



### Cabinets & Tools

#### A

##### Assortments

- Adhesives
  - Drive Grip & Insert bits T-29
- Driver Bits
  - Grabit Damaged Screw Remover & DriveGrip T-29

#### C

##### Cabinets

- Drill Dispensers & Organizers T-14, T-15
- Drill & Tap Indexes T-16, T-17
- Large Metal & Plastic Compartment Trays T-6, T-7
- Large Metal Racks & Accessories T-8
- Metal & Plastic Compartment Trays and Racks T-10
- Metal Storage Bins & Accessories T-5, T-6
- Metal Storage Drawers & Accessories T-6
- Small Metal & Plastic Compartment Trays T-9
- Small Metal Racks & Accessories T-9
- Specialty Storage: Peg Racks & Miscellaneous T-13
- Specialty Storage: Rod, Bar & Tie Racks T-12
- Specialty Storage: Utility & Aerosol Cabinets T-10
- Specialty Storage: Wire & Hose Racks T-11

##### Crimping Tools

- Ratcheting Crimp Tool T-39

#### D

##### Driver Bits

- Flexible Extension T-18
- GRABIT PRO Damaged Screw Remover T-28, T-30

#### E

##### Extractors

- Bolt Extractor
  - 5 Pc. 3/8" Drive Bolt/Stud Extractor Set T-27
- Screw Extractors
  - 5 Pc. 3/8" Drive Bolt/Stud Extractor Set T-27
  - Power-Outs™ Double Edged Screw Extractors T-25
  - Spin-It-Out Damaged Screw Removers T-25
- Screw Extractors, Sets
  - Power-Outs Sets T-25
  - Spiral Screw Extractors T-26

#### F

##### Fiskars Utility Knives & Tools

- Tools
  - Fiskars PowerArc Easy Action Shears (10") T-32
  - Fiskars PowerArc Utility Snips (8") T-32
  - Fiskars PowerGear Plastic Pipe Cutter T-33

#### H

##### Hand

- 2 QT Pump Up Sprayer T-49

#### S

##### Snips, Shears & Pipe Cutters

- Fiskars
  - PowerArc Easy Action Shears (10") T-32

##### Specialty Storage

- Sphag Sorb 30 Gallon Storage Drum
  - with Locking Lid T-17
- Sure Can Fuel Containers
  - 2.2G, 5G, & 5G Diesel T-17
- Wall Mountable Pegboard Panel
  - 8" Pegboard Hooks T-13
- Wall Mountable Pegboard Panel w (10) 8" Hooks T-13

#### T

##### Threaded Rod

- Tools
  - Deburring Tool (T03) T-31

##### Tools

- Battery & Crimping
  - Ratcheting Crimp Tool T-39
- Driver Bits
  - Flexible Extension T-18
- Hand
  - 2 QT Pump Up Sprayer T-49
  - 3 & 6 Pc NES Internal & External Tool Sets T-24
  - 3 Pc iNES Internal Set T-24
  - 4-in-1 Tube Fitting Brush T-39
  - 4-Way Chuck Key Caddies T-18
  - 12 Volt Tester T-38
  - 16" Adjustable Pry Bar/Nail Puller T-49
  - 25 Piece Hex Hd Spline Drive Screw Extractor Set T-27
  - Automatic Center Punch T-20
  - Battery Cable Stripper T-38
  - Big Daddy Manual Rivet Tool T-46
  - Butane Refill T-37
  - Cable Cutter T-38
  - Cable Tie Gun T-42
  - Can-Gun T-42
  - Cartridge Loading Snap Knife with Rubber Grip T-33
  - Caulking Gun T-43
  - Center Punch Band-It Clamp
    - Light Duty Hand Tool T-41
    - T300 Heavy Duty Hand Tool T-41
  - Deutsch Connector Tools T-40
  - Excalibur Butane
    - Solder Torch Kit T-37
  - Fiskars Power Arc Easy Action Shears T-32
  - Fiskars PowerArc Utility Snips (8") T-32
  - Golden Grip™ Internal Pipe Wrenches T-27
  - HD Retractable Blade



8 Pt. Breakaway Knife T-33  
Heavy Duty Nutsert Tool T-45  
Heavy Duty Rivet Tool T-46  
Hex Head Spline Drive Screw Extractors T-27  
High Capacity Hydraulic Crimper T-38  
Hose Crimper T-48  
Hose & Tubing Cutter T-48  
IBS "Rapid Razor" Utility Knife T-33  
IBS Service Broom T-49  
Indent Crimper T-38  
Indexing Pry Bars T-49  
Industrial Butane Torch T-37  
iNES Internal Rethreading Tap T-23  
iNES Replacement Blades T-24  
Locking Dual Wheel Adapter T-44  
LockNFlate Coupler T-44  
LockNLube Coupler T-44  
Medium Duty Grease Guns T-43  
Metripack Crimping Tool T-40  
Metripack Terminal Removal Tool T-40  
Microtorch Butane Torch T-37  
Mini Cable Tie Gun T-42  
Mini Grease Gun T-43  
NES Internal Thread Cleaner / Restoring Tool T-22  
NES Replacement Blades T-22  
NES Rethreading Tools T-21  
NES Universal Thread Restorer 4 Pc Tool Kit T-22  
Nicholson® Pro Series  
4-in1 Hacksaw Frame T-31  
Power-Outs Sets T-25  
Professional Hex Die Wrench T-19  
Professional Straight Handle Tap Wrench T-19  
Ratcheting Crimp Tool Sets T-39  
Reciprocating Saw Handle T-32  
ReelTek Hose Reels & Assemblies T-47  
Revo Folding Knife T-34  
Rivet Nut Gun T-45  
Rivet Nut Gun Mandrels & Nosepieces T-45  
Select-A-Bit Security Driver T-18  
SHARK Heavy Duty  
Combination Utility Knife T-34  
Shur-Shot Dispensing Gun T-42  
Spray Bottle &  
Trigger Sprayers T-43  
Static Mixers T-42  
Sure Shot 32 oz. Measuring Pitcher T-43  
Swivel Head Professional Rivet Tool T-45  
Tapping Tool & Guide T-19  
T-Handle Ratcheting  
Tap Wrenches T-20  
T-Handle Tap Wrench T-19, T-20  
ThreadMate Set & External Tool T-24  
Transfer Punches T-20  
28 Pc Set T-20  
Universal Crimping Tool T-38  
Weatherpack 22-12GA Crimper T-40

Weatherpack Terminal Extractor Tool T-40  
Wire Crimp Tool T-39  
Wire Cutter T-38  
Power  
1/4" 90° Angle  
Air Die Grinder T-19  
1/4" Air Die Grinder T-19  
7-1/4" Circular Saw T-36  
14" Circular Saw T-36  
Battery End Power Cleaning Brushes T-39  
Compact Magnetic Drill Press T-35  
Dual Temp Electric Heat Gun T-37  
Hydraulic Crimper T-38, T-48  
Magnetic Drill Press T-35  
Slugger Cutting Fluid for Mag Drills T-35  
Variable Speed / Reversible  
Magnetic Drill Press T-35  
Threaded Rod  
Deburring Tool 3Pc Set (T03) T-31



### *Turning Maintenance Departments into Profit Centers*



**DOES YOUR SHOP LOOK  
LIKE THIS?** 

*The Supplies You Need, When & Where you Need Them*



**WE'LL MAKE IT LOOK  
LIKE THIS!** 

*Eliminates Downtime, High Costs, Stock-Outs & Overstock*



# **IBS, Inc.**

1 (800) 678-1906  
[www.industrialbolt.com](http://www.industrialbolt.com)

C  
A  
B  
I  
N  
E  
T  
S  
&  
T  
O  
O  
L  
S



# IBS, INCORPORATED

## Cabinets T01

### Inventory Control On 13,000 High Quality Maintenance Products

#### THE SUPPLIES YOU NEED WHERE YOU CAN FIND THEM!

With IBS Inc. cabinets and drawers the right part is always available when and where you need it. No more endless searching through piles of parts and through countless unidentified boxes for that 1/4" lockwasher you purchased last week. With the IBS inventory system you'll always know what you have and what you need to order. IBS' Sales Agent will work with you to specially design your system to meet your companies specific and unique needs.

#### The IBS Sales Agent will:

- Recommend required storage equipment.
- Identify each part carried.
- Determine inventory needs.
- Set minimum and maximum quantities.
- Check stock on a regular basis.
- Organize and clean bins.

#### IBS Inventory Control Helps To Eliminate:

- Excessive downtime.
- High maintenance costs.
- Stock-outs.
- Excessive inventories.



C  
A  
B  
I  
N  
E  
T  
S  
&  
T  
O  
O  
L  
S

# IBS, INCORPORATED

## Cabinets T01



### Metal Storage Bins & Accessories

- All welded, prime cold rolled steel.
- Fully hemmed, 1-1/8 bin fronts to hold and retain parts.
- Roll formed sides for increased strength and stability.
- Modular with all other 12" deep bins.
- Durable black powder coat finish.
- Optional base and bin labels available.
- Ships fully assembled.



#### 72 HOLE STORAGE BIN

NOTE: AUTO FREIGHT ONLY

IBS No.	Dim: (W x D x H in.)	Holes	Hole Dim: (W x D x H in.)	Wt	Qty
72B	33-3/4 x 12 x 42	72	4 x 11-7/8 x 4-1/2	80 lbs	1
72BU	33-3/4 x 12 x 42 USED	72	4 x 11-7/8 x 4-1/2	80 lbs	1



#### 56 HOLE STORAGE BIN

NOTE: AUTO FREIGHT ONLY

IBS No.	Dim: (W x D x H in.)	Holes	Hole Dim: (W x D x H in.)	Wt	Qty
56B	33-3/4 x 12 x 42	56	4-7/8 x 11-7/8 x 5-1/8	75 lbs	1
56BU	33-3/4 x 12 x 42 USED	56	4-7/8 x 11-7/8 x 5-1/8	75 lbs	1



#### 42 HOLE STORAGE BIN

NOTE: AUTO FREIGHT ONLY

IBS No.	Dim: (W x D x H in.)	Holes	Hole Dim: (W x D x H in.)	Wt	Qty
42B	33-3/4 x 12 x 42	42	5-3/8 x 11-7/8 x 5-1/2	71 lbs	1
42BU	33-3/4 x 12 x 42 USED	42	5-3/8 x 11-7/8 x 5-1/2	71 lbs	1



#### 40 HOLE STORAGE BIN

IBS No.	Dim: (W x D x H in.)	Holes	Hole Dim: (W x D x H in.)	Wt	Qty
40B	33-3/4 x 12 x 23-7/8	40	4 x 11-7/8 x 4-1/2	50 lbs	1
40BU	33-3/4 x 12 x 23-7/8 USED	40	4 x 11-7/8 x 4-1/2	50 lbs	1



#### 36 HOLE STORAGE BIN - GRAY ONLY

IBS No.	Dim: (W x D x H in.)	Holes	Hole Dim: (W x D x H in.)	Wt	Qty
36B	17-7/8 x 12 x 42	36	4 x 11-7/8 x 4-1/2	50 lbs	1
36BU	17-7/8 x 12 x 42 USED	36	4 x 11-7/8 x 4-1/2	50 lbs	1



#### 20 HOLE STORAGE BIN

NOTE: AUTO FREIGHT ONLY

IBS No.	Dim: (W x D x H in.)	Holes	Hole Dim: (W x D x H in.)	Wt	Qty
20B	33-1/4 x 12 x 42	20	8 x 11-7/8 x 8-1/2	55 lbs	1
20BU	33-1/4 x 12 x 42 USED	20	8 x 11-7/8 x 8-1/2	55 lbs	1



#### BASE FOR "B" TYPE BIN

- Prime cold rolled steel.
- Fits all 12" x 33-3/4" parts bins.
- Raises bins 5-3/4" above the floor
- Legs attach easily using fasteners provided
- Durable black powder coat finish

IBS No.	Dim: (W x D x H in.)	Fits Models	Wt	Qty
AJ364	33-3/4 x 12-1/4 x 5-3/4	72B, 56B, 42B, 40B, 36B, 24D, 20B	13 lbs	1
AJ364U	33-3/4 x 12-1/4 x 5-3/4 USED	72B, 56B, 42B, 40B, 36B, 24D, 20B	13 lbs	1

C  
A  
B  
I  
N  
E  
T  
S  
&  
T  
O  
O  
L  
S



# IBS, INCORPORATED

## Cabinets T01

### Metal Storage Bins & Accessories

#### LEG SET BASE FOR BINS

- Prime cold rolled steel.
- Fits all 12" parts bins.
- Raises bins 4-31/32" above the floor
- Legs attach easily using fasteners provided
- Leveling Feet
- Durable black powder coat finish



IBS No.	Dim: (W x D x H in.)	Fits Models	Wt	Qty
AJ365	3-31/32 x 11-29/32 x 4-31/32	72B, 56B, 42B, 40B, 36B, 20B	7 lbs	1
AJ365U	3-31/32 x 11-29/32 x 4-31/32 USED	72B, 56B, 42B, 40B, 36B,, 20B	7 lbs	1

#### AEROSOL BIN TOPPER

- Prime cold rolled steel.
- Holds 17 standard-size aerosol cans.
- Fits all 12" depth and 33" width bins.
- Angled top keeps the bin free of clutter
- Durable black powder coat finish



IBS No.	Dim: (W x D x H in.)	Holes	Fit Models	Wt	Qty
AJ479	33-11/16 x 12 x 8-1/2	17	72B, 56B, 42B, 40B, 20B	10 lbs	1
AJ479U	33-11/16 x 12 x 8-1/2 USED	17	72B, 56B, 42B, 40B, 20B	10 lbs	1

### Metal Storage Drawers & Accessories

- Prime cold rolled steel construction.
- High density drawer cabinet; easy to store large quantities of small parts.
- Drawers feature interlocking design for superior strength.
- Drawers have full width handles and easy glide runners.
- Each drawer includes 2 easy-to-label dividers.
- Dividers are adjustable with 1" centers.
- Durable black powder coat finish.
- Cabinets can be stacked using mounting holes.
- Ships fully assembled.

#### 18 DRAWER STORAGE CABINET



IBS No.	Dim: (W x D x H in.)	Drawers	Drawer Dim: (W x D x H in.)	Wt	Qty
18D	33-3/4x11-5/8 x10-7/8	18	5-3/8x11-1/4x2-3/4	50 lbs	1
18DU	33-3/4x11-5/8 x10-7/8 USED	18	5-3/8x11-1/4x2-3/4	50 lbs	1

#### 9 DRAWER STORAGE CABINET



IBS No.	Dim: (W x D x H in.)	Drawers	Drawer Dim: (W x D x H in.)	Wt	Qty
9D	17-1/4 x 11-5/8 x 10-7/8	9	5-3/8 x11-1/4x2-3/4	28 lbs	1
9DU	17-1/4 x11-5/8 x 10-7/8 USED	9	5-3/8 x11-1/4x2-3/4	28 lbs	1
AJ023	Dividers	-	5-3/8x2-3/4	-	12

### Large Metal & Plastic Compartment Trays

- Prime cold rolled steel outer shell construction
- Full piano hinge on cover provides rigidity.
- Positive pull-down catch keeps cover tightly closed to prevent part migration.
- Handle allows for easy transport.
- Durable black powder finish.

#### 32 HOLE LARGE TRAY



IBS No.	Dimensions (W x D x H in.)	Holes	Weight	Qty.
DL-32C	18 x 12 x 3	32	8 lbs	1
DL-32CU	18 x 12 x 3 USED	32	8 lbs	1

#### 24 HOLE LARGE TRAY



IBS No.	Dimensions (W x D x H in.)	Holes	Weight	Qty.
DL-24C	18 x 12 x 3	24	8 lbs	1
DL-24CU	18 x 12 x 3 USED	24	8 lbs	1

C  
A  
B  
I  
N  
E  
T  
S  
&  
T  
O  
O  
L  
S

### Large Metal & Plastic Compartment Trays



#### 21 HOLE LARGE TRAY

IBS No.	Dimensions (W x D x H in.)	Holes	Weight	Qty.
DL-21C	18 x 12 x 3	21	8 lbs	1
DL-21CU	18 x 12 x 3 USED	21	8 lbs	1



#### 20 HOLE LARGE TRAY

IBS No.	Dimensions (W x D x H in.)	Holes	Weight	Qty.
DL-20C	18 x 12 x 3	20	8 lbs	1
DL-20CU	18 x 12 x 3 USED	20	8 lbs	1



#### 16 HOLE LARGE TRAY

IBS No.	Dimensions (W x D x H in.)	Holes	Weight	Qty.
DL-16C	18 x 12 x 3	24	8 lbs	1
DL-16CU	18 x 12 x 3 USED	24	8 lbs	1



#### 12 HOLE LARGE TRAY

IBS No.	Dimensions (W x D x H in.)	Holes	Weight	Qty.
DL-12C	18 x 12 x 3	32	8 lbs	1
DL-12CU	18 x 12 x 3 USED	32	8 lbs	1



#### 6 HOLE LARGE TRAY

IBS No.	Dimensions (W x D x H in.)	Holes	Weight	Qty.
DL-6C	18 x 12 x 3	6	8 lbs	1
DL-6CU	18 x 12 x 3 USED	6	8 lbs	1



#### ADJUSTABLE COMPARTMENT LARGE TRAY HORIZONTAL

IBS No.	Dimensions (W x D x H in.)	Holes	Weight	Qty.
AD-H	18 x 12 x 3	ADJ	8 lbs	1
AD-HU	18 x 12 x 3 USED	ADJ	8 lbs	1
AJ097	Dividers for AD-H (sold in pkgs of 9)		1 lb	9



#### ADJUSTABLE COMPARTMENT LARGE TRAY VERTICAL

IBS No.	Dimensions (W x D x H in.)	Holes	Weight	Qty.
AD-L	18 x 12 x 3	ADJ	8 lbs	1
AD-LU	18 x 12 x 3 USED	ADJ	8 lbs	1
AJ120	Dividers for AD-L (sold in pkgs of 9)		1 lb	9



#### ADJUSTABLE HOLE LARGE TRAY EXPANDABLE

IBS No.	Dimensions (W x D x H in.)	Holes	Weight	Qty.
AD-E	18 x 12 x 3	ADJ	8 lbs	1
AD-EU	18 x 12 x 3 USED	ADJ	8 lbs	1
125772	Horizontal Dividers for AD-E		1 lb	9
125773	Vertical Dividers for AD-E		1 lb	9



# IBS, INCORPORATED

## Cabinets T01

### Large Metal Racks & Accessories

- Sturdy construction using prime cold-rolled steel.
- Each sliding cradle holds up to 75 lbs.
- Easy glide slides allow boxes to move in and out smoothly.
- Center braces on cradles provide extra rigidity.
- Boxes can be easily removed for transport to work areas.
- Reinforced rack keeps boxes level.
- Durable black powder coat finish.

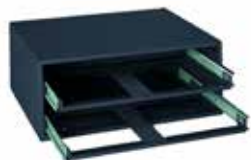

#### 2 DRAWER LARGE RACK      HOLDS 2 LARGE COMPARTMENT TRAYS

IBS No.	Dimensions (W x D x H in.)	Drawers	Wt	Qty.
2LR-BT	20 x 15-3/4 x 8-1/8	2	20 lbs	1
2LR-BTU	20 x 15-3/4 x 8-1/8 USED	2	20 lbs	1



#### 4 DRAWER LARGE RACK      HOLDS 4 LARGE COMPARTMENT TRAYS

IBS No.	Dimensions (W x D x H in.)	Drawers	Wt	Qty.
4LR-BT	20 x 15-3/4 x 15	4	37 lbs	1
4LR-BTU	20 x 15-3/4 x 15 USED	4	37 lbs	1



#### TRIPLE TRACK SPACE SAVER RACK (Holds 4 Lg Compartment Boxes)

IBS No.	Dimensions (W x D x H in.)	Drawers	Wt	Qty.
4LR-TT	20-1/4 x 12-1/2 x 15	4	37 lbs	1
4LR-TTU	20-1/4 x 12-1/2 x 15 USED	4	37 lbs	1



AJ304, AJ311

#### BASES FOR LARGE SLIDE RACKS

- Sturdy all steel construction.
- Available for both the Easy Glide and Space Saver Racks.
- Raises units off the floor.
- Legs attach easily using fasteners (included).
- Durable black powder coat finish.



AJ304S

IBS No.	Dimensions (W x D x H in.)	Fits	Wt	Qty.
AJ304	20-5/8 x 16-1/4 x 15-5/8	4LR-BT	13 lbs	1
AJ304U	20-5/8 x 16-1/4 x 15-5/8 USED	4LR-BT	13 lbs	1
AJ304S	20-5/8 x 16-1/4 x 5-3/4	4LR-BT	12 lbs	1
AJ304SU	20-5/8 x 16-1/4 x 5-3/4 USED	4LR-BT	12 lbs	1
AJ311	20-5/8 x 12-5/8 x 15-5/8	4LR-TT	12 lbs	1
AJ311U	20-5/8 x 12-5/8 x 15-5/8 USED	4LR-TT	12 lbs	1



#### LOCKING HINGE

- All steel for durability.
- Fits both the 4 section Easy Glide Slide and Triple Track Space Saver Racks.
- Holds boxes securely in place during transport.
- Swivel padlock attachment allows units to be locked for security (Padlock not included).
- Easy to install using pop rivets or sheet metal screws (fasteners not included).
- Chrome plate finish.

IBS No.	Dimensions (W x D x H in.)	Fits	Wt	Qty.
AJ312	Locking Hinge	4LR,4LR-TT	1 lbs	1

C  
A  
B  
I  
N  
E  
T  
S  
&  
T  
O  
O  
L  
S

### Small Metal & Plastic Compartment Trays

- Prime cold rolled steel outer shell construction
- Full piano hinge on cover provides rigidity.
- Positive pull-down catch keeps cover tightly closed to prevent part migration.
- Handle allows for easy transport.
- Durable gray powder finish.



#### 24 HOLE SMALL TRAY

IBS No.	Dimensions (W x D x H in.)	Holes	Weight	Qty.
DS-24C	13-3/8 x 9-1/4 x 2	24	4 lbs	1
DS-24CU	13-3/8 x 9-1/4 x 2 USED	24	4 lbs	1



#### 20 HOLE SMALL TRAY

IBS No.	Dimensions (W x D x H in.)	Holes	Weight	Qty.
DS-20C	13-3/8 x 9-1/4 x 2	20	4 lbs	1
DS-20CU	13-3/8 x 9-1/4 x 2 USED	20	4 lbs	1



#### 16 HOLE SMALL TRAY

IBS No.	Dimensions (W x D x H in.)	Holes	Weight	Qty.
DS-16C	13-3/8 x 9-1/4 x 2	24	4 lbs	1
DS-16CU	13-3/8 x 9-1/4 x 2 USED	24	4 lbs	1



#### 12 HOLE SMALL TRAY

IBS No.	Dimensions (W x D x H in.)	Holes	Weight	Qty.
DS-12C	13-3/8 x 9-1/4 x 2	32	4 lbs	1
DS-12CU	13-3/8 x 9-1/4 x 2 USED	32	4 lbs	1



#### ADJUSTABLE COMPARTMENT SMALL TRAY VERTICAL

IBS No.	Dimensions (W x D x H in.)	Holes	Weight	Qty.
AD-S	13-3/8 x 9-1/4 x 2	ADJ	4 lbs	1
AD-SU	13-3/8 x 9-1/4 x 2 USED	ADJ	4 lbs	1
AJ216	Dividers for AD-S (sold in pkgs of 9)		1 lb	9

### Small Metal Racks & Accessories

- Sturdy construction using prime cold-rolled steel.
- Easy glide slides allow boxes to move in and out smoothly.
- Center braces on cradles provide extra rigidity.
- Boxes can be easily removed for transport to work areas.
- Reinforced rack keeps boxes level.
- Durable gray powder coat finish.



#### 4 DRAWER SMALL RACK

IBS No.	Dimensions (W x D x H in.)	Drawers	Wt	Qty.
4SR	15-9/16 x 11-7/8 x 11-5/16	4	22 lbs	1
4SRU	15-9/16 x 11-7/8 x 11-5/16 USED	4	22 lbs	1



#### 6 DRAWER SMALL RACK

IBS No.	Dimensions (W x D x H in.)	Drawers	Wt	Qty.
6SR	15-9/16 x 11-7/8 x 16-3/8	6	32 lbs	1
6SRU	15-9/16 x 11-7/8 x 16-3/8 USED	6	32 lbs	1



#### BASES FOR SMALL SLIDE RACKS

- Sturdy all steel construction.
- Legs attach easily using fasteners (included).
- Raises units off the floor.
- Durable black powder coat finish.

IBS No.	Dimensions (W x D x H in.)	Fits	Wt	Qty.
AJ315	15-7/8 x 12-1/8 x 15-1/8	4LR, 4LR-TT	12 lbs	1
AJ315U	15-7/8 x 12-1/8 x 15-1/8 USED	4LR, 4LR-TT	12 lbs	1



# IBS, INCORPORATED

## Cabinets T01

C  
A  
B  
I  
N  
E  
T  
S  
&  
T  
O  
O  
L  
S

### Metal & Plastic Compartment Trays and Racks



#### ADJUSTABLE COMPARTMENT SMALL PLASTIC TRAVEL TRAY

- Features IBS Logo on lid.
- Clear plastic for easy visual inspection.
- Locking hinges.
- Portable

IBS No.	Dimensions (W x D x H in.)	Sections	Wt	Qty.
17017	7-1/4 x 11 x 1-3/4	6 +ADJ	.8 lbs	1



#### STEEL RACK for PLASTIC TRAVEL TRAYS - GRAY ONLY

- Flexible offset handle prevents boxes from sliding out during transport.
- Holds up to 5 IBS Travel Trays
- Can be wall mounted, stacked or carried with removable handle.
- Keyhole slots in back allow for mounting on walls or panels.
- Durable gray powder coat finish.
- Dimensions: 11-1/4W x 6-3/4D x 10-3/4H

IBS No.	Dimensions (W x D x H in.)	Sections	Wt	Qty.
17057	11-1/4 x 6-3/4 x 10-3/4	5	6 lbs	1

### Specialty Storage: Aerosol Utility Cabinets



#### AEROSOL UTILITY CABINET

- Manufactured using prime cold rolled steel.
- All-welded construction prevents warping and twisting.
- Full piano hinges prevent door sag.
- Channeled shelves (AJ385) hold 88 standard aerosol cans.
- Pre-installed lock and 2 keys are included
- Key hole slots in back of unit for mounting.
- Durable black powder coat finish.

IBS No.	Dimensions (W x D x H in.)	Sections	Wt	Qty.
AJ386	33-3/4 x 11-7/8 x 23-7/8	2	40 lbs	1
AJ386U	33-3/4 x 11-7/8 x 23-7/8 USED	2	40 lbs	1



#### SMALL VERTICAL AEROSOL UTILITY CABINET

- Manufactured using prime cold rolled steel.
- All-welded construction prevents warping and twisting.
- Full piano hinges prevent door sag.
- 2 adjustable shelves are included.
- Holes in top and bottom allow secure stacking.
- Keyhole slots in back allow wall hanging.
- Built-in lock attachment.
- Durable black powder coat finish.

IBS No.	Dimensions (W x D x H in.)	Sections	Wt	Qty.
AJ382	13-3/4 x 12-3/4 x 30	Adjustable	31 lbs	1
AJ382U	13-3/4 x 12-3/4 x 30 USED	Adjustable	31 lbs	1



#### KEYS FOR CABINET

- Set of spare keys for locking cabinets.

IBS No.	Qty.
AJKEYS	1

### Specialty Storage: Wire & Hose Racks

CABINETS & TOOLS



#### 4 ROW WIRE SPOOL RACK

- Prime cold rolled steel construction.
- Includes 4 polished steel rods.
- Easy to store different sized spools on the same rod.
- Accommodates up to 10" diameter spools.
- Punched side panels allow quick spool changes.
- Ruled decal is supplied, making it easy to cut wire to tubing to the proper length.
- Keyhole slots are provided for wall mounting.
- Easy to assemble using fasteners provided.
- Durable black powder coat finish.

IBS No.	Dimensions (W x D x H in.)	Rows	Wt	Qty.
AJ368	26-1/8 x 5-7/8 x 36-1/2	4	18 lbs	1
AJ368U	26-1/8 x 5-7/8 x 36-1/2 USED	4	18 lbs	1



#### 2 ROW WIRE SPOOL RACK

- Prime cold rolled steel construction.
- Includes 2 polished steel rods.
- Easy to store different sized spools on the same rod.
- Accommodates up to 10" diameter spools.
- Punched side panels allow quick spool changes.
- Keyhole slots are provided for wall mounting.
- Easy to assemble using fasteners provided.
- Durable black powder coat finish.

IBS No.	Dimensions (W x D x H in.)	Sections	Wt	Qty.
AJ384	26-1/8 x 5-7/8 x 21-1/2	2	11 lbs	1
AJ384U	26-1/8 x 5-7/8 x 21-1/2 USED	2	11 lbs	1



#### 10 LOOP HOSE CLAMP RACK

- Manufactured using prime cold rolled steel.
- Holds 10 different diameters: Mini-clamp (7/32-5/8), Mini-clamp (5/16-7/8), #6, #10, #12, #16, #20, #28, #32, #36.
- Sign panel lists clamp diameters and hose ID's.
- Can be set on counter tops or hung on walls and panels.
- Durable black powder coat finish with black and white sign panel.
- Clamps not included.

IBS No.	Dimensions (W x D x H in.)	Loops	Wt	Qty.
AJ907	23-5/16 x 5-1/2 x 14-5/16	10	6 lbs	1
AJ907U	23-1/4 x 5-3/8 x 16-1/8 USED	10	5 lbs	1



#### 5 LOOP HOSE CLAMP RACK FOR LARGE CLAMPS

- Manufactured using prime cold rolled steel.
- Holds 5 different diameters: #40, #48, #52, #56, #72.
- Sign panel lists clamp diameters and hose ID's.
- Can be set on counter tops or hung on walls and panels.
- Durable black powder coat finish with black and white sign panel.
- Clamps not included.

IBS No.	Dimensions (W x D x H in.)	Loops	Wt	Qty.
AJ910	23-5/16 x 5-1/2 x 14-5/16	5	6 lbs	1
AJ910U	23-1/4 x 5-3/8 x 16-1/8 USED	5	5 lbs	1



### Specialty Storage: Rod, Bar & Tie Racks

C  
A  
B  
I  
N  
E  
T  
S  
&  
T  
O  
O  
L  
S



#### 3 SHELF HOSE CABLE AND TUBING CABINET

- Heavy duty all steel construction.
- Black powder coated finish and rust and acid resistant.

IBS No.	Dim. (W x D x H in.)	Shelves	Wt	Qty.
3HB	20 x 15-3/4 x 15	2 Fixed	45 lbs	1
3HBU	20 x 15-3/4 x 15 USED	2 Fixed	45 lbs	1



#### KEYSTOCK RACK

- Sturdy all steel construction.
- Holds keystock up to 3/4" square.
- Ten compartments.
- Keyhole slots allow for wall mounting.
- Durable black powder coat finish.

IBS No.	Dim. (W x D x H in.)	Holes	Wt	Qty.
AJ381	12-1/4 x 6-1/4 x 12	10	8 lbs	1
AJ381U	12-1/4 x 6-1/4 x 12 USED	10	8 lbs	1



#### THREADED ROD RACK

- Sturdy all-steel construction.
- Separates and protects threaded rods.
- (18) 2-1/16" diameter openings accommodate different sizes.
- Durable black powder coat finish.

IBS No.	Dim. (W x D x H in.)	Holes	Wt	Qty.
AJ367	24-1/8 x 6-7/8 x 24	18	16 lbs	1
AJ367U	24-1/8 x 6-7/8 x 24 USED	18	16 lbs	1

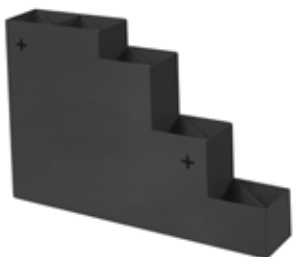

#### CABLE TIE RACK

- Sturdy all-steel construction.
- Each compartment is supplied with a removable divider to create from 5 to 10 compartments, for multiple tie lengths.
- Durable black powder finish
- Wall mountable.
- 18-5/32W x 3D x 12-1/4H

IBS No.	Dim. (W x D x H in.)	Holes	Wt	Qty.
AJ298	18-5/32 x 3 x 12-1/4	5-10	8 lbs	1



#### MAGNETIC DISPENSER FOR GLOVES

- **Magnetic glove dispenser** conveniently attaches to your toolbox or any ferrous metal.
- **Two large magnets hold the dispenser in place**, or mount it on a wall using screws.
- **Standard fits all common sizes** of disposable gloves,.
- **Large fits thicker gloves** that come in larger boxes (Orange Nitrile Gloves).
- **The dispenser has 3 adjusting springs** which can be adjusted as necessary **to hold the various box sizes**.
- Made of **powder coated steel**.

IBS No.	Description	Dimensions	Qty.
143865	Standard Magnetic Dispenser for Gloves	10 x 5-3/4 x 3-3/4	1
143866	Large Magnetic Dispenser for Orange Nitrile Gloves	10 x 5-3/4 x 4-3/8	1

### Specialty Storage: Peg Racks & Miscellaneous



#### 4-1/2" DISC DISPENSER

- **ORGANIZES CUT-OFF WHEELS:** Cut-off wheel dispenser allows wheels to be stored for easy access when needed.
- **HOLDS 4-1/2" WHEELS:** Dispenser will hold up to 48 Type 1 or Type 27 4-1/2" cut off wheels, up to 10 Type 27 Grinding Wheels with 7/8 arbor or 5 grinding wheels with 5/8-11 threaded arbor.
- **DURABLE CONSTRUCTION:** Powder-coated steel construction is tough and durable for long service life.
- **MADE IN THE U.S.A.**

IBS No.	Description	Qty.
17060	4-1/2" Disc Dispenser	1



#### MOLDED PLASTIC STORAGE CASES

- Durable molded plastic storage case.
- Locking hinge
- Portable

IBS No.	Description	Qty.
17018	4 Pc Hole Hog or Reamer Case	1
17335	10 PC EMPTY Hex Shank Drap Case	1
19376	EMPTY Box for Annular Cutters	1

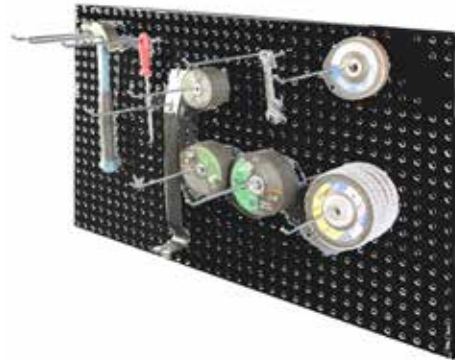
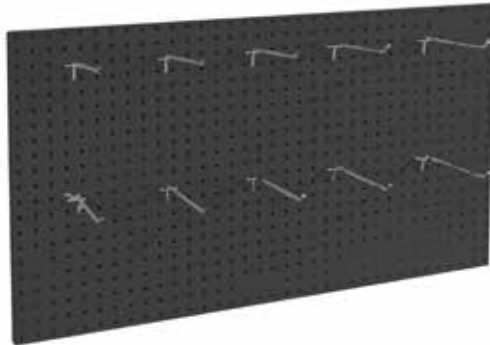

#### WALL MOUNTABLE PEGBOARD PANEL WITH (10) 8" HOOKS

- 18 Gauge, sturdy, formed steel.
- Hole punches allow for wall mounting.
- Peghole size is 1/4" and are spaced 1" apart.
- (10) 8" Pegboard hooks are included.
- Fully assembled and ready for use.
- Overall dimensions 34-3/4" W X 1" D X 20-1/3"H



IBS No.	Description	Qty.
AJ915	Wall Mountable Pegboard Panels with 10 Bin Hooks	1
AJ915H	8" Pegboard Hooks	1



### Drill Dispensers & Organizers

C  
A  
B  
I  
N  
E  
T  
S  
&  
T  
O  
O  
L  
S



17000, 17002

#### DRILL DISPENSERS

- **Dimensions: 14-5/8 W x 7-3/8" D x 7-3/4" H**
- Holds full packages of each size.
- Stackable for larger inventories.
- One piece drawer slide for long useful life.
- Decimal equivalents.

IBS No.	Description	Drawers	Wt	Qty.
17000	1/16th to 1/2" x 64ths drills	3	10.25 lbs	1
17001	#1 to #60 drills	5	10.25 lbs	1
17002	A to Z drills	3	10.25 lbs	1



17001



17008

#### FRACTIONAL TAP DISPENSER

- **Dimensions: 14-5/8 W x 7-3/8" D x 7-3/4" H**
- Holds popular **fractional sizes:** \
  - 1/4-20 NC, 1/4-28 NF, 5/16-18 NC, 5/16-24 NF, 3/8-16 NC, 3/8-24 NF
  - 7/16-14 NC, 7/16-20 NF, 1/2-13 NC, 1/2-20 NF, 9/16-12 NC, 9/16-18 NF
  - 5/8-11 NC, 5/8-18 NF, 3/4-10 NC, 3/4-16 NF, 7/8-9 NC, 7/8-14 NF, 1-8 NC, 1-12 NF
- Stackable for larger inventories.
- One piece drawer slide for long useful life.
- Finished with tough epoxy powder coating.

IBS No.	Description	Drawers	Wt	Qty.
17008	1/4 to 1" NC/NF Fractional Tap Dispenser	3	10.25 lbs	1



17015

#### TAP & DRILL DISPENSER

- **Dimensions: 14-5/8 W x 7-3/8" D x 7-3/4" H**
- Holds popular **Tap & Drill sizes:**
  - 6-32 (#36), 8-32 (#29), 10-24 (#25), 10-32 (#21), 1/4-20 (#7), 1/4-28 (#3), 5/16-18 (#24), 5/16-24 (I), 3/8-16 (5/16), 3/8-24 (Q), 7/16-14 (U), 7/16-20 (25/64), 1/2-13 (27/64), 1/2-20 (29/64).
- Stores and organizes correct drill with corresponding size tap.
- Stackable for larger inventories.
- One piece drawer slide for long useful life.
- Finished with tough epoxy powder coating.

IBS No.	Description	Drawers	Wt	Qty.
17015	Tap & Drill Dispenser	3	10.25 lbs	1



17024

#### METRIC TAP DISPENSER

- **Dimensions: 14-5/8 W x 7-3/8" D x 7-3/4" H**
- Holds 29 popular **Metric Tap sizes:**
  - 3mm x .50, 3mm x .60, 4mm x .70, 4mm x .75, 5mm x .80, 5mm x .90, 6mm x 1.00, 6.3mm x 1.00, 7mm x 1.00, 8mm x 1.00, 8mm x 1.25, 9mm x .75, 9mm x 1.00, 9mm x 1.25, 10mm x 1.00, 10mm x 1.25, 11mm x 1.50, 12mm x 1.25, 12mm x 1.50, 14mm x 1.25, 14mm x 1.50, 14mm x 2.00, 16mm x 1.50, 16mm x 2.00, 18mm x 2.50, 20mm x 2.50, 24mm x 3.00.
- Stackable for larger inventories.
- One piece drawer slide for long useful life.
- Finished with tough epoxy powder coating.

IBS No.	Description	Drawers	Wt	Qty.
17024	Metric Tap Dispenser	3	10.25 lbs	1

### Drill Dispensers & Organizers



17026

#### METRIC TAPS, DRILLS & DIES DISPENSER

- **Dimensions:** 14-5/8 W x 7-3/8" D x 7-3/4" H
- The dispenser for metric taps, drills and dies. From 2.5 x .45 tap to 12.0 x 1.75 tap:  
**Top Drawer:** 2.5 x .45 tap - 2.05 drill & dies, 3.0 x .50 tap - 2.50 drill & dies, 3.5 x .60 tap - 2.90 drill & dies, 4.0 x .70 tap - 3.30 drill & dies.  
**2nd Drawer:** 5.0 x .80 tap - 4.20 drill & dies, 6.0 x 1.0 tap - 5.0 drill & dies, 8.0 x 1.25 tap - 6.70 drill & dies.  
**3rd Drawer:** 10.0 x 1.50 tap - 8.50 drill & dies, 12.0 x 1.75 tap - 10.20 drill & dies.
- Stackable for larger inventories.
- One piece drawer slide for long useful life.
- Finished with tough epoxy powder coating.

IBS No.	Description	Drawers	Wt	Qty.
17026	Metric Tap Drills and Dies Dispenser	3	10.25 lbs	1



17031

#### METRIC DRILLS DISPENSER 1-13MM by 0.5

- **Dimensions:** 14-5/8 W x 7-3/8" D x 7-3/4" H
- Holds full packages of each size (12 PC Min).
- Stackable for larger inventories.
- One piece drawer slide for long useful life.
- Decimal equivalents
- Finished with tough epoxy powder coating.

IBS No.	Description	Drawers	Wt	Qty.
17031	Metric Drills Dispenser 1-10 mm by 0.5	3	10.25 lbs	1



#### FRACTIONAL WOODEN TAP STAND

- Easy storage and organization.
- Holds taper, plug and bottom taps.
- 4-40 - 1/2" sizes.

IBS No.	Description	Qty.
126539	Fractional Wooden Tap Stand	1



#### S & D REDUCED SHANK STAND

- Sturdy all steel construction.
- Holds Silver & Deming Reduced Shank drill bits.
- 1/2" to 1" by 64ths.

IBS No.	Description	Qty.
17019	S&D Reduced Shank Stand	1



# IBS, INCORPORATED

## Cabinets T01

### Drill & Tap Indexes

C  
A  
B  
I  
N  
E  
T  
S  
&  
T  
O  
O  
L  
S



17003-BLK



17004-BLK



17005-BLK



17006-BLK



17007-BLK



17009-BLK



17010-BLK



17012



17013-BLK



17014



17016

IBS No.	Description	Size	Qty.
17003-BLK	13 Pc. Fractional Drills - Black	1/16" to 1/4" by 64ths	1
17004-BLK	15 Pc. Fractional Drills - Black	1/16" to 1/2" by 32nds	1
17005-BLK	29 Pc. Fractional Drills - Black	1/16" to 1/2" by 64ths	1
17006-BLK	26 Pc. Drill Index	A to Z	1
17007-BLK	60 Pc. Drill Index	No. 1 to No. 60	1
17009-BLK	18 Pc. Drill Index for Taps & Drills	--	1
17010-BLK	21 Pc. Drill Index	1/16th to 3/8" by 64ths	1
17012	8 Pc. S&D Drills	9/16" to 1" Steel Case	1
17013-BLK	115 Pc. Fractional, Letter, #, Black	--	1
17014	20 Pc. Drill Index	#61 - #80	1
17016	8 Pc Index for 1/4 Shank Tool	--	1
17021-BLK	10 Pc. NC & NF Taps - Black	1/4" to 1/2"	1
17022	10 Pc. NC Tap Index	4-40 through 5/8-11	1
17023	29 Pc. Stubby Drill Index	1/16" to 1/2" by 64ths	1
17025	4 Hole Spotweld Metal Index	--	1
17027	18 Pc. Metric Tap & Drill Index	2.5mm-2.05 to 12mm-10.20	1
17028	118 Pc Metric Drill Index	1MM to 13MM	1
17032-BLK	25 Pc. Metric Drill Index	1-10MM by .5MM	1
17035	7 Pc Drill Pouch	—	1
17029	Handi-Bit Drill Index Mech Length Black		1
17030	Handi-Bit Drill Index Jobber Length Black		1
17039	Hi-Vis Handi-Bit Drill Index Mechanics Length Orange		1
17040	Hi-Vis Handi-Bit Drill Index Jobber Length Orange		1
17041	15 Pc. Stubby Drill Index	1/16" to 1/2" by 32nds	1
17042	Drill and Extractor Index		1
17049	Cryo Red Handi Bit Drill Index Jobber Length Red		1
15913	Drill Gauge - Number Drills	#1 to #80 2"x5-1/4"x1/16"	1
15914	Drill Gauge - Fractional Drills	1/16" to 1/2" by 64ths 3"x 6"x1/16"	1



**DRILL GAUGES**  
15913 — #1 to 80  
15914 — 1/16" TO 1/2"

### Drill & Tap Indexes



#### HANDI-BIT 29 PC DRILL INDEX

- Holds drill bits from 1/16" to 1/2" by 64ths.
- Screw-on hexagonal cover protects and contains drill bits.
- Water-resistant, great for outdoor job sites.
- Constructed of high impact, break resistant plastic.

IBS No.	Description	Holds	Qty.
17029	HANDI-BIT 29 Pc Drill Index - Mechanics Length <b>BLACK</b>	29	1
17030	HANDI-BIT 29 Pc Drill Index - Jobbers Length <b>BLACK</b>	29	1
17039	HANDI-BIT 29 Pc HI-VIS Drill Index Mech Length <b>ORANGE</b>	29	1
17040	HANDI-BIT 29 Pc HI-VIS Drill Index Jobbers Length <b>ORANGE</b>	29	1
17049	HANDI-BIT 29 Pc CRYO Drill Index Jobbers Length <b>RED</b>	29	1

### Storage Containers

#### Sure Can Fuel Containers

SureCan fuel cans are **FM Approved**, meet **OSHA & MSHA** standards, **DOT compliant**, **UN approved**, accepted by the **EPA & CARB** and simply are the best fuel cans to use on the job, at home or out playing.

- **Patented spill proof technology** — uses gravity to dispense fuel from the bottom of the can, which means no bending, tipping, slipping or spilling for less mess, less waste and improved safety.
- **Thumb trigger to start, stop and control the flow** to eliminate spills and waste.
- **Flexible rotating nozzle** means no more tipping and easier dispensing.
- **Self-Ventilating action** enables a smooth flow without glugging — easy handling and **NO SPLASHING**.
- **Comfortable grip** is made to fit hands perfectly to make carrying easy for any user and less injury.
- **Child proof caps** for superior safety.
- **Durable — 6-layer, high density polyethylene design** protects vessel from punctures and cracking for extended life.
- **Stainless steel springs, aluminum rivets and viton seals** last longer, resist corrosion, and extend product life for maximum economy and value.



SUR2SFG2



SUR5SFG2



SUR5SFD2

#### Sphag Sorb 30 Gallon Storage Drum with Locking Lid

**Description:** 30 gallon UN/DOT-approved storage drum.



IBS No.	Description	Qty
SS-3D	Sphag Sorb 30 Gallon Storage Drum	1

IBS No.	Description	Qty
SUR2SFG2	Sure Can 2.2 Gallon Container	1
SUR5SFG2	Sure Can 5 Gallon Container	1
SUR5SFD2	Sure Can 5 Gallon Diesel Container	1



### Select-A-Bit Security Driver

- Includes 14 security tips plus 2 standard tips on eight 3" double-ended bits.
- All bits store safely in the handle in separate bit compartments.
- When no bit is loaded, the nosepiece becomes a 1/4" nut driver.
- Extra long 3" nosepiece to reach even recessed fasteners.



BIT LOAD CHART

Hex	Spanner	Square	Torx	Phillips	Slotted
1/8	4		10		
9/64	6	1	15		
5/32	8	2	20	2	7/32
3/16	10		25		

IBS No.	Description	Qty
CA-141752	Select-A-Bit Security Driver	1

### 4-Way Chuck Key Caddies

Replace 8 Single Chuck Keys with 2 EZ-to-Find Key Caddies

*Keys & Bodies are replaceable*

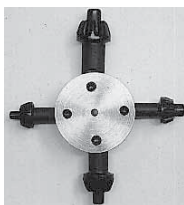

Combined these two caddies will fit a combination of 227 different chucks from 1/4" to 5/8".

#### LARGE 4-WAY DRILL CHUCK

IBS No.	Description
17051	Fits 100 different models in 3/8", 1/2", & 5/8" Fits Jacob Series: 3, 3A, 6A, 6B, 14H, 34, 55, 56, 634, 75, 11N, 32, 33, 3326, MC10, MC33, MC3326, 2A, MC5, 30, 31B, 8-1/2N, MC1.

#### SMALL 4-WAY DRILL CHUCK

IBS No.	Description
17052	Fits 127 different models in 1/4", 3/8", & 1/2" Fits Jacob Series: 1A, 1B, 1BS, MC, DC, H1, McU, 7A, 7BA, 7B, DC, H, MC, U

### Flexible Extension



Flexible drive bit or drill bit extension holds any 1/4" hex shank bit to access tight or hard to reach areas. Can be used for drilling, driving, tapping or with any rotary tool with a 1/4" hex shank.

- Flexible extension flexes to a full 90 degrees allowing for access in tight and hard to reach areas saving time and money.
- Easy load quick disconnect provides fast and easy changeout of accessories and holds them in place eliminating lost tools.
- Outer cover does not rotate so it can be used safely at any speed and held by hand directing the operation exactly where it needs to be.
- 11" long for optimal reach and control.
- Rated for 13 ft.lbs. of torque makes this a powerful tool for most jobs.
- Can be used with standard 1" insert bits and power bits for added convenience and versatility.
- Standard 1/4" shank fits standard electric and cordless drills or screwdrivers.

IBS No.	Description	Qty
73614	Flexible Extension	1



### 1/4" Air Die Grinder

- Designed for tight, tough quarter jobs that require fast metal removal.
- Very maneuverable and perfect for those hard-to-reach areas.
- 1/4" capacity collet with two collet wrenches included.



IBS No.	Description	RPM	HP
69282	1/4" Air Die Grinder	22,000	.33
69283	1/4" Air Die Grinder W/Regulator	25,000	.40

Grinder NOT for use with cut-off wheels over 3" in diameter. Refer to ASTM B7.1-2001

### 1/4" 90° Angle Air Die Grinder

- Great for tight or angled grinding jobs that an in-line die grinder won't reach.
- Rugged ball-bearing motor provides up to 22,000 RPM.
- Efficient rear exhaust air flow system is preferred by professionals everywhere.
- Lever throttle action and 90° angle provide mobility and control.
- Speed (RPM) 22,000.



IBS No.	Description	RPM	HP
127357	1/4" 90° Angle Air Die Grinder	22,000	.30

Grinder NOT for use with cut-off wheels over 3" in diameter. Refer to ASTM B7.1-2001

### Professional Straight Handle Tap Wrench

- Solid construction for long life and ease of use.
- Straight handle design provides greater leverage, especially when using larger diameter taps.
- Ideal for hand tapping.



IBS No.	Description
120922	For Taps #0 to 1/2" (3mm to 12mm)
120923	For Taps #1/4" to 3/4" (6mm to 18mm)

### Professional Hex Die Wrench

- Maintains alignment for accurate, straight threading.
- Dies easily lock in position with set screw.



IBS No.	Description
120925	For 1" Hexagon Dies
120926	For 1-7/16 Hexagon Dies

### Tapping Tool & Guide

Perfect alignment provided for close tolerances and perpendicularity between the hardened sleeve of the tapper and the inside of the tapping guide.



- Stops tap breakage.
- Carbonitrided jaws for long life.
- Center drill on stem for floating center.
- Sliding T-Wrench Handle.
- 120° Vees on Aligner Body Base to accept round parts.
- Slotted body serves as wrench for tightening when changing jaws.

IBS No.	Description
17050	Tapping Tool & Guide

### T-Handle Tap Wrench

- Designed for use with taps and on many other tools to be turned by hand.
- Adjusted and tightened to size by twisting knurled nut.
- Sliding T-Wrench Handle.
- Additional holding jaws are recessed and inside hole for tapping onto small sized taps.
- T-Handle may be extended full length in either direction for more leverage.
- Sliding T-handle has spring tension stop.



IBS No.	Description
120920	For Taps #0 to 1/4" (3mm to 6mm)
120921	For Taps #3/16 to 1/2" (4mm to 12mm)



# IBS, INCORPORATED

## Miscellaneous Tools T03

### T-Handle Ratcheting Tap Wrenches

- Adjustable T-Handle may be slipped from side to side for positioning convenience and added leverage in tight spaces.
- It can be easily set for left or right handed operation, or locked for non-ratcheting use.
- Available in sizes to fit 1/16" up to 1/2" taps, and in extended lengths up to 12" for hard-to-reach areas.
- Designed for use with taps, reamers, screw extractors and other tools with a square shank.



IBS No.	Description
120930	1/16 -1/4 Ratcheting Tap Wrench
120931	1/4 -1/2 Ratcheting Tap Wrench
120932	1/16 -1/4 x 10 Ratcheting Tap Wrench
120933	1/4 -1/2 x 12 Ratcheting Tap Wrench

### Transfer Punches

When you need to make identical holes in different pieces of metal, these punches mark the spot. They fit through existing holes and mark the center of the hole in a second work piece. Punches are made of heat-treated and tempered steel and are approximately 4-7/8" long. Diameter tolerance is  $\pm 0.0005"$ . Punch Sets come in a metal stand for easy storage and organization.



IBS No.	Size	Qty	IBS No.	Size	Qty	IBS No.	Size	Qty
17346	3/32	1	17355	15/64	1	17364	3/8	1
17347	7/64	1	17356	1/4	1	17365	25/64	1
17348	1/8	1	17357	17/64	1	17366	13/32	1
17349	9/64	1	17358	9/32	1	17367	27/64	1
17350	5/32	1	17359	19/64	1	17368	7/16	1
17351	11/64	1	17360	5/16	1	17369	29/64	1
17352	3/16	1	17361	21/64	1	17370	15/32	1
17353	13/64	1	17362	11/32	1	17371	31/64	1
17354	7/32	1	17363	23/64	1	17372	1/2	1
17345	28 Pc 3/32 - 17/32 Transfer Punch Set		1	17374	17/32	1		



### Automatic Center Punch

IBS No. 141700

Automatic Center Punch delivers an automatic spring-driven strike when pressed down against a surface. Marks workpiece with a dimple, providing a starting point that prevents drill bits from wandering. Adjustable tensioner allows you to rotate the body of the center punch to regulate striking force. For use on various metals and woods. Hand operated, no hammer needed. Ball end for greater gripping power and reduced hand fatigue.

Features:

- Automatic spring-driven strike.
- Marks workpiece with a dimple.
- Prevents drill bits from wandering.
- Adjustable tensioner.
- Rotate body of center punch to regulate striking force.
- Use on various metals and woods.
- Hand operated.
- No hammer needed.
- Ball end for greater gripping power.

C  
A  
B  
I  
N  
E  
T  
S  
&  
T  
O  
O  
L  
S

### NES External Rethreading Tools



An essential tool for anyone who deals with nuts and bolts in: maintenance, construction, garages, plumbing, agriculture and engineering.

- Adjusts automatically to thread diameter & pitch.
- No measuring of thread required.
- Can be used on left and right hand threads.
- Can be used on both inch and metric threads.
- Two hardened steel blades (58RC) guided by the existing thread, regroove the damaged area.

Turn handle (A) to raise floating blades (B).

Place the tool over the thread to be repaired.



1 Open

Turn handle (A) to lower floating blades into grooves of thread and tighten by hand only.



2 Close

Turn the NES External fastener repair tool in the direction of the arrow.



3 Turn

**NES 1 External Tool**  
IBS No. 99152



**NES 2 External Tool**  
IBS No. 99162

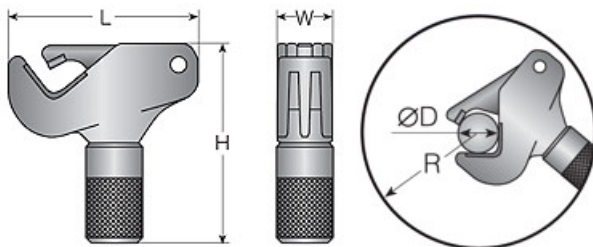

**NES 1 EXTERNAL TOOL** IBS No. 99152

NES 1	OD	Pipe	L	W	H	R
in.	5/32 to 11/16	up to 7/16	2-3/8	29/32	2-7/16	2-11/16
mm.	4-18		61	23	62	68

**NES 3 External Tool**  
IBS No. 99163

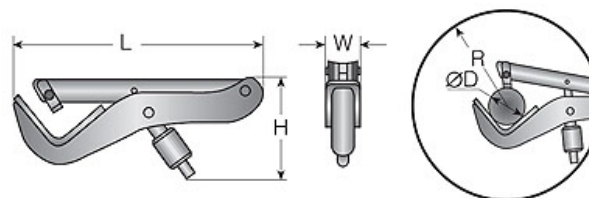

**NES 3 EXTERNAL TOOL** IBS No. 99163

NES 3	OD	Pipe	L	W	H	R
in.	1-1/4 to 5	1 to 4-1/2	12	1-3/4	5-1/8	9-7/8
mm.	32-128		305	44	130	250

**NES 2 EXTERNAL TOOL** IBS No. 99162

NES 2	OD	Pipe	L	W	H	R
in.	11/16 to 1-1/2	3/8 to 1-1/8	4-1/8	1-1/2	4-5/16	4-5/8
mm.	17-38		105	32	110	117



### NES Universal Thread Restorer 4 Pc Tool Kit



IBS No.	Description
122254	NES Universal Thread Restorer 4 Pc Tool Kit Contains all three NES Rethreading Tools. Replacement blades and internal thread cleaner tool included.

### NES Internal Thread Cleaner / Restoring Tool



IBS No.	Description
122252	NES Internal Thread Cleaner Restoring Tool
122253	NES Internal Thread Cleaner Replacement Blades

### NES Replacement Blades



IBS No.	Description
122249	NES1 Replacement Blades
122250	NES2 Replacement Blades
122251	NES3 Replacement Blades

### iNES Internal Rethreading Tap



An essential tool for anyone who deals with nuts and bolts in: maintenance, construction, garages, plumbing, agriculture and engineering.

- Adjusts automatically to thread diameter & pitch.
- No measuring of thread required.
- Can be used on left and right hand threads.
- Can be used on both inch & metric threads.
- Hardened steel blade (62RC) guided by the existing threads, regrooves the damaged area.

Turn knurled knob (K) to fully retract the blade (B) into the housing. Insert iNES tool into the threaded hole or bore to be repaired.

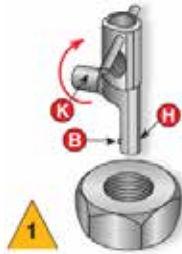

Turn knurled knob (K) to extend blade (B) into the thread groove on an undamaged section and tighten by hand only.



Rotate the iNES internal fastener repair tool by the cross rod, as shown, in the desired direction.

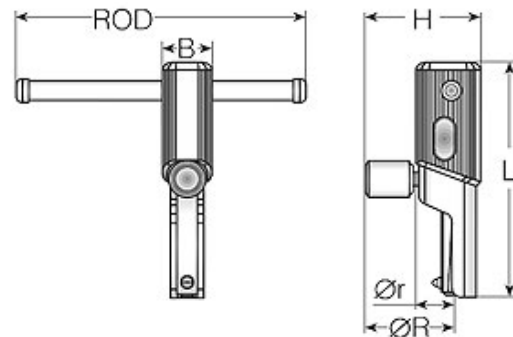

**iNES #22 IBS No. 126294**

iNES 22	OD	L	B	H	Rod	Or	OR
in.	1/2 to 5/8	4-5/8	11/16	1-3/4	5-3/8	11/16	1-9/16
mm.	12 to 16	109	18	45	136	17	39
pipes	1/4 - 3/8						

**iNES #24 IBS No. 126296**

iNES 24	OD	L	B	H	Rod	Or	OR
in.	7/8 to 1-1/4	5-3/8	1-1/16	2-1/2	6-3/8	1-1/16	2-1/8
mm.	22 to 32	136	27	64	161	27	54
pipes	1/2 to 7/8						

**iNES #23 IBS No. 126295**

iNES 23	OD	L	B	H	Rod	Or	OR
in.	11/16 to 13/16	4-3/8	13/16	2-1/16	5-3/4	13/16	1-3/4
mm.	16 to 20	111	21	53	146	20	45
pipes	3/8 - 1/2						

**iNES #25 IBS No. 126297**

iNES 25	OD	L	B	H	Rod	Or	OR
in.	1-1/4 to 2-1/8	6-7/16	1-1/2	3-3/16	7-9/16	1-3/8	2-7/8
mm.	32 to 54	163	38	81	192	35	62
pipes	7/8 to 1-3/4						



# IBS, INCORPORATED

## Miscellaneous Tools (T03)

C  
A  
B  
I  
N  
E  
T  
S  
&  
T  
O  
O  
L  
S

### 3 Pc iNES Internal Set



IBS No.	Description
126302	Contains #22 Small, #23 Medium & #24 Large iNES tools. Replacement blades included.

### 3 & 6 Pc NES Internal & External Tool Sets



IBS No.	Description
126303	Contains NES 1A Small External Tool, #21 Small & #22 Medium iNES Internal tools. Replacement blades included.
126304	Contains NES 1A Small & #2 Large External Tools, #21 Small, #22 Small, #23 Medium & #24 Large iNES Internal tools. Replacement blades included for internal tools.

### iNES Replacement Blades



IBS No.	Description
126298	iNES #22 Replacement Blades
126299	iNES #23 Replacement Blades
126300	iNES #24 Replacement Blades
NS-126301	iNES #25 Replacement Blades

### ThreadMate™ Set & External Tool



- Fixes any thread in diameter between M5-M12 (#12 - 1/2") internal and M4-M13 (5/32" - 1/2") external.
- A great solution for outdoor technicians, industrial maintenance, workshops, auto garages, marine use, farmers, auto mechanics, professional and hobby users, etc.
- Small size fits any toolbox.
- External thread repair tool repairs and restores external threads.
- Easy to use set with built-in knob — just set and turn.
- Kit contains replaceable nylon pads for soft metal repair jobs.
- Clean thread in both ways - inside out, or outside in.
- Easy to operate, no special thread knowledge required — works on USS, SAE, Metric, Fine, Coarse, etc.

IBS No.	Description	Qty
126290	MINI ThreadMate™ Kit	1
126292	MINI ThreadMate™ External Tool	1
126291	Replacement Blades Ext. Tool 1 pr.	1



### Spin-It-Out Damaged Screw Removers

The perfect tool for removing stripped and broken or damaged screws. The Spin-It-Out Damaged Screw Remover is extremely easy to operate. A Spin-It-Out extractor bit and a drill motor in reverse make light work of removing stripped out Phillips, Torx, Square Drive, Posi-Drive or even Tri-Wing head screws.

- Removes stripped and broken screws, saving time and money.
- The serrated design on the tip aggressively bites into damaged screws or drills into broken bolts helping to make broken screw removal faster and easier.
- Made of high quality M2 high speed steel for exceptional strength, making them strong enough to drill into hardened bolts.
- Number size corresponds with the number sizes of Phillips Head Screws.



IBS No.	Description	Qty
133310	Spin-It-Out 5 Pc Set	1

#### SPIN-IT-OUT REPLACEMENT BITS

IBS No.	Description	Qty
133311	#0 Spin-It-Out Extractor Bit	1
133312	#1 Spin-It-Out Extractor Bit	1
133313	#2 Spin-It-Out Extractor Bit	1
133314	#3 Spin-It-Out Extractor Bit	1
133315	#4 Spin-It-Out Extractor Bit	1

### Power-Outs™ Double Edged Screw Extractors

These patented double-edged screw extractors are made from hardened chrome vanadium steel with a burnished finish. The cutting edges are polished, and the part number and dimensions are laser marked on the shank for easy identification.



IBS No.	Size	SW Diam (in)	Drill Diam (in)		Screw Size (in)	
			Min	Max	Min	Max
139501	1	1/4	1/8	3/16	3/16	1/4
139502	2	3/8	3/16	9/32	5/16	3/8
139503	3	1/2	1/4	3/8	7/16	1/2
139504	4	5/8	11/32	1/2	1/2	9/16
139505	5	3/4	7/16	5/8	5/8	3/4
139506	6	7/8	9/16	3/4	7/8	1
139507	7	1	3/4	15/16	1	1-1/8
139395	5 Pc Set ( Sizes 1-5 in a plastic pouch)					

### Power-Outs™ Sets



IBS No.	Description
670P	5 pc Power Outs & 8 Pc LH Drill Extractor Set (1/16, 1/8, 3/16, 1/4, 5/16, 3/8, 7/16, 1/2)
745R	5 pc Power Outs Travel Tray w/Corresponding LH Drill Bits (5/32, 1/4 5/16, 7/16 & 1/2)
818R	5 pc Power Outs Travel Tray w/Corresponding LH Stubby Drill Bits (5/32, 1/4 5/16, 7/16 & 1/2)

C  
A  
B  
I  
N  
E  
T  
S  
&  
T  
O  
O  
L  
S



# IBS, INCORPORATED

## Screw Extractors P09

### Spiral Screw Extractors

Round shank helical flute screw extractors are used to remove broken screws, bolts, studs, pipe and lubrication fittings without damage to the threaded hole. They are designed with a left hand helical flute to firmly grip and remove any right hand threaded screw or bolt from 3/16 to 3-1/2 in size.



C  
A  
B  
I  
N  
E  
T  
S  
&  
T  
O  
O  
L  
S

IBS No.	Size	Drill Size	Diameter of Extractor		For Screw Sizes	
			Min	Max	Min	Max
57100	1	5/64	.060	1/8	3/32	5/32
57110	2	7/64	.080	3/16	5/32	7/32
57120	3	5/32	1/8	1/4	7/32	9/32
57130	4	1/4	3/16	5/16	9/32	3/8
57140	5	17/64	1/4	7/16	3/8	5/8
57150	6	13/32	3/8	5/8	5/8	7/8
57160	7	17/32	15/32	7/8	7/8	1-1/8
57170	8	13/16	11/32	3/4	1-1/8	1-3/8
57180	9	1-1/8	1	1-9/32	1-3/8	3-1/2
16712	10 Pc Set					



PN 16712

### Hex Head Spline Drive Screw Extractors (P09)

- Designed to remove broken studs, bolts, socket screws and fittings.
- For use with sockets and flat wrenches.
- Made in the U.S.A.



IBS No.	Size	Hex Hd Size	Bolt Dia.	Drill Bit Dia.
53201	1/8	1/2	#12	1/8
53202	5/32	1/2	1/4	5/32
53204	7/32	1/2	3/8	7/32
53205	1/4	1/2	7/16	1/4
53206	9/32	1/2	1/2	9/32
53207	5/16	1/2	9/16	5/16
53208	11/32	1/2	5/8	11/32
53209	3/8	1/2	11/16	3/8
53210	13/32	1/2	3/4	13/32
53211	7/16	5/8	13/16	7/16
53213	1/2	5/8	15/32	1/2
53217	5/8	3/4	1-3/16	5/8
53220	23/32	7/8	1-3/8	23/32
53225	7/8	1	1-11/16	7/8

### 25 Piece Hex Hd Spline Drive Screw Extractor Set

- Sizes 1/8" - 7/8"
- Designed to remove broken studs, bolts & socket screws from #12 - 1-3/4"
- For use with sockets and flat wrenches
- Packaged in a sturdy red plastic box for easy storage and organization
- Made in the U.S.A.



IBS No.	Description
53227	25 Pc. Hex Head Spline Drive Screw Extractor Set

### Golden Grip™

#### INTERNAL PIPE WRENCHES

No more busted knuckles, broken pipes or ruined walls. Golden Grip™ is the world's only self-locking, reversible internal pipe wrench that installs or extracts pipe nipples quickly and easily. Golden Grip is used with ratchets, extensions, and impact wrenches, making it easier to work in tight spaces.

Available in single grip sizes for 1/2" to 3/4" pipe, and double grip sizes ranging from 1" to 2" for Schedule 40 Pipe.

#### REVOLUTIONARY DESIGN

- Designed and manufactured from heat tempered steel to meet the demanding specifications of the professional tradesman.
- Each tool is individually inspected and assembled to assure the finest quality.
- Use on iron, chrome, and brass pipe - won't scar chrome!
- Self-locking and reversible.
- Will not damage threads.



IBS No.	Description	Qty
97250	1/2" Single Size	1
97251	3/4" Single Size	1
97252	1" & 1-1/4" Dual	1
97253*	1-1/2 & 2" Dual (* non-stock item)	1
97256	Set of all 4	1

### 5 Pc. 3/8" Drive Bolt/Stud Extractor Set 5/16" to 3/4"



IBS No.	Description
54115	Removes bolt sizes: 8mm, 10mm, 13mm, 19mm, 5/16, 11/16, & 3/4" in drive size 3/8"



### GrabitPro®

### Damaged Screw Remover

The GrabitPro quickly and easily removes most damaged screws such as Hex, Phillips, Torx, and Square Drive from wood, plastic or metal up to 3 inches in length. The serrated extracting end of the tool results in greater torque for hard to remove bolts and screws. The design of the shaft make them compatible with "quick change" chuck systems or can be chucked directly into a drill. Good for multiple extractions with a single tool.

#### FEATURES & BENEFITS

- The two ended design with a drill bit and extractor in one tool eliminates the need for multiple tools saving time and money.
- There is no bolt preparation required, such as grinding, smoothing, cutting, center punching or pre-drilling, making for a faster and more convenient repair.
- Self-centering drill tip eliminates walking or wandering, saving time and frustration.
- Works on jagged, uneven, and rough breaks where standard drills could chip or break.
- Tempered twice for extra hardness proving a tools with a longer life resulting in multiple extractions per tool saving time and money.
- Four (4) piece kit. Removes screw sizes AN4 to AN24, bolt sizes SAE 10 to 12, 1/4", 5/16", and 3/8" (Metric M5 to M10).
- Made in the U.S.A.

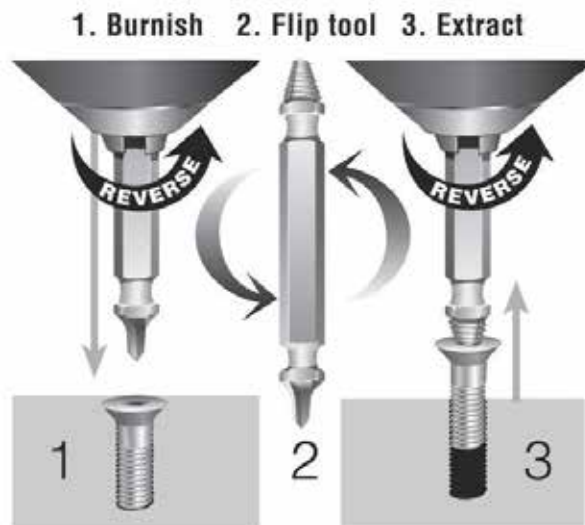

#### OPERATING INSTRUCTIONS

##### Burnishing

1. Insert GRABIT directly into drill or chuck - burnishing end is showing.
2. Set drill for reverse.
3. Place burnishing end of tool into damaged screw head until smooth.
4. NOTE: Burnishing end is not to be used to drill a hole.

##### Removing

1. Remove burnishing end from chuck, flip tool, replace into drill chuck — Remover end now showing.
2. Maintain reverse setting.
3. Place Remover end of tool into now smooth screw head.
4. Apply firm downward pressure, drill at slow speed. Apply lowest level of power to the hand drill.
5. Remover end of GRABIT will thread into screw head and remove.

##### WARNING:

Always wear safety glasses when operating or near power tools. Cutting tools may shatter when broken.

IBS No.	Description	Qty	For Screw Sizes
133318	#1 Grabit Pro	1	No. 4 to No. 7
133319	#2 Grabit Pro	1	No 8 to No. 10
133320	#3 Grabit Pro	1	No. 11 to No. 14
133321	#4 Grabit Pro	1	No. 16 to No. 24













C  
A  
B  
I  
N  
E  
T  
S  
&  
T  
O  
O  
L  
S



### Grabit Damaged Screw Remover & DriveGrip Assortment

IBS No. 794R 5 Items • 5 Pcs

Packaged in a locking plastic travel tray for easy storage & organization

 <p>SPECIALTY PRODUCTS FOR MAINTENANCE &amp; REPAIR INDUSTRIALBOLT.COM © © © 800-678-1906</p>				<h3>Grabit Damaged Screw Remover and DriveGrip Assortment</h3>	
Assortment 794R					
<p>133318 #1 GRABIT PRO</p>  <p>For Screw Sizes: No. 4 - No. 7, Bolt Size: No. 10 (5mm)</p> 	<p>133319 #2 GRABIT PRO</p>  <p>For Screw Sizes: No. 8 - No. 10, Bolt Size: 1/4" (6mm)</p> 	<p>133320 #3 GRABIT PRO</p>  <p>For Screw Sizes: No. 11 - No. 14, Bolt Size: 5/16" (8mm)</p> 	<p>133321 #4 GRABIT PRO</p>  <p>For Screw Sizes: No. 16 - No. 24, Bolt Size: 3/8" (10mm)</p> 	<p>52010 DRIVE GRIP ANTI CAM- OUT FLUID .5FL OZ</p>  <p>NET 0.5 FL OZ (15 mL)</p> 	

C  
A  
B  
I  
N  
E  
T  
S  
&  
T  
O  
O  
L  
S



# IBS, INCORPORATED

## Driver Bits P12

### Grabit® Drill-Out Broken Bolt Extractor Set

Removing stripped screws and bolts can be a frustrating experience, and now there's a solution! This 4 Pc. extractor kit removes broken bolts from as small as 1/4" to 1/2" (6mm-12mm) and can drill up to Grade 8 or 10.9 class fasteners. Each Drill-Out is a drill bit and extractor in one and is uniquely designed to drill into the rough surfaces when bolts break.

#### SINGLE STEP EXTRACTION FAST & EASY TO USE

A drill bit and extractor in one tool, the DRILL-OUT creates a unique interaction between drill bit and extractor, resulting in maximum impact and break out ability. Broken bolts and studs are removed quickly and easily without damaging the fastener threads.

- **Unique drill tip** allows the tool to stay on center
- **Self centering drill tip** eliminates walking or wandering.
- **No grinding, center punching or pilot hole** required.
- **Works on** jagged, uneven and rough breaks.
- **Tempered twice for extra hardness**; resulting in multiple extractions per tool.
- **Made from the highest quality M2 HSS Steel.**
- **MADE IN THE USA.**

#### USE IN REVERSE ONLY WHILE DRILLING OR EXTRACTING

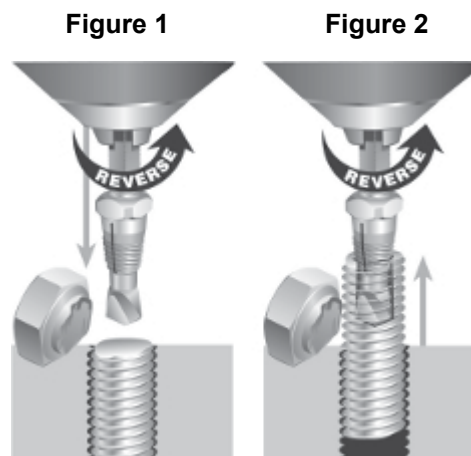

#### DRILLING:

1. **Choose the correct size DRILL-OUT.**
2. **Secure round end in the drill chuck and tighten.**
3. **Thread collet/extractor back against drill chuck.**
4. **Set drill in reverse and begin drilling a the suggested RPM's. (See Figure 1)**
5. **Tempered twice for extra hardness**; resulting in multiple extractions per tool.z  
REMEMBER: Hole must be straight & on center. DO NOT allow collet/extractor to move down toward tip while drilling.
6. **Made from the highest quality M2 HSS Steel.**
7. **MADE IN THE USA.**



IBS No.	Description	Qty
133309	Grab-It Drill Out Extractor 4 Pc Set 1/4" to 1/2" (6mm to 12mm)	1

C  
A  
B  
I  
N  
E  
T  
S  
&  
T  
O  
O  
L  
S

### External Deburring Tools 3Pc Set (T03)

**IBS No. 476P**



- Quickly repairs damaged threads from 7/64" to 2-1/3".
- Hardened HRC 60 Steel blades remove burrs and uneven ridges from threaded rods, pipes and more.
- Works on hardened and mild steels, Grade 8 fasteners, stainless steel, brass copper, aluminum, plastics, wood, etc.
- 1/4" hex shank attaches to your drill quickly.
- Most effective at low speeds — recommended speed should not exceed 500 RPM in a clockwise direction only.

IBS No.	Description	Shank	Qty
51951	Small Deburring Tool 7/64" to 7/16"	1/4"	1
51950	Medium Deburring Tool 5/16" to 7/8"	1/4"	1
51952	Large Deburring Tool 23/32" to 2-1/3"	3/8"	1
476P	3 Piece Set - Deburring Tools		1



REMOVE BURS



REPAIR DAMAGED THREADS



WORKS ON A VARIETY OF MATERIALS

### Nicholson® Pro Series 4-in1 Hacksaw Frame

Ideal for making flush, Sideways & Angle Cuts in Metal, Pipe & Tubing

The Nicholson® Pro-Series 4-in-1 hacksaw takes versatility and quality to an entirely new level. Its frame is designed to hold blades at a tension of up to 30,000 psi, for smooth straight cuts, whether in standard, 45° angle, or low profile configurations. And while some other hacksaws have jab saw capability, the unique design of the Nicholson Pro Series accommodates a heavy duty reciprocal saw blade for maximum performance in jab saw applications.

IBS No.	Description	Qty
16411	4-in-1 Hacksaw Frame	1



**Four Ways to Get the Job Done!**





# IBS, INCORPORATED

## Miscellaneous Tools (T03)

C  
A  
B  
I  
N  
E  
T  
S  
&  
T  
O  
O  
L  
S

### Reciprocating Saw Handle

- Instantly turn any standard reciprocating saw blade into a hand saw!
- Ergonomic handle with angled setting for additional leverage.
- Quick-twist lock securely holds any standard reciprocating saw blade or any 1/4" hex shank bit.
- Converts to a multi-bit screwdriver — handle stores 6 of the most popular bits: #5 & #6 Slotted, #1 & #2 Phillips and T15 and T20 Torx.
- Use to cut metal, wood, drywall and much more.



IBS No.	Description	Qty
44600	Reciprocating Saw Handle	1

### Heavy Duty Metal Scraper



Overall length is 9-1/4 inches\*

- Protective cap keeps the blade covered until it is in use. The cover then snaps on the back of the scraper to keep from losing or misplacing the cap.
- Ergonomic grip for better control.
- No push-button slide to expose the blade which often causes the blade to slide back when in use.
- Includes one standard straight razor blade for added value and allows the scraper to be used immediately.
- Perfect for scraping labels, decals, paint and adhesive from glass and other surfaces.

IBS No.	Description	Qty
16400	Heavy Duty Metal Scraper	1
16424*	Heavy Duty Extended Scraper 9-1/4"	1

### Snips & Shears (P11) Fiskars® PowerArc Utility Snips (8")

- PowerArc™ Utility Snips boast **intelligently curved blades** that alter the angle between the blades to give you over 2X more power, especially during the toughest part of the cut.
- **Offset design** with heavy-duty stainless steel blades can be used to cut materials from above or below, keeping waste material away from your hand.
- An **ergonomic, spring-assisted handle** helps reduce hand fatigue and features Softgrip® for enhanced dexterity and comfort.
- A **serrated edge, extended tang and bolted joint** improve control and durability.



IBS No.	Description	Qty
16420	Fiskars PowerArc™ Utility Snips	1

### Fiskars® PowerArc Easy Action Shears (10")

- PowerArc™ Easy Action Shears™ boast **intelligently curved blades** that alter the angle between the blades to give you over 2X more power, especially during the toughest part of the cut.
- A radically **ergonomic, spring-assisted handle** features an open top loop, allowing you to rotate your hand over the handle to apply more power, especially during the toughest part of the cut.
- In addition, **Softgrip®** enhances dexterity and comfort, a bigger bottom loop fits large gloved hands and an easy-open lock protects the blades during transport.
- **Heavy-duty coined stainless steel blades** help prevent separation.
- A **serrated edge, extended tang and bolted joint** improve control and durability.



IBS No.	Description	Qty
16421	Fiskars PowerArc™ Easy Action Shears	1

### Fiskars® PowerGear Plastic Pipe Cutter

- **PowerGear® technology** gives you over 35% more power to make cutting plastic pipes easier, while eliminating the need for ratcheting.
- This ingenious technology features a gear that provides more power during the toughest parts of the cut.
- **Replaceable stainless steel blades** cut from start to finish in a single, smooth stroke, while a tough stainless exoskeleton maximizes durability.
- An **ergonomic, spring-assisted handle** helps reduce hand fatigue and features Softgrip for enhanced dexterity and comfort.
- An **easy-open lock** simplifies usage while cutting a range of plastic pipes, including up to 1-1/4" O.D. PVC.



IBS No.	Description	Qty
16422	Fiskars PowerGear Plastic Pipe Cutter	1
16423	Replacement Blade for Fiskars PowerGear Plastic Pipe Cutter	1

### IBS "Rapid Razor" Utility Knife



- Autoloading design
- One-button blade change
- Ergonomic rubber grip
- Heavy duty die cast body
- Holds any standard utility or hook blade
- No tools needed
- 5 blades included



IBS No.	Description	Qty
16402	IBS "Rapid Razor" Utility Knife	1

### HD Retractable Blade 8 Pt. Breakaway Knife



- Steel blade track.
- Auto-locking
- High-visibility yellow.
- Comes with premium steel blades.
- Accepts all standard 8 point blades.
- Spare blade compartment.
- Ideal for cutting cardboard, wood, leather and more.
- For replacement blades use IBS No. 16409

IBS No.	Description	Qty
16403	HD Retractable Breakaway Knife	1

### Cartridge Loading Snap Knife with Rubber Grip



- Autoloading design
- Blade cartridge w/6 premium 8 pt blades
- Ratchet wheel for blade stability
- Ergonomic rubber grip
- Auto-locking
- For replacement blades use IBS No. 16409



IBS No.	Description	Qty
16408	Cartridge Loading Snap Knife	1



# IBS, INCORPORATED

## Miscellaneous Tools (P11)

C  
A  
B  
I  
N  
E  
T  
S  
&  
T  
O  
O  
L  
S

### Revo Folding Knife



- Comfort-grip finger loop for added safety and control.
- Two position cutting.
- 50% more blade-edge exposed for deeper cutting.
- Quick-change blade replacement.
- Metal belt clip.
- Use with IBS No. 16407 IBS Rapid Razor 100 BLADES/PK (purchase separately).

IBS No.	Description	Qty
16416	Revo Folding Knife	1

### Serrated Blades

100 Blades/Pkg

- **Sharp Serrated Blades** – Rapid Edge serrated utility knife blades feature multiple cutting edges that distribute friction evenly for faster, smoother cuts, and prolonged blade life.
- **All-Purpose Use** – These razor knife blades easily cut materials like cardboard, drywall, rubber, and carpet. Tackle projects without worrying about dull box knife blades.
- **Cost-Effective Bulk Pack** – Each pack includes 100 serrated utility knife blades, providing a reliable supply for offices, warehouses, or construction projects.
- **Seamless Compatibility** – These refill box cutter blades fit standard safety knives and Rapid Edge utility knives. Upgrade your existing tools with Rapid Edge serrated utility blades!
- **Durable Construction** – Made from alloy steel, Rapid Edge blades withstand tough jobs. Our serrated utility blades last longer than standard single-edge utility razor blades.



IBS No.	Description	Qty
16415	100 PK Shark Serrated Blades	1

### Magnetic Drill Press

- The optimal drilling speed designed for use with carbide and hss cutters on the toughest jobs and applications.
- Effective solution for drilling harder materials.
- Powerful magnet for easier placement and better holding power on thinner material.
- Cost effective drill for running with carbide cutters for longer life, higher cutting rate and capable of cutting harder materials.
- 1-3/8" MAX diameter annular cutter.
- 2" maximum drilling depth.
- 15.75" Height, 1100W, 11.5 Amp, 450-590 RPM.



IBS No.	Description
19467	Magnetic Drill Press up to 1-3/8 - 2"
19456	Arbor Adapter
19457	Drill Chuck

### Compact Magnetic Drill Press

#### Compact with Fixed Drill Motor for Work in Confined Spaces

- **Extremely compact** with ideal power to weight ratio for work at heights and in confined spaces.
- **Hand feed wheel mounts** on either side for use in special situations.
- **Die cast aluminum housing** for strength in the field.
- **Internal motor cable routing** prevents unintended threading or hanging up on the workpiece.
- Internal Cooling.
- **Easy** guide adjustment.
- **Stationary** drill motor.
- **Quill feed spindle** eliminates field maintenance and adjustments provides positive slug ejection.
- 1-5/8 maximum diameter annular cutter.
- 2" maximum drilling depth.



IBS No.	Description
19468	Compact Magnetic Drill Press for 1-3/8 - 2"

### Variable Speed / Reversible Magnetic Drill Press

#### Universal with 2 Speed Gearbox

#### For Use with 1-9/16 to 2" Annular Cutters

Compact with high functionality for universal use on the construction site and in the workshop.

- Simple and error-proof control concept in the operator's field of view.
- **Double drill motor guides** enable use of the largest core bits.
- **Reversible.**
- **Electronic speed control.**
- **High power motor** with stable speed.
- **High magnetic holding force.**
- Convenient magnetic holding force gauge.
- **Integrated cooling tank.**
- **Hand feed wheel** can be mounted on either side.



IBS No.	Description
19469	Variable Speed / Reversible Magnetic Drill Press

### Slugger Cutting Fluid for Mag Drills



- Water soluble concentrate makes up to 10 quarts of cutting fluid.
- Improves surface finish and reduces heat build up when drilling — extending the life of the cutter.
- Specially designed packaging with a sight window ensures proper mixing ratios.

IBS No.	Description
19463	Slugger Cutting Fluid for Mag Drills 1 Quart
19464	Slugger Cutting Fluid for Mag Drills 1 Gallon



# IBS, INCORPORATED

## Miscellaneous Tools T03

### Circular Saws (T03)

- Increase Productivity — No milling or deburring with near surgical dry-cut technology.
- Cuts a variety of Metals, Plastic and Wood.
- Cool to the Touch — No waiting for your workpiece to cool down.
- Precise Cutting — with integrated laser sighting sytem (7-1/4" saw only).



*Circular & Chop Saw Blades Sold Separately*

#### 7-1/4" CIRCULAR SAW

SPECIFICATIONS	7-1/4"
Part Number	137759
Cutting Capacity	2-1/4"
Weight	15 lbs.
Blade Diameter	7.25"
Arbor	3/4" (20mm)
RPM	3800
Beveling/Mitering	Beveling / 45°
Motor	120V / 1400W
Depth Adjustment	Yes
Chip Cover	1 Cover for Metal
Applications	Pipe, plate, channel, grating, roof decking, silos, emergency rescue.

- Powerful double-insulated motor for continuous loads
- Internally powered laser (no batteries required)
- Spring loaded lower guard
- Integrated chip collection
- Soft Start
- Electric Brake
- Smooth bevel and angle cutting adjustments
- Well balanced handle design for better control

**INCLUDES:** 1 tool case, 1 blade, 1 wrench, 1 guide plate, 1 safety eyewear, 1 ear protection, 1 instruction manual

**DO NOT USE** on materials thicker than 3/8" solid for aluminum, 5/16" for mild steel, or 1/4" for solid stainless steel.

#### 14" CIRCULAR SAW

SPECIFICATIONS	14"
Part Number	137760
Cutting Capacity	4-3/4"
Weight	54 lbs.
Blade Diameter	14"
Arbor	1" (25.4mm)
RPM	1300
Beveling/Mitering	Mitering / 45°
Motor	120V / 1800 W
Depth Adjustment	Two Position Vise
Chip Cover	Chip Tray
Applications	Pipe, plate, channel, conduit angle iron, metal studs, rebar, tubing, etc..

- Low speed high torque motor
- High Precision durable steel construction
- Cast aluminum base
- Quick release table/base clamp cuts 0° to 45°
- Smooth bevel and angle cutting adjustments
- Eye protection plate
- Table/base clamp with quick release
- Depth stop
- Well balanced handle design for better control
- Integrated chip collection

**INCLUDES:** 1 tool case, 1 blade, 1 wrench, 1 guide plate, 1 safety eyewear, 1 ear protection, 1 instruction manual

**DO NOT USE** on materials thicker than 3/8" solid for aluminum, 5/16" for mild steel, or 1/4" for solid stainless steel.

C  
A  
B  
I  
N  
E  
T  
S  
&  
T  
O  
O  
L  
S



### Excalibur Butane Solder Torch Kit



A self-igniting and cordless Soldering Iron, Hot Air Blower and Butane Torch complete in 1 great tool! The Piezo electric instant ignition system provides a quick start-up in any mode.

Includes a wide range of tips, wrench, sponge and a tube of solder for all your needs.

Includes a handy, impact-resistant travel case for complete mobility, moves easily from the workshop to the field. Case holds everything cleanly for quick, hassle-free storage.

IDEAL for: Electronic System Repair, Automotive, Industrial, Woodworking, Lapidary, Optical, General Maintenance and Professional Repair Jobs.

IBS No.	Description
141060	Excalibur Solder Torch Kit

### Microtorch Butane Torch

At only 5-1/4" high with a 2500°F flame, the MICROTORCH is ideal for all types of professional use. Refillable with premium grade butane (IBS No, 95007 - 42 grams). A versatile and handy addition to any professional workshop.



IBS No.	Description
125738	MICROTORCH Butane Torch

### Industrial Butane Torch

Powerful, portable, refillable and anti-flare with a flame temperature of over 2500°F, the INDUSTRIAL TORCH is ideal for automotive, plumbing, and professional repair shop use.

Functions & Uses: Lead Gutters, Toughen Metal, Sweat Fittings & Joints, Loosen Bolts, Stripping Paint, Dry Cements, Automotive, Repair, Plumbing, Lay or Remove Tiles & Professional Use.



IBS No.	Description
125739	Industrial Butane Torch

### Butane Refill

- Universal tip fuels most leading butane lighters
- Low in non-volatile contaminants which can cause burner valve to clog, affecting flame height and function.



**WARNING: USE THIS PRODUCT ONLY AS DIRECTED ON THE PACKAGE.**

**INTENTIONAL MISUSE BY DELIBERATELY CONCENTRATING AND INHALING THE CONTENTS CAN BE HARMFUL OR FATAL.**

**KEEP OUT OF REACH OF CHILDREN. DO NOT DISTRIBUTE TO MINORS.**

IBS No.	Description
95007	BUTANE Refill 75 ml

### Dual Temp Electric Heat Gun

A general purpose heat gun that is ideal for most heating applications, including applying heat shrink tubing, stripping paint, thawing pipes and loosening floor tile.

- 2 temperature settings (750°F & 1000°F) for versatility & various applications.
- 4100 BTU output for removing multiple layers of paint.
- 1200 Watts make this a powerful heat gun.
- Measures 16.5 x 9.8 x 17 inches



IBS No.	Description
141096	Dual Temp Electric Heat Gun
141305	Concentrator Nozzle
141306	Flare Nozzle
141307	Glass Protector Nozzle

CABINETS & TOOLS



# IBS, INCORPORATED

## Miscellaneous Tools T03

C  
A  
B  
I  
N  
E  
T  
S  
&  
T  
O  
O  
L  
S

### Universal Crimping Tool

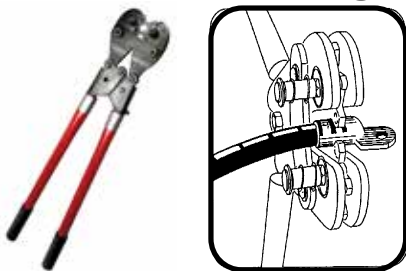

- Double Compound Action effortlessly exerts maximum force for fast, reliable crimps every time.
- Rotating Dies accommodate all sizes of battery terminals, lugs and connectors eliminating loss or need to store individual dies.
- Diamond Shape Crimp compresses all strands together to form a solid mass of copper. This assures a low resistance connection every time.
- Easy To Use Reference Chart located on tool eliminates guess work enabling competitive products to be crimped accurately.
- Wire Range : #8 Gauge through 250 MCM.

IBS No.	Description
B0283	Universal Crimping Tool

### High Capacity Hydraulic Crimper



High Capacity Hydraulic Crimper creates strong mechanical connections with crisp and sharp corners. The powerful hydraulic action delivers 70kN (15,736 Lbf) of force for **secure crimps**. This crimper includes 8 hardened steel die sets, and is ideal for battery and welding cables.

- Powerful hydraulic action delivers nominal force of 10 tons for secure crimps.
- Ideal for battery and welding cables.
- Creates strong mechanical connections with crisp and sharp corners.
- Features non-slip handle and ON/OFF retractor knob for safety.
- Includes 8 hardened-steel die sets from #6 to 4/0 AWG.

IBS No.	Description	Qty
141981	High Capacity Hydraulic Crimper	1

### Battery Cable Stripper

- Wire Range: 8 GA to 4/0
- Length: 3-3/4 inches



IBS No.	Description
B0285	Battery Cable Stripper

### Indent Crimper

- Wire Range: 8 Ga. to 4/0
- Length : 3-3/4"



IBS No.	Description
B0840	Indent Crimper

### Cable Cutter

- Wire Range: 8 Ga. to 350MCM
- Length : 16-1/2"

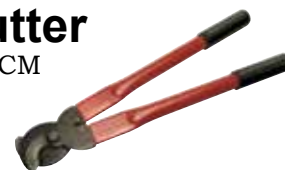

IBS No.	Description
B0014	Cable Cutter

### Wire Cutter

- Wire Range: Up to 2/0
- Length : 7-3/4"



IBS No.	Description
B0012	Wire Cutter

### 12 Volt Tester

- Durable, High quality tester.
- Ideal for testing lighting and wiring circuits in auto, truck, trailer and marine applications.
- Insulated mini-gator clip for positive contact.
- Sharp pierce point for penetrating all low voltage wiring.
- Bulb replaceable with standard automotive bulb.



IBS No.	Description
0690T	12 Volt Tester



### Wire Crimp Tool



A versatile, heavy-duty tool, made of .140" high-strength, heat-treated carbon steel. It is lightweight without sacrificing strength. It handles a variety of terminal and connector styles, including FLAGS, closed-end connectors, crimp sleeves and standard parts, insulated and non-insulated, over a broad range of 26-6 AWG.

- Anvil Type wire cutter.
- Crimp dies for #26-10 AWG insulated terminals, and connectors, and closed-end connectors.
- Cuts & re-threads 4-40, 6-32, 8-32, 10-24, and 10-32 machine screws.
- Crimp die for #12-6 AWG non-insulated terminals, connectors, FLAGS, quickslides, crimp sleeves and high temperature terminals.
- Crimp die for insulated terminals and butt connectors, wire sizes #8-6 AWG.
- Crimp die for #26-14 AWG non-insulated terminals, connectors, FLAGS, quick-slides and crimp sleeves.
- Wire-stripping stations.
- Strip length guide.
- Textured, cushioned grips.

IBS No.	Description	Qty
TH450	Wire Crimp Tool	1

### Battery End Power Cleaning Brushes (P25 & T03)

These brushes remove and polish corroded battery posts to ensure optimal conductivity. Brushes fit easily and securely in any electric, cordless or pneumatic drill.

- Cleans & polishes up to 1,000 battery posts.
- Heavy duty injected molded housing.
- Resilient steel bristles.
- Accepts 1/4" hex shank. Fits all drills or cordless screwdrivers.
- Acceptable RPM rating between 400-800



4-in-1 Tube Fitting Brush



Marine

IBS No.	Description	Qty
133343	Marine Power Brush	1
44690	4-in-1 Tube Fitting Brush (P25)	1

### Ratcheting Crimp Tool Sets Available with 4 Additional Dies for Crimping A Variety of Terminals with One Tool!



- 4 Crimp Nests: 8 AWG Red; 12-10 AWG Yellow; 16-14 AWG Blue; 22-18 AWG Red
- Mating mechanism prevents jaws from slipping or misalignment.
- Long handles make it easier to crimp - Less force required.
- Easy-to-use and understand release mechanism.
- Ergonomic design to initiate the crimp process.



#### Dies Available:

- For open barrel terminals: 20GA thru 10GA
- For Insulated Closed End Connectors
- For Double Crimp Insulated Terminals: 24GA thru 10GA
- For Insulated Flag Terminals

IBS No.	Description	Qty
B0050	Ratcheting Crimp Tool	1
B0051	Ratcheting Crimp Tool & Dies Kit	1
B0052	Ratcheting Crimp Tool Case & Dies — No Tools	1
B0053	Ratcheting Crimp Tool Die for 22-10GA Insulated Closed End Term	1
B0054	Ratcheting Crimp Tool Die with Locator for 20-10 GA Open Barrel Connectors	1
B0055	Ratcheting Crimp Tool Die for 22--14 GA Insulated Flag Terminals	1
B0056	Ratcheting Crimp Tool Die for 26-10 GA Double Grip Insulated Terminals	1

CABINETS & TOOLS



# IBS, INCORPORATED

## Miscellaneous Tools T03

C  
A  
B  
I  
N  
E  
T  
S  
&  
T  
O  
O  
L  
S

### Deutsch Connector Tools



*Removal Tool   Economy Crimp   Crimping Tool*

IBS No.	Description	Qty
125124	Deutsch Removal Tool	1
125125	Deutsch Crimping Tool	1
125127	Deutsch Economy Crimping Tool	1

### Metripack Crimping Tool



IBS No.	Description	Qty
125225	Metripack Crimping Tool	1

### Metripack Terminal Removal Tool



IBS No.	Description	Qty
125226	Metripack Terminal Removal Tool	1

### Weatherpack 22-12GA Crimper



IBS No.	Description	Qty
125325	Weather-Pack 22-12GA Crimper	1

### Weatherpack Terminal Extractor Tool



IBS No.	Description	Qty
125326	Weather-Pack Terminal Extractor	1



**CENTER PUNCH BAND-IT CLAMP  
LIGHT DUTY HAND TOOL**

IBS No.	Description	Qty
60150	Center Punch Band-It Clamp Light Duty Hand Tool	1

### BAND-IT Center Punch Clamps Light Duty Hand Tool Instructions



1. Tool is designed specifically for 3/8" and 5/8" center punch clamps only. Insert clamp in tool and then insert wrench assembly. If you prefer, install wrench assembly before clamp is inserted. Slot must be aligned with clamp tail.

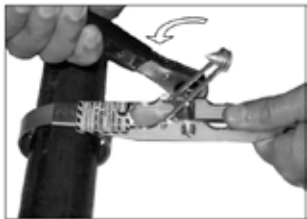

2. Start "pumping" ratchet wrench forward until proper tension has been applied.

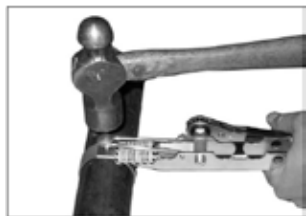

3. Place punch on clamp and while holding tension with ratchet wrench, lock clamp by striking punch once or more with hammer, depending on object being clamped.



4. While holding tension with wrench, pivot tool up against buckle, then backward several times to break off clamp tail.

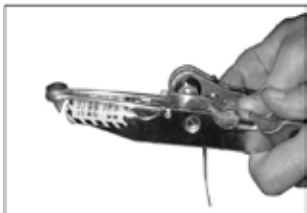

5. To loosen clamp tail, wind ratchet wrench until tail is free. Remove ratchet wrench assembly and clamp tail.



**CENTER PUNCH BAND-IT CLAMP  
HEAVY DUTY HAND TOOL**

IBS No.	Description	Qty
60149	Center Punch Band-It Clamp T300 Heavy Duty Hand Tool	1

### BAND-IT Center Punch Clamps Heavy Duty Hand Tool Instructions

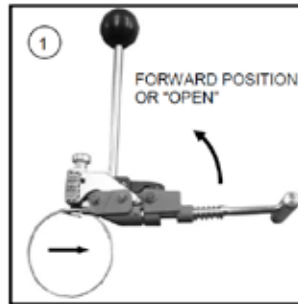

1. Push tension handle all the way forward. Insert BAND-IT Center punch clamp tail and push all the way into tool.

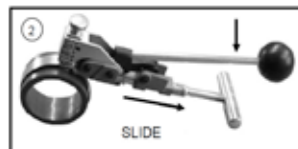

2. Tighten the clamp with short downward strokes. Tension handle should be in down position at completion of tightening clamp.

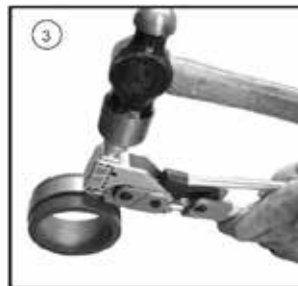

3. Holding tension down, lock clamp by hitting punch at least twice with a 2 lb. mallet.



4. Hold work-piece and pivot the tool back and forth to break off clamp tail. Remove tail from tool by operating tension handle. When tail has moved through holding dog, raise tension handle and pull tail free.



# IBS, INCORPORATED

## Miscellaneous Tools T03

C  
A  
B  
I  
N  
E  
T  
S  
&  
T  
O  
O  
L  
S

### Cable Tie Gun (Q04) 3/32" - 3/16" Capacity



- **Capacity:** 3/32-Inch (2.4mm) to 3/16-Inch (4.8mm) wide and up to 1/16-Inch (1.58mm) thick — **works on 18 lb. to 50 lb. cable ties.**
- **Generates 18-50 Pounds** of tensile strength for a firm and snug bundle.
- **Flush cuts end of cable tie** for a clean and smooth end, eliminating the hazardous, sharp edges left behind with regular tie ends.
- **Adjustable bundling pressure**, allowing it to be used on various types of materials without damaging the material.
- Body is **constructed of high impact nylon and fiberglass** for strength and durability.
- Not compatible with stainless steel ties.



IBS No.	Description	Qty
141416	Cable Tie Gun	1

### Mini Cable Tie Gun

- Secures and cuts cable ties.
- 18-50 lbs tensile strength.



ALWAYS WEAR SAFETY GLASSES  
DO NOT OVER-TIGHTEN

IBS No.	Description	Qty
104487	Mini Cable Tie Gun	1

### Can-Gun

#### Aerosol Trigger Attachment

- Minimizes user fatigue associated with using aerosol nozzles.
- Consistent pressure means less clogging and even application.
- Made of durable plastic for long life.
- Easy to attach, easy to remove, fits most aerosol cans.
- Balances can for easy, fatigue free application — great for big jobs.
- Handle eliminates finger on nozzle and means less skin irritation and mess due to chemical over-spray.



IBS No.	Description	Qty
74200	Can Gun Aerosol Trigger Attachment	1

### Shur-Shot Dispensing Gun

Also works with LOCTITE 2-Part Clear (IBS No. 97434) and FAST SET STEEL

#### Static Mixers

Also works with LOCTITE 2-Part Clear (IBS No. 97434) and FAST SET STEEL



IBS No.	Description	Qty
EQ016	Shur-Shot Dispensing Gun	1
EQ115	Static Mixers	1

### 32 oz. Pressurized Sprayer & 32 oz. Measuring Pitcher

Measuring and spraying system for use with the 5 gallon Brake & Parts Cleaner II.



121043                      121080                      155070                      123776

IBS No.	Description	Qty
121043	32 oz Pressurized Sprayer	1
121080	32 oz Measuring Pitcher	1
155070	Spot Spray Measuring Kit	1
123776	Spot Spray Filler Cap Assembly	1

### Caulking Gun



IBS No.	Description	Qty
49600	Caulking Gun	1

### Spray Bottle & Trigger Sprayers



IBS No.	Description	Qty
74306	Trigger Sprayer for Spray Bottles	1
74307	Empty Spray Bottle	1

### Medium Duty Grease Guns

- Develops pressure up to 10,000 psi.
- Automatic variable pressure.
- Delivery: 1 oz. per 21 strokes.
- Air vent fitting.
- Vinyl grip.
- Deluxe pull handle with heavy-duty rivets & positive stop.
- Heavy-duty one-piece head.
- Three-way loading - loader fitting included.



IBS No.	Description	Qty
500HD	Medium Duty Grease Gun	1

- Three-way loading - loader fitting included.
- 4500/3000 psi.
- Automatic variable pressure.
- Delivery - 1 oz. per 33, 16 strokes.
- Air vent fitting.
- Vinyl grip.
- Deluxe pull handle with heavy duty rivets.
- Heavy duty one-piece head.



IBS No.	Description	Qty
525HD	Medium Duty Grease Gun	1

### Mini Grease Gun

- Uses standard 3 Oz. (85.05g) grease cartridge.
- Right hand direction.
- Capacity Range: 100 to 600 Ft lbs.



IBS No.	Description	Qty
25703	Mini Grease Gun	1



# IBS, INCORPORATED

## Miscellaneous Tools T03

C  
A  
B  
I  
N  
E  
T  
S  
&  
T  
O  
O  
L  
S

### LockNLube Coupler

The LockNLube Coupler has a unique sliding sleeve, activated by thumb lever. The sleeve either locks the four spring-steel jaws onto the zerk fitting or releases the jaws from the zerk. No hands are needed to align or hold the coupler in place while greasing. The locked connection is positive and rigid, preventing the coupler from coming loose and breaking the leakproof seal.



- Works with all grease gun types: pneumatic, manual and electric.
- Works on all DIN and SAE specification zerks.
- Fits 1/8" pipe thread.
- Works with all grease gun manufacturers.
- No need to hold while greasing. Lock-on and free up both hands to operate the grease gun. — simply depress the trigger to release, even under pressure.
- Durable nitrile rubber seal for longevity under high pressure.
- Four hardened spring steel jaws are resilient under high pressure.
- Check valve to reduce leakage.
- LOCK N' LUBE XL with a longer barrel has a 3.6" effective reach.

IBS No.	Description	Qty
5855	LockNLube Locking Grease Coupler	1
5856	LockNLube XL Locking Grease Coupler	1
5860	LockNLube Repair Kit	1

### Locking Dual Wheel Adapter

A quick & easy way to inflate dual wheels. This new air chuck adapter features a two-jaw locking design and patented remote actuator. Easily attach and disconnect with the actuator — no need to reach in to disconnect.

The Dual Locking Head allows you to push onto valves facing towards you, or pull onto the valves facing away from you.

- Overall Length: 15.5 in. (40cm).
- Maximum pressure: 150 PSI (10.3 BAR)



IBS No.	Description	Qty
5859	Dual Wheel Locking Air Chuck Closed-15.5"	1

### LockNFlate Air Chucks

DEPRESS THE THUMB LEVER & PUSH ON THE TIRE VALVE, RELEASE THE LEVER TO SECURE THE AIR CHUCK & CREATE A LEAK-FREE CONNECTION!



**LOCKS ON STAYS ON WON'T LEAK!**

IBS No. 5858

SLIDING SLEEVE SECURELY LOCKS THE AIR CHUCK ONTO THE SHRADER VALVE

HARDENED STEEL COLLET FITS ALL SHRADER VALVES RATED TO 150 PSI

### Also available in 90° for Tight Spaces



IBS No. 5851

### SECURE - HANDS-FREE - LEAK-FREE

- **REVOLUTIONARY DESIGN** six steel jaws lock onto any Schrader valve to create a secure, hands free connection.
- **1/4" NPT THREAD SIZE** compatible with most standard air hoses.
- **HARDENED STEEL COLLET** Fits ALL standard Schrader valves (VG8 /8V1 valve threads).
- **RATED TO 150 PSI** Suitable for garage & Industrial systems, auto and manual tire inflators, portable pressure gauges & constant pressure systems.
- **HEAVY DUTY CONSTRUCTION** is built to last and stand up to everyday use even in the busiest tire shops, service bays and garages.
- **DURABLE, SPRING LOADED TPU SEAL** Inflates tires with or without the core valve in place.

IBS No.	Description	Qty
5851	LockNFlate 90 Degree Locking Air Chuck	1
5858	LockNFlate Locking Air Chuck	1

### Also available in XL for Large Bore

- Fits ALL large bore Schrader valves (VG12/12V1 valve threads) found on heavy duty construction, mining, and agricultural machinery.
- 250 PSI high-flow design, making it faster and easier to fill large tires.



IBS No.	Description	Qty
5850	LockNFlate Large Bore Locking Air Chuck	1

### Rivet Nut Gun



This thin sheet setting tool has been designed to enable threaded nut inserts to be threaded easily by hand. Invaluable to maintenance engineers for on the spot repairs.

- Designed for the quick manual insertion of permanent load bearing threads in materials from 0.20" to 0.128."
- Simple set up and easy uniform stroke allows a nutsert to be set in thin sheet materials without causing surface damage.
- A comprehensive range of mandrels and nosepieces are available.

#### RIVET NUT GUN MANDRELS & NOSEPIECES

IBS No.	Description
49500	Rivet Nut Gun Tool Only No Mandrels or Nosepieces
49507	6-32 Mandrel & Nosepiece
49508	8-32 Mandrel & Nosepiece
49510	10-24 Mandrel & Nosepiece
49511	10-32 Mandrel & Nosepiece
49512	1/4-20 Mandrel & Nosepiece
49513	5/16-18 Mandrel & Nosepiece
49514	3/8-16 Mandrel & Nosepiece
NS-49520*	4mm Mandrel & Nosepiece
NS-49521*	5mm Mandrel & Nosepiece
NS-49522*	6mm Mandrel & Nosepiece
NS-49523*	8mm Mandrel & Nosepiece

\* Order as non-stock item

### Heavy Duty Nutsert Tool

Ideal for installing larger size threaded inserts. This heavy-duty tool installs 1/4-20 through 3/8-16, and 5mm through 10mm threaded inserts in aluminum or steel. Quick changing mandrels, easily adjustable stroke. **1/4-20 nosepiece and mandrel included.**



#### HEAVY DUTY NUTSERT TOOL MANDRELS & NOSEPIECES

IBS No.	Description
49550	Heavy Duty Nutsert Tool includes 1/4-20 Mandrel & Nosepiece only
49551	1/4-20 Mandrel & Nosepiece
49552	5/16-18 Mandrel & Nosepiece
49553	3/8-16 Mandrel & Nosepiece

### Swivel Head Professional Rivet Tool

- Rivet head swivels 360° for riveting at any angle.
- Hardened steel construction
- Extended nosepiece for hard to reach locations.
- Comfortable non-slip handle grips.
- Not recommended for nylon rivets.
- Includes nosepieces: 3/32, 1/8, 5/32 & 3/16.



IBS No.	Description
HP-5	Swivel Head Professional Rivet Tool

Rivet Diameter	3/32	1/8	5/32	3/16
Aluminum	YES	YES	YES	YES
Steel	YES	YES	YES	NO
Copper	NO	YES	NO	NO
Stainless Steel	NO	YES	NO	NO



### Heavy Duty Rivet Tool



The **HP-2** is the number one selling hand rivet tool in the industry. Known and trusted for durability, quality and performance, the HP-2 is often copied but never duplicated. Its square shoulder fulcrum pin of cold-formed heat-treated steel prevents pin rotation that can elongate the engaging holes and cause premature tool failure in imitation tools.

Other quality features include: precision die-cast, high-strength aluminum alloy body; drop-forged carbon steel upper handle; and thick, cushion molded vinyl grips for comfort. The HP-2 sets up to 3/16" steel rivets and comes with four mounted nosepieces (3/32", 1/8", 5/32" and 3/16") and a service wrench.

- **Square shoulder fulcrum pin of cold-formed heat-treated steel** prevents pin rotation that can elongate the engaging holes, a leading cause of premature tool failure in imitations – fewer failures means less rework time, faster installations – equals time and money savings!
- **Precision die-cast, high-strength aluminum alloy body** makes this tool super durable while keeping it light-weight – means longer life and comfortable to use.
- **Drop-forged steel upper handle gives this tool added strength** for extended service life.
- **Thick cushion-molded vinyl grips for comfort** means better productivity and less likely for fatigue and injury.
- **Sets steel and aluminum rivets** from 3/32" to 3/16", and stainless steel up to 5/32"

IBS No.	Description
HP-2	Heavy Duty Rivet Tool

### Big Daddy Manual Rivet Tool



The Big Daddy is a **versatile and powerful hand riveter**, taking the hard work out of setting large diameter blind rivets.

- **Extra-long handles provide excellent leverage** and permit working a foot beyond natural reach.
- **Patented bearing design, self-adjusting two-piece jaws and single-unit body construction** with a steel insert to provide stronger threads for the nosepieces included.
- **Double gear reduction system** easily sets from 1/8" to 1/4" diameter rivets in all alloys.
- **One piece collet case eliminates the need to adjust the tool** when changing rivet diameters.
- **5/32", 3/16" and 1/4" nosepieces**, which are stored in the body
- Weighs 3.75 lbs

IBS No.	Description
49520	Big Daddy Manual Rivet Tool

C  
A  
B  
I  
N  
E  
T  
S  
&  
T  
O  
O  
L  
S

### ReelTek™

#### Air / Water Reels for Light Industrial Use

A new, lighter spring-driven hose reel designed for applications that are less demanding, yet require a product that can withstand industrial use. ReelTek's hybrid design incorporates industrial-grade steel and composite materials to virtually eliminate corrosion.

Easy-to-install and maintain, ReelTek™ conveniently keeps hoses organized for a more efficient, safer work area. Simply pull out the hose to the desired length, lock into position during use, and retract when finished. Hoses stored on reel last five times longer, stay out-of-sight, and out-of-the-way.

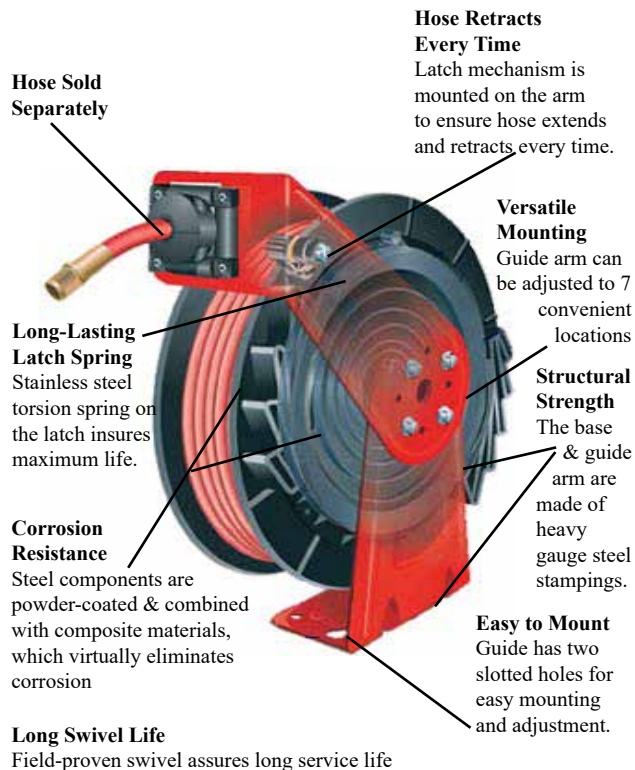

#### REELTEK™ HOSE & REEL ASSEMBLIES

IBS No.	Description	Qty
131272	Reel for 3/8" x 50' Hose 3/8" x 50' Flexeel Hose Rubber Stopper	1
131294	Reel for 3/8" x 50' Hose 3/8" x 25' Flexeel Hose Rubber Stopper	1

#### REELTEK™ HOSE REELS

IBS No.	Description	Qty
131185	Reel for 3/8" x 50' Hose	1

#### REPLACEMENT HOSE

IBS No.	Description	Qty
130491	1/4" x 50' Flexeel Polyurethane Air Hose	1
130494	3/8" x 50" Flexeel Polyurethane Air Hose	1

#### ACCESSORIES

IBS No.	Description	Qty
131186	Rubber Stopper	1

### Installation . . . Easy as 1, 2, 3



#### Step 1

Locate stud & layout bolt hole pattern of the reel. Drill pilot holes into the stud

#### Step 2

Thread lag screws into pilot holes.

#### Step 3

Hang reel onto lag screws and tighten securely. Ready to use.

### ReelTek is ideal for . . .

- Light industrial
- Air-powered tools
- Assembly lines
- Machine shops
- Maintenance shops
- Auto / truck repair
- Auto Paint & Body
- Farm & ranch
- Woodworking
- Garden shops
- Home workshops
- Many more uses



# IBS, INCORPORATED

## Miscellaneous Tools T03

C  
A  
B  
I  
N  
E  
T  
S  
&  
T  
O  
O  
L  
S

### Hose Crimper

- Provides production capability for crimping standard hose.
- Gives "big tool" crimping advantages at just a fraction of the cost.
- Comes with 5 dies to crimp 1/4"-1" braid to 3/8" - 2" braid.
- Die Sizes: 5/8" 37/64" 17/32" 31/64" 11/16"
- Rugged Construction: High strength ductile iron casting.
- Self-contained & Portable: All dies in one place, ready for use.
- One-hand operation: Positive camming action allows for good leverage at end of lever stroke.



IBS No.	Description	Qty
AM855	Hose Crimper	1

### Hose & Tubing Cutter

#### CUTS FLEXIBLE HOSE UP TO 1-1/4"

- Cleanly cuts heater hoses, fuel lines and other types of flexible hose up to 1-1/4".
- Stainless steel blade is reversible for double the life.
- Plier is made of glass-filled nylon for strength.



IBS No.	Description
11420	Hose & Tubing Cutter
11450	Replacement Blades (1)

### Hydraulic Crimper

DROP SHIPS FROM MANUFACTURER



- Heavy duty 60+ ton capacity
- 1/8 to 1-1/4 6-wire capability
- Fully adjustable crimp settings
- 0.125 to 2.75 crimp capability
- Auto micro-switch shut-off
- Good crimp visibility
- Comes with 5 dies standard
- Includes die holder
- Quick crimp cycle time
- Well accepted Dayco die configuration
- Interchangeable with Dayco dies
- Built for longevity

IBS No.	Description	Qty
KH60	Hydraulic Crimper	1

### Indexing Pry Bars

Designed to improve access in tight applications, the head of the pry bars can be adjusted to 14 different positions, offering more than 180° of angle. The new, innovative indexing feature allows the user to gain more leverage. The 8" Indexing Pry Bar can also function as a seal pick for removing engine and axle drive seals. In addition to the fixed length Indexing Pry Bars, an expandable version is available that extends from 18" to 29" .



Grooved foot for added traction. CA-82220 Extendable



IBS No.	Description
CA-82208	8" Indexing Pry Bar
CA-82210	10" Indexing Pry Bar
CA-82216	16" Indexing Pry Bar
CA-82224	24" Indexing Pry Bar
CA-82220	18 to 29" Extend Index Pry Bar
CA-82248	29 to 48" Extend Index Pry Bar

### 16" Adjustable Pry Bar/Nail Puller

An innovative demolition, renovation and construction tool.

- Recipient of the Popular Mechanics Editor's Choice Award for 2012.
- Adjustable jaws slide and clamp onto objects for straightening and prying.
- Crow bar end with nail puller slot.
- Striking hammer head surface for striking
- Large claw on head that adjusts for leverage in pulling nails.



IBS No.	Description	Qty
CA-82000	16" Adj Pry Bar / Nail Puller	1

### IBS Service Broom

- Moderate stiffness, large angled trim upright broom has a sturdy metal capped construction and fused polypropylene bristles for superior performance and long life.
- The large angle bristle flare design and comfortable handle allow for fast clean up of a wide variety of jobs.
- Private labeled with the IBS Logo and tagline "The Mark of Our Quality is in Our Service."



IBS No.	Description	Qty
42010	IBS Service Broom	1

### Pump Up Sprayer 0.5 Gallon

Hand pump sprayer is **convenient and easy to use** with cleaners, degreasers, solvents, insecticides and other solutions. Small enough for **hand-held applications** and large enough to **hold 0.5 gallons for effective cleaning** or application.



- **0.5 Gallon / 2 Liter** capacity tough poly tank - light weight, durable and chemical resistant.
- **Viton seals** provide maximum chemical resistance that extends the life of the sprayer.
- **Versatile** - nozzle adjusts from stream to fine mist.
- **Locking thumb-operated control valve** for easier and more comfortable dispensing.
- **Saves time - wide mouth opening** allows for quick refills.

IBS No.	Description	Qty
74310	Pump Up Sprayer 0.5 Gallon	1



C  
A  
B  
I  
N  
E  
T  
S  
&  
T  
O  
O  
L  
S