



Hardware & Springs

A

Assortments

- Polyurethane Bungee Ball Bundle U-3
- Polyurethane Straps Variety Pack U-3
- Quick Links & Spring Links U-8
- Roller Chain & Offset Chain Links U-10
- Springs
 - Compression U-12
 - Extension U-13

B

Brushes, Floor

- 24" Pro-Flex Floor Brush U-17
 - Coarse
 - 24" Block U-17
- IBS Service Broom U-17
 - Medium
 - 18" Block U-17
 - 24" Block U-17

Brushes, Misc.

- 4-in-1 Tube Fitting Brush U-18
- Acid Brushes U-18
- Chip and Oil U-18
- Counter Duster U-17
- Handles & Braces U-18
- Parts Cleaning U-18
- Squeegees U-17
- Truck Wash Brush U-17

C

Chain Parts

- Chain Repair Tools U-10
- Offset Links U-10
- Slip Fit Connecting Links U-10

H

Hardware

- Clevis Grab Hooks U-8, U-9
- Cold Shuts U-7
- Machinery Hoist Eyes U-5
- Quick Links U-7
- Screw Pin Shackles U-9
- Spring Links U-7
- Turned Eye Bolts U-5
- Wire Rope U-6
- Wire Rope Clips U-9
- Wire Rope Sleeves U-7
- Wire Rope Thimbles U-7

P

Polyurethane Rope & Straps U-2, U-14, U-15, U-16

- Poly Strap with Hooks U-2
- Poly Synch Chord with Nylon Hooks U-2
- Polyurethane Bungee Balls U-3
- Polyurethane Rope & Nylon Hook Ends U-2, U-3
- Polyurethane Straps Variety Pack U-3

R

Ratchets

- Ratcheting Retractable Tie Downs U-4
- Ratcheting Tie Downs U-4
- Rope Ratchet U-4

S

Springs

- Compression U-12
- Extension U-13
- General Information U-11

T

Tarp Cords

- Molded Tie-Down Straps U-3
- Tarp Card & Hooks U-3

Tools

- Cable Cutting Tools U-6
- Swaging Tools U-6

W

Web Slings

- Polyester Lifting Straps U-14, U-15, U-16
- Polyester Round Slings U-16

Wire Rope

- 7X7 Wire Rope Vinyl Coated U-6
- 7X19 Wire Rope U-6
- 7X19 Wire Rope Vinyl Coated U-6
- General Information U-6



Polyurethane Rope & Straps

An improvement on the old rubber straps and standard bungee cord — a new high tech material made of polyurethane. It's a new, stronger material with the advantage of molded on nylon ends. These polyurethane ropes and straps are lightweight and strong, and the molded on nylon ends have superior construction with break ratings that exceed 180 lbs.

- **Industrial grade polyurethane rope** (no cloth or elastic) will not break, rot, or become brittle like rubber or cloth and maintains its stretch even under extreme conditions for a safer and longer lasting cord — saving time and money.
- **Polyurethane has a long, safe stretch of 2 times its length** for a superior reach and hold for all tie down and strapping needs — requiring fewer lengths — reducing inventory and storage of a variety of strap lengths.
- **Polyurethane has a better performance under extreme weather conditions** such as UV, hot and cold temp variations, water, ozone than rubber and cloth — even performs when exposed to diesel fuel, oil and most household chemicals — making this a superior cord for all areas, — saving time and money.
- **Quick attach hooks make customizing any size tie downs, cargo nets, or cord extremely fast and convenient** — saving time, money and the struggle to find the right cord length
- Fixed strap lengths are made with **fiberglass-filled nylon hooks that are overmolded into cord** for superior performance and durability with the same 2 times stretch and a break rating on hook of 180 lbs for maximum safety — keeping workers safe from snap back and injury.
- **Molded on nylon end hooks won't mar or scratch like metal hooks** — providing a strap that is safer to use on all materials, keeping vehicles and other areas where straps are used safe from damage.
- **The Synch™ Cord has a loop on one end and an over-molded super strong non-marring end on the other** — it can make an anchor point easily by wrapping the cord around a bar or through a hole; then put the hook through the loop, pull tight then secure the hook end — for a convenient and fast strap where two hooks just won't work.
- **Made in the USA, they won't break, crack or become brittle** — they retain their color, always remain stretchy, stretching up to twice their original length!

H
A
R
D
W
A
R
E
&
S
P
R
I
N
G
S

Polyurethane Rope & Nylon Hook Ends



IBS No.	Description	Qty
24006	5/16 x 50 ft. HD Poly Rope - Black	1
24007	5/16 Nylon Hook End for Rope (10 pk)	1

Poly Strap with Hooks Poly Synch Cord WITH NYLON HOOKS

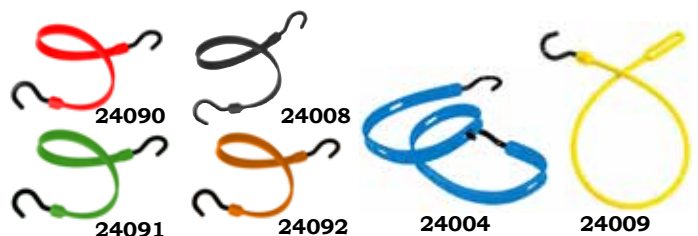

IBS No.	Description	Qty
24090	12" Poly Strap w/Hooks - Red	1
24091	18" Poly Strap w/Hooks - Green	1
24008	24" Poly Strap w/Hooks - Black	1
24004	36" Poly Slotted Strap w/Hooks - Blue	1
24092	36" Poly Strap w/Hooks - Orange	1
24009	30" Poly Synch Cord w/Molded Nylon Hook - Yellow	1



Polyurethane Straps

VARIETY PACK
IBS No. 588P



24090 24091 24092 24008 24004

IBS No.	Contains 1 of Each Strap	Qty
24090	12" Poly Strap w/Hooks - Red	2
24091	18" Poly Strap w/Hooks - Green	2
24008	24" Poly Strap w/Hooks - Black	2
24004	36" Poly Slotted Strap w/Hooks - Blue	1
24092	36" Poly Strap w/Hooks - Orange	2

Tarp Cord & Hooks



The 7/16" tarp cord with attachable hooks is ideal for use with canvas, tarpaulins, covers and lids on RV's, boats, cars trucks, trailers and motorcycles. It comes in a 125 ft. roll that can be cut to length for any use. The hooks can be attached easily and quickly. It's perfect for holding extra gear on trucks and trailers, or for holding down tarps and canvas covers. It's made of the highest quality Neoprene so it won't rot, peel or crack under normal usage—even in demanding outdoor conditions.

IBS No.	Description	Qty
32071601	7/16 dia. Neoprene Cord 125'	1
320#710	Galvanized Double Eye Hooks	25

To Apply Fastener Hooks To Tarp Cord

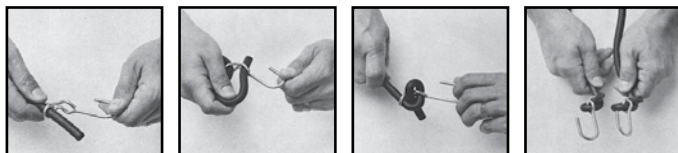

Insert cord through eye of hook. Return through second position of eye, to form a loop. Pull end through loop, forming a knot. Same procedure at other end provides a tie-down strap that has many uses.

Tarp Cord Stretchability

Cut Length	Stretches To
12"	18"
24"	40"
36"	60"

Tarp Cords

MOLDED TIE-DOWN STRAPS
Heavy-Duty Rubber Hold-Down Straps
With "S" Hooks



- Heavy duty EPDM lasts longer than rubber with excellent UV properties to resist cracking and extend strap life.
- Strong stretch and recovery performance with both hot and cold temperatures.
- 1/2" thick, teardrop ends to help prevent hooks from tearing through the strap.
- Zinc plated, rust-resistant steel S-hooks.
- Made in the USA.

IBS No.	Length	Box	Pkg
SH9	10"	50	ea.
SH15	15"	50	ea.
SH20	21"	50	ea.
SH30	31"	50	ea.
SHH	S-Hook Replacement	10	ea.

Polyurethane Bungee Balls

- Bungee balls are made with polyurethane that **resists breaking, rotting, cracking, and becoming brittle**; it maintains reliable elasticity even in extreme conditions for long-term durability and safety.
- **Designed to outperform rubber and cloth**, polyurethane withstands UV exposure, extreme heat and cold, water, ozone, diesel fuel, oil, and most household chemicals, making it dependable for both indoor and outdoor applications.
- **Proudly Made in the USA**, these bungee balls **retain their color and stretch over time**, delivering consistent performance without failure.

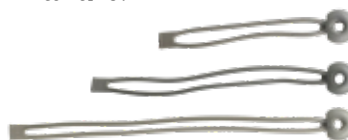

IBS No.	Length	Qty
24096	6"	4
24097	9"	4
24098	12"	4

Polyurethane Bungee Ball

BUNDLE PACK
IBS No. 863P



4 of each size (6", 9" & 12"). A total of 12 high quality bungee balls.

H
A
R
D
W
A
R
E
&
S
P
R
I
N
G
S



IBS, INCORPORATED

Tie Down Straps U01

H
A
R
D
W
A
R
E
&
S
P
R
I
N
G
S

Ratcheting Retractable Tie Downs



Retractable ratcheting utility tie down straps features a retractable ratcheting system that keeps the webbing secure, contained and efficiently stored and protected on the spindle. Durable, fully sized S-hooks with safety clips efficiently and securely holds cargo in place.

- **Self-contained bolt-on style assembly** stores webbing on a built-in spindle.
- **Multi-position** lever release design.
- 1" polyester webbing.
- **Full size coated S-hooks** with safety clips.
- **Special gear spring design** restricts accelerated retraction.

IBS No.	Description	Qty
24095	15' X 1" 2 Pack Retractable Ratchet Tie Downs	1

Ratcheting Tie Downs

- Molded grip ratchet handle for easy and convenient use.
- Extra strong, heat treated steel, compact vinyl-coated S-hooks prevent scratching.
- Fully adjustable to 15' fits most tie downs.
- Locks secure for dependability.
- Working load limit: 500 lbs.
- Breaking strength: 1500 lbs.



IBS No.	Description	Qty
24005	1" x 15' 4 Pack Ratchet Tied Downs	1

Rope Ratchet

With the Rope Ratchet you simply attach the two hooks and pull the loose end of the rope for a secure, tight hold. Rope Ratchets stay tight, locking in place as you pull the free end. To loosen you just pull the rope to reduce tension and push the handy thumb release. It's that easy!



IBS No.	Description	Load Rating	Qty
24000	1/4" x 8'	150LB Max.	1
24001	3/8" x 15'	250LB Max.	1
24002	1/2" x 15'	500LB Max.	1



Machinery Hoist Eyes

SHOULDER PATTERN EYEBOLTS

Made from drop forged steel. Heat treated after forging.

Maximum load rating for eyebolts are based on a straight vertical lift in a gradually increasing manner. Angular lifts will significantly lower loads and should be avoided whenever possible. If an angular lift is required, a properly seated Machinery Hoist Eye should be used and the lifting angle must not be more than a 45° pull. Refer to the chart below for the maximum load ratings for straight and 45° pulls.

MACHINERY HOIST EYES

IBS No.	Shank		Eye		Max Load (lbs.)		Pkg Qty
	Size	Length	ID	OD	Strt Pull	45° Pull	
20000	1/4-20	1	3/4	1-1/4	500	125	5
20001	5/16-18	1-1/8	7/8	1-1/2	900	225	5
20002	3/8-16	1-1/4	1	1-21/32	1400	350	5
20003	7/16-14	1-3/8	1-3/32	1-27/32	2000	500	3
20004	1/2-13	1-1/2	1-3/16	2-1/8	2600	650	2
20005	9/16-12	1-5/8	1-9/32	2-9/32	3000	750	2
20006	5/8-11	1-3/4	1-3/8	2-1/2	4000	1000	2
20007	3/4-10	2	1-1/2	2-13/16	6000	1500	2
20008	7/8-9	2-1/4	1-11/16	3-1/4	7000	1750	2
20009	1-8	2-1/2	1-13/16	3-9/16	9000	2250	2

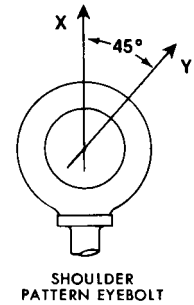

Turned Eye Bolts

Turned Eyebolts are manufactured from low carbon cold drawn steel wire, threaded and supplied with a nut.

TURNUED EYEBOLTS

IBS No.	Dimensions in inches					MAX Load (Lbs)	Pkg Qty
	A	B	C	D	T		
22024	10-24	2	3/8	2-11/16	1	38	20
02539	10-24	3	3/8	3-11/16	1-1/2	38	20
22025	1/4-20	2	1/2	3	1-1/4	74	20
22027	1/4-20	3	1/2	4	1-1/2	74	20
22028	1/4-20	5	1/2	6	3	74	20
22029	5/16-18	3	5/8	4-1/8	1-1/2	96	20
22030	5/16-18	4	5/8	5-1/8	2-1/2	96	20
02549	5/16-18	5	5/8	6-1/8	3	96	20
02550	5/16-18	6	5/8	7-1/8	4	96	20
02552	3/8-16	3	3/4	4-1/2	1-1/2	144	20
02553	3/8-16	4	3/4	5-1/2	2-1/2	144	20
02554	3/8-16	5	3/4	6-1/2	3	144	20
22032	3/8-16	6	3/4	7-1/2	4	144	20

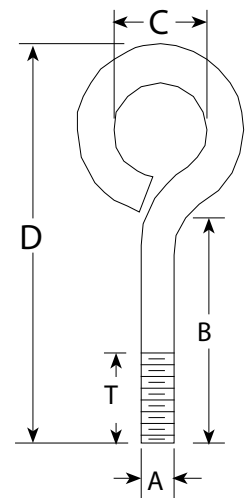
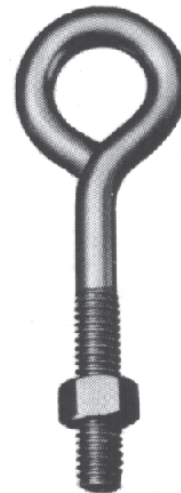



IBS, INCORPORATED

Eyebolts, Chain & Wire Hardware U02

Vinyl Coated, Galvanized Wire Rope

- High strength, quality flexible construction.
- All cable is made according to federal specification RR-W-410E.
- NOTE: Small diameter 7x7 and 7x19 wire rope (also referred to as Aircraft Cable) is not intended for aircraft use because it does not test according MIL-W-83420 request.
- Caution: Actual working loads may vary, but should never exceed 20% of nominal breaking strength.
- Working load limit is based on a design factor of 5:1.

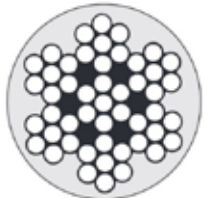

7X7 Wire Rope
Vinyl Coated



7X19 Wire Rope
Vinyl Coated



7X19 Wire Rope

IBS No.	Size (inches)	Description	Working Load Limit LBS	Spool Length	Pkg Qty
22052	1/16 X 1/8*	7X7 Wire Rope Vinyl Coated	96	100	1
22053	3/32 X 3/16*		84	100	1
22058	1/8 X 3/16*	7X19 Wire Rope Vinyl Coated	400	100	1
22061	3/16	7X19 Wire Rope	840	100	1
22062	1/4		1400		1
22063	5/16		1960		1
22064	3/8		2880		1

* Bare Cable Diameter X Coated Diameter

Swaging Tools (T03)

- Heat-treated steel jaw used for making loops and splicing cable.
- Crimps and cuts accurately.
- Used only for copper or aluminum sleeves and stops.



22090



22091

IBS No.	Size (inches)	Description	Pkg Qty
22090	1/16 - 1/8	Swager	1
22091	1/16 - 3/16	Swager	1

Cable Cutting Tools (T03)

- 22092: For wire ropes up to 1/4" diameter.
- 22092: Bolted joint for precise blade guidance; re-adjustable.
- 22092: Chrome vanadium heavy duty steel; forged oil hardened.
- 22093: For ACSR, wire ropes and steel rods copper and aluminum cables up to 3/8" diam.
- 22093: Suitable for cutting overhead cables with strain relief wire.
- 22093: Bolted head cutter, replaceable.



22092



22093

IBS No.	Size (inches)	Description	Pkg Qty
22092	1/4	Knipex Steel Cable Cutter	1
22093	3/8	Knipex Steel Cable Cutter	1

H
A
R
D
W
A
R
E
&
S
P
R
I
N
G
S

IBS, INCORPORATED

Eyebolts, Chain & Wire Hardware U02



Wire Rope Sleeves

- Used to make a solid eye in cable.
- Made of aluminum.



IBS No.	Size	Description	Pkg Qty
22070	1/16	Wire Rope Sleeve	100
22071	3/32	Wire Rope Sleeve	50
22072	1/8	Wire Rope Sleeve	50
22074	3/16	Wire Rope Sleeve	50
22075	1/4	Wire Rope Sleeve	50
22076	5/16	Wire Rope Sleeve	50
22077	3/8	Wire Rope Sleeve	50

Wire Rope Thimbles

- Used with rope clips to make a solid eye in cable or rope.
- Zinc-plated steel construction combines strength and corrosion resistance
- Warning: Not recommended for overhead lifting.



IBS No.	Size	Description	Pkg Qty
22080	1/8	Wire Rope Thimble	25
22081	3/16	Wire Rope Thimble	25
22082	1/4	Wire Rope Thimble	25
22083	5/16	Wire Rope Thimble	25
22084	3/8	Wire Rope Thimble	25

Cold Shuts

Repair links for chain

- An economical way to join chain links and attach fittings.
- To close, drive the end through the eye and flatten the end to prevent opening (can also be welded shut).



IBS No.	Description	Qty
22036	1/4" Cold Shut	5
03602	5/16" Cold Shut	5
22038	3/8" Cold Shut	5

Quick Links

- Fast easy connections for permanent or temporary applications with low carbon chain.
- Use as a repair link, connecting link, or attaching device.
- Zinc plating offers good corrosion resistance.
- Working load limit is based on a design factor of 4:1.



IBS No.	Size (inch)	Working Load Limit (LBS)	Pkg Qty
22040	1/8	130	20
22041	3/16	400	20
22042	1/4	600	20
22043	5/16	800	20
22044	3/8	1200	10
22045	1/2	4500	10

Spring Links

- Designed for use with chain repair and wire rope.
- Working load limit is based on a design factor of 3:1



IBS No.	Size	Working Load Limit (LBS)	Pkg Qty
22046	1/8	35	20
22047	3/16	70	20
22048	1/4	140	20
22049	5/16	280	20
22050	3/8	400	10
22051	1/2	500	10

H
A
R
D
W
A
R
E
&
S
P
R
I
N
G
S



IBS, INCORPORATED

Assortments Z02

Quick Links & Spring Links Assortment

IBS No.748R • 11 Items - 72 Pcs

Packaged in a locking steel drawer for easy storage and organization











H
A
R
D
W
A
R
E
&
S
P
R
I
N
G
S



IBS, Inc.

SPECIALTY PRODUCTS FOR MAINTENANCE & REPAIR
INDUSTRIALBOLT.COM 800-678-1906

Quick Links & Spring Links

Assortment No. 748R		
<p>22040 1/8 QUICK LINK ZP</p> 	<p>22041 3/16 QUICK LINK ZP</p> 	<p>22042 1/4 QUICK LINK ZP</p> 
<p>22043 5/16 QUICK LINK ZP</p> 	<p>22044 3/8 QUICK LINK ZP</p> 	<p>22045 1/2 QUICK LINK ZP</p> 
<p>22047 3/16 SPRING LINK ZP</p> 	<p>22048 1/4 SPRING LINK ZP</p> 	<p>22049 5/16 SPRING LINK ZP</p> 
<p>22050 3/8 SPRING LINK ZP</p> 	<p>22051 1/2 SPRING LINK ZP</p> 	

Eyebolts, Chain & Wire Hardware U02 Grade 70 Clevis Grab Hooks

- Made from forged carbon steel, clear zinc plated with gold chromate finish for corrosion resistance.
- Designed for Grade 70 chain use.
- Embossed with manufacturer mark, G70, and meets NACM specifications.



IBS No.	Description	Working Load Limit	Pkg
22000	1/4 G70 Clevis Grab Hook Transport ZY	3,150	2
22001	5/16 G70 Clevis Grab Hook Transport ZY	4,700	2
22002	3/8 G70 Clevis Grab Hook Transport ZY	6,600	2
22003	1/2 G70 Clevis Grab Hook Transport ZY	11,300	2

Grade 70 Clevis Grab Hooks with Latch

IBS No.	Description	Working Load Limit	Pkg
22110	1/4 G70 Clevis Grab Hook Transport ZY with Latch	3,150	2
22111	5/16 G70 Clevis Grab Hook Transport ZY with Latch	4,700	2
22112	3/8 G70 Clevis Grab Hook Transport ZY with Latch	6,600	2
22113	1/2 G70 Clevis Grab Hook Transport ZY with Latch	11,300	2



- Features a special latch to prevent chain from releasing.

IBS, INCORPORATED

Eyebolts, Chain & Wire Hardware U02



Clevis Grab Hooks

- Made for use on Hi-Test Chain. All hooks are heat treated. They can also be used on BBB & proof coil.
- High test (H.T.) stamped on every hook.
- Zinc plated for corrosion resistance.

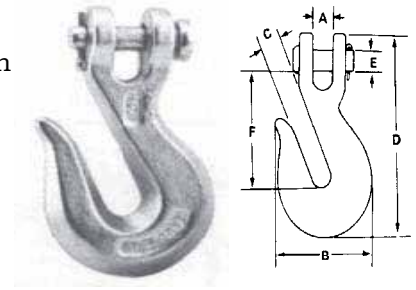

IBS No	Chain Size	A & E	B	C	D	F	Work Load (Lbs)	Pkg Qty
22010	1/4	5/16	1-5/16	3/8	3-3/8	2	2600	2
22021	5/16	3/8	2-1/4	7/16	3-15/16	2-3/8	4000	2
22022	3/8	7/16	2-11/16	1/2	4-1/2	2-11/16	5400	2

Wire Rope Clips — Zinc Plated

IBS No.	Rope Size	Dimensions in inches				Pkg Qty
		A	B	C	T	
22013	1/8	12-24	3/4	9/32	1/2	5
22014	3/16	1/4-20	15/16	5/16	5/8	5
22015	1/4	5/16-18	1-5/32	3/8	3/4	5
02702	5/16	3/8-16	1-1/2	1/2	1	5
02703	3/8	7/16-14	1-5/8	9/16	7/8	5
22016	1/2	1/2-13	1-7/8	5/8	1-1/4	5

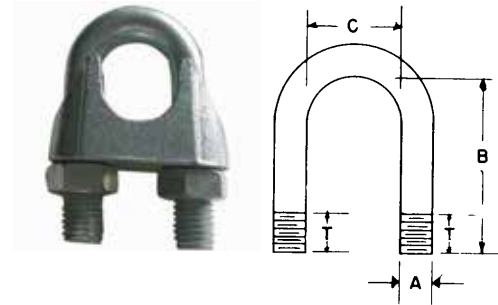

Screw Pin Shackles Forged Galvanized

Loads are based on a safety factor of 5 to 1. When tested all shackles are pulled at a uniform rate of speed in a direct tension. Any deviations as angular lifts, shock loads, modification of the basic forging, etc., will result in drastically reduced maximum loads.

IBS No.	Working Load Limit LBS.	Dimensions - Inches					Pkg Qty
		Thickness Size Dia.	Pin or Bolt Dia	Inside Length	Opening Width	Inside Width	
22017	650	3/16	1/4	3/4	3/8	19/32	2
22018	1000	1/4	5/16	1-1/8	15/32	25/32	2
22019	1500	5/16	3/8	1-1/4	17/32	27/32	2
22020	2000	3/8	7/16	1-1/2	21/32	1-1/32	2
22023	4000	1/2	5/8	2	13/16	1-5/16	1
22065	6500	5/8	3/4	2-1/2	1-1/16	1-11/16	1
22066	9500	3/4	7/8	3	1-1/4	2	1

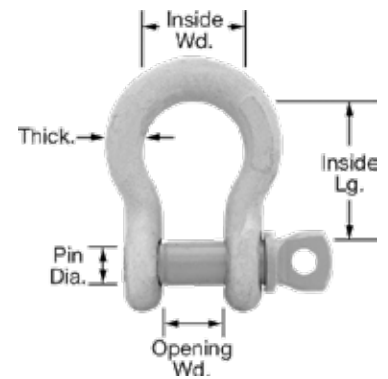

HARDWARE & SPRINGS



IBS, INCORPORATED

Eyebolts, Chain & Wire Hardware U02

H
A
R
D
W
A
R
E
&
S
P
R
I
N
G
S

Chain Parts

SLIP FIT CONNECTING LINKS



Slip-Fit Connecting Links or Rivet-Type Connecting Links are furnished with a pin link plate and a spring clip. Once the connecting link is inserted between the chain links, slide the pin link plate over ring and assemble with spring clip grooves on pins.

IBS No.	Chain No.	Description	Qty
20135	#35	.375 Pitch	10
20140	#40	.500 Pitch	10
20141	#41	.500 Pitch	10
20150	#50	.625 Pitch	10
20160	#60	.750 Pitch	10
20180	#80	1.00 Pitch	5

OFFSET LINKS



This is in reality a roll link at one end, and a pin link at the other end. An offset link is used whenever an odd number of pitches is required. The pin is removed to assemble the link into a chain.

IBS No.	Chain No.	Description	Qty
20235	#35	.375 Pitch (Half)	10
20240	#40	.500 Pitch (Half)	10
20241	#41	.500 Pitch (Half)	10
20250	#50	.625 Pitch (Half)	10
20260	#60	.750 Pitch (Half)	10
20280	#80	1.00 Pitch (Half)	5

Chain Repair Tools

#1 CHAIN BREAKER



A quality tool with forged jaws. The "push-out" pins are made of tempered alloy steel. Simplifies the disassembly of the roller chain.

Use for disassembly of single pitch chains No. 25 thru 60 (1/4, 3/8, 1/2, 5/8 & 3/4" pitch; double pitch chains 1 and 1-1/4" pitch.

IBS No.	Description	Qty
20300	#1 Chain Breaker	1

Roller Chain & Offset Chain Links

IBS No. 208P • 13 Items • 67 Pcs

Packaged in a locking steel drawer for easy storage and organization

IBS, Inc. SECURITY PRODUCTS FOR MAINTENANCE & REPAIR INDUSTRIALBOLTY.COM © © © 800-878-1906						Roller Chain Links Offset Chain Links
Assortment No. 208P						
20135 #35 .375 PITCH CONN. LINK 	20140 #40 .500 PITCH CONN. LINK 	20141 #41 .500 PITCH CONN. LINK 	20150 #50 .625 PITCH CONN. LINK 	20160 #60 .750 PITCH CONN. LINK 	20300 #1 CHAIN BREAKER 	
20180 #80 1.00 PITCH CONN. LINK 						
20235 #35 .375 PITCH OFFSET (HALF) 	20240 #40 .500 PITCH OFFSET (HALF) 	20241 #41 .500 PITCH OFFSET (HALF) 	20250 #50 .625 PITCH OFFSET (HALF) 	20260 #60 .750 PITCH OFFSET (HALF) 		
20280 #80 1.00 PITCH OFFSET (HALF) 						



General Information Compression & Extension Springs



Compression springs generally have closed ends and the number of active coils (N) are two less than the total number of coils.

Extension springs - All coils are active and the body length is the number of coils + 1 times the wire diameter. For extension type springs the rate per inch is effective only after enough load is applied to separate the close wound coils and accept the initial tension load first.

Additional Notes:

1. Compression springs should be used between 20% and 80% of travel for optimum performance.
2. Compression springs that are over-stressed will take a set prior to full travel.
3. Rates of compression springs with less than two active coils will be subject to a plus or minus 20% load tolerance.
4. Initial tension of extension springs as shown in catalog is for reference only. This factor can vary with tensile of metal.

SPRING WIRE GAUGE
American Steel & Wire Co.

Gauge	Decimal	Gauge	Decimal
4/0	.3938	16	.0625
3/0	.3625	17	.0540
2/0	.3310	18	.0475
1/0	.3065	19	.0410
1	.2830	20	.0348
2	.2625	21	.0317
3	.2437	22	.0286
4	.2253	23	.0258
5	.2070	24	.0230
6	.1920	25	.0204
7	.1770	26	.0180
8	.1620	27	.0173
9	.1483	28	.0162
10	.1350	29	.0150
11	.1205	30	.0140
12	.1055	31	.0132
13	.0915	32	.0128
14	.0800	33	.0118
15	.0720	34	.0104

Basic Formula For Round Wire Compression & Extension Springs

$$R = \frac{Gd^4}{8ND^3}$$

$$S = \frac{8DP}{\pi d^3}$$

R = Rate in Pounds per Inch of Deflection

P = Load in Pounds

D = Mean Diameter—Inches

d = Wire Diameter—Inches

G = Modulus of Elasticity—Steel = 11.5×10^6 psi

N = Number of Active Coils

S = Torsional Stress—p.s.i.



IBS, INCORPORATED

Springs U03

Compression Springs

IBS No.	O.D. (in)	Free Length (in)	Wire Dia. (in)	Mat'l	Total Coils	Solid Hgt (in)	Calc Rate (in)	Ends	Finish
47006	3/16	1	.014	A	10-1/2	.161	1.25	Closed	Zinc
47005	5/16	1-19/32	.024	B	15-1/2	.360	1.36	Cl/Grd	None
47000	5/16	10	.047	C	76-1/2	3.643	5.06	Closed	Cad.
47007	3/8	3/4	.041	D	6-3/4	.318	22.95	Closed	Zinc
47001	3/8	12	.062	D	119	7.440	5.92	Closed	Zinc
47013	7/16	2-7/8	.076	D	24	1.824	45.95	Cl/Grd	Cad.
47004	1/2	1	.072	D	8	.576	82.12	Cl/Grd	Ziinc
47012	1/2	2-1/2	.062	D	18	1.178	15.80	Closed	Zinc
47010	19/32	2-1/2	.072	D	12	.864	27.32	Cl/Grd	Zinc
47011	5/8	2-3/4	.072	C	15	1.080	17.57	Cl/Grd	Zinc
47002	5/8	12	.062	D	60	3.782	2.05	Closed	Zinc
47009	11/16	4	.105	D	23-1/4	2.441	41.71	Cl/Grd	Zinc
47015	7/8	2-1/32	.122	C	11-7/8	1.449	75.53	Cl/Grd	Gold/lr
47016	7/8	3	.091	D	12-1/2	1.138	19.48	Cl/Grd	Zinc
47003	7/8	12	.080	D	42-2/3	3.493	2.88	Closed	Zinc
47014	15/16	2-1/4	.100	C	10	1.00	30.53	Cl/Grd	Zinc
47006	1-1/64	3-1/8	.058	C	8	.522	3.09	Closed	Zinc
47017	1-1/16	3-5/8	.107	C	12	1.284	21.63	Cl/Grd	Zinc

Sold Each

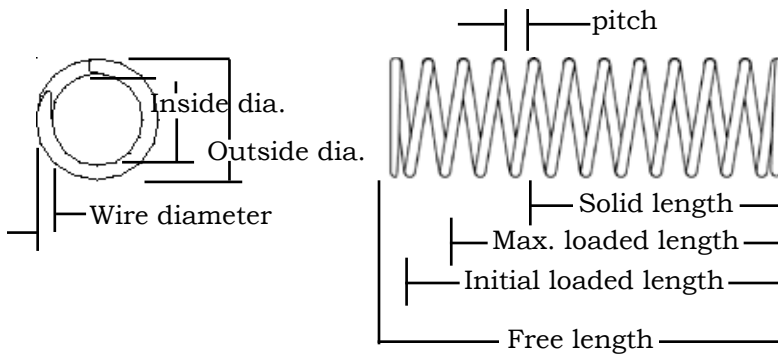

Material Code

- A = Music Wire**
- B = Stainless**
- C = Spring Steel**
- D = Hard Drawn**

HARDWARE & SPRINGS

Universal Compression Spring Asst. (Z02)

IBS No.116R • 18 Items - 54 Pcs

Packaged in a locking steel drawer for easy storage and organization

IBS, Inc. SPECIALTY PRODUCTS FOR MAINTENANCE & REPAIR INDUSTRIALBOLT.COM © © © 800-478-1906		Universal Compression Springs	
Assortment No. 116R			
47000 5/16 OD X 10 COMPRESSION*		47004 1/2 OD X 1 COMPRESSION	47005 5/16 OD X 1-19/32
47001 3/8 OD X 12 COMPRESSION*		47006 3/16 OD X 1 COMPRESSION*	47007 3/8 OD X 3/4 COMPRESSION
47002 5/8 OD X 12 COMPRESSION*		47008 1-1/64 OD X 3-1/8 COMPRESSION	
47003 7/8 OD X 12 COMPRESSION*		47009 11/16 OD X 4 COMPRESSION*	
47010 19/32 OD X 2-1/2 COMPRESSION	47011 5/8 OD X 2-3/4 COMPRESSION	47012 1/2 OD X 2-1/2 COMPRESSION	47013 7/16 OD X 2-7/8 COMPRESSION
47014 15/16 OD X 2-1/4 COMPRESSION	47015 7/8 OD X 2-1/32 COMPRESSION	47016 7/8 OD X 3 COMPRESSION SPRING*	47017 1-1/16 OD X 3-5/8 COMPRESSION



Extension Springs

IBS No.	O.D. (in)	Length Inside Hooks (in)	Wire Dia (in)	Mat'l	Initial Tension	Calculated Rate (#/in.)	Max. Deflect	Load	Finish
47037	15/64	1-1/32	.023	A	.25	1.63	1.45	2.62	Cad.
47038	1/4	4	.028	A	.49	0.65	5.92	4.33	Zinc
47041	1/4	5	.031	D	.76	0.84	4.75	4.76	Zinc
47035	19/64	13/16	.060	C	9.14	202.48	.10	28.66	Cad.
47042	21/64	5-7/8	.042	C	1.49	1.47	4.87	8.66	Zinc
47036	11/32	1-13/32	.050	C	2.86	18.80	.58	13.75	Zinc
47039	3/8	3	.041	C	.99	1.82	3.26	6.92	Zinc
47040	7/16	4-1/2	.041	C	.71	0.68	7.53	5.84	Zinc
47043	7/16	7	.062	D	4.13	3.87	4.05	19.82	Zinc
47034	1/2	1-5/8	.080	D	9.12	66.23	.41	36.40	Zinc
47030	1/2	9-5/8	.062	C	3.02	1.81	7.72	16.97	Zinc
47044	19/64	5	.075	C	4.63	5.69	3.52	24.64	Gld/Ir
47031	5/8	8-1/2	.072	D	3.45	2.14	8.00	20.60	Zinc
47046	23/32	3-3/16	.120	C	22.77	72.41	.79	79.83	Zinc
47047	47/64	3-7/8	.064	C	1.47	1.93	5.50	12.10	Blk/Ox
47048	3/4	4-1/2	.062	D	1.23	1.19	8.07	10.80	Zinc
47032	13/16	8-1/2	.072	D	1.93	0.92	14.69	15.39	Zinc
47033	1	8-1/2	.091	D	3.26	1.66	12.48	23.99	Zinc
47045	1-1/16	5-1/2	.120	D	9.18	9.51	4.36	50.68	Gld/Ir

HARDWARE & SPRINGS

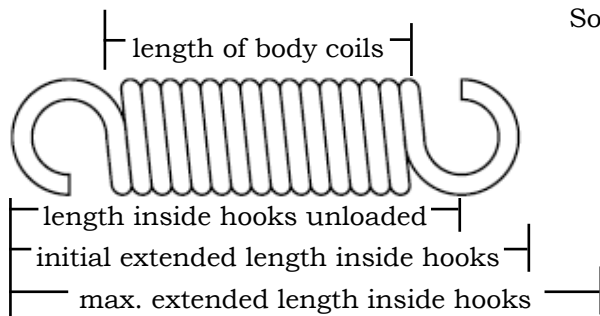

Sold Each

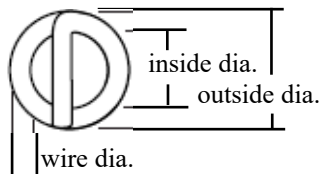

Material Code
A = Music Wire
B = Stainless
C = Spring Steel
D = Hard Drawn

Universal Extension Spring Asst. (Z02)

IBS No. 115R • 18 Items - 70 Pcs

Packaged in a locking steel drawer for easy storage and organization





IBS, INCORPORATED

Web Slings U04

Polyester Lifting Straps

Crafted from **high-quality polyester**, not nylon, our slings are moisture-resistant, ensuring consistent break strength even in outdoor conditions—making them safer for all environments. Vigorously tested to meet or exceed all ASME, OSHA & WSTDA standards, helping you avoid costly fines and penalties associated with non-compliance. Proudly **made and fabricated in the USA!**

STRUCTURE

- Our slings feature edges reinforced with **twisted tire-cord yarns**, delivering unmatched durability by reducing the risk of cuts, abrasion, and wear. This means a longer service life, saving you both time and money.
- We use **double-ply webbing construction with high-tenacity stuffers**, making our slings up to 50% stronger than competitors—giving you superior performance and greater value.
- **Dyed and impregnated with a premium blend of binders**, our webbing is built to withstand abrasion, providing a longer-lasting sling that cuts down on replacements and saves you even more.

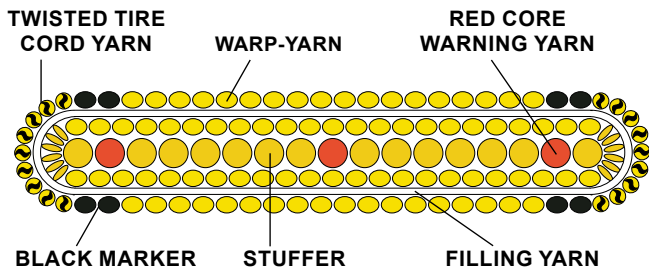

ENDLESS WEB SLING

Endless Web Slings are a continuous loop made by joining the ends of webbing with a **strong, load-bearing splice**. These slings are extremely versatile because their design allows the bearing points to rotate, which **helps avoid constant wear on the same spot, extending their lifespan**. Can be used with all three lifting methods: vertical, basket, and choker.



Endless Web Slings

IBS No.	Description	Rate Capacity (lbs.)			
		Vertical	Choker	Basket	Towing
20114	1" x 4' 1-Ply	3,200	2,500	6,400	5,333
20116	1" x 6' 1-Ply				
20226	2" x 6' 2-Ply	12,200	9,800	24,200	20,333
202210	2" x 10' 2-Ply				

DUAL-LAYER LASER PRINTED TAG

A missing or illegible tag means a sling is out of service—our slings are designed with a **dual-layer tag, laser printed for clarity, and sewn securely on all four sides** to prevent premature retirement due to damaged tags.



TWISTED BUFFER EYE WEB SLING

A Twisted Eye Web Sling features a **loop at each end, with the loops positioned at a right angle to the body of the sling**. It is suitable for all hitches but is particularly recommended for choker hitch applications.



Equipped with a **Buffer Eye**, our slings offer enhanced wear resistance where it matters most the eye. The Buffer Eye takes the brunt of the wear, preserving the integrity of the sling itself for extended life.



Twisted Buffer Eye Web Slings

IBS No.	Description	Rated Capacity (lbs.)			
		Vertical	Choker	Basket	Towing
21213	1" x 3' 2-Ply	3,200	2,560	6,400	5,333
21214	1" x 4' 2-Ply				
21216	1" x 6' 2-Ply				
21224	2" x 4' 2-Ply	6,400	5,120	12,800	20,333
21226	2" x 6' 2-Ply				
21228	2" x 8' 2-Ply				
212210	2" x 10' 2-Ply				

H
A
R
D
W
A
R
E
&
S
P
R
I
N
G
S

Polyester Lifting Straps

Removal Criteria for Flat Web Slings

The web sling shall be **removed from service if any of the following are visible:**

- Missing or illegible identification.
- Acid or caustic burns.
- Melting or charring of any part of the sling.
- Holes, tears, cuts, snags, or embedded articles.
- Broken or worn stitching in load bearing splices.
- Excessive abrasive wear.
- Knots in any part of the sling.
- Discoloration and brittle or stiff areas on any part of the sling, which may indicate chemical or ultra-violet/sunlight damage.
- Other conditions and/or visible damage that cause doubt as to the continued use of the sling.

EXAMPLES OF WEB SLINGS TO BE REMOVED FROM SERVICE:

SLING KNOT



SLING WELDING SPLATTERS



SLING CUTS



SLING ABRASION



SLING FRAY & PULLS

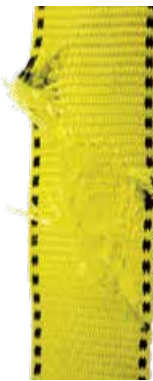

SLING ACID BURNS



✓ **COMPLIANT WITH ASME, OSHA, & WSTDA**
Vigorously tested to meet or exceed all standards, helping you avoid costly fines and penalties associated with non-compliance



✓ **QUALITY TAG**
Your Liftex® sling won't be scrapped early due to a missing or illegible tag. Quality tags are protected from smearing or ripping



✓ **EDGE PROTECTED**
Reduces frequent replacements by reducing risk of cuts, abrasion, & wear that commonly begins at the edge of slings



✓ **WSTDA DESIGN FACTOR**
Slings improperly rated at 2:1 or 3:1 less safety buffer compared to 5:1 - providing less durability and confidence against sling failure

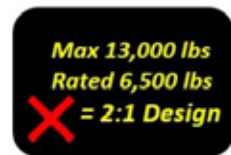

✓ **POLYESTER**
Polyester has no such UBS reduction due to Saturation, whereas Nylon UBS is reduced by 10-15%. Consult experts for use with specific chemicals



✓ **USA MADE SLING AND WEBBING**
Liftex® is vertically integrated - weaving their own webbing. Proudly Made and Fabricated in the USA to give you the highest standards of quality you can trust!





Polyester Round Slings

Crafted from **high-quality polyester**, not nylon, our slings are moisture-resistant, ensuring consistent break strength even in outdoor conditions—making them safer for all environments.

Proudly **made and fabricated in the USA!**

- **Endless Round Slings** are a **continuous loop** of 100% polyester fiber. Each Round Sling is covered with a double polyester woven jacket to protect the load bearing fibers from damage. Since the **load bearing fibers never come into contact with the load they are protected from most abrasions and ultra-violet degradation.**
- These slings are extremely versatile because their design **allows the bearing points to rotate**, which **helps avoid constant wear on the same spot, extending their lifespan.** Can be used with all three lifting methods: vertical, basket, and choker.
- A missing or illegible tag means a sling is out of service—our slings are designed with a **dual-layer tag, laser printed for clarity, and sewn securely** to prevent premature retirement due to damaged tags; less loss and spend.

- Manufactured with a double jacket that protects its load-bearing core.
- Abrasion to the protective cover will not reduce rated capacity.
- Soft & flexible, ideal for choker and basket applications.
- Capacities are color-coded.

Internal Cross-Section

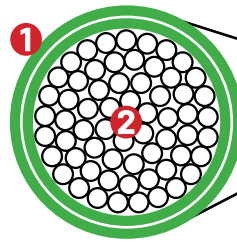

- ① Double Layer Polyester Sleeve
- ② Internal Load-Bearing Polyester Yarn

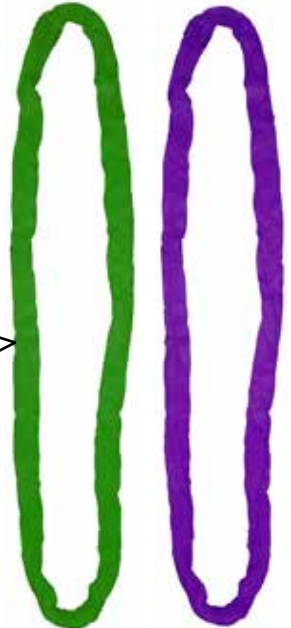

Dual-Layer Laser Printed Tag

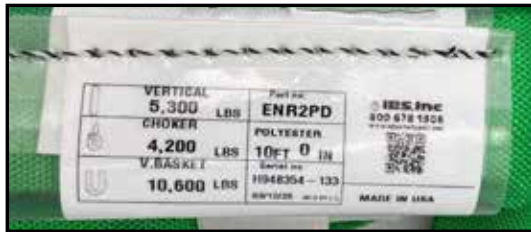

Endless Round Sling

P/N	Size	Dia	Rated Capacity (lbs.)		
			Vertical	Choker	Basket
22104	4' Purple	0.625"	2,600	2,100	5,200
22106	6' Purple	0.625"			
22206	6' Green	0.875"	5,300	4,200	10,600
22210	10' Green	0.875"			

Removal Criteria for Round Slings

The web sling shall be **removed from service if any of the following are visible:**

- Missing or illegible identification.
- Acid or caustic burns.
- Evidence of heat damage.
- Holes, tears, cuts, snags, or embedded articles.
- Broken or worn stitching in load bearing splices.
- Excessive abrasive wear.
- Knots in any part of the sling.
- Discoloration and brittle or stiff areas on any part of the sling, which may indicate chemical, heat, or ultraviolet/sunlight damage.
- Other conditions and/or visible damage that cause doubt as to the continued use of the sling.

EXAMPLES OF ROUND SLINGS TO BE REMOVED FROM SERVICE:

ROUND SLING CUTS



ROUND SLING ABRASION



ROUND SLING TEAR & PULLS



ROUND SLING KNOT



ROUND SLING WELD SPLATTERS



ROUND SLING ACID BURNS

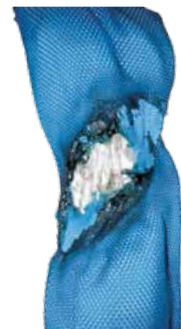

HARDWARE & SPRINGS

Maintenance Brushes P25

Miscellaneous Brushes

Floor Brushes



- Black Tampico fill
- **Medium** sweeping

FLOOR BRUSHES - MEDIUM

IBS No.	Block	Trim	Qty
42007	18"	3"	1
42008	24"	3"	1

- Black Tampico w/**middle wire row**
- **Coarse** sweeping

FLOOR BRUSHES - COARSE

IBS No.	Block	Trim	Qty
42135	24"	3"	1



- Assembles in less than 1 minute.
- Handle/sweep connector flexes on impact, providing unbelievable shock absorbency.
- No brace needed.
- Light, easy-to-manuever and easy to manage in low surface areas.

24" PRO-FLEX FLOOR BRUSH

IBS No.	Description	Qty
42000	24" Pro-Flex Floor Brush	1

Floor Squeegees

- Black Neoprene rubber blade.
- Designed for rough, heavy use.



IBS No.	Description	Qty
45510	24" Floor Squeegee	1
45511	36" Floor Squeegee	1

Use with Tapered Wood Handle IBS No. 44020

IBS Service Broom

- Moderate stiffness, large angled trim upright broom has a sturdy metal capped construction and fused polypropylene bristles for superior performance and long life.
- The large angle bristle flare design and comfortable handle allow for fast clean up of a wide variety of jobs.
- Private labeled with the IBS Logo and tagline "The Mark of Our Quality is in Our Service."



IBS No.	Description	Qty
42010	IBS Service Broom	1

Truck Wash Brush

- Fill - Flagged white polystyrene.
- Foam Block Size: 9-1/2 x 2-3/4.
- Trim: 2-1/2".
- Protective Bumper.
- Two handle holes - tapered (44020) and threaded (44301 or 44578)



IBS No.	Description	Qty
44510	Truck Wash Brush	1

Counter Duster

8" MEDIUM - WOOD HANDLE

TRIM LENGTH: 2 1/2"

Great for general factory dusting and bench cleaning. Made with grey Tampico - a natural vegetable fiber from the Mexican Century plant. Provides a medium sweeping or brushing action.



IBS No.	Description	Qty
44004	Counter Duster Brush	1



IBS, INCORPORATED

Maintenance Brushes P25

H
A
R
D
W
A
R
E
&
S
P
R
I
N
G
S

Handles & Braces

Metal handles provide a strong and durable alternative to wooden handles. Ideal for industrial and construction applications.

- Plastic Coat Finish - for a smooth & durable scratch & crack-proof coating.
- Comfort Foam Grip - reduces user fatigue & provides a comfortable grip.
- Swivel Hang Cap - Allows a broom to be easily stored, extends broom life.
- Heavy Duty Metal Tip - stronger than standard wooden thread.



Metal Handle with Comfort Grip

METAL HANDLE WITH COMFORT GRIP

IBS No.	Description	Qty
44578	5' Metal Handle Use with Floor Brushes	1

Wood handles are constructed of quality hardwood for long life. Ideal for industrial and construction applications.

PERMA-FLEX HANDLE

IBS No.	Description	Qty
44301	5' Perma-Flex Handle Use with Floor Brushes	2



TAPERED WOOD HANDLE

IBS No.	Description	Qty
44020	5' Tapered Wood Handle Use with Floor Squeegee	2



#2 HEAVY DUTY BRACE

IBS No.	Description	Qty
44290	H.D. Steel Brace Use with IBS No.42135	2



Chip and Oil Brushes

- New and improved to resist damage due to chemicals
- Multi-purpose econoline brushes
- White china bristle with wood handle



IBS No.	Width	Thickness	Bristle Length	Qty
40066	1"	5/16	1-5/8	6
40067	1-1/2"	5/16	1-5/8	6

Parts Cleaning Brush

- Stiff nylon fill
- Steel ferrule Diam. : 1"
- Chisel trim Bristle: 2 3/4"



IBS No.	Description	Qty
40035	Parts & Cleaning Brush	2

Acid Brushes

- Pure black horsehair
- Tin ferrule



IBS No.	Width	Trim	Overall	Qty
44088	5/16	3/4	5-3/4	24
44089	3/8	3/4	5-3/4	24
44090	1/2	3/4	5-3/4	24

4-in-1 Tube Fitting Brush (T03)

ONE BRUSH REPLACES FOUR!

Steel Wire. Cleans the outside and inside diameters of 1/2" and 3/4" tubes and fittings. Use for soldering prep, deburring, drill hole cleaning and cleaning battery terminals.



IBS No.	Description	Qty
44690	4-in-1 Tube Fitting Brush	1