

# IBS, INCORPORATED

## Assortments (Drawer & Bin) Z02 & Z06



### Select-O-Sort Assortments

Select-O-Sorts are specially designed assortments which are unique for each customer. In these assortments the customer decides which products best suit their needs. Our standard assortments, while designed to fit a broad spectrum of customer needs, may not always be right for each customer. For more information on Select-O-Sorts, refer to your Administration Manual SM-201.

IBS No.	UNITS	CABINET
50200	36	36B
50201	40	40B
50202	42	42B
50203	56	56B
50204	72	72B
50205	30	18D
50206	50	18D
50207	12	DL-12C
50209	16	DL-16C
50211	20	DL-20C
50212	21	DL-21C
50213	24	DL-24C
50214	32	DL-32C
50216	ADJ	AD-H, AD-L, AD-E
50218	VARIABLES	DS (SMALL DRAWER)
50219	80	2 - 40B
50225	MISC	MISC



ASSORTMENTS



**IBS, INCORPORATED**

















**Assortment Drawers Z02**

## Large Drawers



A  
S  
S  
O  
R  
T  
M  
E  
N  
T  
S



 <b>Hex Flange Bolts</b>				
Assortment No. 811R				
3198 1/4-20 FLANGE LOCK NUT GR.G PLN 	3110 1/4-20 X 3/4 GR8 HEX FLANGE BOLT PLN 	3111 1/4-20 X 1 GR8 HEX FLANGE BOLT PLN 	3112 1/4-20 X 1-1/4 GR8 HEX FLANGE BOLT PLN 	3113 1/4-20 X 1-1/2 GR8 HEX FLANGE BOLT PLN 
3199 5/16-18 FLANGE LOCK NUT GR.G PLN 	3120 5/16-18 X 3/4 GR8 HEX FLANGE BOLT PLN 	3121 5/16-18 X 1 GR8 HEX FLANGE BOLT PLN 	3122 5/16-18 X 1-1/4 GR8 HEX FLANGE BOLT PLN 	3123 5/16-18 X 1-1/2 GR8 HEX FLANGE BOLT PLN 
4000 3/8-16 FLANGE LOCK NUT GR.G PLN 	3200 3/8-16 X 1 GR8 HEX FLANGE BOLT PLN 	3201 3/8-16 X 1-1/4 GR8 HEX FLANGE BOLT PLN 	3202 3/8-16 X 1-1/2 GR8 HEX FLANGE BOLT PLN 	3204 3/8-16 X 2 GR8 HEX FLANGE BOLT PLN 



















PRODUCT CATEGORY: A

### Hex Flange Bolts

15 Items • 405 Pcs  
IBS No. 811R



Packaged in a Locking Steel Drawer  
for Easy Storage & Organization

 <b>Machine Screw Nuts, Wing Nuts &amp; Cap Nuts</b>				
Assortment No. 126R				
5076 8-32 CAP NUT ZP 	5032 4-40 HEX MACHINE SCREW NUT ZP 	5036 10-32 HEX MACHINE SCREW NUT ZP 	5086 8-32 WING NUT ZP 	5089 1/4-20 WING NUT ZP 
5077 10-24 CAP NUT ZP 	5033 6-32 HEX MACHINE SCREW NUT ZP 	5037 12-24 HEX MACHINE SCREW NUT ZP 	5087 10-24 WING NUT ZP 	5090 5/16-18 WING NUT ZP 
5079 1/4-20 CAP NUT NP 	5034 8-32 HEX MACHINE SCREW NUT ZP 	5038 1/4-20 HEX MACHINE SCREW NUT 	5088 10-32 WING NUT ZP 	5091 3/8-16 WING NUT ZP 
5080 5/16-18 CAP NUT NP 	5035 10-24 HEX MACHINE SCREW NUT ZP 	5039 5/16-18 HEX MACHINE SCREW NUT 		

PRODUCT CATEGORY: B

### Machine Screw Nuts, Wing Nuts & Cap Nuts

18 Items • 1,225 Pcs  
IBS No. 126R



Packaged in a Locking Steel Drawer  
for Easy Storage & Organization

 <b>Machine Screw Nuts &amp; Washers</b>					
Assortment No. 392R					
7100 #4 MEDIUM LOCKWASHER ZP 	7101 #6 MEDIUM LOCKWASHER ZP 	7102 #8 MEDIUM LOCKWASHER ZP 	7103 #10 MEDIUM LOCKWASHER ZP 	7104 #12 MEDIUM LOCKWASHER ZP 	7105 1/4 MEDIUM LOCKWASHER ZP 
7044 #4 SAE FLAT WASHER ZP 	7045 #6 SAE FLAT WASHER ZP 	7046 #8 SAE FLAT WASHER ZP 	7047 #10 SAE FLAT WASHER ZP 	7048 #12 SAE FLAT WASHER ZP 	7049 1/4 SAE FLAT WASHER ZP 
5032 4-40 HEX MACHINE SCREW NUT ZP 	5033 6-32 HEX MACHINE SCREW NUT ZP 	5034 8-32 HEX MACHINE SCREW NUT ZP 	5035 10-24 HEX MACHINE SCREW NUT ZP 	5036 10-32 HEX MACHINE SCREW NUT ZP 	5038 1/4-20 HEX MACHINE SCREW NUT 
5037 12-24 HEX MACHINE SCREW NUT ZP 	5001 6-32 NYLOC NUT ZP 	5002 8-32 NYLOC NUT ZP 	5003 10-24 NYLOC NUT ZP 	6099 10-32 NYLOC NUT ZP 	5004 1/4-20 NYLOC NUT ZP 

PRODUCT CATEGORY: B

### Machine Screw Nuts & Washers

24 Items • 1,250 Pcs  
IBS No. 392R



Packaged in a Locking Steel Drawer  
for Easy Storage & Organization

ASSORTMENTS



# IBS, INCORPORATED

## Assortments - Washers (C)

ASSORTMENTS

IBS, Inc. SPECIALTY PRODUCTS FOR MAINTENANCE & REPAIR INDUSTRIALBOLT.COM © © © 800-670-1506		Heavy Duty Flat Washers		
Assortment No. 117R				
7303 7/16 HVY DUTY FLAT WASHER PLN 	7307 3/4 HVY DUTY FLAT WASHER PLN 			
7302 3/8 HVY DUTY FLAT WASHER PLN 	7306 5/8 HVY DUTY FLAT WASHER PLN 			
7301 5/16 HVY DUTY FLAT WASHER PLN 	7305 9/16 HVY DUTY FLAT WASHER PLN 	7309 1 HVY DUTY FLAT WASHER PLN 		
7300 1/4 HVY DUTY FLAT WASHER PLN 	7304 1/2 HVY DUTY FLAT WASHER PLN 	7308 7/8 HVY DUTY FLAT WASHER PLN 		

PRODUCT CATEGORY: C

### Heavy Duty Flat Washers

10 Items • 330 Pcs  
IBS No. 117R



Packaged in a Locking Steel Drawer for Easy Storage & Organization

IBS, Inc. SPECIALTY PRODUCTS FOR MAINTENANCE & REPAIR INDUSTRIALBOLT.COM © © © 800-670-1506		Fender Washers		
Assortment No. 320R				
7225 3/16 X 3/4 FENDER WASHER ZP 	7232 5/16 X 1-1/2 FENDER WASHER ZP 	7245 1/4 X 1-1/8 HVY DUTY FENDER WASHER ZP 		
7227 3/16 X 1-1/4 FENDER WASHER ZP 	7234 3/8 X 1-1/2 FENDER WASHER ZP 	7246 5/16 X 1-1/4 HVY DUTY FENDER WASHER ZP 		
7229 1/4 X 1 FENDER WASHER ZP 	7235 1/2 X 2 FENDER WASHER ZP 	7247 3/8 X 2 HVY DUTY FENDER WASHER ZP 		
7230 1/4 X 1-1/4 FENDER WASHER ZP 		7248 1/2 X 2 HVY DUTY FENDER WASHER ZP 		

PRODUCT CATEGORY: C

### Fender Washers

11 Items • 650 Pcs  
IBS No. 320R



Packaged in a Locking Steel Drawer for Easy Storage & Organization

IBS, Inc. SPECIALTY PRODUCTS FOR MAINTENANCE & REPAIR INDUSTRIALBOLT.COM © © © 800-670-1506		Sur-Lock Washers	
Assortment No. 698R			
7250 1/4 & M6 SUR-LOCK WASHER PAIR 	7251 5/16 & M8 SUR-LOCK WASHER PAIR 	7252 3/8 & M10 SUR-LOCK WASHER PAIR 	7253 7/16 & M11 SUR-LOCK WASHER PR 
7254 1/2 & M12 SUR-LOCK WASHER PAIR 	7255 9/16 & M14 SUR-LOCK WASHER PR 	7256 5/8 & M16 SUR-LOCK WASHER PAIR 	7257 3/4 & M20 SUR-LOCK WASHER PAIR 
7258 7/8 & M22 SUR-LOCK WASHER PAIR 	7259 1" & M24 SUR-LOCK WASHER PAIR 		

PRODUCT CATEGORY: C

### Sur-Lock Washers

10 Items • 99 Pcs  
IBS No. 698R



Packaged in a Locking Steel Drawer for Easy Storage & Organization



 <b>Internal and External Star Washers</b>					
Assortment No. 797R					
7162 #6 STAR WASHER INTERNAL ZP	7163 #8 STAR WASHER INTERNAL ZP	7164 #10 STAR WASH INTERNAL ZP	7165 #12 STAR WASHER INTERNAL ZP	7166 1/4 STAR WASHER INTERNAL ZP	7167 5/16 STAR WASHER INTERNAL ZP
7168 3/8 STAR WASHER INTERNAL ZP	7169 7/16 STAR WASHER INTERNAL ZP	7170 1/2 STAR WASHER INTERNAL ZP	7171 9/16 STAR WASHER INTERNAL ZP	7172 5/8 STAR WASHER INTERNAL ZP	7173 3/4 STAR WASHER INTERNAL ZP
7180 #6 STAR WASHER EXTERNAL ZP	7181 #8 STAR WASHER EXTERNAL ZP	7182 #10 STAR WASHER EXTERNAL ZP	7183 #12 STAR WASHER EXTERNAL ZP	7184 1/4 STAR WASHER EXTERNAL ZP	7185 5/16 STAR WASHER EXTERNAL ZP
7186 3/8 STAR WASHER EXTERNAL ZP	7187 7/16 STAR WASHER EXTERNAL ZP	7188 1/2 STAR WASHER EXTERNAL ZP	7189 9/16 STAR WASHER EXTERNAL ZP	7190 5/8 STAR WASHER EXTERNAL ZP	7191 3/4 STAR WASHER EXTERNAL ZP

PRODUCT CATEGORY: C

### Internal & External Star Washers

24 Items • 775 Pcs

IBS No. 797R



Packaged in a Locking Steel Drawer  
for Easy Storage & Organization

ASSORTMENTS



# IBS, INCORPORATED

## Assortments - Tapping Screws & Driver Bits (E)

ASSORTMENTS

IBS, Inc. SPECIALTY PRODUCTS FOR MAINTENANCE & REPAIR INDUSTRIALBOLT.COM 800-678-1906						Phillips Pan Head Tapping Screws
Phillips Bit Chart						Assortment No. 113R
7693 6 X 3/8 PHIL PAN HD T/S ZP	7698 6 X 1" PHIL PAN HD T/S ZP	7717 8 X 1" PHIL PAN HD T/S ZP	7733 10 X 1" PHIL PAN HD T/S ZP	7748 12 X 1" PHIL PAN HD T/S ZP	7761 14 X 3/4 PHIL PAN HD T/S ZP	
7694 6 X 1/2 PHIL PAN HD T/S ZP	7713 8 X 1/2 PHIL PAN HD T/S ZP	7729 10 X 1/2 PHIL PAN HD T/S ZP	7735 10 X 1-1/2 PHIL PAN HD T/S ZP	7749 12 X 1-1/4 PHIL PAN HD T/S ZP	7763 14 X 1" PHIL PAN HD T/S ZP	
7695 6 X 5/8 PHIL PAN HD T/S ZP	7714 8 X 5/8 PHIL PAN HD T/S ZP	7730 10 X 5/8 PHIL PAN HD T/S ZP	7744 12 X 1/2 PHIL PAN HD T/S ZP	7750 12 X 1-1/2 PHIL PAN HD T/S ZP	7764 14 X 1-1/4 PHIL PAN HD T/S ZP	
7696 6 X 3/4 PHIL PAN HD T/S ZP	7715 8 X 3/4 PHIL PAN HD T/S ZP	7731 10 X 3/4 PHIL PAN HD T/S ZP	7746 12 X 3/4 PHIL PAN HD T/S ZP	7760 14 X 5/8 PHIL PAN HD T/S ZP	7765 14 X 1-1/2 PHIL PAN HD T/S ZP	

PRODUCT CATEGORY: E

### Phillips Pan Head Tapping Screws 24 Items • 1500 Pcs IBS No. 113R



Packaged in a Locking Steel Drawer for Easy Storage & Organization

IBS, Inc. SPECIALTY PRODUCTS FOR MAINTENANCE & REPAIR INDUSTRIALBOLT.COM 800-678-1906					Hex Washer Head Thread Cutting Screws Type "F"
					Assortment No. 150R
8207 8-32 X 1/2 HWH T/C TYPE F ZP	8209 8-32 X 3/4 HWH T/C TYPE F ZP	8211 8-32 x 1 HWH T/C TYPE F ZP	8214 10-24 X 1/2 HWH T/C TYPE F ZP	8215 10-24 X 5/8 HWH T/C TYPE F ZP	
Hex Size 1/4"	Hex Size 1/4"	Hex Size 1/4"	Hex Size 5/16"	Hex Size 5/16"	
8216 10-24 X 3/4 HWH T/C TYPE F ZP	8217 10-24 X 1 HWH T/C TYPE F ZP	8220 12-24 X 3/4 HWH T/C TYPE F ZP	8221 12-24 X 1 HWH T/C TYPE F ZP	8223 1/4-20 X 1/2 HWH T/C TYPE F ZP	
Hex Size 5/16"	Hex Size 5/16"	Hex Size 5/16"	Hex Size 5/16"	Hex Size 3/8"	
8225 1/4-20 X 3/4 HWH T/C TYPE F ZP	8226 1/4-20 X 1 HWH T/C TYPE F ZP	8227 1/4-20 X 1-1/4 HWH T/C TYPE F ZP	8229 5/16-18 X 3/4 HWH T/C TYPE F ZP	8230 5/16-18 X 1 HWH T/C TYPE F ZP	
Hex Size 3/8"	Hex Size 3/8"	Hex Size 3/8"	Hex Size 1/2"	Hex Size 1/2"	
8231 5/16-18 X 1-1/4 HWH T/C TYPE F ZP	8232 3/8-16 X 3/4 HWH T/C TYPE F ZP	8233 3/8-16 X 1 HWH T/C TYPE F ZP	8234 3/8-16 X 1-1/4 HWH T/C TYPE F ZP	8235 3/8-16 X 1-1/2 HWH T/C TYPE F ZP	
Hex Size 1/2"	Hex Size 9/16"	Hex Size 9/16"	Hex Size 9/16"	Hex Size 9/16"	

PRODUCT CATEGORY: E

### Hex Washer Head Thread Cutting Screws Type "F" 20 Items • 380 Pcs IBS No. 150R



Packaged in a Locking Steel Drawer for Easy Storage & Organization

IBS, Inc. SPECIALTY PRODUCTS FOR MAINTENANCE & REPAIR INDUSTRIALBOLT.COM 800-678-1906						Hex Washer Head Tapping Screws
						Assortment No. 152R
8097 6 X 1/4 SLTD HEX WASHER HD	8098 6 X 3/8 SLTD HEX WASHER HD	8099 6 X 1/2 SLTD HEX WASHER HD	8101 6 X 3/4 SLTD HEX WASHER HD	8102 6 X 1 SLTD HEX WASHER HD T/S	8160 14 X 3/4 SLTD HEX WASHER HD	
Hex Size 1/4"	Hex Size 1/4"	Hex Size 1/4"	Hex Size 1/4"	Hex Size 1/4"	Hex Size 3/8"	
8110 8 X 3/8 SLTD HEX WASHER HD	8111 8 X 1/2 SLTD HEX WASHER HD	8113 8 X 3/4 SLTD HEX WASHER HD	8114 8 X 1 SLTD HEX WASHER HD T/S	8115 8 X 1-1/4 SLTD HEX WASHER HD	8161 14 X 1 SLTD HEX WASHER HD T/S	
Hex Size 1/4"	Hex Size 1/4"	Hex Size 1/4"	Hex Size 1/4"	Hex Size 1/4"	Hex Size 3/8"	
8127 10 X 3/8 SLTD HEX WASHER HD	8128 10 X 1/2 SLTD HEX WASHER HD	8129 10 X 5/8 SLTD HEX WASHER HD	8130 10 X 3/4 SLTD HEX WASHER HD	8131 10 X 1 SLTD HEX WASHER HD T/S	8162 14 X 1-1/4 SLTD HEX WASHER HD	
Hex Size 5/16"	Hex Size 5/16"	Hex Size 5/16"	Hex Size 5/16"	Hex Size 5/16"	Hex Size 3/8"	
8133 10 X 1-1/2 SLTD HEX WASHER HD	8143 12 X 1/2 SLTD HEX WASHER HD	8145 12 X 3/4 SLTD HEX WASHER HD	8146 12 X 1 SLTD HEX WASHER HD T/S	8148 12 X 1-1/2 SLTD HEX WASHER HD	8163 14 X 1-1/2 SLTD HEX WASHER HD	
Hex Size 5/16"	Hex Size 5/16"	Hex Size 5/16"	Hex Size 5/16"	Hex Size 5/16"	Hex Size 3/8"	

PRODUCT CATEGORY: E

### Slotted Hex Washer Head Tapping Screws 24 Items • 1,325 Pcs IBS No. 152R



Packaged in a Locking Steel Drawer for Easy Storage & Organization



## Assortments - Tapping Screws & Driver Bits (E)

IBS, Inc. SPECIALTY PRODUCTS FOR MAINTENANCE & REPAIR INDUSTRIALBOLT.COM • 800-678-1996		Square Bit Chart				Assortment No. 162R	
		NOTE: ALL - IBS SQUARE DR PAN HD T/S ZP	NOTE: ALL - IBS SQUARE DR PAN HD T/S ZP	NOTE: ALL - IBS SQUARE DR PAN HD T/S ZP	NOTE: ALL - IBS SQUARE DR PAN HD T/S ZP		
7934 6 X 3/8 SQUARE DR PAN HD T/S	7938 6 X 1 SQUARE DR PAN HD T/S ZP	7950 8 X 1 SQUARE DR PAN HD T/S ZP	7965 10 X 1 SQUARE DR PAN HD T/S ZP	7980 12 X 1 SQUARE DR PAN HD T/S ZP	7994 14 X 3/4 SQUARE DR PAN HD T/S		
7935 6 X 1/2 SQUARE DR PAN HD T/S	7947 8 X 1/2 SQUARE DR PAN HD T/S	7962 10 X 1/2 SQUARE DR PAN HD T/S	7966 10 X 1-1/4 SQUARE DR PAN HD	7981 12 X 1-1/4 SQUARE DR PAN HD	7995 14 X 1 SQUARE DR PAN HD T/S ZP		
7936 6 X 5/8 SQUARE DR PAN HD T/S	7948 8 X 5/8 SQUARE DR PAN HD T/S	7963 10 X 5/8 SQUARE DR PAN HD T/S	7978 12 X 5/8 SQUARE DR PAN HD T/S	7982 12 X 1-1/2 SQUARE DR PAN HD	7996 14 X 1-1/4 SQUARE DR PAN HD		
7937 6 X 3/4 SQUARE DR PAN HD T/S	7949 8 X 3/4 SQUARE DR PAN HD T/S	7964 10 X 3/4 SQUARE DR PAN HD T/S	7979 12 X 3/4 SQUARE DR PAN HD T/S	7993 14 X 5/8 SQUARE DR PAN HD T/S	7997 14 X 1-1/2 SQUARE DR PAN HD		

### Square Drive Pan Head Tapping Screws

24 Items • 1250 Pcs  
IBS No. 162R



Packaged in a Locking Steel Drawer for Easy Storage & Organization

PRODUCT CATEGORY: E

IBS, Inc. SPECIALTY PRODUCTS FOR MAINTENANCE & REPAIR INDUSTRIALBOLT.COM • 800-678-1996		Phillips Bit Chart				Assortment No. 166R	
		NOTE: ALL - IBS PHIL FLAT HD T/S ZP	NOTE: ALL - IBS PHIL FLAT HD T/S ZP	NOTE: ALL - IBS PHIL FLAT HD T/S ZP	NOTE: ALL - IBS PHIL FLAT HD T/S ZP		
7785 6 X 3/8 PHIL FLAT HD T/S ZP	7790 6 X 1 PHIL FLAT HD T/S ZP	7807 8 X 1 PHIL FLAT HD T/S ZP	7820 10 X 3/4 PHIL FLAT HD T/S ZP	7834 12 X 3/4 PHIL FLAT HD T/S ZP	7847 14 X 3/4 PHIL FLAT HD T/S ZP		
7786 6 X 1/2 PHIL FLAT HD T/S ZP	7803 8 X 1/2 PHIL FLAT HD T/S ZP	7808 8 X 1-1/4 PHIL FLAT HD T/S ZP	7822 10 X 1 PHIL FLAT HD T/S ZP	7836 12 X 1 PHIL FLAT HD T/S ZP	7849 14 X 1 PHIL FLAT HD T/S ZP		
7787 6 X 5/8 PHIL FLAT HD T/S ZP	7804 8 X 5/8 PHIL FLAT HD T/S ZP	7818 10 X 1/2 PHIL FLAT HD T/S ZP	7823 10 X 1-1/4 PHIL FLAT HD T/S ZP	7837 12 X 1-1/4 PHIL FLAT HD T/S ZP	7850 14 X 1-1/4 PHIL FLAT HD T/S ZP		
7788 6 X 3/4 PHIL FLAT HD T/S ZP	7805 8 X 3/4 PHIL FLAT HD T/S ZP	7819 10 X 5/8 PHIL FLAT HD T/S ZP	7824 10 X 1-1/2 PHIL FLAT HD T/S ZP	7838 12 X 1-1/2 PHIL FLAT HD T/S ZP	7851 14 X 1-1/2 PHIL FLAT HD T/S ZP		

### Phillips Flat Head Tapping Screws

24 Items • 1550 Pcs  
IBS No. 166R



Packaged in a Locking Steel Drawer for Easy Storage & Organization

PRODUCT CATEGORY: E

IBS, Inc. SPECIALTY PRODUCTS FOR MAINTENANCE & REPAIR INDUSTRIALBOLT.COM • 800-678-1996		Serrated Hex Washer Head TEK/Drill Point Screws				Assortment No. 173R	
23630 8-18 X 1/2 HWH SERRATED TEK ZP HEX SIZE: 1/4"	23644 10-16 X 1/2 HWH SERRATED TEK ZP HEX SIZE: 5/16"	23654 12-14 X 5/8 HWH SERRATED TEK ZP HEX SIZE: 5/16"	23666 1/4-14 X 3/4 HWH SERRATED TEK ZP HEX SIZE: 3/8"				
23632 8-18 X 5/8 HWH SERRATED TEK ZP HEX SIZE: 1/4"	23646 10-16 X 5/8 HWH SERRATED TEK ZP HEX SIZE: 5/16"	23656 12-14 X 3/4 HWH SERRATED TEK ZP HEX SIZE: 5/16"	23668 1/4-14 X 1 HWH SERRATED TEK ZP HEX SIZE: 3/8"				
23636 8-18 X 3/4 HWH SERRATED TEK ZP HEX SIZE: 1/4"	23648 10-16 X 3/4 HWH SERRATED TEK ZP HEX SIZE: 5/16"	23658 12-14 X 1 HWH SERRATED TEK ZP HEX SIZE: 5/16"	23670 1/4-14 X 1-1/2 HWH SERRATED TEK ZP HEX SIZE: 3/8"				
23638 8-18 X 1 HWH SERRATED TEK ZP HEX SIZE: 1/4"	23650 10-16 X 1 HWH SERRATED TEK ZP HEX SIZE: 5/16"	23660 12-14 X 1-1/2 HWH SERRATED TEK ZP HEX SIZE: 5/16"	23672 1/4-14 X 2 HWH SERRATED TEK ZP HEX SIZE: 3/8"				

### Serrated HWH Tek/Drill Point Screws

16 Items • 900 Pcs  
IBS No. 173R



Packaged in a Locking Steel Drawer for Easy Storage & Organization

PRODUCT CATEGORY: E

ASSORTMENTS



# IBS, INCORPORATED

## Assortments - Tapping Screws & Driver Bits (E)

ASSORTMENTS



### Stainless Steel Phillips Pan Head TEK Screws

<b>Phillips Bit Chart</b>	POINT A1 - FOR SCREWS AS SHOWN POINT A2 - FOR SCREWS AS SHOWN POINT A3 - FOR SCREWS AS SHOWN POINT A4 - FOR SCREWS AS SHOWN POINT A5 - FOR SCREWS AS SHOWN
This bit chart will help you match the correct bit to the proper Phillips point.	

Assortment No. 310R

12740 6 X 1/2 PHIL PAN TEK SS 	12741 6 X 3/4 PHIL PAN TEK SS 	12742 6 X 1 PHIL PAN TEK SS 	12745 8 X 1/2 PHIL PAN TEK SS 	12746 8 X 3/4 PHIL PAN TEK SS 
12747 8 X 1 PHIL PAN TEK SS 	12748 8 X 1-1/2 PHIL PAN TEK SS 	12750 10 X 1/2 PHIL PAN TEK SS 	12751 10 X 3/4 PHIL PAN TEK SS 	12752 10 X 1 PHIL PAN TEK SS 
12753 10 X 1-1/2 PHIL PAN TEK SS 	12755 12 X 3/4 PHIL PAN TEK SS 	12756 12 X 1 PHIL PAN TEK SS 	12757 12 X 1-1/4 PHIL PAN TEK SS 	12758 12 X 1-1/2 PHIL PAN TEK SS 
12760 14 X 3/4 PHIL PAN TEK SS 	12761 14 X 1 PHIL PAN TEK SS 	12762 14 X 1-1/4 PHIL PAN TEK SS 	12763 14 X 1-1/2 PHIL PAN TEK SS 	12764 14 X 2 PHIL PAN TEK SS 

PRODUCT CATEGORY: E



### Stainless Steel Hex Washer Head TEK Screws

Assortment No. 311R

12770 8 X 1/2 HWH TEK SS  Hex Size 1/4"	12771 8 X 3/4 HWH TEK SS  Hex Size 1/4"	12772 8 X 1 HWH TEK SS  Hex Size 1/4"	12830 8 X 1-1/2 HWH TEK SS  Hex Size 1/4"
12774 10 X 1/2 HWH TEK SS  Hex Size 5/16"	12775 10 X 3/4 HWH TEK SS  Hex Size 5/16"	12776 10 X 1 HWH TEK SS  Hex Size 5/16"	12778 10 X 1-1/2 HWH TEK SS  Hex Size 5/16"
12780 12 X 3/4 HWH TEK SS  Hex Size 5/16"	12781 12 X 1 HWH TEK SS  Hex Size 5/16"	12783 12 X 1-1/2 HWH TEK SS  Hex Size 5/16"	12784 12 X 2 HWH TEK SS  Hex Size 5/16"
12786 14 X 3/4 HWH TEK SS  Hex Size 3/8"	12786 14 X 1 HWH TEK SS  Hex Size 3/8"	12788 14 X 1-1/2 HWH TEK SS  Hex Size 3/8"	12789 14 X 2 HWH TEK SS  Hex Size 3/8"

PRODUCT CATEGORY: E



### Square Drive Pan Head TEK Screws

Assortment No. 312R

<b>Square Bit Chart</b>	POINT A1 - FOR SCREWS AS SHOWN POINT A2 - FOR SCREWS AS SHOWN POINT A3 - FOR SCREWS AS SHOWN POINT A4 - FOR SCREWS AS SHOWN POINT A5 - FOR SCREWS AS SHOWN
This bit chart will help you match the correct bit to the proper Square point.	

8627 8 X 1/2 SQUARE DRIVE PN TEK ZP 	8629 8 X 3/4 SQUARE DRIVE PN TEK ZP 
8630 8 X 1 SQUARE DRIVE PAN TEK ZP 	8631 8 X 1-1/4 SQUARE DRIVE PAN TEK 
8632 8 X 1-1/2 SQUARE DRIVE PAN TEK 	8633 10 X 1/2 SQUARE DRIVE PAN TEK 
8635 10 X 3/4 SQUARE DRIVE PAN TEK 	8636 10 X 1 SQUARE DRIVE PAN TEK ZP 
8637 10 X 1-1/4 SQUARE DRIVE PAN 	8638 10 X 1-1/2 SQUARE DRIVE PAN 
8640 12 X 3/4 SQUARE DRIVE PAN TEK 	8641 12 X 1 SQUARE DRIVE PAN TEK ZP 
8642 12 X 1-1/4 SQUARE DRIVE PAN 	8643 12 X 1-1/2 SQUARE DRIVE PAN 

PRODUCT CATEGORY: E

## Stainless Steel Phillips Pan Head TEK Screws 20 Items • 900 Pcs IBS No. 310R



Packaged in a Locking Steel Drawer for Easy Storage & Organization

## Stainless Steel HWH Tek Screws 16 Items • 550 Pcs IBS No. 311R



Packaged in a Locking Steel Drawer for Easy Storage & Organization

## Square Drive Pan Head Tek Screws 16 Items • 650 Pcs IBS No. 312R



Packaged in a Locking Steel Drawer for Easy Storage & Organization



<b>Insert Driver Bits</b>					
Assortment No. 641P					
MSH1/4 1/4 MAGNETIC NUT DRIVER	MSHL5/16 5/16 MAGNETIC NUT DRIVER	250-PB3 1/4 HEX PHILLIPS BITS #3	60-T20 1/4 HEX TORX 20	250R1 1/4 HEX SQ DRIVE #1	MBHL25225 1/4 X 2-1/4 MAG. DRIVER BIT
MSH5/16 5/16 MAGNETIC NUT DRIVER	MSHL3/8 3/8 MAGNETIC NUT DRIVER	250-PB11 #1 PHIL X 1-15/16 POWER BIT	60-T25 1/4 HEX TORX 25	250R2 1/4 HEX SQ DRIVE #2	133319 #2 GRABIT BIT
MSH3/8 3/8 MAGNETIC NUT DRIVER	250-PB1 1/4 HEX PHILLIPS BITS #1	250-PB12 #2 PHIL X 1-15/16 POWER BIT	60-T30 1/4 HEX TORX 30	250R3 1/4 HEX SQ DRIVE #3	133320 #3 GRABIT BIT
MSHL1/4 1/4 MAGNETIC NUT DRIVER	250-PB2 1/4 HEX PHILLIPS BIT #2	250-PB13 #3 PHIL X 1-15/16 POWER BIT	60-T40 1/4 HEX TORX 40	SSA-S 1/4 HEX-1/4 SQ DR 2-9/16" EXT	140341 COMBO QUICK CHANGE BIT HOLDER

PRODUCT CATEGORY: E

### Insert Driver Bits

24 Items • 53 Pcs  
IBS No. 641P



Packaged in a Locking Steel Drawer for Easy Storage & Organization

<b>Hex Washer Head Tek Screws</b>				
Assortment No. 709R				
8436 8-18 X 1/2 HEX WASHER HD TEK ZP	8438 8-18 X 3/4 HEX WASHER HD TEK ZP	8439 8-18 X 1 HEX WASHER HD TEK ZP	84390 8-18 X 1-1/4 HEX WASHER HD TEK ZP	84392 8-18 X 1-1/2 HEX WASHER HD TEK ZP
Hex Size: 1/4"	Hex Size: 1/4"	Hex Size: 1/4"	Hex Size: 1/4"	Hex Size: 1/4"
8440 10-16 X 1/2 HEX WASHER HD TEK ZP	8442 10-16 X 3/4 HEX WASHER HD TEK ZP	8443 10-16 X 1 HEX WASHER HD TEK ZP	84431 10-16 X 1-1/4 HEX WASHER HD TEK ZP	8445 10-16 X 1-1/2 HEX WASHER HD TEK ZP
Hex Size: 5/16"	Hex Size: 5/16"	Hex Size: 5/16"	Hex Size: 5/16"	Hex Size: 5/16"
8449 12-14 X 3/4 HEX WASHER HD TEK ZP	8450 12-14 X 1 HEX WASHER HD TEK ZP	84501 12-14 X 1-1/4 HEX WASHER HD TEK ZP	8451 12-14 X 1-1/2 HEX WASHER HD TEK ZP	84511 12-14 X 2 HEX WASHER HD TEK ZP
Hex Size: 5/16"	Hex Size: 5/16"	Hex Size: 5/16"	Hex Size: 5/16"	Hex Size: 5/16"
8452 1/4-14 X 3/4 HEX WASHER HD TEK ZP	8453 1/4-14 X 1 HEX WASHER HD TEK ZP	84531 1/4-14 X 1-1/4 HWH TEK ZP	8454 1/4-14 X 1-1/2 HEX WASHER HD TEK ZP	8455 1/4-14 X 2 HEX WASHER HD TEK ZP
Hex Size: 3/8"	Hex Size: 3/8"	Hex Size: 3/8"	Hex Size: 3/8"	Hex Size: 3/8"

PRODUCT CATEGORY: E

### Hex Washer Head Tek Screws

20 Items • 1,075 Pcs  
IBS No. 709R



Packaged in a Locking Steel Drawer for Easy Storage & Organization

<b>Power Bits</b>		
Assortment No. 712R		
133319 #2 GRABIT BIT	250SSP63 1/4 X 3 #6-8 SLOT POWER BIT	250SSP66 1/4x6 #6-8 SLOT POWER BIT
140341 COMBO QUICK CHANGE BIT HOLDER	250SSP83 1/4 X 3 #8-10 SLOT POWER BIT	250SSP106 1/4 X 6 #10-12 SLOT POWER BIT
250-PB11 #1 PHIL X 1-15/16 POWER BIT	250-PB31 #1 PHIL X 3-1/2 POWER BIT	250-PB61 #1 X 6 PHILLIPS POWER DRIVER
250-PB12 #2 PHIL X 1-15/16 POWER BIT	250-PB32 #2 PHIL X 3-1/2 POWER BIT	250-PB62 #2 X 6 PHILLIPS POWER DRIVER
250-PB13 #3 PHIL X 1-15/16 POWER BIT	250-PB33 #3 PHIL X 3-1/2 POWER BIT	250-PB63 #3 X 6 PHILLIPS POWER DRIVER
MBHL25225 1/4 X 2-1/4 MAG. DRIVER BIT	MBHL2530 1/4 X 3 MAG DRIVER BIT HOLDER	MBHL2560 1/4 X 6 MAG DRIVER BIT HOLDER

PRODUCT CATEGORY: E

### Power Bits

17 Items • 31 Pcs  
IBS No. 712R



Packaged in a Locking Steel Drawer for Easy Storage & Organization

ASSORTMENTS



# IBS, INCORPORATED

## Assortments - Tapping Screws & Driver Bits (E)

ASSORTMENTS

**IBS, Inc.**  
SPECIALTY PRODUCTS FOR MAINTENANCE & REPAIR  
INDUSTRIALBOLT.COM © & © 800-878-1506

**Phillips Pan and Oval Head Tapping Screws - Black Oxide**

Phillips Bit Chart  
This chart will help you match the correct size for your application.

Assortment 767R

A-16889 6 X 3/8 PHIL PAN HD T/S B/O	A-11917 6 X 1/2 PHIL PAN HD T/S B/O	A-11918 6 X 3/4 PHIL PAN HD T/S B/O	A-11919 6 X 1 PHIL PAN HD T/S B/O	A-10180 8 X 1/2 PHIL PAN HD T/S B/O	A-10181 8 X 3/4 PHIL PAN HD T/S B/O
A-10182 8 X 1 PHIL PAN HD T/S B/O	A-10183 8 X 1-1/4 PHIL PAN HD T/S B/O	A-12799 8 X 1-1/2 PHIL PAN HD T/S B/O	A-11921 10 X 1/2 PHIL PAN HD T/S B/O	A-11922 10 X 3/4 PHIL PAN HD T/S B/O	A-11923 10 X 1 PHIL PAN HD T/S B/O
A-11924 10 X 1-1/4 PHIL PAN HD T/S B/O	A-12800 10 X 1-1/2 PHIL PAN HD T/S B/O	A-12795 6 X 1/2 PHIL OVAL HD T/S B/O	A-12796 6 X 3/4 PHIL OVAL HD T/S B/O	A-12797 6 X 1 PHIL OVAL HD T/S B/O	A-10163 8 X 1/2 PHIL OVAL HD T/S B/O
A-10165 8 X 3/4 PHIL OVAL HD T/S B/O	A-10167 8 X 1 PHIL OVAL HD T/S B/O	A-10169 8 X 1-1/4 PHIL OVAL HD T/S B/O	A-11084 10 X 1/2 PHIL OVAL HD T/S B/O	A-11086 10 X 3/4 PHIL OVAL HD T/S B/O	A-11088 10 X 1 PHIL OVAL HD T/S B/O

PRODUCT CATEGORY: E

### Phillips Pan & Oval Head Tapping Screws

Black Oxide

24 Items • 1,100 Pcs

IBS No. 767R



Packaged in a Locking Steel Drawer for Easy Storage & Organization

**IBS, Inc.**  
SPECIALTY PRODUCTS FOR MAINTENANCE & REPAIR  
INDUSTRIALBOLT.COM © & © 800-878-1506

**Phillips Pan Head & K-Lath TEK Screws**

Phillips Bit Chart  
This chart will help you match the correct size for your application.

Assortment No. 778R

8427 6-20 X 1/2 PHIL PAN HD TEK ZP	8426 6-20 X 3/4 PHIL PAN HD TEK ZP	8425 6-20 X 1 PHIL PAN HD TEK ZP	8428 8-18 X 1/2 PHIL PAN HD TEK ZP	8430 8-18 X 3/4 PHIL PAN HD TEK ZP
8431 8-18 X 1 PHIL PAN HD TEK ZP	8432 8-18 X 1-1/2 PHIL PAN HD TEK ZP	8433 10-16 X 1/2 PHIL PAN HD TEK ZP	8435 10-16 X 3/4 PHIL PAN HD TEK ZP	84351 10-16 X 1 PHIL PAN HD TEK ZP
8437 10-16 X 1-1/2 PHIL PAN HD TEK ZP	12790 8 X 1/2 PHIL K-LATH TEK ZP	12791 8 X 3/4 PHIL K-LATH TEK ZP	12792 8 X 1 PHIL K-LATH TEK ZP	12793 8 X 1-1/4 PHIL K-LATH TEK ZP
12794 8 X 1-5/8 PHIL K-LATH TEK ZP	12795 8 X 2 PHIL K-LATH TEK ZP			

PRODUCT CATEGORY: E

### Phillips Pan Head & K-Lath Tek Screws

17 Items • 1,150 Pcs

IBS No. 778R



Packaged in a Locking Steel Drawer for Easy Storage & Organization

**IBS, Inc.**  
SPECIALTY PRODUCTS FOR MAINTENANCE & REPAIR  
INDUSTRIALBOLT.COM © & © 800-878-1506

**Impact Torsion Phillips and Square Bits**

Assortment No. 812R

21001 #1 PHILLIPS INSERT BIT	21004 #1 X 1-15/16 PHILLIPS POWER BIT	21007 #1 X 3-1/2 PHILLIPS POWER BIT	21010 #1 X 6 PHILLIPS POWER BIT
21002 #2 PHILLIPS INSERT BIT	21005 #2 X 1-15/16 PHILLIPS POWER BIT	21008 #2 X 3-1/2 PHILLIPS POWER BIT	21011 #2 X 6 PHILLIPS POWER BIT
21003 #3 PHILLIPS INSERT BIT	21006 #3 X 1-15/16 PHILLIPS POWER BIT	21009 #3 X 3-1/2 PHILLIPS POWER BIT	21012 #3 X 6 PHILLIPS POWER BIT
21017 #1 SQUARE INSERT BIT	21020 #1 X 1-15/16 SQUARE POWER BIT	21024 #1 X 3-1/2 SQUARE POWER BIT	21027 #1 X 6 SQUARE POWER BIT
21018 #2 SQUARE INSERT BIT	21021 #2 X 1-15/16 SQUARE POWER BIT	21025 #2 X 3-1/2 SQUARE POWER BIT	21028 #2 X 6 SQUARE POWER BIT
21019 #3 SQUARE INSERT BIT	21022 #3 X 1-15/16 SQUARE POWER BIT	21026 #3 X 3-1/2 SQUARE POWER BIT	21029 #3 X 6 SQUARE POWER BIT

PRODUCT CATEGORY: E

### Impact Phillips & Square Bits

























24 Items • 38 Pcs

IBS No. 812R



Packaged in a Locking Steel Drawer for Easy Storage & Organization



 <b>IBS, Inc.</b> <small>SPECIALTY PRODUCTS FOR MAINTENANCE &amp; REPAIR                  INDUSTRIALBOLTY.COM © © © 800-678-1908</small>		Impact Torsion Torx and Bit Holders	
Assortment No. 813R			
21031 T15 TORX INSERT BIT 	21037 T15 X 1-15/16 TORX POWER BIT 	21042 T15 X 3-1/2 TORX POWER BIT 	21047 T15 X 6 TORX POWER BIT 
21032 T20 TORX INSERT BIT 	21038 T20 X 1-15/16 TORX POWER BIT 	21043 T20 X 3-1/2 TORX POWER BIT 	21048 T20 X 6 TORX POWER BIT 
21033 T25 TORX INSERT BIT 	21039 T25 X 1-15/16 TORX POWER BIT 	21044 T25 X 3-1/2 TORX POWER BIT 	21049 T25 X 6 TORX POWER BIT 
21034 T30 TORX INSERT BIT 	21040 T30 X 1-15/16 TORX POWER BIT 	21045 T30 X 3-1/2 TORX POWER BIT 	21050 T30 X 6 TORX POWER BIT 
21035 T40 TORX INSERT BIT 	21041 T40 X 1-15/16 TORX POWER BIT 	21046 T40 X 3-1/2 TORX POWER BIT 	21051 T40 X 6 TORX POWER BIT 
21065 READY TO USE MAGNETIC BIT AND SCREW HOLDER 	21066 COMBO QUICK CHANGE BIT HOLDER 3" 	21060 1/4 X 3 MAGNETIC DRIVER BIT HOLDER 	21061 1/4 X 6 MAGNETIC DRIVER BIT HOLDER 

PRODUCT CATEGORY: E

### Impact Torsion Torx & Bit Holders

24 Items • 31 Pcs  
IBS No. 813R



Packaged in a Locking Steel Drawer  
for Easy Storage & Organization

A S S O R T M E N T S



# IBS, INCORPORATED

## Assortments - Machine Screws (G)

ASSORTMENTS

IBS, Inc.		Slotted Round Head Machine Screws				Assortment No. 105R
5033 6-32 HEX MACHINE SCREW NUT ZP	5034 8-32 HEX MACHINE SCREW NUT ZP	5036 10-32 HEX MACHINE SCREW NUT ZP	5035 10-24 HEX MACHINE SCREW NUT ZP	9089 10-24 X 1-1/4 SLTD ROUND HD	9134 12-24 X 3/4 SLTD ROUND HD M/S	
9044 6-32 X 1/2 SLTD ROUND HD M/S	9064 8-32 X 1/2 SLTD ROUND HD M/S	9108 10-32 X 1/2 SLTD ROUND HD M/S	9084 10-24 X 1/2 SLTD ROUND HD M/S	9090 10-24 X 1-1/2 SLTD ROUND HD	9136 12-24 X 1 SLTD ROUND HD M/S ZP	
9046 6-32 X 3/4 SLTD ROUND HD M/S	9066 8-32 X 3/4 SLTD ROUND HD M/S	9110 10-32 X 3/4 SLTD ROUND HD M/S	9086 10-24 X 3/4 SLTD ROUND HD M/S	5037 12-24 HEX MACHINE SCREW NUT ZP	9137 12-24 X 1-1/4 SLTD ROUND HD	
9048 6-32 X 1 SLTD ROUND HD M/S ZP	9068 8-32 X 1 SLTD ROUND HD M/S ZP	9112 10-32 X 1 SLTD ROUND HD M/S ZP	9088 10-24 X 1 SLTD ROUND HD M/S ZP	9132 12-24 X 1/2 SLTD ROUND HD M/S	9138 12-24 X 1-1/2 SLTD ROUND HD	

PRODUCT CATEGORY: G

IBS, Inc.		Phillips Pan Head Machine Screws & Nuts				Assortment No. 169R
5033 6-32 HEX MACHINE SCREW NUT ZP	5034 8-32 HEX MACHINE SCREW NUT ZP	5036 10-32 HEX MACHINE SCREW NUT ZP	5035 10-24 HEX MACHINE SCREW NUT ZP	9529 10-24 X 1-1/4 PHIL PAN HD M/S	9549 1/4-20 X 3/4 PHIL PAN HD M/S	
9509 6-32 X 1/2 PHIL PAN HD M/S ZP	9516 8-32 X 1/2 PHIL PAN HD M/S ZP	9536 10-32 X 1/2 PHIL PAN HD M/S ZP	9524 10-24 X 1/2 PHIL PAN HD M/S ZP	9530 10-24 X 1-1/2 PHIL PAN HD M/S	9551 1/4-20 X 1 PHIL PAN HD M/S ZP	
9511 6-32 X 3/4 PHIL PAN HD M/S ZP	9518 8-32 X 3/4 PHIL PAN HD M/S ZP	9538 10-32 X 3/4 PHIL PAN HD M/S ZP	9526 10-24 X 3/4 PHIL PAN HD M/S ZP	5038 1/4-20 HEX MACHINE SCREW NUT	9552 1/4-20 X 1-1/4 PHIL PAN HD	
9512 6-32 X 1 PHIL PAN HD M/S ZP	9520 8-32 X 1 PHIL PAN HD M/S ZP	9540 10-32 X 1 PHIL PAN HD M/S ZP	9528 10-24 X 1 PHIL PAN HD M/S ZP	9547 1/4-20 X 1/2 PHIL PAN HD M/S	9553 1/4-20 X 1-1/2 PHIL PAN HD	

PRODUCT CATEGORY: G

IBS, Inc.		Stainless Steel Phillips Pan Head Machine Screws with Hex Nuts				Assortment No. 194R
11002 6-32 MACHINE SCREW NUT SS	11003 8-32 MACHINE SCREW NUT SS	11005 10-32 MACHINE SCREW NUT SS	11004 10-24 MACHINE SCREW NUT SS	12196 10-24 X 1-1/4 PHIL PAN M/S SS	12220 1/4-20 X 3/4 PHIL PAN M/S SS	
12164 6-32 X 1/2 PHIL PAN M/S SS	12178 8-32 X 1/2 PHIL PAN M/S SS	12205 10-32 X 1/2 PHIL PAN M/S SS	12191 10-24 X 1/2 PHIL PAN M/S SS	12197 10-24 X 1-1/2 PHIL PAN M/S SS	12222 1/4-20 X 1 PHIL PAN M/S SS	
12166 6-32 X 3/4 PHIL PAN M/S SS	12180 8-32 X 3/4 PHIL PAN M/S SS	12207 10-32 X 3/4 PHIL PAN M/S SS	12193 10-24 X 3/4 PHIL PAN M/S SS	11007 1/4-20 MACHINE SCREW NUT SS	12223 1/4-20 X 1-1/4 PHIL PAN M/S SS	
12168 6-32 X 1 PHIL PAN M/S SS	12182 8-32 X 1 PHIL PAN M/S SS	12209 10-32 X 1 PHIL PAN M/S SS	12195 10-24 X 1 PHIL PAN M/S SS	12218 1/4-20 X 1/2 PHIL PAN M/S SS	12224 1/4-20 X 1-1/2 PHIL PAN M/S SS	

PRODUCT CATEGORY: G

### Slotted Round Head Machine Screws

24 Items • 2050 Pcs  
IBS No. 105R



Packaged in a Locking Steel Drawer for Easy Storage & Organization

### Phillips Pan Head Machine Screws & Nuts

24 Items • 1,525 Pcs  
IBS No. 169R



Packaged in a Locking Steel Drawer for Easy Storage & Organization

### Stainless Steel Phillips Flat Head Machine Screws

24 Items • 1,150 Pcs  
IBS No. 194R



Packaged in a Locking Steel Drawer for Easy Storage & Organization

# IBS, INCORPORATED

## Assortments - Machine Screws (G)



IBS, Inc. SPECIALTY PRODUCTS FOR MAINTENANCE & REPAIR INDUSTRIALBOLT.COM • 800-878-1986		Phillips Flat Head Machine Screws			
		Assortment No. 391R			
9612 6-32 X 3/8 PHIL FLAT HD M/S ZP	9622 8-32 X 3/8 PHIL FLAT HD M/S ZP	9630 10-24 X 1/2 PHIL FLAT HD M/S	9638 10-32 X 1/2 PHIL FLAT HD M/S	9647 1/4-20 X 3/4 PHIL FLAT HD M/S	
9613 6-32 X 1/2 PHIL FLAT HD M/S ZP	9623 8-32 X 1/2 PHIL FLAT HD M/S ZP	9632 10-24 X 3/4 PHIL FLAT HD M/S	9640 10-32 X 3/4 PHIL FLAT HD M/S	9649 1/4-20 X 1 PHIL FLAT HD M/S ZP	
9615 6-32 X 3/4 PHIL FLAT HD M/S ZP	9625 8-32 X 3/4 PHIL FLAT HD M/S ZP	9634 10-24 X 1 PHIL FLAT HD M/S ZP	9642 10-32 X 1 PHIL FLAT HD M/S ZP	9651 1/4-20 X 1-1/2 PHIL FLAT HD ZP	
9617 6-32 X 1 PHIL FLAT HD M/S ZP	9627 8-32 X 1 PHIL FLAT HD M/S ZP	9637 10-24 X 3/8 PHIL FLAT HD M/S	9645 1/4-20 X 1/2 PHIL FLAT HD M/S	9653 1/4-20 X 2 PHIL FLAT HD M/S ZP	

PRODUCT CATEGORY: G

**Phillips Flat Head  
Machine Screws**  
20 Items • 1675 Pcs  
IBS No. 391R



Packaged in a Locking Steel Drawer  
for Easy Storage & Organization

IBS, Inc. SPECIALTY PRODUCTS FOR MAINTENANCE & REPAIR INDUSTRIALBOLT.COM • 800-878-1986		Metric Phillips Pan Head Machine Screws Flat Washers & Nuts			
		Assortment No. 715R			
10713 M4-.7 X 10 PHIL PAN M/S ZP	10716 M4-.7 X 16 PHIL PAN M/S ZP	10718 M4-.7 X 20 PHIL PAN M/S ZP	10721 M4-.7 X 30 PHIL PAN M/S ZP	10564 M4 FLAT WASHER ZP	10599 M4-.7 FIN HEX NUT CL8 ZP
602 M5-.8 X 10 PHIL PAN M/S ZP	604 M5-.8 X 16 PHIL PAN M/S ZP	606 M5-.8 X 20 PHIL PAN M/S ZP	608 M5-.8 X 30 PHIL PAN M/S ZP	10565 M5 FLAT WASHER ZP	10600 M5-.8 FIN HEX NUT CL8 ZP
10730 M6-1.0 X 10 PHIL PAN M/S ZP	10733 M6-1.0 X 16 PHIL PAN M/S ZP	10735 M6-1.0 X 20 PHIL PAN M/S ZP	10738 M6-1.0 X 30 PHIL PAN M/S ZP	10566 M6 FLAT WASHER ZP	10601 M6-1.0 FIN HEX NUT CL8 ZP
10750 M8-1.25 X 16 PHIL PAN M/S ZP	10752 M8-1.25 X 20 PHIL PAN M/S ZP	10754 M8-1.25 X 25 PHIL PAN M/S ZP	10755 M8-1.25 X 30 PHIL PAN M/S ZP	10568 M8 FLAT WASHER ZP	10603 M8-1.25 FIN HEX HUT CL8 ZP

PRODUCT CATEGORY: G

**Metric Phillips  
Pan Head Machine  
Screws, Flat Washers  
& Nuts**

24 Items • 1,445 Pcs  
IBS No. 715R



Packaged in a Locking Steel Drawer  
for Easy Storage & Organization

ASSORTMENTS



# IBS, INCORPORATED

## Assortments - Metric Fasteners (H)

ASSORTMENTS

<b>Metric Cap Screws &amp; Nuts Class 8.8</b>					
Assortment No. 122R					
10601 M6-1.0 FIN HEX NUT C/L8 ZP	10603 M8-1.25 FIN HEX HUT C/L8 ZP	10091 M8-1.25 X 40 HEX C/S 8.8 ZP	10605 M10-1.5 FIN HEX NUT C/L8 ZP	10116 M10-1.5 X 40 HEX C/S 8.8 ZP	10606 M12-1.75 FIN HEX NUT C/L8 ZP
10047 M6-1.0 X 30 HEX C/S 8.8 ZP	10086 M8-1.25 X 25 HEX C/S 8.8 ZP	10093 M8-1.25 X 50 HEX C/S 8.8 ZP	10111 M10-1.5 X 25 HEX C/S 8.8 ZP	10118 M10-1.5 X 50 HEX C/S 8.8 ZP	10140 M12-1.75 X 40 HEX C/S 8.8 ZP
10048 M6-1.0 X 35 HEX C/S 8.8 ZP	10089 M8-1.25 X 30 HEX C/S 8.8 ZP	10095 M8-1.25 X 60 HEX C/S 8.8 ZP	10114 M10-1.5 X 30 HEX C/S 8.8 ZP	10120 M10-1.5 X 60 HEX C/S 8.8 ZP	10142 M12-1.75 X 50 HEX C/S 8.8 ZP
10049 M6-1.0 X 40 HEX C/S 8.8 ZP	10090 M8-1.25 X 35 HEX C/S 8.8 ZP	10097 M8-1.25 X 70 HEX C/S 8.8 ZP	10115 M10-1.5 X 35 HEX C/S 8.8 ZP	10122 M10-1.5 X 70 HEX C/S 8.8 ZP	10144 M12-1.75 X 60 HEX C/S 8.8 ZP

PRODUCT CATEGORY: H

**Metric 12.9 Socket Head Capscrews**  
 24 Items • 440 Pcs  
 IBS No. 122R



Packaged in a Locking Steel Drawer for Easy Storage & Organization

<b>Metric 12.9 Socket Head Capscrews</b>					
Assortment No. 266R					
816 M4 X 12 SOCKET HD C/S ALLOY	818 M4 X 16 SOCKET HD C/S ALLOY	820 M4 X 20 SOCKET HD C/S ALLOY	821 M4 X 25 SOCKET HD C/S ALLOY	822 M5 X 12 SOCKET HD C/S ALLOY	823 M5 X 16 SOCKET HD C/S ALLOY
823A M5 X 20 SOCKET HD C/S ALLOY	824 M5 X 25 SOCKET HD C/S ALLOY	824A M6 X 12 SOCKET HD C/S ALLOY	824B M6 X 16 SOCKET HD C/S ALLOY	824C M6 X 20 SOCKET HD C/S ALLOY	824D M6 X 25 SOCKET HD C/S ALLOY
825 M6 X 30 SOCKET HD C/S ALLOY	827 M6 X 40 SOCKET HD C/S ALLOY	829 M8 X 20 SOCKET HD C/S ALLOY	829A M8 X 25 SOCKET HD C/S ALLOY	830 M8 X 30 SOCKET HD C/S ALLOY	830A M8 X 35 SOCKET HD C/S ALLOY
831 M8 X 40 SOCKET HD C/S ALLOY	835 M10 X 20 SOCKET HD C/S ALLOY	835A M10 X 25 SOCKET HD C/S ALLOY	835B M10 X 30 SOCKET HD C/S ALLOY	835C M10 X 35 SOCKET HD C/S ALLOY	835D M10 X 40 SOCKET HD C/S ALLOY

PRODUCT CATEGORY: H

**Metric 12.9 Socket Head Capscrews**  
 24 Items • 475 Pcs  
 IBS No. 266R



Packaged in a Locking Steel Drawer for Easy Storage & Organization

<b>Metric 12.9 Flat Socket Head Cap Screws</b>					
Assortment No. 267R					
84345 M4 X 12 FLAT SOCKET C/S ALLOY	84346 M4 X 16 FLAT SOCKET C/S ALLOY	84347 M4 X 20 FLAT SOCKET C/S ALLOY	84348 M4 X 25 FLAT SOCKET C/S ALLOY	84360 M5 X 12 FLAT SOCKET C/S ALLOY	84361 M5 X 16 FLAT SOCKET C/S ALLOY
84362 M5 X 20 FLAT SOCKET C/S ALLOY	84363 M5 X 25 FLAT SOCKET C/S ALLOY	84370 M6 X 12 FLAT SOCKET C/S ALLOY	84371 M6 X 16 FLAT SOCKET C/S ALLOY	84372 M6 X 20 FLAT SOCKET C/S ALLOY	84373 M6 X 25 FLAT SOCKET C/S ALLOY
84374 M6 X 30 FLAT SOCKET C/S ALLOY	84375 M6 X 40 FLAT SOCKET C/S ALLOY	84381 M8 X 20 FLAT SOCKET C/S ALLOY	84382 M8 X 25 FLAT SOCKET C/S ALLOY	84383 M8 X 30 FLAT SOCKET C/S 12.9	84384 M8 X 35 FLAT SOCKET C/S 12.9
84385 M8 X 40 FLAT SOCKET C/S ALLOY	84391 M10 X 20 FLAT SOCKET C/S ALLOY	84393 M10 X 25 FLAT SOCKET C/S ALLOY	84394 M10 X 30 FLAT SOCKET C/S ALLOY	84395 M10 X 35 FLAT SOCKET C/S ALLOY	84396 M10 X 40 FLAT SOCKET C/S 12.9

PRODUCT CATEGORY: H

**Metric 12.9 Flat Socket Head Capscrews**  
 24 Items • 435 Pcs  
 IBS No. 267R



Packaged in a Locking Steel Drawer for Easy Storage & Organization

# IBS, INCORPORATED

## Assortments - Metric Fasteners (H)



<b>Stainless Steel Metric Socket Set Screws</b>					
Assortment No. 405R					
<b>96900</b> M4 X 6 SOC SET SCREW SS  Hex Key: 2mm	<b>96905</b> M5 X 6 SOC SET SCREW SS  Hex Key: 2.5mm	<b>96910</b> M6 X 8 SOC SET SCREW SS  Hex Key: 3mm	<b>96915</b> M8 X 10 SOC SET SCREW SS  Hex Key: 4mm	<b>96920</b> M10 X 12 SOC SET SCREW SS  Hex Key: 5mm	<b>96925</b> M12 X 16 SOC SET SCREW SS  Hex Key: 6mm
<b>96901</b> M4 X 8 SOC SET SCREW SS  Hex Key: 2mm	<b>96906</b> M5 X 8 SOC SET SCREW SS  Hex Key: 2.5mm	<b>96911</b> M6 X 10 SOC SET SCREW SS  Hex Key: 3mm	<b>96916</b> M8 X 12 SOC SET SCREW SS  Hex Key: 4mm	<b>96921</b> M10 X 16 SOC SET SCREW SS  Hex Key: 5mm	<b>96926</b> M12 X 20 SOC SET SCREW SS  Hex Key: 6mm
<b>96902</b> M4 X 10 SOC SET SCREW SS  Hex Key: 2mm	<b>96907</b> M5 X 10 SOC SET SCREW SS  Hex Key: 2.5mm	<b>96912</b> M6 X 12 SOC SET SCREW SS  Hex Key: 3mm	<b>96917</b> M8 X 16 SOC SET SCREW SS  Hex Key: 4mm	<b>96922</b> M10 X 20 SOC SET SCREW SS  Hex Key: 5mm	<b>96927</b> M12 X 25 SOC SET SCREW SS  Hex Key: 6mm
<b>96903</b> M4 X 12 SOC SET SCREW SS  Hex Key: 2mm	<b>96908</b> M5 X 12 SOC SET SCREW SS  Hex Key: 2.5mm	<b>96913</b> M6 X 16 SOC SET SCREW SS  Hex Key: 3mm	<b>96918</b> M8 X 20 SOC SET SCREW SS  Hex Key: 4mm	<b>96923</b> M10 X 25 SOC SET SCREW SS  Hex Key: 5mm	<b>96928</b> M12 X 30 SOC SET SCREW SS  Hex Key: 6mm

PRODUCT CATEGORY: H

<b>Metric JIS Flange Bolts</b>					
Assortment No. 779R					
<b>10850</b> M6-1.0 X 12 JIS FLANGE BOLT ZP 10.9 	<b>10851</b> M6-1.0 X 16 JIS FLANGE BOLT ZP 10.9 	<b>10852</b> M6-1.0 X 20 JIS FLANGE BOLT ZP 10.9 	<b>10856</b> M6-1.0 X 25 JIS FLANGE BOLT ZP 10.9 	<b>10853</b> M6-1.0 X 30 JIS FLANGE BOLT ZP 10.9 	<b>10854</b> M6-1.0 X 35 JIS FLANGE BOLT ZP 10.9 
<b>10855</b> M8-1.0 X 40 JIS FLANGE BOLT ZP 10.9 	<b>10860</b> M8-1.25 X 12 JIS FLANGE BOLT ZP 10.9 	<b>10861</b> M8-1.25 X 16 JIS FLANGE BOLT ZP 10.9 	<b>10862</b> M8-1.25 X 20 JIS FLANGE BOLT ZP 10.9 	<b>10863</b> M8-1.25 X 25 JIS FLANGE BOLT ZP 10.9 	<b>10864</b> M8-1.25 X 30 JIS FLANGE BOLT ZP 10.9 
<b>10865</b> M8-1.25 X 35 JIS FLANGE BOLT ZP 10.9 	<b>10866</b> M8-1.25 X 40 JIS FLANGE BOLT ZP 10.9 	<b>10870</b> M10-1.25 X 16 JIS FLANGE BOLT ZP 10.9 	<b>10871</b> M10-1.25 X 20 JIS FLANGE BOLT ZP 10.9 	<b>10872</b> M10-1.25 X 25 JIS FLANGE BOLT ZP 10.9 	<b>10873</b> M10-1.25 X 30 JIS FLANGE BOLT ZP 10.9 
<b>10874</b> M10-1.25 X 35 JIS FLANGE BOLT ZP 10.9 	<b>10875</b> M10-1.25 X 40 JIS FLANGE BOLT ZP 10.9 	<b>10877</b> M10-1.25 X 50 JIS FLANGE BOLT ZP 10.9 	<b>10845</b> M6-1.0 JIS SERR FLANGE NUT ZP 	<b>10843</b> M8-1.25 JIS SERR FLANGE NUT ZP 	<b>10844</b> M10-1.25 JIS SERR FLANGE NUT ZP 

PRODUCT CATEGORY: H

<b>Metric 10.9 Hex Flange Bolts - Zinc Plated</b>					
Assortment No. 810R					
<b>30800</b> M6-1.0 HEX FLANGE NUT CL10 ZP 	<b>30402</b> M6-1.0 X 16 HEX FLANGE BOLT 10.9 ZP 	<b>30403</b> M6-1.0 X 20 HEX FLANGE BOLT 10.9 ZP 	<b>30404</b> M6-1.0 X 25 HEX FLANGE BOLT 10.9 ZP 	<b>30405</b> M6-1.0 X 30 HEX FLANGE BOLT 10.9 ZP 	<b>30513</b> M8-1.25 X 30 HEX FLANGE BOLT 10.9 ZP 
<b>30801</b> M8-1.25 HEX FLANGE NUT CL10 ZP 	<b>30510</b> M8-1.25 X 16 HEX FLANGE BOLT 10.9 ZP 	<b>30511</b> M8-1.25 X 20 HEX FLANGE BOLT 10.9 ZP 	<b>30512</b> M8-1.25 X 25 HEX FLANGE BOLT 10.9 ZP 	<b>30513</b> M8-1.25 X 30 HEX FLANGE BOLT 10.9 ZP 	<b>30624</b> M10-1.5 X 40 HEX FLANGE BOLT 10.9 ZP 
<b>30802</b> M10-1.5 HEX FLANGE NUT CL10 ZP 	<b>30620</b> M10-1.5 X 20 HEX FLANGE BOLT 10.9 ZP 	<b>30621</b> M10-1.5 X 25 HEX FLANGE BOLT 10.9 ZP 	<b>30622</b> M10-1.5 X 30 HEX FLANGE BOLT 10.9 ZP 	<b>30624</b> M10-1.5 X 40 HEX FLANGE BOLT 10.9 ZP 	<b>30735</b> M12-1.75 X 50 HEX FLANGE BOLT 10.9 ZP 
<b>30803</b> M12-1.75 HEX FLANGE NUT CL10 ZP 	<b>30730</b> M12-1.75 X 25 HEX FLANGE BOLT 10.9 ZP 	<b>30731</b> M12-1.75 X 30 HEX FLANGE BOLT 10.9 ZP 	<b>30733</b> M12-1.75 X 40 HEX FLANGE BOLT 10.9 ZP 	<b>30735</b> M12-1.75 X 50 HEX FLANGE BOLT 10.9 ZP 	

PRODUCT CATEGORY: H

## Stainless Steel Metric Socket Set Screws

24 Items • 206 Pcs  
IBS No. 405R



Packaged in a Locking Steel Drawer for Easy Storage & Organization

## Metric JIS Flange Bolts

24 Items • 595 Pcs  
IBS No. 779R



Packaged in a Locking Steel Drawer for Easy Storage & Organization

## Metric 10.9 Hex Flange Bolts Zinc Plated

20 Items • 515 Pcs  
IBS No. 810R



Packaged in a Locking Steel Drawer for Easy Storage & Organization

ASSORTMENTS



# IBS, INCORPORATED

## Assortments - Stainless Steel Fasteners (I)

ASSORTMENTS

**IBS, Inc.**  
SPECIALTY PRODUCTS FOR MAINTENANCE & REPAIR  
INDUSTRIALBOLT.COM • 800-678-1506

**Phillips III Chart**  
This chart will help you match the correct size for Stainless Phillips pan.

**Assortment No. 171R**

12649 6 X 1/2 PHIL OVAL T/S SS	12653 6 X 1-1/4 PHIL OVAL T/S SS	12661 8 X 1 PHIL OVAL T/S SS	12669 10 X 3/4 PHIL OVAL T/S SS	12679 12 X 3/4 PHIL OVAL T/S SS	12689 14 X 3/4 PHIL OVAL T/S SS
12650 6 X 5/8 PHIL OVAL T/S SS	12658 8 X 1/2 PHIL OVAL T/S SS	12662 8 X 1-1/4 PHIL OVAL T/S SS	12670 10 X 1 PHIL OVAL T/S SS	12680 12 X 1 PHIL OVAL T/S SS	12690 14 X 1 PHIL OVAL T/S SS
12651 6 X 3/4 PHIL OVAL T/S SS	12659 8 X 5/8 PHIL OVAL T/S SS	12667 10 X 1/2 PHIL OVAL T/S SS	12671 10 X 1-1/4 PHIL OVAL T/S SS	12681 12 X 1-1/4 PHIL OVAL T/S SS	12691 14 X 1-1/4 PHIL OVAL T/S SS
12652 6 X 1 PHIL OVAL T/S SS	12660 8 X 3/4 PHIL OVAL T/S SS	12668 10 X 5/8 PHIL OVAL T/S SS	12672 10 X 1-1/2 PHIL OVAL T/S SS	12682 12 X 1-1/2 PHIL OVAL T/S SS	12692 14 X 1-1/2 PHIL OVAL T/S SS

PRODUCT CATEGORY: I

**Stainless Steel  
Phillips Oval Head  
Tapping Screws**  
24 Items • 1,050 Pcs  
IBS No. 171R



Packaged in a Locking Steel Drawer  
for Easy Storage & Organization

**IBS, Inc.**  
SPECIALTY PRODUCTS FOR MAINTENANCE & REPAIR  
INDUSTRIALBOLT.COM • 800-678-1506

**Phillips III Chart**  
This chart will help you match the correct size for Stainless Phillips pan.

**Assortment No. 195R**

12528 6 X 3/8 PHIL PAN T/S SS	12532 6 X 1 PHIL PAN T/S SS	12541 8 X 1 PHIL PAN T/S SS	12550 10 X 1 PHIL PAN T/S SS	12560 12 X 1 PHIL PAN T/S SS	12569 14 X 3/4 PHIL PAN T/S SS
12529 6 X 1/2 PHIL PAN T/S SS	12538 8 X 1/2 PHIL PAN T/S SS	12547 10 X 1/2 PHIL PAN T/S SS	12552 10 X 1-1/2 PHIL PAN T/S SS	12561 12 X 1-1/4 PHIL PAN T/S SS	12570 14 X 1 PHIL PAN T/S SS
12530 6 X 5/8 PHIL PAN T/S SS	12539 8 X 5/8 PHIL PAN T/S SS	12548 10 X 5/8 PHIL PAN T/S SS	12557 12 X 1/2 PHIL PAN T/S SS	12562 12 X 1-1/2 PHIL PAN T/S SS	12571 14 X 1-1/4 PHIL PAN T/S SS
12531 6 X 3/4 PHIL PAN T/S SS	12540 8 X 3/4 PHIL PAN T/S SS	12549 10 X 3/4 PHIL PAN T/S SS	12559 12 X 3/4 PHIL PAN T/S SS	12568 14 X 5/8 PHIL PAN T/S SS	12572 14 X 1-1/2 PHIL PAN T/S SS

PRODUCT CATEGORY: I

**Stainless Steel  
Phillips Pan Head  
Sheet Metal Screws**  
24 Items • 1,200 Pcs  
IBS No. 195R



Packaged in a Locking Steel Drawer  
for Easy Storage & Organization

**IBS, Inc.**  
SPECIALTY PRODUCTS FOR MAINTENANCE & REPAIR  
INDUSTRIALBOLT.COM • 800-678-1506

**Square Fit Chart**  
This chart will help you match the correct size for the proper square pan.

**Assortment No. 313R**

12801 6 X 1/2 SQUARE DR PAN TEK	12802 6 X 3/4 SQUARE DR PAN TEK	12803 6 X 1 SQUARE DR PAN TEK SCREW	12805 8 X 1/2 SQUARE DR PAN TEK	12807 8 X 3/4 SQUARE DR PAN TEK
12808 8 X 1 SQUARE DR PAN TEK SCREW	12810 8 X 1-1/2 SQUARE DR PAN TEK	12811 10 X 1/2 SQUARE DR PAN TEK	12813 10 X 3/4 SQUARE DR PAN TEK	12814 10 X 1 SQUARE DR PAN TEK
12816 10 X 1-1/2 SQUARE DR PAN TEK	12817 10 X 2 SQUARE DR PAN TEK	12818 12 X 3/4 SQUARE DR PAN TEK	12819 12 X 1 SQUARE DR PAN TEK	12821 12 X 1-1/2 SQUARE DR PAN TEK
12822 12 X 2 SQUARE DR PAN TEK	12823 14 X 3/4 SQUARE DR PAN TEK	12824 14 X 1 SQUARE DR PAN TEK	12826 14 X 1-1/2 SQUARE DR PAN TEK	12827 14 X 2 SQUARE DR PAN TEK

PRODUCT CATEGORY: I

**Stainless Steel  
Square Drive Pan  
Head Tek Screws**  
20 Items • 590 Pcs  
IBS No. 313R



Packaged in a Locking Steel Drawer  
for Easy Storage & Organization



## Assortments - Stainless Steel Fasteners (I)

IBS, Inc. SPECIALTY PRODUCTS FOR MAINTENANCE & REPAIR INDUSTRIALBOLTY.COM 8 8 8 800-678-1506		Stainless Steel Button Socket Security Machine Screws			
Assortment No. 388R					
12850 6-32 X 1/2 SEC BS C/S SS 1/8 DRIVE 	12851 6-32 X 3/4 SEC BS C/S SS 1/8 DRIVE 	12852 6-32 X 1 SEC BS C/S SS 1/8 DRIVE 	12853 8-32 X 1/2 SEC BS C/S SS 5/32 DRIVE 	12854 8-32 X 3/4 SEC BS C/S SS 5/32 DRIVE 	
12855 8-32 X 1 SEC BS C/S SS 5/32 DRIVE 	12857 10-24 X 1/2 SEC BS C/S SS 5/32 DRIVE 	12859 10-24 X 3/4 SEC BS C/S SS 5/32 DRIVE 	12860 10-24 X 1 SEC BS C/S SS 5/32 DRIVE 	12863 10-32 X 1/2 SEC BS C/S SS 5/32 DRIVE 	
12865 10-32 X 3/4 SEC BS C/S SS 5/32 DRIVE 	12866 10-32 X 1 SEC BS C/S SS 5/32 DRIVE 	12871 10-24 X 3/4 SEC BS C/S SS 5/32 DRIVE 	12872 1/4-20 X 1 SEC BS C/S SS 5/32 DRIVE 	12874 1/4-20 X 1-1/2 SEC BS C/S SS 5/32 DRIVE 	
12880 10-24 SECURITY BREAKAWAY NUT 	12881 1/4-20 SECURITY BREAKAWAY NUT 		12945 1/8 HEX W/PIN 1/4 HEX DRIVER 	12946 5/32 HEX W/PIN 1/4 HEX DRIVER 	

PRODUCT CATEGORY: I

### Stainless Steel Button Socket Security Machine Screws

19 Items • 232 Pcs  
IBS No. 388R



Packaged in a Locking Steel Drawer for Easy Storage & Organization

IBS, Inc. SPECIALTY PRODUCTS FOR MAINTENANCE & REPAIR INDUSTRIALBOLTY.COM 8 8 8 800-678-1506		Stainless Steel Button Socket Security Tapping Screws			
Assortment No. 389R					
12900 6 X 3/8 SEC BS C/S SS 1/8 DRIVE 	12901 6 X 1/2 SEC BS C/S SS 1/8 DRIVE 	12902 6 X 3/4 SEC BS C/S SS 1/8 DRIVE 	12903 6 X 1 SEC BS C/S SS 1/8 DRIVE 	12904 8 X 3/8 SEC BS C/S SS 5/32 DRIVE 	
12905 8 X 1/2 SEC BS C/S SS 5/32 DRIVE 	12906 8 X 3/4 SEC BS C/S SS 5/32 DRIVE 	12907 8 X 1 SEC BS C/S SS 5/32 DRIVE 	12908 8 X 1-1/4 SEC BS C/S SS 5/32 DRIVE 	12909 8 X 1-1/2 SEC BS C/S SS 5/32 DRIVE 	
12910 10 X 1/2 SEC BS C/S SS 5/32 DRIVE 	12911 10 X 3/4 SEC BS C/S SS 5/32 DRIVE 	12912 10 X 1 SEC BS C/S SS 5/32 DRIVE 	12913 10 X 1-1/4 SEC BS C/S SS 5/32 DRIVE 	12914 10 X 1-1/2 SEC BS C/S SS 5/32 DRIVE 	
12915 10 X 2 SEC BS C/S SS 5/32 DRIVE 			12945 1/8 HEX W/PIN 1/4 HEX DRIVER 	12946 5/32 HEX W/PIN 1/4 HEX DRIVER 	

PRODUCT CATEGORY: I

### Stainless Steel Button Socket Security Tapping Screws

18 Items • 162 Pcs  
IBS No. 389R



Packaged in a Locking Steel Drawer for Easy Storage & Organization

IBS, Inc. SPECIALTY PRODUCTS FOR MAINTENANCE & REPAIR INDUSTRIALBOLTY.COM 8 8 8 800-678-1506		Stainless Steel Socket Head Cap Screws			
Assortment No. 836R					
11501 6-32 X 1/2 SOCKET HD C/S SS 	11503 6-32 X 1 SOCKET HD C/S SS 	11504 8-32 X 1/2 SOCKET HD C/S SS 	11505 8-32 X 3/4 SOCKET HD C/S SS 	11506 8-32 X 1 SOCKET HD C/S SS 	11512 10-24 X 1/2 SOCKET HD C/S SS 
11513 10-24 X 3/4 SOCKET HD C/S SS 	11514 10-24 X 1 SOCKET HD C/S SS 	11520 10-32 X 1/2 SOCKET HD C/S SS 	11521 10-32 X 3/4 SOCKET HD C/S SS 	11522 10-32 X 1 SOCKET HD C/S SS 	11526 1/4-20 X 1/2 SOCKET HD C/S SS 
11528 1/4-20 X 3/4 SOCKET HD C/S SS 	11530 1/4-20 X 1 SOCKET HD C/S SS 	11532 1/4-20 X 1-1/2 SOCKET HD C/S SS 	11534 1/4-20 X 2 SOCKET HD C/S SS 	11539 5/16-18 X 3/4 SOCKET HD C/S SS 	11541 5/16-18 X 1 SOCKET HD C/S SS 
11544 5/16-18 X 1-1/2 SOCKET HD C/S SS 	11552 3/8-16 X 1 SOCKET HD C/S SS 	11553 3/8-16 X 1-1/2 SOCKET HD C/S SS 	11556 3/8-16 X 2 SOCKET HD C/S SS 		

PRODUCT CATEGORY: I

### Stainless Steel Socket Head Capscrews

24 Items • 850 Pcs  
IBS No. 836R



Packaged in a Locking Steel Drawer for Easy Storage & Organization

ASSORTMENTS



# IBS, INCORPORATED

## Assortments - Stainless Steel Fasteners (I)

ASSORTMENTS

IBS, Inc. SPECIALTY PRODUCTS FOR MAINTENANCE & REPAIR INDUSTRIALBOLTY.COM © 2010 800-678-1906		Button Socket Screw Size		Hex Size		Stainless Steel Button Socket Cap Screws	
Assortment No. 837R							
11902 6-32 X 1/2 BUTTON SOCKET C/S SS	11903 6-32X 3/4 BUTTON SOCKET C/S SS	11904 6-32 X 1 BUTTON SOCKET C/S SS	11907 8-32 X 1/2 BUTTON SOCKET C/S SS	11908 8-32 X 3/4 BUTTON SOCKET C/S SS	11909 8-32 X 1 BUTTON SOCKET C/S SS		
11912 10-24 X 1/2 BUTTON SOCKET C/S SS	11913 10-24 X 3/4 BUTTON SOCKET C/S SS	11914 10-24 X 1 BUTTON SOCKET C/S SS	11916 10-32 X 1/2 BUTTON SOCKET C/S SS	11917 10-32 X 3/4 BUTTON SOCKET C/S SS	11918 10-32 X 1 BUTTON SOCKET C/S SS		
11920 1/4-20 X 1/2 BUTTON SOCKET C/S SS	11921 1/4-20 X 3/4 BUTTON SOCKET C/S SS	11922 1/4-20 X 1 BUTTON SOCKET C/S SS	11924 1/4-20 X 1-1/2 BUTTON SOCKET C/S SS	11926 5/16-18 X 3/4 BUTTON SOCKET C/S SS	11927 5/16-18 X 1 BUTTON SOCKET C/S SS		
11928 5/16-18 X 1-1/4 BUTTON SOCKET C/S SS	11929 5/16-18 X 1-1/2 BUTTON SOCKET C/S SS	11931 3/8-16 X 3/4 BUTTON SOCKET C/S SS	11932 3/8-16 X 1 BUTTON SOCKET C/S SS	11933 3/8-16 X 1-1/4 BUTTON SOCKET C/S SS	11934 3/8-16 X 1-1/2 BUTTON SOCKET C/S SS		

PRODUCT CATEGORY: I

**Stainless Steel  
Button Socket Head  
Capcrews**  
24 Items • 1060 Pcs  
IBS No. 837R



Packaged in a Locking Steel Drawer for Easy Storage & Organization

IBS, Inc. SPECIALTY PRODUCTS FOR MAINTENANCE & REPAIR INDUSTRIALBOLTY.COM © 2010 800-678-1906		Flat Socket Screw Size		Hex Size		Stainless Steel Flat Socket Cap Screws	
Assortment No. 838R							
11952 6-32 X 1/2 FLAT SOCKET C/S SS	11953 6-32X 3/4 FLAT SOCKET C/S SS	11954 6-32 X 1 FLAT SOCKET C/S SS	11957 8-32 X 1/2 FLAT SOCKET C/S SS	11958 8-32 X 3/4 FLAT SOCKET C/S SS	11959 8-32 X 1 FLAT SOCKET C/S SS		
11962 10-24 X 1/2 FLAT SOCKET C/S SS	11963 10-24 X 3/4 FLAT SOCKET C/S SS	11964 10-24 X 1 FLAT SOCKET C/S SS	11966 10-32 X 1/2 FLAT SOCKET C/S SS	11967 10-32 X 3/4 FLAT SOCKET C/S SS	11968 10-32 X 1 FLAT SOCKET C/S SS		
11970 1/4-20 X 1/2 FLAT SOCKET C/S SS	11971 1/4-20 X 3/4 FLAT SOCKET C/S SS	11972 1/4-20 X 1 FLAT SOCKET C/S SS	11974 1/4-20 X 1-1/2 FLAT SOCKET C/S SS	11976 5/16-18 X 3/4 FLAT SOCKET C/S SS	11977 5/16-18 X 1 FLAT SOCKET C/S SS		
11978 5/16-18 X 1-1/4 FLAT SOCKET C/S SS	11979 5/16-18 X 1-1/2 FLAT SOCKET C/S SS	11981 3/8-16 X 3/4 FLAT SOCKET C/S SS	11982 3/8-16 X 1 FLAT SOCKET C/S SS	11983 3/8-16 X 1-1/4 FLAT SOCKET C/S SS	11984 3/8-16 X 1-1/2 FLAT SOCKET C/S SS		

PRODUCT CATEGORY: I

**Stainless Steel Flat  
Socket Head  
Cap screws**  
24 Items • 1080 Pcs  
IBS No. 838R



Packaged in a Locking Steel Drawer for Easy Storage & Organization

IBS, Inc. SPECIALTY PRODUCTS FOR MAINTENANCE & REPAIR INDUSTRIALBOLTY.COM © 2010 800-678-1906		Fender Washers Stainless Steel	
Assortment No. 850R			
12074 10 X 1 FENDER WASHER SS	12075 1/4 X 1 FENDER WASHER SS	12076 1/4 X 1-1/4 FENDER WASHER SS	
12077 1/4 X 1-1/2 FENDER WASHER SS	12078 1/4 X 2 FENDER WASHER SS	12079 5/16 X 1 FENDER WASHER SS	
12080 5/16 X 1-1/2 FENDER WASHER SS	12081 5/16 X 2 FENDER WASHER SS	12082 3/8 X 1-1/2 FENDER WASHER SS	
12083 3/8 X 2 FENDER WASHER SS	12084 1/2 X 2 FENDER WASHER SS		

PRODUCT CATEGORY: I

**Stainless Steel Fender  
Washers**  
11 Items • 345 Pcs  
IBS No. 850R



Packaged in a Locking Steel Drawer for Easy Storage & Organization



IBS, Inc. SPECIALTY PRODUCTS FOR MAINTENANCE & REPAIR INDUSTRIALBOLT.COM © © © 800-878-1906						Cotter Pins					
						Assortment No. 125R					
3469 1/16 X 1 COTTER PIN ZP	13471 1/16 X 1-1/2 COTTER PIN ZP	13473 1/16 X 2 COTTER PIN ZP	13481 3/32 X 1 COTTER PIN ZP	13483 3/32 X 1-1/2 COTTER PIN ZP	13577 1/4 X 3 COTTER PIN ZP						
3485 3/32 X 2 COTTER PIN ZP	13532 5/32 X 1 COTTER PIN ZP	13534 5/32 X 1-1/2 COTTER PIN ZP	13505 1/8 X 1 COTTER PIN ZP	13507 1/8 X 1-1/2 COTTER PIN ZP	13512 1/8 X 3 COTTER PIN ZP						
3509 7/8 X 2 COTTER PIN ZP	13536 5/32 X 2 COTTER PIN ZP	13539 5/32 X 3 COTTER PIN ZP	13558 3/16 X 1 COTTER PIN ZP	13560 3/16 X 1-1/2 COTTER PIN ZP	13565 3/16 X 3 COTTER PIN ZP						
3562 1/16 X 2 COTTER PIN ZP	13572 1/4 X 1-1/2 COTTER PIN ZP	13574 1/4 X 2 COTTER PIN ZP	13602 5/16 X 2 COTTER PIN ZP	13616 3/8 X 2 COTTER PIN ZP	13618 3/8 X 2-1/2 COTTER PIN ZP						

PRODUCT CATEGORY: K

### Cotter Pins

24 Items • 1,545 Pcs  
IBS No. 125R



Packaged in a Locking Steel Drawer for Easy Storage & Organization

IBS, Inc. SPECIALTY PRODUCTS FOR MAINTENANCE & REPAIR INDUSTRIALBOLT.COM © © © 800-878-1906						Clevis Pins					
						Assortment No. 132R					
13831 3/16 X 3/4 CLEVIS PIN	13832 3/16 X 1 CLEVIS PIN	13837 3/16 X 1-1/2 CLEVIS PIN	13843 1/4 X 1 CLEVIS PIN	13848 1/4 X 1-1/2 CLEVIS PIN	13911 1/4 X 2 UNIVERSAL CLEVIS PIN						
13851 5/16 X 1 CLEVIS PIN	13856 5/16 X 1-1/2 CLEVIS PIN	13859 5/16 X 2 CLEVIS PIN	13867 3/8 X 1-1/2 CLEVIS PIN	13870 3/8 X 2 CLEVIS PIN	13915 5/16 X 2 UNIV CLEVIS PIN						
13873 3/8 X 2-1/2 CLEVIS PIN	13881 7/16 X 1-1/2 CLEVIS PIN	13884 7/16 X 2 CLEVIS PIN	13892 1/2 X 1-1/2 CLEVIS PIN	13895 1/2 X 2 CLEVIS PIN	13918 3/8 X 2 UNIVERSAL CLEVIS PIN						
13898 1/2 X 2-1/2 CLEVIS PIN	13902 5/8 X 1-1/2 CLEVIS PIN	13904 5/8 X 2 CLEVIS PIN	13922 7/16 X 2-1/2 UNIV CLEVIS PIN	13928 1/2 X 3 UNIV CLEVIS PIN	13932 5/8 X 3 UNIV CLEVIS PIN						

PRODUCT CATEGORY: K

### Clevis Pins

24 Items • 129 Pcs  
IBS No. 132R



Packaged in a Locking Steel Drawer for Easy Storage & Organization

A  
S  
S  
O  
R  
T  
M  
E  
N  
T  
S



# IBS, INCORPORATED

## Assortments - Rings & Pins (K)

ASSORTMENTS

<b>Female Rod Ends, Yoke Ends, Clevis Pins, Cotter Pins &amp; Jam Nuts</b>			
Assortment No. 142R			
<b>A-12034</b> 10-32 RH F. BALL JOINT W/STUD 	<b>A-10737</b> 1/4-28 DROP FORGED-ADJ YOKE END 	<b>13843</b> 1/4 X 1 CLEVIS PIN 	<b>13480</b> 3/32 X 3/4 COTTER PIN ZP  <b>9036</b> 10-32 HEX MACHINE SCREW NUT ZP 
<b>A-12035</b> 1/4-28 RH F. BALL JOINT W/STUD 	<b>A-10738</b> 5/16-24 DROP FORG-ADJ YOKE END 	<b>13854</b> 5/16 X 1-1/4 CLEVIS PIN 	<b>13805</b> 1/8 X 1 COTTER PIN ZP  <b>6085</b> 1/4-28 HEX JAM NUT NF ZP 
<b>A-12036</b> 5/16-24 RH F. BALL JOINT 	<b>A-10739</b> 3/8-24 DROP FORGED ADJ YOKE END 	<b>13865</b> 3/8 X 1-1/4 CLEVIS PIN 	<b>13532</b> 5/32 X 1 COTTER PIN ZP  <b>6086</b> 5/16-24 HEX JAM NUT NF ZP 
<b>A-12037</b> 3/8-24 RH F. BALL JOINT W/STUD 	<b>A-10741</b> 1/2-20 DROP FORGED ADJ YOKE END 	<b>13891</b> 1/2 X 1-3/8 CLEVIS PIN 	<b>13532</b> 5/32 X 1 COTTER PIN ZP  <b>6087</b> 3/8-24 HEX JAM NUT NF ZP 

PRODUCT CATEGORY: K

**Female Rod Ends, Yoke Ends, Clevis Pins, Cotter Pins & Jam Nuts**  
 20 Items • 247 Pcs  
 IBS No. 142R



Packaged in a Locking Steel Drawer for Easy Storage & Organization

<b>Woodruff Keys</b>					
Assortment No. 148R					
<b>13951</b> #2 3/32 X 1/2 WOODRUFF KEY 	<b>13957</b> #7 1/8 X 3/4 WOODRUFF KEY 	<b>13956</b> #61 3/16 X 5/8 WOODRUFF KEY 	<b>13971</b> #16 3/16 X 1-1/8 WOODRUFF KEY 	<b>13968</b> #15 1/4 X 1 WOODRUFF KEY 	<b>13974</b> #C 5/16 X 1-1/8 WOODRUFF KEY 
<b>13953</b> #4 3/32 X 5/8 WOODRUFF KEY 	<b>13955</b> #6 5/32 X 5/8 WOODRUFF KEY 	<b>13959</b> #9 3/16 X 3/4 WOODRUFF KEY 	<b>13975</b> #19 3/16 X 1-1/4 WOODRUFF KEY 	<b>13973</b> #18 1/4 X 1-1/8 WOODRUFF KEY 	<b>13983</b> #D 5/16 X 1-1/4 WOODRUFF KEY 
<b>13952</b> #3 1/8 X 1/2 WOODRUFF KEY 	<b>13958</b> #8 5/32 X 3/4 WOODRUFF KEY 	<b>13962</b> #11 3/16 X 7/8 WOODRUFF KEY 	<b>13960</b> #91 1/4 X 3/4 WOODRUFF KEY 	<b>13977</b> #21 1/4 X 1-1/4 WOODRUFF KEY 	<b>13970</b> #152 3/8 X 1 WOODRUFF KEY 
<b>13954</b> #5 1/8 X 5/8 WOODRUFF KEY 	<b>13961</b> #10 5/32 X 7/8 WOODRUFF KEY 	<b>13966</b> #13 3/16 X 1 WOODRUFF KEY 	<b>13964</b> #A 1/4 X 7/8 WOODRUFF KEY 	<b>13969</b> #B 5/16 X 1 WOODRUFF KEY 	<b>13978</b> #22 1/4 X 1-3/8 WOODRUFF KEY 

PRODUCT CATEGORY: K

**Woodruff Keys**  
 24 Items • 185 Pcs  
 IBS No. 148R



Packaged in a Locking Steel Drawer for Easy Storage & Organization

<b>Cotter Pins</b> Large Diameter Long Length	
Assortment No. 155R	
<b>13646</b> 1/2 X 6 COTTER PIN ZP 	<b>13645</b> 1/2 X 5 COTTER PIN ZP 
<b>13624</b> 3/8 X 6 COTTER PIN ZP 	<b>13643</b> 1/2 X 4 COTTER PIN ZP 
<b>13623</b> 3/8 X 5 COTTER PIN ZP 	<b>13579</b> 1/4 X 4 COTTER PIN ZP 
<b>13621</b> 3/8 X 4 COTTER PIN ZP 	<b>13581</b> 1/4 X 5 COTTER PIN ZP 
<b>13605</b> 5/16 X 3 COTTER PIN ZP 	<b>13609</b> 5/16 X 5 COTTER PIN ZP 
<b>13641</b> 1/2 X 3 COTTER PIN ZP 	<b>13604</b> 5/16 X 2-1/2 COTTER PIN ZP  <b>13607</b> 5/16 X 4 COTTER PIN ZP 

PRODUCT CATEGORY: K

**Cotter Pins**  
 Large Diameter, Long Length  
 13 Items • 115 Pcs  
 IBS No. 155R



Packaged in a Locking Steel Drawer for Easy Storage & Organization

# IBS, INCORPORATED

## Assortments - Rings & Pins (K)



 <b>"E" Clips</b> Regular & Reinforced							
Assortment No. 161R							
A-8824 1/16 E-CLIP RETAINING RING	A-8825 1/8 E-CLIP RETAINING RING	A-8826 3/16 E-CLIP RETAINING RING	A-10130 9/64 E-CLIP RETAINING RING	A-10131 5/32 E-CLIP RETAINING RING	A-10132 11/64 E-CLIP RETAINING RING	A-8827 3/16 E-CLIP RETAINING RING	A-10133 7/32 E-CLIP RETAINING RING
A-8828 1/4 E-CLIP RETAINING RING	A-8824 5/16 E-CLIP RETAINING RING	A-8829 3/8 E-CLIP RETAINING RING	A-8830 7/16 E-CLIP RETAINING RING	A-5602 1/2 E-CLIP RETAINING RING	A-5603 5/8 E-CLIP RETAINING RING	A-8831 3/4 E-CLIP RETAINING RING	A-8832 7/8 E-CLIP RETAINING RING
A-8833 1" E-CLIP RETAINING RING						A-1615 1/8 HVY E-CLIP RETAINING RING	A-10134 5/32 HVY E-CLIP RETAINING RING
A-3166 3/16 HVY E-CLIP RETAINING RING	A-10135 7/32 E-CLIP RETAINING RING	A-3167 1/4 HVY E-CLIP RETAINING RING	A-3628 5/16 HVY E-CLIP RETAINING RING	A-5600 3/8 HVY E-CLIP RETAINING RING	A-2672 7/16 HVY E-CLIP RETAINING RING	A-8837 1/2 HVY E-CLIP RETAINING RING	A-5601 9/16 HVY E-CLIP RETAINING RING

PRODUCT CATEGORY: K

**"E" Clips**  
 Regular & Reinforced  
 27 Items • 1345 Pcs  
 IBS No. 161R



Packaged in a Locking Steel Drawer  
 for Easy Storage & Organization

 <b>Internal and External Retaining Rings</b>							
Assortment No. 163R							
A-8701 1/4 EXTERNAL SNAP RING	A-8702 1/8 EXT SNAP RING	A-8703 3/8 EXT SNAP RING	A-8704 7/16 EXT SNAP RING	A-8705 1/2 EXT SNAP RING	A-8706 9/16 EXT SNAP RING	A-8707 5/8 EXT SNAP RING	A-10120 11/16 EXT. SNAP RING
A-8708 3/4 EXT SNAP RING	A-10121 13/16 EXT E-CLIP RETAINING RIN	A-8709 7/8 EXT SNAP RING	A-10122 15/16 EXT. SNAP RING	A-8710 1" EXTERNAL SNAP RING	A-10123 1-1/16 EXT. SNAP RING	A-8711 1-1/8 EXT SNAP RING	A-10124 1-3/16 EXT. SNAP RING
A-8712 1-1/4 EXT SNAP RING	A-8688 1/4 INT SNAP RING	A-8689 5/16 INTERNAL SNAP RING	A-8690 3/8 INT SNAP RING	A-8691 7/16 INT SNAP RING	A-8692 1/2 INTERNAL SNAP RING	A-8693 9/16 INT SNAP RING	A-8694 5/8 INT SNAP RING
A-8695 3/4 INT SNAP RING	A-8696 7/8 INT SNAP RING	A-8697 1 INT SNAP RING	A-8698 1-1/8 INTERNAL SNAP RING	A-8699 1-1/4 INT SNAP RING			

PRODUCT CATEGORY: K

**Internal & External Retaining Rings**  
 29 Items • 410 Pcs  
 IBS No. 163R



Packaged in a Locking Steel Drawer  
 for Easy Storage & Organization

 <b>Standard O-Rings</b>							
Assortment No. 164R							
15545 #006 1/16 WL 1/8 ID O-RNG	15549 #010 1/16 WL 1/4 ID O-RNG	15558 #111 3/32 WL 7/16 ID O-RNG	15562 #115 3/32 WL 11/16 ID O-RNG	15566 #212 1/8 WL 7/8 ID O-RNG	15570 #216 1/8 WL 1-1/8 ID O-RNG	15574 #220 1/8 WL 1-3/8 ID O-RNG	15606 #326 3/16 WL 1- 5/8 ID O-RNG
15546 #007 1/16 WL 5/32 ID O-RNG	15550 #011 1/16WL 5/16ID X 7/16OD	15559 #112 3/32 WL 1/2 ID O-RNG	15563 #116 3/32 WL 3/4 ID O-RNG	15567 #213 1/8 WL 15/16 ID O-RNG	15571 #217 1/8 WL 1- 3/16 ID O-RNG	15575 #221 1/8 WL 1- 7/16 ID O-RNG	15607 #327 3/16 WL 1- 3/4 ID O-RNG
15547 #008 1/16 WL 3/16 ID O-RNG	15551 #012 1/16 WL 3/8 ID O-RNG	15560 #113 3/32 WL 9/16 ID O-RNG	15564 #210 1/8 WL 3/4 ID O-RNG	15568 #214 1/8 WL 1 ID O-RNG	15572 #218 1/8 WL 1-1/4 ID O-RNG	15576 #222 1/8 WL 1-1/2 ID O-RNG	
15548 #009 1/16 WL 7/32 ID O-RNG	15557 #110 3/32 WL 3/8 ID O-RNG	15561 #114 3/32 WL 5/8 ID O-RNG	15565 #211 1/8 WL 13/16 ID O-RNG	15569 #215 1/8 WL 1-1/16 ID O-RNG	15573 #219 1/8 WL 1- 5/16 ID O-RNG	15605 #325 3/16 WL 1- 1/2 ID O-RNG	

PRODUCT CATEGORY: K

**Standard O-Rings**  
 30 Items • 805 Pcs  
 IBS No. 164R



Packaged in a Locking Steel Drawer  
 for Easy Storage & Organization

ASSORTMENTS



# IBS, INCORPORATED

## Assortments - Rings & Pins (K)

ASSORTMENTS

IBS, Inc. SPECIALTY PRODUCTS FOR MAINTENANCE & REPAIR INDUSTRIALBOLT.COM © 2010 800-878-1906						Roll Pins
						Assortment No. 165R
13652 1/16 X 1/4 ROLL PIN ZP	13655 1/16 X 1/2 ROLL PIN ZP	13658 1/16 X 3/4 ROLL PIN ZP	13663 5/64 X 1/4 ROLL PIN ZP	13666 5/64 X 1/2 ROLL PIN ZP	13669 5/64 X 3/4 ROLL PIN ZP	
13679 3/32 X 3/8 ROLL PIN ZP	13683 3/32 X 3/4 ROLL PIN ZP	13685 3/32 X 1 ROLL PIN ZP	13690 1/8 X 3/8 ROLL PIN ZP	13696 1/8 X 1 ROLL PIN ZP	13698 1/8 X 1-1/4 ROLL PIN ZP	
13705 5/32 X 1/2 ROLL PIN ZP	13710 5/32 X 1 ROLL PIN ZP	13714 5/32 X 1-1/2 ROLL PIN ZP	13722 3/16 X 5/8 ROLL PIN ZP	13725 3/16 X 1 ROLL PIN ZP	13732 3/16 X 2 ROLL PIN ZP	
13738 7/32 X 3/4 ROLL PIN ZP	13744 7/32 X 1-1/2 ROLL PIN ZP	13746 7/32 X 1-3/4 ROLL PIN ZP	13753 1/4 X 1 ROLL PIN ZP	13760 1/4 X 2 ROLL PIN ZP	13764 1/4 X 3 ROLL PIN ZP	

PRODUCT CATEGORY: K

**Roll Pins**  
24 Items • 570 Pcs  
IBS No. 165R



Packaged in a Locking Steel Drawer for Easy Storage & Organization

IBS, Inc. SPECIALTY PRODUCTS FOR MAINTENANCE & REPAIR INDUSTRIALBOLT.COM © 2010 800-878-1906								Metric O-Rings 1.5mm to 3.0mm
								Assortment No. 184R
15700 3.0 X 1.5 METRIC O RING	15701 5.0 X 1.5 METRIC O RING	15702 7.0 X 1.5 METRIC O RING	15703 9.0 X 1.5 METRIC O RING	15704 11.0 X 1.5 METRIC O RING	15705 6.0 X 2.0 METRIC O RING	15706 8.0 X 2.0 METRIC O RING	15707 10.0 X 2.0 METRIC O RING	
15708 12.0 X 2.0 METRIC O RING	15709 14.0 X 2.0 METRIC O RING	15712 6.3 X 2.4 METRIC O RING	15713 8.3 X 2.4 METRIC O RING	15714 11.8 X 2.4 METRIC O RING	15715 13.3 X 2.4 METRIC O RING	15716 17.3 X 2.4 METRIC O RING	15717 5.0 X 2.5 METRIC O RING	
15718 7.0 X 2.5 METRIC O RING	15719 10.0 X 2.5 METRIC O RING	15720 12.0 X 2.5 METRIC O RING	15721 15.0 X 2.5 METRIC O RING	15722 10.0 X 3.0 METRIC O RING	15723 12.0 X 3.0 METRIC O RING	15724 14.0 X 3.0 METRIC O RING	15725 16.0 X 3.0 METRIC O RING	
15726 18.0 X 3.0 METRIC O RING	15727 20.2 X 3.0 METRIC O RING	15729 22.2 X 3.0 METRIC O RING	15730 24.2 X 3.0 METRIC O RING	15732 26.2 X 3.0 METRIC O RING	15734 30.2 X 3.0 METRIC O RING			

PRODUCT CATEGORY: K

**Metric O-Rings**  
1.5mm to 3.0mm  
30 Items • 220 Pcs  
IBS No. 184R



Packaged in a Locking Steel Drawer for Easy Storage & Organization

IBS, Inc. SPECIALTY PRODUCTS FOR MAINTENANCE & REPAIR INDUSTRIALBOLT.COM © 2010 800-878-1906						Metric O-Rings 2.0mm to 5.0mm Large Diameter
						Assortment No. 185R
15710 18.0 X 2.0 METRIC O RING	15711 20.0 X 2.0 METRIC O RING	15728 22.0 X 3.0 METRIC O RING	15731 25.0 X 3.0 METRIC O RING	15733 28.0 X 3.0 METRIC O RING	15734 30.2 X 3.0 METRIC O RING	
15735 32.2 X 3.0 METRIC O RING	15736 38.0 X 3.0 METRIC O RING	15737 25.0 X 4.0 METRIC O RING	15738 30.0 X 4.0 METRIC O RING	15739 32.0 X 4.0 METRIC O RING	15740 35.0 X 4.0 METRIC O RING	
15741 35.0 X 4.0 METRIC O RING	15742 38.0 X 4.0 METRIC O RING	15743 40.0 X 4.0 METRIC O RING	15744 44.0 X 4.0 METRIC O RING	15745 45.0 X 4.0 METRIC O RING	15746 50.0 X 4.0 METRIC O RING	
15747 25.0 X 5.0 METRIC O RING	15748 30.0 X 5.0 METRIC O RING	15749 35.0 X 5.0 METRIC O RING	15750 40.0 X 5.0 METRIC O RING	15751 45.0 X 5.0 METRIC O RING	15752 50.0 X 5.0 METRIC O RING	

PRODUCT CATEGORY: K

**Metric O-Rings**  
2.0mm to 5.0  
Large Diameter  
24 Items • 76 Pcs  
IBS No. 185R



Packaged in a Locking Steel Drawer for Easy Storage & Organization

# IBS, INCORPORATED

## Assortments - Rings & Pins (K)



IBS, Inc. SPECIALTY PRODUCTS FOR MAINTENANCE & REPAIR INDUSTRIALBOLTY.COM © © © 800-678-1906				Hitch Pin Clips			
				Assortment No. 240R			
15530 1/32 X 9-1/16 HITCH PIN 31P	15520 3/64 X 19-3/32 HITCH PIN 21P	15521 1/16 X 1-5/16 HITCH PIN 22P	15524 5/64 X 1-3/32 HITCH PIN 25P				
15512 3/32 X 1-3/16 HITCH PIN 13P	15516 3/32 X 1-9/16 HITCH PIN 17P	15506 3/32 X 2-5/16 HITCH PIN 7P	15513 3/32 X 2-1/2 HITCH PIN 14P				
15515 1/8 X 1-15/16 HITCH PIN 16P	15510 1/8 X 2-9/16 HITCH PIN 11P	15526 1/8 X 2-1/2 HITCH PIN 27P	15509 5/32 X 2-15/16 HITCH PIN 10P				
15505 3/16 X 3-1/4 HITCH PIN 6P	15507 3/16 X 3-3/4 HITCH PIN 8P	15528 3/16 X 3-1/2 HITCH PIN 29P	15518 1/4 X 4 HITCH PIN 19P				

PRODUCT CATEGORY: K

### Hitch Pin Clips

16 Items • 390 Pcs  
IBS No. 240R



Packaged in a Locking Steel Drawer  
for Easy Storage & Organization

IBS, Inc. SPECIALTY PRODUCTS FOR MAINTENANCE & REPAIR INDUSTRIALBOLTY.COM © © © 800-678-1906				Snapper & Lynch Pins			
				Assortment No. 394R			
28-01 1/4 X 1-3/4 SNAPPER PIN	63-01 3/16 X 1-9/16 LYNCH PIN	63-04 7/16 X 1-9/16 LYNCH PIN					
28-02 5/16 X 2-1/2 SNAPPER PIN	63-02 1/4 X 1-9/16 LYNCH PIN	63-05 7/16 X 1-3/4 LYNCH PIN					
28-03 3/8 X 1-3/8 SNAPPER PIN	A-11736 1/4 X 1-3/4 LYNCH PIN	63-11 7/16 X 1-9/16 LYNCH PIN					
28-04 3/8 X 2-1/4 SNAPPER PIN	63-03 5/16 X 1-9/16 LYNCH PIN						

PRODUCT CATEGORY: K

### Snapper & Lynch Pins

11 Items • 33 Pcs  
IBS No. 394R



Packaged in a Locking Steel Drawer  
for Easy Storage & Organization

IBS, Inc. SPECIALTY PRODUCTS FOR MAINTENANCE & REPAIR INDUSTRIALBOLTY.COM © © © 800-678-1906								Viton O-Rings							
								Assortment No. 735R							
30006 #006 1/16 WL 1/8 ID VITON O-RING	30010 #010 1/16 WL 1/4 ID VITON O-RING	30111 #111 3/32 WL 7/16 ID VITON O-RING	30115 #115 3/32 WL 11/16 ID VITON O-RING	30212 #212 1/8 WL 7/8 ID VITON O-RING	30216 #216 1/8 WL 1-1/8 ID VITON O-RING	30220 #220 1/8 WL 1-3/8 ID VITON O-RING	30326 #326 3/16 WL 1-5/8 ID VITON O-RING								
30007 #007 1/16 WL 5/32 ID VITON O-RING	30011 #011 1/16 WL 9/16 ID VITON O-RING	30112 #112 3/32 WL 1/2 ID VITON O-RING	30116 #116 3/32 WL 3/4 ID VITON O-RING	30213 #213 1/8 WL 15/16 ID VITON O-RING	30217 #217 1/8 WL 1-3/16 ID VITON O-RING	30221 #221 1/8 WL 1-7/16 ID VITON O-RING	30327 #327 3/16 WL 1-3/4 ID VITON O-RING								
30008 #008 1/16 WL 3/16 ID VITON O-RING	30012 #012 1/16 WL 3/8 ID VITON O-RING	30113 #113 3/32 WL 9/16 ID VITON O-RING	30210 #210 1/8 WL 3/4 ID VITON O-RING	30214 #214 1/8 WL 1" ID VITON O-RING	30218 #218 1/8 WL 1-1/4 ID VITON O-RING	30222 #222 1/8 WL 1-1/2 ID VITON O-RING									
30009 #009 1/16 WL 7/32 ID VITON O-RING	30110 #110 3/32 WL 3/8 ID VITON O-RING	30114 #114 3/32 WL 5/8 ID VITON O-RING	30211 #211 1/8 WL 13/16 ID VITON O-RING	30215 #215 1/8 WL 1-1/16 ID VITON O-RING	30219 #219 1/8 WL 1-5/16 ID VITON O-RING	30325 #325 3/16 WL 1-1/2 ID VITON O-RING									

PRODUCT CATEGORY: K

### Viton O-Rings

30 Items • 360 Pcs  
IBS No. 735R



Packaged in a Locking Steel Drawer  
for Easy Storage & Organization

ASSORTMENTS



# IBS, INCORPORATED

## Assortments - Rings & Pins (K)

ASSORTMENTS

<b>IBS, Inc.</b> <small>SPECIALTY PRODUCTS FOR MAINTENANCE &amp; REPAIR  INDUSTRIALBOLTY.COM © © © 800-670-1906</small>						Stainless Steel Cotter Pins					
						Assortment No. 798R					
13300 1/16 X 1/2 COTTER PIN SS 	13306 1/16 X 2 COTTER PIN SS 	13313 3/32 X 2 COTTER PIN SS 	13320 1/8 X 2 COTTER PIN SS 	13325 5/32 X 1-1/2 COTTER PIN SS 	13332 3/16 X 1-1/2 COTTER PIN SS 	13301 1/16 X 3/4 COTTER PIN SS 	13308 3/32 X 3/4 COTTER PIN SS 	13315 1/8 X 3/4 COTTER PIN SS 	13321 1/8 X 2-1/2 COTTER PIN SS 	13327 5/32 X 2 COTTER PIN SS 	13334 3/16 X 2 COTTER PIN SS 
13302 1/16 X 1 COTTER PIN SS 	13309 3/32 X 1 COTTER PIN SS 	13316 1/8 X 1 COTTER PIN SS 	13322 1/8 X 3 COTTER PIN SS 	13328 5/32 X 2-1/2 COTTER PIN SS 	13335 3/16 X 2-1/2 COTTER PIN SS 	13304 1/16 X 1-1/2 COTTER PIN SS 	13311 3/32 X 1-1/2 COTTER PIN SS 	13318 1/8 X 1-1/2 COTTER PIN SS 	13323 5/32 X 1 COTTER PIN SS 	13329 5/32 X 3 COTTER PIN SS 	13336 3/16 X 3 COTTER PIN SS 

PRODUCT CATEGORY: K

### Stainless Steel Cotter Pins

24 Items • 845 Pcs  
IBS No. 798R



Packaged in a Locking Steel Drawer  
for Easy Storage & Organization

<b>IBS, Inc.</b> <small>SPECIALTY PRODUCTS FOR MAINTENANCE &amp; REPAIR  INDUSTRIALBOLTY.COM © © © 800-670-1906</small>					A/C O-Rings				
					Nitrile for use with R134A & R12 Refrigerant				
					Assortment No. 804R				
A-18134 4.5MM X 7.3MM X 1.4MM NITRILE A/C O-RING 	A-18135 6MM X 9.6MM X 1.8MM NITRILE A/C O-RING 	A-18136 6.5MM X 9.5MM 1.5MM NITRILE A/C O-RING 	A-18137 6.6MM X 10.2MM X 1.8MM NITRILE A/C O-RING 	A-17604 290 X .432 X .071 NITRILE A/C O-RING 	A-18138 7.7MM X 11.3MM X 1.8MM NITRILE A/C O-RING 	A-18646 .375 X .500 X .063 NITRILE A/C O-RING 	A-17605 .400 X .546 X .073 NITRILE A/C O-RING 	A-18140 10.7MM X 15.5MM X 2.4MM NITRILE A/C O-RING 	A-18139 10.8MM X 14.4MM X 1.8MM NITRILE A/C O-RING 
A-17606 .509 X .655 X .073 NITRILE A/C O-RING 	A-18141 13.3MM X 18.1MM X 2.4MM NITRILE A/C O-RING 	A-18143 13.4MM X 17.2MM X 1.9MM NITRILE A/C O-RING 	A-18142 14MM X 17.6MM X 1.8MM NITRILE A/C O-RING 	A-18144 14.8MM X 19.6MM X 2.4MM NITRILE A/C O-RING 	A-17607 .617 X .769 X .076 NITRILE A/C O-RING 	A-18647 .688 X .813 X .063 NITRILE A/C O-RING 	A-19235 13/16 X 1-1/16 X 1/8 NITRILE A/C O-RING 		

PRODUCT CATEGORY: K

### AC O-Rings

Nitrile for use with  
R134A & R12 Refrigerant  
18 Items • 180 Pcs  
IBS No. 804R



Packaged in a Locking Steel Drawer  
for Easy Storage & Organization

# IBS, INCORPORATED

## Assortments - Socket Products (L)



IBS, Inc. SPECIALTY PRODUCTS FOR MAINTENANCE & REPAIR INDUSTRIALBOLT.COM © © © 800-678-1906						Hex Socket Head Cap Screws					
Assortment No. 167R											
14450 6-32 X 1/4 SOCKET HD C/S ALLOY	14454 6-32 X 3/4 SOCKET HD C/S ALLOY	14562 8-32 X 1/2 SOCKET HD C/S ALLOY	14681 10-32 X 1/2 SOCKET HD C/S	14571 10-24 X 1/2 SOCKET HD C/S	14685 10-32 X 1-1/4 SOCKET HD C/S						
14451 6-32 X 3/8 SOCKET HD C/S ALLOY	14455 6-32 X 1 SOCKET HD C/S ALLOY	14563 8-32 X 5/8 SOCKET HD C/S ALLOY	14682 10-32 X 5/8 SOCKET HD C/S	14572 10-24 X 5/8 SOCKET HD C/S	14686 10-32 X 1-1/2 SOCKET HD C/S						
14452 6-32 X 1/2 SOCKET HD C/S ALLOY	14560 8-32 X 1/4 SOCKET HD C/S ALLOY	14564 8-32 X 3/4 SOCKET HD C/S ALLOY	14683 10-32 X 3/4 SOCKET HD C/S	14573 10-24 X 3/4 SOCKET HD C/S	14576 10-24 X 1-1/4 SOCKET HD C/S						
14453 6-32 X 5/8 SOCKET HD C/S ALLOY	14561 8-32 X 3/8 SOCKET HD C/S ALLOY	14565 8-32 X 1 SOCKET HD C/S ALLOY	14684 10-32 X 1 SOCKET HD C/S ALLOY	14574 10-24 X 1 SOCKET HD C/S ALLOY	14577 10-24 X 1-1/2 SOCKET HD C/S						

PRODUCT CATEGORY: L

### Hex Socket Head Capscrews

24 Items • 925 Pcs  
IBS No. 167R



Packaged in a Locking Steel Drawer  
for Easy Storage & Organization

IBS, Inc. SPECIALTY PRODUCTS FOR MAINTENANCE & REPAIR INDUSTRIALBOLT.COM © © © 800-678-1906								Socket Set Screws Knurled Point Thread							
Assortment No. 190R															
14168 6-32 X 1/4 SOC SET KNURLED PT	14169 6-32 X 5/16 SOC SET KNURLED PT	14170 6-32 X 3/8 SOC SET KNURLED PT	14178 8-32 X 1/4 SOC SET KNURLED PT	14179 8-32 X 5/16 SOC SET KNURLED PT	14180 8-32 X 3/8 SOC SET KNURLED PT	14182 8-32 X 1/2 SOC SET KNURLED PT	14187 10-24 X 3/16 SOC SET KNURLED								
14188 10-24 X 1/4 SOC SET KNURLED PT	14190 10-24 X 3/8 SOC SET KNURLED PT	14191 10-24 X 1/2 SOC SET KNURLED PT	14212 1/4-20 X 1/4 SOC SET KNURLED	14213 1/4-20 X 5/16 SOC SET	14214 1/4-20 X 3/8 SOC SET KNURLED	14216 1/4-20 X 1/2 SOC SET KNURLED	14218 1/4-20 X 3/4 SOC SET KNURLED								
14228 5/16-18 X 3/8 SOC SET	14300 5/16-18 X 1/2 SOC SET	14302 5/16-18 X 3/4 SOC SET	14314 3/8-16 X 1/2 SOC SET KNURLED	14315 3/8-16 X 5/8 SOC SET KNURLED	14316 3/8-16 X 3/4 SOC SET KNURLED	14318 3/8-16 X 1 SOC SET KNURLED PT	14335 1/2-13 X 1/2 SOC SET KNURLED								
14336 1/2-13 X 5/8 SOC SET KNURLED	14337 1/2-13 X 3/4 SOC SET KNURLED	14338 1/2-13 X 1 SOC SET KNURLED PT													

PRODUCT CATEGORY: L

### Socket Set Screws Knurled Point Thread

27 Items • 490 Pcs  
IBS No. 190R



Packaged in a Locking Steel Drawer  
for Easy Storage & Organization

IBS, Inc. SPECIALTY PRODUCTS FOR MAINTENANCE & REPAIR INDUSTRIALBOLT.COM © © © 800-678-1906					SAE Alloy Socket Set Screws Knurled Point				
Assortment No. 191R									
14198 10-32 X 3/16 SOC SET KNURLED	14361 1/4-28 X 1/4 SOC SET KNURLED	14366 1/4-28 X 3/4 SOC SET KNURLED	14384 3/8-24 X 1/2 SOC SET KNURLED	14398 1/2-20 X 1/2 SOC SET CUP					
14199 10-32 X 1/4 SOC SET KNURLED PT	14362 1/4-28 X 5/16 SOC SET KNURLED	14372 5/16-24 X 3/8 SOC SET KNURLED	14385 3/8-24 X 5/8 SOC SET KNURLED	14399 1/2-20 X 5/8 SOC SET CUP					
14201 10-32 X 3/8 SOC SET KNURLED	14363 1/4-28 X 3/8 SOC SET KNURLED	14374 5/16-24 X 1/2 SOC SET KNURLED	14386 3/8-24 X 3/4 SOC SET KNURLED	14400 1/2-20 X 3/4 SOC SET CUP					
14203 10-32 X 1/2 SOC SET KNURLED	14365 1/4-28 X 1/2 SOC SET KNURLED	14376 5/16-24 X 3/4 SOC SET KNURLED	14387 3/8-24 X 1 SOC SET KNURLED PT	14401 1/2-20 X 1 SOC SET CUP POINT					

PRODUCT CATEGORY: L

### SAE Alloy Socket Set Screws Knurled Point

20 Items • 390 Pcs  
IBS No. 191R



Packaged in a Locking Steel Drawer  
for Easy Storage & Organization

ASSORTMENTS



# IBS, INCORPORATED

## Assortments - Socket Products (L)

ASSORTMENTS

<b>Socket Head Cap Screws</b> 4-40 to 10-32					
Assortment No. 371R					
14440 4-40 X 1/4 SOCKET HD C/S ALLOY	14441 4-40 X 3/8 SOCKET HD C/S ALLOY	14442 4-40 X 1/2 SOCKET HD C/S ALLOY	14443 4-40 X 5/8 SOCKET HD C/S ALLOY	14444 4-40 X 3/4 SOCKET HD C/S ALLOY	14480 6-32 X 1/4 SOCKET HD C/S ALLOY
14451 6-32 X 3/8 SOCKET HD C/S ALLOY	14452 6-32 X 1/2 SOCKET HD C/S ALLOY	14453 6-32 X 5/8 SOCKET HD C/S ALLOY	14454 6-32 X 3/4 SOCKET HD C/S ALLOY	14561 8-32 X 3/8 SOCKET HD C/S ALLOY	14562 8-32 X 1/2 SOCKET HD C/S ALLOY
14563 8-32 X 5/8 SOCKET HD C/S ALLOY	14564 8-32 X 3/4 SOCKET HD C/S ALLOY	14565 8-32 X 1 SOCKET HD C/S ALLOY	14570 10-24 X 3/8 SOCKET HD C/S	14571 10-24 X 1/2 SOCKET HD C/S	14573 10-24 X 3/4 SOCKET HD C/S
14574 10-24 X 1 SOCKET HD C/S ALLOY	14680 10-32 X 3/8 SOCKET HD C/S	14681 10-32 X 1/2 SOCKET HD C/S	14683 10-32 X 3/4 SOCKET HD C/S	14684 10-32 X 1 SOCKET HD C/S ALLOY	

PRODUCT CATEGORY: L

### Socket Head Capscrews

4-40 to 10-32  
23 Items • 1,075 Pcs  
IBS No. 371R



Packaged in a Locking Steel Drawer  
for Easy Storage & Organization

<b>Socket Head Cap Screws</b> 4-40 to 10-32					
Assortment No. 371R					
14440 4-40 X 1/4 SOCKET HD C/S ALLOY	14441 4-40 X 3/8 SOCKET HD C/S ALLOY	14442 4-40 X 1/2 SOCKET HD C/S ALLOY	14443 4-40 X 5/8 SOCKET HD C/S ALLOY	14444 4-40 X 3/4 SOCKET HD C/S ALLOY	14480 6-32 X 1/4 SOCKET HD C/S ALLOY
14451 6-32 X 3/8 SOCKET HD C/S ALLOY	14452 6-32 X 1/2 SOCKET HD C/S ALLOY	14453 6-32 X 5/8 SOCKET HD C/S ALLOY	14454 6-32 X 3/4 SOCKET HD C/S ALLOY	14561 8-32 X 3/8 SOCKET HD C/S ALLOY	14562 8-32 X 1/2 SOCKET HD C/S ALLOY
14563 8-32 X 5/8 SOCKET HD C/S ALLOY	14564 8-32 X 3/4 SOCKET HD C/S ALLOY	14565 8-32 X 1 SOCKET HD C/S ALLOY	14570 10-24 X 3/8 SOCKET HD C/S	14571 10-24 X 1/2 SOCKET HD C/S	14573 10-24 X 3/4 SOCKET HD C/S
14574 10-24 X 1 SOCKET HD C/S ALLOY	14680 10-32 X 3/8 SOCKET HD C/S	14681 10-32 X 1/2 SOCKET HD C/S	14683 10-32 X 3/4 SOCKET HD C/S	14684 10-32 X 1 SOCKET HD C/S ALLOY	

PRODUCT CATEGORY: L

### Socket Head Capscrews

1/4-20 to 1/2-13  
19 Items • 403 Pcs  
IBS No. 372R



Packaged in a Locking Steel Drawer  
for Easy Storage & Organization

<b>Flat Head Socket Capscrews</b> 4-40 - 10-32					
Assortment No. 373R					
147390 4-40 X 1/4 FLAT SOCKET C/S	147391 4-40 X 3/8 FLAT SOCKET C/S	147392 4-40 X 1/2 FLAT SOCKET C/S	147393 4-40 X 5/8 FLAT SOCKET C/S	147394 4-40 X 3/4 FLAT SOCKET C/S	147399 6-32 X 1/4 FLAT SOCKET HD C/S
147400 6-32 X 3/8 FLAT SOCKET C/S	147401 6-32 X 1/2 FLAT SOCKET C/S	147402 6-32 X 5/8 FLAT SOCKET C/S	147403 6-32 X 3/4 FLAT SOCKET C/S	147410 8-32 X 3/8 FLAT SOCKET C/S	147411 8-32 X 1/2 FLAT SOCKET C/S
147412 8-32 X 5/8 FLAT SOCKET C/S	147413 8-32 X 3/4 FLAT SOCKET C/S	147414 8-32 X 1 FLAT SOCKET C/S ALLOY	147420 10-24 X 3/8 FLAT SOCKET C/S	147421 10-24 X 1/2 FLAT SOCKET C/S	147423 10-24 X 3/4 FLAT SOCKET HD
147424 10-24 X 1 FLAT SOCKET HD C/S	14815 10-32 X 3/8 FLAT SOCKET C/S	14816 10-32 X 1/2 FLAT SOCKET C/S	14818 10-32 X 3/4 FLAT SOCKET C/S	14819 10-32 X 1 FLAT SOCKET C/S	

PRODUCT CATEGORY: L

### Flat Head Socket Capscrews

4-40 to 10-32  
23 Items • 1,050 Pcs  
IBS No. 373R



Packaged in a Locking Steel Drawer  
for Easy Storage & Organization

# IBS, INCORPORATED

## Assortments - Socket Products (L)



<b>Flat Head Socket Capscrews</b> 1/4-20 - 1/2-13 Assortment No. 374R				
14750 1/4-20 X 1/2 FLAT SOCKET C/S 	14752 1/4-20 X 3/4 FLAT SOCKET C/S 	14753 1/4-20 X 1 FLAT SOCKET C/S 	14754 1/4-20 X 1-1/4 FLAT SOCKET 	14755 1/4-20 X 1-1/2 FLAT SOCKET 
14760 5/16-18 X 1/2 FLAT SOCKET C/S 	14762 5/16-18 X 3/4 FLAT SOCKET C/S 	14763 5/16-18 X 1 FLAT SOCKET C/S 	14764 5/16-18 X 1-1/4 FLAT SOCKET 	14765 5/16-18 X 1-1/2 FLAT SOCKET 
14772 3/8-16 X 3/4 FLAT SOCKET C/S 	14773 3/8-16 X 1 FLAT SOCKET C/S 	14774 3/8-16 X 1-1/4 FLAT SOCKET 	14775 3/8-16 X 1-1/2 FLAT SOCKET 	14777 3/8-16 X 2 FLAT SOCKET C/S 
14787 1/2-13 X 1 FLAT SOCKET C/S 	14788 1/2-13 X 1-1/4 FLAT SOCKET 	14789 1/2-13 X 1-1/2 FLAT SOCKET 	14791 1/2-13 X 2 FLAT SOCKET C/S 	

PRODUCT CATEGORY: L

### Flat Socket Head Capscrews

1/4-20 to 1/2-13  
19 Items • 356 Pcs  
IBS No. 374R



Packaged in a Locking Steel Drawer for Easy Storage & Organization

<b>Button Head Socket Cap Screws</b> 4-40 to 10-32 Assortment No. 376R					
148911 4-40 X 1/4 BUTTON SOC C/S Hex Key: 1/16" 	148912 4-40 X 3/8 BUTTON SOC C/S Hex Key: 1/16" 	148913 4-40 X 3/8 BUTTON SOC C/S Hex Key: 1/16" 	148915 6-32 X 3/8 BUTTON SOC C/S Hex Key: 1/12" 	148916 6-32 X 3/8 BUTTON SOC C/S Hex Key: 5/64" 	148917 6-32 X 1/2 BUTTON SOC C/S Hex Key: 5/64" 
148918 6-32 X 5/8 BUTTON SOC C/S Hex Key: 5/64" 	148920 8-32 X 1/4 BUTTON SOC C/S Hex Key: 3/32" 	148921 8-32 X 3/8 BUTTON SOC C/S Hex Key: 3/32" 	14902 8-32 X 1/2 BUTTON SOC C/S Hex Key: 3/32" 	14903 8-32 X 5/8 BUTTON SOC C/S Hex Key: 3/32" 	14904 8-32 X 3/4 BUTTON SOC C/S Hex Key: 3/32" 
148925 10-24 X 1/4 BUTTON SOC C/S Hex Key: 1/8" 	148926 10-24 X 3/8 BUTTON SOC C/S Hex Key: 1/8" 	14907 10-24 X 1/2 BUTTON SOC C/S Hex Key: 1/8" 	14908 10-24 X 5/8 BUTTON SOC C/S Hex Key: 1/8" 	14909 10-24 X 3/4 BUTTON SOC C/S Hex Key: 1/8" 	14910 10-24 X 1 BUTTON SOC C/S Hex Key: 3/32" 
148930 10-32 X 1/4 BUTTON SOC C/S Hex Key: 1/8" 	148931 10-32 X 1/4 BUTTON SOC C/S Hex Key: 1/8" 	14911 10-32 X 1/2 BUTTON SOC C/S Hex Key: 1/8" 	148932 10-32 X 5/8 BUTTON SOC C/S Hex Key: 1/8" 	14912 10-32 X 3/4 BUTTON SOC C/S Hex Key: 1/8" 	14913 10-32 X 1 BUTTON SOC C/S Hex Key: 1/8" 

PRODUCT CATEGORY: L

### Button Head Socket Capscrews

4-40 to 10-32  
24 Items • 1,050 Pcs  
IBS No. 376R



Packaged in a Locking Steel Drawer for Easy Storage & Organization

<b>Button Head Socket Capscrews</b> 1/4-20 to 1/2-13 Assortment No. 377R				
14915 1/4-20 X 3/8 BUTTON SOCKET C/S Hex Key 5/32" 	14916 1/4-20 X 1/2 BUTTON SOCKET C/S Hex Key 5/32" 	14917 1/4-20 X 5/8 BUTTON SOCKET C/S Hex Key 5/32" 	14918 1/4-20 X 3/4 BUTTON SOCKET C/S Hex Key 5/32" 	14919 1/4-20 X 1 BUTTON SOCKET C/S Hex Key 5/32" 
14920 5/16-18 X 3/8 BUTTON SOCKET C/S Hex Key 3/16" 	14921 5/16-18 X 1/2 BUTTON SOCKET C/S Hex Key 3/16" 	14922 5/16 X 5/8 BUTTON SOCKET C/S Hex Key 3/16" 	14923 5/16-18 X 3/4 BUTTON SOCKET C/S Hex Key 3/16" 	14924 5/16-18 X 1 BUTTON SOCKET C/S Hex Key 3/16" 
14926 3/8-16 X 1/2 BUTTON SOCKET C/S Hex Key 7/32" 	14927 3/8-16 X 5/8 BUTTON SOCKET C/S Hex Key 7/32" 	14928 3/8-16 X 3/4 BUTTON SOCKET C/S Hex Key 7/32" 	14929 3/8-16 X 1 BUTTON SOCKET C/S Hex Key 7/32" 	14930 3/8-16 X 1-1/4 BUTTON SOCKET C/S Hex Key 7/32" 
14932 1/2-13 X 1 BUTTON SOCKET C/S Hex Key 5/16" 	14933 1/2-13 X 1-1/4 BUTTON SOCKET C/S Hex Key 5/16" 	14934 1/2-13 X 1-1/2 BUTTON SOCKET C/S Hex Key 5/16" 	14935 1/2-13 X 2 BUTTON SOCKET C/S Hex Key 5/16" 	

PRODUCT CATEGORY: L

### Button Head Socket Capscrews

1/4-20 to 1/2-13  
19 Items • 376 Pcs  
IBS No. 377R



Packaged in a Locking Steel Drawer for Easy Storage & Organization

ASSORTMENTS



# IBS, INCORPORATED

## Assortments - Steel Pipe Fittings (N)



### Steel Pipe Fittings

Assortment No. 139R

15021 1/2 HEX PLUG NPT ZP 	15071 1/2 4SDGR ST. ELB 150# NPT BMI 	15063 1/2 90DGR ST. ELB 150# NPT BMI 	15027 1/2 COUPLER 150# NPT BMI 	15135 1/2 X CLOSE (1-1/8) BLACK 	15136 1/2 X 1-1/2 BLACK NIPPLE 	15077 1/2 X 1/8 HEX BUSHING NPT ZP 	
15020 3/8 HEX PLUG NPT ZP 	15070 3/8 4SDGR ST. ELB 150# NPT BMI 	15062 3/8 90DGR ST. ELB 150# NPT BMI 	15026 3/8 COUPLER 150# NPT BMI 	15126 3/8 X CLOSE (1) BLACK NIPPLE 	15127 3/8 X 1-1/2 BLACK NIPPLE 	15076 3/8 X 1/4 HEX BUSHING NPT ZP 	
15019 1/4 HEX PLUG NPT ZP 	15069 1/4 4SDGR ST. ELB 150# NPT BMI 	15061 1/4 90DGR ST. ELB 150# NPT BMI 	15025 1/4 COUPLER 150# NPT BMI 	15115 1/4 X CLOSE (7/8) BLACK NIPPLE 	15116 1/4 X 1-1/2 BLACK NIPPLE 	15075 3/8 X 1/8 HEX BUSHING NPT ZP 	15079 1/2 X 3/8 HEX BUSHING NPT ZP 
15018 1/8 HEX PLUG NPT ZP 	15068 1/8 4SDGR ST. ELB 150# NPT BMI 	15060 1/8 90DGR ST. ELB 150# NPT BMI 	15201 1/8 COUPLER BLACK NPT STEEL 	15105 1/8 X CLOSE (3/4) BLACK NIPPLE 	15106 1/8 X 1-1/2 BLACK NIPPLE 	15074 1/4 X 1/8 HEX BUSHING NPT ZP 	15078 1/2 X 1/4 HEX BUSHING NPT ZP 

PRODUCT CATEGORY: N

## Steel Pipe Fittings

30 Items • 34 Pcs  
IBS No. 139R



Packaged in a Locking Steel Drawer  
for Easy Storage & Organization

A  
S  
S  
O  
R  
T  
M  
E  
N  
T  
S

# IBS, INCORPORATED

## Assortments - Brass Pipe Fittings (O)



IBS, Inc. SPECIALTY PRODUCTS FOR MAINTENANCE & REPAIR INDUSTRIALBOLT.COM • 800-478-1506								Brass Pipe Fittings	
								Assortment No. 103R	
3152X8 1/2 BRASS HEX HD PLUG	3220X8X2 1/2 X 1/4 BRASS PIPE HX	3326X4 1/4 X CLOSE BRASS NIPPLE	3350X4 1/4 BRASS 45DGR ST. ELBOW	3400X4 1/4 X 1/4 BRASS ST. ELBOW	3750X4 1/4 BRASS PIPE ST. TEE	WHD145 1/4 BRASS EXT SEAT DRAINCK	3300X8 1/2 BRASS PIPE COUPLING		
3152X6 3/8 BRASS HEX HD PLUG	3220X6X4 3/8 X 1/8 BRASS PIPE HX	3326X2 1/8 X CLOSE BRASS NIPPLE	3350X2 1/8 BRASS 45DGR ST. ELBOW	3400X2 1/8 X 1/8 BRASS ST. ELBOW	3750X2 1/8 BRASS PIPE ST. TEE	WHD135 1/8 BRASS EXT SEAT DRAINCK	3300X6 3/8 BRASS PIPE COUPLING		
3152X4 1/4 BRASS HEX HD PLUG	3220X4X2 3/8 X 1/8 BRASS PIPE HX	3326X8X6 1/2 X 3/8 BRASS PIPE HX	3326X8 1/2 X CLOSE BRASS NIPPLE	3350X8 1/2 BRASS 45DGR ST. ELBOW	3400X8 1/2 X 1/2 BRASS ST. ELBOW	3750X8 1/2 BRASS PIPE ST. TEE	3300X4 1/4 BRASS PIPE COUPLING		
3152X2 1/8 BRASS HEX HD PLUG	3220X4X2 1/4 X 1/8 BRASS PIPE HX	3220X8X4 3/8 X 1/4 BRASS PIPE HX	3326X6 3/8 X CLOSE BRASS NIPPLE	3350X6 3/8 BRASS 45DGR ST. ELBOW	3400X6 3/8 X 3/8 BRASS ST. ELBOW	3750X6 3/8 BRASS PIPE ST. TEE	3300X2 1/8 BRASS PIPE COUPLING		

PRODUCT CATEGORY: O

## Brass Pipe Fittings

32 Items • 64 Pcs  
IBS No. 103R



Packaged in a Locking Steel Drawer  
for Easy Storage & Organization

IBS, Inc. SPECIALTY PRODUCTS FOR MAINTENANCE & REPAIR INDUSTRIALBOLT.COM • 800-478-1506				Brass Pipe Fittings	
				3/8" & 1/2"	
				Assortment No. 103R-LGR	
3220X6X4 3/8 X 1/4 BRASS PIPE HX	3326X8 1/2 X CLOSE BRASS NIPPLE	3400X8 1/2 X 1/2 BRASS ST. ELBOW	3300X8 1/2 BRASS PIPE COUPLING		
3220X6X2 3/8 X 1/8 BRASS PIPE HX	3326X6 3/8 X CLOSE BRASS NIPPLE	3400X6 3/8 X 3/8 BRASS ST. ELBOW	3300X6 3/8 BRASS PIPE COUPLING		
3152X8 1/2 BRASS HEX HD PLUG	3220X8X6 1/2 X 3/8 BRASS PIPE HX	3350X8 1/2 BRASS 45DGR ST. ELBOW	3750X8 1/2 BRASS PIPE ST. TEE		
3152X6 3/8 BRASS HEX HD PLUG	3220X8X4 1/2 X 1/4 BRASS PIPE HX	3350X6 3/8 BRASS 45DGR ST. ELBOW	3750X6 3/8 BRASS PIPE ST. TEE		

PRODUCT CATEGORY: O

## Brass Pipe Fittings

3/8" & 1/2"

17 Items • 64 Pcs  
IBS No. 103R-LGR



Packaged in a Locking Steel Drawer  
for Easy Storage & Organization

IBS, Inc. SPECIALTY PRODUCTS FOR MAINTENANCE & REPAIR INDUSTRIALBOLT.COM • 800-478-1506				Brass Pipe Fittings	
				1/8" & 1/4"	
				Assortment No. 103R-SML	
3220X4X2 1/4 X 1/8 BRASS PIPE HX	3400X4 1/4 X 1/4 BRASS ST. ELBOW	3750X4 1/4 BRASS PIPE ST. TEE	WHD145 1/4 BRASS EXT. SEAT DRAIN COCK		
3152X4 1/4 BRASS HEX HD PLUG	3400X2 1/8 X 1/8 BRASS ST. ELBOW	3750X2 1/8 BRASS PIPE ST. TEE	WHD135 1/8 BRASS EXT. SEAT DRAIN COCK		
3152X2 1/8 BRASS HEX HD PLUG	3326X4 1/4 X CLOSE BRASS NIPPLE	3350X4 1/4 BRASS 45DGR ST. ELBOW	3300X4 1/4 BRASS PIPE COUPLING		
	3326X2 1/8 X CLOSE BRASS NIPPLE	3350X2 1/8 BRASS 45DGR ST. ELBOW	3300X2 1/8 BRASS PIPE COUPLING		

PRODUCT CATEGORY: O

## Brass Pipe Fittings

1/8" & 1/4"

15 Items • 69 Pcs  
IBS No. 103R-SML



Packaged in a Locking Steel Drawer  
for Easy Storage & Organization

ASSORTMENTS



# IBS, INCORPORATED

## Assortments - Brass Pipe Fittings (O)

ASSORTMENTS

<b>IBS, Inc.</b> <small>SPECIALTY PRODUCTS FOR MAINTENANCE &amp; REPAIR  INDUSTRIALBOLT.COM • 800-670-1506</small>								<b>SAE 45° Flare Brass Fittings</b>	
								Assortment No. 104R	
42X8 1/2 SAE 45DGR BRASS FLARE	48X5 5/16 X 1/8 SAE 45DGR BRASS	48X8 1/2 X 3/8 SAE 45DGR BRASS	48X10X6 5/8 X 3/8 SAE 45DGR BRASS	49X5X4 5/16 X 1/4 SAE 90DGR BRASS	49X8X4 1/2 X 1/4 SAE 90DGR BRASS	54X4 1/4 X 1/8 SAE 45DGR BRASS	54X10 5/8 X 1/2 SAE 45DGR BRASS		
42X6 3/8 SAE 45DGR BRASS FLARE	48X4X4 1/4 X 1/4 SAE 45DGR BRASS	48X6X6 3/8 X 3/8 SAE 45DGR BRASS	48X10 5/8 X 1/2 SAE 45DGR BRASS	49X5 5/16 X 1/4 SAE 90DGR BRASS	49X8 1/2 X 3/8 SAE 90DGR BRASS	49X10X6 5/8 X 3/8 SAE 90DGR BRASS	54X5 1/2 X 3/8 SAE 45DGR BRASS		
42X5 5/16 SAE 45DGR BRASS FLARE	48X4 1/4 X 1/8 SAE 45DGR BRASS	48X6 3/8 X 1/4 SAE 45DGR BRASS	48X8X8 1/2 X 1/2 SAE 45DGR BRASS	49X4X4 1/4 X 1/4 SAE 90DGR BRASS	49X6X6 3/8 X 3/8 SAE 90DGR BRASS	49X10 5/8 X 1/2 SAE 90DGR BRASS	54X6 3/8 X 1/4 SAE 45DGR BRASS		
42X4 1/4 SAE 45DGR BRASS FLARE	42X10 5/8 SAE 45DGR BRASS FLARE	48X5X4 5/16 X 1/4 SAE 45DGR BRASS	48X8X4 1/2 X 1/4 SAE 45DGR BRASS	49X4 1/4 X 1/8 SAE 90DGR BRASS	49X6 3/8 X 1/4 SAE 90DGR BRASS	49X8X8 1/2 X 1/2 SAE 90DGR BRASS	54X5 5/16 X 1/8 SAE 45DGR BRASS		

PRODUCT CATEGORY: O

### SAE 45° Flare Brass Fittings

32 Items • 95 Pcs  
IBS No. 104R



Packaged in a Locking Steel Drawer  
for Easy Storage & Organization

<b>IBS, Inc.</b> <small>SPECIALTY PRODUCTS FOR MAINTENANCE &amp; REPAIR  INDUSTRIALBOLT.COM • 800-670-1506</small>				<b>SAE 45° Flare Brass Fittings</b>	
				Assortment No. 104R-LGR	
42X8 1/2 SAE 45DGR BRASS FLARE	48X8X4 1/2 X 1/4 SAE 45DGR BRASS	48X8X8 1/2 X 1/2 SAE 45DGR BRASS			
42X10 5/8 SAE 45DGR BRASS FLARE	48X8 1/2 X 3/8 SAE 45DGR BRASS	48X10X6 5/8 X 3/8 SAE 45DGR BRASS			
54X8 1/2 X 3/8 SAE 45DGR BRASS	49X8X4 1/2 X 1/4 SAE 90DGR BRASS	49X8X8 1/2 X 1/2 SAE 90DGR BRASS			
54X10 5/8 X 1/2 SAE 45DGR BRASS	49X8 1/2 X 3/8 SAE 90DGR BRASS	49X10X6 5/8 X 3/8 SAE 90DGR BRASS			

PRODUCT CATEGORY: O

### SAE 45° Flare Brass Fittings

14 Items • 36 Pcs  
IBS No. 104R-LGR



Packaged in a Locking Steel Drawer  
for Easy Storage & Organization

<b>IBS, Inc.</b> <small>SPECIALTY PRODUCTS FOR MAINTENANCE &amp; REPAIR  INDUSTRIALBOLT.COM • 800-670-1506</small>				<b>SAE 45° Flare Brass Fittings</b>	
				Assortment No. 104R-SML	
42X4 1/4 SAE 45DGR BRASS FLARE	42X5 5/16 SAE 45DGR BRASS FLARE	42X6 3/8 SAE 45DGR BRASS FLARE			
48X4 1/4 X 1/8 SAE 45DGR BRASS	48X5 5/16 X 1/8 SAE 45DGR BRASS	48X6 3/8 X 1/4 SAE 45DGR BRASS			
48X4X4 1/4 X 1/4 SAE 45DGR BRASS	48X5X4 5/16 X 1/4 SAE 45DGR BRASS	48X6X6 3/8 X 3/8 SAE 45DGR BRASS			
49X4 1/4 X 1/8 SAE 90DGR BRASS	49X5 5/16 X 1/8 SAE 90DGR BRASS	49X6 3/8 X 1/4 SAE 90DGR BRASS			
49X4X4 1/4 X 1/4 SAE 90DGR BRASS	49X5X4 5/16 X 1/4 SAE 90DGR BRASS	49X6X6 3/8 X 3/8 SAE 90DGR BRASS			

PRODUCT CATEGORY: O

### SAE 45° Flare Brass Fittings 1/4", 5/16" & 3/8"

18 Items • 58 Pcs  
IBS No. 104R-SML



Packaged in a Locking Steel Drawer  
for Easy Storage & Organization

# IBS, INCORPORATED

## Assortments - Brass Pipe Fittings (O)



### Small Push-On Hose Fittings

20 Items • 88 Pcs  
IBS No. 111R



Packaged in a Locking Steel Drawer  
for Easy Storage & Organization

### Large Push-On Hose Fittings

12 Items • 51 Pcs  
IBS No. 112R



Packaged in a Locking Steel Drawer  
for Easy Storage & Organization

### SAE 45° Flare Brass Fittings

20 Items • 34 Pcs  
IBS No. 121R



Packaged in a Locking Steel Drawer  
for Easy Storage & Organization

IBS, Inc. SPECIALTY PRODUCTS FOR MAINTENANCE & REPAIR INDUSTRIALBOLT.COM • • • 800-478-1906					Small Push-On Hose Fittings
					Assortment No. 111R
10004B-102 1/4 X 1/8 BRASS PUSH-ON M. PIPE	10004B-104 1/4 X 1/4 BRASS PUSH-ON M. PIPE	10005B-102 5/16 X 1/8 PUSH-ON M. PIPE	10005B-104 5/16 X 1/4 PUSH-ON M. PIPE	10004B-Y04 1/4 PUSH-ON HOSE MENDER	
10006B-104 3/8 X 1/4 PUSH-ON M. PIPE	10006B-106 3/8 X 3/8 PUSH-ON M. PIPE	10004B-404 1/4 X 1/4 PUSH-ON SAE FE.	10004B-405 1/4 X 5/16 PUSH-ON SAE FE.	10005B-Y05 5/16 PUSH-ON HOSE MENDER	
10005B-405 5/16 X 5/16 PUSH-ON SAE	10006B-405 3/8 X 5/16 PUSH-ON SAE	10006B-406 3/8 X 3/8 PUSH-ON SAE	10004B-B04 1/4 X 1/4 PUSH-ON M. INV	10006B-Y06 3/8 PUSH-ON HOSE MENDER	
10004B-B05 1/4 X 5/16 PUSH-ON	10005B-B04 5/16 X 1/4 PUSH-ON M.	10005B-B05 5/16 X 5/16 PUSH-ON M. INV	10006B-B05 3/8 X 5/16 PUSH-ON M.	10006B-B06 3/8 X 3/8 PUSH-ON M. INV.	

PRODUCT CATEGORY: O

IBS, Inc. SPECIALTY PRODUCTS FOR MAINTENANCE & REPAIR INDUSTRIALBOLT.COM • • • 800-478-1906					Large Push-On Hose Fittings
					Assortment No. 112R
10008B-106 1/2 X 3/8 PUSH-ON M. PIPE		10008B-108 1/2 X 1/2 PUSH-ON M. PIPE		10008B-Y08 1/2 PUSH-ON HOSE MENDER	
10010B-108 5/8 X 1/2 PUSH-ON M. PIPE		10012B-112 3/4 X 3/4 PUSH-ON M. PIPE RIGID		10010B-Y10 5/8 PUSH-ON HOSE MENDER	
10008B-408 1/2 X 1/2 PUSH-ON SAE FE. SWIV		10010B-410 5/8 X 5/8 PUSH-ON SAE FE.		10012B-Y12 3/4 PUSH-ON HOSE MENDER	
10012B-412 PUSH-ON SAE FEMALE SWIVEL	10008B-B08 1/2 X 1/2 PUSH-ON M. INV	10006B-606 3/8 X 3/8 PUSH-ON JIC FE.			

PRODUCT CATEGORY: O

IBS, Inc. SPECIALTY PRODUCTS FOR MAINTENANCE & REPAIR INDUSTRIALBOLT.COM • • • 800-478-1906					Brass Draincocks & Shut-Off Valves
					Assortment No. 121R
WHD135 1/8 BRASS EXT. SEAT DRAIN COCK	WHD145 1/4 BRASS EXT. SEAT DRAIN COCK	WHD270 3/8 BRASS EXT. SEAT DRAIN COCK	WHD130 1/8 BRASS INT. SEAT DRAIN COCK	WHD108 1/2 BRASS EXT. SEAT DRAIN COCK	
WHD-1424 1/8 INT. SEAT DRAIN VALVE BRASS	WHD-1425 1/4 INT. SEAT DRAIN VALVE BRASS	WHD-1426 3/8 INT. SEAT DRAIN VALVE BRASS	6809 1/4 FE BRASS PIPE SHUT OFF	WHD1423 5/8 X 3/8 PIPE TO HOSE SHUT	
WHD6824 1/8 X 1/8 M. TO F. SHUT OFF	6828 1/4 X 1/4 MARINE SHUT OFF	WHD150 1/8 BRASS ANGLE BIB DRAIN COCK	WHD6660 1/4 BRASS ANGLE BIB DRAIN COCK	229KF SHUT OFF	
WHD-1421 1/4 BRASS AIR TANK VALVE	WHD6829 1/4 X 1/4 M TO F SHUT OFF	WHD-6892 1/4 BRASS GROUND PLUG	WHD-6893 3/8 BRASS GROUND PLUG	WHD1422 3/8 X 3/8 PIPE TO HOSE SHUT	

PRODUCT CATEGORY: O

ASSORTMENTS



# IBS, INCORPORATED

## Assortments - Brass Pipe Fittings (O)

ASSORTMENTS

IBS, Inc. SPECIALTY PRODUCTS FOR MAINTENANCE & REPAIR INDUSTRIALBOLTY.COM 800-678-1966		Air Brake Fittings for Hose	
Assortment No. 149R			
W15536 3/8 X 1/4 AIR BRAKE MALE CONNECTOR WITH SPRING GUARD	W15539 3/8 X 1/2 AIR BRAKE MALE CONNECTOR	W23907 3/8 X 3/8 AIR BRAKE MALE CONNECTOR WITH SPRING GUARD	W33886 1/2 X 1/2 AIR BRAKE MALE CONNECTOR WITH SPRING GUARD
	W03624 3/8 AIR BRAKE NUT		W33902 1/2 AIR BRAKE NUT
		W16678 3/8 AIR BRAKE HOSE MENDER	
			W33801 1/2 AIR BRAKE SLEEVE
W15535 3/8 X 1/2 AIR BRAKE MALE CONNECTOR WITH SPRING GUARD	W03613 3/8 AIR BRAKE NUT FOR SPRING GUARD		
	W03610 3/8 AIR BRAKE SLEEVE		
		W15540 3/8 X 1/4 AIR BRAKE MALE CONNECTOR	
			W24887 3/8 X 3/8 AIR BRAKE MALE CONNECTOR

PRODUCT CATEGORY: O

### Air Brake Fittings for Hose

13 Items • 35 Pcs  
IBS No. 149R



Packaged in a Locking Steel Drawer  
for Easy Storage & Organization

IBS, Inc. SPECIALTY PRODUCTS FOR MAINTENANCE & REPAIR INDUSTRIALBOLTY.COM 800-678-1966		Compression Brass Fittings			
Assortment No. 177R					
60X3 3/16 OD BRASS COMP SLEEVE	60X4 1/4 OD BRASS COMP SLEEVE	60X5 5/16 OD BRASS COMP SLEEVE	60X6 3/8 OD BRASS COMP SLEEVE	61X3 3/16 OD BRASS COMP NUT	61X4 1/4 OD BRASS COMP NUT
61X5 5/16 OD BRASS COMP NUT	61X6 3/8 OD BRASS COMP NUT	62X3 3/16 OD BRASS COMP UNION	62X4 1/4 OD BRASS COMP UNION	62X5 5/16 OD BRASS COMP UNION	62X6 3/8 OD BRASS COMP UNION
68X3 3/16 X 1/8 BRASS COMP M CONN	68X4 1/4 X 1/8 BRASS COMP M CONN	68X4X4 1/4 X 1/4 BRASS COMP M CONN	68X5 5/16 X 1/8 BRASS COMP M CONN	68X5X4 5/16 X 1/4 BRASS COMP M CONN	68X6 3/8 X 1/4 BRASS COMP M CONN
69X3 3/16 X 1/8 90DGR BRASS COMP M	69X4 1/4 X 1/8 90DGR BRASS COMP M	69X4X4 1/4 X 1/4 90DGR BRASS COMP M	69X5 5/16 X 1/8 90DGR BRASS COMP M	69X5X4 5/16 X 1/4 90DGR BRASS COMP M	69X6 3/8 X 1/4 90DGR BRASS COMP M

PRODUCT CATEGORY: O

### Compression Brass Fittings

24 Items • 209 Pcs  
IBS No. 177R



Packaged in a Locking Steel Drawer  
for Easy Storage & Organization

IBS, Inc. SPECIALTY PRODUCTS FOR MAINTENANCE & REPAIR INDUSTRIALBOLTY.COM 800-678-1966		Inverted Flare Brass Fittings			
Assortment No. 178R					
105X3 3/16 INV TUBE NUT STEEL	105X4 1/4 INV TUBE NUT STEEL	105X5 5/16 INV TUBE NUT STEEL	105X6 3/8 INV TUBE NUT STEEL	202X3 3/16 X 1/8 INV M CONN BRASS	202X4 1/4 X 1/8 INV M CONN BRASS
202X4X4 1/4 X 1/4 INV M CONN BRASS	202X5 5/16 X 1/8 INV M CONN BRASS	202X5X4 5/16 X 1/4 INV M CONN BRASS	202X6 3/8 X 1/4 INV M CONN BRASS	402X3 3/16 X 1/8 INV 90DGR ELBOW M	402X4 1/4 X 1/8 INV 90DGR ELBOW M
402X4X4 1/4 X 1/4 INV 90DGR ELBOW M	402X5 5/16 X 1/8 INV 90DGR ELBOW M	402X5X4 5/16 X 1/4 INV 90DGR ELBOW M	402X6 3/8 X 1/4 INV 90DGR ELBOW M	352X3 3/16 X 1/8 INV 45DGR ELBOW M	352X4 1/4 X 1/8 INV 45DGR ELBOW M
352X5 5/16 X 1/8 INV 45DGR ELBOW M	352X6 3/8 X 1/4 INV 45DGR ELBOW M	302X3 3/16 INV UNION BRASS	302X4 1/4 INV UNION BRASS	302X5 5/16 INV UNION BRASS	302X6 3/8 INV UNION BRASS

PRODUCT CATEGORY: O

### Inverted Flare Brass Fittings

24 Items • 129 Pcs  
IBS No. 178R



Packaged in a Locking Steel Drawer  
for Easy Storage & Organization

# IBS, INCORPORATED

## Assortments - Brass Pipe Fittings (O)



IBS, Inc. SPECIALTY PRODUCTS FOR MAINTENANCE & REPAIR INDUSTRIALBOLTY.COM © © © 800-678-1906		Fuller Transmission Fittings Compression & Push-On 1/8" & 5/32"				Assortment No. 179R
660A 1/8 SLEEVE FULLER TRANS	669A 1/8X1/8 M ELBOW FULLER TRANS	668AS 1/8X1/16 M CONN FULLER TRANS	1169X2X28 1/8X1/8 90DGR M SWIV ELB POLY	56822 1/8 X 1/8 M CONN POLY PUSH NP	1162X2 1/8 UNION POLY PUSH NP BRASS	
660B 5/32 SLEEVE FULLER TRANS	669B 5/32X1/8 M ELBOW FULLER TRANS	668A 1/8X1/8 M CONN FULLER TRANS	1169X3X28 5/32X1/8 90DGR M SWIV ELB	56832 5/32 X 1/8 M CONN POLY PUSH	1162X3 5/32 UNION POLY PUSH NP BRASS	
661A 1/8 NUT FULLER TRANS	662A 1/8 UNION FULLER TRANS	668BS 5/32 X1/16 M CONN FULLER TRANS	1169X3X4S 5/32X1/4 90DGR M SWIV ELB	56834 5/32 X 1/4 M CONN POLY PUSH		
661B 5/32 NUT FULLER TRANS	662B 5/32 UNION FULLER TRANS	668B 5/32X1/8 M CONN FULLER TRANS				

PRODUCT CATEGORY: O

### Fuller Transmission Fittings Compression & Push-On

1/8" & 5/32"  
20 Items • 95 Pcs  
IBS No. 179R



Packaged in a Locking Steel Drawer for Easy Storage & Organization

IBS, Inc. SPECIALTY PRODUCTS FOR MAINTENANCE & REPAIR INDUSTRIALBOLTY.COM © © © 800-678-1906		Push Lock DOT Air Brake Fittings 1/4" & 3/8"		Assortment No. 180R
86842 1/4 X 1/8 POLY-MATIC DOT MALE	87942 1/4 X 1/8 POLY-MATIC DOT M	86244 1/4 POLY-MATIC DOT UNION		
86844 1/4 X 1/4 POLY-MATIC DOT MALE	87944 1/4 X 1/4 POLY-MATIC M SWIVEL	86266 3/8 POLY-MATIC DOT UNION		
86864 3/8 X 1/4 POLY-MATIC DOT MALE	87964 3/8 X 1/4 POLY-MATIC DOT M	88244 1/4 POLY-MATIC DOT BULK HEAD		
86866 3/8 X 3/8 POLY-MATIC DOT MALE	87966 3/8 X 3/8 POLY-MATIC DOT M	88266 3/8 POLY-MATIC DOT BULK HEAD		

PRODUCT CATEGORY: O

### Push-Lock DOT Air Brake Fittings

12 Items • 36 Pcs  
IBS No. 180R



Packaged in a Locking Steel Drawer for Easy Storage & Organization

IBS, Inc. SPECIALTY PRODUCTS FOR MAINTENANCE & REPAIR INDUSTRIALBOLTY.COM © © © 800-678-1906		Push Lock DOT Air Brake Fittings 1/4", 3/8" and 1/2"		Assortment No. 181R
87944 1/4 X 1/4 POLY-MATIC M SWIVEL ELBOW	87966 3/8 X 3/8 POLY-MATIC DOT M SWIVEL ELBOW	87988 1/2 X 1/2 POLY-MATIC DOT M SWIVEL ELBOW		
87942 1/4 X 1/8 POLY-MATIC DOT M SWIVEL ELBOW	87964 3/8 X 1/4 POLY-MATIC DOT M SWIVEL ELBOW	87986 1/2 X 3/8 POLY-MATIC DOT M SWIVEL ELBOW		
86844 1/4 X 1/4 POLY-MATIC DOT MALE CONNECTOR	86866 3/8 X 3/8 POLY-MATIC DOT MALE CONNECTOR	86888 1/2 X 1/2 POLY-MATIC DOT MALE CONNECTOR		
86842 1/4 X 1/8 POLY-MATIC DOT MALE CONNECTOR	86864 3/8 X 1/4 POLY-MATIC DOT MALE CONNECTOR	86886 1/2 X 3/8 POLY-MATIC DOT MALE CONNECTOR		
88244 1/4 POLY-MATIC DOT BULK HEAD UNION	88266 3/8 POLY-MATIC DOT BULK HEAD UNION	88288 1/2 POLY-MATIC DOT BULK HEAD UNION		
86244 1/4 POLY-MATIC DOT UNION	86266 3/8 POLY-MATIC DOT UNION	86288 1/2 POLY-MATIC DOT UNION		

PRODUCT CATEGORY: O

### Push-Lock DOT Air Brake Fittings

1/4", 3/8" & 1/2"  
18 Items • 45 Pcs  
IBS No. 181R



Packaged in a Locking Steel Drawer for Easy Storage & Organization

A  
S  
S  
O  
R  
T  
M  
E  
N  
T  
S



# IBS, INCORPORATED

## Assortments - Brass Pipe Fittings (O)

ASSORTMENTS

IBS, Inc. SPECIALTY PRODUCTS FOR MAINTENANCE & REPAIR INDUSTRIALBOLT.COM © B © 300-678-1906					Nylon Air Brake Fittings 1/4" & 3/8" 192R				
1460X4 1/4 BRASS A/B SLEEVE	1461X4 1/4 BRASS A/B NUT	1462X4 1/4 BRASS A/B UNION	1468X4 1/4 X 1/8 BRASS A/B M CONN	1468X4X4 1/4 X 1/4 BRASS A/B M CONN	1469X4 1/4 X 1/8 BRASS A/B 90DGR M CONN	1469X4X4 1/4 X 1/4 BRASS A/B 90DGR M CONN	1480X4 1/4 X 1/8 BRASS A/B 45DGR M CONN	1484X4 1/4 BRASS A/B INSERT	1460X6 3/8 BRASS A/B SLEEVE
1461X6 3/8 BRASS A/B NUT	1462X6 3/8 BRASS A/B UNION	1468X6 3/8 X 1/4 BRASS A/B M CONN	1468X6X2 3/8 X 1/8 BRASS A/B M CONN	1468X6X6 3/8 X 3/8 BRASS A/B M CONN	1469X6 3/8 X 1/4 BRASS A/B 90DGR M CONN	1469X6X2 3/8 X 1/8 BRASS A/B 90DGR M CONN	1469X6X6 3/8 X 1/4 BRASS A/B 90DGR M CONN	1480X6 3/8 X 1/4 BRASS A/B 45DGR M CONN	1484X6 3/8 BRASS A/B INSERT

PRODUCT CATEGORY: O

### Nylon Air Brake Fittings 1/4" & 3/8" 20 Items • 121 Pcs IBS No. 192R



Packaged in a Locking Steel Drawer for Easy Storage & Organization

IBS, Inc. SPECIALTY PRODUCTS FOR MAINTENANCE & REPAIR INDUSTRIALBOLT.COM © B © 300-678-1906					1/2" Nylon Air Brake Fittings Assortment No. 193R				
1460X8 1/2 BRASS A/B SLEEVE	1461X8 1/2 BRASS A/B NUT	1462X8 1/2 BRASS A/B UNION	1468X8 1/2 X 3/8 BRASS A/B M. CONN	1468X8X4 1/2 X 1/4 BRASS A/B M. CONN	1469X8 1/2 X 1/2 BRASS A/B M. CONN	1469X8X8 1/2 X 1/2 BRASS A/B M. CONN	1469X8 1/2 X 3/8 BRASS A/B 90DGR	1469X8X4 1/2 X 1/4 BRASS A/B 90DGR	1469X8X8 1/2 X 1/2 BRASS A/B 90DR
1480X8 1/2 X 3/8 BRASS A/B 45DGR	1484X8 1/2 BRASS A/B INSERT								

PRODUCT CATEGORY: O

### 1/2" Nylon Air Brake Fittings 11 Items • 68 Pcs IBS No. 193R



Packaged in a Locking Steel Drawer for Easy Storage & Organization

IBS, Inc. SPECIALTY PRODUCTS FOR MAINTENANCE & REPAIR INDUSTRIALBOLT.COM © B © 300-678-1906					Poly-Matic Nickel Plated Brass Fittings Assortment No. 197R				
56822 1/8 X 1/8 COMPOSITE M CONN	56842 1/4 X 1/8 COMPOSITE M CONN	56844 1/4 X 1/4 COMPOSITE M CONN	56862 3/8 X 1/8 COMPOSITE M CONN	56864 3/8 X 1/4 COMPOSITE M CONN	56866 3/8 X 3/8 COMPOSITE M CONN	56886 1/2 X 3/8 COMPOSITE M CONN	1169X2X2S 1/2 X 1/8 90DGR M SWIV ELB POLY	1169X4X2S 1/4 X 1/8 90DGR M SWIV ELB POLY	1169X4X4S 1/4 X 1/4 90DGR M SWIV ELB POLY
1169X6X2S 3/8 X 1/8 90DGR M SWIV POLY	1169X6X4S 3/8 X 1/4 90DGR M SWIV ELB POLY	1169X6X6S 3/8 X 3/8 90DGR M SWIV ELB POLY	1169X8X6S 1/2 X 3/8 90DGR M SWIV ELB POLY	1162X2 1/8 UNION POLY PUSH NP BRASS	1162X4 1/4 UNION POLY PUSH NP BRASS	1162X6 3/8 UNION POLY PUSH NP BRASS	1162X8 1/2 UNION POLY PUSH NP BRASS		

PRODUCT CATEGORY: O

### Poly-Matic Nickel Plated Brass Fittings 18 Items • 44 Pcs IBS No. 197R



Packaged in a Locking Steel Drawer for Easy Storage & Organization

# IBS, INCORPORATED

## Assortments - Brass Pipe Fittings (O)



<b>Male/Female Pipe Thread Protectors</b>			
Assortment No. 203R			
18102 1/8 MALE NPT POLY PLUG 	18104 1/4 MALE NPT POLY PLUG 	18106 3/8 MALE NPT POLY PLUG 	18108 1/2 MALE NPT POLY PLUG 
18112 3/4 MALE NPT POLY PLUG 	18116 1 MALE NPT POLY PLUG 	18120 1-1/4 MALE NPT POLY PLUG 	18124 1-1/2 MALE NPT POLY PLUG 
18152 1/8 FEMALE NPT POLY CAP 	18154 1/4 FEMALE NPT POLY CAP 	18156 3/8 FEMALE NPT POLY CAP 	18158 1/2 FEMALE NPT POLY CAP 
18162 3/4 FEMALE NPT POLY CAP 	18166 1 FEMALE NPT POLY CAP 	18170 1-1/4 FEMALE NPT POLY CAP 	18174 1-1/2 FEMALE NPT POLY CAP 

PRODUCT CATEGORY: O

### Pipe Thread Protector Assortment

16 Items • 340 Pcs  
IBS No. 203R



Packaged in a Locking Steel Drawer for Easy Storage & Organization

<b>5/8" Air Brake Fittings for Nylon</b>		
Assortment No. 217R		
1460X10 5/8 BRASS A/B SLEEVE 	1461X10 5/8 BRASS A/B NUT 	1462X10 5/8 BRASS A/B UNION 
1468X10 5/8 X 1/2 BRASS A/B M. CONN 	1468X10X6 5/8 X 3/8 BRASS A/B M CONN 	1468X10X12 5/8 X 3/4 BRASS A/B M CONN 
1469X10 5/8 X 1/2 BRASS A/B 90DGR 	1469X10X6 5/8 X 3/8 BRASS A/B 90DGR 	1469X10X12 5/8 X 3/4 BRASS A/B 90DGR 
1480X10 5/8 X 1/2 BRASS A/B 45DR 	1484X10 5/8 BRASS A/B INSERT 	

PRODUCT CATEGORY: O

### 5/8" Air Brake Fittings for Nylon Tubing

11 Items • 25 Pcs  
IBS No. 217R



Packaged in a Locking Steel Drawer for Easy Storage & Organization

<b>Long-Barb Push-On Fittings</b> 1/8", 3/16", 1/4", 5/16"				
Assortment No. 218R				
10403B-103 3/16 LONG BARB UNION 	10404B-104 1/4 LONG BARB UNION 	10405B-105 5/16 LONG BARB UNION 	10406B-104 3/8 X 1/4 LONG BARB UNION 	10406B-105 3/8 X 5/16 LONG BARB UNION 
10502B-102 1/8 X 1/8 M. LONG BARB H. END 	10503B-102 3/16 X 1/8 M. LONG BARB H. END 	10503B-104 3/16 X 1/4 M. LONG BARB H. END 	10504B-102 1/4 X 1/8 M. LONG BARB H. END 	10504B-104 1/4 X 1/4 M LONG BARB HOSE END 
10504B-106 1/4 X 3/8 M. LONG BARB H. END 	10505B-102 5/16 X 1/8 M. LONG BARB H. END 	10505B-104 5/16 X 1/4 M. LONG BARB H. END 	10502B-202 1/8 X 1/8 F. LONG BARB H. END 	10503B-202 3/16 X 1/8 F. LONG BARB H. END 
10504B-202 1/4 X 1/8 F. LONG BARB H. END 	10504B-204 1/4 X 1/4 F. LONG BARB H. END 	10505B-202 5/16 X 1/8 F. LONG BARB H. END 	10505B-204 5/16 X 1/4 F. LONG BARB H. END 	

PRODUCT CATEGORY: O

### Push-On Hose Fittings 1/8", 3/16", 1/4" & 5/16"

19 Items • 78 Pcs  
IBS No. 218R



Packaged in a Locking Steel Drawer for Easy Storage & Organization

ASSORTMENTS



# IBS, INCORPORATED

## Assortments - Brass Pipe Fittings (O)

ASSORTMENTS

<b>Long-Barb Push-On Fittings</b> <small>3/8", 1/2, 3/4"</small> <small>Assortment No. 219R</small>			
10406B-106 3/8 X LONG BARB UNION 	10408B-108 1/2 LONG BARB UNION 	10410B-110 5/8 LONG BARB UNION 	10412B-112 3/4 LONG BARB UNION 
10506B-104 3/8 X 1/4 M. LONG BARB H. END 	10506B-106 3/8 X 3/8 M. LONG BARB H. END 	10508B-106 1/2 X 3/8 M. LONG BARB H. END 	10508B-108 1/2 X 1/2 M. LONG BARB H. END 
10510B-108 5/8 X 1/2 M. LONG BARB H. END 	10512B-108 3/4 X 1/2 M LONG BARB HOSE 	10512B-112 3/4 X 3/4 M. LONG BARB H. END 	10506B-204 3/8 X 1/4 F. LONG BARB H. END 
10506B-206 3/8 X 3/8 F. LONG BARB H. END 	10508B-204 1/2 X 1/4 F. LONG BARB H. END 	10508B-206 1/2 X 3/8 F. LONG BARB H. END 	10508B-208 1/2 X 1/2 F. LONG BARB H. END 

PRODUCT CATEGORY: O

**Push-On Hose Fittings 3/8", 1/2" & 3/4"**  
**16 Items • 56 Pcs**  
**IBS No. 219R**



Packaged in a Locking Steel Drawer for Easy Storage & Organization

<b>Poly-Push Composite Metric Fittings for Nylon Tubing</b> <b>M4, M6 &amp; M8</b> <small>Assortment No. 332R</small>					
301202 M4 X 1/8SPT COMPOSITE M CONN 	301212 M6 X 1/8SPT COMPOSITE M CONN 	301213 M6 X 1/4SPT COMPOSITE M CONN 	301218 M8 X 1/4SPT COMPOSITE M CONN 	301219 M8 X 3/8SPT COMPOSITE M CONN 	309250 M4 COMPOSITE STRAIGHT UNION 
302202 M4 X 1/8SPT COMP M SWIV 	302212 M6 X 1/8SPT COMP M SWIV 	302213 M6 X 1/4SPT COMP M SWIV 	302218 M8 X 1/4SPT COMP M SWIV 	302219 M8 X 3/8SPT COMP M SWIV 	309263 M6 COMPOSITE UNION CONN POLY 
307202 M4 X 1/8SPT COMP M BRANCH 	307212 M6 X 1/8SPT COMP M BRANCH 	307213 M6 X 1/4SPT COMP M BRANCH 	307218 M8 X 1/4SPT COMP M BRANCH 	307219 M8 X 3/8SPT COMP M BRANCH 	309268 M8 COMPOSITE STRAIGHT UNION 
304250 M4 COMPOSITE UNION ELBOW POLY 	304263 M6 COMPOSITE UNION ELBOW POLY 	304268 M8 COMPOSITE UNION ELBOW POLY 	305250 M4 COMPOSITE UNION TEE POLY 	305263 M6 COMPOSITE UNION TEE POLY 	305268 M8 COMPOSITE UNION TEE POLY 

PRODUCT CATEGORY: O

**Poly-Push Composite Metric Fittings for Nylon Tubing**  
**M4, M6 & M8**  
**24 Items • 39 Pcs**  
**IBS No. 332R**



Packaged in a Locking Steel Drawer for Easy Storage & Organization

<b>Poly-Push Composite Metric Fittings for Nylon Tubing</b> <b>M10 &amp; M12</b> <small>Assortment No. 333R</small>				
301223 M10 X 1/4SPT COMPOSITE M 	301224 M10 X 3/8SPT COMPOSITE M 	301225 M10 X 1/2SPT COMPOSITE M 	301229 M12 X 3/8SPT COMPOSITE M 	301230 M12 X 1/2SPT COMPOSITE M 
302223 M10 X 1/4SPT COMP M SWIV ELB 	302224 M10 X 3/8SPT COMP M SWIV ELB 	302229 M12 X 3/8SPT COMP M SWIV ELB 	302230 M12 X 1/2SPT COMP M SWIV ELB 	
304272 M10 COMPOSITE UNION ELBOW 	304275 M12 COMPOSITE UNION ELBOW 	305272 M10 COMPOSITE UNION TEE POLY 	305275 M12 COMPOSITE UNION TEE POLY 	
309272 M10 COMPOSITE STRAIGHT UNION 	309275 M12 COMPOSITE STRAIGHT UNION 	307224 M10 X 3/8SPT COMP M BRANCH 	307230 M12 X 1/2SPT COMP M BRANCH 	

PRODUCT CATEGORY: O

**Poly-Push Composite Metric Fittings for Nylon Tubing**  
**M10 & M12**  
**17 Items • 19 Pcs**  
**IBS No. 333R**



Packaged in a Locking Steel Drawer for Easy Storage & Organization

# IBS, INCORPORATED

## Assortments - Brass Pipe Fittings (O)



<b>Push Lock DOT Fittings</b> 5/32", 1/4" & 3/8"				
Assortment No. 334R				
86233 5/32 POLY-MATIC DOT UNION 	86244 1/4 POLY-MATIC DOT UNION 	86266 3/8 POLY-MATIC DOT UNION 	86444 1/4 POLY-MATIC DOT UNION TEE 	86466 3/8 POLY-MATIC DOT UNION TEE 
86842 1/4 X 1/8 POLY-MATIC DOT MALE 	86844 1/4 X 1/4 POLY-MATIC DOT MALE 	86864 3/8 X 1/4 POLY-MATIC DOT MALE 	86866 3/8 X 3/8 POLY-MATIC DOT MALE 	
87242 1/4X1/8 POLY-MATIC DOT M SWIV 	87244 1/4X1/4 POLY-MATIC DOT M SWIV 	87264 3/8X1/4 POLY-MATIC DOT M SWIV 	87266 3/8X3/8 POLY-MATIC DOT M SWIV 	
87942 1/4 X 1/8 POLY-MATIC DOT M 	87944 1/4 X 1/4 POLY-MATIC M SWIVEL 	87964 3/8 X 1/4 POLY-MATIC DOT M 	87966 3/8 X 3/8 POLY-MATIC DOT M 	

PRODUCT CATEGORY: O

### Poly-Matic DOT Air Brake Fittings

17 Items • 33 Pcs  
IBS No. 334R



Packaged in a Locking Steel Drawer for Easy Storage & Organization

<b>Push Lock DOT Fittings</b> 3/8" & 1/2"				
Assortment No. 335R				
86266 3/8 POLY-MATIC DOT UNION 	86288 1/2 POLY-MATIC DOT UNIONS 		86466 3/8 POLY-MATIC DOT UNION TEE 	86488 1/2 POLY-MATIC DOT UNION TEE 
86866 3/8 X 3/8 POLY-MATIC DOT MALE 	86884 1/2 X 1/4 POLY-MATIC DOT MALE 	86886 1/2 X 3/8 POLY-MATIC DOT MALE 	86888 1/2 X 1/2 POLY-MATIC DOT MALE 	
87266 3/8X3/8 POLY-MATIC DOT M SWIV 	87284 1/2X1/4 POLY-MATIC DOT M SWIV 	87286 1/2X3/8 POLY-MATIC DOT M SWIV 	87288 1/2X1/2 POLY-MATIC DOT M SWIV 	
87966 3/8 X 3/8 POLY-MATIC DOT M 	87984 1/2 X 1/4 POLY-MATIC DOT M 	87986 1/2 X 3/8 POLY-MATIC DOT M 	87988 1/2 X 1/2 POLY-MATIC DOT M 	

PRODUCT CATEGORY: K

### Poly-Matic DOT Air Brake Fittings

16 Items • 21 Pcs  
IBS No. 335R



Packaged in a Locking Steel Drawer for Easy Storage & Organization

<b>Poly-Push Composite Fractional Fittings for Nylon Tubing</b> 1/8", 5/32", 1/4" & 5/16"					
Assortment No. 336R					
56222 1/8 COMPOSITE STRAIGHT UNION 	56233 5/32 COMPOSITE STRAIGHT UNION 	56244 1/4 COMPOSITE STRAIGHT UNION 	56242 1/4 X 1/8 COMPOSITE UNION RED 	56255 5/16 COMPOSITE STRAIGHT UNION 	
56422 1/8 COMPOSITE UNION TEE POLY 	56444 1/4 COMPOSITE UNION TEE POLY 	56522 1/8 COMPOSITE UNION ELBOW 	56544 1/4 COMPOSITE UNION ELBOW 		57244 1/4 X 1/4 COMP M SWIV BR TEE 
56822 1/8 X 1/8 COMPOSITE M CONN 	56824 1/8 X 1/4 COMPOSITE M CONN 	56832 5/32 X 1/8 COMPOSITE M CONN 	56842 1/4 X 1/8 COMPOSITE M CONN 	56844 1/4 X 1/4 COMPOSITE M CONN 	56854 5/16 X 1/4 COMPOSITE M CONN 
57922 1/8 X 1/8 COMP M SWIV ELBOW 	57924 1/8 X 1/4 COMP M SWIV ELBOW 	57932 5/32 X 1/8 COMP M SWIV ELBOW 	57942 1/4 X 1/8 COMP M SWIV ELBOW 	57944 1/4 X 1/4 COMP M SWIV ELBOW 	57954 5/16 X 1/4 COMP M SWIV ELBOW 

PRODUCT CATEGORY: O

### Poly-Push Composite Fractional Fittings for Nylon Tubing

1/8", 5/32", 1/4" & 5/16"  
22 Items • 41 Pcs  
IBS No. 336R



Packaged in a Locking Steel Drawer for Easy Storage & Organization

ASSORTMENTS



# IBS, INCORPORATED

## Assortments - Brass Pipe Fittings (O)

ASSORTMENTS

<b>Poly-Push Composite Fractional Fittings for Nylon Tubing</b> 3/8" & 1/2" <small>Assortment No. 337R</small>				
56266 3/8 COMPOSITE STRAIGHT UNION 	56264 3/8 X 1/4 COMPOSITE UNION RED 	56288 1/2 COMPOSITE STRAIGHT UNION 	57264 3/8 X 1/4 COMP M SWIV BR TEE 	57286 1/2 X 3/8 COMP M SWIV BR TEE 
56466 3/8 COMPOSITE UNION TEE POLY 	56488 1/2 COMPOSITE UNION TEE POLY 	56566 3/8 COMPOSITE UNION ELBOW 	56588 1/2 COMPOSITE UNION ELBOW 	
56864 3/8 X 1/4 COMPOSITE M CONN 	56866 3/8 X 3/8 COMPOSITE M CONN 	56886 1/2 X 3/8 COMPOSITE M CONN 	56888 1/2 X 1/2 COMPOSITE M CONN 	
57964 3/8 X 1/4 COMP M SWIV ELBOW 	57966 3/8 X 3/8 COMP M SWIV ELBOW 	57986 1/2 X 3/8 COMP M SWIV ELBOW 	57988 1/2 X 1/2 COMP M SWIV ELBOW 	

PRODUCT CATEGORY: O

<b>Hydraulic Hose Shields</b> <small>Assortment No. 367R</small>			
18180 4" BLACK HOSE SHIELD 	18185 6" BLACK HOSE SHIELD 	18191 8" BLACK HOSE SHIELD 	18197 10" BLACK HOSE SHIELD 
18181 4" ORANGE HOSE SHIELD 	18186 6" ORANGE HOSE SHIELD 	18192 8" ORANGE HOSE SHIELD 	
18182 4" YELLOW HOSE SHIELD 	18187 6" YELLOW HOSE SHIELD 	18193 8" YELLOW HOSE SHIELD 	

PRODUCT CATEGORY: O

<b>Boss and For-Seal O-Ring Fittings Cap and Plugs</b> <small>Assortment No. 736R</small>				
7237X4 1/4 O-RING BOSS PLUG 	7237X6 3/8 O-RING BOSS PLUG 	7237X8 1/2 O-RING BOSS PLUG 	7237X10 5/8 O-RING BOSS PLUG 	7237X12 3/4 O-RING BOSS PLUG 
4229X4 1/4 FOR-SEAL PLUG 	4229X6 3/8 FOR-SEAL PLUG 	4229X8 1/2 FOR-SEAL PLUG 	4229X10 5/8 FOR-SEAL PLUG 	4229X12 3/4 FOR-SEAL PLUG 
4129X4 1/4 FOR-SEAL CAP 	4129X6 3/8 FOR-SEAL CAP 	4129X8 1/2 FOR-SEAL CAP 	4129X10 5/8 FOR-SEAL CAP 	4129X12 3/4 FOR-SEAL CAP 

PRODUCT CATEGORY: O

## Poly-Push Composite Fractional Fittings for Nylon Tubing

3/8" & 1/2"  
17 Items • 24 Pcs  
IBS No. 337R



Packaged in a Locking Steel Drawer for Easy Storage & Organization

## Hydraulic Hose Shields

10 Items • 25 Pcs  
IBS No. 367R



Packaged in a Locking Steel Drawer for Easy Storage & Organization

## Boss & For-Seal O-Ring Fittings Caps & Plugs

15 Items • 45 Pcs  
IBS No. 736R



Packaged in a Locking Steel Drawer for Easy Storage & Organization

# IBS, INCORPORATED

## Assortments - Brass Pipe Fittings (O)



IBS, Inc. SPECIALTY PRODUCTS FOR MAINTENANCE & REPAIR INDUSTRIALBOLTY.COM © © © 800-670-1906					Boss O-Ring Fittings				
					Assortment No. 737R				
CS315X4 1/4 X 1/4 MALE JIC TO MALE O-RING BOSS	CS315X4X6 1/4 X 3/8 MALE JIC TO MALE O-RING BOSS	CS315X6X4 3/8 X 1/4 MALE JIC TO MALE O-RING BOSS	CS315X6 3/8 X 3/8 MALE JIC TO MALE O-RING BOSS	CS315X6X8 3/8 X 1/2 MALE JIC TO MALE O-RING BOSS					
CS315X8X6 1/2 X 3/8 MALE JIC TO MALE O-RING BOSS	CS315X8 1/2 X 1/2 MALE JIC TO MALE O-RING BOSS	CS315X12X8 3/4 X 1/2 MALE JIC TO MALE O-RING BOSS	CS315X12 3/4 X 3/4 MALE JIC TO MALE O-RING BOSS						
CS515X4 1/4 MALE JIC TO MALE O-RING BOSS 90DG	CS515X6 3/8 MALE JIC TO MALE O-RING BOSS 90DG	CS515X6X8 3/8 X 1/2 MALE JIC TO MALE O-RING BOSS 90DG	CS515X8X6 1/2 X 3/8 MALE JIC TO MALE O-RING BOSS 90DG	CS515X8 1/2 MALE JIC TO MALE O-RING BOSS 90DG					
CS515X12 3/4 MALE JIC TO MALE O-RING BOSS 90DG									

PRODUCT CATEGORY: O

### Boss O-Ring Fittings

15 Items • 46 Pcs  
IBS No. 737R



Packaged in a Locking Steel Drawer for Easy Storage & Organization

IBS, Inc. SPECIALTY PRODUCTS FOR MAINTENANCE & REPAIR INDUSTRIALBOLTY.COM © © © 800-670-1906					JIC Fitting Adapters				
					Assortment No. 738R				
CS229X4 1/4 JIC PLUG	CS129X4 1/4 JIC CAP	CS305X4 1/4 JIC UNION	CS205X4 1/4 X 1/8 JIC M. CONN	CS205X8 1/2 X 3/8 JIC M. CONN					
CS229X6 3/8 JIC PLUG	CS129X6 3/8 JIC CAP	CS305X6 3/8 JIC UNION	CS205X4X4 1/4 X 1/4 JIC M. CONN	CS205X8X8 1/2 X 1/2 JIC M. CONN					
CS229X8 1/2 JIC PLUG	CS129X8 1/2 JIC CAP	CS305X8 1/2 JIC UNION	CS205X6 3/8 X 1/4 JIC M. CONN						
CS229X12 3/4 JIC PLUG	CS129X12 3/4 JIC CAP	CS305X12 3/4 JIC UNION	CS205X6X6 3/8 X 3/8 JIC M. CONN						

PRODUCT CATEGORY: O

### JIC Fitting Adapters

18 Items • 52 Pcs  
IBS No. 738R



Packaged in a Locking Steel Drawer for Easy Storage & Organization

IBS, Inc. SPECIALTY PRODUCTS FOR MAINTENANCE & REPAIR INDUSTRIALBOLTY.COM © © © 800-670-1906					Swivel Fittings				
					Assortment No. 739R				
9205X2X4 1/8 X 1/4 FEMALE PIPE SWIVEL TO MALE PIPE	9205X4X4 1/4 X 1/4 FEMALE PIPE SWIVEL TO MALE PIPE	9205X4X6 1/4 X 3/8 FEMALE PIPE SWIVEL TO MALE PIPE	9205X6X4 3/8 X 1/4 FEMALE PIPE SWIVEL TO MALE PIPE	9205X6X6 3/8 X 3/8 FEMALE PIPE SWIVEL TO MALE PIPE					
9205X6X8 3/8 X 1/2 FEMALE PIPE SWIVEL TO MALE PIPE	9205X8X6 1/2 X 3/8 FEMALE PIPE SWIVEL TO MALE PIPE	9205X8X8 1/2 X 1/2 FEMALE PIPE SWIVEL TO MALE PIPE							
9405X4X4 1/4 X 1/4 FEMALE PIPE SWIVEL TO MALE PIPE 90DG	9405X4X6 1/4 X 3/8 FEMALE PIPE SWIVEL TO MALE PIPE 90DG	9405X6X4 3/8 X 1/4 FEMALE PIPE SWIVEL TO MALE PIPE 90DG	9405X6X6 3/8 X 3/8 FEMALE PIPE SWIVEL TO MALE PIPE 90DG	9405X6X8 3/8 X 1/2 FEMALE PIPE SWIVEL TO MALE PIPE 90DG					
9405X8X6 1/2 X 3/8 FEMALE PIPE SWIVEL TO MALE PIPE 90DG	9405X8X8 1/2 X 1/2 FEMALE PIPE SWIVEL TO MALE PIPE 90DG								

PRODUCT CATEGORY: O

### JIC Swivel Fittings

15 Items • 30 Pcs  
IBS No. 739R



Packaged in a Locking Steel Drawer for Easy Storage & Organization

ASSORTMENTS



# IBS, INCORPORATED

## Assortments - Brass Pipe Fittings (O)

ASSORTMENTS

IBS, Inc. SPECIALTY PRODUCTS FOR MAINTENANCE & REPAIR INDUSTRIALBOLT.COM • 800-478-1906		Field Attachable Fittings	
Assortment No. 750R			
20620-6-6 5/16 X 3/8 JIC 37DGR F STRAIGHT SWIVEL 	20820-8-8 13/32 X 1/2 SAE 45DGR F STRAIGHT SWIVEL 	27920-4-4 3/16 X 1/4 SAE 45DGR FLARE F SWIVEL 90DGR ELBOW 	
20620-8-8 13/32 X 1/2 JIC 37DGR F STRAIGHT SWIVEL 	20820-10-10 1/2 X 5/8 SAE 45DGR F STRAIGHT SWIVEL 	27920-6-6 5/16 X 3/8 SAE 45DGR FLARE F SWIVEL 90DGR ELBOW 	
20820-4-4 3/16 X 1/4 SAE 45DGR F STRAIGHT SWIVEL 	20120-8-8 13/32 X 1/2 MALE PIPE RIGID 	27920-8-8 13/32 X 1/2 SAE 45DGR FLARE F SWIVEL 90DGR ELBOW 	
20820-6-6 5/16 X 3/8 SAE 45DGR F STRAIGHT SWIVEL 		27920-10-10 1/2 X 3/8 SAE 45DGR FLARE F SWIVEL 90DGR ELBOW 	

PRODUCT CATEGORY: O

### Field Attachable Fittings

11 Items • 19 Pcs  
IBS No. 750R



Packaged in a Locking Steel Drawer for Easy Storage & Organization

IBS, Inc. SPECIALTY PRODUCTS FOR MAINTENANCE & REPAIR INDUSTRIALBOLT.COM • 800-478-1906		Spiral Hose Wrap	
Assortment 777R			
19000 1/2 X SIN BLK HOSE WRAP FOR 1/4ID HYD HOSE 	19002 5/8 X SIN RED HOSE WRAP FOR 1/4ID AND 3/8ID HYD HOSE 	19004 3/4 X SIN YELLOW HOSE WRAP FOR 3/8ID HYD HOSE 	19006 1IN X SIN GREEN HOSE WRAP FOR 1/2ID AND 5/8ID HYD HOSE 
			19008 1-1/4IN X SIN PURPLE HOSE WRAP FOR 3/4ID HYD HOSE 
			19010 1-1/2IN X SIN GRAY HOSE WRAP FOR 1IN AND 1-1/4 IN HYD HOSE 



















PRODUCT CATEGORY: O

### Spiral Hose Wrap

6 Items • 21 Pcs  
IBS No. 777R



Packaged in a Locking Steel Drawer for Easy Storage & Organization

IBS, Inc. SPECIALTY PRODUCTS FOR MAINTENANCE & REPAIR INDUSTRIALBOLT.COM • 800-478-1906		Hydraulic O-Ring Assortment	
Assortment No. 805R			
8X252 1/2 SPLIT FLANGE O-RING 	12X252 3/4 SPLIT FLANGE O-RING 	16X252 1" SPLIT FLANGE O-RING 	20X252 1-1/4 SPLIT FLANGE O-RING 
			24X252 1-1/2 SPLIT FLANGE O-RING 
32X252 2" SPLIT FLANGE O-RING 	4629X4 1/4 FOR-SEAL O-RING 	4629X6 3/8 FOR-SEAL O-RING 	4629X8 1/2 FOR-SEAL O-RING 
			4629X10 5/8 FOR-SEAL O-RING 
4629X12 3/4 FOR-SEAL O-RING 	4629X16 1" FOR-SEAL O-RING 	4629X20 1-1/4 FOR-SEAL O-RING 	7629X4 1/4 O-RING BOSS STRAIGHT THREAD 
			7629X6 3/8 O-RING BOSS STRAIGHT THREAD 
7629X8 1/2 O-RING BOSS STRAIGHT THREAD 	7629X10 5/8 O-RING BOSS STRAIGHT THREAD 	7629X12 3/4 O-RING BOSS STRAIGHT THREAD 	7629X16 1IN O-RING BOSS STRAIGHT THREAD 

PRODUCT CATEGORY: O

### Hydraulic O-Ring Assortment

19 Items • 162 Pcs  
IBS No. 805R



Packaged in a Locking Steel Drawer for Easy Storage & Organization

# IBS, INCORPORATED

## Assortments - Brass Pipe Fittings (O)



<b>IBS, Inc.</b> <small>SPECIALTY PRODUCTS FOR MAINTENANCE &amp; REPAIR  INDUSTRIALBOLT.COM © &amp; © 200-678-1906</small>			
<b>Hydraulic Quick Couplers</b> Assortment No. 825R			
<b>137782</b> 1/2 X 1/2 ISO-A F PIPE COUPLER HYDRAULIC QUICK DISCONNECT 	<b>137784</b> 3/4 X 3/4 ISO-A F PIPE COUPLER HYDRAULIC QUICK DISCONNECT 	<b>137786</b> 1 X 1 ISO-A F PIPE COUPLER HYDRAULIC QUICK DISCONNECT 	<b>137787</b> 1 X 1 ISO-A F PIPE PLUG HYDRAULIC QUICK DISCONNECT 
<b>137783</b> 1/2 X 1/2 ISO-A F PIPE PLUG HYDRAULIC QUICK DISCONNECT 	<b>137785</b> 3/4 X 3/4 ISO-A F PIPE PLUG HYDRAULIC QUICK DISCONNECT 		

PRODUCT CATEGORY: O

### Hydraulic Quick Couplers

6 Items • 12 Pcs  
**IBS No. 825R**



Packaged in a Locking Steel Drawer  
for Easy Storage & Organization

<b>IBS, Inc.</b> <small>SPECIALTY PRODUCTS FOR MAINTENANCE &amp; REPAIR  INDUSTRIALBOLT.COM © &amp; © 200-678-1906</small>			
<b>Gladhands</b> Assortment No. 826R			
<b>393SER</b> GLADHAND SERVICE 	<b>393EME</b> GLADHAND EMERGENCY 	<b>393UNIV</b> GLADHAND UNIVERSAL 	<b>74160</b> DIELECTRIC GREASE GEL PUMP 35ML 
<b>394GLE</b> GLADHAND SEAL SERVICE - BLUE 	<b>394GLR</b> GLADHAND SEAL EMERGENCY - RED 	<b>394GL</b> GLADHAND SEAL UNIVERSAL - BLACK 	<b>394GLP</b> GLADHAND SEAL WITH DUST FLAP 
			<b>394GLS</b> GLADHAND SEAL WITH STAINLESS STEEL SCREEN 

PRODUCT CATEGORY: O

### Glad Hands

7 Items • 22 Pcs  
**IBS No. 826R**



Packaged in a Locking Steel Drawer  
for Easy Storage & Organization

<b>IBS, Inc.</b> <small>SPECIALTY PRODUCTS FOR MAINTENANCE &amp; REPAIR  INDUSTRIALBOLT.COM © &amp; © 200-678-1906</small>			
<b>Composite DOT Push Connect Fittings - 1/4", 3/8" and 1/2"</b> Assortment No. 829R			
<b>86018</b> 1/4 X 1/4 COMPOSITE DOT 90DGR MALE ELBOW PUSH CONNECT 	<b>86022</b> 3/8 X 3/8 COMPOSITE DOT 90DGR MALE ELBOW PUSH CONNECT 	<b>86026</b> 1/2 X 1/2 COMPOSITE DOT 90DGR MALE ELBOW PUSH CONNECT 	
<b>86017</b> 1/4 X 1/8 COMPOSITE DOT 90DGR MALE ELBOW PUSH CONNECT 	<b>86021</b> 3/8 X 1/4 COMPOSITE DOT 90DGR MALE ELBOW PUSH CONNECT 	<b>86025</b> 1/2 X 3/8 COMPOSITE DOT 90DGR MALE ELBOW PUSH CONNECT 	
<b>86004</b> 1/4 X 1/4 COMPOSITE DOT MALE PUSH CONNECT 	<b>86008</b> 3/8 X 3/8 COMPOSITE DOT MALE PUSH CONNECT 	<b>86012</b> 1/2 X 1/2 COMPOSITE DOT MALE PUSH CONNECT 	
<b>86003</b> 1/4 X 1/8 COMPOSITE DOT MALE PUSH CONNECT 	<b>86007</b> 3/8 X 1/4 COMPOSITE DOT MALE PUSH CONNECT 	<b>86011</b> 1/2 X 3/8 COMPOSITE DOT MALE PUSH CONNECT 	
<b>86086</b> 1/4 X 9/16-18 COMPOSITE DOT BULKHEAD UNION PUSH CONNECT 	<b>86087</b> 3/8 X 7/8-14 COMPOSITE DOT BULKHEAD UNION PUSH CONNECT 	<b>86088</b> 1/2 X 1-12 COMPOSITE DOT BULKHEAD UNION PUSH CONNECT 	
<b>86072</b> 1/4 COMPOSITE DOT UNION PUSH CONNECT 	<b>86073</b> 3/8 COMPOSITE DOT UNION PUSH CONNECT 	<b>86074</b> 1/2 COMPOSITE DOT UNION PUSH CONNECT 	

PRODUCT CATEGORY: O

### Composite Body DOT Air Brake Fittings

18 Items • 30 Pcs  
**IBS No. 829R**



Packaged in a Locking Steel Drawer  
for Easy Storage & Organization

ASSORTMENTS



# IBS, INCORPORATED

## Assortments - Brass Pipe Fittings (O)

ASSORTMENTS

<b>IBS, Inc.</b> <small>SPECIALTY PRODUCTS FOR MAINTENANCE &amp; REPAIR          INDUSTRIALBOLTY.COM • P.O. 900-878-1906</small>				<b>Air Brake Fittings</b> For 3/8" Hose Assortment No. 844R			
<b>W15536</b> 3/8 X 1/4 AIR BRAKE FOR HOSE MALE CONNECTOR W/ SPRING 	<b>W15540</b> 3/8 X 1/4 AIR BRAKE FOR HOSE MALE CONNECTOR 	<b>W16678</b> 3/8 AIR BRAKE FOR HOSE MENDER 	<b>W33470</b> 3/8 X 3/8 BRASS AIR HOSE CONN 				
<b>W23907</b> 3/8 X 3/8 AIR BRAKE FOR HOSE MALE CONNECTOR W/ SPRING 	<b>W24887</b> 3/8 X 3/8 AIR BRAKE FOR HOSE MALE CONNECTOR 	<b>W03624</b> 3/8 AIR BRAKE FOR HOSE NUT 	<b>W15992</b> 3/8 X 1/2 AIR BRAKE FOR HOSE INSERT 				
<b>W15535</b> 3/8 X 1/2 AIR BRAKE FOR HOSE MALE CONNECTOR W/ SPRING 	<b>W15539</b> 3/8 X 1/2 AIR BRAKE FOR HOSE MALE CONNECTOR 	<b>W03613</b> 3/8 AIR BRAKE FOR HOSE NUT FOR SPRING GUARD 	<b>W03610</b> 3/8 AIR BRAKE FOR HOSE SLEEVE 				

PRODUCT CATEGORY: O

**Air Brake Fittings for 3/8" Hose**  
 12 Items • 30 Pcs  
 IBS No. 844R



Packaged in a Locking Steel Drawer for Easy Storage & Organization

<b>IBS, Inc.</b> <small>SPECIALTY PRODUCTS FOR MAINTENANCE &amp; REPAIR          INDUSTRIALBOLTY.COM • P.O. 900-878-1906</small>				<b>Air Brake Fittings</b> For 1/2" Hose Assortment No. 845R			
<b>W33885</b> 1/2 X 3/8 AIR BRAKE FOR HOSE MALE CONNECTOR W/ SPRING 	<b>W33883</b> 1/2 X 3/8 AIR BRAKE FOR HOSE MALE CONNECTOR 	<b>W33887</b> 1/2 AIR BRAKE FOR HOSE MENDER 	<b>W33889</b> 1/2 X 1/2 AIR BRAKE FOR HOSE INSERT 				
<b>W33886</b> 1/2 X 1/2 AIR BRAKE FOR HOSE MALE CONNECTOR W/ SPRING 	<b>W33884</b> 1/2 X 1/2 AIR BRAKE FOR HOSE MALE CONNECTOR 	<b>W33802</b> 1/2 AIR BRAKE FOR HOSE NUT 	<b>W33801</b> 1/2 AIR BRAKE FOR HOSE SLEEVE 				
		<b>W33803</b> 1/2 AIR BRAKE FOR HOSE NUT FOR SPRING GUARD 					

PRODUCT CATEGORY: O

**Air Brake Fittings for 1/2" Hose**  
 9 Items • 22 Pcs  
 IBS No. 845R



Packaged in a Locking Steel Drawer for Easy Storage & Organization

<b>IBS, Inc.</b> <small>SPECIALTY PRODUCTS FOR MAINTENANCE &amp; REPAIR          INDUSTRIALBOLTY.COM • P.O. 900-878-1906</small>				<b>SAE 37° JIC Flare</b> <b>90° Elbows</b> Assortment No. 846R			
<b>C5405X4</b> 1/4 X 1/8 JIC 90DGR M ELBOW 	<b>C5405X4X4</b> 1/4 X 1/4 JIC 90DGR M ELBOW 	<b>C5405X5</b> 5/16 X 1/8 JIC 90DGR M ELBOW 	<b>C5405X5X4</b> 5/16 X 1/4 JIC 90DGR M ELBOW 				
<b>C5405X6X2</b> 3/8 X 1/8 JIC 90DGR M ELBOW 	<b>C5405X6</b> 3/8 X 1/4 JIC 90DGR M ELBOW 	<b>C5405X6X6</b> 3/8 X 3/8 JIC 90DGR M ELBOW 					
<b>C5405X8X4</b> 1/2 X 1/4 JIC 90DGR M ELBOW 	<b>C5405X8</b> 1/2 X 3/8 JIC 90DGR M ELBOW 	<b>C5405X8X8</b> 1/2 X 1/2 JIC 90DGR M ELBOW 					
<b>C5405X10X6</b> 5/8 X 3/8 JIC 90DGR M ELBOW 	<b>C5405X10</b> 5/8 X 1/2 JIC 90DGR M ELBOW 	<b>C5405X12</b> 3/4 X 3/4 JIC 90DGR M ELBOW 					

PRODUCT CATEGORY: O

**SAE 37° JIC Flare 90° Elbows**  
 13 Items • 23 Pcs  
 IBS No. 846R



Packaged in a Locking Steel Drawer for Easy Storage & Organization

# IBS, INCORPORATED

## Assortments - Brass Pipe Fittings (O)



<b>For-Seal to Straight-Thread O-Ring Fittings</b>				
Assortment No. 847R				
<b>4315X4</b> 1/4 X 1/4 MALE FACE SEAL TO STRAIGHT THREAD O-RING CONNECTOR 	<b>4315X6</b> 3/8 X 3/8 MALE FACE SEAL TO STRAIGHT THREAD O-RING CONNECTOR 	<b>4315X8</b> 1/2 X 1/2 MALE FACE SEAL TO STRAIGHT THREAD O-RING CONNECTOR 	<b>4315X10</b> 3/4 X 3/4 MALE FACE SEAL TO STRAIGHT THREAD O-RING CONNECTOR 	<b>4315X12</b> 5/8 X 5/8 MALE FACE SEAL TO STRAIGHT THREAD O-RING CONNECTOR 
<b>4365X4</b> 1/4 45DGR FOR SEAL TO STRT THREAD O-RING CONN 	<b>4365X6</b> 3/8 45DGR FOR SEAL TO STRT THREAD O-RING CONN 	<b>4365X8</b> 1/2 45DGR FOR SEAL TO STRT THREAD O-RING CONN 	<b>4365X10</b> 5/8 45DGR FOR SEAL TO STRT THREAD O-RING CONN 	<b>4365X12</b> 3/4 45DGR FOR SEAL TO STRT THREAD O-RING CONN 
<b>4515X4</b> 1/4 X 1/4 90DGR FOR SEAL TO STRAIGHT THREAD O-RING CONN 	<b>4515X6</b> 3/8 X 3/8 90DGR FOR SEAL TO STRAIGHT THREAD O-RING CONN 	<b>4515X8</b> 1/2 X 1/2 90DGR FOR SEAL TO STRAIGHT THREAD O-RING CONN 	<b>4515X10</b> 5/8 X 5/8 90DGR FOR SEAL TO STRAIGHT THREAD O-RING CONN 	<b>4515X12</b> 3/4 X 3/4 90DGR FOR SEAL TO STRAIGHT THREAD O-RING CONN 

PRODUCT CATEGORY: O

## For-Seal to Straight Thread O-Ring Fittings

15 Items • 22 Pcs  
IBS No. 847R



Packaged in a Locking Steel Drawer for Easy Storage & Organization

<b>Flap Wheels</b>				
Assortment No. 388R				
<b>65056</b> 3/4 X 3/4 120G FLAP WHEEL 	<b>65029</b> 1 X 1 120G FLAP WHEEL 	<b>65036</b> 1-1/2 X 1 120G FLAP WHEEL 	<b>65044</b> 2 X 1 120G FLAP WHEEL 	<b>65052</b> 3 X 1 120G FLAP WHEEL 
<b>65055</b> 3/4 X 3/4 80G FLAP WHEEL 	<b>65025</b> 1 X 1 80G FLAP WHEEL 	<b>65034</b> 1-1/2 X 1 80G FLAP WHEEL 	<b>65042</b> 2 X 1 80G FLAP WHEEL 	<b>65050</b> 3 X 1 80G FLAP WHEEL 
<b>65054</b> 3/4 X 3/4 60G FLAP WHEEL 	<b>65021</b> 1 X 1 60G FLAP WHEEL 	<b>65030</b> 1-1/2 X 1 60G FLAP WHEEL 	<b>65038</b> 2 X 1 60G FLAP WHEEL 	<b>65046</b> 3 X 1 60G FLAP WHEEL 
<b>65053</b> 3/4 X 3/4 40G FLAP WHEEL 	<b>65023</b> 1 X 1 40G FLAP WHEEL 	<b>65032</b> 1-1/2 X 1 40G FLAP WHEEL 	<b>65037</b> 2 X 1 40G FLAP WHEEL 	<b>65045</b> 3 X 1 40G FLAP WHEEL 

PRODUCT CATEGORY: PA

## Flap Wheels

12 Items • 33 Pcs  
IBS No. 398R



Packaged in a Locking Steel Drawer for Easy Storage & Organization

<b>Roloc Style Surface Prep Discs with 1/4 Angle Air Die Grinder</b>			
Assortment No. 501P			
<b>06521</b> 2" Fine Surface Conditioning Disc 	<b>06532</b> 3" Medium Surface Conditioning Disc 	<b>06535</b> 3" Roloc Back Pad 	<b>CA-14050</b> 1/4 Angle Air Die Grinder 
<b>06522</b> 2" Medium Surface Conditioning Disc 	<b>06533</b> 3" Coarse Surface Conditioning Disc 	<b>06525</b> 2" Roloc Back Pad 	
<b>06523</b> 2" Coarse Surface Conditioning Disc 	<b>68024</b> 3" 80 Grit Tapered Bristle Disc 	<b>68018</b> 2" 50 Grit Tapered Bristle Disc 	
<b>09420</b> 2" 80 Grit Zirconium Grinding Disc 	<b>36699</b> 3" 80 Grit Zirc Plus Grinding Disc 	<b>06531</b> 3" Fine Surface Conditioning Disc 	
<b>09415</b> 2" 60 Grit Zirconium Grinding Disc 	<b>36698</b> 3" 60 Grit Zirc Plus Grinding Disc 		
<b>09410</b> 2" 36 Grit Zirconium Grinding Disc 	<b>36695</b> 3" 36 Grit Zirc Plus Grinding Disc 		

PRODUCT CATEGORY: PA

## Roloc™ Style Surface Prep Discs with 1/4" Angle Air Die Grinder

17 Items • 64 Pcs  
IBS No. 501P



Packaged in a Locking Steel Drawer for Easy Storage & Organization

ASSORTMENTS



# IBS, INCORPORATED

## Assortments - Abrasives (PA)

ASSORTMENTS

**IBS, Inc.**  
SPECIALTY PRODUCTS FOR MAINTENANCE & REPAIR  
INDUSTRIALBOLT.COM © © © 800-878-1596

**Roloc Style Surface Prep Discs**

Assortment No. 504P

06521 2" Fine Surface Conditioning Disc	06532 3" Medium Surface Conditioning Disc	06535 3" Roloc Back Pad	
06522 2" Medium Surface Conditioning Disc	06533 2" Coarse Surface Conditioning Disc	06525 2" Roloc Back Pad	
06523 2" Coarse Surface Conditioning Disc	68024 3" 80 Grit Tapered Bristle Disc	68018 2" 50 Grit Tapered Bristle Disc	
09420 2" 80 Grit Zirconium Grinding Disc	36699 3" 80 Grit Zirc Plus Grinding Disc	06531 3" Fine Surface Conditioning Disc	
09415 2" 60 Grit Zirconium Grinding Disc	36698 3" 60 Grit Zirc Plus Grinding Disc		
09410 2" 36 Grit Zirconium Grinding Disc	36695 3" 36 Grit Zirc Plus Grinding Disc		

PRODUCT CATEGORY: PA

### 2" & 3" Roloc™ Surface Prep Assortment

16 Items • 66 Pcs  
IBS No. 504P



Packaged in a Locking Steel Drawer for Easy Storage & Organization

**IBS, Inc.**  
SPECIALTY PRODUCTS FOR MAINTENANCE & REPAIR  
INDUSTRIALBOLT.COM © © © 800-878-1596

**Super Stripper Roloc™ Coating Removal Discs**

Assortment No. 519P

06525 2 ROLOC BACKING PAD*	06535 3 ROLOC BACKING PAD*	06545 4 ROLOC BACKING PAD*	
06720 2 ROLOC COATING REMOVAL DISC*	06730 3 ROLOC COATING REMOVAL DISC*	06740 4 ROLOC COATING REMOVAL DISC*	

PRODUCT CATEGORY: PA

### Super Stripper Roloc™ Coating Removal Discs

6 Items • 15 Pcs  
IBS No. 519P



Packaged in a Locking Steel Drawer for Easy Storage & Organization

**IBS, Inc.**  
SPECIALTY PRODUCTS FOR MAINTENANCE & REPAIR  
INDUSTRIALBOLT.COM © © © 800-878-1596

**Roloc Surface Conditioning Discs**

Assortment No. 523P

06521 2IN FINE ROLOC SURF COND DISC	06531 3IN FINE ROLOC SURF COND DISC	06545 4IN ROLOC BACKING PAD	
06522 2IN MED ROLOC SURF COND DISC	06532 3IN MED ROLOC SURF COND DISC	06542 4IN MED ROLOC SURF COND DISC	
06523 2IN CRS ROLOC SURF COND DISC	06533 3IN CRS ROLOC SURF COND DISC	06543 4IN CRS ROLOC SURF COND DISC	
		06535 3IN ROLOC BACKING PAD	
		06525 2IN ROLOC BACKING PAD	

PRODUCT CATEGORY: PA

### Roloc™ Surface Conditioning Discs

11 Items • 56 Pcs  
IBS No. 523P













Packaged in a Locking Steel Drawer for Easy Storage & Organization

# IBS, INCORPORATED

## Assortments - Abrasives (PA)



3" Roloc™ Total Surface Prep Discs			
IBS, Inc. SPECIALTY PRODUCTS FOR MAINTENANCE & REPAIR INDUSTRIALBOLT.COM • 800-878-1506			Assortment No. 529P
40423 3IN MED ROLOC X-TOUGH CERAMIC SURF DISC 	40339 3IN 80G ROLOC CERAMIC GRAIN GRIND DISC 	38862 3IN V FINE ROLOC HI STRENGTH SATIN DISC 	06535 3IN ROLOC BACKING PAD 
40422 3IN CRS ROLOC X-TOUGH CERAMIC SURF DISC 	40338 3IN 60G ROLOC CERAMIC GRAIN GRIND DISC 	38861 3IN FINE ROLOC HI STRENGTH SATIN DISC 	
06730 3IN CRS SUPER STRIPPER COATING REMOVAL DISC 	40335 3IN 36G ROLOC CERAMIC GRAIN GRIND DISC 	38860 3IN MED ROLOC HI STRENGTH SATIN DISC 	

PRODUCT CATEGORY: PA

**3" Roloc™ Total Surface Prep**  
**10 Items • 58 Pcs**  
**IBS No. 529P**



Packaged in a Locking Steel Drawer for Easy Storage & Organization





IBS, Inc. SPECIALTY PRODUCTS FOR MAINTENANCE & REPAIR INDUSTRIALBOLT.COM • 800-878-1506			Roloc Bristle Discs
			Assortment No. 534P
68018 2IN 50G TAPERED BRISTLE DISC ROLOC DISC GREEN 25000RPM 	68025 3IN 50G TAPERED BRISTLE DISC ROLOC DISC GREEN 15000RPM 	06535 3IN ROLOC BACKING PAD 	
68017 2IN 80G TAPERED BRISTLE DISC ROLOC DISC YELLOW 25000RPM 	68024 3IN 80G TAPERED BRISTLE DISC ROLOC DISC YELLOW 15000RPM 	06525 2IN ROLOC BACKING PAD 	

PRODUCT CATEGORY: PA

**Roloc Bristle Discs & Backing Pads**  
**6 Items • 12 Pcs**  
**IBS No. 534P**



Packaged in a Locking Steel Drawer for Easy Storage & Organization

IBS, Inc. SPECIALTY PRODUCTS FOR MAINTENANCE & REPAIR INDUSTRIALBOLT.COM • 800-878-1506			Trim-Kut Discs
			Assortment No. 537P
69336 3IN 36G MID ALLOY TRIM KUT DISC 	69360 3IN 60G MID ALLOY TRIM-KUT DISC 	69399 3IN 120G MID ALLOY TRIM-KUT DISC 	
			69325 MANDREL FOR TRIM CUT DISCS 

PRODUCT CATEGORY: PA

**Trim-Kut Discs**  
**4 Items • 76 Pcs**  
**IBS No. 537P**



Packaged in a Locking Steel Drawer for Easy Storage & Organization

ASSORTMENTS



# IBS, INCORPORATED

## Assortments - Abrasives (PA)

ASSORTMENTS

**IBS, Inc.**  
SPECIALTY PRODUCTS FOR MAINTENANCE & REPAIR  
INDUSTRIALBOLT.COM • • • 800-678-1906

**Roloc Surface Conditioning Discs w/ Angle Air Die Grinder**

Assortment No. 541P

06521 2 FINE ROLOC SURF COND DISC	06531 3 FINE ROLOC SURF COND DISC	40420 2 CRS ROLOC X-TOUGH CERAMIC	06535 3 ROLOC BACKING PAD
06522 2 MED ROLOC SURF COND DISC	06532 3 MED ROLOC SURF COND DISC	40421 2 MED ROLOC X-TOUGH CERAMIC	
06523 2 CRS ROLOC SURF COND DISC	06533 3 CRS ROLOC SURF COND DISC	40422 3 CRS ROLOC X-TOUGH CERAMIC	
06525 2 ROLOC BACKING PAD	40423 3 MED ROLOC X-TOUGH CERAMIC		

PRODUCT CATEGORY: PA

**Roloc Surface Conditioning Discs with Angle Air Die Grinder**  
13 Items • 53 Pcs  
IBS No. 541P



Packaged in a Locking Steel Drawer for Easy Storage & Organization

**IBS, Inc.**  
SPECIALTY PRODUCTS FOR MAINTENANCE & REPAIR  
INDUSTRIALBOLT.COM • • • 800-678-1906

**Roloc Surface Conditioning Discs**

Assortment No. 542P

06521 2 FINE ROLOC SURF COND DISC	06531 3 FINE ROLOC SURF COND DISC	40420 2 CRS ROLOC X-TOUGH CERAMIC	06535 3 ROLOC BACKING PAD
06522 2 MED ROLOC SURF COND DISC	06532 3 MED ROLOC SURF COND DISC	40421 2 MED ROLOC X-TOUGH CERAMIC	
06523 2 CRS ROLOC SURF COND DISC	06533 3 CRS ROLOC SURF COND DISC	40422 3 CRS ROLOC X-TOUGH CERAMIC	
06525 2 ROLOC BACKING PAD	40423 3 MED ROLOC X-TOUGH CERAMIC		

PRODUCT CATEGORY: PA

**Roloc Surface Conditioning Discs**  
12 Items • 52 Pcs  
IBS No. 542P



Packaged in a Locking Steel Drawer for Easy Storage & Organization

**IBS, Inc.**  
SPECIALTY PRODUCTS FOR MAINTENANCE & REPAIR  
INDUSTRIALBOLT.COM • • • 800-678-1906

**2" & 3" Roloc Satin Discs**

Assortment No. 546P

38859 2" V FINE ROLOC HI STRENGTH	38861 3" FINE ROLOC HI STRENGTH	06535 3" ROLOC STYLE BACKING PAD	
38858 2" FINE ROLOC HI STRENGTH	38860 3" MED ROLOC HI STRENGTH	06525 2" ROLOC STYLE BACKING PAD	
38857 2" MED ROLOC HI STRENGTH	38862 3" V FINE ROLOC HI STRENGTH		

PRODUCT CATEGORY: O

**2" & 3" Roloc Satin Discs**  
8 Items • 62 Pcs  
IBS No. 546P













Packaged in a Locking Steel Drawer for Easy Storage & Organization

# IBS, INCORPORATED

## Assortments - Abrasives (PA)



3" Roloc Grinding Discs			
Assortment No. 548P			
09440 3 80G ROLOC ZIRC DISC* 	36699 3 80G ROLOC ZIRC+ GRINDING* 	40339 3 80G ROLOC CERAMIC GRAIN* 	
09435 3 60G ROLOC ZIRC DISC* 	36698 3 60G ROLOC ZIRC+ GRINDING* 	40338 3 60G ROLOC CERAMIC GRAIN* 	
09430 3 36G ROLOC ZIRC DISC* 	36695 3 36G ROLOC ZIRC+ GRINDING* 	40335 3 36G ROLOC CERAMIC GRAIN* 	06535 3 ROLOC BACKING PAD* 

PRODUCT CATEGORY: PA

### 3" Roloc Grinding Discs

9 Items • 15 Pcs  
IBS No. 548P



Packaged in a Locking Steel Drawer for Easy Storage & Organization

Stem Mounted Wire Brushes			
1/4" Shank			
Assortment No. 702R			
50074 1/2 .006 SOLID END BRUSH 1/4 SHANK 7/8 TRIM STEEL 	50078 1 .020 SOLID END BRUSH 1/4 SHANK 1-1/8 TRIM STEEL 	50066 3 .008 CIRCULAR FLARED END 1 SHANK CIRC CRIMP STEEL 	50067 1-1/2 .0118 CONFLX WIRE WHEEL 1/4" SHANK 
50077 3/4 .020 SOLID END BRUSH 1/4 SHANK 7/8" TRIM STEEL 	50065 1-1/2 FLARED END BRUSH 1/4 SHANK CIRC CRIMP STEEL 	04300 1-3/4 .006 WIRE CUP BRUSH 1/4 SHANK CRIMP 3/4 TRIM STEEL 	50069 3 .0118 CONFLX WIRE WHEEL 1/4 SHANK 



PRODUCT CATEGORY: PA

### Stem Mounted Wire Brushes

1/4" SHANK  
8 Items • 8 Pcs  
IBS No. 702R



Packaged in a Locking Steel Drawer for Easy Storage & Organization

Scratch Brushes	
Assortment No. 703R	
50028 10IN .014 RED HAND WIRE BRUSH COATED STEEL 	
50029 10IN .012 BLUE HAND WIRE BRUSH STAINLESS STEEL 	
50030 10IN .012 GRN HAND WIRE BRUSH BRASS 	
50091 3 X 7 SS SMALL SCRATCH BRUSH 	50092 3 X 7 BRASS SMALL SCRATCH BRUSH 
50093 3 X 7 NYLON SMALL SCRATCH BRUSH 	44088 5/16 ACID BRUSH 
44089 3/8 ACID BRUSH 	44090 1/2 ACID BRUSH 

PRODUCT CATEGORY: PA

### Scratch Brushes

9 Items • 45 Pcs  
IBS No. 703R



Packaged in a Locking Steel Drawer for Easy Storage & Organization

ASSORTMENTS



# IBS, INCORPORATED

## Assortments - Abrasives (PA)

ASSORTMENTS

IBS, Inc. SPECIALTY PRODUCTS FOR MAINTENANCE & REPAIR INDUSTRIALBOLT.COM © © © 800-878-1906				Roloc™ Surface Conditioning Discs 3/4" to 4"
				Assortment No. 705R
06516 3/4 FINE ROLOC SURF COND DISC 	06521 2IN FINE ROLOC SURF COND DISC 	06531 3IN FINE ROLOC SURF COND DISC 	06542 4IN MED ROLOC SURF COND DISC 	
06517 3/4 MED ROLOC SURF COND DISC 	06522 2IN MED ROLOC SURF COND DISC 	06532 3IN MED ROLOC SURF COND DISC 	06543 4IN CRS ROLOC SURF COND DISC 	
06518 3/4 CRS ROLOC SURF COND DISC 	06523 2IN CRS ROLOC SURF COND DISC 	06533 3IN CRS ROLOC SURF COND DISC 		

PRODUCT CATEGORY: PA

IBS, Inc. SPECIALTY PRODUCTS FOR MAINTENANCE & REPAIR INDUSTRIALBOLT.COM © © © 800-878-1906				Roloc™ Surface Conditioning Discs 3/4" to 3"
				Assortment No. 707R
06516 3/4 FINE ROLOC SURF COND DISC 	06517 3/4 MED ROLOC SURF COND DISC 	06518 3/4 CRS ROLOC SURF COND DISC 	06520 3/4 ROLOC STYLE BACKING PAD 	
06521 2" FINE ROLOC SURF COND DISC 	06522 2" MED ROLOC STYLE SURF COND 	06523 2" CRS ROLOC STYLE SURF COND 	06525 2" ROLOC STYLE BACKING PAD 	
06531 3" FINE ROLOC SURF COND DISC 	06532 3" MED ROLOC STYLE SURF COND 	06533 3" CRS ROLOC STYLE SURF COND 	06535 3" ROLOC STYLE BACKING PAD 	

PRODUCT CATEGORY: PA

IBS, Inc. SPECIALTY PRODUCTS FOR MAINTENANCE & REPAIR INDUSTRIALBOLT.COM © © © 800-878-1906			Flap Bands
			Assortment No. 733R
51022 1-1/4 X 3/4 FLAP BAND 40G 	51162 1-3/4 X 1-3/16 FLAP BAND 40G 	51262 2-1/2 X 1-3/16 FLAP BAND 40G 	
51024 1-1/4 X 3/4 FLAP BAND 60G 	51164 1-3/4 X 1-3/16 FLAP BAND 60G 	51264 2-1/2 X 1-3/16 FLAP BAND 60G 	
50950 1-1/4 X 3/4 FLAP BAND RUBBER EXPANDING DRUM 	50954 1-3/4 X 1-3/16 FLAP BAND RUBBER EXPANDING DRUM 	50956 2-1/2 X 1-3/16 FLAP BAND RUBBER EXPANDING DRUM 	

PRODUCT CATEGORY: PA

**3/4" - 4"**  
**Roloc Surface Conditioning Discs**  
 11 Items • 49 Pcs  
 IBS No. 705R



Packaged in a Locking Steel Drawer for Easy Storage & Organization

**Roloc Surface Conditioning Discs**  
 3/4" to 3"  
 12 Items • 48 Pcs  
 IBS No. 707R



Packaged in a Locking Steel Drawer for Easy Storage & Organization

**Flap Bands**  
 9 Items • 15 Pcs  
 IBS No. 733R



Packaged in a Locking Steel Drawer for Easy Storage & Organization

# IBS, INCORPORATED

## Assortments - Abrasives (PA)



**IBS, Inc.**  
SPECIALTY PRODUCTS FOR MAINTENANCE & REPAIR  
INDUSTRIALBOLT.COM © © © 800-678-1506

**Flap Bands  
with Air Die Grinder w/Regulator**

Assortment No. 734R

51022 1-1/4 X 3/4 FLAP BAND 40G 	51162 1-3/4 X 1-3/16 FLAP BAND 40G 	51262 2-1/2 X 1-3/16 FLAP BAND 40G 	69283 1/4 AIR DIE GRINDER W/REGULATOR 
51024 1-1/4 X 3/4 FLAP BAND 60G 	51164 1-3/4 X 1-3/16 FLAP BAND 60G 	51264 2-1/2 X 1-3/16 FLAP BAND 60G 	
50950 1-1/4 X 3/4 FLAP BAND RUBBER EXPANDING DRUM 	50954 1-3/4 X 1-3/16 FLAP BAND RUBBER EXPANDING DRUM 	50956 2-1/2 X 1-3/16 FLAP BAND RUBBER EXPANDING DRUM 	

**Flap Bands with  
Air Die Grinder  
with Regulator**  
9 Items • 15 Pcs  
IBS No. 734R



Packaged in a Locking Steel Drawer  
for Easy Storage & Organization

PRODUCT CATEGORY: PA

**IBS, Inc.**  
SPECIALTY PRODUCTS FOR MAINTENANCE & REPAIR  
INDUSTRIALBOLT.COM © © © 800-678-1506

**2" & 3" Roloc Satin & Felt Discs**

Assortment No. 759R

38857 2IN MED ROLOC HI STRENGTH SATIN DISC 	38860 3IN MED ROLOC HI STRENGTH SATIN DISC 	37755 2IN ROLOC MINI FELT FLAP DISC 	74206 GRAY POLISHING COMPOUND FOR FELT DISCS 
38858 2IN FINE ROLOC HI STRENGTH SATIN DISC 	38861 3IN FINE ROLOC HI STRENGTH SATIN DISC 	37757 3IN ROLOC MINI FELT FLAP DISC 	
38859 2IN V FINE ROLOC HI STRENGTH SATIN DISC 	38862 3IN V FINE ROLOC HI STRENGTH SATIN DISC 	06525 2IN ROLOC BACKING PAD 	

**2" & 3" Satin & Felt  
Discs**  
12 Items • 52 Pcs  
IBS No. 759R



Packaged in a Locking Steel Drawer  
for Easy Storage & Organization

PRODUCT CATEGORY: PA

**IBS, Inc.**  
SPECIALTY PRODUCTS FOR MAINTENANCE & REPAIR  
INDUSTRIALBOLT.COM © © © 800-678-1506

**Surface Conditioning Bands**

Assortment No. 774R

51029 1/2 X 1/2 SURFACE CONDITIONING BAND COARSE 	51034 1 X 1 SURFACE CONDITIONING BAND COARSE 	51039 1-1/2 X 1 SURFACE CONDITIONING BAND COARSE 	51042 1-1/2 X 1 SURFACE CONDITIONING BAND DRUM 
51030 1/2 X 1/2 SURFACE CONDITIONING BAND MEDIUM 	51035 1 X 1 SURFACE CONDITIONING BAND MEDIUM 	51040 1-1/2 X 1 SURFACE CONDITIONING BAND MEDIUM 	
51031 1/2 X 1/2 SURFACE CONDITIONING BAND VERY FINE 	51036 1 X 1 SURFACE CONDITIONING BAND VERY FINE 	51041 1-1/2 X 1 SURFACE CONDITIONING BAND VERY FINE 	

**Surface Conditioning  
Bands**  
12 Items • 40 Pcs  
IBS No. 774R



Packaged in a Locking Steel Drawer  
for Easy Storage & Organization

PRODUCT CATEGORY: PA

ASSORTMENTS



# IBS, INCORPORATED

## Assortments - Abrasives (PA)

ASSORTMENTS

**IBS, Inc.**  
SPECIALTY PRODUCTS FOR MAINTENANCE & REPAIR  
INDUSTRIALBOLTY.COM © © © 800-678-1596

Power Tube Brushes

Assortment #16R

50080 5/8 .006 POWER TUBE BRUSH	50081 1/2 .006 POWER TUBE BRUSH	50082 5/8 .005 POWER TUBE BRUSH	50083 3/4 .006 POWER TUBE BRUSH	50084 1" .006 POWER TUBE BRUSH	50085 1-1/4" .0104 POWER TUBE BRUSH

PRODUCT CATEGORY: PA

### Power Tube Brushes

6 Items • 6 Pcs  
IBS No. 816R



Packaged in a Locking Steel Drawer for Easy Storage & Organization

**IBS, Inc.**  
SPECIALTY PRODUCTS FOR MAINTENANCE & REPAIR  
INDUSTRIALBOLTY.COM © © © 800-678-1596

SilverBack Roloc Disc

Assortment No. 821R

50016 2IN 40G ROLOC SILVERBACK FLAP DISC	50017 2IN 60G ROLOC SILVERBACK FLAP DISC	50018 2IN 80G ROLOC SILVERBACK FLAP DISC	50019 2IN 120G ROLOC SILVERBACK FLAP DISC
50020 3IN 40G ROLOC SILVERBACK FLAP DISC	50021 3IN 60G ROLOC SILVERBACK FLAP DISC	50022 3IN 80G ROLOC SILVERBACK FLAP DISC	50023 3IN 120G ROLOC SILVERBACK FLAP DISC
06525 2IN ROLOC BACKING PAD	06535 3IN ROLOC BACKING PAD		

PRODUCT CATEGORY: PA

### Silverback Roloc Discs

10 Items • 22 Pcs  
IBS No. 821R



Packaged in a Locking Steel Drawer for Easy Storage & Organization

**IBS, Inc.**  
SPECIALTY PRODUCTS FOR MAINTENANCE & REPAIR  
INDUSTRIALBOLTY.COM © © © 800-678-1596

Solid Roloc Ceramic+ Grinding Discs

Assortment No. 827R

36600 2IN 36G SOLID ROLOC CERAMIC+ GRINDING DISC	36602 2IN 60G SOLID ROLOC CERAMIC+ GRINDING DISC	36603 2IN 80G SOLID ROLOC CERAMIC+ GRINDING DISC	36605 2IN 120G SOLID ROLOC CERAMIC+ GRINDING DISC
36607 3IN 36G SOLID ROLOC CERAMIC+ GRINDING DISC	36609 3IN 60G SOLID ROLOC CERAMIC+ GRINDING DISC	36610 3IN 80G SOLID ROLOC CERAMIC+ GRINDING DISC	36612 3IN 120G SOLID ROLOC CERAMIC+ GRINDING DISC
06525 2IN ROLOC BACKING PAD	06535 3IN ROLOC BACKING PAD		

PRODUCT CATEGORY: PA

### Solid Roloc Ceramic + Grinding Discs

10 Items • 42 Pcs  
IBS No. 827R



Packaged in a Locking Steel Drawer for Easy Storage & Organization

# IBS, INCORPORATED

## Assortments - Abrasives (PA)



IBS, Inc. SPECIALTY PRODUCTS FOR MAINTENANCE & REPAIR INDUSTRIALBOLT.COM • 800-678-1996				Solid Roloc Zirconia+ Grinding Discs			
				Assortment No. 828R			
36620 2IN 36G SOLID ROLOC ZIRC+ GRINDING DISC	36622 2IN 60G SOLID ROLOC ZIRC+ GRINDING DISC	36623 2IN 80G SOLID ROLOC ZIRC+ GRINDING DISC	36625 2IN 120G SOLID ROLOC ZIRC+ GRINDING DISC				
36627 3IN 36G SOLID ROLOC ZIRC+ GRINDING DISC	36629 3IN 60G SOLID ROLOC ZIRC+ GRINDING DISC	36630 3IN 80G SOLID ROLOC ZIRC+ GRINDING DISC	36632 3IN 120G SOLID ROLOC ZIRC+ GRINDING DISC				
06525 2IN ROLOC BACKING PAD	06535 3IN ROLOC BACKING PAD						

PRODUCT CATEGORY: PA

### Solid Roloc Zirconia+ Grinding Discs

10 Items • 42 Pcs  
IBS No. 828R



Packaged in a Locking Steel Drawer for Easy Storage & Organization

IBS, Inc. SPECIALTY PRODUCTS FOR MAINTENANCE & REPAIR INDUSTRIALBOLT.COM • 800-678-1996						Stem Thread Brushes					
						Assortment No. 839R					
50031 3/8 .012 1/4 STEM THREAD BRUSH COATED STEEL	50032 1/2 .012 1/4 STEM THREAD BRUSH COATED STEEL	50033 5/8 .012 1/4 STEM THREAD BRUSH COATED STEEL	50034 3/4 .012 1/4 STEM THREAD BRUSH COATED STEEL	50095 7/8 .012 1/4 STEM THREAD BRUSH COATED STEEL							

PRODUCT CATEGORY: PA

### Stem Thread Cleaning Brushes

5 Items • 5 Pcs  
IBS No. 839R



Packaged in a Locking Steel Drawer for Easy Storage & Organization

IBS, Inc. SPECIALTY PRODUCTS FOR MAINTENANCE & REPAIR INDUSTRIALBOLT.COM • 800-678-1996				Ceramic Roloc Flex Flap and Mini Flap Discs			
				Assortment No. 841R			
67340 3IN 40GRIT CERAMIC FLEX FLAP ROLOC	67360 3IN 60GRIT CERAMIC FLEX FLAP ROLOC	67380 3IN 80GRIT CERAMIC FLEX FLAP ROLOC					
64340 3IN 40GRIT CERAMIC MINI FLAP ROLOC	64360 3IN 60GRIT CERAMIC MINI FLAP ROLOC	64380 3IN 80GRIT CERAMIC MINI FLAP ROLOC					
67240 2IN 40GRIT CERAMIC FLEX FLAP ROLOC	67260 2IN 60GRIT CERAMIC FLEX FLAP ROLOC	67280 2IN 80GRIT CERAMIC FLEX FLAP ROLOC	06535 3IN ROLOC BACKING PAD				
64240 2IN 40GRIT CERAMIC MINI FLAP ROLOC	64260 2IN 60GRIT CERAMIC MINI FLAP ROLOC	64280 2IN 80GRIT CERAMIC MINI FLAP ROLOC	06525 2IN ROLOC BACKING PAD				

PRODUCT CATEGORY: PA

### Ceramic Roloc Flex Flap & Mini Flap Discs

14 Items • 30 Pcs  
IBS No. 841R



Packaged in a Locking Steel Drawer for Easy Storage & Organization

ASSORTMENTS



# IBS, INCORPORATED

## Assortments - Abrasives (PA)

A  
S  
S  
O  
R  
T  
M  
E  
N  
T  
S

<b>IBS, Inc.</b> <small>SPECIALTY PRODUCTS FOR MAINTENANCE &amp; REPAIR  INDUSTRIALBOLT.COM © © © 800-878-1986</small>		<b>Sanding Belts</b> 1/2 x 18	
Assortment No. 848R			
35036 1/2 X 18 36G ZIRC- SANDING BELT			
35060 1/2 X 18 60G ZIRC- SANDING BELT			
35080 1/2 X 18 80G ZIRC- SANDING BELT	35120 1/2 X 18 120G ZIRC- SANDING BELT		
35001 1/2 X 18 SURFACE CONDITIONING MATERIAL SANDING BELT COARSE			
35002 1/2 X 18 SURFACE CONDITIONING MATERIAL SANDING BELT MEDIUM			
35003 1/2 X 18 SURFACE CONDITIONING MATERIAL SANDING BELT VERY FINE			

PRODUCT CATEGORY: PA

**Sanding Belt Assortment**  
7 Items • 35 Pcs  
IBS No. 848R



Packaged in a Locking Steel Drawer for Easy Storage & Organization

<b>IBS, Inc.</b> <small>SPECIALTY PRODUCTS FOR MAINTENANCE &amp; REPAIR  INDUSTRIALBOLT.COM © © © 800-878-1986</small>		<b>Nylon Abrasive Wheels</b>	
Assortment No. 866R			
94160 1" NYLON ABRASIVE END BRUSH 80G COARSE	94170 1" NYLON ABRASIVE END BRUSH 150G MEDIUM	96660 3" NYLON ABRASIVE WHEEL 80G COARSE	96670 3" NYLON ABRASIVE WHEEL 150G MEDIUM
97460 2" NYLON ABRASIVE CUP BRUSH 80G COARSE	97470 2" NYLON ABRASIVE CUP BRUSH 150G MEDIUM	96760 4" NYLON ABRASIVE WHEEL 80G COARSE	96770 4" NYLON ABRASIVE WHEEL 150G MEDIUM
97660 3" NYLON ABRASIVE CUP BRUSH 80G COARSE	97670 3" NYLON ABRASIVE CUP BRUSH 150G MEDIUM		

PRODUCT CATEGORY: PA

**Sanding Belt Assortment**  
10 Items • 10 Pcs  
IBS No. 866R



Packaged in a Locking Steel Drawer for Easy Storage & Organization

# IBS, INCORPORATED

## Assortments - Taps, Burs & Blades (PT)



 <b>Special Purpose Reciprocating Saw Blades</b>	
Assortment No. 393R	
<b>44906</b> 9 X 3/4 6TPI RECIP BIMETAL Wood, nail-embedded wood, compositions, plastic, cast aluminum, light gauge metals.	
<b>45699</b> 6 TUNGSTEN CARBIDE GRIT RECIP BLADE Cutting fiberglass, lathe, plaster, ceramics, laminates, marble and hardened steel.	<b>45899</b> 8 TUNGSTEN CARBIDE GRIT RECIP BLADE Cutting fiberglass, lathe, plaster, ceramics, laminates, marble and hardened steel.
<b>460906</b> 9 X .062 6TPI DEMOLITION BIMETAL RECIP BLADE Specially designed for the toughest demolition jobs. Cuts all woods, nail-embedded wood and metals.	
<b>461206</b> 12 X .062 6TPI DEMOLITION BIMETAL RECIP BLADE Specially designed for the toughest demolition jobs. Cuts all woods, nail-embedded wood and metals.	
<b>460910</b> 9 X .062 10TPI DEMOLITION BIMETAL RECIP BLADE Specially designed for the toughest demolition jobs. Cuts all woods, nail-embedded wood and metals.	
<b>461210</b> 12 X .062 10TPI DEMOLITION BIMETAL RECIP BLADE Specially designed for the toughest demolition jobs. Cuts all woods, nail-embedded wood and metals.	

PRODUCT CATEGORY: PA

### Special Purpose Reciprocating Saw Blades

7 items • 14 Pcs  
IBS No. 393R



Packaged in a Locking Steel Drawer for Easy Storage & Organization

 <b>Hi-Alloy Reciprocating Saw Blades</b>	
Assortment No. 512P	
<b>441206</b> 12" 6TPI HI ALLOY RECIP BLADE Wood, nail-embedded wood, compositions plastic, cast aluminum, light gauge metals.	
<b>44914</b> 9 X 3/4 14TPI BIMETAL RECIP BLADE Heavy gauge metals of 18 gauge to 1/8" thick conduit, pipe, channels and tubing.	<b>44918</b> 9 X 3/4 18TPI BIMETAL RECIP BLADE Heavy gauge metals of 18 gauge to 1/8" thick conduit, pipe, channels and tubing.
<b>4481014</b> 8" 10-14TPI HI ALLOY RECIP BLADE All woods, plastic, cast aluminum, nail-embedded wood, soil pipe.	<b>44818</b> 8 X 3/4 18TPI BIMETAL RECIP BLADE Heavy gauge metals of 18 gauge to 1/8" thick conduit, pipe, channels and tubing.
<b>44614</b> 6" 14TPI HI ALLOY RECIP BLADE Heavy gauge metals 1/8" thick and above. Barstock and angles.	<b>44618</b> 6" 18TPI HI ALLOY RECIP BLADE Heavy gauge metals of 18 gauge to 1/8" thick conduit, pipe, channels and tubing.
<b>44610</b> 6" 10TPI HI ALLOY RECIP BLADE Wood, nail-embedded wood, compositions plastic, cast aluminum, light gauge metals.	<b>4461014</b> 6" 10-14TPI HI ALLOY RECIP All woods, plastic, cast aluminum, nail-embedded wood, soil pipe.
<b>44606</b> 6" 6TPI HI ALLOY RECIP BLADE Wood, nail-embedded wood, compositions plastic, cast aluminum, light gauge metals.	<b>44656</b> 6" 6TPI HI ALLOY RECIP BLADE Plaster with metal lathe plaster board, sheet rock, plaster walls. tooth design cuts both forward and on backward stroke.

PRODUCT CATEGORY: PA

### Hi-Alloy Reciprocating Saw Blades

12 items • 55 Pcs  
IBS No. 512P



Packaged in a Locking Steel Drawer for Easy Storage & Organization

 <b>Nitro-Carb Power Taps, Hex Dies and Drill Bits with Tools</b>																									
Assortment No. 591P																									
<b>120922</b> Professional Tap Wrench	<b>120925</b> Professional 1" Hex Die Wrench																								
<table border="1"> <tr> <td> <b>129913</b>                              HSS Hex Die                         </td> <td> <b>129922</b>                              HSS Hex Die                         </td> </tr> <tr> <td> <b>17643</b>                              Nitro-Carb Power Tap                         </td> <td> <b>17644</b>                              Nitro-Carb Power Tap                         </td> </tr> <tr> <td> <b>16823</b>                              27/64 Drill Bit                         </td> <td> <b>16825</b>                              29/64 Drill bit                         </td> </tr> </table>	<b>129913</b> HSS Hex Die	<b>129922</b> HSS Hex Die	<b>17643</b> Nitro-Carb Power Tap	<b>17644</b> Nitro-Carb Power Tap	<b>16823</b> 27/64 Drill Bit	<b>16825</b> 29/64 Drill bit	<table border="1"> <tr> <td> <b>129912</b>                              HSS Hex Die                         </td> <td> <b>129921</b>                              HSS Hex Die                         </td> </tr> <tr> <td> <b>17641</b>                              Nitro-Carb Power Tap                         </td> <td> <b>17642</b>                              Nitro-Carb Power Tap                         </td> </tr> <tr> <td> <b>16155</b>                              "U" Drill Bit                         </td> <td> <b>16821</b>                              25/64 Drill Bit                         </td> </tr> </table>	<b>129912</b> HSS Hex Die	<b>129921</b> HSS Hex Die	<b>17641</b> Nitro-Carb Power Tap	<b>17642</b> Nitro-Carb Power Tap	<b>16155</b> "U" Drill Bit	<b>16821</b> 25/64 Drill Bit												
<b>129913</b> HSS Hex Die	<b>129922</b> HSS Hex Die																								
<b>17643</b> Nitro-Carb Power Tap	<b>17644</b> Nitro-Carb Power Tap																								
<b>16823</b> 27/64 Drill Bit	<b>16825</b> 29/64 Drill bit																								
<b>129912</b> HSS Hex Die	<b>129921</b> HSS Hex Die																								
<b>17641</b> Nitro-Carb Power Tap	<b>17642</b> Nitro-Carb Power Tap																								
<b>16155</b> "U" Drill Bit	<b>16821</b> 25/64 Drill Bit																								
<table border="1"> <tr> <td> <b>129910</b>                              HSS Hex Die                         </td> <td> <b>129919</b>                              HSS Hex Die                         </td> <td> <b>129911</b>                              HSS Hex Die                         </td> <td> <b>129920</b>                              HSS Hex Die                         </td> </tr> <tr> <td> <b>17637</b>                              Nitro-Carb Power Tap                         </td> <td> <b>17638</b>                              Nitro-Carb Power Tap                         </td> <td> <b>17639</b>                              Nitro-Carb Power Tap                         </td> <td> <b>17640</b>                              Nitro-Carb Power Tap                         </td> </tr> <tr> <td> <b>16140</b>                              "T" Drill Bit                         </td> <td> <b>16143</b>                              "T" Drill Bit                         </td> <td> <b>16149</b>                              "O" Drill Bit                         </td> <td> <b>16151</b>                              "Q" Drill Bit                         </td> </tr> </table>	<b>129910</b> HSS Hex Die	<b>129919</b> HSS Hex Die	<b>129911</b> HSS Hex Die	<b>129920</b> HSS Hex Die	<b>17637</b> Nitro-Carb Power Tap	<b>17638</b> Nitro-Carb Power Tap	<b>17639</b> Nitro-Carb Power Tap	<b>17640</b> Nitro-Carb Power Tap	<b>16140</b> "T" Drill Bit	<b>16143</b> "T" Drill Bit	<b>16149</b> "O" Drill Bit	<b>16151</b> "Q" Drill Bit	<table border="1"> <tr> <td> <b>129917</b>                              HSS Hex Die                         </td> <td> <b>129908</b>                              HSS Hex Die                         </td> <td> <b>129909</b>                              HSS Hex Die                         </td> <td> <b>129918</b>                              HSS Hex Die                         </td> </tr> <tr> <td> <b>17633</b>                              Nitro-Carb Power Tap                         </td> <td> <b>17634</b>                              Nitro-Carb Power Tap                         </td> <td> <b>17635</b>                              Nitro-Carb Power Tap                         </td> <td> <b>17636</b>                              Nitro-Carb Power Tap                         </td> </tr> <tr> <td> <b>16100</b>                              #21 Drill Bit                         </td> <td> <b>16095</b>                              #16 Drill Bit                         </td> <td> <b>16086</b>                              #7 Drill Bit                         </td> <td> <b>16082</b>                              #3 Drill Bit                         </td> </tr> </table>	<b>129917</b> HSS Hex Die	<b>129908</b> HSS Hex Die	<b>129909</b> HSS Hex Die	<b>129918</b> HSS Hex Die	<b>17633</b> Nitro-Carb Power Tap	<b>17634</b> Nitro-Carb Power Tap	<b>17635</b> Nitro-Carb Power Tap	<b>17636</b> Nitro-Carb Power Tap	<b>16100</b> #21 Drill Bit	<b>16095</b> #16 Drill Bit	<b>16086</b> #7 Drill Bit	<b>16082</b> #3 Drill Bit
<b>129910</b> HSS Hex Die	<b>129919</b> HSS Hex Die	<b>129911</b> HSS Hex Die	<b>129920</b> HSS Hex Die																						
<b>17637</b> Nitro-Carb Power Tap	<b>17638</b> Nitro-Carb Power Tap	<b>17639</b> Nitro-Carb Power Tap	<b>17640</b> Nitro-Carb Power Tap																						
<b>16140</b> "T" Drill Bit	<b>16143</b> "T" Drill Bit	<b>16149</b> "O" Drill Bit	<b>16151</b> "Q" Drill Bit																						
<b>129917</b> HSS Hex Die	<b>129908</b> HSS Hex Die	<b>129909</b> HSS Hex Die	<b>129918</b> HSS Hex Die																						
<b>17633</b> Nitro-Carb Power Tap	<b>17634</b> Nitro-Carb Power Tap	<b>17635</b> Nitro-Carb Power Tap	<b>17636</b> Nitro-Carb Power Tap																						
<b>16100</b> #21 Drill Bit	<b>16095</b> #16 Drill Bit	<b>16086</b> #7 Drill Bit	<b>16082</b> #3 Drill Bit																						
<table border="1"> <tr> <td> <b>129904</b>                              HSS Hex Die                         </td> <td> <b>129905</b>                              HSS Hex Die                         </td> <td> <b>129906</b>                              HSS Hex Die                         </td> <td> <b>129907</b>                              HSS Hex Die                         </td> </tr> <tr> <td> <b>17629</b>                              Nitro-Carb Taper Tap                         </td> <td> <b>17630</b>                              Nitro-Carb Power Tap                         </td> <td> <b>17631</b>                              Nitro-Carb Power Tap                         </td> <td> <b>17632</b>                              Nitro-Carb Power Tap                         </td> </tr> <tr> <td> <b>16122</b>                              #43 Drill Bit                         </td> <td> <b>16115</b>                              #36 Drill Bit                         </td> <td> <b>16108</b>                              #29 Drill Bit                         </td> <td> <b>16104</b>                              #25 Drill Bit                         </td> </tr> </table>	<b>129904</b> HSS Hex Die	<b>129905</b> HSS Hex Die	<b>129906</b> HSS Hex Die	<b>129907</b> HSS Hex Die	<b>17629</b> Nitro-Carb Taper Tap	<b>17630</b> Nitro-Carb Power Tap	<b>17631</b> Nitro-Carb Power Tap	<b>17632</b> Nitro-Carb Power Tap	<b>16122</b> #43 Drill Bit	<b>16115</b> #36 Drill Bit	<b>16108</b> #29 Drill Bit	<b>16104</b> #25 Drill Bit													
<b>129904</b> HSS Hex Die	<b>129905</b> HSS Hex Die	<b>129906</b> HSS Hex Die	<b>129907</b> HSS Hex Die																						
<b>17629</b> Nitro-Carb Taper Tap	<b>17630</b> Nitro-Carb Power Tap	<b>17631</b> Nitro-Carb Power Tap	<b>17632</b> Nitro-Carb Power Tap																						
<b>16122</b> #43 Drill Bit	<b>16115</b> #36 Drill Bit	<b>16108</b> #29 Drill Bit	<b>16104</b> #25 Drill Bit																						

PRODUCT CATEGORY: PT

### Nitro-Carb Power Taps, Hex Dies & Drill Bits with Tools

12 items • 50 Pcs  
IBS No. 591P



Packaged in a Locking Steel Drawer for Easy Storage & Organization



# IBS, INCORPORATED



## Assortments - Taps, Burs & Blades (PT)

ASSORTMENTS

**IBS, Inc.**  
SPECIALTY PRODUCTS FOR MAINTENANCE & REPAIR  
INDUSTRIALBOLT.COM • © • 800-678-1996

Nitro-Carb Plug/Power Taps, Hex Dies  
and Drill Bits with Tools

Assortment No. 592P

 <b>120923</b> Professional Tap Wrench		 <b>120926</b> Professional 1-7/16 Hex Die Wrench	
<b>129916</b> 3/4-10 HSS Hex Die <b>17649</b> Nitro-Carb Power Tap <b>16842</b> 21/32 Drill Bit	<b>129925</b> 3/4-16 HSS Hex Die <b>17650</b> Nitro-Carb Power Tap <b>16844</b> 11/16 Drill Bit	<b>129915</b> 5/8-11 HSS Hex Die <b>17647</b> Nitro-Carb Power Tap <b>16834</b> 17/32 Drill Bit	<b>129924</b> 5/8-18 HSS Hex Die <b>17648</b> Nitro-Carb Power Tap <b>16836</b> 9/16 Drill Bit
<b>129914</b> 9/16-12 HSS Hex Die <b>17645</b> Nitro-Carb Plug Tap <b>16827</b> 31/64 Drill Bit	<b>129923</b> 9/16-18 HSS Hex Die <b>17646</b> Nitro-Carb Plug Tap <b>16828</b> 1/2 Drill Bit		

PRODUCT CATEGORY: PT

**Nitro-Carb Power Taps, Hex Dies & Drill Bits with Tools**  
 18 items • 20 Pcs  
 IBS No. 592P





Packaged in a Locking Steel Drawer  
for Easy Storage & Organization

**IBS, Inc.**  
SPECIALTY PRODUCTS FOR MAINTENANCE & REPAIR  
INDUSTRIALBOLT.COM • © • 800-678-1996

Metric Nitro-Carb Power Taps,  
Hex Dies and Drill Bits w/ Tools

Assortment No. 593P

 <b>120925</b> Professional 1 Hex Die Wrench		 <b>120926</b> Professional 1 Hex Die Wrench	
 <b>120922</b> Professional Tap Wrench			
<b>129934</b> M10-1.5 Nitro-Carb Hex Die <b>17711</b> Nitro-Carb Power Tap <b>17919</b> 5.5mm Nitro-Carb Drill Bit	<b>129935</b> M12-1.75 Nitro-Carb Hex Die <b>17712</b> Nitro-Carb Power Tap <b>17936</b> 10.2mm Nitro-Carb Drill Bit	<b>129931</b> M6-1.0 Nitro-Carb Hex Die <b>17709</b> Nitro-Carb Power Tap <b>17884</b> 5mm Nitro-Carb Drill Bit	<b>129933</b> M8-1.25 Nitro-Carb Hex Die <b>17710</b> Nitro-Carb Power Tap <b>17901</b> 6.7mm Nitro-Carb Drill Bit
<b>129929</b> M4-0.7 Nitro-Carb Hex Die <b>17707</b> Nitro-Carb Power Tap <b>17867</b> 3.3mm Nitro-Carb Drill Bit	<b>129930</b> M5-0.8 Nitro-Carb Hex Die <b>17708</b> Nitro-Carb Power Tap <b>17876</b> 4.2mm Nitro-Carb Drill Bit	<b>M2.5-0.45</b> <b>17704</b> Nitro-Carb Power Tap <b>17854</b> 2.05mm Nitro-Carb Drill Bit	<b>M3-0.5</b> <b>129928</b> Nitro-Carb Hex Die <b>17705</b> Nitro-Carb Power Tap <b>17859</b> 2.5mm Nitro-Carb Drill Bit
		<b>M3.5-0.6</b> <b>135590</b> Nitro-Carb Hex Die <b>17706</b> Nitro-Carb Power Tap <b>17863</b> 2.9mm Nitro-Carb Drill Bit	

PRODUCT CATEGORY: PT

**Metric Nitro-Carb Power Taps, Hex Dies & Drill Bits with Tools**  
 29 items • 29 Pcs  
 IBS No. 593P











Packaged in a Locking Steel Drawer  
for Easy Storage & Organization

**IBS, Inc.**  
SPECIALTY PRODUCTS FOR MAINTENANCE & REPAIR  
INDUSTRIALBOLT.COM • © • 800-678-1996

Maxi-Sharp Files

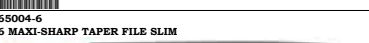
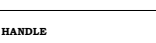
Assortment No. 699R

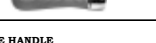
<b>65018-10</b> 10 MAXI-SHARP ALL PURPOSE 	<b>65019-10</b> 10 MAXI-SHARP FLAT MULTI-KUT 
<b>65001-10</b> 10 MAXI-SHARP FLAT FILE 	<b>65003-10</b> 10 MAXI-SHARP 1/2 RD FILE 
<b>65000-10</b> 10 MAXI-SHARP MILL FILE 	
<b>65002-10</b> 10 MAXI-SHARP ROUND FILE 	
<b>65004-6</b> 6 MAXI-SHARP TAPER FILE SLIM 	<b>65008-6</b> 6 SCRUZ-ON FILE HANDLE 
<b>65009</b> FILE CARD WITH BRUSH 	<b>65008-10</b> 10 SCRUZ-ON FILE HANDLE 

PRODUCT CATEGORY: PT

**Maxi Sharp Files**  
 10 items • 12 Pcs  
 IBS No. 699R



Packaged in a Locking Steel Drawer  
for Easy Storage & Organization

# IBS, INCORPORATED















## Assortments - Taps, Burs & Blades (PT)



**IBS, Inc.**  
SPECIALTY PRODUCTS FOR MAINTENANCE & REPAIR  
INDUSTRIALHOLEY.COM • • • 800-675-1506

**Advanced Bi-Metal Hole Saws**  
5/8" to 2"

Assortment No. 729R

29201 5/8 HOLE SAW ADVANCED EDGE 	29209 1-1/8 HOLE SAW ADVANCED EDGE 	29217 1-5/8 HOLE SAW ADVANCED EDGE 	29036 LSS 4 H.S. ARBOR 
29203 3/4 HOLE SAW ADVANCED EDGE 	29211 1-1/4 HOLE SAW ADVANCED EDGE 	29219 1-3/4 HOLE SAW ADVANCED EDGE 	29034 LSS 2 H.S. ARBOR 
29205 7/8 HOLE SAW ADVANCED EDGE 	29213 1-3/8 HOLE SAW ADVANCED EDGE 	29222 2" HOLE SAW ADVANCED EDGE 	29039 1/4 PILOT DRILL 
29207 1" HOLE SAW ADVANCED EDGE 	29215 1-1/2 HOLE SAW ADVANCED EDGE 		

PRODUCT CATEGORY: PT

**Advanced Bi-Metal Hole Saws**  
5/8" to 2"  
14 items • 15 Pcs  
IBS No. 729R











Packaged in a Locking Steel Drawer for Easy Storage & Organization

**IBS, Inc.**  
SPECIALTY PRODUCTS FOR MAINTENANCE & REPAIR  
INDUSTRIALHOLEY.COM • • • 800-675-1506

**Advanced Bi-Metal Hole Saws**  
2-1/8" to 4"

Assortment No. 730R

29224 2-1/8 HOLE SAW ADVANCED EDGE 	29228 2-1/2 HOLE SAW ADVANCED EDGE 	29237 3-1/2 HOLE SAW ADVANCED EDGE 	29034 LSS 2 H.S. ARBOR 
29225 2-1/4 HOLE SAW ADVANCED EDGE 	29233 3" HOLE SAW ADVANCED EDGE 	29241 4" HOLE SAW ADVANCED EDGE 	29039 1/4 PILOT DRILL 

PRODUCT CATEGORY: PT

**Advanced Bi-Metal Hole Saws**  
2-1/8" to 4"  
8 Items • 8 Pcs  
IBS No. 730R





















Packaged in a Locking Steel Drawer for Easy Storage & Organization

**IBS, Inc.**  
SPECIALTY PRODUCTS FOR MAINTENANCE & REPAIR  
INDUSTRIALHOLEY.COM • • • 800-675-1506

**Advanced Bi-Metal Hole Saws 3/4" to 4"**

Assortment No. 731R

29203 3/4 HOLE SAW ADVANCED EDGE 	29217 1-5/8 HOLE SAW ADVANCED EDGE 	29225 2-1/4 HOLE SAW ADVANCED EDGE 	29237 3-1/2 HOLE SAW ADVANCED EDGE 
29207 1" HOLE SAW ADVANCED EDGE 	29219 1-3/4 HOLE SAW ADVANCED EDGE 	29228 2-1/2 HOLE SAW ADVANCED EDGE 	29241 4" HOLE SAW ADVANCED EDGE 
29209 1-1/8 HOLE SAW ADVANCED EDGE 	29222 2" HOLE SAW ADVANCED EDGE 	29233 3" HOLE SAW ADVANCED EDGE 	29036 LSS 4 H.S. ARBOR 
29211 1-1/4 HOLE SAW ADVANCED EDGE 	29224 2-1/8 HOLE SAW ADVANCED EDGE 		29034 LSS 2 H.S. ARBOR 
29213 1-3/8 HOLE SAW ADVANCED EDGE 			29039 1/4 PILOT DRILL 
29215 1-1/2 HOLE SAW ADVANCED EDGE 			

PRODUCT CATEGORY: PT

**Advanced Bi-Metal Hole Saws 3/4" to 4"**  
18 Items • 19 Pcs  
IBS No. 731R



Packaged in a Locking Steel Drawer for Easy Storage & Organization

ASSORTMENTS



# IBS, INCORPORATED

## Assortments - Taps, Burs & Blades (PT)

ASSORTMENTS

<b>IBS, Inc.</b> <small>SPECIALTY PRODUCTS FOR MAINTENANCE &amp; REPAIR  INDUSTRIALBOLT.COM © &amp; © 800-670-1906</small>			
<b>Carbide Tipped Cutters</b> 3/16" Depth Assortment No. 762R			
19205 7/8 CARBIDE TIPPED CUTTER - 3/16" DEPTH  	19209 1-1/8 CARBIDE TIPPED CUTTER - 3/16" DEPTH  	19213 1-3/8 CARBIDE TIPPED CUTTER - 3/16" DEPTH  	19219 1-3/4 CARBIDE TIPPED CUTTER - 3/16" DEPTH  
19223 2" CARBIDE TIPPED CUTTER - 3/16" DEPTH  			

PRODUCT CATEGORY: PT

**Carbide Tipped Cutters**  
1" Depth  
**5 Items • 5 Pcs**  
**IBS No. 762R**



Packaged in a Locking Steel Drawer for Easy Storage & Organization

<b>IBS, Inc.</b> <small>SPECIALTY PRODUCTS FOR MAINTENANCE &amp; REPAIR  INDUSTRIALBOLT.COM © &amp; © 800-670-1906</small>			
<b>Carbide Tipped Cutters</b> 1" Depth Assortment No. 763R			
19250 5/8 CARBIDE TIPPED CUTTER - 1" DEPTH  	19252 3/4 CARBIDE TIPPED CUTTER - 1" DEPTH  	19254 7/8 CARBIDE TIPPED CUTTER - 1" DEPTH  	19256 1" CARBIDE TIPPED CUTTER - 1" DEPTH  

PRODUCT CATEGORY: PT

**Carbide Tipped Cutters**  
1" Depth  
**4 Items • 4 Pcs**  
**IBS No. 763R**



Packaged in a Locking Steel Drawer for Easy Storage & Organization

<b>IBS, Inc.</b> <small>SPECIALTY PRODUCTS FOR MAINTENANCE &amp; REPAIR  INDUSTRIALBOLT.COM © &amp; © 800-670-1906</small>			
<b>Carbide Tipped Cutters</b> 1" Depth Assortment No. 764R			
19254 7/8 CARBIDE TIPPED CUTTER - 1" DEPTH  	19258 1-1/8 CARBIDE TIPPED CUTTER - 1" DEPTH  	19262 1-3/8 CARBIDE TIPPED CUTTER - 1" DEPTH  	19268 1-3/4 CARBIDE TIPPED CUTTER - 1" DEPTH  
19272 2" CARBIDE TIPPED CUTTER - 1" DEPTH  			

PRODUCT CATEGORY: PT

**Carbide Tipped Cutters**  
**IBS No. 764R**  
1" Depth  
**5 Items • 5 Pcs**



Packaged in a Locking Steel Drawer for Easy Storage & Organization

# IBS, INCORPORATED

## Assortments - Taps, Burs & Blades (PT)



**IBS, Inc.**  
SPECIALTY PRODUCTS FOR MAINTENANCE & REPAIR  
INDUSTRIALBOLT.COM • 800-678-1566

**Advanced Bi-Metal Hole Saws 5/8" to 2" with Rapid Core Ejecting Arbors**  
Assortment No. 782R

29201 5/8 HOLE SAW ADVANCED EDGE	29209 1-1/8 HOLE SAW ADVANCED EDGE	29217 1-5/8 HOLE SAW ADVANCED EDGE	29050 RAPID CORE EJECTING ARBOR FOR 1-1/4 TO 6 HOLE SAWS
29203 3/4 HOLE SAW ADVANCED EDGE	29211 1-1/4 HOLE SAW ADVANCED EDGE	29219 1-3/4 HOLE SAW ADVANCED EDGE	
29205 7/8 HOLE SAW ADVANCED EDGE	29213 1-3/8 HOLE SAW ADVANCED EDGE	29051 RAPID CORE EJECTING ARBOR FOR 9/16 - 1-3/16 DIAM HOLE SAWS	
29207 1" HOLE SAW ADVANCED EDGE	29215 1-1/2 HOLE SAW ADVANCED EDGE	29052 PILOT DRILL BIT FOR 29050	
			29053 PILOT DRILL BIT FOR 29051

PRODUCT CATEGORY: PT

### Advanced Bi-Metal Hole Saws

5/8" to 2" with Rapid Core Ejecting Arbors  
15 Items • 15 Pcs  
IBS No. 782R



Packaged in a Locking Steel Drawer for Easy Storage & Organization

**IBS, Inc.**  
SPECIALTY PRODUCTS FOR MAINTENANCE & REPAIR  
INDUSTRIALBOLT.COM • 800-678-1566

**Advanced Bi-Metal Hole Saws 2-1/8" to 4" with Rapid Core Ejecting Arbors**  
Assortment No. 783R

29224 2-1/8 HOLE SAW ADVANCED EDGE	29228 2-1/2 HOLE SAW ADVANCED EDGE	29237 3-1/2 HOLE SAW ADVANCED EDGE	29050 RAPID CORE EJECTING ARBOR FOR 1-1/4 TO 6 DIAM. HOLE SAWS
29225 2-1/4 HOLE SAW ADVANCED EDGE	29233 3" HOLE SAW ADVANCED EDGE	29241 4" HOLE SAW ADVANCED EDGE	
			29052 PILOT DRILL FOR 29050

PRODUCT CATEGORY: PT

### Advanced Bi-Metal Hole Saws

2-1/8" to 4" with Rapid Core Ejecting Arbors  
8 Items • 8 Pcs  
IBS No. 783R



Packaged in a Locking Steel Drawer for Easy Storage & Organization

**IBS, Inc.**  
SPECIALTY PRODUCTS FOR MAINTENANCE & REPAIR  
INDUSTRIALBOLT.COM • 800-678-1566

**Advanced Bi-Metal Hole Saws 3/4" to 4" with Rapid Core Ejecting Arbors**  
Assortment No. 784R

29203 3/4 HOLE SAW ADVANCED EDGE	29217 1-5/8 HOLE SAW ADVANCED EDGE	29225 2-1/4 HOLE SAW ADVANCED EDGE	29241 4" HOLE SAW ADVANCED EDGE
29207 1" HOLE SAW ADVANCED EDGE	29219 1-3/4 HOLE SAW ADVANCED EDGE	29228 2-1/2 HOLE SAW ADVANCED EDGE	
29209 1-1/8 HOLE SAW ADVANCED EDGE	29233 3" HOLE SAW ADVANCED EDGE	29050 RAPID CORE EJECTING ARBOR 1-1/4 - 6 DIAM HOLE SAW	
29211 1-1/4 HOLE SAW ADVANCED EDGE	29222 2" HOLE SAW ADVANCED EDGE	29237 3-1/2 HOLE SAW ADVANCED EDGE	29051 RAPID CORE EJECTING ARBOR FOR 9/16 - 1-3/16 DIAM HOLE SAW
29213 1-3/8 HOLE SAW ADVANCED EDGE	29224 2-1/8 HOLE SAW ADVANCED EDGE	29052 PILOT DRILL FOR 29050	29053 PILOT DRILL FOR 29051
29215 1-1/2 HOLE SAW ADVANCED EDGE			

PRODUCT CATEGORY: PT

### Advanced Bi-Metal Hole Saws 3/4" to 4"

3/4" to 4" with Rapid Core Ejecting Arbors  
18 Items • 19 Pcs  
IBS No. 784R



Packaged in a Locking Steel Drawer for Easy Storage & Organization

ASSORTMENTS



# IBS, INCORPORATED

## Assortments - Taps, Burs & Blades (PT)

A  
S  
S  
O  
R  
T  
M  
E  
N  
T  
S

**IBS, Inc.**  
SPECIALTY PRODUCTS FOR MAINTENANCE & REPAIR  
INDUSTRIALBOLT.COM © © © 800-678-1996

Hi-Alloy Bi-Metal Hacksaw Blades

Assortment No. 785R

16395 12 18/14 HI-ALLOY HACKSAW BLADE	
16396 12 24/20 HI-ALLOY HACKSAW BLADE	
16398 12 32/26 HI-ALLOY HACKSAW BLADE	
16399 12 18/24/32 TRIPLE CUT BIMETAL HACKSAW BLADE	

PRODUCT CATEGORY: PT

### Hi-Alloy Bi-Metal Hacksaw Blades

4 Items • 20 Pcs  
IBS No. 785R



Packaged in a Locking Steel Drawer  
for Easy Storage & Organization

**IBS, Inc.**  
SPECIALTY PRODUCTS FOR MAINTENANCE & REPAIR  
INDUSTRIALBOLT.COM © © © 800-678-1996

Bore Blades and Demolition Blades

Assortment No. 801R

446710 6' 6X10TPI BORE BLADE. For metal and wood cutting.		448711 8' 10X14TPI BORE BLADE. For metal and wood cutting.	
446711 6' 14X18TPI BORE BLADE. For metal and wood cutting.		4410710 10' 8/12X10TPI BORE BLADE. For metal and wood cutting.	
448710 8' 6X10TPI BORE BLADE. For metal and wood cutting.		460906 9 X .062 6TPI DEMOLITION BIMETAL RECIP BLADE Specially designed for the toughest demolition jobs. Cuts all woods, nail-embedded wood and metals.	
460910 9 X .062 10TPI DEMOLITION BIMETAL RECIP BLADE Specially designed for the toughest demolition jobs. Cuts all woods, nail-embedded wood and metals.			
461206 12 X .062 6TPI DEMOLITION BIMETAL RECIP BLADE Specially designed for the toughest demolition jobs. Cuts all woods, nail-embedded wood and metals.			
461210 12 X .062 10TPI DEMOLITION BIMETAL RECIP BLADE Specially designed for the toughest demolition jobs. Cuts all woods, nail-embedded wood and metals.			

PRODUCT CATEGORY: PT

### Bore Blades & Demolition Blades

9 Items • 18 Pcs  
IBS No. 801R



Packaged in a Locking Steel Drawer  
for Easy Storage & Organization

**IBS, Inc.**  
SPECIALTY PRODUCTS FOR MAINTENANCE & REPAIR  
INDUSTRIALBOLT.COM © © © 800-678-1996

Advanced Edge Power Reciprocating Saw Blades

Assortment No. 840R

470610 6IN X .042 10TPI ADVANDED EDGE POWER RECIP BLADE 1IN WIDTH		470910 9IN X .042 10TPI ADVANDED EDGE POWER RECIP BLADE 1IN WIDTH	
471210 12IN X .042 10TPI ADVANDED EDGE POWER RECIP BLADE 1IN WIDTH			
470614 6IN X .042 14TPI ADVANDED EDGE POWER RECIP BLADE 1IN WIDTH		470914 9IN X .042 14TPI ADVANDED EDGE POWER RECIP BLADE 1IN WIDTH	
471214 12IN X .042 14TPI ADVANDED EDGE POWER RECIP BLADE 1IN WIDTH			
470618 6IN X .042 18TPI ADVANDED EDGE POWER RECIP BLADE 1IN WIDTH		470918 9IN X .042 18TPI ADVANDED EDGE POWER RECIP BLADE 1IN WIDTH	
471218 12IN X .042 18TPI ADVANDED EDGE POWER RECIP BLADE 1IN WIDTH		74172 TOOL EASE	

PRODUCT CATEGORY: PT

### Advanced Edge Power Reciprocating Saw Blades with Tool Ease Lubricant Stick

10 Items • 21 Pcs  
IBS No. 840R



Packaged in a Locking Steel Drawer  
for Easy Storage & Organization



<b>Nylon Insulated Double Grip Solderless Terminal</b> <span style="float: right;">101R</span>					
61-SN 22-18 BUTT CONNECTOR	11-6SNB 22-18 X #6 RING TERMINAL	11-8SNB 22-18 X #8 RING TERMINAL	11-10NB 22-18 X #10 RING TERMINAL	31-10NB 22-18 X #10 SPADE TERMINAL	72F-250-32-NBL 16-14 FEMALE QUICK SLIDE
62-SN 16-14 BUTT CONNECTOR	12-6SNB 16-14 X #6 RING TERMINAL	12-10NB 16-14 X #10 RING TERMINAL	12-14SNB 16-14 X 1/4" RING TERMINAL	32-10NB 16-14 X #10 SPADE TERMINAL	72M-250-32-NBL 16-14 MALE QUICK SLIDE
63-SN 12-10 BUTT CONNECTOR	82F-156-NBL 16-14 FEMALE BULLET	82M-156-NB 12-10 MALE BULLET	33-10NB 12-10 X #10 SPADE TERMINAL	13-8SNB 12-10 X #8 RING TERMINAL	73M-250-32-NBL 12-10 MALE QUICK SLIDE
13-10NB 12-10 X #10 RING TERMINAL	13-14SNB 12-10 X 1/4" RING TERMINAL	13-56SNB 12-10 X 5/16" RING TERMINAL	13-38SNB 12-10 X 3/8" RING TERMINAL	13-500NB 12-10 X 1/2" RING TERMINAL	73F-250-32-NBL 12-10 FEMALE QUICK SLIDE

PRODUCT CATEGORY: Q

<b>Nylon Tie Wraps</b> <span style="float: right;">Assortment No. 107R</span>	
15" 120lb. Black Nylon Tie B-14-120	
14-1/2" 50 lb. Black Nylon Tie B-14-50	
4" 18 lb. Black Nylon Tie B-4-18	
11" 50 lb. Black Nylon Tie B-11-50	
7-1/2" 50 lb. Clear Nylon Tie L-7-50	
8" 50 lb. Mountng Tie MH-7-50	
5-1/2" 40 lb. Clear Nylon Tie L-5-30	
7-1/2" 50 lb. Black Nylon Tie B-7-50	
4" 18 lb. Clear Nylon Tie L-4-18	
5-1/2" 40 lb. Black Nylon Tie B-5-30	

PRODUCT CATEGORY: Q

<b>Crimp &amp; Seal Terminals w/ Torch &amp; Butane Refill</b> <span style="float: right;">Assortment No. 109R</span>					
			B5223 16-14 CRIMP & SEAL #8 RING TERM	B5224 16-14 CRIMP & SEAL #10 RING TERM	125738 + 95007 MICROTORCH BUTANE TORCH + REFILL
B5225 16-14 CRIMP & SEAL 1/4 RING TERM	B5228 16-14 CRIMP & SEAL #10 SPADE TERM	B5245 16-14 CRIMP & SEAL .250 FEMALE CONN	B5255 16-14 CRIMP & SEAL .250 MALE CONN	B5265 16-14 CRIMP & SEAL .156 MALE BULLET	
B5275 16-14 CRIMP & SEAL .156 FEMALE BULLET	B5324 16-10 CRIMP & SEAL #10 RING TERM	B5325 12-10 CRIMP & SEAL 1/4 RING TERM	B5327 12-10 CRIMP & SEAL 3/8 RING TERM	B5345 12-10 CRIMP & SEAL .250 FEMALE CONN	B280 22-18 SOLDER&SEAL SHRINK TUBE
B5355 12-10 CRIMP & SEAL .250 MALE CONN	B5110 20-18 CRIMP & SEAL BUTT CONNECTOR	B5210 16-14 CRIMP & SEAL BUTT CONNECTOR	B5310 12-10 CRIMP & SEAL BUTT CONNECTOR	B5100 22-24 CRIMP & SEAL BUTT CONNECTOR	B281 16-14 SOLDER&SEAL SHRINK TUBE
					B282 12-10 SOLDER&SEAL SHRINK TUBE

PRODUCT CATEGORY: Q

### Nylon Insulated Double Grip Solderless Terminals

24 Items • 270 Pcs  
IBS No. 101R



Packaged in a Locking Steel Drawer for Easy Storage & Organization

### Nylon Tie Wraps

10 Items • 750 Pcs  
IBS No. 107R



Packaged in a Locking Steel Drawer for Easy Storage & Organization

### Crimp & Seal Terminals w/ Torch & Butane Refill

21 Items • 315 Pcs  
IBS No. 109R



Packaged in a Locking Steel Drawer for Easy Storage & Organization

ASSORTMENTS



# IBS, INCORPORATED

## Assortments - Electrical (Q)

ASSORTMENTS

IBS, Inc. SPECIALTY PRODUCTS FOR MAINTENANCE & REPAIR INDUSTRIALBOLT.COM © & © 800-878-1906		ECOMAX Post Top Battery Terminals		
Assortment No. 129P				
E2107 ECOMAX BATT TERM 1-2 GA NEG 	E2111 ECOMAX BATT. TERM 2/0 GA. NEG. 	E2309 ECOMAX BATT. TERM. RT. EL. 1/0 NEG. 	B1110 5/16 X 1-1/4 TIN PLTD BATT 	
E2108 ECOMAX BATTERY TERM 1-2 GA POSITIVE 	E2112 ECOMAX BATT. TERM. 2/0 GA. POS. 	E2310 ECOMAX BATT. TERM. RT. EL. 1/0 POS. 		
E2109 ECOMAX BATT TERM 1/0 GA NEG 	E2113 ECOMAX BATT. TERM. 3/0 GA. NEG. 	E2311 ECOMAX BATT. TERM. RT. EL. 2/0 NEG. 	E2411 ECOMAX BATT. TERM. LT. EL. 2/0 NEG. 	E2211 ECOMAX BATT. TERM. FLAG 2/0 NEG. 
E2110 ECOMAX BATT TERM 1/0 GA POS 	E2114 ECOMAX BATT. TERM. 3/0 GA. POS. 	E2312 ECOMAX BATT. TERM. RT. EL. 2/0 POS. 	E2412 ECOMAX BATT. TERM. LT. EL. 2/0 POS. 	E2212 ECOMAX BATT. TERM. FLAG 2/0 POS. 

PRODUCT CATEGORY: Q

### ECOMAX Post Top Battery Terminals

17 Items • 69 Pcs

IBS No. 129P



Packaged in a Locking Steel Drawer  
for Easy Storage & Organization

IBS, Inc. SPECIALTY PRODUCTS FOR MAINTENANCE & REPAIR INDUSTRIALBOLT.COM © & © 800-878-1906		Rubber Insulated & Nylon Clamps		
Assortment No. 141R				
7120A 1/4 NYLON CLAMP 	7122A 3/8 NYLON CLAMP 	7124A 1/2 NYLON CLAMP 	7126A 5/8 NYLON CLAMP 	
7314A 1/4 INSULATED CLAMP 1/4 STUD STAMP #4 	7315A 3/8 INSULATED CLAMP 1/4 STUD STAMP #6 	7316A 1/2 INSULATED CLAMP 1/4 STUD STAMP #8 	7318A 3/4 INSULATED CLAMP 1/4 STUD STAMP #12 	
7320A 1 INSULATED CLAMP 1/4 STUD STAMP #16 	7322A 1-1/4 INSULATED CLAMP 1/4 STUD STAMP #20 	7324A 1-1/2 INSULATED CLAMP 1/4 STUD STAMP #24 	7514A 1/4 INSULATED CLAMP 3/8 STUD STAMP #4 	
7516A 1/2 INSULATED CLAMP 3/8 STUD STAMP #8 	7518A 3/4 INSULATED CLAMP 3/8 STUD STAMP #12 	7520A 1 INSULATED CLAMP 3/8 STUD STAMP #16 	7522A 1-1/4 INSULATED CLAMP 3/8 STUD STAMP #18 	

PRODUCT CATEGORY: Q

### Rubber Insulated & Nylon Clamps

16 Items • 230 Pcs

IBS No. 141R



Packaged in a Locking Steel Drawer  
for Easy Storage & Organization

IBS, Inc. SPECIALTY PRODUCTS FOR MAINTENANCE & REPAIR INDUSTRIALBOLT.COM © & © 800-878-1906		Nylon Clamps		
Assortment No. 145R				
7118A 1/8 NYLON CLAMP 	7119A 3/16 NYLON CLAMP 	7120A 1/4 NYLON CLAMP 		
7121A 5/16 NYLON CLAMP 	7122A 3/8 NYLON CLAMP 	7123A 7/16 NYLON CLAMP 		
7124A 1/2 NYLON CLAMP 	7125A 9/16 NYLON CLAMP 	7126A 5/8 NYLON CLAMP 		
7128A 3/4 NYLON CLAMP 	7129A 7/8 NYLON CLAMP 	7130A 1 NYLON CLAMP 		

PRODUCT CATEGORY: Q

### Nylon Clamps













12 Items • 525 Pcs

IBS No. 145R



Packaged in a Locking Steel Drawer  
for Easy Storage & Organization



 <b>Rubber Insulated Clamps</b> 1/4" Mounting Hole		
Assortment No. 146R		
7314A 1/4 INSULATED CLAMP 1/4 STUD STAMP #4 	7315A 3/8 INSULATED CLAMP 1/4 STUD STAMP #6 	7316A 1/2 INSULATED CLAMP 1/4 STUD STAMP #8 
7317A 5/8 INSULATED CLAMP 1/4 STUD STAMP #10 	7318A 3/4 INSULATED CLAMP 1/4 STUD STAMP #12 	7319A 7/8 INSULATED CLAMP 1/4 STUD STAMP #14 
7320A 1 INSULATED CLAMP 1/4 STUD STAMP #16 	7321A 1-1/8 INSULATED CLAMP 1/4 STUD STAMP #18 	7322A 1-1/4 INSULATED CLAMP 1/4 STUD STAMP #20 
7323A 1-3/8 INSULATED CLAMP 1/4 STUD STAMP #22 	7324A 1-1/2 INSULATED CLAMP 1/4 STUD STAMP #24 	7325A 1-5/8 INSULATED CLAMP 1/4 STUD STAMP #26 









PRODUCT CATEGORY: Q

### Rubber Insulated Clamps

1/4" Mounting Hole  
 12 Items • 90 Pcs  
 IBS No. 146R



Packaged in a Locking Steel Drawer  
 for Easy Storage & Organization

 <b>Rubber Insulated Clamps</b> 3/8" Mounting Hole		
Assortment No. 147R		
7514A 1/4 INSULATED CLAMP 3/8 STUD STAMP #4 	7515A 3/8 INSULATED CLAMP 3/8 STUD STAMP #6 	7516A 1/2 INSULATED CLAMP 3/8 STUD STAMP #8 
7517A 5/8 INSULATED CLAMP 3/8 STUD STAMP #10 	7518A 3/4 INSULATED CLAMP 3/8 STUD STAMP #12 	7519A 7/8 INSULATED CLAMP 3/8 STUD STAMP #14 
7520A 1 INSULATED CLAMP 3/8 STUD STAMP #16 	7522A 1-1/4 INSULATED CLAMP 3/8 STUD STAMP #18 	



















PRODUCT CATEGORY: Q

### Rubber Insulated Clamps

3/8" Mounting Hole  
 8 Items • 75 Pcs  
 IBS No. 147R



Packaged in a Locking Steel Drawer  
 for Easy Storage & Organization

 <b>Heavy Duty Wire Ends</b> for #8, #6 & #4 GA Wire				
Assortment No. 159R				
64-WP #8 BUTT CONNECTOR VINYL 	65-WP #6 BUTT CONNECTOR VINYL 	66-WP #4 BUTT CONNECTOR VINYL 		
16-10-WN #4 RING TERM. 10 STUD NYLON 	16-14-WN #4 RING TERM. 1/4 STUD NYLON 	16-56-WN #4 RING TERM. 5/16 STUD NYLON 	16-38-WN #4 RING TERM. 3/8 STUD NYLON 	16-500S-WN #4 RING TERM 1/2 STUD NYLON 
15-10S-WN #6 RING TERM. 10 STUD NYLON 	15-14S-WN #6 RING TERM 1/4 STUD NYLON 	15-56-WN #6 RING TERM. 5/16 STUD NYLON 	15-38-WN #6 RING TERM 3/8 STUD NYLON 	15-500S-WN #6 RING TERM 1/2 STUD NYLON 
14-10S-WN #8 RING TERM. 10 STUD NYLON 	14-14S-WN #8 RING TERM. 1/4 STUD NYLON 	14-56-WN #8 RING TERM. 5/16 STUD NYLON 	14-38-WN #8 RING TERM. 3/8 STUD NYLON 	14-500S-WN #8 RING TERM. 1/2 STUD NYLON 

PRODUCT CATEGORY: Q

### Heavy Duty Wire Ends

for #8, #6 & #4 GA Wire  
 18 Items • 180 Pcs  
 IBS No. 159R



Packaged in a Locking Steel Drawer  
 for Easy Storage & Organization

ASSORTMENTS



# IBS, INCORPORATED

## Assortments - Electrical (Q)

ASSORTMENTS

**IBS, Inc.**  
SPECIALTY PRODUCTS FOR MAINTENANCE & REPAIR  
INDUSTRIALMOLTY.COM • • • 800-678-1906

**Wire Nuts**  
Assortment No. 198R

6X682 GRAY WIRE NUTS	6X683 BLUE WIRE NUT/REPLACES BLK	6X684 ORANGE WIRE NUTS	6X685 YELLOW WIRE NUT	6X686 RED WIRE NUT	TH450 AUTO WIRE CRIMPER/STRIPPER
6X687 YELLOW WIRE NUT WINGED	6X688 RED WIRE NUT WINGED	6X689 GRAY WIRE NUT WINGED	6X690 BLUE WIRE NUT WINGED	6X691 TAN WIRE NUT WINGED	
6X692 GREEN GROUNDING WIRE NUT WINGED					
973 O/B MULTI WIRE NUT	974 RED/YELLOW MULTI WIRE NUT	975 BLUE / GRAY MULTI WIRE NUT			

PRODUCT CATEGORY: Q

**Wire Nuts**  
15 Items • 256 Pcs  
IBS No. 198R



Packaged in a Locking Steel Drawer for Easy Storage & Organization

**IBS, Inc.**  
SPECIALTY PRODUCTS FOR MAINTENANCE & REPAIR  
INDUSTRIALMOLTY.COM • • • 800-678-1906

**Wall Nuts & Lever Nuts**  
Assortment No. 199R

773-162 2 WIRE WALL NUT	773-164 4 WIRE WALL NUT	773-166 6 WIRE WALL NUT	773-168 8 WIRE WALL NUT	773-173 3 WIRE WALL NUT	TH450 AUTO WIRE CRIMPER/STRIPPER
222-412 2 WIRE LEVER NUT	222-413 3 WIRE LEVER NUT	222-415 5 WIRE LEVER NUT			
221-2401 INLINE SPlice CLEAR LEVER NUT	221-412 2 WIRE CLEAR LEVER NUT	221-413 3 WIRE CLEAR LEVER NUT	221-415 5 WIRE CLEAR LEVER NUT		

PRODUCT CATEGORY: Q

**Wall Nuts & Lever Nuts**

13 Items • 106 Pcs  
IBS No. 199R



Packaged in a Locking Steel Drawer for Easy Storage & Organization

**IBS, Inc.**  
SPECIALTY PRODUCTS FOR MAINTENANCE & REPAIR  
INDUSTRIALMOLTY.COM • • • 800-678-1906

**Vinyl Insulated Solderless Terminals**  
Assortment No. 201R

61-P 22-18 BUTT CONN VINYL	11-6P 22-18 RING TERM #6 STUD VINYL	11-8P 22-18 RING TERM #8 STUD VINYL	11-10P 22-18 RING TERM #10 STUD VINYL	31-10P 22-18 SPADE TERM #10 STUD	72P-250-32P 16-14 FEMALE QIK SLIDE VINYL
62-P 16-14 BUTT CONN VINYL	12-6P 16-14 RING TERM #6 STUD VINYL	12-10-P 16-14 RING TERM 10 STUD VINYL	12-14SP 16-14 RING TERM 1/4 STUD VINYL	32-10P 16-14 SPADE TERM 10 STUD VINYL	72M-250-32P 16-14 MALE QIK SLIDE VINYL
63-P 12-10 BUTT CONN VINYL	82F-156-NL 16-14 FEMALE SNAP PLUG VINYL	82M-156P 16-14 MALE SNAP PLUG VINYL	33-10P 12-10 SPADE TERM #10 STUD	13-8P 12-10 RING TERM #8 STUD VINYL	73M-250-32P 12-10 MALE QIK SLIDE VINYL
13-10P 12-10 RING TERM 10 STUD VINYL	13-14SP 12-10 RING TERM 1/4 STUD VINYL	13-56P 12-10 RING TERM 5/16 STUD VINYL	13-38P 12-10 RING TERM 3/8 STUD VINYL	13-500P 12-10 RING TERM 1/2 STUD VINYL	73F-250-32P 12-10 FEMALE QIK SLIDE VINYL

PRODUCT CATEGORY: Q











**Vinyl Insulated Solderless Terminals**

24 Items • 515 Pcs  
IBS No. 201R



Packaged in a Locking Steel Drawer for Easy Storage & Organization



IBS, Inc. SPECIALTY PRODUCTS FOR MAINTENANCE & REPAIR INDUSTRIALBOLT.COM © © © 800-678-1506		EcoMax Terminals Heavy Duty Lugs & Splices	
Assortment No. 202P			
BAL1038 1/0 X 3/8ST HVY DUTY TUBULAR LUG 	BAL1012 BATT TERM 1/0 X 1/2 STUD LUG HEAVY DUTY TUBULAR 	E2110 ECOMAX BATT TERM 1/0 GA POS 	E2109 ECOMAX BATT TERM 1/0 GA NEG 
BAL2038 2/0 X 3/8ST HVY DUTY TUBULAR LUG 	BAL2012 2/0 X 1/2ST HVY DUTY TUBULAR LUG 	E2112 ECOMAX BATT TERM 2/0 GA POS 	E2111 ECOMAX BATT TERM 2/0 GA NEG 
MS100 1/0GA HVY DUTY BUTT CONN 	MS200 2/0GA HVY DUTY BUTT CONN 		
B1110 5/16 X 1-1/4 BATT BOLT & NUT TIN PLATED 			

























PRODUCT CATEGORY: Q

### EcoMax Terminals, Heavy Duty Lugs & Splices

11 Items • 75 Pcs  
IBS No. 202P



Packaged in a Locking Steel Drawer  
for Easy Storage & Organization

IBS, Inc. SPECIALTY PRODUCTS FOR MAINTENANCE & REPAIR INDUSTRIALBOLT.COM © © © 800-678-1506		Non-Insulated Butted Seam Top 24 Wire Ends			
Assortment No. 211R					
61S 22-18 BUTT CONN NON INSUL 	11-6 22-18 RING TERM. 6 STUD NO-INS 	11-8 22-18 RING TERM 8 STUD NO-INS 	11-10 22-18 RING TERM 10 STUD NO-INS 	31-10 22-18 SPADE TERM #10 STUD 	72F-250-32 16-14 FEMALE QUICK SLIDE 
62S 16-14 BUTT CONN NON INSULATED 	12-6 16-14 RING TERM. 6 STUD NO-INS 	12-10 16-14 RING TERM 10 STUD NO-INS 	12-14 16-14 RING TERM #14 STUD NO-IN 	32-10 16-14 #10 SPADE TERM 	72M-250-32 16-14 MALE QIK SLIDE NO INSUL. 
63S 12-10 BUTT CONN. NON INSUL 	82F-156-NL 16-14 FEMALE SNAP PLUG VINYL 	82M-156 16-14 MALE SNAP PLUG 	13-8 12-10 RING TERM 8 STUD NON-INS 	33-10 12-10 SPADE TERM #10 STUD 	73M-250-32 12-10 MALE QIK SLIDE NO INSUL. 
13-10 12-10 RING TERM #10 STUD NO-IN 	13-14 12-10 RING TERM 1/4 STUD 	13-56 12-10 RING TERM 5/16 STUD 	13-38 12-10 RING TERM. 3/8 STUD NO-1 	13-500 12-10 RING TERM 1/2 STUD 	73P-250-32 12-10 FEMALE QUICK SLIDE 











PRODUCT CATEGORY: Q

### Non-Insulated Butted Seam Top 24 Wire Ends

24 Items • 635 Pcs  
IBS No. 211R



Packaged in a Locking Steel Drawer  
for Easy Storage & Organization

IBS, Inc. SPECIALTY PRODUCTS FOR MAINTENANCE & REPAIR INDUSTRIALBOLT.COM © © © 800-678-1506		Grommet Kit	
Assortment No. 230R			
A-4410 5/32ID X 1/16 GROOVE RUBBER 	A-4413 3/16ID X 1/16 GROOVE RUBBER 	A-4414 3/16ID X 3/32 GROOVE RUBBER 	
A-16454 1/4ID X 1/16 GROOVE RUBBER 	A-4419 5/16ID X 1/16 GROOVE RUBBER 	A-4423 3/8ID X 1/16 GROOVE RUBBER 	
A-4428 1/2ID X 3/32 GROOVE RUBBER 	A-16458 1/2ID X 1/8 GROOVE RUBBER 	A-4432 5/8ID X 1/16 GROOVE RUBBER 	
A-4433 3/4ID X 1/16 GROOVE RUBBER 	A-4430 1/2ID X 1/4 GROOVE RUBBER 		

PRODUCT CATEGORY: Q

### Grommet Kit

11 Items • 220 Pcs  
IBS No. 230R



Packaged in a Locking Steel Drawer  
for Easy Storage & Organization

ASSORTMENTS



# IBS, INCORPORATED

## Assortments - Electrical (Q)

ASSORTMENTS

**IBS, Inc.**  
SPECIALTY PRODUCTS FOR MAINTENANCE & REPAIR  
INDUSTRIALBOLT.COM • 800-678-1906

**Automotive Electrical Fuses**

Assortment No. 290P

AGA15 AUTO FUSE	AGA20 AUTO FUSE	AGA30 AUTO FUSE	SFE7-1/2 AUTO FUSE GLASS TUBE	SFE14 AUTO FUSE GLASS TUBE	SFE20 AUTO FUSE GLASS TUBE	SFE30 AUTO FUSE GLASS TUBE	
AGC1 AUTO FUSE	AGC4 AUTO FUSE	AGC7-1/2 AUTO FUSE	AGC10 AUTO FUSE	AGC15 AUTO FUSE	AGC20 AUTO FUSE	AGC25 AUTO FUSE	
ATC5 AUTO FUSE	ATC10 AUTO FUSE	ATC15 AUTO FUSE	ATC20 AUTO FUSE	ATC25 AUTO FUSE	ATC30 AUTO FUSE	EL-12 HVY DUTY 2 PRONG TRUCK FLASHER	
ATM5 AUTO FUSE	ATM10 AUTO FUSE	ATM15 AUTO FUSE	ATM20 AUTO FUSE	ATM25 AUTO FUSE	ATM30 AUTO FUSE	EL-13 HVY DUTY 3 PRONG TRUCK FLASHER	
19518 GLASS TUBE WATER-PROOF IN-LINE	19513 BLADE TYPE WATER-PROOF IN-LINE FUSE HLDR	FP-C FUSE PULLER					
0690T 12 VOLT TESTER	1588A 3/8 TEST CLIP JAW		MAX20 20 AMP MAXI FUSE YELLOW	MAX30 30 AMP MAXI FUSE GREEN	MAX40 40 AMP MAXI FUSE ORANGE		

PRODUCT CATEGORY: Q

### Automotive Electrical Fuses

37 Items • 235 Pcs  
IBS No. 290P



Packaged in a Locking Steel Drawer for Easy Storage & Organization

**IBS, Inc.**  
SPECIALTY PRODUCTS FOR MAINTENANCE & REPAIR  
INDUSTRIALBOLT.COM • 800-678-1906

**Heavy Wall Shrink Tubing II**

Assortment No. 295P

B3505 2-4/0GA X 6" BLACK HVY	B3405 2-4/0GA X 6" RED HVY WALL
B3503 8-1/0GA X 6" BLACK HEAVY SHRINK TUBE	B3404 8-1/0 GA X 6" RED HEAVY SHRINK TUBE
B3501 12-6GA X 6" BLACK HVY SHRINK	B3502 12-6GA X 6" RED HVY SHRINK
B3508 8-2GA X 6" CLEAR SHRINK TUBE	B282 12-10 SOLDER&SEAL SHRINK TUBE
B3507 14-8GA X 6" CLEAR SHRINK TUBE	B281 16-14 SOLDER&SEAL SHRINK TUBE
B3506 18-12GA X 6" CLEAR SHRINK	B280 22-18 SOLDER&SEAL SHRINK TUBE

PRODUCT CATEGORY: Q

### Heavy Wall Shrink Tubing II

12 Items • 86 Pcs  
IBS No. 295P



Packaged in a Locking Steel Drawer for Easy Storage & Organization

**IBS, Inc.**  
SPECIALTY PRODUCTS FOR MAINTENANCE & REPAIR  
INDUSTRIALBOLT.COM • 800-678-1906

**FUSION™ Solder-On Battery Ends & Shrink Tubing**

Assortment No. 296P

B11381 1/0 X 3/8 FUSION HVY WALL LUG	B21381 2/0 X 3/8 FUSION HVY WALL LUG	B3405 2-4/0GA X 6" RED HVY WALL	B3505 2-4/0GA X 6" BLACK HVY
B2121 1/0 POS STRT FUSION BATTERY	B2123 2/0 POS STRT FUSION BATTERY		
B2120 1/0 NEG STRT FUSION BATTERY	B2122 2/0 NEG STRT FUSION BATTERY		

PRODUCT CATEGORY: Q

### Fusion Solder-On Battery Ends & Shrink Tubing

8 Items • 34 Pcs  
IBS No. 296P



Packaged in a Locking Steel Drawer for Easy Storage & Organization



IBS, Inc. SPECIALTY PRODUCTS FOR MAINTENANCE & REPAIR INDUSTRIALBOLT.COM • • • 800-670-1506		Automotive Shrink Tubing With MicroTorch Butane Torch Included Assortment No. 297R	
B281 16-14 SOLDER&SEAL SHRINK TUBE		B282 12-10 SOLDER/SEAL SHRINK TUBE	
B280 22-18 SOLDER&SEAL SHRINK TUBE		B279 24-22 SOLDER/SEAL SHRINK TUBE	
B3507 14-8GA X 6 CLEAR SHRINK TUBE*		B3508 8-2GA X 6 CLEAR SHRINK TUBE*	
B3302 1/4 X 12 CLEAR DUAL WALL*			
B3301 3/16 X 12 CLEAR DUAL WALL*			
B3300 1/8 X 12 CLEAR DUAL WALL*			

PRODUCT CATEGORY: Q

### Automotive Shrink Tubing

9 Items • 55 Pcs

IBS No. 297R



Packaged in a Locking Steel Drawer for Easy Storage & Organization

IBS, Inc. SPECIALTY PRODUCTS FOR MAINTENANCE & REPAIR INDUSTRIALBOLT.COM • • • 800-670-1506		Multilink Wire Ends Assortment No. 314R					
B5518 20-18 MULTILINK BUTT CONNECTOR		125702 20-18 MULTILINK #8 RING TERM		125703 20-18 MULTILINK #10 RING TERM		125713 20-18 MULTILINK #10 SPADE TERM	
B5514 16-14 MULTILINK BUTT CONNECTOR		125714 16-14 MULTILINK #10 SPADE TERM		125718 16-14 MULTILINK .250 MALE		125719 16-14 MULTILINK .250 FEMALE	
125705 16-14 MULTILINK #8 RING TERM		125706 16-14 MULTILINK #10 RING TERM		125707 16-14 MULTILINK 1/4 RING TERM		125708 16-14 MULTILINK 3/8 RING TERM	
125720 12-10 MULTILINK #10 SPADE TERM		125720 12-10 MULTILINK .250 MALE		125721 12-10 MULTILINK .250 FEMALE			
B5510 12-10 MULTILINK BUTT CONNECTOR		125709 12-10 MULTILINK #10 RING TERM		125710 12-10 MULTILINK 1/4 RING TERM		125711 12-10 MULTILINK 3/8 RING TERM	

PRODUCT CATEGORY: Q

### Multilink Wire Ends

19 Items • 145 Pcs

IBS No. 314R



Packaged in a Locking Steel Drawer for Easy Storage & Organization

IBS, Inc. SPECIALTY PRODUCTS FOR MAINTENANCE & REPAIR INDUSTRIALBOLT.COM • • • 800-670-1506		Crimp-N-Seal Terminals Assortment No. 316R				
B5223 16-14 CRIMP & SEAL #8 RING TERM		B5224 16-14 CRIMP & SEAL #10 RING TERM		B280 22-18 SOLDER&SEAL SHRINK TUBE		
B5225 16-14 CRIMP & SEAL 1/4 RING TERM		B5228 16-14 CRIMP & SEAL #10 SPADE TERM		B281 16-14 SOLDER&SEAL SHRINK TUBE		
B5245 16-14 CRIMP & SEAL .250 FEMALE CONN		B5255 16-14 CRIMP & SEAL .250 MALE CONN		B5265 16-14 CRIMP & SEAL .156 MALE BULLET		
B5275 16-14 CRIMP & SEAL .156 FEMALE BULLET		B5324 12-10 CRIMP & SEAL #10 RING TERM		B5325 12-10 CRIMP & SEAL 1/4 RING TERM		
B5327 12-10 CRIMP & SEAL 3/8 RING TERM		B5345 12-10 CRIMP & SEAL .250 FEMALE CONN		B282 12-10 SOLDER&SEAL SHRINK TUBE		
B5355 12-10 CRIMP & SEAL .250 MALE CONN		B5110 20-18 CRIMP & SEAL BUTT CONNECTOR		B5210 16-14 CRIMP & SEAL BUTT CONNECTOR		
B5310 12-10 CRIMP & SEAL BUTT CONNECTOR		B5100 24-22 CRIMP & SEAL BUTT CONNECTOR				

PRODUCT CATEGORY: Q

### Crimp-N-Seal Terminals

20 Items • 348 Pcs

IBS No. 316R



Packaged in a Locking Steel Drawer for Easy Storage & Organization

ASSORTMENTS



# IBS, INCORPORATED

## Assortments - Electrical (Q)

ASSORTMENTS

**IBS, Inc.**  
SPECIALTY PRODUCTS FOR MAINTENANCE & REPAIR  
INDUSTRIALBOLT.COM • 800-478-1506

**Multilink Wire Ends**  
With Microtorch Butane Torch & Refill Included

Assortment No. 324R

B5518 20-18 MULTILINK BUTT CONNECTOR	125702 20-18 MULTILINK #8 RING TERM	125703 20-18 MULTILINK #10 RING TERM	125713 20-18 MULTILINK #10 SPADE TERM	125738 MICROTORCH BUTANE TORCH
B5514 16-14 MULTILINK BUTT CONNECTOR	125714 16-14 MULTILINK #10 SPADE TERM	125718 16-14 MULTILINK .250 MALE	125719 16-14 MULTILINK .250 FEMALE	125715 12-10 MULTILINK #10 SPADE TERM
125705 16-14 MULTILINK #8 RING TERM	125706 16-14 MULTILINK #10 RING TERM	125707 16-14 MULTILINK 1/4 RING TERM	125708 16-14 MULTILINK 3/8 RING TERM	125720 12-10 MULTILINK .250 MALE
B5510 12-10 MULTILINK BUTT CONNECTOR	125709 12-10 MULTILINK #10 RING TERM	125710 12-10 MULTILINK 1/4 RING TERM	125711 12-10 MULTILINK 3/8 RING TERM	125721 12-10 MULTILINK .250 FEMALE
				95007 42 GRAM BUTANE REFILL





PRODUCT CATEGORY: Q

**Multilink Wire Ends**  
with Micro Butane Torch  
21 Items • 147 Pcs  
IBS No. 324R



Packaged in a Locking Steel Drawer  
for Easy Storage & Organization

**IBS, Inc.**  
SPECIALTY PRODUCTS FOR MAINTENANCE & REPAIR  
INDUSTRIALBOLT.COM • 800-478-1506

**Automotive Bulbs**

Assortment No. 327R

B194 #194 12V INSTRUMENT / SIDE	B194NA 12V AMBER PARKING / SIDE	B1893 12V HD AUTO INSTRUMENT LIGHT	B1895 12V PARKING / SIDE MARKER	B53 12V AUTO INSTRUMENT LIGHT
B57 12V AUTO INSTRUMENT LIGHT	B1157 12V STOP - TURN - SIGNAL LIGHT	B1157NA 12V STOP - TAIL - SIGNAL LIGHT	B3157 12V STOP - TAIL - TURN LIGHT	B3157NA 12V STOP - TAIL - TURN LIGHT
B2057 12V STOP - TAIL - TURN LIGHT	B3057 12V STOP - TAIL - TURN LIGHT	B1156 12V FRONT & REAR TURN LIGHT	B3156 12V FRONT & REAR TURN LIGHT	
B916 12V PARKING / SIDE MARKER	B97 12V PARKING / LICENSE PLATE			

PRODUCT CATEGORY: Q

**Automotive Bulbs**  
16 Items • 160 Pcs  
IBS No. 327R



Packaged in a Locking Steel Drawer  
for Easy Storage & Organization

**IBS, Inc.**  
SPECIALTY PRODUCTS FOR MAINTENANCE & REPAIR  
INDUSTRIALBOLT.COM • 800-478-1506

**Automotive Shrink Tubing**  
12" Cut Lengths

Assortment No. 338R

B3313 14-4AWG HI FLOW ADHESIVE	
B3312 16-8AWG HI FLOW ADHESIVE	
B3311 22-10AWG HI FLOW ADHESIVE	
B3310 24-12AWG HI FLOW ADHESIVE	
B3301 3/16 X 12" CLEAR DUAL WALL	
B3300 1/8 X 12" CLEAR DUAL WALL	

PRODUCT CATEGORY: Q

**Automotive Shrink Tubing**  
12" Cut Lengths  
6 Items • 30 Pcs  
IBS No. 338R



Packaged in a Locking Steel Drawer  
for Easy Storage & Organization



IBS, Inc. SPECIALTY PRODUCTS FOR MAINTENANCE & REPAIR INDUSTRIALMOLTY.COM • • • 800-678-1906							Heavy Duty Truck Circuit Breakers
							Assortment No. 340R
CB1911-10 10AMP MAXI BREAKER	CB1911-20 20AMP MAXI BREAKER	CB1911-30 30AMP MAXI BREAKER	CB212-10 10AMP ATM MINI CIRCUIT BREAKER	CB212-15 15AMP ATM MINI CIRCUIT BREAKER	CB212-20 20AMP ATM MINI CIRCUIT BREAKER	CB212-25 25AMP ATM MINI CIRCUIT BREAKER	
CBC-15B 15AMP STUD MOUNTED	CBC-20B 20AMP STUD MOUNTED	CBC-30B 30AMP STUD MOUNTED	CBC-40B 40AMP STUD MOUNTED	CBC-50B 50AMP STUD MOUNTED	CCB-25 25AMP CIRCUIT BREAKER OE#	FCB-20 20AMP CIRCUIT BREAKER OE#	
UCB-10 10AMP UNIVERSAL CIRCUIT	UCB-15 15AMP UNIVERSAL CIRCUIT	UCB-20 20AMP UNIVERSAL CIRCUIT	UCB-25 25AMP UNIVERSAL CIRCUIT	UCB-30 30AMP UNIVERSAL CIRCUIT	CBF-20 20AMP CIRCUIT BREAKER-GLASS	CBF-30 30AMP CIRCUIT BREAKER-GLASS	
CB221-10 10AMP ATC BLADE BREAKER TYPE 1	CB221-15 15AMP ATC BLADE BREAKER TYPE 1	CB221-20 20AMP ATC BLADE BREAKER TYPE 1	CB221-30 30AMP ATC BLADE BREAKER TYPE 1	CB221-30 30AMP ATC STYLE CIRCUIT			

PRODUCT CATEGORY: Q

### Heavy Duty Truck Circuit Breakers

26 Items • 26 Pcs

IBS No. 340R



Packaged in a Locking Steel Drawer  
for Easy Storage & Organization

IBS, Inc. SPECIALTY PRODUCTS FOR MAINTENANCE & REPAIR INDUSTRIALMOLTY.COM • • • 800-678-1906						LED Smart Fuses
						Assortment No. 364R
139212 ATM 5 Amp Mini / Amber	139214 ATM 10 Amp Mini / Red	139215 ATM 15 Amp Mini / Blue	139216 ATM 20 Amp Mini / Yellow	139217 ATM 25 Amp Mini / Clear	139447 ATM Mini In-Line Clear Cover Fuseholder	
139218 ATM 30 Amp Mini / Green		139222 ATC 5 Amp Amber	139224 ATC 10 Amp Red	139225 ATC 15 Amp Blue	139450 ATC In-Line Clear Cover Fuseholder	
139226 ATC 20 Amp Yellow	139227 ATC 25 Amp Clear	139228 ATC 30 Amp Green		139411 MAXI 20 Amp Yellow	139425 MAXI In-Line Fuseholder with Cover	
139412 MAXI 30 Amp Green	139413 MAXI 40 Amp Amber	139414 MAXI 50 Amp Red	139415 MAXI 60 Amp Blue	139416 MAXI 80 Amp Clear		

PRODUCT CATEGORY: Q

### LED Smart Fuses

22 Items • 76 Pcs

IBS No. 364R



Packaged in a Locking Steel Drawer  
for Easy Storage & Organization

IBS, Inc. SPECIALTY PRODUCTS FOR MAINTENANCE & REPAIR INDUSTRIALMOLTY.COM • • • 800-678-1906		Black Nylon Ty-Raps with Metal Tabs
		Assortment No. 370R
104487 MINI CABLE TIE GUN		
104493 13IN 120LB BLACK NYLON TYRAP METAL TAB		
104492 14IN 50LB BLACK NYLON TYRAP METAL TAB		
104491 11IN 50LB BLACK NYLON TYRAP METAL TAB		
104490 7IN 50LB BLACK NYLON TYRAP METAL TAB		
104488 3-1/2 18LB BLACK NYLON TYRAP METAL TAB	104489 5-1/2 30LB BLACK NYLON TYRAP METAL TAB	

PRODUCT CATEGORY: Q

### Black Nylon Ty-Raps with Metal Tabs

7 Items • 251 Pcs

IBS No. 370R



Packaged in a Locking Steel Drawer  
for Easy Storage & Organization

A  
S  
S  
O  
R  
T  
M  
E  
N  
T  
S



# IBS, INCORPORATED

## Assortments - Electrical (Q)

ASSORTMENTS

IBS, Inc. SPECIALTY PRODUCTS FOR MAINTENANCE & REPAIR INDUSTRIALBOLT.COM • • • 800-678-1506						Multilink Wire Ends
						Assortment No. 385R
B5518 20-18 MULTILINK BUTT CONNECTOR	B5530 20-18 TO 16-14 MULTILINK STEP	B5514 16-14 MULTILINK BUTT CONNECTOR	B5540 16-14 TO 12-10 MULTILINK STEP	B5510 12-10 MULTILINK BUTT CONNECTOR	B5550 12-10 TO 8GA MULTILINK STEP	
125702 20-18 MULTILINK #8 RING TERM	125713 20-18 MULTILINK #10 SPADE TERM	125705 16-14 MULTILINK #8 RING TERM	125714 16-14 MULTILINK #10 SPADE TERM	125709 12-10 MULTILINK #10 RING TERM	125715 12-10 MULTILINK #10 SPADE TERM	
125703 20-18 MULTILINK #10 RING TERM	125716 20-18 MULTILINK .250 MALE	125706 16-14 MULTILINK #10 RING TERM	125718 16-14 MULTILINK .250 MALE	125710 12-10 MULTILINK 1/4 RING TERM	125720 12-10 MULTILINK .250 MALE	
125704 20-18 MULTILINK 1/4 RING TERM	125717 20-18 MULTILINK .250 FEMALE	125707 16-14 MULTILINK 1/4 RING TERM	125719 16-14 MULTILINK .250 FEMALE	125711 12-10 MULTILINK 3/8 RING TERM	125721 12-10 MULTILINK .250 FEMALE	

PRODUCT CATEGORY: Q

### Multilink Wire Ends

24 Items • 175 Pcs

IBS No. 385R



Packaged in a Locking Steel Drawer for Easy Storage & Organization

IBS, Inc. SPECIALTY PRODUCTS FOR MAINTENANCE & REPAIR INDUSTRIALBOLT.COM • • • 800-678-1506						Crimp & Seal Wire Ends
						Assortment No. 386R
B5110 20-18 CRIMP & SEAL BUTT CONNECTOR	B5115 20-18 CRIMP & SEAL 1/4 RING TERM	B5210 16-14 CRIMP & SEAL BUTT CONNECTOR	B5227 16-14 CRIMP & SEAL 3/8 RING TERM	B5310 12-10 CRIMP & SEAL BUTT CONNECTOR	B5327 12-10 CRIMP & SEAL 3/8 RING TERM	
B5112 20-18 CRIMP & SEAL #6 RING TERM	B5118 20-18 #10 CRIMP & SEAL SPADE TERM	B5223 16-14 CRIMP & SEAL #8 RING TERM	B5228 16-14 CRIMP & SEAL #10 SPADE TERM	B5323 12-10 CRIMP & SEAL #8 RING TERM	B5331 12-10 CRIMP & SEAL #10 SPADE TERM	
B5113 20-18 CRIMP & SEAL #8 RING TERM	B5155 20-18 CRIMP & SEAL .250 MALE CONN	B5224 16-14 CRIMP & SEAL #10 RING TERM	B5255 16-14 CRIMP & SEAL .250 MALE CONN	B5324 12-10 CRIMP & SEAL #10 RING TERM	B5355 12-10 CRIMP & SEAL .250 MALE CONN	
B5114 20-18 CRIMP & SEAL #10 RING TERM	B5145 20-18 CRIMP & SEAL .250 FEMALE CONN	B5225 16-14 CRIMP & SEAL 1/4 RING TERM	B5245 16-14 CRIMP & SEAL .250 FEMALE CONN	B5325 12-10 CRIMP & SEAL 1/4 RING TERM	B5345 12-10 CRIMP & SEAL .250 FEMALE CONN	

PRODUCT CATEGORY: Q

### Crimp & Seal Wire Ends

24 Items • 240 Pcs

IBS No. 386R



Packaged in a Locking Steel Drawer for Easy Storage & Organization

IBS, Inc. SPECIALTY PRODUCTS FOR MAINTENANCE & REPAIR INDUSTRIALBOLT.COM • • • 800-678-1506				Fusion Battery Ends
				Assortment No. 387R
B2117 4-GGA NEG STRT FUSION BATTERY	B21171 4-GGA POS STRT FUSION BATTERY	B2118 1-2GA NEG STRT FUSION BATTERY	B2119 1-2GA POS STRT FUSION BATTERY	
B2120 1/0 NEG STRT FUSION BATTERY	B2121 1/0 POS STRT FUSION BATTERY	B2122 2/0 NEG STRT FUSION BATTERY	B2123 2/0 POS STRT FUSION BATTERY	
B2124 3/0 NEG STRT FUSION BATTERY	B2125 3/0 POS STRT FUSION BATTERY	B2126 4/0 NEG STRT FUSION BATTERY	B2127 4/0 POS STRT FUSION BATTERY	

PRODUCT CATEGORY: Q

### Fusion Battery Ends

12 Items • 22 Pcs

IBS No. 387R



Packaged in a Locking Steel Drawer for Easy Storage & Organization



**IBS, Inc.**  
SPECIALTY PRODUCTS FOR MAINTENANCE & REPAIR  
INDUSTRIALBOLTY.COM • 800-670-1906

**Procell Alkaline Batteries**

Assortment No. 395R

<p>EN95 D SIZE PROCELL ALKALINE BATTERY</p>	<p>EN93 C SIZE PROCELL ALKALINE BATTERY</p>	<p>EN91 AA PROCELL ALKALINE BATTERY</p>	<p>EN92 AAA PROCELL ALKALINE BATTERY</p>
			<p>EN22 9 VOLT PROCELL ALKALINE BATTERY</p>

PRODUCT CATEGORY: Q

### Procell Alkaline Batteries

5 Items • 46 Pcs  
IBS No. 395R



Packaged in a Locking Steel Drawer for Easy Storage & Organization

**IBS, Inc.**  
SPECIALTY PRODUCTS FOR MAINTENANCE & REPAIR  
INDUSTRIALBOLTY.COM • 800-670-1906

**Red 22-18 Electrical Connectors**

Assortment No. 400R

<p>61-SN 22-18 BUTT CONN NYLON</p>	<p>61NBM 22-18 MOISTURE RESIST BUTT CON</p>	<p>B5518 20-18 MULTILINK BUTT CONNECTOR</p>	<p>31-6NB 22-18 SPADE TERM 6 STUD NYLON</p>	<p>31-8NB 22-18 SPADE TERM 8 STUD NYLON</p>	<p>31-10NB 22-18 SPADE TERM 10 STUD NYLON</p>
<p>11-6SNB 22-18 RING TERM 6 STUD NYLON</p>	<p>11-8SNB 22-18 RING TERM 8 STUD NYLON</p>	<p>11-10NB 22-18 RING TERM 10 STUD NYLON</p>	<p>11-14SNB 22-18 RING TERM 1/4 STUD NYLON</p>	<p>11-56NB 22-18 RING TERM. 5/16 STUD NYL</p>	<p>11-38NB 22-18 RING TERM. 3/8 STUD NYLO</p>
<p>81M-156-NB 22-18 MALE SNAP PLUG FULL NY</p>	<p>81F-156-NBL 22-18 FEMALE SNAP PLUG FULL NY</p>	<p>71M-250-32-NBL 22-18 MALE QIK SLIDE FULL</p>	<p>71F-250-32-NBL 22-18 FEMALE QIK SLIDE FULL NY</p>	<p>71M-250-32-NB 22-18 MALE QIK SLIDE NYLON</p>	<p>71F-250-32-NB 22-18 FEMALE QIK SLIDE NYLON</p>
<p>71F-250-90-NBL 22-18 1/4 90DGR F QIK</p>	<p>81P-47-NB 22-18 PIN TERMINAL NYLON</p>				

PRODUCT CATEGORY: Q

### Red 22-18 Electrical Connectors

20 Items • 215 Pcs  
IBS No. 400R



Packaged in a Locking Steel Drawer for Easy Storage & Organization

**IBS, Inc.**  
SPECIALTY PRODUCTS FOR MAINTENANCE & REPAIR  
INDUSTRIALBOLTY.COM • 800-670-1906

**Blue 16-14 Electrical Connectors**

Assortment No. 401R

<p>62-SN 16-14 BUTT CONN NYLON</p>	<p>62NBM 16-14 MOISTURE RESIST BUTT CON</p>	<p>B5514 16-14 MULTILINK BUTT CONNECTOR</p>	<p>32-6NB 16-14 SPADE TERM 6 STUD NYLON</p>	<p>32-8NB 16-14 SPADE TERM 8 STUD NYLON</p>	<p>32-10NB 16-14 SPADE TERM 10 STUD NYLON</p>
<p>12-6SNB 16-14 RING TERM 6 STUD NYLON</p>	<p>12-8SNB 16-14 RING TERM 8 STUD NYLON</p>	<p>12-10NB 16-14 RING TERM 10 STUD NYLON</p>	<p>12-14SNB 16-14 RING TERM 1/4 STUD NYLON</p>	<p>12-56SNB 16-14 RING TERM 5/16 STUD NYLO</p>	<p>12-38NB 16-14 RING TERM 3/8 STUD NYLON</p>
<p>82M-156-NB 16-14 MALE SNAP PLUG NYLON</p>	<p>82F-156-NBL 16-14 FEMALE SNAP PLUG FULL NY</p>	<p>72M-250-32-NBL 16-14 MALE QIK SLIDE FULL</p>	<p>72F-250-32-NBL 16-14 FEMALE QIK SLIDE FULL NY</p>	<p>72M-250-32-NB 16-14 MALE QIK SLIDE NYLON</p>	<p>72F-250-32-NB 16-14 FEMALE QIK SLIDE NYLON</p>
<p>72F-250-90-NBL 16-14 90DGR 1/4 F QIK</p>	<p>82P-47-NB 16-14 PIN TERMINAL NYLON</p>				

PRODUCT CATEGORY: Q

### Blue 16-14 Electrical Connectors

20 Items • 215 Pcs  
IBS No. 401R



Packaged in a Locking Steel Drawer for Easy Storage & Organization

ASSORTMENTS



# IBS, INCORPORATED

## Assortments - Electrical (Q)

ASSORTMENTS

IBS, Inc. SPECIALTY PRODUCTS FOR MAINTENANCE & REPAIR INDUSTRIALBOLT.COM © © © 800-876-1506					Yellow 12-10 Electrical Connectors				
					Assortment No. 402R				
63-SN 12-10 BUTT CONN NYLON	63NBM 12-10 MOISTURE RESIST BUTT CON	B5510 12-10 MULTILINK BUTT CONNECTOR	33-8NB 12-10 SPADE TERM 8 STUD NYLON	33-10NB 12-10 SPADE TERM 10 STUD NYLON					
13-10NB 12-10 RING TERM 10 STUD NYLON	13-14SNB 12-10 RING TERM 1/4 STUD NYLON	13-56SNB 12-10 RING TERM 5/16 STUD NYLON	13-38SNB 12-10 RING TERM 3/8 STUD NYLON	13-500NB 12-10 RING TERM 1/2 STUD NYLON					
13-8SNB 12-10 RING TERM 8 STUD NYLON	73M-250-32-NBL 12-10 MALE QIK SLIDE FULL NYLON	73F-250-32-NBL 12-10 FEMALE QIK SLIDE FULL NY	73M-250-32-NB 12-10 MALE QIK SLIDE NYLON	73F-250-32-NB 12-10 FEMALE QIK SLIDE NYLON					
83P-55-NB 12-10 PIN TERMINAL NYLON									

PRODUCT CATEGORY: Q

### Yellow 12-10 Electrical Connectors 16 Items • 175 Pcs IBS No. 402R



Packaged in a Locking Steel Drawer for Easy Storage & Organization

IBS, Inc. SPECIALTY PRODUCTS FOR MAINTENANCE & REPAIR INDUSTRIALBOLT.COM © © © 800-876-1506					Special Battery Ends				
					Assortment No. 642P				
133328 8-6GA OEM POSITIVE BATTERY END	N7000 HVY DUTY TOP MOUNT BATT TERM	133338 POST TO SIDE MNT BATTERY END	133335 MARINE WING NUT BATTERY END	133336 MARINE WING NUT BATTERY END					
133329 8-6GA OEM NEGATIVE BATTERY END	133332 AUTOMOTIVE EMERGENCY POS.	133338 POST TO SIDE MNT BATTERY END	B6007 SIDE MNT BATTERY ACC. BOLT	B6024 TOP MNT BATTERY ACC. BOLT					
133330 4.2&1GA OEM POSITIVE BATTERY	133333 AUTOMOTIVE EMERGENCY NEG.	133339 SIDE MNT TO POST TOP BATT.	B1101 SIDE MOUNT BATT BOLT OEM	B1102 SIDE MOUNT BATT BOLT EX LONG					
133331 4.2&1GA OEM NEGATIVE BATTERY	133334 AUTOMOTIVE SIDE MNT EMERG	133339 SIDE MNT TO POST TOP BATT.	B1110 5/16 X 1-1/4 BATT BOLT & NUT TIN PLATED						

PRODUCT CATEGORY: Q

### Special Battery Ends 19 Items • 52 Pcs IBS No. 642P



Packaged in a Locking Steel Drawer for Easy Storage & Organization

IBS, Inc. SPECIALTY PRODUCTS FOR MAINTENANCE & REPAIR INDUSTRIALBOLT.COM © © © 800-876-1506					Colored Cable Tie Wraps				
					Assortment No. 710R				
BL-4-18 4' 18LB BLUE NYLON TIE					R-4-18 4' 18LB RED NYLON TIE				
Y-4-18 4' 18LB FLOURESCENT YELLOW NYLON TIE					L-4-18 4' 18LB NATURAL NYLON TIE				
B-7-50 7' 50LB BLACK NYLON TIE					B-4-18 4' 18LB BLACK NYLON TIE				
FB-7-50 7' 50LB FLOURESCENT BLUE NYLON TIE					L-7-50 7' 50LB NATURAL NYLON TIE				
FO-7-50 7' 50LB FLOURESCENT ORANGE NYLON TIE					FG-7-50 7' 50LB FLOURESCENT GREEN NYLON TIE				
FY-7-50 7' 50LB FLOURESCENT YELLOW NYLON TIE					FP-7-50 7' 50LB FLOURESCENT PINK NYLON TIE				

PRODUCT CATEGORY: Q

### Colored Cable Tie Wraps 12 Items • 1200 Pcs IBS No. 710R



Packaged in a Locking Steel Drawer for Easy Storage & Organization



**IBS, Inc.**  
SPECIALTY PRODUCTS FOR MAINTENANCE & REPAIR  
INDUSTRIALBOLTY.COM © © © 800-878-1506

Electrical Tape

Assortment No. 711R

145237 3/4 X 60FT BLUE ELECTRICAL TAPE 	145238 3/4 X 60FT GREEN ELECTRICAL TAPE 	145239 3/4 X 60FT WHITE ELECTRICAL TAPE 	B9211 1' X 30' FUSION TAPE 
145240 3/4 X 60FT BROWN ELECTRICAL TAPE 	145241 3/4 X 60FT ORANGE ELECTRICAL TAPE 	145242 3/4 X 60FT YELLOW ELECTRICAL TAPE 	B9201 SILICONE TAPE - RED 
145243 3/4 X 60FT GRAY ELECTRICAL TAPE 	145244 3/4 X 60FT RED ELECTRICAL TAPE 	N9010 3/4 X 60YD PVC ELECTRICAL 	

PRODUCT CATEGORY: Q

**Electrical Tape**  
11 Items • 20 Pcs  
IBS No. 711R



Packaged in a Locking Steel Drawer for Easy Storage & Organization

**IBS, Inc.**  
SPECIALTY PRODUCTS FOR MAINTENANCE & REPAIR  
INDUSTRIALBOLTY.COM © © © 800-878-1506

Blade Fuses  
ATM, ATC and MAX

720R

ATM2 	ATM3 	ATM4 	ATM5 	ATM7-1/2 	ATM10 	ATM15 	ATM20 
ATM25 	ATM30 	ATC2 	ATC3 	ATC4 	ATC5 	ATC7-1/2 	ATC10 
ATC15 	ATC20 	ATC25 	ATC30 	ATC40 			
MAX20 	MAX30 	MAX40 	MAX50 	MAX60 	MAX70 	MAX80 	FP-C FUSE PULLER 

PRODUCT CATEGORY: Q

**Blade Fuses**  
29 Items • 127 Pcs  
IBS No. 720R



Packaged in a Locking Steel Drawer for Easy Storage & Organization

**IBS, Inc.**  
SPECIALTY PRODUCTS FOR MAINTENANCE & REPAIR  
INDUSTRIALBOLTY.COM © © © 800-878-1506

12V Miniature  
Auto Bulb Assortment

Assortment No. 722R

B37 14V AUTO AIR COURTESY DOME IND AUTOMOTIVE BULB GLASS WEDGE 	B53 12V AUTO INSTRUMENT INDICATOR AUTOMOTIVE BULB MINI BASE 	B57 12V AUTO INSTRUMENT INDICATOR AUTOMOTIVE BULB MINI BASE 	B67 12V PARKING DOME INDICATOR AUTOMOTIVE BULB MINI BASE 	B89 12V PARKING DOME INSTRUMENT AUTOMOTIVE BULB MINI BASE 	B97 12V PARKING LICENSE PLATE AUTOMOTIVE BULB MINI BASE 
B194 12V INSTRUMENT SIDE MARKER AUTOMOTIVE BULB GLASS WEDGE 	B194NA 12V SIDE MARKER PARK AMBER AUTOMOTIVE BULB 	B906 12V SIDE MARKER DOME AUTOMOTIVE BULB 	B912 12V SIDE MARKER DOME AUTOMOTIVE BULB 	B916 12V PARKING SIDE MARKER AUTOMOTIVE BULB 	B921 12V SIDE MARKER DOME AUTOMOTIVE BULB 
B1156 12V FRONT REAR TURN LIGHT AUTOMOTIVE BULB 	B1157 12V STOP TURN SIGNAL LIGHT AUTOMOTIVE BULB 	B1157NA 12V STOP TAIL SIGNAL AMBER AUTOMOTIVE BULB 	B1893 14V HD INSTRUMENT MINI BASE AUTOMOTIVE BULB 	B1895 12V PARKING SIDE MARKER AUTOMOTIVE BULB 	B2057 12V STOP TAIL TURN LIGHT AUTOMOTIVE BULB 
B3057 12V STOP TAIL TURN LIGHT AUTOMOTIVE BULB PLASTIC WEDGE 	B3156 12V FRONT REAR TURN LIGHT AUTOMOTIVE BULB PLASTIC WEDGE 	B3157 12V STOP TAIL TURN LIGHT AUTOMOTIVE BULB PLASTIC WEDGE 	B3157NA 12V STOP TAIL TURN LIGHT AMBER AUTOMOTIVE BULB PLASTIC WEDGE 	S457A INSTRUMENT PANEL BULB SOCKET HOLDER 1/2 HOLE 	S458A INSTRUMENT PANEL BULB SOCKET HOLDER 5/8 HOLE 

For Bulb B194 & B194NA      For Bulb B194 & B194NA

PRODUCT CATEGORY: Q

**12V Mini Auto Fuses**  
24 Items • 186 Pcs  
IBS No. 722R



Packaged in a Locking Steel Drawer for Easy Storage & Organization

ASSORTMENTS



# IBS, INCORPORATED

## Assortments - Electrical (Q)

ASSORTMENTS

IBS, Inc. SPECIALTY PRODUCTS FOR MAINTENANCE & REPAIR INDUSTRIALBOLT.COM © © © 800-878-1506		Automotive Fuse Holders & Accessories	
Assortment No. 723R			
139433 ATR MICRO2 ADD A LINE FUSE HOLDER 20AMP 16GA 	139431 ATM 16GA IN LINE FUSE HOLDER 32V 20AMP 	139422 12GA ATC FUSE HOLDER & COVER BLACK IN LINE 	19513 BLADE TYPE WATER-PROOF IN-LINE FUSE HLDR 
139434 ATR MICRO2 INLINE FUSE HOLDER 15AMP 16GA SIN LEADS 	139420 ATM ADD A LINE FUSE HOLDER 32V 2 FUSE 30A 	139427 ATC ADD A LINE FUSE HOLDER TAP 2 ATO/ATC MAX 30A 	139425 MAXI IN-LINE FUSE HOLDER WITH COVER 32V 60A 
139430 ATM LOW PROFILE ADD-A-LINE FUSE HOLDER 	139447 14GA ATM FUSE HOLDER & COVER CLEAR MINI 	139450 12GA ATC FUSE HOLDER & COVER CLEAR 	
139421 12GA ATM IN-LINE FUSE HOLDER W/ COVER 32V 30A 	139428 ATM FUSE BLADE TAP .187 TAB 	139429 ATC FUSE BLADE TAP .250 TAB 	139435 FLEX INLINE FUSE HOLDER 60AMP 8GA 4IN LEADS 58V 

PRODUCT CATEGORY: Q

### Automotive Fuse Holders & Accessories

15 Items • 75 Pcs

IBS No. 723R



Packaged in a Locking Steel Drawer for Easy Storage & Organization

IBS, Inc. SPECIALTY PRODUCTS FOR MAINTENANCE & REPAIR INDUSTRIALBOLT.COM © © © 800-878-1506		Standard Cable Tie Wraps	
Assortment No. 724R			
L-4-18 4 18LB NATURAL NYLON TIE* 	L-5-30 5 1/2 30LB NATURAL NYLON TIE* 		
L-7-50 7 50LB NATURAL NYLON TIE* 			
L-11-50 11 50LB NATURAL NYLON TIE* 			
L-14-50 14 50LB NATURAL NYLON TIE* 			
L-14-120 14 120LB NATURAL NYLON TIE* 			
L-14-120 14 120LB NATURAL NYLON TIE* 			

PRODUCT CATEGORY: Q

### Standard Cable Tie Wraps

6 Items • 600 Pcs

IBS No. 724R



Packaged in a Locking Steel Drawer for Easy Storage & Organization

IBS, Inc. SPECIALTY PRODUCTS FOR MAINTENANCE & REPAIR INDUSTRIALBOLT.COM © © © 800-878-1506		Weather Resistant Cable Tie Wraps	
Assortment No. 725R			
B-4-18 4 18LB BLACK NYLON TIE* 	B-5-30 5 30LB BLACK NYLON TIE* 		
B-7-50 7 50LB BLACK NYLON TIE* 			
B-11-50 11 50LB BLACK NYLON TIE* 			
B-14-50 14 BLACK NYLON TIE* 			
B-14-120 14 120LB BLACK NYLON TIE* 			
B-14-120 14 120LB BLACK NYLON TIE* 			

PRODUCT CATEGORY: Q

### Weather-Resistant Cable Tie Wraps

6 Items • 600 Pcs

IBS No. 725R



Packaged in a Locking Steel Drawer for Easy Storage & Organization



<b>IBS, Inc.</b> <small>SPECIALTY PRODUCTS FOR MAINTENANCE &amp; REPAIR          INDUSTRIALBOLT.COM • 800-678-1906</small>		<b>Releasable Cable Tie Wraps</b>	
Assortment No. 726R			
RB-5-50 5' 50LB BLACK RELEASABLE NYLON TIE			
RB-8-50 8' 50LB BLACK RELEASABLE NYLON TIE			
RB-12-50 12' 50LB BLACK RELEASABLE NYLON TIE			
RB-14-50 14' 50LB BLACK RELEASABLE NYLON TIE			
141146 29.5 200# YELLOW NYLON*			

PRODUCT CATEGORY: Q

### Releasable Cable Tie Wraps

5 Items • 310 Pcs  
IBS No. 726R



Packaged in a Locking Steel Drawer for Easy Storage & Organization

<b>IBS, Inc.</b> <small>SPECIALTY PRODUCTS FOR MAINTENANCE &amp; REPAIR          INDUSTRIALBOLT.COM • 800-678-1906</small>		<b>Mounting Tie Wraps</b>	
Assortment No. 727R			
SM-6-50 6' 50LB STUD MOUNT CABLE TIE WRAP BLACK			
PMB-8-50 8' 50LB BLACK PUSH MOUNT CABLE TIE WRAP			
BH-10-100 9-5/8" 100LB BUTTON HD TIE WRAP BLACK			
MH-7-50 7' 50LB NATURAL MOUNTING NYLON TIE WRAP	MBH-7-50 7' 50LB BLACK NYLON MOUNTING TIE		
MH-14-120 14' 120LB NATURAL MOUNTING NYLON TIE WRAP			
141140 13IN DUAL CLAMP CABLE TIE BLACK			

PRODUCT CATEGORY: Q

### Cable & Tubing Mounting Cable Tie Wraps

7 Items • 255 Pcs  
IBS No. 727R



Packaged in a Locking Steel Drawer for Easy Storage & Organization

<b>IBS, Inc.</b> <small>SPECIALTY PRODUCTS FOR MAINTENANCE &amp; REPAIR          INDUSTRIALBOLT.COM • 800-678-1906</small>				<b>Silicone Sealing Tape</b>			
Assortment No. 743R							
B9201 TAPE SILICONE RED 1" X 36'	B9202 TAPE SILICONE BLACK 1" X 36'	B9204 TAPE SILICONE GRAY 1" X 36'	B9205 TAPE SILICONE CLEAR 1" X 36'				
B9206 TAPE SILICONE RED 2" X 10'	B9207 TAPE SILICONE BLACK 2" X 10'	B9208 TAPE SILICONE GRAY 2" X 10'	B9209 TAPE SILICONE CLEAR 2" X 10'				

PRODUCT CATEGORY: Q

### Silicone Sealing Tape

8 Items • 8 Pcs  
IBS No. 743R



Packaged in a Locking Steel Drawer for Easy Storage & Organization

ASSORTMENTS



# IBS, INCORPORATED

## Assortments - Electrical (Q)

ASSORTMENTS

IBS, Inc. SPECIALTY PRODUCTS FOR MAINTENANCE & REPAIR INDUSTRIALBOLT.COM © 2010 800-670-1506					
Copper Tubular Lugs					
Assortment 755R					
B8101 BATT TERM #8AWG #10 STUD LUG 	B6101 BATT TERM #6AWG #10 STUD LUG 	B4141 BATT TERM #4AWG 1/4 STUD LUG 	B2381 BATT TERM #2AWG 3/8 STUD LUG 	B10381 BATT TERM 1/0AWG 3/8 STUD LUG 	B30381 BATT TERM 3/0AWG 3/8 STUD LUG 
B8141 BATT TERM #8AWG 1/4 STUD LUG 	B6141 BATT TERM #6AWG 1/4 STUD LUG 	B4561 BATT TERM #4AWG 5/16 STUD LUG 	B2503 BATT TERM #2AWG 1/2 STUD LUG 	B10501 BATT TERM 1/0AWG 1/2 STUD LUG 	B30501 BATT TERM 3/0AWG 1/2 STUD LUG 
B8561 BATT TERM #8AWG 5/16 STUD LUG 	B6561 BATT TERM #6AWG 5/16 STUD LUG 	B4381 BATT TERM #4AWG 3/8 STUD LUG 	B1381 BATT TERM #1AWG 3/8 STUD LUG 	B20381 BATT TERM 2/0AWG 3/8 STUD LUG 	B40381 BATT TERM 4/0AWG 3/8 STUD LUG 
B8383 BATT TERM #8AWG 3/8 STUD LUG 	B6583 BATT TERM #6AWG 3/8 STUD LUG 	B4503 BATT TERM #4AWG 1/2 STUD LUG 	B1501 BATT TERM #1AWG 1/2 STUD LUG 	B20501 BATT TERM 2/0AWG 1/2 STUD LUG 	B40501 BATT TERM 4/0AWG 1/2 STUD LUG 

PRODUCT CATEGORY: Q

### Copper Tubular Lugs

24 Items • 120 Pcs  
IBS No. 755R



Packaged in a Locking Steel Drawer for Easy Storage & Organization

IBS, Inc. SPECIALTY PRODUCTS FOR MAINTENANCE & REPAIR INDUSTRIALBOLT.COM © 2010 800-670-1506					
Tin Plated Copper Tubular Lugs					
Assortment 760R					
B8101P BATT TERM #8AWG #10 STUD LUG 	B6101P BATT TERM #6AWG #10 STUD LUG 	B4141P BATT TERM #4AWG 1/4 STUD LUG 	B2381P BATT TERM #2AWG 3/8 STUD LUG 	B10381P BATT TERM 1/0AWG 3/8 STUD LUG 	B30381P BATT TERM 3/0AWG 3/8 STUD LUG 
B8141P BATT TERM #8AWG 1/4 STUD LUG 	B6141P BATT TERM #6AWG 1/4 STUD LUG 	B4561P BATT TERM #4AWG 5/16 STUD LUG 	B2503P BATT TERM #2AWG 1/2 STUD LUG 	B10501P BATT TERM 1/0AWG 1/2 STUD LUG 	B30501P BATT TERM 3/0AWG 1/2 STUD LUG 
B8561P BATT TERM #8AWG 5/16 STUD LUG 	B6561P BATT TERM #6AWG 5/16 STUD LUG 	B4381P BATT TERM #4AWG 3/8 STUD LUG 	B1381P BATT TERM #1AWG 3/8 STUD LUG 	B20381P BATT TERM 2/0AWG 3/8 STUD LUG 	B40381P BATT TERM 4/0AWG 3/8 STUD LUG 
B8383P BATT TERM #8AWG 3/8 STUD LUG 	B6583P BATT TERM #6AWG 3/8 STUD LUG 	B4503P BATT TERM #4AWG 1/2 STUD LUG 	B1501P BATT TERM #1AWG 1/2 STUD LUG 	B20501P BATT TERM 2/0AWG 1/2 STUD LUG 	B40501P BATT TERM 4/0AWG 1/2 STUD LUG 

PRODUCT CATEGORY: Q

### Tin Plated Copper Tubular Lugs

24 Items • 120 Pcs  
IBS No. 760R



Packaged in a Locking Steel Drawer for Easy Storage & Organization

IBS, Inc. SPECIALTY PRODUCTS FOR MAINTENANCE & REPAIR INDUSTRIALBOLT.COM © 2010 800-670-1506				
Sealed Wire Connectors II				
Assortment No. 761R				
B560 26-24 TO 22-18 MULTILINK STEP BUTT CONNECTOR 	B5610 20-18 X 16-14 CRIMP & SEAL STEP BUTT CON 	B5716 20-18 HYDRALINK IN LINE BUTT CONNECTOR 	B5916 22-18 OPTISEAL BUTT CONNECTOR 	B5110 20-18 CRIMP & SEAL BUTT CONNECTOR 
B5530 20-18 TO 16-14 MULTILINK STEP BUTT CONN 	B5620 16-14 12-10 CRIMP & SEAL STEP BUTT CON 	B5714 16-14 HYDRALINK IN LINE BUTT CONNECTOR 	B5914 16-14 OPTISEAL BUTT CONNECTOR 	B5210 16-14 CRIMP & SEAL BUTT CONNECTOR 
B5540 16-14 TO 12-10 MULTILINK STEP BUTT CONN 	B5630 12-10 X 8GA CRIMP & SEAL STEP BUTT CONN 	B5710 12-10 HYDRALINK IN LINE BUTT CONNECTOR 	B5910 12-10 OPTISEAL BUTT CONNECTOR 	B5310 12-10 CRIMP & SEAL BUTT CONNECTOR 
B5550 12-10 TO 8GA MULTILINK STEP BUTT CONN 	B5814 22-14 HYDRALINK CLOSED END CONNECTOR 	B5810 18-10 HYDRALINK CLOSED END CONNECTOR 		

PRODUCT CATEGORY: Q

### Sealed Wire Connectors II

18 Items • 160 Pcs  
IBS No. 761R



Packaged in a Locking Steel Drawer for Easy Storage & Organization



IBS, Inc. SPECIALTY PRODUCTS FOR MAINTENANCE & REPAIR INDUSTRIALBOLTY.COM • • • 800-470-1506					Micro Fuses
					Assortment No. 766R
ATR5 5AMP MICRO2 FUSE 32V TAN FUSE 	ATR7-1/2 7.1/2AMP MICRO2 FUSE 32V BROWN FUSE 	ATR10 10AMP MICRO2 FUSE 32V RED FUSE 	ATR15 15AMP MICRO2 FUSE 32V BLUE FUSE 	ATR20 20AMP MICRO2 FUSE 32V YELLOW FUSE 	
ATR25 25AMP MICRO2 FUSE 32V CLEAR FUSE 	ATR30 30AMP MICRO2 FUSE 32V GREEN FUSE 	ATL5 5AMP MICRO3 FUSE 32V TAN FUSE 	ATL7-1/2 7.1/2AMP MICRO3 FUSE 32V BROWN FUSE 	ATL10 10AMP MICRO3 FUSE 32V RED FUSE 	
ATL15 15AMP MICRO3 FUSE 32V BLUE FUSE 	FMM15 15AMP MCASE FUSE 32V GREY 	FMM20 20AMP MCASE FUSE 32V BLUE 	FMM25 25AMP MCASE FUSE 32V WHITE 	FMM30 30AMP MCASE FUSE 32V PINK 	
FMM40 40AMP MCASE FUSE 32V GREEN 					

PRODUCT CATEGORY: Q

**Micro Fuses**  
16 Items • 135 Pcs  
IBS No. 766R



Packaged in a Locking Steel Drawer  
for Easy Storage & Organization

IBS, Inc. SPECIALTY PRODUCTS FOR MAINTENANCE & REPAIR INDUSTRIALBOLTY.COM • • • 800-470-1506						Deutsch DT Connectors & Terminals with Crimping & Removal Tools
						Assortment No. 768R
125104 DEUTSCH 2WAY RECEPTACLE HOUSING 	125106 DEUTSCH 3WAY RECEPTACLE HOUSING 	125108 DEUTSCH 4WAY RECEPTACLE HOUSING 	125110 DEUTSCH 6WAY RECEPTACLE HOUSING 	125112 DEUTSCH 8WAY RECEPTACLE HOUSING 	125100 DEUTSCH 16-20GA SOCKET FOR PIN 	
125105 DEUTSCH 2WAY PLUG HOUSING 	125107 DEUTSCH 3WAY PLUG HOUSING 	125109 DEUTSCH 4WAY PLUG HOUSING 	125111 DEUTSCH 6WAY PLUG HOUSING 	125113 DEUTSCH 8WAY PLUG HOUSING 	125102 DEUTSCH 16-20GA PIN FOR RECEPTACLE 	
125114 DEUTSCH 2WAY RECEPTACLE WEDGE 	125116 DEUTSCH 3WAY RECEPTACLE WEDGE 	125118 DEUTSCH 4WAY RECEPTACLE WEDGE 	125120 DEUTSCH 6WAY FEMALE WEDGE 	125122 DEUTSCH 8WAY FEMALE WEDGE 	125101 DEUTSCH 14GA SOCKET FOR PLUG 	
125115 DEUTSCH 2WAY PLUG WEDGE 	125117 DEUTSCH 3WAY PLUG WEDGE 	125119 DEUTSCH 4WAY PLUG WEDGE 	125121 DEUTSCH 6WAY MALE WEDGE 	125123 DEUTSCH 8WAY MALE WEDGE 	125103 DEUTSCH 14GA PIN FOR RECEPTACLE 	

PRODUCT CATEGORY: Q

**Deutsch DT  
Connectors &  
Terminals with  
Crimping & Removal  
Tools**

26 Items • 134 Pcs  
IBS No. 768R



Packaged in a Locking Steel Drawer  
for Easy Storage & Organization

IBS, Inc. SPECIALTY PRODUCTS FOR MAINTENANCE & REPAIR INDUSTRIALBOLTY.COM • • • 800-470-1506						Deutsch DT Connectors & Terminals
						Assortment No. 769R
125104 DEUTSCH 2WAY RECEPTACLE HOUSING 	125106 DEUTSCH 3WAY RECEPTACLE HOUSING 	125108 DEUTSCH 4WAY RECEPTACLE HOUSING 	125110 DEUTSCH 6WAY RECEPTACLE HOUSING 	125112 DEUTSCH 8WAY RECEPTACLE HOUSING 	125100 DEUTSCH 16-20GA SOCKET FOR PIN 	
125105 DEUTSCH 2WAY PLUG HOUSING 	125107 DEUTSCH 3WAY PLUG HOUSING 	125109 DEUTSCH 4WAY PLUG HOUSING 	125111 DEUTSCH 6WAY PLUG HOUSING 	125113 DEUTSCH 8WAY PLUG HOUSING 	125102 DEUTSCH 16-20GA PIN FOR RECEPTACLE 	
125114 DEUTSCH 2WAY RECEPTACLE WEDGE 	125116 DEUTSCH 3WAY RECEPTACLE WEDGE 	125118 DEUTSCH 4WAY RECEPTACLE WEDGE 	125120 DEUTSCH 6WAY FEMALE WEDGE 	125122 DEUTSCH 8WAY FEMALE WEDGE 	125101 DEUTSCH 14GA SOCKET FOR PLUG 	
125115 DEUTSCH 2WAY PLUG WEDGE 	125117 DEUTSCH 3WAY PLUG WEDGE 	125119 DEUTSCH 4WAY PLUG WEDGE 	125121 DEUTSCH 6WAY MALE WEDGE 	125123 DEUTSCH 8WAY MALE WEDGE 	125103 DEUTSCH 14GA PIN FOR RECEPTACLE 	

PRODUCT CATEGORY: Q

**Deutsch DT  
Connectors &  
Terminals**

24 Items • 132 Pcs  
IBS No. 769R



Packaged in a Locking Steel Drawer  
for Easy Storage & Organization

ASSORTMENTS



# IBS, INCORPORATED

## Assortments - Electrical (Q)

ASSORTMENTS

**IBS, Inc.**  
SPECIALTY PRODUCTS FOR MAINTENANCE & REPAIR  
INDUSTRIALBOLT.COM © © © 800-670-1906

**Metripack 280 Series  
Electrical Connectors**

Assortment No. 770R

125204 METRIPACK 1 PIN MALE CONNECTOR BODY	125208 METRIPACK 1 PIN FEMALE CONNECTOR BODY	125218 METRIPACK 1 PIN T.P.A. MALE & FEMALE	125201 METRIPACK GREEN CABLE SEAL 18-16 & 20-18 GAUGE	125212 METRIPACK 16-18 GAUGE MALE TERMINAL
125205 METRIPACK 2 PIN MALE CONNECTOR BODY	125209 METRIPACK 2 PIN FEMALE CONNECTOR BODY	125219 METRIPACK 2 PIN T.P.A. MALE & FEMALE	125202 METRIPACK GRAY CABLE SEAL 14-16 GAUGE	125215 METRIPACK 16-18 GAUGE FEMALE TERMINAL
125206 METRIPACK 3 PIN MALE CONNECTOR BODY	125210 METRIPACK 3 PIN FEMALE CONNECTOR BODY	125220 & 125221 METRIPACK 3 PIN T.P.A. MALE AND FEMALE	125203 METRIPACK BLUE CABLE SEAL 12-14 GAUGE	125213 METRIPACK 12-14 GAUGE MALE TERMINAL
125207 METRIPACK 5 PIN MALE CONNECTOR BODY	125211 METRIPACK 5 PIN FEMALE CONNECTOR BODY	125222 & 125223 METRIPACK 5 PIN T.P.A. MALE AND FEMALE	125224 METRIPACK CAVITY PLUG	125216 METRIPACK 12-14 GAUGE FEMALE TERMINAL

PRODUCT CATEGORY: Q

**IBS, Inc.**  
SPECIALTY PRODUCTS FOR MAINTENANCE & REPAIR  
INDUSTRIALBOLT.COM © © © 800-670-1906

**Metripack 280 Series  
Electrical Connectors & Tools**

Assortment No. 771R

125204 METRIPACK 1 PIN MALE CONNECTOR BODY	125208 METRIPACK 1 PIN FEMALE CONNECTOR BODY	125218 METRIPACK 1 PIN T.P.A. MALE & FEMALE	125201 METRIPACK GREEN CABLE SEAL 18-16 & 20-18 GAUGE	125212 METRIPACK 16-18 GAUGE MALE TERMINAL	
125205 METRIPACK 2 PIN MALE CONNECTOR BODY	125209 METRIPACK 2 PIN FEMALE CONNECTOR BODY	125219 METRIPACK 2 PIN T.P.A. MALE & FEMALE	125202 METRIPACK GRAY CABLE SEAL 14-16 GAUGE	125215 METRIPACK 16-18 GAUGE FEMALE TERMINAL	
125206 METRIPACK 3 PIN MALE CONNECTOR BODY	125210 METRIPACK 3 PIN FEMALE CONNECTOR BODY	125220 & 125221 METRIPACK 3 PIN T.P.A. MALE AND FEMALE	125203 METRIPACK BLUE CABLE SEAL 12-14 GAUGE	125213 METRIPACK 12-14 GAUGE MALE TERMINAL	
125207 METRIPACK 5 PIN MALE CONNECTOR BODY	125211 METRIPACK 5 PIN FEMALE CONNECTOR BODY	125222 & 125223 METRIPACK 5 PIN T.P.A. MALE AND FEMALE	125224 METRIPACK CAVITY PLUG	125216 METRIPACK 12-14 GAUGE FEMALE TERMINAL	

PRODUCT CATEGORY: Q

**IBS, Inc.**  
SPECIALTY PRODUCTS FOR MAINTENANCE & REPAIR  
INDUSTRIALBOLT.COM © © © 800-670-1906

**Weatherpack Connectors  
and Terminals**

Assortment No. 772R

125307 WEATHERPACK 1 CAVITY SHROUD MALE	125309 WEATHERPACK 2 CAVITY SHROUD MALE	125311 WEATHERPACK 3 CAVITY SHROUD MALE	125313 WEATHERPACK 4 CAVITY SHROUD MALE	125315 WEATHERPACK 6 CAVITY SHROUD MALE
125306 WEATHERPACK 1 CAVITY TOWER FEMALE	125308 WEATHERPACK 2 CAVITY TOWER FEMALE	125310 WEATHERPACK 3 CAVITY TOWER FEMALE	125312 WEATHERPACK 4 CAVITY TOWER FEMALE	125314 WEATHERPACK 6 CAVITY TOWER FEMALE
125300 WEATHERPACK 20-18GA MALE TERMINAL	125302 WEATHERPACK 16-14GA MALE TERMINAL	125304 WEATHERPACK 12GA MALE TERMINAL	125201 METRIPACK AND WEATHERPACK SEAL	125203 METRIPACK AND WEATHERPACK SEAL
125301 WEATHERPACK 20-18GA FEMALE TERMINAL	125303 WEATHERPACK 16-14GA FEMALE TERMINAL	125305 WEATHERPACK 12GA FEMALE TERMINAL	125202 METRIPACK WEATHERPACK SEAL	125224 METRIPACK & WEATHERPACK CAVITY PLUG

PRODUCT CATEGORY: Q

**Metripack 280 Series**  
20 Items • 430 Pcs  
IBS No. 770R



Packaged in a Locking Steel Drawer for Easy Storage & Organization

**Metripack 280 Series  
with Crimping &  
Removal Tools**  
22 Items • 432 Pcs  
IBS No. 771R



Packaged in a Locking Steel Drawer for Easy Storage & Organization

**Weatherpack Series**  
20 Items • 329 Pcs  
IBS No. 772R



Packaged in a Locking Steel Drawer for Easy Storage & Organization



**IBS, Inc.**  
SPECIALTY PRODUCTS FOR MAINTENANCE & REPAIR  
INDUSTRIALBOLT.COM • 800-678-1506

**Weatherpack Connectors and Terminals with Tools**

Assortment No. 773R

125307 WEATHERPACK 1 CAVITY SHROUD MALE	125309 WEATHERPACK 2 CAVITY SHROUD MALE	125311 WEATHERPACK 3 CAVITY SHROUD MALE	125313 WEATHERPACK 4 CAVITY SHROUD MALE	125315 WEATHERPACK 6 CAVITY SHROUD MALE	125325 WEATHERPACK 22-12GA CRIMPER 125326 WEATHERPACK TERM EXTRACTOR TOOL
125306 WEATHERPACK 1 CAVITY TOWER FEMALE	125308 WEATHERPACK 2 CAVITY TOWER FEMALE	125310 WEATHERPACK 3 CAVITY TOWER FEMALE	125312 WEATHERPACK 4 CAVITY TOWER FEMALE	125314 WEATHERPACK 6 CAVITY TOWER FEMALE	
125300 WEATHERPACK 20-18GA MALE TERMINAL	125302 WEATHERPACK 16-14GA MALE TERMINAL	125304 WEATHERPACK 12GA MALE TERMINAL	125201 METRIPACK/WEATHERPK SEALGRN 18-16/20-18GA	125203 METRIPACK/WEATHERPK SEAL BLUE 14-12 GA	
125301 WEATHERPACK 20-18GA FEMALE TERMINAL	125303 WEATHERPACK 16-14GA FEMALE TERMINAL	125305 WEATHERPACK 12GA FEMALE TERMINAL	125202 METRIPACK/WEATHERPK SEAL GRAY 16-14 GAUGE	125224 METRIPACK/WEATHERPK CAVITY PLUG	

PRODUCT CATEGORY: Q

### Weatherpack Series with Crimping & Removal Tools

22 Items • 331 Pcs  
IBS No. 773R



Packaged in a Locking Steel Drawer for Easy Storage & Organization

**IBS, Inc.**  
SPECIALTY PRODUCTS FOR MAINTENANCE & REPAIR  
INDUSTRIALBOLT.COM • 800-678-1506

**Deutsch DT Connectors & Terminals**

Assortment No. 780R

125104 DEUTSCH 2WAY RECEPTACLE HOUSING	125106 DEUTSCH 3WAY RECEPTACLE HOUSING	125108 DEUTSCH 4WAY RECEPTACLE HOUSING	125110 DEUTSCH 6WAY RECEPTACLE HOUSING	125112 DEUTSCH 8WAY RECEPTACLE HOUSING	125100 DEUTSCH 16-20GA SOCKET FOR PIN
125105 DEUTSCH 2WAY PLUG HOUSING	125107 DEUTSCH 3WAY PLUG HOUSING	125109 DEUTSCH 4WAY PLUG HOUSING	125111 DEUTSCH 6WAY PLUG HOUSING	125113 DEUTSCH 8WAY PLUG HOUSING	125102 DEUTSCH 16-20GA PIN FOR RECEPTACLE
125114 DEUTSCH 2WAY RECEPTACLE WEDGE	125116 DEUTSCH 3WAY RECEPTACLE WEDGE	125118 DEUTSCH 4WAY RECEPTACLE WEDGE	125120 DEUTSCH 6WAY FEMALE WEDGE	125122 DEUTSCH 8WAY FEMALE WEDGE	125101 DEUTSCH 14GA SOCKET FOR PLUG
125115 DEUTSCH 2WAY PLUG WEDGE	125117 DEUTSCH 3WAY PLUG WEDGE	125119 DEUTSCH 4WAY PLUG WEDGE	125121 DEUTSCH 6WAY MALE WEDGE	125123 DEUTSCH 8WAY MALE WEDGE	125103 DEUTSCH 14GA PIN FOR RECEPTACLE

PRODUCT CATEGORY: Q

### Deutsch DT Connectors & Terminals II with Crimping & Removal Tools

26 Items • 134 Pcs  
IBS No. 780R



Packaged in a Locking Steel Drawer for Easy Storage & Organization

**IBS, Inc.**  
SPECIALTY PRODUCTS FOR MAINTENANCE & REPAIR  
INDUSTRIALBOLT.COM • 800-678-1506

**Metripack 280 Series Electrical Connectors & Tools**

Assortment No. 781R

125204 METRIPACK 1 PIN MALE CONNECTOR BODY	125208 METRIPACK 1 PIN FEMALE CONNECTOR BODY	125218 METRIPACK 1 PIN T.P.A. MALE & FEMALE	125201 METRIPACK GREEN CABLE SEAL 18-16 & 20-18 GAUGE	125212 METRIPACK 16-18 GAUGE MALE TERMINAL	125325 - CRIMPING TOOL 125226 - REMOVAL TOOL
125205 METRIPACK 2 PIN MALE CONNECTOR BODY	125209 METRIPACK 2 PIN FEMALE CONNECTOR BODY	125219 METRIPACK 2 PIN T.P.A. MALE & FEMALE	125202 METRIPACK GRAY CABLE SEAL 14-16 GAUGE	125215 METRIPACK 16-18 GAUGE FEMALE TERMINAL	
125206 METRIPACK 3 PIN MALE CONNECTOR BODY	125210 METRIPACK 3 PIN FEMALE CONNECTOR BODY	125220 & 125221 METRIPACK 3 PIN T.P.A. MALE AND FEMALE	125203 METRIPACK BLUE CABLE SEAL 12-14 GAUGE	125213 METRIPACK 12-14 GAUGE MALE TERMINAL	
125207 METRIPACK 5 PIN MALE CONNECTOR BODY	125211 METRIPACK 5 PIN FEMALE CONNECTOR BODY	125222 & 125223 METRIPACK 5 PIN T.P.A. MALE AND FEMALE	125224 METRIPACK CAVITY PLUG	125216 METRIPACK 12-14 GAUGE FEMALE TERMINAL	

PRODUCT CATEGORY: Q

### Metripack 280 Series II with Crimping & Removal Tools

22 Items • 432 Pcs  
IBS No. 781R



Packaged in a Locking Steel Drawer for Easy Storage & Organization

ASSORTMENTS



# IBS, INCORPORATED

## Assortments - Electrical (Q)

ASSORTMENTS

IBS, Inc. SPECIALTY PRODUCTS FOR MAINTENANCE & REPAIR INDUSTRIALBOLT.COM • • • • 800-670-1506		7" Colored Cable Tie Wraps	
BL-7-50 7" 50LB BLUE NYLON TIE		GY-7-50 7" 50LB GRAY NYLON TIE	
Y-7-50 7" 50LB YELLOW NYLON TIE		GR-7-50 7" 50LB GREEN NYLON TIE	
R-7-50 7" 50LB RED NYLON TIE		P-7-50 7" 50LB PURPLE NYLON TIE	
BR-7-50 7" 50LB BROWN NYLON TIE		FO-7-50 7" 50LB FLUORESCENT ORANGE NYLON TIE	
FB-7-50 7" 50LB FLUORESCENT BLUE NYLON TIE		FP-7-50 7" 50LB FLUORESCENT PINK NYLON TIE	
FY-7-50 7" 50LB FLUORESCENT YELLOW NYLON TIE		FG-7-50 7" 50LB FLUORESCENT GREEN NYLON TIE	

Assortment No. 786R

PRODUCT CATEGORY: Q

### 8" Colored Cable Tie Wraps

12 Items • 1200 Pcs

IBS No. 786R



Packaged in a Locking Steel Drawer for Easy Storage & Organization

IBS, Inc. SPECIALTY PRODUCTS FOR MAINTENANCE & REPAIR INDUSTRIALBOLT.COM • • • • 800-670-1506		Crimp & Seal Long Neck Terminals	
136025 22-18 CRIMP & SEAL #6 LONG NECK RING		136029 16-14 CRIMP & SEAL #8 LONG NECK RING	
136026 22-18 CRIMP & SEAL #8 LONG NECK RING		136030 16-14 CRIMP & SEAL #10 LONG NECK RING	
136027 22-18 CRIMP & SEAL #10 LONG NECK RING		136031 16-14 CRIMP & SEAL 1/4 LONG NECK RING	
136028 16-14 CRIMP & SEAL #6 LONG NECK RING		136032 16-14 CRIMP & SEAL 5/16 LONG NECK RING	
		136033 16-14 CRIMP & SEAL 3/8 LONG NECK RING	
		136034 12-10 CRIMP & SEAL #8 LONG NECK RING	
		136035 12-10 CRIMP & SEAL #10 LONG NECK RING	
		136036 12-10 CRIMP & SEAL 1/4 LONG NECK RING	
		136037 12-10 CRIMP & SEAL 5/16 LONG NECK RING	
		136038 12-10 CRIMP & SEAL 3/8 LONG NECK RING	

Assortment No. 790R

PRODUCT CATEGORY: Q

### Long Neck Crimp & Seal Terminals

14 Items • 140 Pcs

IBS No. 790R



Packaged in a Locking Steel Drawer for Easy Storage & Organization

IBS, Inc. SPECIALTY PRODUCTS FOR MAINTENANCE & REPAIR INDUSTRIALBOLT.COM • • • • 800-670-1506		Crimp & Seal Wire Ends w/ Long Neck Ring Terminals	
B5110 20-18 CRIMP & SEAL BUTT CONNECTOR		B5118 20-18 #10 CRIMP & SEAL SPADE TERM	
136025 22-18 #6 CRIMP & SEAL LONG NECK RING		136029 16-14 #8 CRIMP & SEAL LONG NECK RING	
136026 22-18 #8 CRIMP & SEAL LONG NECK RING		B5155 20-18 CRIMP & SEAL .250 MALE CONN	
136027 22-18 #10 CRIMP & SEAL LONG NECK RING		B5145 20-18 CRIMP & SEAL .250 FEMALE CONN	
		136030 16-14 #10 CRIMP & SEAL LONG NECK RING	
		B5228 16-14 CRIMP & SEAL #10 SPADE TERM	
		B5255 16-14 CRIMP & SEAL .250 MALE CONN	
		B5245 16-14 CRIMP & SEAL .250 FEMALE CONN	
		136031 16-14 1/4 CRIMP & SEAL LONG NECK RING	
		136033 16-14 3/8 CRIMP & SEAL LONG NECK RING	
		136034 12-10 #8 CRIMP & SEAL LONG NECK RING	
		136035 12-10 1/4 CRIMP & SEAL LONG NECK RING	
		136036 12-10 1/4 CRIMP & SEAL LONG NECK RING	
		B5310 12-10 CRIMP & SEAL BUTT CONNECTOR	
		B5331 12-10 CRIMP & SEAL #10 SPADE TERM	
		B5355 12-10 CRIMP & SEAL .250 MALE CONN	
		B5345 12-10 CRIMP & SEAL .250 FEMALE CONN	

Assortment No. 791R

PRODUCT CATEGORY: Q

### Crimp & Seal Terminals with Long Neck Ring Terminals

24 Items • 240 Pcs

IBS No. 791R



Packaged in a Locking Steel Drawer for Easy Storage & Organization

# IBS, INCORPORATED

## Assortments - Electrical (Q)



<b>Optiseal Terminals</b>					
Assortment No. 793R					
<b>B5916</b> 22-18 OPTISEAL BUTT CONNECTOR 	<b>136017</b> 22-18 TO 16-14 OPTISEAL STEP BUTT 	<b>B5914</b> 16-14 OPTISEAL BUTT CONNECTOR 	<b>136016</b> 16-14 TO 12-10 OPTISEAL STEP BUTT 	<b>B5910</b> 12-10 OPTISEAL BUTT CONNECTOR 	<b>136015</b> 12-10 TO 8GA OPTISEAL STEP BUTT CONNECTOR 
<b>136018</b> 24-22 TO 22-18 OPTISEAL STEP BUTT 	<b>136014</b> 22-18 #10 OPTISEAL RING TERMINAL 	<b>136007</b> 16-14 #8 OPTISEAL RING TERMINAL 	<b>136011</b> 16-14 3/8 OPTISEAL RING TERMINAL 	<b>136001</b> 12-10 #10 OPTISEAL RING TERMINAL 	<b>136005</b> 12-10 3/8 OPTISEAL RING TERMINAL 
<b>136012</b> 22-18 #6 OPTISEAL RING TERMINAL 	<b>136023</b> 22-18 .250 FEMALE OPTISEAL CONNECTOR 	<b>136008</b> 16-14 #10 OPTISEAL RING TERMINAL 	<b>136021</b> 16-14 .250 FEMALE OPTISEAL CONNECTOR 	<b>136002</b> 12-10 #10 OPTISEAL RING TERMINAL 	<b>136019</b> 12-10 .250 FEMALE OPTISEAL CONNECTOR 
<b>136013</b> 22-18 #8 OPTISEAL RING TERMINAL 	<b>136024</b> 22-18 .250 MALE OPTISEAL CONNECTOR 	<b>136009</b> 16-14 1/4 OPTISEAL RING TERMINAL 	<b>136039</b> 16-14 .250 MALE OPTISEAL CONNECTOR 	<b>136003</b> 12-10 1/4 OPTISEAL RING TERMINAL 	<b>136020</b> 12-10 .250 MALE OPTISEAL CONNECTOR 

PRODUCT CATEGORY: Q

### Optiseal Terminals

24 Items • 220 Pcs  
IBS No. 793R



Packaged in a Locking Steel Drawer for Easy Storage & Organization

<b>Low Profile and Releasable Cable Tie Wraps</b>	
Assortment No. 796R	
<b>BLP-14-120</b> 14IN 120LB BLACK NYLON LOW PROFILE TIE WRAP 	
<b>BLP-14-50</b> 14IN 50LB BLACK NYLON LOW PROFILE TIE WRAP 	
<b>RB-5-50</b> 5 50LB BLACK RELEASABLE NYLON TIE WRAP 	<b>BLP-11-50</b> 11IN 50LB BLACK NYLON LOW PROFILE TIE WRAP 
<b>RB-8-50</b> 8 50LB BLACK RELEASABLE NYLON TIE WRAP 	<b>BLP-7-50</b> 7IN 50LB BLACK NYLON LOW PROFILE TIE WRAP 
<b>RB-12-50</b> 12 50LB BLACK RELEASABLE NYLON TIE WRAP 	
<b>RB-14-50</b> 14 50LB BLACK RELEASABLE NYLON TIE WRAP 	

PRODUCT CATEGORY: Q

### Black Low Profile Cable Tie Wraps

8 Items • 700 Pcs  
IBS No. 796R



Packaged in a Locking Steel Drawer for Easy Storage & Organization

<b>Dual Wall Shrink Tubing</b>	
Assortment No. 800R	
<b>16486</b> 3/16 X 6IN BLACK DUAL WALL SHRINK TUBE 	<b>16481</b> 3/16 X 6IN RED DUAL WALL SHRINK TUBE 
<b>16487</b> 1/4 X 6IN BLACK DUAL WALL SHRINK TUBE 	<b>16482</b> 1/4 X 6IN RED DUAL WALL SHRINK TUBE 
<b>16488</b> 3/8 X 6IN BLACK DUAL WALL SHRINK TUBE 	<b>16483</b> 3/8 X 6IN RED DUAL WALL SHRINK TUBE 
<b>16489</b> 1/2 X 6IN BLACK DUAL WALL SHRINK TUBE 	<b>16484</b> 1/2 X 6IN RED DUAL WALL SHRINK TUBE 
<b>16490</b> 3/4 X 6IN BLACK DUAL WALL SHRINK TUBE 	<b>16492</b> 3/4 X 6IN RED DUAL WALL SHRINK TUBE 
<b>16491</b> 1IN X 6IN BLACK DUAL WALL SHRINK TUBE 	<b>16493</b> 1IN X 6IN RED DUAL WALL SHRINK TUBE 

PRODUCT CATEGORY: Q

### Dual Wall Shrink Tubing

12 Items • 72 Pcs  
IBS No. 800R



Packaged in a Locking Steel Drawer for Easy Storage & Organization

ASSORTMENTS



# IBS, INCORPORATED

## Assortments - Electrical (Q)

ASSORTMENTS

Vinyl Coated Clamps			
Assortment No. 802R			
16540 1/4ID 1/4 STUD VINYL COATED LOOM CLAMP	16531 1/2ID 1/4 STUD VINYL COATED LOOM CLAMP	16547 1ID 3/8 STUD VINYL COATED LOOM CLAMP	16548 1-1/2ID 3/8 STUD VINYL COATED LOOM CLAMP
16541 5/16ID 3/8STUD VINYL COATED LOOM CLAMP	16534 5/8ID 1/4 STUD VINYL COATED LOOM CLAMP	16533 1-1/4ID 13/32 STUD VINYL COATED LOOM CLAMP	16550 2ID 3/8 STUD VINYL COATED LOOM CLAMP
16530 3/8ID 1/4 STUD VINYL COATED LOOM CLAMP	16545 3/4ID 3/8 STUD VINYL COATED LOOM CLAMP		

PRODUCT CATEGORY: Q

### Vinyl Coated Clamps

10 Items • 197 Pcs

IBS No. 802R



Packaged in a Locking Steel Drawer for Easy Storage & Organization

ATR, ATL & ATM Low-Profile Fuses				
Assortment No. 822R				
ATR5 5AMP MICRO2 FUSE 32V TAN FUSE	ATR7-1/2 7-1/2AMP MICRO2 FUSE 32V BROWN FUSE	ATR10 10AMP MICRO2 FUSE 32V RED FUSE	ATR15 15AMP MICRO2 FUSE 32V BLUE FUSE	ATR20 20AMP MICRO2 FUSE 32V YELLOW FUSE
ATR25 25AMP MICRO2 FUSE 32V CLEAR FUSE	ATR30 30AMP MICRO2 FUSE 32V GREEN FUSE	ATL5 5AMP MICRO3 FUSE 32V TAN FUSE	ATL7-1/2 7-1/2AMP MICRO3 FUSE 32V BROWN FUSE	ATL10 10AMP MICRO3 FUSE 32V RED FUSE
ATL15 15AMP MICRO3 FUSE 32V BLUE FUSE	ATM5LP AUTO FUSE ATM LOW PROFILE 5AMP	ATM7-1/2LP AUTO FUSE ATM LOW PROFILE 7-1/2AMP	ATM10LP AUTO FUSE ATM LOW PROFILE 10AMP	ATM15LP AUTO FUSE ATM LOW PROFILE 15AMP
ATM20LP AUTO FUSE ATM LOW PROFILE 20AMP	ATM25LP AUTO FUSE ATM LOW PROFILE 25AMP	ATM30LP AUTO FUSE ATM LOW PROFILE 30AMP		

PRODUCT CATEGORY: Q

### ATR, ATL & ATM Low Profile Fuses

18 Items • 160 Pcs

IBS No. 822R



Packaged in a Locking Steel Drawer for Easy Storage & Organization

Micro Cartridge Fuses					
Assortment No. 823R					
FMX-20 20AMP BLUE MAXI FUSE JCASE	FMX-25 25AMP WHITE MAXI FUSE JCASE	FMX-30 30AMP PINK MAXI FUSE JCASE	FMX-40 40AMP GREEN MAXI FUSE JCASE	FMX-50 50AMP RED MAXI FUSE JCASE	FMX-60 60AMP YELLOW MAXI FUSE JCASE
FMX-20LP 20AMP BLUE LP MAXI FUSE JCASE LP - LOW PROFILE	FMX-25LP 25AMP WHITE LP MAXI FUSE JCASE LP - LOW PROFILE	FMX-30LP 30AMP PINK LP MAXI FUSE JCASE LP - LOW PROFILE	FMX-40LP 40AMP GREEN LP MAXI FUSE JCASE LP - LOW PROFILE	FMX-50LP 50AMP RED LP MAXI FUSE JCASE LP - LOW PROFILE	FMX-60LP 60AMP YELLOW LP MAXI FUSE JCASE LP - LOW PROFILE
FMM15 15AMP MCASE FUSE 32V GRAY	FMM20 20AMP MCASE FUSE 32V BLUE	FMM25 25AMP MCASE FUSE 32V WHITE	FMM30 30AMP MCASE FUSE 32V PINK	FMM40 40AMP MCASE FUSE 32V GREEN	FMS15 15AMP MCASE FUSE 32V GRAY SLOTTED
FMS20 20AMP MCASE FUSE 32V BLUE SLOTTED	FMS25 25AMP MCASE FUSE 32V WHITE SLOTTED	FMS30 30AMP MCASE FUSE 32V PINK SLOTTED	FMS40 40AMP MCASE FUSE 32V GREEN SLOTTED	FMS50 50AMP MCASE FUSE 32V RED SLOTTED	FMS60 60AMP MCASE FUSE 32V YELLOW SLOTTED

PRODUCT CATEGORY: Q

### Micro Cartridge Fuses

24 Items • 48 Pcs

IBS No. 823R



Packaged in a Locking Steel Drawer for Easy Storage & Organization



IBS, Inc. SPECIALTY PRODUCTS FOR MAINTENANCE & REPAIR INDUSTRIALBOLTY.COM ●●● 800-678-1906		Automotive Circuit Breakers ATM & ATC						Assortment No. 824R
CB212-10 10AMP ATM MINI CIRC BREAKER II	CB212-15 15AMP ATM MINI CIRCUIT BREAKER II	CB212-20 20AMP ATM MINI CIRCUIT BREAKER II	CB212-25 25AMP ATM MINI CIRCUIT BREAKER II	CB212-30 30AMP ATM MINI CIRCUIT BREAKER II	CB233-05 5AMP ATM MINI RESET CB TYPE III	CB233-10 10AMP ATM MINI RESET CB TYPE III	CB233-15 15AMP ATM MINI RESET CB TYPE III	
CB233-20 20AMP ATM MINI RESET CB TYPE III	CB233-25 25AMP ATM MINI RESET CB TYPE III	CB233-30 30AMP ATM MINI RESET CB TYPE III	CB221-10 10AMP ATC CIRCUIT BREAKER TYPE I	CB221-15 15AMP ATC CIRCUIT BREAKER TYPE I	CB221-20 20AMP ATC CIRCUIT BREAKER TYPE I	CB221-25 25AMP ATC CIRCUIT BREAKER TYPE I	CB221-30 30AMP ATC CIRCUIT BREAKER TYPE I	
CB223-10 10AMP ATC 24V RESET CB TYPE III	CB223-15 15AMP ATC 24V RESET CB TYPE III	CB223-20 20AMP ATC 24V RESET CB TYPE III	CB223-25 25AMP ATC 24V RESET CB TYPE III	CB223-30 30AMP ATC 24V RESET CB TYPE III	CB227-10 10AMP ATC RESET CB TYPE III RED	CB227-15 15AMP ATC RESET CB TYPE III BLUE	CB227-20 20AMP ATC RESET CB TYPE III YELLOW	
CB227-25 25AMP ATC RESET CB TYPE III WHITE	CB227-30 30AMP ATC RESET CB TYPE III GREEN	UCB-10 10AMP ATM CB SNAP OFF BLADES	UCB-15 15AMP ATM CB SNAP OFF BLADES	UCB-20 20AMP ATM CB SNAP OFF BLADES	UCB-25 25AMP ATM CB SNAP OFF BLADES	UCB-30 30AMP ATM CB SNAP OFF BLADES		

PRODUCT CATEGORY: Q

### Automotive Circuit Breakers ATM & ATC

31 Items • 46 Pcs  
IBS No. 824R



Packaged in a Locking Steel Drawer  
for Easy Storage & Organization

IBS, Inc. SPECIALTY PRODUCTS FOR MAINTENANCE & REPAIR INDUSTRIALBOLTY.COM ●●● 800-678-1906		Eco-Max Battery Ends & Shrink Tubing		Assortment No. 835R
BAL1038 1/0 X 3/8ST HVY DUTY TUBULAR	BAL2038 2/0 X 3/8ST HVY DUTY TUBULAR	B3405 2-4/0GA X 6" RED HVY WALL	B3505 2-4/0GA X 6" BLACK HVY	
E2110 ECOMAX BATT TERM 1/0 GA POS	E2112 ECOMAX BATT TERM 2/0 GA POS			
E2109 ECOMAX BATT TERM 1/0 GA NEG	E2111 ECOMAX BATT TERM 2/0 GA NEG			

PRODUCT CATEGORY: Q

### EcoMax Battery Ends & Shrink Tubing

8 Items • 34 Pcs  
IBS No. 835R



Packaged in a Locking Steel Drawer  
for Easy Storage & Organization

IBS, Inc. SPECIALTY PRODUCTS FOR MAINTENANCE & REPAIR INDUSTRIALBOLTY.COM ●●● 800-678-1906		Multilink Wire Ends w/ Thermal Indicator Butt Connectors				Assortment No. 859R
BTS518 20-18 MULTILINK BUTT CONNECTOR WITH THERMAL INDICATOR	B5530 20-18 TO 16-14 MULTILINK STEP	BT5514 16-14 MULTILINK BUTT CONNECTOR WITH THERMAL INDICATOR	B5540 16-14 TO 12-10 MULTILINK STEP	BTS510 12-10 MULTILINK BUTT CONNECTOR WITH THERMAL INDICATOR	B5550 12-10 TO 8GA MULTILINK STEP	
125702 20-18 MULTILINK #8 RING TERM	125713 20-18 MULTILINK #10 SPADE TERM	125705 16-14 MULTILINK #8 RING TERM	125714 16-14 MULTILINK #10 SPADE TERM	125709 12-10 MULTILINK #10 RING TERM	125715 12-10 MULTILINK #10 SPADE TERM	
125703 20-18 MULTILINK #10 RING TERM	125716 20-18 MULTILINK .250 MALE	125706 16-14 MULTILINK #10 RING TERM	125718 16-14 MULTILINK .250 MALE	125710 12-10 MULTILINK 1/4 RING TERM	125720 12-10 MULTILINK .250 MALE	
125704 20-18 MULTILINK 1/4 RING TERM	125717 20-18 MULTILINK .250 FEMALE	125707 16-14 MULTILINK 1/4 RING TERM	125719 16-14 MULTILINK .250 FEMALE	125711 12-10 MULTILINK 3/8 RING TERM	125721 12-10 MULTILINK .250 FEMALE	

PRODUCT CATEGORY: Q

### Multilink Wire Ends w/ Thermal Indicator Butt Connectors

24 Items • 175 Pcs  
IBS No. 859R



Packaged in a Locking Steel Drawer  
for Easy Storage & Organization

ASSORTMENTS



# IBS, INCORPORATED

## Assortments - Electrical (Q) / Hose Clamps (R)

ASSORTMENTS

**IBS, Inc.**  
SPECIALTY PRODUCTS FOR MAINTENANCE & REPAIR  
INDUSTRIALBOLT.COM © © © 800-670-1906

Hydralink Connector & Shrink Tubing

Assortment No. 865R

B3310 24-12 AWG HI FLOW ADHESIVE SHRINK TUBING 			
B3311 22-10 AWG HI FLOW ADHESIVE SHRINK TUBING 			
B3312 16-8 AWG HI FLOW ADHESIVE SHRINK TUBING 			
B3313 14-4 AWG HI FLOW ADHESIVE SHRINK TUBING 			
B5614 22-14 HYDRALINK CLOSED END CONNECTOR 	B5716 20-18 HYDRALINK IN LINE BUTT CONNECTOR 	B5714 16-14 HYDRALINK IN LINE BUTT CONNECTOR 	B5710 12-10 HYDRALINK IN LINE BUTT CONNECTOR 
B5610 18-10 HYDRALINK CLOSED END CONNECTOR 	B5610 20-18 X 16-14 CRIMP & SEAL STEP BUTT CON 	B5620 16-14 12-10 CRIMP & SEAL STEP BUTT CON 	B5630 12-10 TO 8GA CRIMP & SEAL STEP BUTT CON 

PRODUCT CATEGORY: Q

### Hydralink Connector & Shrink Tubing

12 Items • 78 Pcs

IBS No. 865R



Packaged in a Locking Steel Drawer for Easy Storage & Organization

**IBS, Inc.**  
SPECIALTY PRODUCTS FOR MAINTENANCE & REPAIR  
INDUSTRIALBOLT.COM © © © 800-670-1906

Two-Ear Hose Clamps

Assortment No. 756R

60041 5/32 TWO-EAR CLAMP .122-.161 	60305 3/16 TWO-EAR CLAMP .134-.197 	60507 1/4 TWO-EAR CLAMP .197-.276 	60709 5/16 TWO-EAR CLAMP .276-.354 	60811 3/8 TWO-EAR CLAMP .319-.433 	61098 EAR CLAMP STANDARD JAW PINNERS CRIMPER 
61113 1/2 TWO-EAR CLAMP .425-.512 	61315 9/16 TWO-EAR CLAMP .492-.591 	61518 5/8 TWO-EAR CLAMP .591-.709 	61720 3/4 TWO-EAR CLAMP .638-.787 	62023 7/8 TWO-EAR CLAMP .748-.906 	
62327 1" TWO-EAR CLAMP .886-1.063 	62831 1-1/8 TWO-EAR CLAMP 1.063-1.220 	63134 1-5/16 TWO-EAR CLAMP 1.154-1.339 	63437 1-7/16 TWO-EAR CLAMP 1.261-1.457 	63740 1-1/2 TWO-EAR CLAMP 1.378-1.575 	

PRODUCT CATEGORY: R

### Two-Ear Hose Clamps

16 Items • 51 Pcs

IBS No. 756R



Packaged in a Locking Steel Drawer for Easy Storage & Organization

# IBS, INCORPORATED

## Assortments - Adhesives (SA)



### Loctite Thread Lockers

8 Items • 8 Pcs  
IBS No. 671R



Packaged in a Locking Steel Drawer for Easy Storage & Organization

### Loctite Glues & Epoxies

8 Items • 12 Pcs  
IBS No. 674R





Packaged in a Locking Steel Drawer for Easy Storage & Organization

### Loctite 10ml Threadlockers

8 Items • 8Pcs  
IBS No. 676R





Packaged in a Locking Steel Drawer for Easy Storage & Organization

IBS, Inc. SPECIALTY PRODUCTS FOR MAINTENANCE & REPAIR INDUSTRIALBOLT.COM © © © 800-678-1906				Loctite Thread Lockers
				Assortment No. 671R
37087 LOCTITE 19GM BLUE	37686 LOCTITE 19GM RED THREADLOCKER	51604 LOCTITE TIGHT ANAEROBIC GEL	21348 LOCTITE PRIMER-N AEROSOL 4.5OZ	
24231 LOCTITE REMOVABLE	26331 LOCTITE 263 RED HIGH STRENGTH OIL RESISTANT THREADLOCKER	29031 LOCTITE 50ML GREEN MEDIUM	27240 LOCTITE 50ML HT TEMP HI	

PRODUCT CATEGORY: SA

IBS, Inc. SPECIALTY PRODUCTS FOR MAINTENANCE & REPAIR INDUSTRIALBOLT.COM © © © 800-678-1906				Loctite Glues & Epoxies
				Assortment No. 674R
39202 LOCTITE QUICKTITE INSTANT	74510 MULTI-PURPOSE ADHESIVE 3.7 OZ E6000	97434 FIXMASTER 2 PART 4 MINUTE	EQ115 STATIC MIXER	
20251 LOCTITE 330 DEPEND ADHESIVE	21425 LOCTITE .12 OZ FAST CURE	96604 LOCTITE FIXMASTER FAST SET	EQ016 DISPENSING GUN	

PRODUCT CATEGORY: SA

IBS, Inc. SPECIALTY PRODUCTS FOR MAINTENANCE & REPAIR INDUSTRIALBOLT.COM © © © 800-678-1906				Loctite 10ml Threadlockers
				Assortment No. 676R
37087 LOCTITE 19GM BLUE THREADLOCKER STICK	37686 LOCTITE 19GM RED THREADLOCKER STICK	51604 LOCTITE TIGHT ANAEROBIC GEL 50ML	21348 LOCTITE PRIMER-N AEROSOL 4.5OZ	
24221 BLUE REMOVABLE THREADLOCKER 10ml	26221 262 RED HIGH STRENGTH THREADLOCKER 10ml	29021 290 GREEN MEDIUM THREADLOCKER 10ml	32526 2760 RED HIGH THREADLOCKER 10ml	

PRODUCT CATEGORY: SA



ASSORTMENTS



# IBS, INCORPORATED

## Assortments - Adhesives (SA)

ASSORTMENTS

 <b>IBS, Inc.</b> <small>SPECIALTY PRODUCTS FOR MAINTENANCE &amp; REPAIR  INDUSTRIALBOLT.COM © © © 800-678-1506</small>						<b>Loctite RTV Tube Assortment</b>					
						Assortment 776R					
59530 LOCTITE SUPERFLEX 80ML TUBE RTV CLEAR	59430 LOCTITE SUPERFLEX 80ML TUBE RTV WHITE	59330 LOCTITE SUPERFLEX 80ML TUBE RTV BLACK	30560 LOCTITE SUPERFLEX 80ML TUBE RTV BLUE	59630 LOCTITE HI TEMP 80ML TUBE RTV RED	18718 LOCTITE GASKET MAKER 70ML TUBE RTV GRAY						
						<b>PRODUCT CATEGORY: SA</b>					

**Loctite RTV Tube Assortment**  
**6 Items • 12 Pcs**  
**IBS No. 776R**



**Packaged in a Locking Steel Drawer for Easy Storage & Organization**

 <b>IBS, Inc.</b> <small>SPECIALTY PRODUCTS FOR MAINTENANCE &amp; REPAIR  INDUSTRIALBOLT.COM © © © 800-678-1506</small>						<b>Thread Locker, Anti-Seize &amp; Dielectric Grease</b>					
						Assortment 833R					
74242 MEDIUM STRENGTH THREADLOCKER GEL BLUE 35ML	74262 HIGH STRENGTH THREADLOCKER GEL RED 35ML	74151 ANTI SEIZE GEL ALUMINUM 35ML	74152 ANTI SEIZE GEL COPPER 35ML	74159 PTFE PIPE SEALANT GEL 35ML	74160 DIELECTRIC GREASE PUMP 35ML						
						<b>PRODUCT CATEGORY: SA</b>					

**Thread Locker, Anti-Seize & Dielectric Grease**

**6 Items • 12 Pcs**  
**IBS No. 833R**



**Packaged in a Locking Steel Drawer for Easy Storage & Organization**

# IBS, INCORPORATED

## Assortments - Coatings (SCO) / Welding (SW)



IBS, Inc. SPECIALTY PRODUCTS FOR MAINTENANCE & REPAIR INDUSTRIALBOLT.COM • • • 800-870-1506		Industrial Markers	
Assortment No. 695R			
96520 DURA INK 5 BLACK EXTENDED MICRO TIP		96823 VALVE ACTION PAINT PEN-BLACK	
96023 DURA INK 15 BLACK FINE TIP		96822 VALVE ACTION PAINT PEN- RED	
96022 DURA INK 15 RED FINE TIP		96821 VALVE ACTION PAINT PEN-YELLOW	
96025 DURA INK 15 BLUE FINE TIP		96820 VALVE ACTION PAINT PEN-WHITE	
96026 DURA INK 15 GREEN FINE TIP		96575 DURA INK 20 BLACK RETRACTABLE BULLET TIP	
96283 DURA INK BLACK DUAL TIP MARKER		96576 DURA INK 20 RED RETRACTABLE BULLET TIP	
96282 DURA INK RED DUAL TIP MARKER			

PRODUCT CATEGORY: SCO

### Industrial Markers

13 Items • 27 Pcs  
IBS No. 695R



Packaged in a Locking Steel Drawer for Easy Storage & Organization

IBS, Inc. SPECIALTY PRODUCTS FOR MAINTENANCE & REPAIR INDUSTRIALBOLT.COM • • • 800-870-1506		Industrial Markers & Welder's Pencils	
Assortment No. 807R			
96023 DURA INK 15 BLACK FINE BULLET TIP		96823 VALVE ACTION PAINT PEN-BLACK	
96022 DURA INK 15 RED FINE TIP		96822 VALVE ACTION PAINT PEN- RED	
96025 DURA INK 15 BLUE FINE TIP		96821 VALVE ACTION PAINT PEN-YELLOW	
96026 DURA INK 15 GREEN FINE TIP		96820 VALVE ACTION PAINT PEN-WHITE	
96101 MARKAL SILVER STREAK PENCIL WELDERS		96575 DURA INK 20 BLACK RETRACTABLE BULLET TIP	
96006 MARKAL SILVER STREAK MECHANICAL WELDERS ROUND PENCIL		96576 DURA INK 20 RED RETRACTABLE BULLET TIP	

PRODUCT CATEGORY: SCO

### Industrial Markers & Welder's Pencils

12 Items • 23 Pcs  
IBS No. 807R



Packaged in a Locking Steel Drawer for Easy Storage & Organization

IBS, Inc. SPECIALTY PRODUCTS FOR MAINTENANCE & REPAIR INDUSTRIALBOLT.COM • • • 800-870-1506		Vinculum Welding Electrode Assortment Steel & Cast Iron	
Assortment No. 754R			
46015 1/8 GROOVY VINCLUM Premium High Speed Gouging And Chamfering Electrode	VINCLUM™ M™ GROOVY is designed to remove metal fast and efficiently without special skills or special equipment, expensive gases or compressed gas. Color: Gray	Technical Data: Current..... AC or DC Straight Polarity (Electrode -)	
46031 1/8 MRO CAST VINCLUM Specially Designed for Dirty Cast Iron - The Problem Solver to Use When All Others Fail	Vinculum™ MRO CAST has a unique flux coating on alloyed core wire which produces dense, strong crack-resistant welds on all types of cast iron. Especially good for contaminated, old, oil soaked, dirty base metal. Also recommended for joining cast iron to steel. Use on gray, ductile, malleable, and nodular cast iron. Deposits are machinable. Color: Dark Gray/Black	Technical Data: Tensile Strength..... up to 75,000 psi (517N/mm <sup>2</sup> ) Hardness..... Brinell 210 Current..... AC or DC Reverse Polarity (Electrode+)	
46012 1/8 HI ALLOY VINCLUM A Superior Super Strength Electrode For Welding Alloy and Dissimilar Steels	VINCLUM™ Hi-Alloy is designed to weld low, medium and high alloy steels where super strength and high quality welds are desirable. Color: Blue	Technical Data: Tensile Strength..... welded..... up to 120,000 psi work hardened..... up to 180,000 psi Yield strength..... up to 90,000 psi Elongation %..... approx. 28% Hardness (HRC)..... approx. 320 Current..... AC or DC Reverse Polarity (Electrode+)	
46042 1/8 VINCLUM DIVERSE-ALLOY A Premium High Strength Electrode For Welding High Strength Low Alloy Steels and Abrasion	DIVERSE ALLOY is excellent for welding most high-strength low alloy steels. It is recommended for the repair of heavy equipment and joints subjected to high stresses because of its high strength. The moisture resistant coating assures dense, crack free deposits for outstanding impact resistance at all temperatures, and X-ray quality welds. Color: White	Technical Data: Tensile Strength..... up to 93,000 psi (70 kg/mm <sup>2</sup> ) Elongation %..... approx. 32 Current..... AC or DC Reverse Polarity (Electrode+)	
46004 1/8 MID ALLOY VINCLUM Premium General Purpose Alloy For Low Carbon Steels	Vinculum™ Mid-Alloy is designed to operate on all welding machines, even small AC type transformers when the open circuit voltage is very low. The specially formulated coating protects the deposit from adverse conditions normally encountered in maintenance welding. An ideal electrode for field repair work and out of position welding. Color: Red	Technical Data: Tensile Strength..... up to 80,000 psi Yield Strength..... up to 68,000 psi Elongation %..... approx. 24% Current..... AC or DC either polarity	

PRODUCT CATEGORY: SW

### Vinculum Welding Electrodes

### Steel & Cast Iron

5 Items • 9 lbs  
IBS No. 754R



Packaged in a Locking Steel Drawer for Easy Storage & Organization

ASSORTMENTS



# IBS, INCORPORATED

## Assortments - Hardware & Springs (U)

ASSORTMENTS

IBS, Inc. SPECIALTY PRODUCTS FOR MAINTENANCE & REPAIR INDUSTRIALINDY.COM © © © 800-878-1986						Universal Extension Springs					
Assortment No. 115R											
47030 1/2 OD X 9-5/8 EXTENSION SPRING						47045 1-1/16 OD X 5-1/2" EXTENSION SPRING					
47031 5/8 OD X 8-1/2 EXTENSION SPRING						47044 19/32 OD X 5" EXTENSION SPRING					
47032 13/16 OD X 8-1/2 EXTENSION SPRING						47043 7/16 OD X 7" EXTENSION SPRING					
47033 1" OD X 8-1/2 EXTENSION SPRING						47042 21/64 OD X 5-7/8 EXTENSION SPRING					
47038 1/4 OD X 4" EXTENSION SPRING				47039 3/8 OD X 3" EXTENSION SPRING				47040 7/16 OD X 4-1/2 EXTENSION SPRING			
47041 1/4 OD X 5" EXTENSION SPRING				47034 1/2 OD X 1-9/8 EXTENSION SPRING				47035 19/64 OD X 19/16 EXTENSION SPRING			
47036 11/32 OD X 1-13/32 EXTENSION SPRING				47037 15/64 OD X 1-1/32 EXTENSION SPRING				47046 23/32 OD X 3-3/16 EXTENSION SPRING			
47047 47/64 OD X 3-7/8 EXTENSION SPRING											

PRODUCT CATEGORY: U

### Universal Extension Springs

18 Items • 70 Pcs  
IBS No. 115R



Packaged in a Locking Steel Drawer for Easy Storage & Organization

IBS, Inc. SPECIALTY PRODUCTS FOR MAINTENANCE & REPAIR INDUSTRIALINDY.COM © © © 800-878-1986						Universal Compression Springs					
Assortment No. 116R											
47000 5/16 OD X 10 COMPRESSION*						47004 1/2 OD X 1 COMPRESSION			47005 5/16 OD X 1-19/32		
47001 3/8 OD X 12 COMPRESSION*						47006 3/16 OD X 1 COMPRESSION*			47007 3/8 OD X 3/4 COMPRESSION		
47002 5/8 OD X 12 COMPRESSION*						47008 1-1/64 OD X 3-1/8 COMPRESSION					
47003 7/8 OD X 12 COMPRESSION*						47009 11/16 OD X 4 COMPRESSION*					
47010 19/32 OD X 2-1/2 COMPRESSION				47011 5/8 OD X 2-3/4 COMPRESSION				47012 1/2 OD X 2-1/2 COMPRESSION			
47013 7/16 OD X 2-7/8 COMPRESSION				47014 15/16 OD X 2-1/4 COMPRESSION				47015 7/8 OD X 2-1/32 COMPRESSION			
47016 7/8 OD X 3 COMPRESSION SPRING*				47017 1-1/16 OD X 3-5/8 COMPRESSION							

PRODUCT CATEGORY: U

### Universal Compression Springs

18 Items • 54 Pcs  
IBS No. 116R

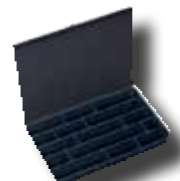

Packaged in a Locking Steel Drawer for Easy Storage & Organization

IBS, Inc. SPECIALTY PRODUCTS FOR MAINTENANCE & REPAIR INDUSTRIALINDY.COM © © © 800-878-1986						Roller Chain Links Offset Chain Links					
Assortment No. 208P											
20135 #35 .375 PITCH CONN. LINK				20140 #40 .500 PITCH CONN. LINK				20141 #41 .500 PITCH CONN. LINK			
20150 #50 .625 PITCH CONN. LINK				20160 #60 .750 PITCH CONN. LINK				20300 #1 CHAIN BREAKER			
20180 #80 1.00 PITCH CONN. LINK											
20235 #35 .375 PITCH OFFSET (HALF)				20240 #40 .500 PITCH OFFSET (HALF)				20241 #41 .500 PITCH OFFSET (HALF)			
20250 #50 .625 PITCH OFFSET (HALF)				20260 #60 .750 PITCH OFFSET (HALF)							
20280 #80 1.00 PITCH OFFSET (HALF)											

PRODUCT CATEGORY: U

### Roller Chain Links Offset Chain Links

13 Items • 67 Pcs  
IBS No. 208P



Packaged in a Locking Steel Drawer for Easy Storage & Organization



<b>IBS, Inc.</b> <small>SPECIALTY PRODUCTS FOR MAINTENANCE &amp; REPAIR                  INDUSTRIALBOLT.COM © P.O. 800-678-1906</small>			Quick Links & Spring Links
			Assortment No. 748R
22040 1/8 QUICK LINK ZP 	22041 3/16 QUICK LINK ZP 	22042 1/4 QUICK LINK ZP 	
22043 5/16 QUICK LINK ZP 	22044 3/8 QUICK LINK ZP 	22045 1/2 QUICK LINK ZP 	
22047 3/16 SPRING LINK ZP 	22048 1/4 SPRING LINK ZP 	22049 5/16 SPRING LINK ZP 	
22050 3/8 SPRING LINK ZP 	22051 1/2 SPRING LINK ZP 		

PRODUCT CATEGORY: U

### Quick Links & Spring Links

11 Items • 72 Pcs  
IBS No. 748R



Packaged in a Locking Steel Drawer for Easy Storage & Organization

<b>IBS, Inc.</b> <small>SPECIALTY PRODUCTS FOR MAINTENANCE &amp; REPAIR                  INDUSTRIALBOLT.COM © P.O. 800-678-1906</small>				Automotive Couplers, Plugs and Flexeel Repair Kit
				Assortment No. 718R
C2 1/4 COUPLER 1/4 FPT AUTO 	130789 SPLICER FOR 3/8 POLYURETHANE 	130791 1/4NPT X 3/8 HOSE SWIV 	11420 HOSE & TUBING CUTTER UP TO 1-1/4 	
C1 1/4 COUPLER 1/4 MPT AUTO 				
CP2 1/4 PLUG 1/4 FPT AUTO 				
CP1 1/4 PLUG 1/4 MPT AUTO 				

PRODUCT CATEGORY: VA

### Automotive Couplers, Plugs & Flexeel Repair Kit

9 Items • 36 Pcs  
IBS No. 717R



Packaged in a Locking Steel Drawer for Easy Storage & Organization

<b>IBS, Inc.</b> <small>SPECIALTY PRODUCTS FOR MAINTENANCE &amp; REPAIR                  INDUSTRIALBOLT.COM © P.O. 800-678-1906</small>				Automotive Couplers, Plugs and Hose Repair Kit
				Assortment No. 719R
C2 1/4 COUPLER 1/4 FPT AUTO 	VG-6 VINYL GUARD FOR 3/8 AIR HOSE 	AM7328 21/32 I.D. FERRULE BRASS 	11420 HOSE & TUBING CUTTER UP TO 1-1/4 	
C1 1/4 COUPLER 1/4 MPT AUTO 		10406B-106 3/8 LONG BARB UNION 		
CP2 1/4 PLUG 1/4 FPT AUTO 	10506B-104 3/8 X 1/4 M. LONG BARB H. END 			
CP1 1/4 PLUG 1/4 MPT AUTO 				

PRODUCT CATEGORY: VA

### Automotive Couplers, Plugs & Hose Repair Kit

9 Items • 36 Pcs  
IBS No. 719R



Packaged in a Locking Steel Drawer for Easy Storage & Organization





ASSORTMENTS



# IBS, INCORPORATED

## Assortments - Air Fittings (VA) / Grease Fittings (VG)

ASSORTMENTS

IBS, Inc. SPECIALTY PRODUCTS FOR MAINTENANCE & REPAIR INDUSTRIALBOLTY.COM • 800-478-1906		Pressure Washer Couplers, Plugs and Nozzles		Assortment No. 831R
CST3B 1/4 MPT STRAIGHT THRU COUPLER BRASS FOR PRESSURE WASHER	CST5B 3/8 MPT STRAIGHT THRU COUPLER BRASS FOR PRESSURE WASHER	130560 PRESSURE WASHER NOZZLE 0 DEGREE RED		
CST4B 1/4 FPT STRAIGHT THRU COUPLER BRASS FOR PRESSURE WASHER	CST6B 3/8 FPT STRAIGHT THRU COUPLER BRASS FOR PRESSURE WASHER	130561 PRESSURE WASHER NOZZLE 15 DEGREE YELLOW		
CPST3 1/4 MPT STRAIGHT THRU COUPLER PLUG STEEL FOR PRESSURE WASHER	CPST5 3/8 MPT STRAIGHT THRU COUPLER PLUG STEEL FOR PRESSURE WASHER	130562 PRESSURE WASHER NOZZLE 25 DEGREE GREEN		
CPST4 1/4 FPT STRAIGHT THRU COUPLER PLUG STEEL FOR PRESSURE WASHER	CPST6 3/8 FPT STRAIGHT THRU COUPLER PLUG STEEL FOR PRESSURE WASHER	130563 PRESSURE WASHER NOZZLE 40 DEGREE WHITE		

PRODUCT CATEGORY: VA

### Pressure Washer Couplers, Plugs & Nozzles

12 Items • 32 Pcs  
IBS No. 831R



Packaged in a Locking Steel Drawer for Easy Storage & Organization

IBS, Inc. SPECIALTY PRODUCTS FOR MAINTENANCE & REPAIR INDUSTRIALBOLTY.COM • 800-478-1906		Grease Fittings		Assortment No. 124R
1641-B 1/4-28 TAPER TRD STRT ZERK	1652-B 1/4-28 TAPER TRD 11/16 ZERK	1680-B 1/4-28 TAPER TRD 31/32 STRT	1637-B 1/4-28 TAPER TRD 45 DGR ZERK	1911-B 1/4-28 TAPER TRD. 90 DGR ZERK
1644-B 1/8 NPT SHORT STRT. ZERK	1607-B 1/8 NPT 1-1/4L STRT ZERK	1611-B 1/8 NPT 30DGR STRT ZERK	1688-B 1/8 NPT 45 DGR ZERK	1613-B 1/8 NPT 90DGR ZERK
1743-B 1/4 DRIVE ZERK BALL CHECK	1608-B 5/16 DRIVE ZERK BALL CHECK	1728-B 3/16 DRIVE ZERK BALL CHECK	1666-NB 3/8 DRIVER ZERK - NO BALL CHECK	1646-B 3/16 45DGR DRIVE ZERK
1711-B 5/16-24 ZERK (LEAF SPRINGS)	1720-B 1/8 NPT STRT THREAD CUTTING	3038-B 1/4-28 NPT STRT THREAD CUTTING	5251 RUBBER ZERK CAP	

PRODUCT CATEGORY: VG

### Grease Fittings

21 Items • 180 Pcs  
IBS No. 124R



Packaged in a Locking Steel Drawer for Easy Storage & Organization

IBS, Inc. SPECIALTY PRODUCTS FOR MAINTENANCE & REPAIR INDUSTRIALBOLTY.COM • 800-478-1906		Grease Fittings		Assortment No. 225R
1641-B 1/4-28 TAPER TRD STRT ZERK	1652-B 1/4-28 TAPER TRD 11/16 ZERK	1637-B 1/4-28 TAPER TRD 45 DGR ZERK	1911-B 1/4-28 TAPER TRD. 90 DGR ZERK	317850-1F 18" LUB. HOSE
1610-B 1/8 NPT STRT ZERK	1688-B 1/8 NPT 45 DGR ZERK	1613-B 1/8 NPT 90DGR ZERK		
1608-B 5/16 DRIVE ZERK BALL CHECK	1728-B 3/16 DRIVE ZERK BALL CHECK			
5251 RUBBER ZERK CAP			308730 1/8 NPT GREASE FITTING COUPLER	

PRODUCT CATEGORY: VG

### Grease Fittings

12 Items • 178 Pcs  
IBS No. 225R



Packaged in a Locking Steel Drawer for Easy Storage & Organization



Metric Grease Fittings		
Assortment No. 232R		
Z-1600 6MM X 1.0 STRT METRIC ZERK 	Z-1621 6MM X 1.0 45DGR METRIC ZERK 	Z-1690 6MM X 1.0 90DGR METRIC ZERK 
Z-2103 8MM X 1.0 STRT METRIC ZERK 	Z-2104 8MM X 1.0 45DGR METRIC ZERK 	Z-2105 8MM X 1.0 90DGR METRIC ZERK 
Z-2109 10MM X 1.0 STRT. METRIC ZERK 	Z-2110 10MM X 1.0 45DGR METRIC ZERK 	Z-2111 10MM X 1.0 90DGR METRIC ZERK 
5251 RUBBER ZERK CAP 		

PRODUCT CATEGORY: VG

### Metric Grease Fittings

10 Items • 150 Pcs  
IBS No. 232R

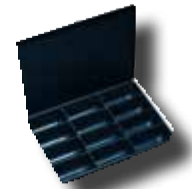

Packaged in a Locking Steel Drawer for Easy Storage & Organization

Grease Fittings Inch & Metric					
Assortment No. 849R					
1911-B 1/4-28 TAPER TRD 90 DGR ZERK 	1613-B 1/8 NPT 90 DGR ZERK 	1608-B 5/16 DRIVE ZERK BALL CHECK 	Z-1690 M6 X 1.0 90DGR METRIC ZERK 	Z-2105 8MM X 1.0 90DGR METRIC ZERK 	Z-2111 10MM X 1.0 90DGR METRIC ZERK 
1637-B 1/4-28 TAPER TRD 45 DGR ZERK 	1688-B 1/8 NPT 45 DGR ZERK 	1743-B 1/4 DRIVE ZERK BALL CHECK 	Z-1621 M6 X 1.0 45DGR METRIC ZERK 	Z-2104 8 X 1.0 45DGR METRIC ZERK 	Z-2110 10MM X 1.0 45DGR METRIC ZERK 
1652-B 1/4-28 TAPER TRD 11/16 ZERK 	1607-B 1/8 NPT 1-1/4L STRT ZERK 	1728-B 3/16 DRIVE ZERK BALL CHECK 	Z-1600 M6 X 1.0 STRT METRIC ZERK 	Z-2103 8 X 1.0 STRT METRIC ZERK 	Z-2109 10MM X 1.0 STRT. METRIC ZERK 
1641-B 1/4-28 TAPER TRD STRT ZERK 	1610-B 1/8 NPT STRT ZERK 			8852 LINCOLN GREASE COUPLER 	5251 RUBBER ZERK CAP 

PRODUCT CATEGORY: VG

### Inch & Metric Grease Fittings

22 Items • 166 Pcs  
IBS No. 849R



Packaged in a Locking Steel Drawer for Easy Storage & Organization

Aluminum Blind Rivets				
Assortment No. 156R				
AB3-2A 3/32 .032-.125 ALUM/ALUM RIVET 	AB3-4A 3/32 .126-.250 ALUM/ALUM RIVET 	AB4-2A 1/8 .063-.125 ALUM/ALUM RIVET 	AB4-3A 1/8 .126-.187 ALUM/ALUM RIVET 	AB4-4A 1/8 .188-.250 ALUM/ALUM RIVET 
			AB5-3A 5/32 .126-.187 ALUM/ALUM RIVET 	AB5-4A 5/32 .188-.250 ALUM/ALUM RIVET 
AB5-6A 5/32 .251-.375 ALUM/ALUM RIVET 	AB5-8A 5/32 .376-.500 ALUM/ALUM RIVET 	AB6-4A 3/16 .126-.250 ALUM/ALUM RIVET 	AB6-6A 3/16 .251-.375 ALUM/ALUM RIVET 	AB6-8A 3/16 .376-.500 ALUM/ALUM RIVET 
AB6-10A 3/16 .501-.625 ALUM/ALUM RIVET 		ABL6-6A 3/16 .251-.375 LRG FLGE 	ABL6-8A 3/16 .376-.500 LRG FLGE 	ABL6-10A 3/16 .501-.625 LRG FLNGE 

PRODUCT CATEGORY: W

### Aluminum Blind Rivets

16 Items • 1,050 Pcs  
IBS No. 156R



Packaged in a Locking Steel Drawer for Easy Storage & Organization

ASSORTMENTS



# IBS, INCORPORATED

## Assortments - Rivets & Inserts (W)

ASSORTMENTS

IBS, Inc. SPECIALTY PRODUCTS FOR MAINTENANCE & REPAIR INDUSTRIALBOLT.COM © © © 800-878-1566		Rivet Code Explanation		Aluminum / Steel Blind Rivets	
Assortment No. 157R					
AB3-2 3/32 .032-.125 ALUM/STEEL	AB3-4 3/32 .126-.250 ALUM/STEEL	AB4-2 1/8 .063-.125 ALUM/STEEL RIVET	AB4-3 1/8 .126-.187 ALUM/STEEL RIVET	AB4-4 1/8 .188-.250 ALUM/STEEL RIVET	
			AB5-3 5/32 .126-.187 ALUM/STEEL	AB5-4 5/32 .188-.250 ALUM/STEEL	
AB5-6 5/32 .251-.375 ALUM/STEEL	AB5-8 5/32 .376-.500 ALUM/STEEL	AB6-4 3/16 .126-.250 ALUM/STEEL	AB6-6 3/16 .251-.375 ALUM/STEEL	AB6-8 3/16 .376-.500 ALUM/STEEL	
AB6-10 3/16 .501-.625 AI		ABL6-6 3/16 .251-.375 LRG FLGE	ABL6-8 3/16 .376-.500 LRG FLGE	ABL6-10 3/16 .501-.625 LRG FLGE	

PRODUCT CATEGORY: W

**Aluminum / Steel  
Blind Rivets**  
16 Items • 1,050 Pcs  
IBS No. 157R



Packaged in a Locking Steel Drawer  
for Easy Storage & Organization

IBS, Inc. SPECIALTY PRODUCTS FOR MAINTENANCE & REPAIR INDUSTRIALBOLT.COM © © © 800-878-1566		Rivet Code Explanation		Steel Blind Rivets	
Assortment No. 174R					
SB3-4 3/32 .126-.250 STEEL RIVET		SB4-2 1/8 .063-.125 STEEL RIVET	SB4-3 1/8 .126-.187 STEEL RIVET	SB4-4 1/8 .188-.250 STEEL RIVET	
			SB5-2 5/32 .062-.125 STEEL RIVET	SB5-4 5/32 .188-.250 STEEL RIVET	
SB5-6 5/32 .251-.375 STEEL RIVET	SB5-8 5/32 .376-.500 STEEL RIVET	SB6-4 3/16 .126-.250 STEEL RIVET	SB6-6 3/16 .251-.375 STEEL RIVET	SB6-8 3/16 .376-.500 STEEL RIVET	
SB6-10 3/16 .501-.625 STEEL RIVET		SBL6-6 3/16 .251-.375 LRG FLGE STEEL	SBL6-8 3/16 .376-.500 LRG FLGE STEEL	SBL6-10 3/16 .501-.625 LRG FLGE STEEL	

PRODUCT CATEGORY: W

**Steel Blind Rivets**  
15 Items • 975 Pcs  
IBS No. 174R









Packaged in a Locking Steel Drawer  
for Easy Storage & Organization









# IBS, INCORPORATED

## Assortments - Rivets & Inserts (W)









					
<b>Thread Repair Kit</b> <b>1/4-1/2 NC USS Heavy Wall</b>					
Assortment No. 212R					
					65999 INSERT TOOL FOR THD INSERTS 
65902 1/4-20 HVY WALL THD INSERT  Use With P/N 16158 X Drill P/N 17641 7/16-14 Tap	65903 5/16-18 HVY WALL THD INSERT  Use With P/N 17425 29/64 Drill P/N 17643 1/2-13 Tap	65904 3/8-16 HVY WALL THD INSERT  Use With P/N 16833 33/64 Drill P/N 17645 9/16-12 Tap	65905 7/16-14 HVY WALL THD INSERT  Use With P/N 16845 37/64 Drill P/N 17647 5/8-11 Tap	65906 1/2-13 HVY WALL THD INSERT  Use With: P/N 16845 45/64 Drill P/N 17650 3/4-16 Tap	

PRODUCT CATEGORY: W

					
<b>Thread Repair Kit</b> <b>1/4-1/2 NF SAE Heavy Wall</b>					
Assortment No. 213R					
					65999 INSERT TOOL FOR THD INSERTS 
66102 1/4-28 HVY WALL THD INSERT  Use With P/N 16158 X Drill P/N 17641 7/16-14 Tap	66103 5/16-24 HVY WALL THD INSERT  Use With P/N 17425 29/64 Drill P/N 17643 1/2-13 Tap	66104 3/8-24 HVY WALL THD INSERT  Use With P/N 16833 33/64 Drill P/N 17645 9-16-12 Tap	66105 7/16-20 HVY WALL THD INSERT  Use With P/N 16837 37/64 Drill P/N 17647 5/8-11 Tap	66106 1/2-20 HVY WALL THD INSERT  Use With P/N 16845 45/64 Drill P/N 17650 3/4-16 Tap	66108 5/8-18 HVY WALL THD INSERT  Use With P/N 16853 53/64 Drill P/N 17652 7/8-14 Tap

PRODUCT CATEGORY: W

					
<b>Thread Repair Kit</b> <b>1/4-1/2 NC USS Thin Wall</b>					
Assortment No. 214R					
					65999 INSERT TOOL FOR THD INSERTS 
65922 1/4-20 THIN WALL THD INSERTS  Use With P/N 16151 Q Drill P/N 17639 3/8-16 Tap	65923 5/16-18 THIN WALL THD INSERTS  Use With P/N 16158 X Drill P/N 17641 7/16-14 Tap	65924 3/8-16 THIN WALL THD INSERTS  Use With P/N 17425 29/64 Drill P/N 17643 1/2-13 Tap	65925 7/16-14 THIN WALL THD INSERTS  Use With P/N 16833 33/64 Drill P/N 17645 9/16-12 Tap	65926 1/2-13 THIN WALL THD INSERTS  Use With P/N 16837 37/64 Drill P/N 17647 5/8-11 Tap	

PRODUCT CATEGORY: W

**Thread Repair Kit**  
**1/4-12 NC USS Heavy Wall**  
**6 Items • 81 Pcs**  
**IBS No. 212R**

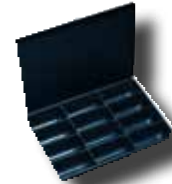

Packaged in a Locking Steel Drawer  
 for Easy Storage & Organization

**Thread Repair Kit**  
**1/4-12 NF SAE Heavy Wall**  
**7 Items • 87 Pcs**  
**IBS No. 213R**



Packaged in a Locking Steel Drawer  
 for Easy Storage & Organization

**Thread Repair Kit**  
**1/4-1/2 NC USS Thin Wall**  
**6 Items • 82 Pcs**  
**IBS No. 214R**



Packaged in a Locking Steel Drawer  
 for Easy Storage & Organization







ASSORTMENTS



# IBS, INCORPORATED

## Assortments - Rivets & Inserts (W)

ASSORTMENTS











IBS, Inc. SPECIALTY PRODUCTS FOR MAINTENANCE & REPAIR INDUSTRIALBOLTY.COM © © © 800-678-1506					Thread Repair Kit 1/4-1/2 NF SAE Thin Wall
					Assortment No. 215R
66122 1/4-28 THIN WALL THD INSERT 	66123 5/16-24 THIN WALL THD INSERT 	66124 3/8-24 THIN WALL THD INSERT 	66125 7/16-20 THIN WALL THD INSERT 	66126 1/2-20 THIN WALL THD INSERT 	
Use With P/N 16151 'Q' Drill P/N 17639 3/8-16 Tap	Use With P/N 16158 'X' Drill P/N 17641 7/16-14 Tap	Use With P/N 17425 29/64 Drill P/N 17643 1/2-13 Tap	Use With P/N 16833 33/64 Drill P/N 17645 9/16-12 Tap	Use With P/N 16837 37/64 Drill P/N 17647 5/8-11 Tap	
					65999 INSERT TOOL FOR THD INSERTS 

PRODUCT CATEGORY: W

**Thread Repair Kit**  
1/4-12 NF SAE Thin Wall  
6 Items • 82 Pcs  
IBS No. 215R



Packaged in a Locking Steel Drawer for Easy Storage & Organization













IBS, Inc. SPECIALTY PRODUCTS FOR MAINTENANCE & REPAIR INDUSTRIALBOLTY.COM © © © 800-678-1506			Multi-Grip Rivets
			Assortment No. 368R
170406 1/8 LARGE FLG SHORT MULTIGRIP 	170408 1/8 LARGE FLG LONG MULTIGRIP 	170508 5/32 LARGE FLG MULTIGRIP 	
170608 3/16 LARGE FLG SHORT MULTIGRIP 	170612 3/16 LARGE FLG LONG MULTIGRIP 		
171406 1/8 DOME HD SHORT MULTIGRIP 	171408 1/8 DOME HD LONG MULTIGRIP 	171508 5/32 DOME HD MULTIGRIP 	
171608 3/16 DOME HD SHORT MULTIGRIP 	171612 3/16 DOME HD LONG MULTIGRIP 		

PRODUCT CATEGORY: W

**Multi-Grip Rivets**  
10 Items • 1000 Pcs  
IBS No. 368R



Packaged in a Locking Steel Drawer for Easy Storage & Organization

IBS, Inc. SPECIALTY PRODUCTS FOR MAINTENANCE & REPAIR INDUSTRIALBOLTY.COM © © © 800-678-1506			Multi-Grip & Tri-Fold Rivets
			Assortment No. 369R
170406 1/8 LARGE FLG SHORT MULTIGRIP 	170408 1/8 LARGE FLG LONG MULTIGRIP 	170508 5/32 LARGE FLG MULTIGRIP 	
170608 3/16 LARGE FLG SHORT MULTIGRIP 	170612 3/16 LARGE FLG LONG MULTIGRIP 	171406 1/8 DOME HD SHORT MULTIGRIP 	
171408 1/8 DOME HD LONG MULTIGRIP 	171608 3/16 DOME HD SHORT MULTIGRIP 	171612 3/16 DOME HD LONG MULTIGRIP 	
17256 5/32 TRI-FOLD RIVET .040-.375 	17264 3/16 TRI-FOLD RIVET .062-.250 	17266 3/16 TRI-FOLD RIVET .187-.375 	

PRODUCT CATEGORY: W

**Multi-Grip & Tri-Fold Rivets**  
12 Items • 800 Pcs  
IBS No. 369R



Packaged in a Locking Steel Drawer for Easy Storage & Organization

# IBS, INCORPORATED

## Assortments - Rivets & Inserts (W)



**IBS, Inc.**  
SPECIALTY PRODUCTS FOR MAINTENANCE & REPAIR  
INDUSTRIALBOLT.COM © P.O. 800-878-1906

**Knurled Nutserts with Tool**

Assortment No. 431P

49514 3/8-16 MANDREL & NOSEPIECE	49503 10-32 KNURLED GRIP SERT	49506 3/8-16 KNURLED GRIP SERT	49500 RIVET NUT GUN
49513 5/16-18 MANDREL & NOSEPIECE		NOTE: This size should be installed with Heavy Duty Nutsert Tool P/N 49550	
49512 1/4-20 MANDREL & NOSEPIECE	49502 10-24 KNURLED GRIP SERT	49505 5/16-18 KNURLED GRIP SERT	
49511 10-32 MANDREL & NOSEPIECE		NOTE: This size should be installed with Heavy Duty Nutsert Tool P/N 49550	
49510 10-24 MANDREL & NOSEPIECE	49501 8-32 KNURLED GRIP SERT	49504 1/4-20 KNURLED GRIP SERT	
49508 8-32 MANDREL & NOSEPIECE		NOTE: This size should be installed with Heavy Duty Nutsert Tool P/N 49550	

PRODUCT CATEGORY: W

### Knurled Nutserts with Tool

13 Items • 127 Pcs  
IBS No. 431P



Packaged in a Locking Steel Drawer for Easy Storage & Organization

**IBS, Inc.**  
SPECIALTY PRODUCTS FOR MAINTENANCE & REPAIR  
INDUSTRIALBOLT.COM © P.O. 800-878-1906

**Aluminum Nutserts**

Assortment No. 432P

49514 3/8-16 MANDREL & NOSEPIECE	17503 10-32 ALUM RIVET NUT Drill Hole Size 9/32"	17506 3/8-16 ALUM RIVET NUT Drill Hole Size 1/2"	49500 RIVET NUT GUN
49513 5/16-18 MANDREL & NOSEPIECE	17502 10-24 ALUM RIVET NUT Drill Hole Size 9/32"	17505 5/16-18 ALUM RIVET NUT Drill Hole Size 1/2"	
49512 1/4-20 MANDREL & NOSEPIECE			
49511 10-32 MANDREL & NOSEPIECE	17501 8-32 ALUM RIVET NUT Drill Hole Size 1/4"		
49510 10-24 MANDREL & NOSEPIECE	17500 6-32 ALUM RIVET NUT Drill Hole Size 1/4"	17504 1/4-20 ALUM RIVET NUT Drill Hole Size 3/8"	
49508 8-32 MANDREL & NOSEPIECE	49507 6-32 MANDREL & NOSEPIECE		

PRODUCT CATEGORY: W

### Aluminum Nutserts

15 Items • 153 Pcs  
IBS No. 432P



Packaged in a Locking Steel Drawer for Easy Storage & Organization

**IBS, Inc.**  
SPECIALTY PRODUCTS FOR MAINTENANCE & REPAIR  
INDUSTRIALBOLT.COM © P.O. 800-878-1906

**Self-Tapping Threaded Inserts**

Assortment No. 696R

65935 1/4-20 SELF-TAPPING THREAD INSERT (USE DRILL: V)	65936 5/16-18 SELF-TAPPING THREAD INSERT (USE DRILL: 29/64)	65937 3/8-16 SELF TAPPING THREAD INSERT (USE DRILL: 17/32)	65939 1/2-13 SELF TAPPING THREAD INSERT (USE DRILL: 11/16)
65945 M6-1.0 SELF-TAPPING THREAD INSERT (USE DRILL: V)	65946 M8-1.25 SELF-TAPPING THREAD INSERT (USE DRILL: 29/64)	65947 M10-1.5 SELF TAPPING THREAD INSERT (USE DRILL: 17/32)	65948 M12-1.75 SELF TAPPING THREAD INSERT (USE DRILL 39/64)

PRODUCT CATEGORY: W

### Self-Tapping Threaded Inserts

8 Items • 60 Pcs  
IBS No. 696R



Packaged in a Locking Steel Drawer for Easy Storage & Organization





















ASSORTMENTS













# IBS, INCORPORATED

## Assortments - Automotive (X)

























ASSORTMENTS

IBS, Inc. SPECIALTY PRODUCTS FOR MAINTENANCE & REPAIR INDUSTRIALBOLTY.COM 800-878-1906					
Universal Studs Black Oil Finish High Carbon - Heat Treated					
Assortment No. 119R					
A-9668 1/4-28X1/2 X 1/4-20X1/2 OL 1-1/4 STUD 	A-9669 1/4-28X3/4 X 1/4-20X1/2 OL 1-1/2 STUD 	A-9670 1/4-28X1 X 1/4-20X1/2 OL 2" STUD 	A-9673 5/16-24X1/2 X 5/16-18X3/8 OL 1" STUD 	A-9675 5/16-24X5/8 X 5/16-18X3/4 OL 1-1/2 STUD 	A-9690 3/8-24X2 X 3/8-16X5/8 OL 3" STUD 
A-9677 5/16-24X1 X 5/16-18X9/16 OL 2" STUD 	A-9683 3/8-24X3/4 X 3/8-16X1/2 OL 1-1/2 STUD 	A-9684 3/8-24X3/4 X 3/8-16X1/2 OL 1-3/4 STUD 	A-9686 3/8-24X1 X 3/8-16X5/8 OL 2" STUD 	A-9699 7/16-20X3/4 X 7/16-14X9/16 OL 1-3/4" STUD 	
A-9701 7/16-20X7/8 X 7/16-14X3/4 OL 2" STUD 	A-9712 7/16-20X1-3/8 X 7/16-14X3/4 OL 2-1/2" STUD 	A-9715 7/16-20X1-13/16 X 7/16-14X3/4 OL 3" STUD 	A-9727 1/2-20X3/4 X 1/2-13X3/4 OL 1-7/8" STUD 	A-9745 5/8-18X1-1/4 X 5/8-11X1 OL 3" STUD 	
A-9731 1/2-20X1 X 1/2-13X3/4 OL 2-1/2" STUD 	A-9732 1/2-20X2 X 1/2-13X3/4 OL 3" STUD 	A-9739 7/16-18X1-1/4 X 9/16-12X1 OL 	A-9744 5/8-11X1-1/2 X 5/8-11X13/16 		

PRODUCT CATEGORY: X

IBS, Inc. SPECIALTY PRODUCTS FOR MAINTENANCE & REPAIR INDUSTRIALBOLTY.COM 800-878-1906		
Copper Washers		
Assortment No. 160R		
D-725-001 1/4ID X 5/8OD COPPER WASHER 	D-725-002 5/16ID X 11/16OD COPPER WASHER 	D-725-003 3/8ID X 3/4OD COPPER WASHER 
D-725-004 7/16ID X 13/16OD COPPER WASHER 	D-725-005 1/2ID X 7/8OD COPPER WASHER 	
D-725-011 1/4ID X 7/16OD COPPER WASHER 	D-725-012 5/16ID X 1/2OD COPPER WASHER 	D-725-013 3/8ID X 9/16OD COPPER WASHER 
D-725-014 7/16ID X 5/8OD COPPER WASHER 	D-725-015 1/2ID X 11/16OD COPPER WASHER 	

PRODUCT CATEGORY: W

IBS, Inc. SPECIALTY PRODUCTS FOR MAINTENANCE & REPAIR INDUSTRIALBOLTY.COM 800-878-1906							
Nylon Connectors and Vacuum Caps							
Assortment No. 301P							
A-12929 1/8 STRT VACUUM CONNECTOR 	A-12937 3/16 X 3/16 NYLON VACUUM CONN 	A-12931 1/4 X 1/4 NYLON VACUUM CONN 	A-12946 5/16 X 5/16 NYLON VACUUM CONN 	A-12934 3/8 X 3/8 NYLON VACUUM CONN 	A-12930 1/8X3/16 NYLON VACUUM CONN 	A-12936 1/8 X 1/4 NYLON VACUUM CONN 	A-12935 3/16 X 1/4 NYLON VACUUM CONN 
A-12923 1/8 NYLON VACUUM CONN 	A-12918 3/16 NYLON VACUUM CONN 	A-17629 1/4 NYLON VACUUM TEE 	A-12920 5/16 NYLON VACUUM CONN 	A-12925 3/8 NYLON VACUUM CONN 	A-12927 3/16 VACUUM Y" CONNECTOR 		
A-12209 1/8 HI-TEMP RUBBER VACUUM CAP 	A-19000 3/16 HI-TEMP RUBBER VACUUM CAP 	A-19001 1/4 HI-TEMP RUBBER VACUUM CAP 	A-19003 3/8 HI-TEMP RUBBER VACUUM CAP 			A-11419 3/16 4-WAY VACUUM CONN 	
A-12916 1/8X3/16X1/8 NYLON VACUUM CONN 	A-12919 1/4X3/16X3/16 NYLON VACUUM CONN 	A-12926 3/16X3/16X1/8 NYLON VACUUM CONN 	A-12921 3/8X3/8X1/4 NYLON VACUUM TEE 			A-12949 3/16 SWAY VACUUM CONNECTOR 	

PRODUCT CATEGORY: X

### Universal Studs BLACK OIL FINISH High Carbon - Heat Treated 21 Items • 67 Pcs IBS No. 119R



Packaged in a Locking Steel Drawer for Easy Storage & Organization

### Copper Washers 10 Items • 250 Pcs IBS No. 160R



Packaged in a Locking Steel Drawer for Easy Storage & Organization

### Nylon Connectors & Vacuum Caps 24 Items • 310 Pcs IBS No. 301P



Packaged in a Locking Steel Drawer for Easy Storage & Organization

# IBS, INCORPORATED

## Assortments - Automotive (X)



Automotive Drain Plugs				
Assortment No. 321R				
A-14196 1/2-20 OIL DRAIN PLUG	A-19130 1/2 DRAIN PLUG	A-17145 1/2-20 OVERSIZE DRAIN PLUG	A-18121 1/2 OIL DRAIN PLUG	A-8285 5/8-18 OVERSIZE DRAIN PLUG W/FIBRE
A-15527 M12-1.25 OIL DRAIN PLUG	A-14677 M12-1.75 OIL PAN PLUG	A-19024 14MM DRAIN PLUG W/GASKET	A-16308 14MM DRAIN PLUG	A-14678 M14 DRAIN PLUG
A-15528 16MM DRAIN PLUG	A-15529 18MM DRAIN PLUG			

PRODUCT CATEGORY: X

## Automotive Drain Plugs

12 Items • 72 Pcs  
IBS No. 321R



Packaged in a Locking Steel Drawer for Easy Storage & Organization

Oil Drain Plug Gaskets				
Assortment No. 322R				
A-18726 12MM ID 22MM OD BLACK DRAIN	A-18665 DRAIN PLUG RUBBER GASKET M12-1.75	A-16996 1/2 NYLON DRAIN PLUG GASKET	A-19538 1/2ID X 3/4OD BLACK FIBER	A-8277 1/2 NYLON GASKET
A-16026 1/2 STEEL & RUBBER DRAIN PLUG	A-15918 1/2 COPPER DRAIN WASHER	A-19545 1/2 COPPER DRAIN PLUG GASKET	A-16682 14MM DRAIN PLUG GASKET	A-16681 M14 NYLON DRAIN PLUG GASKET
A-18299 14MM X 25MM RUBBER/STEEL FORD	A-19007 14MMX20MM STEEL CRUSHABLE	A-16956 M14 ALUMINUM DRAIN PLUG GASKET	A-8278 5/8 NYLON OIL DRAIN PLUG GASKET	A-17263 M16 COPPER WASHER
A-16683 M16.5 NYLON DRAIN PLUG GASKET	A-18829 M18 GREEN OIL DRAIN PLUG	A-17264 M18 COPPER WASHER	A-16955 18MM ALUM OIL DRAIN PLUG	A-19139 20MM STEEL OIL DRAIN PLUG

PRODUCT CATEGORY: X

## Oil Drain Plug Gaskets

20 Items • 260 Pcs  
IBS No. 322R



Packaged in a Locking Steel Drawer for Easy Storage & Organization

X-mas Tree Retainers				
Assortment No. 343P				
A-10831 (GM 322354 Ford 330208 Chry 3891590 503121 AMC 8004098) Black Nylon Fender & Bumper Shield Retainer Stem Dia: 5/16" Stem Length: 3/4" HD Dia: 11/16" GM, Ford, Chrysler & AMC	A-17664 (GM 10114522 Chry 8033982 8033940 Ford 3000191-5) Black Nylon Shield Retainer Battery Post Cable Shield Engine Splash Shield Radiators Side Air Buffer GM 1989-Ch	A-12992 (8800082 21421900) White Nylon Door Trim Panel Retainer Stem Dia: 5/16" HD Dia: 3/4" + 7/16" Stem Length: 3/4" GM 1983-Ch	A-13945 (101553-0 09020) Nylon Door Trim Panel Retainer Stem Dia: 5/32" HD Dia: 3/4" Stem Length: 3/4" Trucks	A-11130 (007811 3071731) Black Nylon Hood Insulation Retainer Stem Dia: 5/16" HD Dia: 2" Stem Length: 3/4" GM 1984-Ch
A-11146 (GM 1408306 Chry 6030441 Ford 3895175) Black Nylon Fender & Bumper Shield Retainer Stem Dia: 5/16" HD Dia: 11/16" Stem Length: 13/16" GM, Ford & Chrysler	A-12737 (12337920 20374471) White Nylon Door Panel Retainer Grease & Plastic 1982-Ch GM Truck 1989-Ch	A-11796 (3006579) White Nylon Door Trim Panel Retainer Stem Dia: 5/16" HD Dia: 3/8" Stem Length: 3/4" GM 1978-Ch	A-19356 (15966673) White Nylon Front & Rear Door Trim Panel Retainer GM Trucks 910 & 915 1999-Ch	A-12909 (388930-5) Black Nylon Trim Panel Retainer Stem Dia: 5/16" HD Dia: 1" Stem Length: 11/16" Ford 1983-Ch
A-12766 (163194 22512276) Black Nylon Fused End Hood Insulation Retainer Stem Dia: 3/4" Stem Length: 13/16" GM 1981-Ch	A-19541 (8504135) Black Nylon Hood Insulation Retainer Chrysler Mini Vans & Durango 1987-Ch	A-12565 (1801925-5) Black Nylon Door Trim Panel Retainer Stem Dia: 5/16" HD Dia: 25/32" Stem Length: 13/16" Ford 1981-Ch	A-17612 (15966673) Black Nylon Chrysler 9304543 Ford 980721-5 Trim Panel Retainer 1983-Ch Truck Lid Latch Chwyser 1988-Ch	A-18391 (388930-5) Black Nylon Trim Panel Retainer Chry Astro & GMC Batten Mini Vans 1983-Ch
A-20189 (GM 18074036 Ford 8806113-B Chry 6030343) Black Nylon Trim Panel Retainer	A-16818 (GM 21041150) Black Nylon Front Panel Retainer GM Saturn 1991-Ch Bling Color & Lid Gate Trim Panel Retainer Chrysler Mini Vans 1987-Ch	A-12137 (1819251) Black Nylon Radiator Against Panel Retainer GM 1977-Ch		

PRODUCT CATEGORY: X

## X-Mas Tree Retainers

18 Items • 330 Pcs  
IBS No. 343P



Packaged in a Locking Steel Drawer for Easy Storage & Organization

ASSORTMENTS



# IBS, INCORPORATED

## Assortments - Automotive (X)

ASSORTMENTS

**IBS, Inc.**  
SPECIALTY PRODUCTS FOR MAINTENANCE & REPAIR  
INDUSTRIALBOLT.COM © © © 800-678-1906

### Nylon Push/Screw Type Retainers

Assortment No. 344P					
 <b>A-18119</b> <small>(387943-S) Black Nylon Front &amp; Rear Bumper Push-Type Retainer Head Dia: 20mm Stem Length: 25mm Fits into 13mm Hole Honda 1990-On</small>	 <b>A-13993</b> <small>(20510029) Black Nylon Body Retainer Head Dia: 11/16" Fits 1/4" Hole GM 1984-On</small>	 <b>A-14993</b> <small>Hole Dia: .250" Panel Range: 100-197" Flange Dia: .700" Stem Length: .900" GM: 22538004</small>	 <b>A-17143</b> <small>(91502-SM-0000) Black Nylon Push-Type Retainer Hd Dia: 20 mm Stem Length: 27mm Fits 10mm Hole Bumper Fascia Accord 1990-On</small>	 <b>A-14698</b> <small>(90688-SBC-003) Black Nylon Push-Type Retainer Hd Dia: 18mm Stem Length: 11 mm Fits 6 mm Hole</small>	
 <b>A-14997</b> <small>(10053182) Black Nylon Push-Type Retainer Head Dia: .19032" Stem Length: .1306" Fits into 5/16" Hole GM 1987-On</small>	 <b>A-14011</b> <small>(14019220) 14071289) Black Nylon Radiator Overflow Bottle/Windshield Washer Bottle Retainer Hd Dia: 21/32" Fits 5/16" Hole GM 1981-On</small>	 <b>A-14994</b> <small>Hole Dia: .250" Panel Range: 100-240" Flange Dia: .000" Stem Length: .900" Ford: N8048375</small>	 <b>A-14697</b> <small>(GM: 94196687; Honda: 90657-SA6-003; Mazda N304-13-356A) Black Nylon Push-Type Retainer Hd Dia: 14mm Stem Length: 11mm Fits 7mm Hole</small>		
 <b>A-14992</b> <small>(Ford: N803946S; Chry: 6502871) Black Nylon Push-Type Retainer Head Dia: .19032" Stem Length: .2932" Fits into 1/4" Hole Ford &amp; Chrysler 1987-On</small>	 <b>A-13994</b> <small>(GM: 20570245; Ford: N8249143) Black Nylon Spare Tire Retainer Hd Dia: 1" Fits 5/16" Hole GM 1984-On</small>	 <b>A-17057</b> <small>(90505-SM-4-003) Black Nylon Push-Type Retainer Head Dia: 18mm Stem Length: 21mm fits into 8mm Hole Accord 1990 - On</small>	 <b>A-16000</b> <small>(Honda: 90675-SB3-003; Mazda: F801-26-904; Nissan: 63876-65099) Black Nylon Push Type Retainer Hd Dia: 20mm Stem Length: 9mm Fits 8mm Hole</small>		
 <b>A-14260</b> <small>(Toyota 90467-02017; Mazda: 9925-50-625; GM: 20429301) Black Nylon Push-Type Retainer Head Dia: 15mm Stem Length: 12mm Fits into 7mm Hole</small>	 <b>A-17632</b> <small>(Mazda: B092-51-833; Ford: M8-456-56143) Black Nylon Push-Type Retainer Head Dia: 18mm Stem Length: 12mm Fits into 8mm Hole Mazda &amp; Ford Aspire</small>	 <b>A-17222</b> <small>(GM: 1156187-2107-5686; Ford: F3LV14570-B) Black Nylon Push-Type Retainer Head Dia: 15mm Stem Length: 20mm Fits into 8mm Hole Saturn 1991 - On</small>	 <b>A-16888</b> <small>(Nissan: 6384-01003; Ford: NMA01-56145; NAD1-56145) Black Nylon Nylon Inner Fender Shield Retainer Hd Dia: 20mm(2332") Stem Length: 18mm(2332") Fits 8mm 5/16 Hole Nissan 1993-On Ford Probe &amp; Aspire 1995-On</small>		

**PRODUCT CATEGORY: X**

## Nylon Push Screw Type Retainers

**17 Items • 155Pcs**  
**IBS No. 344P**



**Packaged in a Locking Steel Drawer for Easy Storage & Organization**

**IBS, Inc.**  
SPECIALTY PRODUCTS FOR MAINTENANCE & REPAIR  
INDUSTRIALBOLT.COM © © © 800-678-1906

### Black Trim Screws

Assortment No. 345P					
 <b>A-10654</b> <small>#8 X 1-1/4 PHIL OVAL SEMS T/S</small>	 <b>A-12820</b> <small>8 X 3/4 PHIL PAN SEMS T/S B/O</small>	 <b>A-12213</b> <small>8 X 1/2 PHIL FLT TOP WASH HD</small>	 <b>A-12215</b> <small>8 X 3/4 PHIL FLT TOP WASH HD</small>	 <b>A-12216</b> <small>8 X 1 PHIL FLT TOP WASH HD</small>	
 <b>A-12953</b> <small>10 X 3/4 PHIL FLT TOP WASH HD</small>	 <b>A-12954</b> <small>10 X 1 PHIL FLT TOP WASH HD</small>	 <b>A-10180</b> <small>8 X 1/2 PHIL PAN HD T/S B/O</small>	 <b>A-10181</b> <small>8 X 3/4 PHIL PAN HD T/S B/O</small>	 <b>A-10182</b> <small>8 X 1 PHIL PAN HD T/S B/O</small>	 <b>A-10183</b> <small>8 X 1-1/4 PHIL PAN T/S B/O</small>
 <b>A-11921</b> <small>10 X 1/2 PHIL PAN HD T/S B/O</small>	 <b>A-11922</b> <small>10 X 3/4 PHIL PAN HD T/S B/O</small>	 <b>A-11923</b> <small>10 X 1 PHIL PAN HD T/S B/O</small>	 <b>A-10163</b> <small>8 X 1/2 PHIL OVAL T/S B/O</small>	 <b>A-10165</b> <small>8 X 3/4 PHIL OVAL T/S B/O</small>	 <b>A-10167</b> <small>8 X 1 PHIL OVAL T/S B/O</small>
 <b>A-11086</b> <small>10 X 3/4 PHIL OVAL T/S B/O</small>	 <b>A-11088</b> <small>10 X 1 PHIL OVAL T/S B/O</small>	 <b>A-12060</b> <small>M4.2 X 20 PHIL WASHER HD T/S</small>	 <b>A-15373</b> <small>M4.2 X 20 HEX HD SEMS T/S B/O</small>	 <b>A-12339</b> <small>M6.3 X 25 HEX HD SEMS T/S B/O</small>	

**PRODUCT CATEGORY: X**

## Black Trim Screws

**22 Items • 950 Pcs**  
**IBS No. 345P**



**Packaged in a Locking Steel Drawer for Easy Storage & Organization**

**IBS, Inc.**  
SPECIALTY PRODUCTS FOR MAINTENANCE & REPAIR  
INDUSTRIALBOLT.COM © © © 800-678-1906

### Metric Body Hardware

Assortment No. 346P					
 <b>A-13613</b> <small>M8 X 25 HEX HEAD SEMS T/S</small>	 <b>A-12336</b> <small>M8 X 25 HEX WASHER HD T/S</small>	 <b>A-15780</b> <small>M8 X 33 HEX HD SEMS T/S DOG PT</small>	 <b>A-11641</b> <small>M10 X 40 HEX HD SEMS T/S</small>		
 <b>A-11709</b> <small>M8-1.25 HEX FLANGE LOCKNUT 17MM FLANGE</small>	 <b>A-15334</b> <small>M8-1.25 FREE SPINNING WASHER</small>	 <b>A-12667</b> <small>M8-1.25 GM "U" NUT</small>	 <b>A-11630</b> <small>M8-1.25 GM/FORD U NUT</small>	 <b>A-15337</b> <small>M10-1.5 FREE SPINNING WASHER</small>	
 <b>A-12065</b> <small>M6 X 25 HEX HEAD SEMS T/S</small>	 <b>A-15818</b> <small>M6 X 30 HEX HD SEMS T/S DOG PT</small>	 <b>A-12160</b> <small>M6 X 22 HEX HD SEMS T/S DOG PT</small>	 <b>A-16899</b> <small>M6 X 28 HEX HD SEMS T/S DOG PT</small>	 <b>A-11631</b> <small>M10-1.5 GM U NUT</small>	
 <b>A-18251</b> <small>HEX FLANGE LOCKNUT M6-1.0 THREAD</small>	 <b>A-15329</b> <small>M6-1.0 FREE SPINNING WASHER</small>	 <b>A-12669</b> <small>M6-1.0 GM/FORD "U" NUT</small>	 <b>A-12575</b> <small>M6-1.0 GM "U" NUT</small>	 <b>A-13619</b> <small>M10 X 30 HEX HD SEMS T/S</small>	

**PRODUCT CATEGORY: X**

## Metric Body Hardware

**19 Items • 215 Pcs**  
**IBS No. 346P**



**Packaged in a Locking Steel Drawer for Easy Storage & Organization**

# IBS, INCORPORATED

## Assortments - Automotive (X)



<b>JIS Hex Head Capscrews</b>					
Assortment No. 697R					
10802 M8-1.25 X 16 JIS HEX C/S ZP	10803 M8-1.25 X 20 JIS HEX C/S ZP	10804 M8-1.25 X 25 JIS HEX C/S ZP	10805 M8-1.25 X 30 JIS HEX C/S ZP	10807 M8-1.25 X 40 JIS HEX C/S ZP	10811 M10-1.25 X 20 JIS HEX C/S ZP
10812 M10-1.25 X 25 JIS HEX C/S ZP	10813 M10-1.25 X 30 JIS HEX C/S ZP	10814 M10-1.25 X 35 JIS HEX C/S ZP	10815 M10-1.25 X 40 JIS HEX C/S ZP	10816 M10-1.25 X 45 JIS HEX C/S ZP	10817 M10-1.25 X 50 JIS HEX C/S ZP
10822 M12-1.25 X 25 JIS HEX C/S ZP	10823 M12-1.25 X 30 JIS HEX C/S ZP	10824 M12-1.25 X 35 HEX C/S JIS ZP	10825 M12-1.25 X 40 JIS HEX C/S ZP	10827 M12-1.25 X 50 JIS HEX C/S ZP	
10840 M8-1.25 JIS HEX NUT ZP	10841 M10-1.25 JIS HEX NUT ZP	10842 M12-1.25 JIS HEX NUT ZP			

PRODUCT CATEGORY: X

### JIS Hex Head Capscrews

20 Items • 595 Pcs  
IBS No. 697R



Packaged in a Locking Steel Drawer  
for Easy Storage & Organization

<b>Door Panel and Moulding Clips</b>				
Assortment No. 842R				
A-11612 WEATHERSTRIP RETAINER - GM FORD AMC	A-12571 FASCIA TO BUMPER RETAINER BLK FORD	A-12992 5/16 GM NYLON RET. DOOR TRIM PANEL	A-14021 FASCIA RETAINER BLK	A-15480 FORD INTERIOR TRIM PANEL RETAINER - BLACK NYLON
A-15668 FORD TRIM PANEL RETAINER	A-15670 GM DOOR PANEL RETAINER	A-15970 GM DOOR TRIM PANEL RETAINER WHITE NYLON	A-16017 WHITE NYLON TRIM PANEL RETAINER	A-17102 WHITE TRIM PANEL RETAINER
A-17339 LINCOLN WEATHERSTRIP RETAINER	A-18033 CHRYSLER WEATHERSTRIP RETAINER	A-18353 DOOR TRIM PANEL PUSH TYPE RETAINER	A-18848 YELLOW FORD DOOR TRIM PANEL RETAINER	A-19386 CHRYSLER TRIM PANEL RETAINER NYLON
A-19655 HOOD INSULATION RETAINER BLK FORD	A-19850 WEATHER STRIP RETAINER	A-21241 FORD TRM BLK NYLON ROCKER, PILLER & FENDER LINER 7.5MM X 28MM		

PRODUCT CATEGORY: X

### Door Panel & Moulding Clips

18 Items • 315 Pcs  
IBS No. 842R



Packaged in a Locking Steel Drawer  
for Easy Storage & Organization

<b>Push-In Fasteners</b>				
Assortment No. 843R				
A-14260 TOYOTA PUSH-TYPE RETAINER 15MM HEAD DIA.	A-14369 MAZDA PUSH-TYPE RETAINER 20MM HD DIA. 9MM LENGTH	A-14753 FORD PUSH TYPE RETAINER 11/16 HEAD DIA. 7/8 LENGTH	A-16835 12MM SCREW RETAINER NYLON	A-17103 FASCIA RETAINING CLIP
A-17216 PUSH-TYPE RETAINER 20MM HEAD DIA. 20MM LENGTH	A-18030 CHRYSLER PUSH TYPE RTNR 11/16 HD 13/16 LGTH	A-18269 CHRYSLER LOWER SILL MOULDING CLIP	A-18310 GM REAR BUMPER FASCIA PUSH RETAINER	A-19244 FORD TRUNK TRIM PANEL RETAINER 1 HEAD DIA
A-19422 CHRYSLER FASCIA PUSH TYPE RETAINER 29/32 STM LENGTH	A-19801 GM PUSH-TYPE RETAINER	A-20191 FORD PUSH TYPE RETNR 16MM HD DIA 18MM STM LGTH	A-20349 NISSAN BUMPER CLIP PUSH TYPE RETAINER	A-20923 FORD & MAZDA PUSH TYPE RETAINER
A-21173 ACURA & HONDA PUSH TYPE RTNR BLK BUMPER & SPLASH SHIELD				

PRODUCT CATEGORY: X

### Push-In Fasteners

16 Items • 135 Pcs  
IBS No. 843R



Packaged in a Locking Steel Drawer  
for Easy Storage & Organization

ASSORTMENTS



# IBS, INCORPORATED

## Assortments - Automotive (X)

ASSORTMENTS



### Tire Valves and Caps Assortment

Assortment No. 861R

10963 TR# 413 Rubber Snap-In Valve 	10994 TR #600HP 1 1/4 High" Pressure Snap-In 	10970 TR #C-1, Short Std. Bore Valve Core, Black 	10972 TR #VC-3, Long Skirted Metal Dome Cap 
10964 TR# 414 Rubber Snap-In Valve 	10995 TR #602HP 2 High Pressure" Snap-In 	10971 TR #C-1, Short Std. Bore Valve Core, High Temp (Red) 	10973 TR #VC-3, Black Plastic Valve Cap 
10965 TR# 415 Rubber Snap-In Valve 	10991 TR# 801HP 1-1/4 High Pressure Snap-In, .625 Rim Hole 	10975 3/4 Metal Valve Extension 	10981 LONG SKIRTED GREEN PLASTIC VALVE CAP WITH SEAL 
10968 TR# 418 Rubber Snap-In Valve 	10992 TR# 802HP 2 HI Press Snap In .625 Rimi Hole 	10976 1-1/4 Metal Valve Extension 	10986 Four-Way Valve Tool 

PRODUCT CATEGORY: X

### Tire Valves and Caps

16 Items • 210 Pcs

IBS No. 861R



Packaged in a Locking Steel Drawer for Easy Storage & Organization



### Tire Repair Assortment

Assortment No. 862R

10907 1-3/4 (44mm) Small Round USA Universal Repair Units Radial or Bias 	10914 2-1/4 x 4 (57mmx 100mm) Radial 12, 1 Ply USA Style COI Radial Repair Unit 	10921 1-5/8 (42mm) Round, 5/32 (4mm) Round Stem Universal Quilled 	10926 Patch: 2-1/8 (55mm), Stem 1/4 (7.5mm) Lead-Wire Combination Unit 
10908 2-1/4 (57mm) Medium Round USA Universal Repair Units Radial or Bias 	10915 3-3/4 x 4 (95mm x 100mm) Radial 14, 1 Ply USA COI Radial Repair Unit 	10922 1-7/8 (47mm) Round, 7/32 (5.5mm) Round Stem Universal Quilled 	10918 4 (102mm) Fat, Brown String 
10909 3-1/4 (82mm) Large Round USA Universal Repair Units Radial or Bias 	10916 2-7/8 x 5 (72mm x 125mm) Radial 20, 2 Ply USA COI Radial Repair Unit 	10925 Patch: 1-5/8 (42mm), Stem: 3/16 (5mm) Lead-Wire Combination Unit 	10920 8 (204mm) Fat, Brown String 

PRODUCT CATEGORY: X

### Tire Repair

12 Items • 50 Pcs

IBS No. 862R



Packaged in a Locking Steel Drawer for Easy Storage & Organization



IBS, Inc. SPECIALTY PRODUCTS FOR MAINTENANCE & REPAIR INDUSTRIALBOLT.COM © © © 300-678-1996		Hollow Wall Anchors & Fasteners		
Assortment No. 205R				
7698 6 X 1 PHIL PAN HD T/S ZP		55230 4-6-8 X 1 WING SCREW PLASTIC	55038 E-Z MINI ANCHOR ZINC	
7717 8 X 1 PHIL PAN HD T/S ZP	7719 8 X 1-1/2 PHIL PAN HD T/S ZP	55231 8-10-12X1-1/4 WING SCREW	55037 EZ-ANCHOR WHITE NYLON	
7733 10 X 1 PHIL PAN HD T/S ZP	7735 10 X 1-1/2 PHIL PAN HD T/S ZP	55231 8-10-12X1-1/4 WING SCREW	55036 EZ-ANCHOR ZINC	55035 MUNGO JET PLUG EZ-ANCHOR
7763 14 X 1 PHIL PAN HD T/S ZP	7765 14 X 1-1/2 PHIL PAN HD T/S ZP	55232 12-14-16X1-1/2 WING SCREW		55240 E-Z TOGGLE STANDARD

PRODUCT CATEGORY: Y

### Hollow Wall Anchors & Fasteners

16 Items • 650 Pcs  
IBS No. 205R



Packaged in a Locking Steel Drawer for Easy Storage & Organization

IBS, Inc. SPECIALTY PRODUCTS FOR MAINTENANCE & REPAIR INDUSTRIALBOLT.COM © © © 300-678-1996		Concrete Screws with Drills & Installation Kit		
Assortment No. 273P				
55309 1/4 X 2-1/4 HWH CONCRETE SCREW	55316 3/16X2-1/4 PHIL FLT CONCRETE SCREW	55336 5/32X7 SDS HEX CARBIDE DRILL Use with 3/16 Screws	55330 TOOL KIT FOR CONCRETE SCREWS	
55308 1/4 X 1-3/4 HWH CONCRETE SCREW	55315 3/16X1-3/4 PHIL FLT CONCRETE SCREW	55338 3/16X7 SDS HEX CARBIDE DRILL Use with 1/4 Screws		
55307 1/4 X 1-1/4 HWH CONCRETE SCREW	55314 3/16X1-1/4 PHIL FLT CONCRETE SCREW		55317 3/16X2-3/4 PHIL FLT CONCRETE SCREW	55324 1/4X2-3/4 PHIL FLT CONCRETE SCREW
55300 3/16 X 1-1/4 HWH CONCRETE SCREW	55310 1/4 X 2-3/4 HWH CONCRETE SCREW			

PRODUCT CATEGORY: Y

### Concrete Screws with Drills & Installation Kit

13 Items • 253 Pcs  
IBS No. 273P



Packaged in a Locking Steel Drawer for Easy Storage & Organization

IBS, Inc. SPECIALTY PRODUCTS FOR MAINTENANCE & REPAIR INDUSTRIALBOLT.COM © © © 300-678-1996		Hollow Wall Anchors & Fasteners		
Assortment No. 397R				
55095 10-24 (3/16-24) HVY TOGGLE ANCHOR	55096 1/4-20 HVY DUTY TOGGLE ANCHOR	55093 1/2 TO 5/8 POLY TOGGLE	143150 3/16 X 1-1/4 RAPIDRIVE PHIL PH CHROME ANCHOR SCREW	
		55037 EZ-ANCHOR WHITE NYLON		
		7719 8 X 1-1/2 PHIL PAN HD T/S ZP	143152 3/16 X 1-1/4 RAPIDRIVE PHIL OH CHROME ANCHOR SCREW	
9585 10-24 X 3 PHIL ROUND HD M/S ZP	9608 1/4-20 X 4 PHIL ROUND HD M/S ZP			

PRODUCT CATEGORY: Y

### Hollow Wall Anchors

9 Items • 180 Pcs  
IBS No. 397R



Packaged in a Locking Steel Drawer for Easy Storage & Organization

ASSORTMENTS



# **IBS, INCORPORATED**

## **Travel Tray Assortments Z03**

**A  
S  
S  
O  
R  
T  
M  
E  
N  
T  
S**



# IBS, INCORPORATED

## Travel Tray Assortments Z03

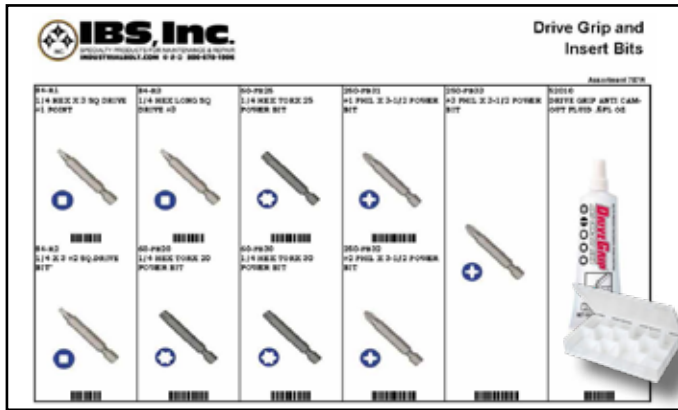

PRODUCT CATEGORY: E

**DRIVE GRIP & INSERT BITS**  
IBS No. 787R • 10 ITEMS • 19 Pcs

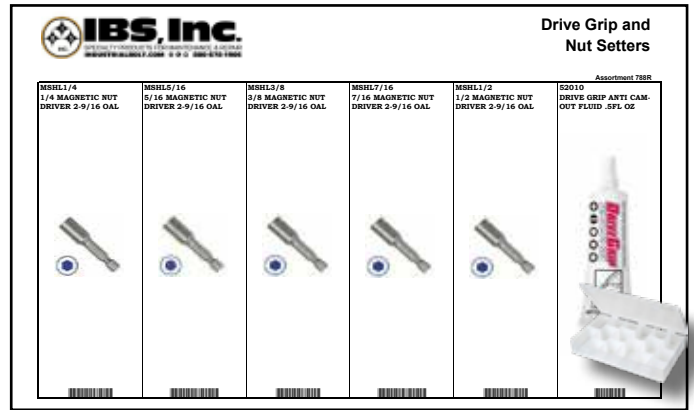

PRODUCT CATEGORY: E

**DRIVE GRIP & NUTSETTS**  
IBS No. 788R • 6 ITEMS • 9 Pcs



PRODUCT CATEGORY: E

**GRAB-IT DAMAGED  
SCREW REMOVER**  
IBS No. 794R • 5 ITEMS • 5 Pcs

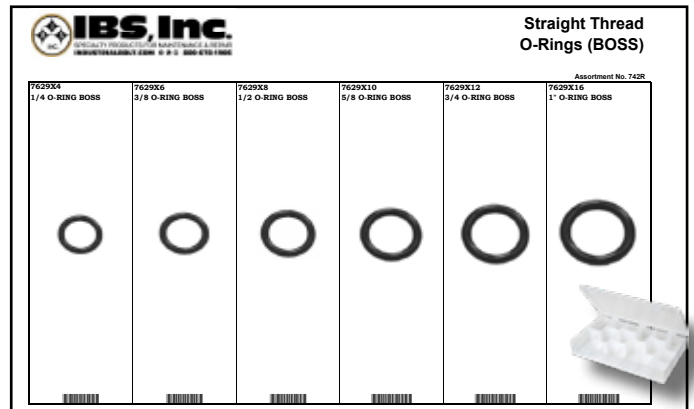

PRODUCT CATEGORY: O

**STRAIGHT THREAD BOSS O-RINGS**  
IBS No. 742R • 6 ITEMS • 135 Pcs

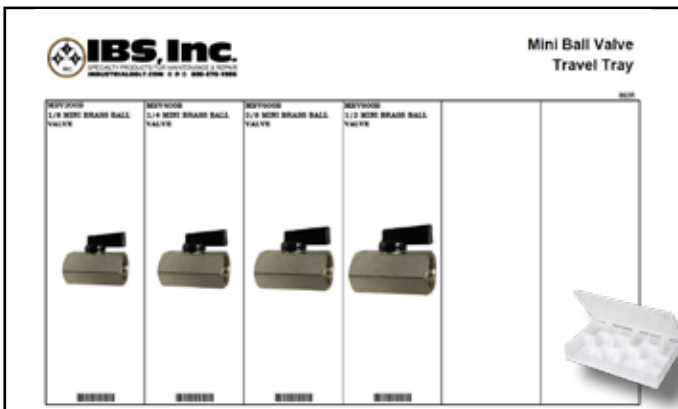

PRODUCT CATEGORY: O

**MINI BALL VALVE**  
IBS No. 863R • 4 ITEMS • 10 Pcs



PRODUCT CATEGORY: O

**GLADHAND SEALS**  
IBS No. 864R • 5 ITEMS • 45 Pcs

ASSORTMENTS



# IBS, INCORPORATED

## Travel Tray Assortments Z03

ASSORTMENTS



PRODUCT CATEGORY: PA  
**POWER TUBE BRUSHES**  
 IBS No. 704R • 6 ITEMS • 6 Pcs



PRODUCT CATEGORY: PD  
**NITRO CARB DRAPS COARSE THREAD**  
 IBS No. 17178 • 6 ITEMS • 6 Pcs

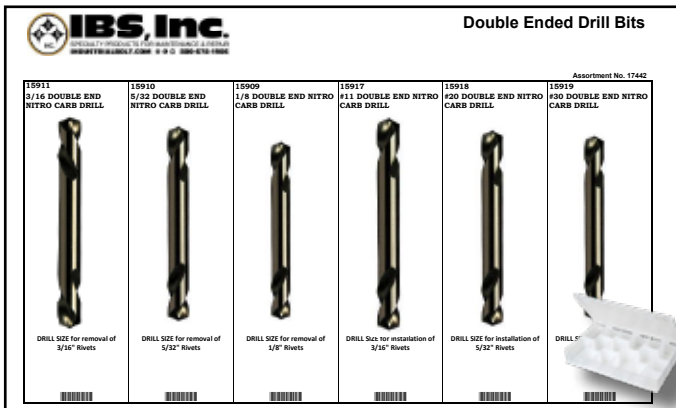

PRODUCT CATEGORY: PD  
**DOUBLE-ENDED DRILL BITS**  
 IBS No. 17442 • 6 ITEMS • 6 Pcs



PRODUCT CATEGORY: PD  
**NITRO CARB DRAPS METRIC THREAD**  
 IBS No. 17179 • 4 ITEMS • 4 Pcs



PRODUCT CATEGORY: PD  
**NITRO-CARB-STEP DRILLS**  
 IBS No. 749R • 6 ITEMS • 6 Pcs

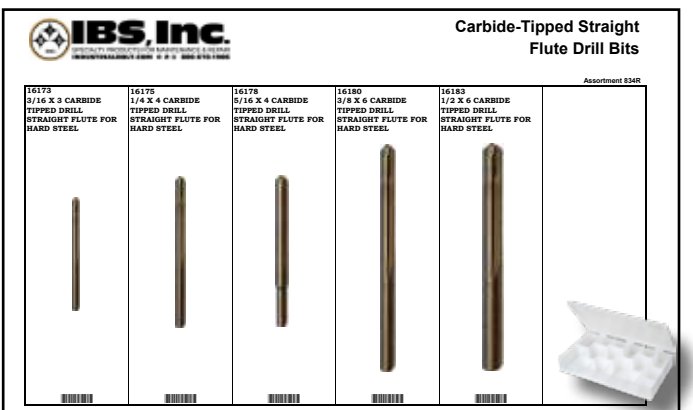

PRODUCT CATEGORY: PD  
**CARBIDE-TIPPED STRAIGHT FLUTE DRILL BITS**  
 IBS No. 834R • 5 ITEMS • 5 Pcs

# IBS, INCORPORATED

## Travel Tray Assortments Z03



PRODUCT CATEGORY: PD

**POWER OUT EXTRACTOR & LEFT HAND NITRO CARB DRILL BITS**  
**IBS No. 745R • 10 ITEMS • 10 Pcs**



PRODUCT CATEGORY: PD

**POWER-OUT EXTRACTORS & STUBBY LEFT HAND DRILL BITS**  
**IBS No. 818R • 10 ITEMS • 10 Pcs**

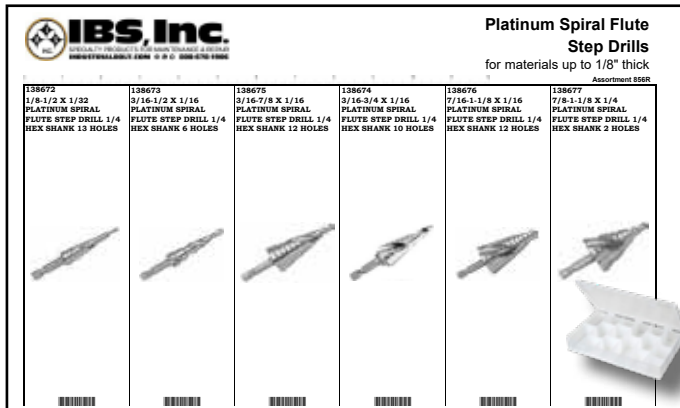

PRODUCT CATEGORY: PD

**PLATINUM SPIRAL FLUTE STEP DRILLS**  
**IBS No. 856R • 6 ITEMS • 6 Pcs**

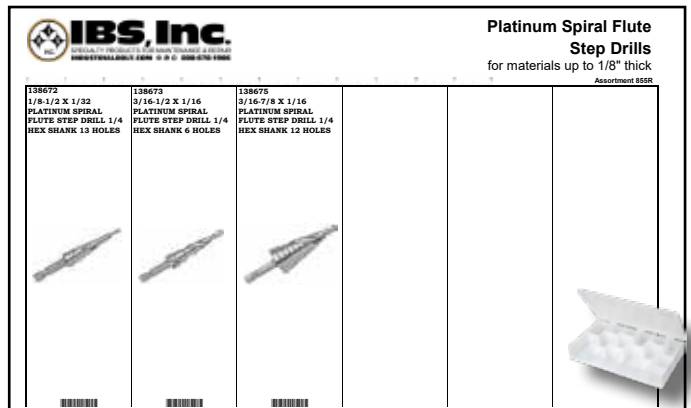

PRODUCT CATEGORY: PD

**PLATINUM SPIRAL FLUTE STEP DRILLS**  
**IBS No. 855R • 3 ITEMS • 3 Pcs**

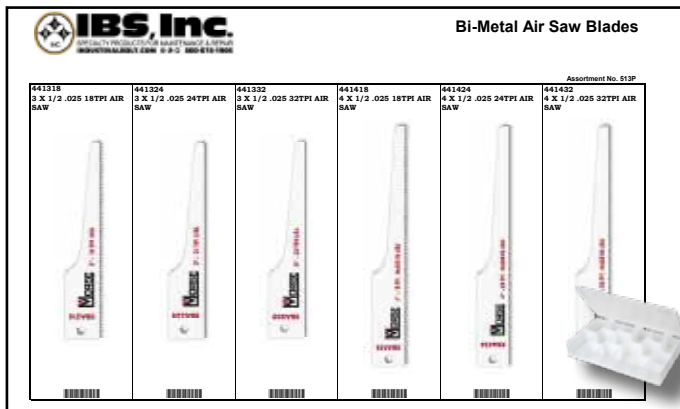

PRODUCT CATEGORY: PT

**BI-METAL AIR SAW BLADES**  
**IBS No. 513P • 6 ITEMS • 30 Pcs**

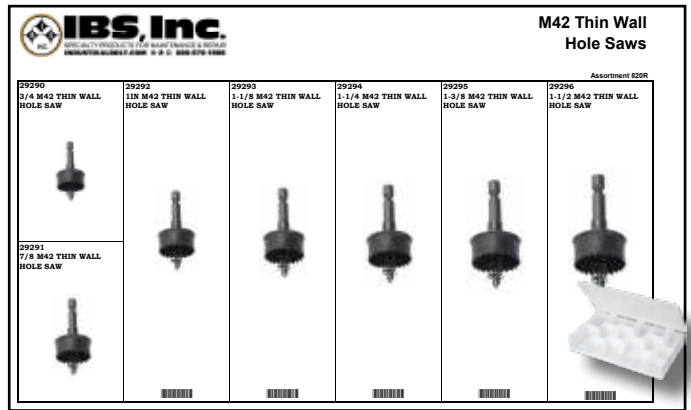

PRODUCT CATEGORY: PT

**M42 THIN WALL HOLE SAWS**  
**IBS No. 820R • 7 ITEMS • 7 Pcs**

ASSORTMENTS



# IBS, INCORPORATED

## Travel Tray Assortments Z03

ASSORTMENTS

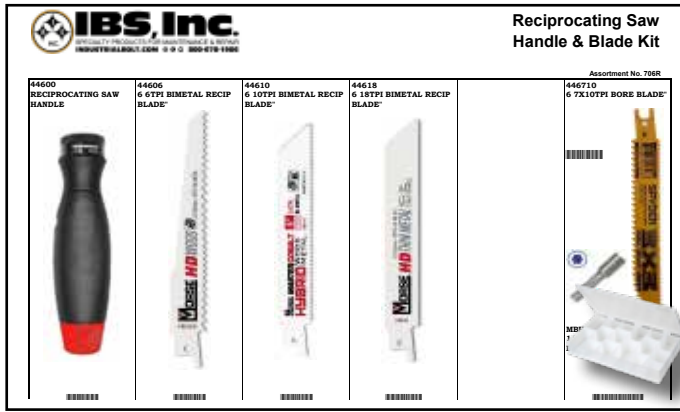

PRODUCT CATEGORY: PT

### RECIPROCATING SAW HANDLE BLADE KIT

IBS No. 706R • 7 ITEMS • 11 Pcs

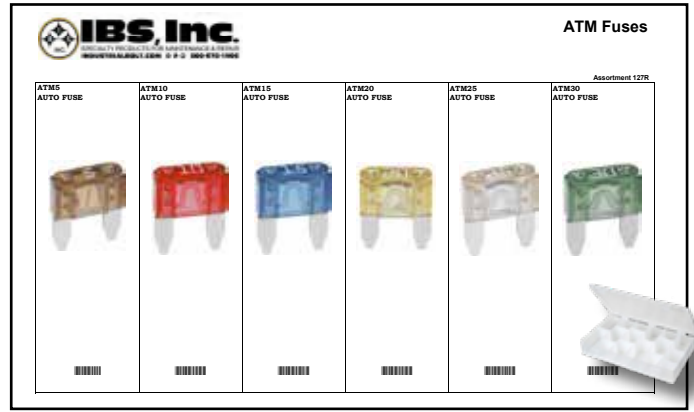

PRODUCT CATEGORY: Q

### ATM FUSES

IBS No. 127R • 6 ITEMS • 60 Pcs

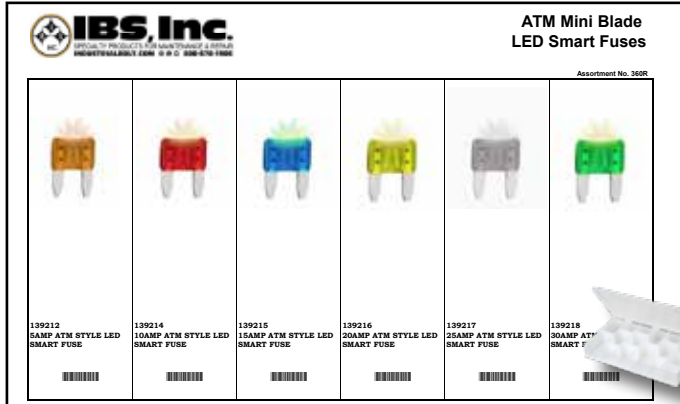

PRODUCT CATEGORY: Q

### ATM MINI BLADE LED SMART FUSES

IBS No. 360R • 6 ITEMS • 36 Pcs



PRODUCT CATEGORY: Q

### MAXI FUSES

IBS No. 128R • 7 ITEMS • 31 Pcs



PRODUCT CATEGORY: Q

### MAXI BLADE LED SMART FUSES

IBS No. 362R • 6 ITEMS • 18 Pcs

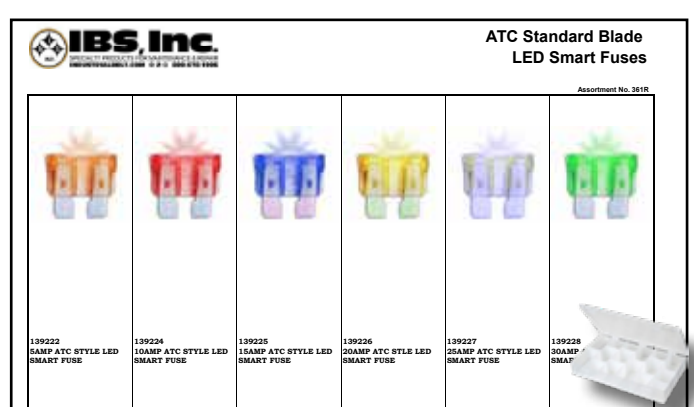

PRODUCT CATEGORY: Q

### ATC STANDARD BLADE LED FUSES

IBS No. 361R • 6 ITEMS • 42 Pcs

# IBS, INCORPORATED

## Travel Tray Assortments Z03



PRODUCT CATEGORY: Q

**ATM LOW PROFILE FUSES**  
 IBS No. 721R • 7 ITEMS • 35 Pcs

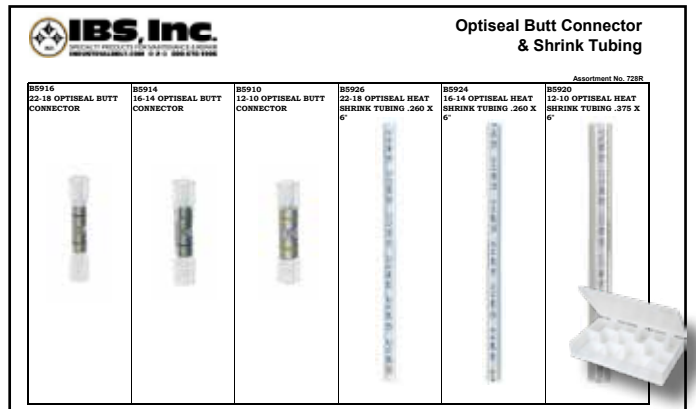

PRODUCT CATEGORY: Q

**OPTI-SEAL BUTT CONNECTORS & SHRINK TUBING**

IBS No. 728R • 6 ITEMS • 100 Pcs

**IBS No. 728R-1 • KIT WITH CRIMP TOOL**

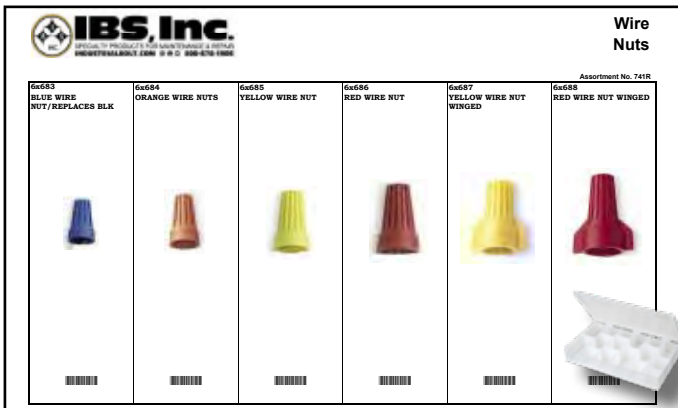

PRODUCT CATEGORY: Q

**WIRE NUTS**  
 IBS No. 741R • 6 ITEMS • 90 Pcs

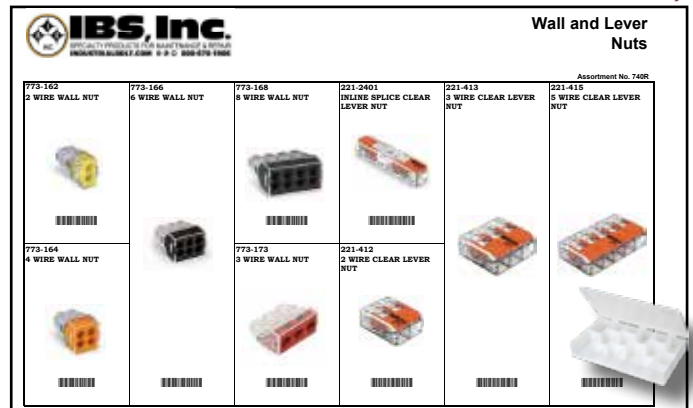

PRODUCT CATEGORY: Q

**WALL & LEVER NUTS**  
 IBS No. 740R • 9 ITEMS • 105 Pcs



PRODUCT CATEGORY: Q

**ATC FUSES**  
 IBS No. 792R • 8 ITEMS • 40 Pcs

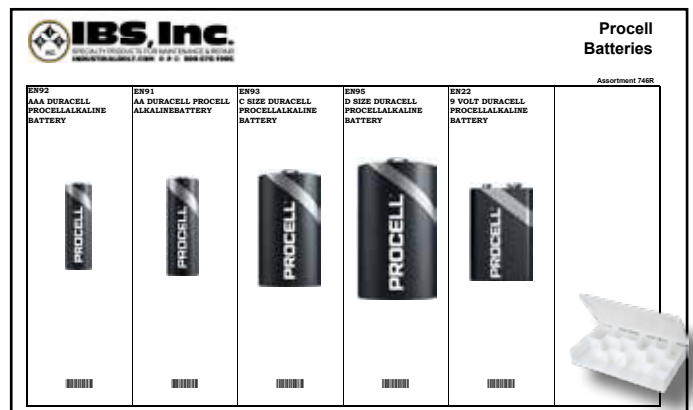

PRODUCT CATEGORY: Q

**PROCELL BATTERIES**  
 IBS No. 746R • 5 ITEMS • 30 Pcs

ASSORTMENTS



# IBS, INCORPORATED

## Travel Tray Assortments Z03

A  
S  
S  
O  
R  
T  
M  
E  
N  
T  
S

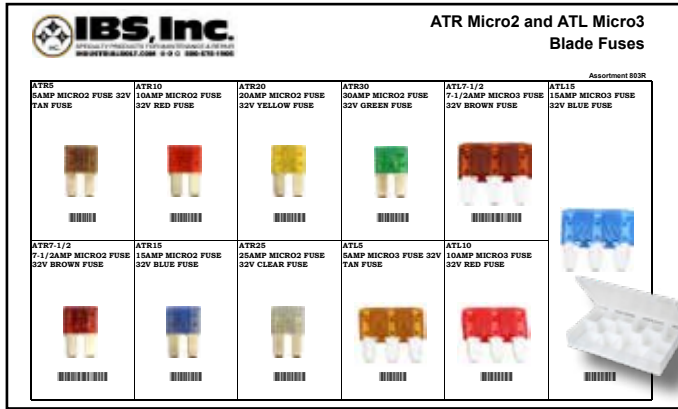

PRODUCT CATEGORY: Q

**ATR MICRO2 & ATL MICRO3  
BLADE FUSES**  
IBS No. 803R • 11 ITEMS • 55 Pcs

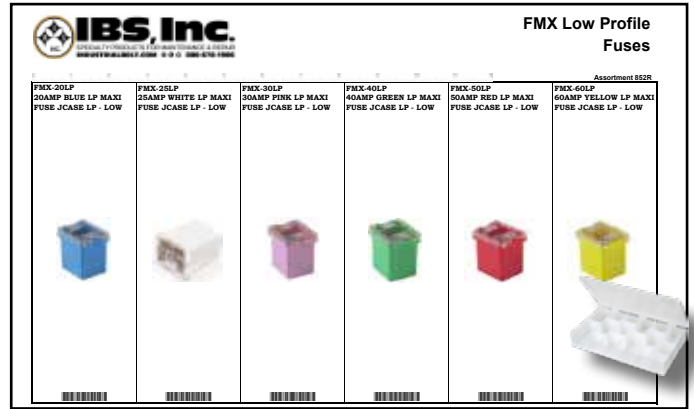

PRODUCT CATEGORY: Q

**FMX LOW PROFILE FUSES**  
IBS No. 852R • 6 ITEMS • 12 Pcs



PRODUCT CATEGORY: Q

**FMX FUSES**  
IBS No. 851R • 6 ITEMS • 12 Pcs

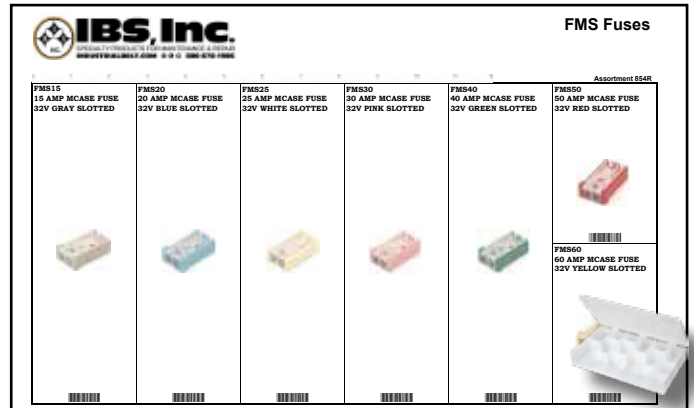

PRODUCT CATEGORY: Q

**FMS FUSES**  
IBS No. 854R • 7 ITEMS • 35 Pcs



PRODUCT CATEGORY: Q

**FMM FUSES**  
IBS No. 853R • 5 ITEMS • 30 Pcs



PRODUCT CATEGORY: SA

**LOCTITE QUICK-STIX  
TRAVEL TRAY**  
IBS No. 673R • 6 ITEMS • 6 Pcs



PRODUCT CATEGORY: SA

**LOCTITE 10ML TRAVEL TRAY**  
IBS No. 747R • 6 ITEMS • 6 Pcs



PRODUCT CATEGORY: Q

**NO MESS THREADLOCKER TRAVEL TRAY**  
IBS No. 817R • 4 ITEMS • 4 Pcs



PRODUCT CATEGORY: SCO

**DURA-INK INDUSTRIAL MARKERS**  
IBS No. 694R • 7 ITEMS • 11 Pcs



PRODUCT CATEGORY: Q

**THREADLOCKER, ANTI-SEIZE & DIELECTRIC GREASE TRAVEL TRAY**  
IBS No. 832R • 6 ITEMS • 12 Pcs

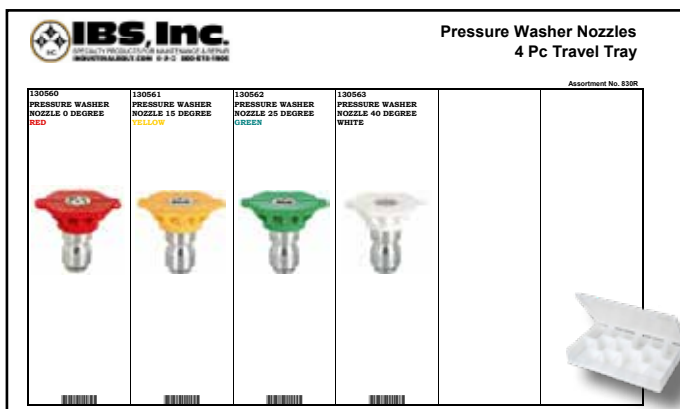

PRODUCT CATEGORY: V

**PRESSURE WASHER NOZZLES**  
IBS No. 830R • 4 ITEMS • 4 Pcs



PRODUCT CATEGORY: SCO

**QUIK STIK & PAINT MARKERS**  
IBS No. 806R • 6 ITEMS • 6 Pcs

ASSORTMENTS

