

# IBS, INCORPORATED

## Assortments (Drawer & Bin) Z02 & Z06



### Select-O-Sort Assortments

Select-O-Sorts are specially designed assortments which are unique for each customer. In these assortments the customer decides which products best suit their needs. Our standard assortments, while designed to fit a broad spectrum of customer needs, may not always be right for each customer. For more information on Select-O-Sorts, refer to your Administration Manual SM-201.

IBS No.	UNITS	CABINET
50200	36	36B
50201	40	40B
50202	42	42B
50203	56	56B
50204	72	72B
50205	30	18D
50206	50	18D
50207	12	DL-12C
50209	16	DL-16C
50211	20	DL-20C
50212	21	DL-21C
50213	24	DL-24C
50214	32	DL-32C
50216	ADJ	AD-H, AD-L, AD-E
50218	VARIES	DS (SMALL DRAWER)
50219	80	2 - 40B
50225	MISC	MISC

ASSORTMENTS





# IBS, INCORPORATED

## Assortment Drawers Z02

### Large Drawers



A  
S  
S  
O  
R  
T  
M  
E  
N  
T  
S

# IBS, INCORPORATED

## Assortments - Fasteners (A)



IBS, Inc. SPECIALTY PRODUCTS FOR MAINTENANCE & REPAIR INDUSTRIALBOLT.COM • 800-878-1906		Hex Flange Bolts		
Assortment No. 811R				
3198 1/4-20 FLANGE LOCK NUT GR.G PLN 	3110 1/4-20 X 3/4 GR8 HEX FLANGE BOLT PLN 	3111 1/4-20 X 1 GR8 HEX FLANGE BOLT PLN 	3112 1/4-20 X 1-1/4 GR8 HEX FLANGE BOLT PLN 	3113 1/4-20 X 1-1/2 GR8 HEX FLANGE BOLT PLN 
3199 5/16-18 FLANGE LOCK NUT GR.G PLN 	3120 5/16-18 X 3/4 GR8 HEX FLANGE BOLT PLN 	3121 5/16-18 X 1 GR8 HEX FLANGE BOLT PLN 	3122 5/16-18 X 1-1/4 GR8 HEX FLANGE BOLT PLN 	3123 5/16-18 X 1-1/2 GR8 HEX FLANGE BOLT PLN 
4000 3/8-16 FLANGE LOCK NUT GR.G PLN 	3200 3/8-16 X 1 GR8 HEX FLANGE BOLT PLN 	3201 3/8-16 X 1-1/4 GR8 HEX FLANGE BOLT PLN 	3202 3/8-16 X 1-1/2 GR8 HEX FLANGE BOLT PLN 	3204 3/8-16 X 2 GR8 HEX FLANGE BOLT PLN 

PRODUCT CATEGORY: A

**Hex Flange Bolts**  
**15 Items • 405 Pcs**  
**IBS No. 811R**



**Packaged in a Locking Steel Drawer  
 for Easy Storage & Organization**

A  
S  
S  
O  
R  
T  
M  
E  
N  
T  
S



# IBS, INCORPORATED

## Assortments - Hex Nuts (B)

ASSORTMENTS

IBS, Inc. SPECIALTY PRODUCTS FOR MAINTENANCE & REPAIR INDUSTRIALBOLT.COM © 9 0 800-678-1506		Machine Screw Nuts, Wing Nuts & Cap Nuts			Assortment No. 126R
5076 8-32 CAP NUT ZP 	5032 4-40 HEX MACHINE SCREW NUT ZP 	5036 10-32 HEX MACHINE SCREW NUT ZP 	5086 8-32 WING NUT ZP 	5089 1/4-20 WING NUT ZP 	
5077 10-24 CAP NUT ZP 	5033 6-32 HEX MACHINE SCREW NUT ZP 	5037 12-24 HEX MACHINE SCREW NUT ZP 	5087 10-24 WING NUT ZP 	5090 5/16-18 WING NUT ZP 	
5079 1/4-20 CAP NUT NP 	5034 8-32 HEX MACHINE SCREW NUT ZP 	5038 1/4-20 HEX MACHINE SCREW NUT 	5088 10-32 WING NUT ZP 	5091 3/8-16 WING NUT ZP 	
5080 5/16-18 CAP NUT NP 	5035 10-24 HEX MACHINE SCREW NUT ZP 	5039 5/16-18 HEX MACHINE SCREW NUT 			

PRODUCT CATEGORY: B

### Machine Screw Nuts, Wing Nuts & Cap Nuts

18 Items • 1,225 Pcs

IBS No. 126R



Packaged in a Locking Steel Drawer  
for Easy Storage & Organization

IBS, Inc. SPECIALTY PRODUCTS FOR MAINTENANCE & REPAIR INDUSTRIALBOLT.COM © 9 0 800-678-1506		Machine Screw Nuts & Washers				Assortment No. 392R
7100 #4 MEDIUM LOCKWASHER ZP 	7101 #6 MEDIUM LOCKWASHER ZP 	7102 #8 MEDIUM LOCKWASHER ZP 	7103 #10 MEDIUM LOCKWASHER ZP 	7104 #12 MEDIUM LOCKWASHER ZP 	7105 1/4 MEDIUM LOCKWASHER ZP 	
7044 #4 SAE FLAT WASHER ZP 	7045 #6 SAE FLAT WASHER ZP 	7046 #8 SAE FLAT WASHER ZP 	7047 #10 SAE FLAT WASHER ZP 	7048 #12 SAE FLAT WASHER ZP 	7049 1/4 SAE FLAT WASHER ZP 	
5032 4-40 HEX MACHINE SCREW NUT ZP 	5033 6-32 HEX MACHINE SCREW NUT ZP 	5034 8-32 HEX MACHINE SCREW NUT ZP 	5035 10-24 HEX MACHINE SCREW NUT ZP 	5036 10-32 HEX MACHINE SCREW NUT ZP 	5038 1/4-20 HEX MACHINE SCREW NUT 	
5037 12-24 HEX MACHINE SCREW NUT ZP 	5001 6-32 NYLOC NUT ZP 	5002 8-32 NYLOC NUT ZP 	5003 10-24 NYLOC NUT ZP 	6099 10-32 NYLOC NUT ZP 	5004 1/4-20 NYLOC NUT ZP 	

PRODUCT CATEGORY: B

### Machine Screw Nuts & Washers

24 Items • 1,250 Pcs

IBS No. 392R



Packaged in a Locking Steel Drawer  
for Easy Storage & Organization

# IBS, INCORPORATED

## Assortments - Washers (C)



IBS, Inc. SPECIALTY PRODUCTS FOR MAINTENANCE & REPAIR INDUSTRIALBOLT.COM • 800-670-1506		Heavy Duty Flat Washers		
Assortment No. 117R				
7303 7/16 HVY DUTY FLAT WASHER PLN 	7307 3/4 HVY DUTY FLAT WASHER PLN 			
7302 3/8 HVY DUTY FLAT WASHER PLN 	7306 5/8 HVY DUTY FLAT WASHER PLN 			
7301 5/16 HVY DUTY FLAT WASHER PLN 	7305 9/16 HVY DUTY FLAT WASHER PLN 	7309 1 HVY DUTY FLAT WASHER PLN 		
7300 1/4 HVY DUTY FLAT WASHER PLN 	7304 1/2 HVY DUTY FLAT WASHER PLN 	7308 7/8 HVY DUTY FLAT WASHER PLN 		

PRODUCT CATEGORY: C

**Heavy Duty Flat Washers**  
**10 Items • 330 Pcs**  
**IBS No. 117R**



**Packaged in a Locking Steel Drawer for Easy Storage & Organization**

IBS, Inc. SPECIALTY PRODUCTS FOR MAINTENANCE & REPAIR INDUSTRIALBOLT.COM • 800-670-1506		Fender Washers		
Assortment No. 320R				
7225 3/16 X 3/4 FENDER WASHER ZP 	7232 5/16 X 1-1/2 FENDER WASHER ZP 	7245 1/4 X 1-1/8 HVY DUTY FENDER WASHER ZP 		
7227 3/16 X 1-1/4 FENDER WASHER ZP 	7234 3/8 X 1-1/2 FENDER WASHER ZP 	7246 5/16 X 1-1/4 HVY DUTY FENDER WASHER ZP 		
7229 1/4 X 1 FENDER WASHER ZP 	7235 1/2 X 2 FENDER WASHER ZP 	7247 3/8 X 2 HVY DUTY FENDER WASHER ZP 		
7230 1/4 X 1-1/4 FENDER WASHER ZP 		7248 1/2 X 2 HVY DUTY FENDER WASHER ZP 		

PRODUCT CATEGORY: C

**Fender Washers**  
**11 Items • 650 Pcs**  
**IBS No. 320R**



**Packaged in a Locking Steel Drawer for Easy Storage & Organization**

IBS, Inc. SPECIALTY PRODUCTS FOR MAINTENANCE & REPAIR INDUSTRIALBOLT.COM • 800-670-1506		Sur-Lock Washers	
Assortment No. 698R			
7250 1/4 & M6 SUR-LOCK WASHER PAIR 	7251 5/16 & M8 SUR-LOCK WASHER PAIR 	7252 3/8 & M10 SUR-LOCK WASHER PAIR 	7253 7/16 & M11 SUR-LOCK WASHER PR 
7254 1/2 & M12 SUR-LOCK WASHER PAIR 	7255 9/16 & M14 SUR-LOCK WASHER PR 	7256 5/8 & M16 SUR-LOCK WASHER PAIR 	7257 3/4 & M20 SUR-LOCK WASHER PAIR 
7258 7/8 & M22 SUR-LOCK WASHER PAIR 	7259 1" & M24 SUR-LOCK WASHER PAIR 		

PRODUCT CATEGORY: C

**Sur-Lock Washers**  
**10 Items • 99 Pcs**  
**IBS No. 698R**



**Packaged in a Locking Steel Drawer for Easy Storage & Organization**

ASSORTMENTS



# IBS, INCORPORATED

## Assortments - Washers (C)



### Internal and External Star Washers

Assortment No. 797R

7162 #6 STAR WASHER INTERNAL ZP	7163 #8 STAR WASHER INTERNAL ZP	7164 #10 STAR WASH INTERNAL ZP	7165 #12 STAR WASHER INTERNAL ZP	7166 1/4 STAR WASHER INTERNAL ZP	7167 5/16 STAR WASHER INTERNAL ZP
7168 3/8 STAR WASHER INTERNAL ZP	7169 7/16 STAR WASHER INTERNAL ZP	7170 1/2 STAR WASHER INTERNAL ZP	7171 9/16 STAR WASHER INTERNAL ZP	7172 5/8 STAR WASHER INTERNAL ZP	7173 3/4 STAR WASHER INTERNAL ZP
7180 #6 STAR WASHER EXTERNAL ZP	7181 #8 STAR WASHER EXTERNAL ZP	7182 #10 STAR WASHER EXTERNAL ZP	7183 #12 STAR WASHER EXTERNAL ZP	7184 1/4 STAR WASHER EXTERNAL ZP	7185 5/16 STAR WASHER EXTERNAL ZP
7186 3/8 STAR WASHER EXTERNAL ZP	7187 7/16 STAR WASHER EXTERNAL ZP	7188 1/2 STAR WASHER EXTERNAL ZP	7189 9/16 STAR WASHER EXTERNAL ZP	7190 5/8 STAR WASHER EXTERNAL ZP	7191 3/4 STAR WASHER EXTERNAL ZP

PRODUCT CATEGORY: C

## Internal & External Star Washers

24 Items • 775 Pcs  
IBS No. 797R



Packaged in a Locking Steel Drawer  
for Easy Storage & Organization

A  
S  
S  
O  
R  
T  
M  
E  
N  
T  
S



<b>Phillips Pan Head Tapping Screws</b>					
<small>Phillips Bit Chart</small> <small>Phillips bit chart will help you match the correct bit to the screw. Phillips screw bits are available in a variety of sizes. Please refer to the chart for more information.</small>					
Assortment No. 113R					
7693 6 X 3/8 PHIL PAN HD T/S ZP	7698 6 X 1" PHIL PAN HD T/S ZP	7717 8 X 1" PHIL PAN HD T/S ZP	7733 10 X 1" PHIL PAN HD T/S ZP	7748 12 X 1" PHIL PAN HD T/S ZP	7761 14 X 3/4 PHIL PAN HD T/S ZP
7694 6 X 1/2 PHIL PAN HD T/S ZP	7713 8 X 1/2 PHIL PAN HD T/S ZP	7729 10 X 1/2 PHIL PAN HD T/S ZP	7735 10 X 1-1/2 PHIL PAN HD T/S ZP	7749 12 X 1-1/4 PHIL PAN HD T/S ZP	7763 14 X 1" PHIL PAN HD T/S ZP
7695 6 X 5/8 PHIL PAN HD T/S ZP	7714 8 X 5/8 PHIL PAN HD T/S ZP	7730 10 X 5/8 PHIL PAN HD T/S ZP	7744 12 X 1/2 PHIL PAN HD T/S ZP	7750 12 X 1-1/2 PHIL PAN HD T/S ZP	7764 14 X 1-1/4 PHIL PAN HD T/S ZP
7696 6 X 3/4 PHIL PAN HD T/S ZP	7715 8 X 3/4 PHIL PAN HD T/S ZP	7731 10 X 3/4 PHIL PAN HD T/S ZP	7746 12 X 3/4 PHIL PAN HD T/S ZP	7760 14 X 5/8 PHIL PAN HD T/S ZP	7765 14 X 1-1/2 PHIL PAN HD T/S ZP

PRODUCT CATEGORY: E

### Phillips Pan Head Tapping Screws

24 Items • 1500 Pcs  
IBS No. 113R



Packaged in a Locking Steel Drawer for Easy Storage & Organization

<b>Hex Washer Head Thread Cutting Screws Type "F"</b>				
Assortment No. 150R				
8207 8-32 X 1/2 HWH T/C TYPE F ZP	8209 8-32 X 3/4 HWH T/C TYPE F ZP	8211 8-32 x 1 HWH T/C TYPE F ZP	8214 10-24 X 1/2 HWH T/C TYPE F ZP	8215 10-24 X 5/8 HWH T/C TYPE F ZP
Hex Size 1/4"	Hex Size 1/4"	Hex Size 1/4"	Hex Size 5/16"	Hex Size 5/16"
8216 10-24 X 3/4 HWH T/C TYPE F ZP	8217 10-24 X 1 HWH T/C TYPE F ZP	8220 12-24 X 3/4 HWH T/C TYPE F ZP	8221 12-24 X 1 HWH T/C TYPE F ZP	8223 1/4-20 X 1/2 HWH T/C TYPE F ZP
Hex Size 5/16"	Hex Size 5/16"	Hex Size 5/16"	Hex Size 5/16"	Hex Size 3/8"
8225 1/4-20 X 3/4 HWH T/C TYPE F ZP	8226 1/4-20 X 1 HWH T/C TYPE F ZP	8227 1/4-20 X 1-1/4 HWH T/C TYPE F ZP	8229 5/16-18 X 3/4 HWH T/C TYPE F ZP	8230 5/16-18 X 1 HWH T/C TYPE F ZP
Hex Size 3/8"	Hex Size 3/8"	Hex Size 3/8"	Hex Size 1/2"	Hex Size 1/2"
8231 5/16-18 X 1-1/4 HWH T/C TYPE F ZP	8232 3/8-16 X 3/4 HWH T/C TYPE F ZP	8233 3/8-16 X 1 HWH T/C TYPE F ZP	8234 3/8-16 X 1-1/4 HWH T/C TYPE F ZP	8235 3/8-16 X 1-1/2 HWH T/C TYPE F ZP
Hex Size 1/2"	Hex Size 9/16"	Hex Size 9/16"	Hex Size 9/16"	Hex Size 9/16"

PRODUCT CATEGORY: E

### Hex Washer Head Thread Cutting Screws Type "F"

20 Items • 380 Pcs  
IBS No. 150R



Packaged in a Locking Steel Drawer for Easy Storage & Organization

<b>Hex Washer Head Tapping Screws</b>					
Assortment No. 152R					
8097 6 X 1/4 SLTD HEX WASHER HD	8098 6 X 3/8 SLTD HEX WASHER HD	8099 6 X 1/2 SLTD HEX WASHER HD	8101 6 X 3/4 SLTD HEX WASHER HD	8102 6 X 1 SLTD HEX WASHER HD T/S	8160 14 X 3/4 SLTD HEX WASHER HD
Hex Size 1/4"	Hex Size 1/4"	Hex Size 1/4"	Hex Size 1/4"	Hex Size 1/4"	Hex Size 3/8"
8110 8 X 3/8 SLTD HEX WASHER HD	8111 8 X 1/2 SLTD HEX WASHER HD	8113 8 X 3/4 SLTD HEX WASHER HD	8114 8 X 1 SLTD HEX WASHER HD T/S	8115 8 X 1-1/4 SLTD HEX WASHER HD	8161 14 X 1 SLTD HEX WASHER HD T/S
Hex Size 1/4"	Hex Size 1/4"	Hex Size 1/4"	Hex Size 1/4"	Hex Size 1/4"	Hex Size 3/8"
8127 10 X 3/8 SLTD HEX WASHER HD	8128 10 X 1/2 SLTD HEX WASHER HD	8129 10 X 5/8 SLTD HEX WASHER HD	8130 10 X 3/4 SLTD HEX WASHER HD	8131 10 X 1 SLTD HEX WASHER HD T/S	8162 14 X 1-1/4 SLTD HEX WASHER HD
Hex Size 5/16"	Hex Size 5/16"	Hex Size 5/16"	Hex Size 5/16"	Hex Size 5/16"	Hex Size 3/8"
8133 10 X 1-1/2 SLTD HEX WASHER HD	8143 12 X 1/2 SLTD HEX WASHER HD	8145 12 X 3/4 SLTD HEX WASHER HD	8146 12 X 1 SLTD HEX WASHER HD T/S	8148 12 X 1-1/2 SLTD HEX WASHER HD	8163 14 X 1-1/2 SLTD HEX WASHER HD
Hex Size 5/16"	Hex Size 5/16"	Hex Size 5/16"	Hex Size 5/16"	Hex Size 5/16"	Hex Size 3/8"

PRODUCT CATEGORY: E

### Slotted Hex Washer Head Tapping Screws

24 Items • 1,325 Pcs  
IBS No. 152R



Packaged in a Locking Steel Drawer for Easy Storage & Organization



# IBS, INCORPORATED

## Assortments - Tapping Screws & Driver Bits (E)

ASSORTMENTS

IBS, Inc. SPECIALTY PRODUCTS FOR MAINTENANCE & REPAIR INDUSTRIALBOLT.COM • 800-678-1996		Square Bit Chart				Square Drive Pan Head Tapping Screws	
7934 6 X 3/8 SQUARE DR PAN HD T/S	7938 6 X 1 SQUARE DR PAN HD T/S ZP	7950 8 X 1 SQUARE DR PAN HD T/S ZP	7965 10 X 1 SQUARE DR PAN HD T/S ZP	7980 12 X 1 SQUARE DR PAN HD T/S ZP	7994 14 X 3/4 SQUARE DR PAN HD T/S	Assortment No. 162R	
7935 6 X 1/2 SQUARE DR PAN HD T/S	7947 8 X 1/2 SQUARE DR PAN HD T/S	7962 10 X 1/2 SQUARE DR PAN HD T/S	7966 10 X 1-1/4 SQUARE DR PAN HD	7981 12 X 1-1/4 SQUARE DR PAN HD	7995 14 X 1-1/4 SQUARE DR PAN HD T/S ZP		
7936 6 X 5/8 SQUARE DR PAN HD T/S	7948 8 X 5/8 SQUARE DR PAN HD T/S	7963 10 X 5/8 SQUARE DR PAN HD T/S	7978 12 X 5/8 SQUARE DR PAN HD T/S	7982 12 X 1-1/2 SQUARE DR PAN HD	7996 14 X 1-1/4 SQUARE DR PAN HD		
7937 6 X 3/4 SQUARE DR PAN HD T/S	7949 8 X 3/4 SQUARE DR PAN HD T/S	7964 10 X 3/4 SQUARE DR PAN HD T/S	7979 12 X 3/4 SQUARE DR PAN HD T/S	7993 14 X 5/8 SQUARE DR PAN HD T/S	7997 14 X 1-1/2 SQUARE DR PAN HD		

PRODUCT CATEGORY: E

IBS, Inc. SPECIALTY PRODUCTS FOR MAINTENANCE & REPAIR INDUSTRIALBOLT.COM • 800-678-1996		Phillips Bit Chart				Phillips Flat Head Tapping Screws	
7785 6 X 3/8 PHIL FLAT HD T/S ZP	7790 6 X 1 PHIL FLAT HD T/S ZP	7807 8 X 1 PHIL FLAT HD T/S ZP	7820 10 X 3/4 PHIL FLAT HD T/S ZP	7834 12 X 3/4 PHIL FLAT HD T/S ZP	7847 14 X 3/4 PHIL FLAT HD T/S ZP	Assortment No. 166R	
7786 6 X 1/2 PHIL FLAT HD T/S ZP	7803 8 X 1/2 PHIL FLAT HD T/S ZP	7808 8 X 1-1/4 PHIL FLAT HD T/S ZP	7822 10 X 1 PHIL FLAT HD T/S ZP	7836 12 X 1 PHIL FLAT HD T/S ZP	7849 14 X 1 PHIL FLAT HD T/S ZP		
7787 6 X 5/8 PHIL FLAT HD T/S ZP	7804 8 X 5/8 PHIL FLAT HD T/S ZP	7818 10 X 1/2 PHIL FLAT HD T/S ZP	7823 10 X 1-1/4 PHIL FLAT HD T/S ZP	7837 12 X 1-1/4 PHIL FLAT HD T/S ZP	7850 14 X 1-1/4 PHIL FLAT HD T/S ZP		
7788 6 X 3/4 PHIL FLAT HD T/S ZP	7805 8 X 3/4 PHIL FLAT HD T/S ZP	7819 10 X 5/8 PHIL FLAT HD T/S ZP	7824 10 X 1-1/2 PHIL FLAT HD T/S ZP	7838 12 X 1-1/2 PHIL FLAT HD T/S ZP	7851 14 X 1-1/2 PHIL FLAT HD T/S ZP		

PRODUCT CATEGORY: E

IBS, Inc. SPECIALTY PRODUCTS FOR MAINTENANCE & REPAIR INDUSTRIALBOLT.COM • 800-678-1996		Serrated Hex Washer Head TEK/Drill Point Screws			
23630 8-18 X 1/2 HWH SERRATED TEK ZP HEX SIZE: 1/4"	23644 10-16 X 1/2 HWH SERRATED TEK ZP HEX SIZE: 5/16"	23654 12-14 X 5/8 HWH SERRATED TEK ZP HEX SIZE: 5/16"	23666 1/4-14 X 3/4 HWH SERRATED TEK ZP HEX SIZE: 3/8"	Assortment No. 173R	
23632 8-18 X 5/8 HWH SERRATED TEK ZP HEX SIZE: 1/4"	23646 10-16 X 5/8 HWH SERRATED TEK ZP HEX SIZE: 5/16"	23656 12-14 X 3/4 HWH SERRATED TEK ZP HEX SIZE: 5/16"	23668 1/4-14 X 1 HWH SERRATED TEK ZP HEX SIZE: 3/8"		
23636 8-18 X 3/4 HWH SERRATED TEK ZP HEX SIZE: 1/4"	23648 10-16 X 3/4 HWH SERRATED TEK ZP HEX SIZE: 5/16"	23658 12-14 X 1 HWH SERRATED TEK ZP HEX SIZE: 5/16"	23670 1/4-14 X 1-1/2 HWH SERRATED TEK ZP HEX SIZE: 3/8"		
23638 8-18 X 1 HWH SERRATED TEK ZP HEX SIZE: 1/4"	23650 10-16 X 1 HWH SERRATED TEK ZP HEX SIZE: 5/16"	23660 12-14 X 1-1/2 HWH SERRATED TEK ZP HEX SIZE: 5/16"	23672 1/4-14 X 2 HWH SERRATED TEK ZP HEX SIZE: 3/8"		

PRODUCT CATEGORY: E

### Square Drive Pan Head Tapping Screws 24 Items • 1250 Pcs IBS No. 162R



Packaged in a Locking Steel Drawer for Easy Storage & Organization

### Phillips Flat Head Tapping Screws 24 Items • 1550 Pcs IBS No. 166R



Packaged in a Locking Steel Drawer for Easy Storage & Organization

### Serrated HWH Tek/Drill Point Screws 16 Items • 900 Pcs IBS No. 173R



Packaged in a Locking Steel Drawer for Easy Storage & Organization



# IBS, INCORPORATED

## Assortments - Tapping Screws & Driver Bits (E)



IBS, Inc. SPECIALTY PRODUCTS FOR MAINTENANCE & REPAIR INDUSTRIALBOLT.COM • 800-678-1506		Stainless Steel Phillips Pan Head TEK Screws			Assortment No. 310R
		Phillips Bit Chart	<small>PHS# 40 - FOR SCREW# 40-41 PHS# 41 - FOR SCREW# 42-43 PHS# 42 - FOR SCREW# 44-45 PHS# 43 - FOR SCREW# 46-47 PHS# 44 - FOR SCREW# 48-49 PHS# 45 - FOR SCREW# 50-51 PHS# 46 - FOR SCREW# 52-53 PHS# 47 - FOR SCREW# 54-55</small>		
12740 6 X 1/2 PHIL PAN TEK SS	12741 6 X 3/4 PHIL PAN TEK SS	12742 6 X 1 PHIL PAN TEK SS	12745 8 X 1/2 PHIL PAN TEK SS	12746 8 X 3/4 PHIL PAN TEK SS	
12747 8 X 1 PHIL PAN TEK SS	12748 8 X 1-1/2 PHIL PAN TEK SS	12750 10 X 1/2 PHIL PAN TEK SS	12751 10 X 3/4 PHIL PAN TEK SS	12752 10 X 1 PHIL PAN TEK SS	
12753 10 X 1-1/2 PHIL PAN TEK SS	12755 12 X 3/4 PHIL PAN TEK SS	12756 12 X 1 PHIL PAN TEK SS	12757 12 X 1-1/4 PHIL PAN TEK SS	12758 12 X 1-1/2 PHIL PAN TEK SS	
12760 14 X 3/4 PHIL PAN TEK SS	12761 14 X 1 PHIL PAN TEK SS	12762 14 X 1-1/4 PHIL PAN TEK SS	12763 14 X 1-1/2 PHIL PAN TEK SS	12764 14 X 2 PHIL PAN TEK SS	

PRODUCT CATEGORY: E

### Stainless Steel Phillips Pan Head TEK Screws

20 Items • 900 Pcs  
IBS No. 310R



Packaged in a Locking Steel Drawer  
for Easy Storage & Organization

IBS, Inc. SPECIALTY PRODUCTS FOR MAINTENANCE & REPAIR INDUSTRIALBOLT.COM • 800-678-1506		Stainless Steel Hex Washer Head TEK Screws			Assortment No. 311R
12770 8 X 1/2 HWH TEK SS	12771 8 X 3/4 HWH TEK SS	12772 8 X 1 HWH TEK SS	12830 8 X 1-1/2 HWH TEK SS		
Hex Size 1/4"		Hex Size 1/4"		Hex Size 1/4"	
12774 10 X 1/2 HWH TEK SS	12775 10 X 3/4 HWH TEK SS	12776 10 X 1 HWH TEK SS	12778 10 X 1-1/2 HWH TEK SS		
Hex Size 5/16"		Hex Size 5/16"		Hex Size 5/16"	
12780 12 X 3/4 HWH TEK SS	12781 12 X 1 HWH TEK SS	12783 12 X 1-1/2 HWH TEK SS	12784 12 X 2 HWH TEK SS		
Hex Size 5/16"		Hex Size 5/16"		Hex Size 5/16"	
12785 14 X 3/4 HWH TEK SS	12786 14 X 1 HWH TEK SS	12788 14 X 1-1/2 HWH TEK SS	12789 14 X 2 HWH TEK SS		
Hex Size 3/8"		Hex Size 3/8"		Hex Size 3/8"	

PRODUCT CATEGORY: E

### Stainless Steel HWH Tek Screws

16 Items • 550 Pcs  
IBS No. 311R



Packaged in a Locking Steel Drawer  
for Easy Storage & Organization

IBS, Inc. SPECIALTY PRODUCTS FOR MAINTENANCE & REPAIR INDUSTRIALBOLT.COM • 800-678-1506		Square Drive Pan Head TEK Screws			Assortment No. 312R
		Square Bit Chart	<small>SQB# 40 - FOR SCREW# 40-41 SQB# 41 - FOR SCREW# 42-43 SQB# 42 - FOR SCREW# 44-45 SQB# 43 - FOR SCREW# 46-47 SQB# 44 - FOR SCREW# 48-49 SQB# 45 - FOR SCREW# 50-51 SQB# 46 - FOR SCREW# 52-53 SQB# 47 - FOR SCREW# 54-55</small>		
		8627 8 X 1/2 SQUARE DRIVE PN TEK ZP	8629 8 X 3/4 SQUARE DRIVE PN TEK ZP		
8630 8 X 1 SQUARE DRIVE PAN TEK ZP	8631 8 X 1-1/4 SQUARE DRIVE PAN TEK	8632 8 X 1-1/2 SQUARE DRIVE PAN TEK	8633 10 X 1/2 SQUARE DRIVE PAN TEK		
8635 10 X 3/4 SQUARE DRIVE PAN TEK	8636 10 X 1 SQUARE DRIVE PAN TEK ZP	8637 10 X 1-1/4 SQUARE DRIVE PAN	8638 10 X 1-1/2 SQUARE DRIVE PAN		
8640 12 X 3/4 SQUARE DRIVE PAN TEK	8641 12 X 1 SQUARE DRIVE PAN TEK ZP	8642 12 X 1-1/4 SQUARE DRIVE PAN	8643 12 X 1-1/2 SQUARE DRIVE PAN		

PRODUCT CATEGORY: E

### Square Drive Pan Head Tek Screws

16 Items • 650 Pcs  
IBS No. 312R



Packaged in a Locking Steel Drawer  
for Easy Storage & Organization

ASSORTMENTS



# IBS, INCORPORATED

## Assortments - Tapping Screws & Driver Bits (E)

ASSORTMENTS



### Insert Driver Bits

Assortment No. 641P					
MSH1/4 1/4 MAGNETIC NUT DRIVER	MSHL5/16 5/16 MAGNETIC NUT DRIVER	250-PB3 1/4 HEX PHILLIPS BITS #3	60-T20 1/4 HEX TORX 20	250R1 1/4 HEX SQ DRIVE #1	MBHL25225 1/4 X 2-1/4 MAG. DRIVER BIT
MSH5/16 5/16 MAGNETIC NUT DRIVER	MSHL3/8 3/8 MAGNETIC NUT DRIVER	250-PB11 #1 PHIL X 1-15/16 POWER BIT	60-T25 1/4 HEX TORX 25	250R2 1/4 HEX SQ DRIVE #2	133319 #2 GRABIT BIT
MSH3/8 3/8 MAGNETIC NUT DRIVER	250-PB1 1/4 HEX PHILLIPS BITS #1	250-PB12 #2 PHIL X 1-15/16 POWER BIT	60-T30 1/4 HEX TORX 30	250R3 1/4 HEX SQ DRIVE #3	133320 #3 GRABIT BIT
MSHL1/4 1/4 MAGNETIC NUT DRIVER	250-PB2 1/4 HEX PHILLIPS BIT #2	250-PB13 #3 PHIL X 1-15/16 POWER BIT	60-T40 1/4 HEX TORX 40	SSA-5 1/4 HEX-1/4 SQ DR 2-9/16" EXT	140341 COMBO QUICK CHANGE BIT HOLDER

PRODUCT CATEGORY: E

### Insert Driver Bits 24 Items • 53 Pcs IBS No. 641P



Packaged in a Locking Steel Drawer for Easy Storage & Organization



### Hex Washer Head Tek Screws

Assortment No. 709R				
8436 8-18 X 1/2 HEX WASHER HD TEK ZP	8438 8-18 X 3/4 HEX WASHER HD TEK ZP	8439 8-18 X 1 HEX WASHER HD TEK ZP	84390 8-18 X 1-1/4 HEX WASHER HD TEK ZP	84392 8-18 X 1-1/2 HEX WASHER HD TEK ZP
Hex Size: 1/4"	Hex Size: 1/4"	Hex Size: 1/4"	Hex Size: 1/4"	Hex Size: 1/4"
8440 10-16 X 1/2 HEX WASHER HD TEK ZP	8442 10-16 X 3/4 HEX WASHER HD TEK ZP	8443 10-16 X 1 HEX WASHER HD TEK ZP	84431 10-16 X 1-1/4 HEX WASHER HD TEK ZP	8445 10-16 X 1-1/2 HEX WASHER HD TEK ZP
Hex Size: 5/16"	Hex Size: 5/16"	Hex Size: 5/16"	Hex Size: 5/16"	Hex Size: 5/16"
8449 12-14 X 3/4 HEX WASHER HD TEK ZP	8450 12-14 X 1 HEX WASHER HD TEK ZP	84501 12-14 X 1-1/4 HEX WASHER HD TEK ZP	8451 12-14 X 1-1/2 HEX WASHER HD TEK ZP	84511 12-14 X 2 HEX WASHER HD TEK ZP
Hex Size: 5/16"	Hex Size: 5/16"	Hex Size: 5/16"	Hex Size: 5/16"	Hex Size: 5/16"
8452 1/4-14 X 3/4 HEX WASHER HD TEK ZP	8453 1/4-14 X 1 HEX WASHER HD TEK ZP	84531 1/4-14 X 1-1/4 HWH TEK ZP	8454 1/4-14 X 1-1/2 HEX WASHER HD TEK ZP	8455 1/4-14 X 2 HEX WASHER HD TEK ZP
Hex Size: 3/8"	Hex Size: 3/8"	Hex Size: 3/8"	Hex Size: 3/8"	Hex Size: 3/8"

PRODUCT CATEGORY: E

### Hex Washer Head Tek Screws 20 Items • 1,075 Pcs IBS No. 709R



Packaged in a Locking Steel Drawer for Easy Storage & Organization



### Power Bits

Assortment No. 712R		
133319 #2 GRABIT BIT	250SSP63 1/4 X 3 #6-8 SLOT POWER BIT	250SSP66 1/4x6 #6-8 SLOT POWER BIT
140341 COMBO QUICK CHANGE BIT HOLDER	250SSP83 1/4 X 3 #8-10 SLOT POWER BIT	250SSP106 1/4 X 6 #10-12 SLOT POWER BIT
250-PB11 #1 PHIL X 1-15/16 POWER BIT	250-PB31 #1 PHIL X 3-1/2 POWER BIT	250-PB61 #1 X 6 PHILLIPS POWER DRIVER
250-PB12 #2 PHIL X 1-15/16 POWER BIT	250-PB32 #2 PHIL X 3-1/2 POWER BIT	250-PB62 #2 X 6 PHILLIPS POWER DRIVER
250-PB13 #3 PHIL X 1-15/16 POWER BIT	250-PB33 #3 PHIL X 3-1/2 POWER BIT	250-PB63 #3 X 6 PHILLIPS POWER DRIVER
MBHL25225 1/4 X 2-1/4 MAG. DRIVER BIT	MBHL2530 1/4 X 3 MAG DRIVER BIT HOLDER	MBHL2560 1/4 X 6 MAG DRIVER BIT HOLDER

PRODUCT CATEGORY: E

### Power Bits 17 Items • 31 Pcs IBS No. 712R



Packaged in a Locking Steel Drawer for Easy Storage & Organization

# IBS, INCORPORATED

## Assortments - Tapping Screws & Driver Bits (E)



**IBS, Inc.**  
SPECIALTY PRODUCTS FOR MAINTENANCE & REPAIR  
INDUSTRIALBOLT.COM © © © 800-679-1906

**Phillips Bit Chart**

**Phillips Pan and Oval Head Tapping Screws - Black Oxide**

Assortment 767R

A-16889 6 X 3/8 PHIL PAN HD T/S B/O	A-11917 6 X 1/2 PHIL PAN HD T/S B/O	A-11918 6 X 3/4 PHIL PAN HD T/S B/O	A-11919 6 X 1 PHIL PAN HD T/S B/O	A-10180 8 X 1/2 PHIL PAN HD T/S B/O	A-10181 8 X 3/4 PHIL PAN HD T/S B/O
A-10182 8 X 1 PHIL PAN HD T/S B/O	A-10183 8 X 1-1/4 PHIL PAN HD T/S B/O	A-12799 8 X 1-1/2 PHIL PAN HD T/S B/O	A-11921 10 X 1/2 PHIL PAN HD T/S B/O	A-11922 10 X 3/4 PHIL PAN HD T/S B/O	A-11923 10 X 1 PHIL PAN HD T/S B/O
A-11924 10 X 1-1/4 PHIL PAN HD T/S B/O	A-12800 10 X 1-1/2 PHIL PAN HD T/S B/O	A-12795 6 X 1/2 PHIL OVAL HD T/S B/O	A-12796 6 X 3/4 PHIL OVAL HD T/S B/O	A-12797 6 X 1 PHIL OVAL HD T/S B/O	A-10163 8 X 1/2 PHIL OVAL HD T/S B/O
A-10165 8 X 3/4 PHIL OVAL HD T/S B/O	A-10167 8 X 1 PHIL OVAL HD T/S B/O	A-10169 8 X 1-1/4 PHIL OVAL HD T/S B/O	A-11084 10 X 1/2 PHIL OVAL HD T/S B/O	A-11086 10 X 3/4 PHIL OVAL HD T/S B/O	A-11088 10 X 1 PHIL OVAL HD T/S B/O

### Phillips Pan & Oval Head Tapping Screws

Black Oxide  
24 Items • 1,100 Pcs  
IBS No. 767R



Packaged in a Locking Steel Drawer for Easy Storage & Organization

PRODUCT CATEGORY: E

**IBS, Inc.**  
SPECIALTY PRODUCTS FOR MAINTENANCE & REPAIR  
INDUSTRIALBOLT.COM © © © 800-679-1906

**Phillips Bit Chart**

**Phillips Pan Head & K-Lath TEK Screws**

Assortment No. 778R

8427 6-20 X 1/2 PHIL PAN HD TEK ZP	8426 6-20 X 3/4 PHIL PAN HD TEK ZP	8425 6-20 X 1 PHIL PAN HD TEK ZP	8428 8-18 X 1/2 PHIL PAN HD TEK ZP	8430 8-18 X 3/4 PHIL PAN HD TEK ZP
8431 8-18 X 1 PHIL PAN HD TEK ZP	8432 8-18 X 1-1/2 PHIL PAN HD TEK ZP	8433 10-16 X 1/2 PHIL PAN HD TEK ZP	8435 10-16 X 3/4 PHIL PAN HD TEK ZP	84351 10-16 X 1 PHIL PAN HD TEK ZP
8437 10-16 X 1-1/2 PHIL PAN HD TEK ZP	12790 8 X 1/2 PHIL K-LATH TEK ZP	12791 8 X 3/4 PHIL K-LATH TEK ZP	12792 8 X 1 PHIL K-LATH TEK ZP	12793 8 X 1-1/4 PHIL K-LATH TEK ZP
12794 8 X 1-5/8 PHIL K-LATH TEK ZP	12795 8 X 2 PHIL K-LATH TEK ZP			

### Phillips Pan Head & K-Lath Tek Screws

17 Items • 1,150 Pcs  
IBS No. 778R



Packaged in a Locking Steel Drawer for Easy Storage & Organization

PRODUCT CATEGORY: E

**IBS, Inc.**  
SPECIALTY PRODUCTS FOR MAINTENANCE & REPAIR  
INDUSTRIALBOLT.COM © © © 800-679-1906

**Phillips Bit Chart**

**Impact Torsion Phillips and Square Bits**

Assortment No. 812R

21001 #1 PHILLIPS INSERT BIT	21004 #1 X 1-15/16 PHILLIPS POWER BIT	21007 #1 X 3-1/2 PHILLIPS POWER BIT	21010 #1 X 6 PHILLIPS POWER BIT
21002 #2 PHILLIPS INSERT BIT	21005 #2 X 1-15/16 PHILLIPS POWER BIT	21008 #2 X 3-1/2 PHILLIPS POWER BIT	21011 #2 X 6 PHILLIPS POWER BIT
21003 #3 PHILLIPS INSERT BIT	21006 #3 X 1-15/16 PHILLIPS POWER BIT	21009 #3 X 3-1/2 PHILLIPS POWER BIT	21012 #3 X 6 PHILLIPS POWER BIT
21017 #1 SQUARE INSERT BIT	21020 #1 X 1-15/16 SQUARE POWER BIT	21024 #1 X 3-1/2 SQUARE POWER BIT	21027 #1 X 6 SQUARE POWER BIT
21018 #2 SQUARE INSERT BIT	21021 #2 X 1-15/16 SQUARE POWER BIT	21025 #2 X 3-1/2 SQUARE POWER BIT	21028 #2 X 6 SQUARE POWER BIT
21019 #3 SQUARE INSERT BIT	21022 #3 X 1-15/16 SQUARE POWER BIT	21026 #3 X 3-1/2 SQUARE POWER BIT	21029 #3 X 6 SQUARE POWER BIT

### Impact Phillips & Square Bits

24 Items • 38 Pcs  
IBS No. 812R



Packaged in a Locking Steel Drawer for Easy Storage & Organization

PRODUCT CATEGORY: E

ASSORTMENTS























# IBS, INCORPORATED

## Assortments - Tapping Screws & Driver Bits (E)



### Impact Torsion Torx and Bit Holders

Assortment No. 813R

21031 T15 TORX INSERT BIT 	21037 T15 X 1-15/16 TORX POWER BIT 	21042 T15 X 3-1/2 TORX POWER BIT 	21047 T15 X 6 TORX POWER BIT 
21032 T20 TORX INSERT BIT 	21038 T20 X 1-15/16 TORX POWER BIT 	21043 T20 X 3-1/2 TORX POWER BIT 	21048 T20 X 6 TORX POWER BIT 
21033 T25 TORX INSERT BIT 	21039 T25 X 1-15/16 TORX POWER BIT 	21044 T25 X 3-1/2 TORX POWER BIT 	21049 T25 X 6 TORX POWER BIT 
21034 T30 TORX INSERT BIT 	21040 T30 X 1-15/16 TORX POWER BIT 	21045 T30 X 3-1/2 TORX POWER BIT 	21050 T30 X 6 TORX POWER BIT 
21035 T40 TORX INSERT BIT 	21041 T40 X 1-15/16 TORX POWER BIT 	21046 T40 X 3-1/2 TORX POWER BIT 	21051 T40 X 6 TORX POWER BIT 
21065 READY TO USE MAGNETIC BIT AND SCREW HOLDER 	21066 COMBO QUICK CHANGE BIT HOLDER 3" 	21060 1/4 X 3 MAGNETIC DRIVER BIT HOLDER 	21061 1/4 X 6 MAGNETIC DRIVER BIT HOLDER 

PRODUCT CATEGORY: E

## Impact Torsion Torx & Bit Holders

24 Items • 31 Pcs

IBS No. 813R



Packaged in a Locking Steel Drawer  
for Easy Storage & Organization

A  
S  
S  
O  
R  
T  
M  
E  
N  
T  
S

# IBS, INCORPORATED

## Assortments - Machine Screws (G)



IBS, Inc. SPECIALTY PRODUCTS FOR MAINTENANCE & REPAIR INDUSTRIALBOLT.COM © © © 800-670-1506						Slotted Round Head Machine Screws					
						Assortment No. 105R					
5033 6-32 HEX MACHINE SCREW NUT ZP	5034 8-32 HEX MACHINE SCREW NUT ZP	5036 10-32 HEX MACHINE SCREW NUT ZP	5035 10-24 HEX MACHINE SCREW NUT ZP	9089 10-24 X 1-1/4 SLTD ROUND HD	9134 12-24 X 3/4 SLTD ROUND HD M/S						
9044 6-32 X 1/2 SLTD ROUND HD M/S	9064 8-32 X 1/2 SLTD ROUND HD M/S	9108 10-32 X 1/2 SLTD ROUND HD M/S	9084 10-24 X 1/2 SLTD ROUND HD M/S	9090 10-24 X 1-1/2 SLTD ROUND HD	9136 12-24 X 1 SLTD ROUND HD M/S ZP						
9046 6-32 X 3/4 SLTD ROUND HD M/S	9066 8-32 X 3/4 SLTD ROUND HD M/S	9110 10-32 X 3/4 SLTD ROUND HD M/S	9086 10-24 X 3/4 SLTD ROUND HD M/S	5037 12-24 HEX MACHINE SCREW NUT ZP	9137 12-24 X 1-1/4 SLTD ROUND HD						
9048 6-32 X 1 SLTD ROUND HD M/S ZP	9068 8-32 X 1 SLTD ROUND HD M/S ZP	9112 10-32 X 1 SLTD ROUND HD M/S ZP	9088 10-24 X 1 SLTD ROUND HD M/S ZP	9132 12-24 X 1/2 SLTD ROUND HD M/S	9138 12-24 X 1-1/2 SLTD ROUND HD						

PRODUCT CATEGORY: G

IBS, Inc. SPECIALTY PRODUCTS FOR MAINTENANCE & REPAIR INDUSTRIALBOLT.COM © © © 800-670-1506						Phillips Pan Head Machine Screws & Nuts					
						Assortment No. 169R					
5033 6-32 HEX MACHINE SCREW NUT ZP	5034 8-32 HEX MACHINE SCREW NUT ZP	5036 10-32 HEX MACHINE SCREW NUT ZP	5035 10-24 HEX MACHINE SCREW NUT ZP	9529 10-24 X 1-1/4 PHIL PAN HD M/S	9549 1/4-20 X 3/4 PHIL PAN HD M/S						
9509 6-32 X 1/2 PHIL PAN HD M/S ZP	9516 8-32 X 1/2 PHIL PAN HD M/S ZP	9536 10-32 X 1/2 PHIL PAN HD M/S ZP	9524 10-24 X 1/2 PHIL PAN HD M/S ZP	9530 10-24 X 1-1/2 PHIL PAN HD M/S	9551 1/4-20 X 1 PHIL PAN HD M/S ZP						
9511 6-32 X 3/4 PHIL PAN HD M/S ZP	9518 8-32 X 3/4 PHIL PAN HD M/S ZP	9538 10-32 X 3/4 PHIL PAN HD M/S ZP	9526 10-24 X 3/4 PHIL PAN HD M/S ZP	5038 1/4-20 HEX MACHINE SCREW NUT	9552 1/4-20 X 1-1/4 PHIL PAN HD						
9512 6-32 X 1 PHIL PAN HD M/S ZP	9520 8-32 X 1 PHIL PAN HD M/S ZP	9540 10-32 X 1 PHIL PAN HD M/S ZP	9528 10-24 X 1 PHIL PAN HD M/S ZP	9547 1/4-20 X 1-1/2 PHIL PAN HD M/S	9553 1/4-20 X 1-1/2 PHIL PAN HD						

PRODUCT CATEGORY: G

IBS, Inc. SPECIALTY PRODUCTS FOR MAINTENANCE & REPAIR INDUSTRIALBOLT.COM © © © 800-670-1506						Stainless Steel Phillips Pan Head Machine Screws with Hex Nuts					
						Assortment No. 194R					
11002 6-32 MACHINE SCREW NUT SS	11003 8-32 MACHINE SCREW NUT SS	11005 10-32 MACHINE SCREW NUT SS	11004 10-24 MACHINE SCREW NUT SS	12196 10-24 X 1-1/4 PHIL PAN M/S SS	12220 1/4-20 X 3/4 PHIL PAN M/S SS						
12164 6-32 X 1/2 PHIL PAN M/S SS	12178 8-32 X 1/2 PHIL PAN M/S SS	12205 10-32 X 1/2 PHIL PAN M/S SS	12191 10-24 X 1/2 PHIL PAN M/S SS	12197 10-24 X 1-1/2 PHIL PAN M/S SS	12222 1/4-20 X 1 PHIL PAN M/S SS						
12166 6-32 X 3/4 PHIL PAN M/S SS	12180 8-32 X 3/4 PHIL PAN M/S SS	12207 10-32 X 3/4 PHIL PAN M/S SS	12193 10-24 X 3/4 PHIL PAN M/S SS	11007 1/4-20 MACHINE SCREW NUT SS	12223 1/4-20 X 1-1/4 PHIL PAN M/S SS						
12168 6-32 X 1 PHIL PAN M/S SS	12182 8-32 X 1 PHIL PAN M/S SS	12209 10-32 X 1 PHIL PAN M/S SS	12195 10-24 X 1 PHIL PAN M/S SS	12218 1/4-20 X 1-1/2 PHIL PAN M/S SS	12224 1/4-20 X 1-1/2 PHIL PAN M/S SS						

PRODUCT CATEGORY: G

## Slotted Round Head Machine Screws

24 Items • 2050 Pcs  
IBS No. 105R



Packaged in a Locking Steel Drawer for Easy Storage & Organization

## Phillips Pan Head Machine Screws & Nuts

24 Items • 1,525 Pcs  
IBS No. 169R



Packaged in a Locking Steel Drawer for Easy Storage & Organization

## Stainless Steel Phillips Flat Head Machine Screws

24 Items • 1,150 Pcs  
IBS No. 194R



Packaged in a Locking Steel Drawer for Easy Storage & Organization

ASSORTMENTS



# IBS, INCORPORATED

## Assortments - Machine Screws (G)

ASSORTMENTS

IBS, Inc. SPECIALTY PRODUCTS FOR MAINTENANCE & REPAIR INDUSTRIALBODY.COM • 800-878-1996		Phillips Flat Head Machine Screws			Assortment No. 391R	
Phillips Flat Chart		PHILLIPS		PHILLIPS		
9612 6-32 X 3/8 PHIL FLAT HD M/S ZP	9622 8-32 X 3/8 PHIL FLAT HD M/S ZP	9630 10-24 X 1/2 PHIL FLAT HD M/S	9638 10-32 X 1/2 PHIL FLAT HD M/S	9647 1/4-20 X 3/4 PHIL FLAT HD M/S		
9613 6-32 X 1/2 PHIL FLAT HD M/S ZP	9623 8-32 X 1/2 PHIL FLAT HD M/S ZP	9632 10-24 X 3/4 PHIL FLAT HD M/S	9640 10-32 X 3/4 PHIL FLAT HD M/S	9649 1/4-20 X 1 PHIL FLAT HD M/S ZP		
9615 6-32 X 3/4 PHIL FLAT HD M/S ZP	9625 8-32 X 3/4 PHIL FLAT HD M/S ZP	9634 10-24 X 1 PHIL FLAT HD M/S ZP	9642 10-32 X 1 PHIL FLAT HD M/S ZP	9651 1/4-20 X 1-1/2 PHIL FLAT HD ZP		
9617 6-32 X 1 PHIL FLAT HD M/S ZP	9627 8-32 X 1 PHIL FLAT HD M/S ZP	9637 10-24 X 3/8 PHIL FLAT HD M/S	9645 1/4-20 X 1/2 PHIL FLAT HD M/S	9653 1/4-20 X 2 PHIL FLAT HD M/S ZP		

PRODUCT CATEGORY: G

**Phillips Flat Head  
Machine Screws**  
20 Items • 1675 Pcs  
IBS No. 391R



Packaged in a Locking Steel Drawer  
for Easy Storage & Organization

IBS, Inc. SPECIALTY PRODUCTS FOR MAINTENANCE & REPAIR INDUSTRIALBODY.COM • 800-878-1996		Metric Phillips Pan Head Machine Screws Flat Washers & Nuts				Assortment No. 715R	
10713 M4-.7 X 10 PHIL PAN M/S ZP	10716 M4-.7 X 16 PHIL PAN M/S ZP	10718 M4-.7 X 20 PHIL PAN M/S ZP	10721 M4-.7 X 30 PHIL PAN M/S ZP	10564 M4 FLAT WASHER ZP	10599 M4-.7 FIN HEX NUT CL8 ZP		
602 M5-.8 X 10 PHIL PAN M/S ZP	604 M5-.8 X 16 PHIL PAN M/S ZP	606 M5-.8 X 20 PHIL PAN M/S ZP	608 M5-.8 X 30 PHIL PAN M/S ZP	10565 M5 FLAT WASHER ZP	10600 M5-.8 FIN HEX NUT CL8 ZP		
10730 M6-1.0 X 10 PHIL PAN M/S ZP	10733 M6-1.0 X 16 PHIL PAN M/S ZP	10735 M6-1.0 X 20 PHIL PAN M/S ZP	10738 M6-1.0 X 30 PHIL PAN M/S ZP	10566 M6 FLAT WASHER ZP	10601 M6-1.0 FIN HEX NUT CL8 ZP		
10750 M8-1.25 X 16 PHIL PAN M/S ZP	10752 M8-1.25 X 20 PHIL PAN M/S ZP	10754 M8-1.25 X 25 PHIL PAN M/S ZP	10755 M8-1.25 X 30 PHIL PAN M/S ZP	10568 M8 FLAT WASHER ZP	10603 M8-1.25 FIN HEX HUT CL8 ZP		

PRODUCT CATEGORY: G

**Metric Phillips  
Pan Head Machine  
Screws, Flat Washers  
& Nuts**

24 Items • 1,445 Pcs  
IBS No. 715R



Packaged in a Locking Steel Drawer  
for Easy Storage & Organization

# IBS, INCORPORATED

## Assortments - Metric Fasteners (H)



<b>Metric Cap Screws &amp; Nuts Class 8.8</b>					
Assortment No. 122R					
10601 M6-1.0 FIN HEX NUT C/L8 ZP	10603 M8-1.25 FIN HEX HUT C/L8 ZP	10091 M8-1.25 X 40 HEX C/S 8.8 ZP	10605 M10-1.5 FIN HEX NUT C/L8 ZP	10116 M10-1.5 X 40 HEX C/S 8.8 ZP	10606 M12-1.75 FIN HEX NUT C/L8 ZP
10047 M6-1.0 X 30 HEX C/S 8.8 ZP	10086 M8-1.25 X 25 HEX C/S 8.8 ZP	10093 M8-1.25 X 50 HEX C/S 8.8 ZP	10111 M10-1.5 X 25 HEX C/S 8.8 ZP	10118 M10-1.5 X 50 HEX C/S 8.8 ZP	10140 M12-1.75 X 40 HEX C/S 8.8 ZP
10048 M6-1.0 X 35 HEX C/S 8.8 ZP	10089 M8-1.25 X 30 HEX C/S 8.8 ZP	10095 M8-1.25 X 60 HEX C/S 8.8 ZP	10114 M10-1.5 X 30 HEX C/S 8.8 ZP	10120 M10-1.5 X 60 HEX C/S 8.8 ZP	10142 M12-1.75 X 50 HEX C/S 8.8 ZP
10049 M6-1.0 X 40 HEX C/S 8.8 ZP	10090 M8-1.25 X 35 HEX C/S 8.8 ZP	10097 M8-1.25 X 70 HEX C/S 8.8 ZP	10115 M10-1.5 X 35 HEX C/S 8.8 ZP	10122 M10-1.5 X 70 HEX C/S 8.8 ZP	10144 M12-1.75 X 60 HEX C/S 8.8 ZP

PRODUCT CATEGORY: H

### Metric 12.9 Socket Head Capscrews

24 Items • 440 Pcs  
IBS No. 122R



Packaged in a Locking Steel Drawer for Easy Storage & Organization

<b>Metric 12.9 Socket Head Capscrews</b>					
Assortment No. 266R					
816 M4 X 12 SOCKET HD C/S ALLOY	818 M4 X 16 SOCKET HD C/S ALLOY	820 M4 X 20 SOCKET HD C/S ALLOY	821 M4 X 25 SOCKET HD C/S ALLOY	822 M5 X 12 SOCKET HD C/S ALLOY	823 M5 X 16 SOCKET HD C/S ALLOY
823A M5 X 20 SOCKET HD C/S ALLOY	824 M5 X 25 SOCKET HD C/S ALLOY	824A M6 X 12 SOCKET HD C/S ALLOY	824B M6 X 16 SOCKET HD C/S ALLOY	824C M6 X 20 SOCKET HD C/S ALLOY	824D M6 X 25 SOCKET HD C/S ALLOY
825 M6 X 30 SOCKET HD C/S ALLOY	827 M6 X 40 SOCKET HD C/S ALLOY	829 M8 X 20 SOCKET HD C/S ALLOY	829A M8 X 25 SOCKET HD C/S ALLOY	830 M8 X 30 SOCKET HD C/S ALLOY	830A M8 X 35 SOCKET HD C/S ALLOY
831 M8 X 40 SOCKET HD C/S ALLOY	835 M10 X 20 SOCKET HD C/S ALLOY	835A M10 X 25 SOCKET HD C/S ALLOY	835B M10 X 30 SOCKET HD C/S ALLOY	835C M10 X 35 SOCKET HD C/S ALLOY	835D M10 X 40 SOCKET HD C/S ALLOY

PRODUCT CATEGORY: H

### Metric 12.9 Socket Head Capscrews

24 Items • 475 Pcs  
IBS No. 266R



Packaged in a Locking Steel Drawer for Easy Storage & Organization

<b>Metric 12.9 Flat Socket Head Cap Screws</b>					
Assortment No. 267R					
84345 M4 X 12 FLAT SOCKET C/S ALLOY	84346 M4 X 16 FLAT SOCKET C/S ALLOY	84347 M4 X 20 FLAT SOCKET C/S ALLOY	84348 M4 X 25 FLAT SOCKET C/S ALLOY	84360 M5 X 12 FLAT SOCKET C/S ALLOY	84361 M5 X 16 FLAT SOCKET C/S ALLOY
84362 M5 X 20 FLAT SOCKET C/S ALLOY	84363 M5 X 25 FLAT SOCKET C/S ALLOY	84370 M6 X 12 FLAT SOCKET C/S ALLOY	84371 M6 X 16 FLAT SOCKET C/S ALLOY	84372 M6 X 20 FLAT SOCKET C/S ALLOY	84373 M6 X 25 FLAT SOCKET C/S ALLOY
84374 M6 X 30 FLAT SOCKET C/S ALLOY	84375 M6 X 40 FLAT SOCKET C/S ALLOY	84381 M8 X 20 FLAT SOCKET C/S ALLOY	84382 M8 X 25 FLAT SOCKET C/S ALLOY	84383 M8 X 30 FLAT SOCKET C/S 12.9	84384 M8 X 35 FLAT SOCKET C/S 12.9
84385 M8 X 40 FLAT SOCKET C/S ALLOY	84391 M10 X 20 FLAT SOCKET C/S ALLOY	84393 M10 X 25 FLAT SOCKET C/S ALLOY	84394 M10 X 30 FLAT SOCKET C/S ALLOY	84395 M10 X 35 FLAT SOCKET C/S ALLOY	84396 M10 X 40 FLAT SOCKET C/S 12.9

PRODUCT CATEGORY: H

### Metric 12.9 Flat Socket Head Capscrews

24 Items • 435 Pcs  
IBS No. 267R



Packaged in a Locking Steel Drawer for Easy Storage & Organization

ASSORTMENTS



# IBS, INCORPORATED

## Assortments - Metric Fasteners (H)

ASSORTMENTS

IBS, Inc. SPECIALTY PRODUCTS FOR MAINTENANCE & REPAIR INDUSTRIALBOLT.COM © © © 300-670-1506						Stainless Steel Metric Socket Set Screws					
						Assortment No. 405R					
96900 M4 X 6 SOC SET SCREW SS  Hex Key: 2mm	96905 M5 X 6 SOC SET SCREW SS  Hex Key: 2.5mm	96910 M6 X 8 SOC SET SCREW SS  Hex Key: 3mm	96915 M8 X 10 SOC SET SCREW SS  Hex Key: 4mm	96920 M10 X 12 SOC SET SCREW SS  Hex Key: 5mm	96925 M12 X 16 SOC SET SCREW SS  Hex Key: 6mm						
96901 M4 X 8 SOC SET SCREW SS  Hex Key: 2mm	96906 M5 X 8 SOC SET SCREW SS  Hex Key: 2.5mm	96911 M6 X 10 SOC SET SCREW SS  Hex Key: 3mm	96916 M8 X 12 SOC SET SCREW SS  Hex Key: 4mm	96921 M10 X 16 SOC SET SCREW SS  Hex Key: 5mm	96926 M12 X 20 SOC SET SCREW SS  Hex Key: 6mm						
96902 M4 X 10 SOC SET SCREW SS  Hex Key: 2mm	96907 M5 X 10 SOC SET SCREW SS  Hex Key: 2.5mm	96912 M6 X 12 SOC SET SCREW SS  Hex Key: 3mm	96917 M8 X 16 SOC SET SCREW SS  Hex Key: 4mm	96922 M10 X 20 SOC SET SCREW SS  Hex Key: 5mm	96927 M12 X 25 SOC SET SCREW SS  Hex Key: 6mm						
96903 M4 X 12 SOC SET SCREW SS  Hex Key: 2mm	96908 M5 X 12 SOC SET SCREW SS  Hex Key: 2.5mm	96913 M6 X 16 SOC SET SCREW SS  Hex Key: 3mm	96918 M8 X 20 SOC SET SCREW SS  Hex Key: 4mm	96923 M10 X 25 SOC SET SCREW SS  Hex Key: 5mm	96928 M12 X 30 SOC SET SCREW SS  Hex Key: 6mm						

PRODUCT CATEGORY: H

IBS, Inc. SPECIALTY PRODUCTS FOR MAINTENANCE & REPAIR INDUSTRIALBOLT.COM © © © 300-670-1506						Metric JIS Flange Bolts					
						Assortment No. 779R					
10850 M6-1.0 X 12 JIS FLANGE BOLT ZP 10.9 	10851 M6-1.0 X 16 JIS FLANGE BOLT ZP 10.9 	10852 M6-1.0 X 20 JIS FLANGE BOLT ZP 10.9 	10856 M6-1.0 X 25 JIS FLANGE BOLT ZP 10.9 	10853 M6-1.0 X 30 JIS FLANGE BOLT ZP 10.9 	10854 M6-1.0 X 35 JIS FLANGE BOLT ZP 10.9 						
10855 M8-1.0 X 40 JIS FLANGE BOLT ZP 10.9 	10860 M8-1.25 X 12 JIS FLANGE BOLT ZP 10.9 	10861 M8-1.25 X 16 JIS FLANGE BOLT ZP 10.9 	10862 M8-1.25 X 20 JIS FLANGE BOLT ZP 10.9 	10863 M8-1.25 X 25 JIS FLANGE BOLT ZP 10.9 	10864 M8-1.25 X 30 JIS FLANGE BOLT ZP 10.9 						
10865 M8-1.25 X 35 JIS FLANGE BOLT ZP 10.9 	10866 M8-1.25 X 40 JIS FLANGE BOLT ZP 10.9 	10870 M10-1.25 X 16 JIS FLANGE BOLT ZP 10.9 	10871 M10-1.25 X 20 JIS FLANGE BOLT ZP 10.9 	10872 M10-1.25 X 25 JIS FLANGE BOLT ZP 10.9 	10873 M10-1.25 X 30 JIS FLANGE BOLT ZP 10.9 						
10874 M10-1.25 X 35 JIS FLANGE BOLT ZP 10.9 	10875 M10-1.25 X 40 JIS FLANGE BOLT ZP 10.9 	10877 M10-1.25 X 50 JIS FLANGE BOLT ZP 10.9 	10845 M6-1.0 JIS SERR FLANGE NUT ZP 	10843 M8-1.25 JIS SERR FLANGE NUT ZP 	10844 M10-1.25 JIS SERR FLANGE NUT ZP 						

PRODUCT CATEGORY: H

IBS, Inc. SPECIALTY PRODUCTS FOR MAINTENANCE & REPAIR INDUSTRIALBOLT.COM © © © 300-670-1506						Metric 10.9 Hex Flange Bolts - Zinc Plated					
						Assortment No. 810R					
30800 M6-1.0 HEX FLANGE NUT CL10 ZP 	30402 M6-1.0 X 16 HEX FLANGE BOLT 10.9 ZP 	30403 M6-1.0 X 20 HEX FLANGE BOLT 10.9 ZP 	30404 M6-1.0 X 25 HEX FLANGE BOLT 10.9 ZP 	30405 M6-1.0 X 30 HEX FLANGE BOLT 10.9 ZP 							
30801 M8-1.25 HEX FLANGE NUT CL10 ZP 	30510 M8-1.25 X 16 HEX FLANGE BOLT 10.9 ZP 	30511 M8-1.25 X 20 HEX FLANGE BOLT 10.9 ZP 	30512 M8-1.25 X 25 HEX FLANGE BOLT 10.9 ZP 	30513 M8-1.25 X 30 HEX FLANGE BOLT 10.9 ZP 							
30802 M10-1.5 HEX FLANGE NUT CL10 ZP 	30620 M10-1.5 X 20 HEX FLANGE BOLT 10.9 ZP 	30621 M10-1.5 X 25 HEX FLANGE BOLT 10.9 ZP 	30622 M10-1.5 X 30 HEX FLANGE BOLT 10.9 ZP 	30624 M10-1.5 X 40 HEX FLANGE BOLT 10.9 ZP 							
30803 M12-1.75 HEX FLANGE NUT CL10 ZP 	30730 M12-1.75 X 25 HEX FLANGE BOLT 10.9 ZP 	30731 M12-1.75 X 30 HEX FLANGE BOLT 10.9 ZP 	30733 M12-1.75 X 40 HEX FLANGE BOLT 10.9 ZP 	30735 M12-1.75 X 50 HEX FLANGE BOLT 10.9 ZP 							

PRODUCT CATEGORY: H

## Stainless Steel Metric Socket Set Screws

24 Items • 206 Pcs  
IBS No. 405R



Packaged in a Locking Steel Drawer for Easy Storage & Organization

## Metric JIS Flange Bolts

24 Items • 595 Pcs  
IBS No. 779R



Packaged in a Locking Steel Drawer for Easy Storage & Organization

## Metric 10.9 Hex Flange Bolts Zinc Plated

20 Items • 515 Pcs  
IBS No. 810R



Packaged in a Locking Steel Drawer for Easy Storage & Organization





IBS, Inc. SPECIALTY PRODUCTS FOR MAINTENANCE & REPAIR INDUSTRIALBOLT.COM © © © 800-678-1506		Stainless Steel Phillips Oval Head Tapping Screws				Assortment No. 171R
Phillips Bit Chart		PHIL PAN - PAN SCREWS #1-1/2 PHIL PAN - PAN SCREWS #1-1/4 PHIL PAN - PAN SCREWS #1 PHIL PAN - PAN SCREWS #3/4 PHIL PAN - PAN SCREWS #1/2				
This bit chart will help you match the correct size to the specific Phillips pan.		This bit chart will help you match the correct size to the specific Phillips pan.				
12649 6 X 1/2 PHIL OVAL T/S SS	12653 6 X 1-1/4 PHIL OVAL T/S SS	12661 8 X 1 PHIL OVAL T/S SS	12669 10 X 3/4 PHIL OVAL T/S SS	12679 12 X 3/4 PHIL OVAL T/S SS	12689 14 X 3/4 PHIL OVAL T/S SS	
12650 6 X 5/8 PHIL OVAL T/S SS	12658 8 X 1/2 PHIL OVAL T/S SS	12662 8 X 1-1/4 PHIL OVAL T/S SS	12670 10 X 1 PHIL OVAL T/S SS	12680 12 X 1 PHIL OVAL T/S SS	12690 14 X 1 PHIL OVAL T/S SS	
12651 6 X 3/4 PHIL OVAL T/S SS	12659 8 X 5/8 PHIL OVAL T/S SS	12667 10 X 1/2 PHIL OVAL T/S SS	12671 10 X 1-1/4 PHIL OVAL T/S SS	12681 12 X 1-1/4 PHIL OVAL T/S SS	12691 14 X 1-1/4 PHIL OVAL T/S SS	
12652 6 X 1 PHIL OVAL T/S SS	12660 8 X 3/4 PHIL OVAL T/S SS	12668 10 X 5/8 PHIL OVAL T/S SS	12672 10 X 1-1/2 PHIL OVAL T/S SS	12682 12 X 1-1/2 PHIL OVAL T/S SS	12692 14 X 1-1/2 PHIL OVAL T/S SS	

PRODUCT CATEGORY: I

### Stainless Steel Phillips Oval Head Tapping Screws

24 Items • 1,050 Pcs  
IBS No. 171R



Packaged in a Locking Steel Drawer  
for Easy Storage & Organization

IBS, Inc. SPECIALTY PRODUCTS FOR MAINTENANCE & REPAIR INDUSTRIALBOLT.COM © © © 800-678-1506		Stainless Steel Phillips Pan Head Sheet Metal Screws				Assortment No. 195R
Phillips Bit Chart		PHIL PAN - PAN SCREWS #1-1/2 PHIL PAN - PAN SCREWS #1-1/4 PHIL PAN - PAN SCREWS #1 PHIL PAN - PAN SCREWS #3/4 PHIL PAN - PAN SCREWS #1/2				
This bit chart will help you match the correct size to the specific Phillips pan.		This bit chart will help you match the correct size to the specific Phillips pan.				
12528 6 X 3/8 PHIL PAN T/S SS	12532 6 X 1 PHIL PAN T/S SS	12541 8 X 1 PHIL PAN T/S SS	12550 10 X 1 PHIL PAN T/S SS	12560 12 X 1 PHIL PAN T/S SS	12569 14 X 3/4 PHIL PAN T/S SS	
12529 6 X 1/2 PHIL PAN T/S SS	12538 8 X 1/2 PHIL PAN T/S SS	12547 10 X 1/2 PHIL PAN T/S SS	12552 10 X 1-1/2 PHIL PAN T/S SS	12561 12 X 1-1/4 PHIL PAN T/S SS	12570 14 X 1 PHIL PAN T/S SS	
12530 6 X 5/8 PHIL PAN T/S SS	12539 8 X 5/8 PHIL PAN T/S SS	12548 10 X 5/8 PHIL PAN T/S SS	12557 12 X 1/2 PHIL PAN T/S SS	12562 12 X 1-1/2 PHIL PAN T/S SS	12571 14 X 1-1/4 PHIL PAN T/S SS	
12531 6 X 3/4 PHIL PAN T/S SS	12540 8 X 3/4 PHIL PAN T/S SS	12549 10 X 3/4 PHIL PAN T/S SS	12559 12 X 3/4 PHIL PAN T/S SS	12568 14 X 5/8 PHIL PAN T/S SS	12572 14 X 1-1/2 PHIL PAN T/S SS	

PRODUCT CATEGORY: I

### Stainless Steel Phillips Pan Head Sheet Metal Screws

24 Items • 1,200 Pcs  
IBS No. 195R



Packaged in a Locking Steel Drawer  
for Easy Storage & Organization

IBS, Inc. SPECIALTY PRODUCTS FOR MAINTENANCE & REPAIR INDUSTRIALBOLT.COM © © © 800-678-1506		Stainless Steel Square Drive Pan Head TEK Screws				Assortment No. 313R
Square Bit Chart		PHIL PAN - PAN SCREWS #1-1/2 PHIL PAN - PAN SCREWS #1-1/4 PHIL PAN - PAN SCREWS #1 PHIL PAN - PAN SCREWS #3/4 PHIL PAN - PAN SCREWS #1/2				
This bit chart will help you match the correct size to the specific Square pan.		This bit chart will help you match the correct size to the specific Square pan.				
12801 6 X 1/2 SQUARE DR PAN TEK	12802 6 X 3/4 SQUARE DR PAN TEK	12803 6 X 1 SQUARE DR PAN TEK SCREW	12805 8 X 1/2 SQUARE DR PAN TEK	12807 8 X 3/4 SQUARE DR PAN TEK		
12808 8 X 1 SQUARE DR PAN TEK SCREW	12810 8 X 1-1/2 SQUARE DR PAN TEK	12811 10 X 1/2 SQUARE DR PAN TEK	12813 10 X 3/4 SQUARE DR PAN TEK	12814 10 X 1 SQUARE DR PAN TEK		
12816 10 X 1-1/2 SQUARE DR PAN TEK	12817 10 X 2 SQUARE DR PAN TEK	12818 12 X 3/4 SQUARE DR PAN TEK	12819 12 X 1 SQUARE DR PAN TEK	12821 12 X 1-1/2 SQUARE DR PAN TEK		
12822 12 X 2 SQUARE DR PAN TEK	12823 14 X 3/4 SQUARE DR PAN TEK	12824 14 X 1 SQUARE DR PAN TEK	12826 14 X 1-1/2 SQUARE DR PAN TEK	12827 14 X 2 SQUARE DR PAN TEK		

PRODUCT CATEGORY: I

### Stainless Steel Square Drive Pan Head Tek Screws

20 Items • 590 Pcs  
IBS No. 313R



Packaged in a Locking Steel Drawer  
for Easy Storage & Organization

ASSORTMENTS



# IBS, INCORPORATED

## Assortments - Stainless Steel Fasteners (I)

ASSORTMENTS

IBS, Inc. SPECIALTY PRODUCTS FOR MAINTENANCE & REPAIR INDUSTRIALBOLTY.COM 8 8 8 800-678-1506		Stainless Steel Button Socket Security Machine Screws			
Assortment No. 388R					
12850 6-32 X 1/2 SEC BS C/S SS 1/8 DRIVE 	12851 6-32 X 3/4 SEC BS C/S SS 1/8 DRIVE 	12852 6-32 X 1 SEC BS C/S SS 1/8 DRIVE 	12853 8-32 X 1/2 SEC BS C/S SS 5/32 DRIVE 	12854 8-32 X 3/4 SEC BS C/S SS 5/32 DRIVE 	
12855 8-32 X 1 SEC BS C/S SS 5/32 DRIVE 	12857 10-24 X 3/4 SEC BS C/S SS 5/32 DRIVE 	12859 10-24 X 3/4 SEC BS C/S SS 5/32 DRIVE 	12860 10-24 X 1 SEC BS C/S SS 5/32 DRIVE 	12863 10-32 X 1/2 SEC BS C/S SS 5/32 DRIVE 	
12865 10-32 X 3/4 SEC BS C/S SS 5/32 DRIVE 	12866 10-32 X 1 SEC BS C/S SS 5/32 DRIVE 	12871 1/4-20 X 3/4 SEC BS C/S SS 5/32 DRIVE 	12872 1/4-20 X 1 SEC BS C/S SS 5/32 DRIVE 	12874 1/4-20 X 1-1/2 SEC BS C/S SS 5/32 DRIVE 	
12890 10-24 SECURITY BREAKAWAY NUT 	12881 1/4-20 SECURITY BREAKAWAY NUT 		12945 1/8 HEX W/PIN 1/4 HEX DRIVER 	12946 5/32 HEX W/PIN 1/4 HEX DRIVER 	

PRODUCT CATEGORY: I

### Stainless Steel Button Socket Security Machine Screws

19 Items • 232 Pcs  
IBS No. 388R



Packaged in a Locking Steel Drawer for Easy Storage & Organization

IBS, Inc. SPECIALTY PRODUCTS FOR MAINTENANCE & REPAIR INDUSTRIALBOLTY.COM 8 8 8 800-678-1506		Stainless Steel Button Socket Security Tapping Screws			
Assortment No. 389R					
12900 6 X 3/8 SEC BS C/S SS 1/8 DRIVE 	12901 6 X 1/2 SEC BS C/S SS 1/8 DRIVE 	12902 6 X 3/4 SEC BS C/S SS 1/8 DRIVE 	12903 6 X 1 SEC BS C/S SS 1/8 DRIVE 	12904 8 X 3/8 SEC BS C/S SS 5/32 DRIVE 	
12905 8 X 1/2 SEC BS C/S SS 5/32 DRIVE 	12906 8 X 3/4 SEC BS C/S SS 5/32 DRIVE 	12907 8 X 1 SEC BS C/S SS 5/32 DRIVE 	12908 8 X 1-1/4 SEC BS C/S SS 5/32 DRIVE 	12909 8 X 1-1/2 SEC BS C/S SS 5/32 DRIVE 	
12910 10 X 1/2 SEC BS C/S SS 5/32 DRIVE 	12911 10 X 3/4 SEC BS C/S SS 5/32 DRIVE 	12912 10 X 1 SEC BS C/S SS 5/32 DRIVE 	12913 10 X 1-1/4 SEC BS C/S SS 5/32 DRIVE 	12914 10 X 1-1/2 SEC BS C/S SS 5/32 DRIVE 	
12915 10 X 2 SEC BS C/S SS 5/32 DRIVE 			12945 1/8 HEX W/PIN 1/4 HEX DRIVER 	12946 5/32 HEX W/PIN 1/4 HEX DRIVER 	

PRODUCT CATEGORY: I

### Stainless Steel Button Socket Security Tapping Screws

18 Items • 162 Pcs  
IBS No. 389R



Packaged in a Locking Steel Drawer for Easy Storage & Organization

IBS, Inc. SPECIALTY PRODUCTS FOR MAINTENANCE & REPAIR INDUSTRIALBOLTY.COM 8 8 8 800-678-1506		Stainless Steel Socket Head Cap Screws			
Assortment No. 836R					
11501 6-32 X 1/2 SOCKET HD C/S SS 	11503 6-32 X 1 SOCKET HD C/S SS 	11504 8-32 X 1/2 SOCKET HD C/S SS 	11505 8-32 X 3/4 SOCKET HD C/S SS 	11506 8-32 X 1 SOCKET HD C/S SS 	11512 10-24 X 1/2 SOCKET HD C/S SS 
11513 10-24 X 3/4 SOCKET HD C/S SS 	11514 10-24 X 1 SOCKET HD C/S SS 	11520 10-32 X 1/2 SOCKET HD C/S SS 	11521 10-32 X 3/4 SOCKET HD C/S SS 	11522 10-32 X 1 SOCKET HD C/S SS 	11526 1/4-20 X 1/2 SOCKET HD C/S SS 
11528 1/4-20 X 3/4 SOCKET HD C/S SS 	11530 1/4-20 X 1 SOCKET HD C/S SS 	11532 1/4-20 X 1-1/2 SOCKET HD C/S SS 	11534 1/4-20 X 2 SOCKET HD C/S SS 	11539 5/16-18 X 3/4 SOCKET HD C/S SS 	11541 5/16-18 X 1 SOCKET HD C/S SS 
11544 5/16-18 X 1-1/2 SOCKET HD C/S SS 	11552 3/8-16 X 1 SOCKET HD C/S SS 	11553 3/8-16 X 1-1/2 SOCKET HD C/S SS 	11556 3/8-16 X 2 SOCKET HD C/S SS 		

PRODUCT CATEGORY: I

### Stainless Steel Socket Head Capscrews

24 Items • 850 Pcs  
IBS No. 836R



Packaged in a Locking Steel Drawer for Easy Storage & Organization



IBS, Inc. SPECIALTY PRODUCTS FOR MAINTENANCE & REPAIR INDUSTRIALBOLTY.COM © © © 800-679-1906		Button Socket Head Screw Size		Hex Size		Stainless Steel Button Socket Cap Screws	
Assortment No. 837R							
11902 6-32 X 1/2 BUTTON SOCKET C/S SS	11903 6-32X 3/4 BUTTON SOCKET C/S SS	11904 8-32 X 1 BUTTON SOCKET C/S SS	11907 8-32 X 1/2 BUTTON SOCKET C/S SS	11908 8-32 X 3/4 BUTTON SOCKET C/S SS	11909 8-32 X 1 BUTTON SOCKET C/S SS		
11912 10-24 X 1/2 BUTTON SOCKET C/S SS	11913 10-24 X 3/4 BUTTON SOCKET C/S SS	11914 10-24 X 1 BUTTON SOCKET C/S SS	11916 10-32 X 1/2 BUTTON SOCKET C/S SS	11917 10-32 X 3/4 BUTTON SOCKET C/S SS	11918 10-32 X 1 BUTTON SOCKET C/S SS		
11920 1/4-20 X 1/2 BUTTON SOCKET C/S SS	11921 1/4-20 X 3/4 BUTTON SOCKET C/S SS	11922 1/4-20 X 1 BUTTON SOCKET C/S SS	11924 1/4-20 X 1-1/2 BUTTON SOCKET C/S SS	11926 5/16-18 X 3/4 BUTTON SOCKET C/S SS	11927 5/16-18 X 1 BUTTON SOCKET C/S SS		
11928 5/16-18 X 1-1/4 BUTTON SOCKET C/S SS	11929 5/16-18 X 1-1/2 BUTTON SOCKET C/S SS	11931 3/8-16 X 3/4 BUTTON SOCKET C/S SS	11932 3/8-16 X 1 BUTTON SOCKET C/S SS	11933 3/8-16 X 1-1/4 BUTTON SOCKET C/S SS	11934 3/8-16 X 1-1/2 BUTTON SOCKET C/S SS		

PRODUCT CATEGORY: I

IBS, Inc. SPECIALTY PRODUCTS FOR MAINTENANCE & REPAIR INDUSTRIALBOLTY.COM © © © 800-679-1906		Flat Socket Screw Size		Hex Size		Stainless Steel Flat Socket Cap Screws	
Assortment No. 838R							
11952 6-32 X 1/2 FLAT SOCKET C/S SS	11953 6-32X 3/4 FLAT SOCKET C/S SS	11954 6-32 X 1 FLAT SOCKET C/S SS	11957 8-32 X 1/2 FLAT SOCKET C/S SS	11958 8-32 X 3/4 FLAT SOCKET C/S SS	11959 8-32 X 1 FLAT SOCKET C/S SS		
11962 10-24 X 1/2 FLAT SOCKET C/S SS	11963 10-24 X 3/4 FLAT SOCKET C/S SS	11964 10-24 X 1 FLAT SOCKET C/S SS	11966 10-32 X 1/2 FLAT SOCKET C/S SS	11967 10-32 X 3/4 FLAT SOCKET C/S SS	11968 10-32 X 1 FLAT SOCKET C/S SS		
11970 1/4-20 X 1/2 FLAT SOCKET C/S SS	11971 1/4-20 X 3/4 FLAT SOCKET C/S SS	11972 1/4-20 X 1 FLAT SOCKET C/S SS	11974 1/4-20 X 1-1/2 FLAT SOCKET C/S SS	11976 5/16-18 X 3/4 FLAT SOCKET C/S SS	11977 5/16-18 X 1 FLAT SOCKET C/S SS		
11978 5/16-18 X 1-1/4 FLAT SOCKET C/S SS	11979 5/16-18 X 1-1/2 FLAT SOCKET C/S SS	11981 3/8-16 X 3/4 FLAT SOCKET C/S SS	11982 3/8-16 X 1 FLAT SOCKET C/S SS	11983 3/8-16 X 1-1/4 FLAT SOCKET C/S SS	11984 3/8-16 X 1-1/2 FLAT SOCKET C/S SS		

PRODUCT CATEGORY: I

IBS, Inc. SPECIALTY PRODUCTS FOR MAINTENANCE & REPAIR INDUSTRIALBOLTY.COM © © © 800-679-1906		Fender Washers Stainless Steel	
Assortment No. 850R			
12074 10 X 1 FENDER WASHER SS	12075 1/4 X 1 FENDER WASHER SS	12076 1/4 X 1-1/4 FENDER WASHER SS	
12077 1/4 X 1-1/2 FENDER WASHER SS	12078 1/4 X 2 FENDER WASHER SS	12079 5/16 X 1 FENDER WASHER SS	
12080 5/16 X 1-1/2 FENDER WASHER SS	12081 5/16 X 2 FENDER WASHER SS	12082 3/8 X 1-1/2 FENDER WASHER SS	
12083 3/8 X 2 FENDER WASHER SS	12084 1/2 X 2 FENDER WASHER SS		

PRODUCT CATEGORY: I

### Stainless Steel Button Socket Head Capcrews 24 Items • 1060 Pcs IBS No. 837R



Packaged in a Locking Steel Drawer  
for Easy Storage & Organization

### Stainless Steel Flat Socket Head Capscrews 24 Items • 1080 Pcs IBS No. 838R



Packaged in a Locking Steel Drawer  
for Easy Storage & Organization

### Stainless Steel Fender Washers 11 Items • 345 Pcs IBS No. 850R



Packaged in a Locking Steel Drawer  
for Easy Storage & Organization

ASSORTMENTS



# IBS, INCORPORATED

## Assortments - Stainless Steel Fasteners (I)

ASSORTMENTS

IBS, Inc. SPECIALTY PRODUCTS FOR MAINTENANCE & REPAIR INDUSTRIALBOLTY.COM 8 8 8 800-878-1906						Cotter Pins
						Assortment No. 125R
3469 1/16 X 1 COTTER PIN ZP	13471 1/16 X 1-1/2 COTTER PIN ZP	13473 1/16 X 2 COTTER PIN ZP	13481 3/32 X 1 COTTER PIN ZP	13483 3/32 X 1-1/2 COTTER PIN ZP	13577 1/4 X 3 COTTER PIN ZP	
3485 3/32 X 2 COTTER PIN ZP	13532 5/32 X 1 COTTER PIN ZP	13534 5/32 X 1-1/2 COTTER PIN ZP	13505 1/8 X 1 COTTER PIN ZP	13507 1/8 X 1-1/2 COTTER PIN ZP	13512 1/8 X 3 COTTER PIN ZP	
3509 7/8 X 2 COTTER PIN ZP	13536 5/32 X 2 COTTER PIN ZP	13539 5/32 X 3 COTTER PIN ZP	13588 3/16 X 1 COTTER PIN ZP	13560 3/16 X 1-1/2 COTTER PIN ZP	13565 3/16 X 3 COTTER PIN ZP	
3562 1/16 X 2 COTTER PIN ZP	13572 1/4 X 1-1/2 COTTER PIN ZP	13574 1/4 X 2 COTTER PIN ZP	13602 5/16 X 2 COTTER PIN ZP	13616 3/8 X 2 COTTER PIN ZP	13618 3/8 X 2-1/2 COTTER PIN ZP	

PRODUCT CATEGORY: K

**Cotter Pins**  
24 Items • 1,545 Pcs  
IBS No. 125R



Packaged in a Locking Steel Drawer  
for Easy Storage & Organization

IBS, Inc. SPECIALTY PRODUCTS FOR MAINTENANCE & REPAIR INDUSTRIALBOLTY.COM 8 8 8 800-878-1906						Clevis Pins
						Assortment No. 132R
13831 3/16 X 3/4 CLEVIS PIN	13832 3/16 X 1 CLEVIS PIN	13837 3/16 X 1-1/2 CLEVIS PIN	13843 1/4 X 1 CLEVIS PIN	13848 1/4 X 1-1/2 CLEVIS PIN	13911 1/4 X 2 UNIVERSAL CLEVIS PIN	
13851 5/16 X 1 CLEVIS PIN	13856 5/16 X 1-1/2 CLEVIS PIN	13859 5/16 X 2 CLEVIS PIN	13867 3/8 X 1-1/2 CLEVIS PIN	13870 3/8 X 2 CLEVIS PIN	13915 5/16 X 2 UNIV CLEVIS PIN	
13873 3/8 X 2-1/2 CLEVIS PIN	13881 7/16 X 1-1/2 CLEVIS PIN	13884 7/16 X 2 CLEVIS PIN	13892 1/2 X 1-1/2 CLEVIS PIN	13895 1/2 X 2 CLEVIS PIN	13918 3/8 X 2 UNIVERSAL CLEVIS PIN	
13898 1/2 X 2-1/2 CLEVIS PIN	13902 5/8 X 1-1/2 CLEVIS PIN	13904 5/8 X 2 CLEVIS PIN	13922 7/16 X 2-1/2 UNIV CLEVIS PIN	13928 1/2 X 3 UNIV CLEVIS PIN	13932 5/8 X 3 UNIV CLEVIS PIN	

PRODUCT CATEGORY: K

**Clevis Pins**  
24 Items • 129 Pcs  
IBS No. 132R



Packaged in a Locking Steel Drawer  
for Easy Storage & Organization

# IBS, INCORPORATED

## Assortments - Rings & Pins (K)



<b>Female Rod Ends, Yoke Ends, Clevis Pins, Cotter Pins &amp; Jam Nuts</b>			
Assortment No. 142R			
<b>A-12034</b> 10-32 RH F. BALL JOINT W/STUD 	<b>A-10737</b> 1/4-28 DROP FORGED-ADJ YOKE END 	<b>13843</b> 1/4 X 1 CLEVIS PIN 	<b>13480</b> 3/32 X 3/4 COTTER PIN ZP  <b>9036</b> 10-32 HEX MACHINE SCREW NUT ZP 
<b>A-12035</b> 1/4-28 RH F. BALL JOINT W/STUD 	<b>A-10738</b> 5/16-24 DROP FORG-ADJ YOKE END 	<b>13854</b> 5/16 X 1-1/4 CLEVIS PIN 	<b>13805</b> 1/8 X 1 COTTER PIN ZP  <b>6085</b> 1/4-28 HEX JAM NUT NF ZP 
<b>A-12036</b> 5/16-24 RH F. BALL JOINT 	<b>A-10739</b> 3/8-24 DROP FORGED ADJ YOKE END 	<b>13865</b> 3/8 X 1-1/4 CLEVIS PIN 	<b>13532</b> 5/32 X 1 COTTER PIN ZP  <b>6086</b> 5/16-24 HEX JAM NUT NF ZP 
<b>A-12037</b> 3/8-24 RH F. BALL JOINT W/STUD 	<b>A-10741</b> 1/2-20 DROP FORGED ADJ YOKE END 	<b>13891</b> 1/2 X 1-3/8 CLEVIS PIN 	<b>13532</b> 5/32 X 1 COTTER PIN ZP  <b>6087</b> 3/8-24 HEX JAM NUT NF ZP 

PRODUCT CATEGORY: K

## Female Rod Ends, Yoke Ends, Clevis Pins, Cotter Pins & Jam Nuts

20 Items • 247 Pcs  
IBS No. 142R



Packaged in a Locking Steel Drawer for Easy Storage & Organization

<b>Woodruff Keys</b>					
Assortment No. 148R					
<b>13951</b> #2 3/32 X 1/2 WOODRUFF KEY 	<b>13957</b> #7 1/8 X 3/4 WOODRUFF KEY 	<b>13956</b> #61 3/16 X 5/8 WOODRUFF KEY 	<b>13971</b> #16 3/16 X 1-1/8 WOODRUFF KEY 	<b>13968</b> #15 1/4 X 1 WOODRUFF KEY 	<b>13974</b> #C 5/16 X 1-1/8 WOODRUFF KEY 
<b>13953</b> #4 3/32 X 5/8 WOODRUFF KEY 	<b>13955</b> #6 5/32 X 5/8 WOODRUFF KEY 	<b>13959</b> #9 3/16 X 3/4 WOODRUFF KEY 	<b>13975</b> #19 3/16 X 1-1/4 WOODRUFF KEY 	<b>13973</b> #18 1/4 X 1-1/8 WOODRUFF KEY 	<b>13983</b> #D 5/16 X 1-1/4 WOODRUFF KEY 
<b>13952</b> #3 1/8 X 1/2 WOODRUFF KEY 	<b>13958</b> #8 5/32 X 3/4 WOODRUFF KEY 	<b>13962</b> #11 3/16 X 7/8 WOODRUFF KEY 	<b>13960</b> #91 1/4 X 3/4 WOODRUFF KEY 	<b>13977</b> #21 1/4 X 1-1/4 WOODRUFF KEY 	<b>13970</b> #152 3/8 X 1 WOODRUFF KEY 
<b>13954</b> #5 1/8 X 5/8 WOODRUFF KEY 	<b>13961</b> #10 5/32 X 7/8 WOODRUFF KEY 	<b>13966</b> #13 3/16 X 1 WOODRUFF KEY 	<b>13964</b> #A 1/4 X 7/8 WOODRUFF KEY 	<b>13969</b> #B 5/16 X 1 WOODRUFF KEY 	<b>13978</b> #22 1/4 X 1-3/8 WOODRUFF KEY 

PRODUCT CATEGORY: K

## Woodruff Keys

24 Items • 185 Pcs  
IBS No. 148R

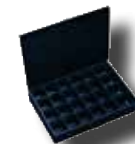

Packaged in a Locking Steel Drawer for Easy Storage & Organization

<b>Cotter Pins</b> Large Diameter Long Length	
Assortment No. 155R	
<b>13646</b> 1/2 X 6 COTTER PIN ZP 	<b>13645</b> 1/2 X 5 COTTER PIN ZP 
<b>13624</b> 3/8 X 6 COTTER PIN ZP 	<b>13643</b> 1/2 X 4 COTTER PIN ZP 
<b>13623</b> 3/8 X 5 COTTER PIN ZP 	<b>13579</b> 1/4 X 4 COTTER PIN ZP 
<b>13621</b> 3/8 X 4 COTTER PIN ZP 	<b>13581</b> 1/4 X 5 COTTER PIN ZP 
<b>13605</b> 5/16 X 3 COTTER PIN ZP 	<b>13609</b> 5/16 X 5 COTTER PIN ZP 
<b>13641</b> 1/2 X 3 COTTER PIN ZP 	<b>13604</b> 5/16 X 2-1/2 COTTER PIN ZP  <b>13607</b> 5/16 X 4 COTTER PIN ZP 

PRODUCT CATEGORY: K

## Cotter Pins

Large Diameter, Long Length

13 Items • 115 Pcs  
IBS No. 155R



Packaged in a Locking Steel Drawer for Easy Storage & Organization



# IBS, INCORPORATED

## Assortments - Rings & Pins (K)

ASSORTMENTS

<b>IBS, Inc.</b> <small>SPECIALTY PRODUCTS FOR MAINTENANCE &amp; REPAIR          INDUSTRIALBOLTY.COM • P O BOX 678-1906</small>								"E" Clips Regular & Reinforced
								Assortment No. 161R
A-8824 1/16 E-CLIP RETAINING RING	A-8825 3/32 E-CLIP RETAINING RING	A-8826 1/8 E-CLIP RETAINING RING	A-10130 9/64 E-CLIP RETAINING RING	A-10131 5/32 E-CLIP RETAINING RING	A-10132 11/64 E-CLIP RETAINING RING	A-8827 3/16 E-CLIP RETAINING RING	A-10133 7/32 E-CLIP RETAINING RING	
A-8828 1/4 E-CLIP RETAINING RING	A-8824 5/16 E-CLIP RETAINING RING	A-8829 3/8 E-CLIP RETAINING RING	A-8830 7/16 E-CLIP RETAINING RING	A-5602 1/2 E-CLIP RETAINING RING	A-5603 5/8 E-CLIP RETAINING RING	A-8831 3/4 E-CLIP RETAINING RING	A-8832 7/8 E-CLIP RETAINING RING	
A-8833 1" E-CLIP RETAINING RING						A-1615 1/8 HVY E-CLIP RETAINING RING	A-10134 5/32 HVY E-CLIP RETAINING RING	
A-3166 3/16 HVY E-CLIP RETAINING RING	A-10135 7/32 HVY E-CLIP RETAINING RING	A-3167 1/4 HVY E-CLIP RETAINING RING	A-3628 5/16 HVY E-CLIP RETAINING RING	A-5600 3/8 HVY E-CLIP RETAINING RING	A-2672 7/16 HVY E-CLIP RETAINING RING	A-8837 1/2 HVY E-CLIP RETAINING RING	A-5601 9/16 HVY E-CLIP RETAINING RING	

PRODUCT CATEGORY: K

**"E" Clips**  
Regular & Reinforced  
**27 Items • 1345 Pcs**  
**IBS No. 161R**



Packaged in a Locking Steel Drawer  
for Easy Storage & Organization

<b>IBS, Inc.</b> <small>SPECIALTY PRODUCTS FOR MAINTENANCE &amp; REPAIR          INDUSTRIALBOLTY.COM • P O BOX 678-1906</small>								Internal and External Retaining Rings
								Assortment No. 163R
A-8701 1/4 EXTERNAL SNAP RING	A-8702 1/8 EXT SNAP RING	A-8703 3/8 EXT SNAP RING	A-8704 7/16 EXT SNAP RING	A-8705 1/2 EXT SNAP RING	A-8706 9/16 EXT SNAP RING	A-8707 5/8 EXT SNAP RING	A-10120 11/16 EXT. SNAP RING	
A-8708 3/4 EXT SNAP RING	A-10121 13/16 EXT E-CLIP RETAINING RIN	A-8709 7/8 EXT SNAP RING	A-10122 15/16 EXT. SNAP RING	A-8710 1" EXTERNAL SNAP RING	A-10123 1-1/16 EXT. SNAP RING	A-8711 1-1/8 EXT SNAP RING	A-10124 1-3/16 EXT. SNAP RING	
A-8712 1-1/4 EXT SNAP RING	A-8688 1/4 INT SNAP RING	A-8689 5/16 INTERNAL SNAP RING	A-8690 3/8 INT SNAP RING	A-8691 7/16 INT SNAP RING	A-8692 1/2 INTERNAL SNAP RING	A-8693 9/16 INT SNAP RING	A-8694 5/8 INT SNAP RING	
A-8695 3/4 INT SNAP RING	A-8696 7/8 INT SNAP RING	A-8697 1 INT SNAP RING	A-8698 1-1/8 INTERNAL SNAP RING	A-8699 1-1/4 INT SNAP RING				

PRODUCT CATEGORY: K

**Internal & External  
Retaining Rings**  
**29 Items • 410 Pcs**  
**IBS No. 163R**



Packaged in a Locking Steel Drawer  
for Easy Storage & Organization

<b>IBS, Inc.</b> <small>SPECIALTY PRODUCTS FOR MAINTENANCE &amp; REPAIR          INDUSTRIALBOLTY.COM • P O BOX 678-1906</small>								Standard O-Rings
								Assortment No. 164R
15545 #006 1/16 WL 1/8 ID O-RNG	15549 #010 1/16 WL 1/4 ID O-RNG	15558 #111 3/32 WL 7/16 ID O-RNG	15562 #115 3/32 WL 11/16 ID O-RNG	15566 #212 1/8 WL 7/8 ID O-RNG	15570 #216 1/8 WL 1-1/8 ID O-RNG	15574 #220 1/8 WL 1-3/8 ID O-RNG	15606 #326 3/16 WL 1- 5/8 ID O-RNG	
15546 #007 1/16 WL 5/32 ID O-RNG	15550 #011 1/16WL 5/16ID X 7/16OD	15559 #112 3/32 WL 1/2 ID O-RNG	15563 #116 3/32 WL 3/4 ID O-RNG	15567 #213 1/8 WL 15/16 ID O-RNG	15571 #217 1/8 WL 1- 3/16 ID O-RNG	15575 #221 1/8 WL 1- 7/16 ID O-RNG	15607 #327 3/16 WL 1- 3/4 ID O-RNG	
15547 #008 1/16 WL 3/16 ID O-RNG	15551 #012 1/16 WL 3/8 ID O-RNG	15560 #113 3/32 WL 9/16 ID O-RNG	15564 #210 1/8 WL 3/4 ID O-RNG	15568 #214 1/8 WL 1 ID O-RNG	15572 #218 1/8 WL 1-1/4 ID O-RNG	15576 #222 1/8 WL 1-1/2 ID O-RNG		
15548 #009 1/16 WL 7/32 ID O-RNG	15557 #110 3/32 WL 3/8 ID O-RNG	15561 #114 3/32 WL 5/8 ID O-RNG	15565 #211 1/8 WL 13/16 ID O-RNG	15569 #215 1/8 WL 1-1/16 ID O-RNG	15573 #219 1/8 WL 1- 5/16 ID O-RNG	15605 #325 3/16 WL 1- 1/2 ID O-RNG		

PRODUCT CATEGORY: K

**Standard O-Rings**  
**30 Items • 805 Pcs**  
**IBS No. 164R**



Packaged in a Locking Steel Drawer  
for Easy Storage & Organization

# IBS, INCORPORATED

## Assortments - Rings & Pins (K)



IBS, Inc. SPECIALTY PRODUCTS FOR MAINTENANCE & REPAIR INDUSTRIALBOLT.COM © 2010 800-878-1906						Roll Pins
						Assortment No. 165R
13652 1/16 X 1/4 ROLL PIN ZP	13655 1/16 X 1/2 ROLL PIN ZP	13658 1/16 X 3/4 ROLL PIN ZP	13663 5/64 X 1/4 ROLL PIN ZP	13666 5/64 X 1/2 ROLL PIN ZP	13669 5/64 X 3/4 ROLL PIN ZP	
13679 3/32 X 3/8 ROLL PIN ZP	13683 3/32 X 3/4 ROLL PIN ZP	13685 3/32 X 1 ROLL PIN ZP	13690 1/8 X 3/8 ROLL PIN ZP	13696 1/8 X 1 ROLL PIN ZP	13698 1/8 X 1-1/4 ROLL PIN ZP	
13705 5/32 X 1/2 ROLL PIN ZP	13710 5/32 X 1 ROLL PIN ZP	13714 5/32 X 1-1/2 ROLL PIN ZP	13722 3/16 X 5/8 ROLL PIN ZP	13725 3/16 X 1 ROLL PIN ZP	13732 3/16 X 2 ROLL PIN ZP	
13738 7/32 X 3/4 ROLL PIN ZP	13744 7/32 X 1-1/2 ROLL PIN ZP	13746 7/32 X 1-3/4 ROLL PIN ZP	13753 1/4 X 1 ROLL PIN ZP	13760 1/4 X 2 ROLL PIN ZP	13764 1/4 X 3 ROLL PIN ZP	

PRODUCT CATEGORY: K

### Roll Pins

24 Items • 570 Pcs  
IBS No. 165R



Packaged in a Locking Steel Drawer for Easy Storage & Organization

IBS, Inc. SPECIALTY PRODUCTS FOR MAINTENANCE & REPAIR INDUSTRIALBOLT.COM © 2010 800-878-1906								Metric O-Rings 1.5mm to 3.0mm
								Assortment No. 184R
15700 3.0 X 1.5 METRIC O RING	15701 5.0 X 1.5 METRIC O RING	15702 7.0 X 1.5 METRIC O RING	15703 9.0 X 1.5 METRIC O RING	15704 11.0 X 1.5 METRIC O RING	15705 6.0 X 2.0 METRIC O RING	15706 8.0 X 2.0 METRIC O RING	15707 10.0 X 2.0 METRIC O RING	
15708 12.0 X 2.0 METRIC O RING	15709 14.0 X 2.0 METRIC O RING	15712 6.3 X 2.4 METRIC O RING	15713 8.3 X 2.4 METRIC O RING	15714 11.8 X 2.4 METRIC O RING	15715 13.3 X 2.4 METRIC O RING	15716 17.3 X 2.4 METRIC O RING	15717 5.0 X 2.5 METRIC O RING	
15718 7.0 X 2.5 METRIC O RING	15719 10.0 X 2.5 METRIC O RING	15720 12.0 X 2.5 METRIC O RING	15721 15.0 X 2.5 METRIC O RING	15722 10.0 X 3.0 METRIC O RING	15723 12.0 X 3.0 METRIC O RING	15724 14.0 X 3.0 METRIC O RING	15725 16.0 X 3.0 METRIC O RING	
15726 18.0 X 3.0 METRIC O RING	15727 20.2 X 3.0 METRIC O RING	15729 22.2 X 3.0 METRIC O RING	15730 24.2 X 3.0 METRIC O RING	15732 26.2 X 3.0 METRIC O RING	15734 30.2 X 3.0 METRIC O RING			

PRODUCT CATEGORY: K

### Metric O-Rings

1.5mm to 3.0mm  
30 Items • 220 Pcs  
IBS No. 184R



Packaged in a Locking Steel Drawer for Easy Storage & Organization

IBS, Inc. SPECIALTY PRODUCTS FOR MAINTENANCE & REPAIR INDUSTRIALBOLT.COM © 2010 800-878-1906						Metric O-Rings 2.0mm to 5.0mm Large Diameter
						Assortment No. 185R
15710 18.0 X 2.0 METRIC O RING	15711 20.0 X 2.0 METRIC O RING	15728 22.0 X 3.0 METRIC O RING	15731 25.0 X 3.0 METRIC O RING	15733 28.0 X 3.0 METRIC O RING	15734 30.2 X 3.0 METRIC O RING	
15735 32.2 X 3.0 METRIC O RING	15736 38.0 X 3.0 METRIC O RING	15737 25.0 X 4.0 METRIC O RING	15738 30.0 X 4.0 METRIC O RING	15739 32.0 X 4.0 METRIC O RING	15740 35.0 X 4.0 METRIC O RING	
15741 36.0 X 4.0 METRIC O RING	15742 38.0 X 4.0 METRIC O RING	15743 40.0 X 4.0 METRIC O RING	15744 44.0 X 4.0 METRIC O RING	15745 45.0 X 4.0 METRIC O RING	15746 50.0 X 4.0 METRIC O RING	
15747 25.0 X 5.0 METRIC O RING	15748 30.0 X 5.0 METRIC O RING	15749 35.0 X 5.0 METRIC O RING	15750 40.0 X 5.0 METRIC O RING	15751 45.0 X 5.0 METRIC O RING	15752 50.0 X 5.0 METRIC O RING	

PRODUCT CATEGORY: K

### Metric O-Rings

2.0mm to 5.0  
Large Diameter  
24 Items • 76 Pcs  
IBS No. 185R



Packaged in a Locking Steel Drawer for Easy Storage & Organization



# IBS, INCORPORATED

## Assortments - Rings & Pins (K)

ASSORTMENTS

IBS, Inc. SPECIALTY PRODUCTS FOR MAINTENANCE & REPAIR INDUSTRIALBOLTY.COM © © © 800-678-1906				Hitch Pin Clips			
				Assortment No. 240R			
15530 1/32 X 9-1/16 HITCH PIN 31P	15520 3/64 X 19-3/32 HITCH PIN 21P	15521 1/16 X 1-5/16 HITCH PIN 22P	15524 5/64 X 1-3/32 HITCH PIN 25P				
15512 3/32 X 1-3/16 HITCH PIN 13P	15516 3/32 X 1-9/16 HITCH PIN 17P	15506 3/32 X 2-5/16 HITCH PIN 7P	15513 3/32 X 2-1/2 HITCH PIN 14P				
15515 1/8 X 1-15/16 HITCH PIN 16P	15510 1/8 X 2-9/16 HITCH PIN 11P	15526 1/8 X 2-1/2 HITCH PIN 27P	15509 5/32 X 2-15/16 HITCH PIN 10P				
15505 3/16 X 3-1/4 HITCH PIN 6P	15507 3/16 X 3-3/4 HITCH PIN 8P	15528 3/16 X 3-1/2 HITCH PIN 29P	15518 1/4 X 4 HITCH PIN 19P				

PRODUCT CATEGORY: K

**Hitch Pin Clips**  
16 Items • 390 Pcs  
IBS No. 240R



Packaged in a Locking Steel Drawer for Easy Storage & Organization

IBS, Inc. SPECIALTY PRODUCTS FOR MAINTENANCE & REPAIR INDUSTRIALBOLTY.COM © © © 800-678-1906				Snapper & Lynch Pins			
				Assortment No. 394R			
28-01 1/4 X 1-3/4 SNAPPER PIN	63-01 3/16 X 1-9/16 LYNCH PIN	63-04 7/16 X 1-9/16 LYNCH PIN					
28-02 5/16 X 2-1/2 SNAPPER PIN	63-02 1/4 X 1-9/16 LYNCH PIN	63-05 7/16 X 1-3/4 LYNCH PIN					
28-03 3/8 X 1-3/8 SNAPPER PIN	A-11736 1/4 X 1-3/4 LYNCH PIN	63-11 7/16 X 1-9/16 LYNCH PIN					
28-04 3/8 X 2-1/4 SNAPPER PIN	63-03 5/16 X 1-9/16 LYNCH PIN						

PRODUCT CATEGORY: K

**Snapper & Lynch Pins**  
11 Items • 33 Pcs  
IBS No. 394R



Packaged in a Locking Steel Drawer for Easy Storage & Organization

IBS, Inc. SPECIALTY PRODUCTS FOR MAINTENANCE & REPAIR INDUSTRIALBOLTY.COM © © © 800-678-1906								Viton O-Rings							
								Assortment No. 735R							
30006 #006 1/16 WL 1/8 ID VITON O-RING	30010 #010 1/16 WL 1/4 ID VITON O-RING	30111 #111 3/32 WL 7/16 ID VITON O-RING	30115 #115 3/32 WL 11/16 ID VITON O-RING	30212 #212 1/8 WL 7/8 ID VITON O-RING	30216 #216 1/8 WL 1-1/8 ID VITON O-RING	30220 #220 1/8 WL 1-3/8 ID VITON O-RING	30326 #326 3/16 WL 1-5/8 ID VITON O-RING								
30007 #007 1/16 WL 5/32 ID VITON O-RING	30011 #011 1/16 WL 5/16 ID VITON O-RING	30112 #112 3/32 WL 1/2 ID VITON O-RING	30116 #116 3/32 WL 3/4 ID VITON O-RING	30213 #213 1/8 WL 15/16 ID VITON O-RING	30217 #217 1/8 WL 3/16 ID VITON O-RING	30221 #221 1/8 WL 1-7/16 ID VITON O-RING	30327 #327 3/16 WL 1-3/4 ID VITON O-RING								
30008 #008 1/16 WL 3/16 ID VITON O-RING	30012 #012 1/16 WL 3/8 ID VITON O-RING	30113 #113 3/32 WL 9/16 ID VITON O-RING	30210 #210 1/8 WL 3/4 ID VITON O-RING	30214 #214 1/8 WL 1" ID VITON O-RING	30218 #218 1/8 WL 1-1/4 ID VITON O-RING	30222 #222 1/8 WL 1-1/2 ID VITON O-RING									
30009 #009 1/16 WL 7/32 ID VITON O-RING	30110 #110 3/32 WL 3/8 ID VITON O-RING	30114 #114 3/32 WL 5/8 ID VITON O-RING	30211 #211 1/8 WL 13/16 ID VITON O-RING	30215 #215 1/8 WL 1-1/16 ID VITON O-RING	30219 #219 1/8 WL 1-5/16 ID VITON O-RING	30325 #325 3/16 WL 1-1/2 ID VITON O-RING									

PRODUCT CATEGORY: K

**Viton O-Rings**  
30 Items • 360 Pcs  
IBS No. 735R



Packaged in a Locking Steel Drawer for Easy Storage & Organization



# IBS, INCORPORATED

## Assortments - Rings & Pins (K)



<b>Stainless Steel Cotter Pins</b>					
Assortment No. 798R					
13300 1/16 X 1/2 COTTER PIN SS 	13306 1/16 X 2 COTTER PIN SS 	13313 3/32 X 2 COTTER PIN SS 	13320 1/8 X 2 COTTER PIN SS 	13325 5/32 X 1-1/2 COTTER PIN SS 	13332 3/16 X 1-1/2 COTTER PIN SS 
13301 1/16 X 3/4 COTTER PIN SS 	13308 3/32 X 3/4 COTTER PIN SS 	13315 1/8 X 3/4 COTTER PIN SS 	13321 1/8 X 2-1/2 COTTER PIN SS 	13327 5/32 X 2 COTTER PIN SS 	13334 3/16 X 2 COTTER PIN SS 
13302 1/16 X 1 COTTER PIN SS 	13309 3/32 X 1 COTTER PIN SS 	13316 1/8 X 1 COTTER PIN SS 	13322 1/8 X 3 COTTER PIN SS 	13328 5/32 X 2-1/2 COTTER PIN SS 	13335 3/16 X 2-1/2 COTTER PIN SS 
13304 1/16 X 1-1/2 COTTER PIN SS 	13311 3/32 X 1-1/2 COTTER PIN SS 	13318 1/8 X 1-1/2 COTTER PIN SS 	13323 5/32 X 1 COTTER PIN SS 	13329 5/32 X 3 COTTER PIN SS 	13336 3/16 X 3 COTTER PIN SS 

PRODUCT CATEGORY: K

<b>A/C O-Rings</b>				
Nitrile for use with R134A & R12 Refrigerant				
Assortment No. 804R				
A-18134 4.5MM X 7.3MM X 1.4MM NITRILE A/C O-RING 	A-18135 6MM X 9.6MM X 1.8MM NITRILE A/C O-RING 	A-18136 6.5MM X 9.5MM 1.5MM NITRILE A/C O-RING 	A-18137 6.6MM X 10.2MM X 1.8MM NITRILE A/C O-RING 	A-17604 290 X .432 X .071 NITRILE A/C O-RING 
A-18138 7.7MM X 11.3MM X 1.8MM NITRILE A/C O-RING 	A-18646 .375 X .500 X .063 NITRILE A/C O-RING 	A-17605 .400 X .546 X .073 NITRILE A/C O-RING 	A-18140 10.7MM X 15.5MM X 2.4MM NITRILE A/C O-RING 	A-18139 10.8MM X 14.4MM X 1.8MM NITRILE A/C O-RING 
A-17606 .509 X .655 X .073 NITRILE A/C O-RING 	A-18141 13.3MM X 18.1MM X 2.4MM NITRILE A/C O-RING 	A-18143 13.4MM X 17.2MM X 1.9MM NITRILE A/C O-RING 	A-18142 14MM X 17.6MM X 1.8MM NITRILE A/C O-RING 	A-18144 14.8MM X 19.6MM X 2.4MM NITRILE A/C O-RING 
A-17607 .617 X .769 X .076 NITRILE A/C O-RING 	A-18647 .688 X .813 X .063 NITRILE A/C O-RING 	A-19235 13/16 X 1-1/16 X 1/8 NITRILE A/C O-RING 		

PRODUCT CATEGORY: K

## Stainless Steel Cotter Pins

24 Items • 845 Pcs  
IBS No. 798R



Packaged in a Locking Steel Drawer  
for Easy Storage & Organization

## AC O-Rings

Nitrile for use with  
R134A & R12 Refrigerant  
18 Items • 180 Pcs  
IBS No. 804R



Packaged in a Locking Steel Drawer  
for Easy Storage & Organization

ASSORTMENTS



# IBS, INCORPORATED

## Assortments - Socket Products (L)

ASSORTMENTS

IBS, Inc. SPECIALTY PRODUCTS FOR MAINTENANCE & REPAIR INDUSTRIALBOLTY.COM © © © 800-678-1906						Hex Socket Head Cap Screws					
Assortment No. 167R											
14450 6-32 X 1/4 SOCKET HD C/S ALLOY	14454 6-32 X 3/4 SOCKET HD C/S ALLOY	14562 8-32 X 1/2 SOCKET HD C/S ALLOY	14681 10-32 X 1/2 SOCKET HD C/S	14571 10-24 X 1/2 SOCKET HD C/S	14685 10-32 X 1-1/4 SOCKET HD C/S						
14451 6-32 X 3/8 SOCKET HD C/S ALLOY	14455 6-32 X 1 SOCKET HD C/S ALLOY	14563 8-32 X 5/8 SOCKET HD C/S ALLOY	14682 10-32 X 5/8 SOCKET HD C/S	14572 10-24 X 5/8 SOCKET HD C/S	14686 10-32 X 1-1/2 SOCKET HD C/S						
14452 6-32 X 1/2 SOCKET HD C/S ALLOY	14560 8-32 X 1/4 SOCKET HD C/S ALLOY	14564 8-32 X 3/4 SOCKET HD C/S ALLOY	14683 10-32 X 3/4 SOCKET HD C/S	14573 10-24 X 3/4 SOCKET HD C/S	14576 10-24 X 1-1/4 SOCKET HD C/S						
14453 6-32 X 5/8 SOCKET HD C/S ALLOY	14561 8-32 X 3/8 SOCKET HD C/S ALLOY	14565 8-32 X 1 SOCKET HD C/S ALLOY	14684 10-32 X 1 SOCKET HD C/S ALLOY	14574 10-24 X 1 SOCKET HD C/S ALLOY	14577 10-24 X 1-1/2 SOCKET HD C/S						

PRODUCT CATEGORY: L

**Hex Socket Head  
Capscrews**  
24 Items • 925 Pcs  
IBS No. 167R



Packaged in a Locking Steel Drawer  
for Easy Storage & Organization

IBS, Inc. SPECIALTY PRODUCTS FOR MAINTENANCE & REPAIR INDUSTRIALBOLTY.COM © © © 800-678-1906								Socket Set Screws Knurled Point Thread							
Assortment No. 190R															
14168 6-32 X 1/4 SOC SET KNURLED PT	14169 6-32 X 5/16 SOC SET KNURLED PT	14170 6-32 X 3/8 SOC SET KNURLED PT	14178 8-32 X 1/4 SOC SET KNURLED PT	14179 8-32 X 5/16 SOC SET KNURLED PT	14180 8-32 X 3/8 SOC SET KNURLED PT	14182 8-32 X 1/2 SOC SET KNURLED PT	14187 10-24 X 3/16 SOC SET KNURLED								
14188 10-24 X 1/4 SOC SET KNURLED PT	14190 10-24 X 3/8 SOC SET KNURLED PT	14191 10-24 X 1/2 SOC SET KNURLED PT	14212 1/4-20 X 1/4 SOC SET KNURLED	14213 1/4-20 X 5/16 SOC SET	14214 1/4-20 X 3/8 SOC SET KNURLED	14216 1/4-20 X 1/2 SOC SET KNURLED	14218 1/4-20 X 3/4 SOC SET KNURLED								
14228 5/16-18 X 3/8 SOC SET	14300 5/16-18 X 1/2 SOC SET	14302 5/16-18 X 3/4 SOC SET	14314 3/8-16 X 1/2 SOC SET KNURLED	14315 3/8-16 X 5/8 SOC SET KNURLED	14316 3/8-16 X 3/4 SOC SET KNURLED	14318 3/8-16 X 1 SOC SET KNURLED PT	14335 1/2-13 X 1/2 SOC SET KNURLED								
14336 1/2-13 X 5/8 SOC SET KNURLED	14337 1/2-13 X 3/4 SOC SET KNURLED	14338 1/2-13 X 1 SOC SET KNURLED PT													

PRODUCT CATEGORY: L

**Socket Set Screws  
Knurled Point Thread**  
27 Items • 490 Pcs  
IBS No. 190R



Packaged in a Locking Steel Drawer  
for Easy Storage & Organization

IBS, Inc. SPECIALTY PRODUCTS FOR MAINTENANCE & REPAIR INDUSTRIALBOLTY.COM © © © 800-678-1906					SAE Alloy Socket Set Screws Knurled Point				
Assortment No. 191R									
14198 10-32 X 3/16 SOC SET KNURLED	14361 1/4-28 X 1/4 SOC SET KNURLED	14366 1/4-28 X 3/4 SOC SET KNURLED	14384 3/8-24 X 1/2 SOC SET KNURLED	14398 1/2-20 X 1/2 SOC SET CUP					
14199 10-32 X 1/4 SOC SET KNURLED PT	14362 1/4-28 X 5/16 SOC SET KNURLED	14372 5/16-24 X 3/8 SOC SET KNURLED	14385 3/8-24 X 5/8 SOC SET KNURLED	14399 1/2-20 X 5/8 SOC SET CUP					
14201 10-32 X 3/8 SOC SET KNURLED	14363 1/4-28 X 3/8 SOC SET KNURLED	14374 5/16-24 X 1/2 SOC SET KNURLED	14386 3/8-24 X 3/4 SOC SET KNURLED	14400 1/2-20 X 3/4 SOC SET CUP					
14203 10-32 X 1/2 SOC SET KNURLED	14365 1/4-28 X 1/2 SOC SET KNURLED	14376 5/16-24 X 3/4 SOC SET KNURLED	14387 3/8-24 X 1 SOC SET KNURLED PT	14401 1/2-20 X 1 SOC SET CUP POINT					

PRODUCT CATEGORY: L

**SAE Alloy Socket Set  
Screws Knurled Point**  
20 Items • 390 Pcs  
IBS No. 191R



Packaged in a Locking Steel Drawer  
for Easy Storage & Organization

# IBS, INCORPORATED

## Assortments - Socket Products (L)



 <b>Socket Head Cap Screws</b> 4-40 to 10-32 Assortment No. 371R					
14440 4-40 X 1/4 SOCKET HD C/S ALLOY	14441 4-40 X 3/8 SOCKET HD C/S ALLOY	14442 4-40 X 1/2 SOCKET HD C/S ALLOY	14443 4-40 X 5/8 SOCKET HD C/S ALLOY	14444 4-40 X 3/4 SOCKET HD C/S ALLOY	14480 6-32 X 1/4 SOCKET HD C/S ALLOY
14451 6-32 X 3/8 SOCKET HD C/S ALLOY	14452 6-32 X 1/2 SOCKET HD C/S ALLOY	14453 6-32 X 5/8 SOCKET HD C/S ALLOY	14454 6-32 X 3/4 SOCKET HD C/S ALLOY	14561 8-32 X 3/8 SOCKET HD C/S ALLOY	14562 8-32 X 1/2 SOCKET HD C/S ALLOY
14563 8-32 X 5/8 SOCKET HD C/S ALLOY	14564 8-32 X 3/4 SOCKET HD C/S ALLOY	14565 8-32 X 1 SOCKET HD C/S ALLOY	14570 10-24 X 3/8 SOCKET HD C/S	14571 10-24 X 1/2 SOCKET HD C/S	14573 10-24 X 3/4 SOCKET HD C/S
14574 10-24 X 1 SOCKET HD C/S ALLOY	14680 10-32 X 3/8 SOCKET HD C/S	14681 10-32 X 1/2 SOCKET HD C/S	14683 10-32 X 3/4 SOCKET HD C/S	14684 10-32 X 1 SOCKET HD C/S ALLOY	

PRODUCT CATEGORY: L

 <b>Socket Head Cap Screws</b> 4-40 to 10-32 Assortment No. 371R					
14440 4-40 X 1/4 SOCKET HD C/S ALLOY	14441 4-40 X 3/8 SOCKET HD C/S ALLOY	14442 4-40 X 1/2 SOCKET HD C/S ALLOY	14443 4-40 X 5/8 SOCKET HD C/S ALLOY	14444 4-40 X 3/4 SOCKET HD C/S ALLOY	14480 6-32 X 1/4 SOCKET HD C/S ALLOY
14451 6-32 X 3/8 SOCKET HD C/S ALLOY	14452 6-32 X 1/2 SOCKET HD C/S ALLOY	14453 6-32 X 5/8 SOCKET HD C/S ALLOY	14454 6-32 X 3/4 SOCKET HD C/S ALLOY	14561 8-32 X 3/8 SOCKET HD C/S ALLOY	14562 8-32 X 1/2 SOCKET HD C/S ALLOY
14563 8-32 X 5/8 SOCKET HD C/S ALLOY	14564 8-32 X 3/4 SOCKET HD C/S ALLOY	14565 8-32 X 1 SOCKET HD C/S ALLOY	14570 10-24 X 3/8 SOCKET HD C/S	14571 10-24 X 1/2 SOCKET HD C/S	14573 10-24 X 3/4 SOCKET HD C/S
14574 10-24 X 1 SOCKET HD C/S ALLOY	14680 10-32 X 3/8 SOCKET HD C/S	14681 10-32 X 1/2 SOCKET HD C/S	14683 10-32 X 3/4 SOCKET HD C/S	14684 10-32 X 1 SOCKET HD C/S ALLOY	

PRODUCT CATEGORY: L

 <b>Flat Head Socket Capscrews</b> 4-40 - 10-32 Assortment No. 373R					
147390 4-40 X 1/4 FLAT SOCKET C/S	147391 4-40 X 3/8 FLAT SOCKET C/S	147392 4-40 X 1/2 FLAT SOCKET C/S	147393 4-40 X 5/8 FLAT SOCKET C/S	147394 4-40 X 3/4 FLAT SOCKET C/S	147399 6-32 X 1/4 FLAT SOCKET HD C/S
147400 6-32 X 3/8 FLAT SOCKET C/S	147401 6-32 X 1/2 FLAT SOCKET C/S	147402 6-32 X 5/8 FLAT SOCKET C/S	147403 6-32 X 3/4 FLAT SOCKET C/S	147410 8-32 X 3/8 FLAT SOCKET C/S	147411 8-32 X 1/2 FLAT SOCKET C/S
147412 8-32 X 5/8 FLAT SOCKET C/S	147413 8-32 X 3/4 FLAT SOCKET C/S	147414 8-32 X 1 FLAT SOCKET C/S ALLOY	147420 10-24 X 3/8 FLAT SOCKET C/S	147421 10-24 X 1/2 FLAT SOCKET C/S	147423 10-24 X 3/4 FLAT SOCKET HD
147424 10-24 X 1 FLAT SOCKET HD C/S	14815 10-32 X 3/8 FLAT SOCKET C/S	14816 10-32 X 1/2 FLAT SOCKET C/S	14818 10-32 X 3/4 FLAT SOCKET C/S	14819 10-32 X 1 FLAT SOCKET C/S	

PRODUCT CATEGORY: L

### Socket Head Capscrews

4-40 to 10-32  
23 Items • 1,075 Pcs  
IBS No. 371R



Packaged in a Locking Steel Drawer  
for Easy Storage & Organization

### Socket Head Capscrews

1/4-20 to 1/2-13  
19 Items • 403 Pcs  
IBS No. 372R



Packaged in a Locking Steel Drawer  
for Easy Storage & Organization

### Flat Head Socket Capscrews

4-40 to 10-32  
23 Items • 1,050 Pcs  
IBS No. 373R



Packaged in a Locking Steel Drawer  
for Easy Storage & Organization

ASSORTMENTS



# IBS, INCORPORATED

## Assortments - Socket Products (L)

ASSORTMENTS

IBS, Inc. SPECIALTY PRODUCTS FOR MAINTENANCE & REPAIR INDUSTRIALBOLT.COM 9 9 9 800-679-1996		Flat Head Socket Capscrews 1/4-20 - 1/2-13			
Assortment No. 374R					
14750 1/4-20 X 1/2 FLAT SOCKET C/S 	14752 1/4-20 X 3/4 FLAT SOCKET C/S 	14753 1/4-20 X 1 FLAT SOCKET C/S 	14754 1/4-20 X 1-1/4 FLAT SOCKET 	14755 1/4-20 X 1-1/2 FLAT SOCKET 	
14760 5/16-18 X 1/2 FLAT SOCKET C/S 	14762 5/16-18 X 3/4 FLAT SOCKET C/S 	14763 5/16-18 X 1 FLAT SOCKET C/S 	14764 5/16-18 X 1-1/4 FLAT SOCKET 	14765 5/16-18 X 1-1/2 FLAT SOCKET 	
14772 3/8-16 X 3/4 FLAT SOCKET C/S 	14773 3/8-16 X 1 FLAT SOCKET C/S 	14774 3/8-16 X 1-1/4 FLAT SOCKET 	14775 3/8-16 X 1-1/2 FLAT SOCKET 	14777 3/8-16 X 2 FLAT SOCKET C/S 	
14787 1/2-13 X 1 FLAT SOCKET C/S 	14788 1/2-13 X 1-1/4 FLAT SOCKET 	14789 1/2-13 X 1-1/2 FLAT SOCKET 	14791 1/2-13 X 2 FLAT SOCKET C/S 		

PRODUCT CATEGORY: L

IBS, Inc. SPECIALTY PRODUCTS FOR MAINTENANCE & REPAIR INDUSTRIALBOLT.COM 9 9 9 800-679-1996		Button Head Socket Cap Screws 4-40 to 10-32			
Assortment No. 376R					
148911 4-40 X 1/4 BUTTON SOC C/S Hex Key: 1/16" 	148912 4-40 X 3/8 BUTTON SOC C/S Hex Key: 1/16" 	148913 4-40 X 3/8 BUTTON SOC C/S Hex Key: 1/16" 	148915 6-32 X 3/8 BUTTON SOC C/S Hex Key: 1/12" 	148916 6-32 X 3/8 BUTTON SOC C/S Hex Key: 5/64" 	148917 6-32 X 1/2 BUTTON SOC C/S Hex Key: 5/64" 
148918 6-32 X 5/8 BUTTON SOC C/S Hex Key: 5/64" 	148920 8-32 X 1/4 BUTTON SOC C/S Hex Key: 3/32" 	148921 8-32 X 3/8 BUTTON SOC C/S Hex Key: 3/32" 	14902 8-32 X 1/2 BUTTON SOC C/S Hex Key: 3/32" 	14903 8-32 X 5/8 BUTTON SOC C/S Hex Key: 3/32" 	14904 8-32 X 3/4 BUTTON SOC C/S Hex Key: 3/32" 
148925 10-24 X 1/4 BUTTON SOC C/S Hex Key: 1/8" 	148926 10-24 X 3/8 BUTTON SOC C/S Hex Key: 1/8" 	14907 10-24 X 1/2 BUTTON SOC C/S Hex Key: 1/8" 	14908 10-24 X 5/8 BUTTON SOC C/S Hex Key: 1/8" 	14909 10-24 X 3/4 BUTTON SOC C/S Hex Key: 1/8" 	14910 10-24 X 1 BUTTON SOC C/S Hex Key: 3/32" 
148930 10-32 X 1/4 BUTTON SOC C/S Hex Key: 1/8" 	148931 10-32 X 1/4 BUTTON SOC C/S Hex Key: 1/8" 	14911 10-32 X 1/2 BUTTON SOC C/S Hex Key: 1/8" 	148932 10-32 X 5/8 BUTTON SOC C/S Hex Key: 1/8" 	14912 10-32 X 3/4 BUTTON SOC C/S Hex Key: 1/8" 	14913 10-32 X 1 BUTTON SOC C/S Hex Key: 1/8" 

PRODUCT CATEGORY: L

IBS, Inc. SPECIALTY PRODUCTS FOR MAINTENANCE & REPAIR INDUSTRIALBOLT.COM 9 9 9 800-679-1996		Button Head Socket Capscrews 1/4-20 to 1/2-13			
Assortment No. 377R					
14915 1/4-20 X 3/8 BUTTON SOCKET C/S Hex Key 5/32" 	14916 1/4-20 X 1/2 BUTTON SOCKET C/S Hex Key 5/32" 	14917 1/4-20 X 5/8 BUTTON SOCKET C/S Hex Key 5/32" 	14918 1/4-20 X 3/4 BUTTON SOCKET C/S Hex Key 5/32" 	14919 1/4-20 X 1 BUTTON SOCKET C/S Hex Key 5/32" 	
14920 5/16-18 X 3/8 BUTTON SOCKET C/S Hex Key 3/16" 	14921 5/16-18 X 1/2 BUTTON SOCKET C/S Hex Key 3/16" 	14922 5/16 X 5/8 BUTTON SOCKET C/S Hex Key 3/16" 	14923 5/16-18 X 3/4 BUTTON SOCKET C/S Hex Key 3/16" 	14924 5/16-18 X 1 BUTTON SOCKET C/S Hex Key 3/16" 	
14926 3/8-16 X 1/2 BUTTON SOCKET C/S Hex Key 7/32" 	14927 3/8-16 X 5/8 BUTTON SOCKET C/S Hex Key 7/32" 	14928 3/8-16 X 3/4 BUTTON SOCKET C/S Hex Key 7/32" 	14929 3/8-16 X 1 BUTTON SOCKET C/S Hex Key 7/32" 	14930 3/8-16 X 1-1/4 BUTTON SOCKET C/S Hex Key 7/32" 	
14932 1/2-13 X 1 BUTTON SOCKET C/S Hex Key 5/16" 	14933 1/2-13 X 1-1/4 BUTTON SOCKET C/S Hex Key 5/16" 	14934 1/2-13 X 1-1/2 BUTTON SOCKET C/S Hex Key 5/16" 	14935 1/2-13 X 2 BUTTON SOCKET C/S Hex Key 5/16" 		

PRODUCT CATEGORY: L

### Flat Socket Head Capscrews

1/4-20 to 1/2-13  
19 Items • 356 Pcs  
IBS No. 374R



Packaged in a Locking Steel Drawer  
for Easy Storage & Organization

### Button Head Socket Capscrews

4-40 to 10-32  
24 Items • 1,050 Pcs  
IBS No. 376R



Packaged in a Locking Steel Drawer  
for Easy Storage & Organization

### Button Head Socket Capscrews

1/4-20 to 10-32  
19 Items • 1,050 Pcs  
IBS No. 377R



Packaged in a Locking Steel Drawer  
for Easy Storage & Organization

# IBS, INCORPORATED

## Assortments - Steel Pipe Fittings (N)



 <b>IBS, Inc.</b> <small>SPECIALTY PRODUCTS FOR MAINTENANCE &amp; REPAIR</small> <small>INDUSTRIALBOLTY.COM • 800-679-1996</small>								Steel Pipe Fittings									
							Assortment No. 139R										
15021 1/2 HEX PLUG NPT ZP 	15071 1/2 4SDGR ST. ELB 150# NPT BMI 	15063 1/2 90DGR ST. ELB 150# NPT BMI 	15027 1/2 COUPLER 150# NPT BMI 	15135 1/2 X CLOSE (1-1/8) BLACK 	15136 1/2 X 1-1/2 BLACK NIPPLE 	15077 1/2 X 1/8 HEX BUSHING NPT ZP 											
15020 3/8 HEX PLUG NPT ZP 	15070 3/8 4SDGR ST. ELB 150# NPT BMI 	15062 3/8 90DGR ST. ELB 150# NPT BMI 	15026 3/8 COUPLER 150# NPT BMI 	15126 3/8 X CLOSE (1) BLACK NIPPLE 	15127 3/8 X 1-1/2 BLACK NIPPLE 	15076 3/8 X 1/4 HEX BUSHING NPT ZP 											
15019 1/4 HEX PLUG NPT ZP 	15069 1/4 4SDGR ST. ELB 150# NPT BMI 	15061 1/4 90DGR ST. ELB 150# NPT BMI 	15025 1/4 COUPLER 150# NPT BMI 	15115 1/4 X CLOSE (7/8) BLACK NIPPLE 	15116 1/4 X 1-1/2 BLACK NIPPLE 	15075 3/8 X 1/8 HEX BUSHING NPT ZP 	15079 1/2 X 3/8 HEX BUSHING NPT ZP 										
15018 1/8 HEX PLUG NPT ZP 	15068 1/8 4SDGR ST. ELB 150# NPT BMI 	15060 1/8 90DGR ST. ELB 150# NPT BMI 	15201 1/8 COUPLER BLACK NPT STEEL 	15105 1/8 X CLOSE (3/4) BLACK NIPPLE 	15106 1/8 X 1-1/2 BLACK NIPPLE 	15074 1/4 X 1/8 HEX BUSHING NPT ZP 	15078 1/2 X 1/4 HEX BUSHING NPT ZP 										

PRODUCT CATEGORY: N

## Steel Pipe Fittings

### 30 Items • 34 Pcs

### IBS No. 139R



Packaged in a Locking Steel Drawer  
for Easy Storage & Organization

A  
S  
S  
O  
R  
T  
M  
E  
N  
T  
S



# IBS, INCORPORATED

## Assortments - Brass Pipe Fittings (O)

ASSORTMENTS

IBS, Inc. SPECIALTY PRODUCTS FOR MAINTENANCE & REPAIR INDUSTRIALBOLTY.COM © © © 800-478-1906								Brass Pipe Fittings	
								Assortment No. 103R	
3152X8 1/2 BRASS HEX HD PLUG	3220X8X2 1/4 X 1/8 BRASS PIPE HX	3326X4 1/4 X CLOSE BRASS NIPPLE	3350X4 1/4 BRASS 45DGR ST. ELBOW	3400X4 1/4 X 1/4 BRASS ST. ELBOW	3750X4 1/4 BRASS PIPE ST. TEE	WHD145 1/4 BRASS EXT SEAT DRAINCK	3300X8 1/2 BRASS PIPE COUPLING		
3152X6 3/8 BRASS HEX HD PLUG	3220X6X2 3/8 X 1/8 BRASS PIPE HX	3326X2 1/8 X CLOSE BRASS NIPPLE	3350X2 1/8 BRASS 45DGR ST. ELBOW	3400X2 1/8 X 1/8 BRASS ST. ELBOW	3750X2 1/8 BRASS PIPE ST. TEE	WHD135 1/8 BRASS EXT SEAT DRAINCK	3300X6 3/8 BRASS PIPE COUPLING		
3152X4 1/4 BRASS HEX HD PLUG	3220X4X2 3/8 X 1/8 BRASS PIPE HX	3326X8X6 1/2 X 3/8 BRASS PIPE HX	3350X8 1/2 BRASS 45DGR ST. ELBOW	3400X8 1/2 X 1/2 BRASS ST. ELBOW	3750X8 1/2 BRASS PIPE ST. TEE	WHD135 1/8 BRASS EXT SEAT DRAINCK	3300X4 1/4 BRASS PIPE COUPLING		
3152X2 1/8 BRASS HEX HD PLUG	3220X4X2 1/4 X 1/8 BRASS PIPE HX	3326X8X4 1/2 X 1/4 BRASS PIPE HX	3350X6 3/8 BRASS 45DGR ST. ELBOW	3400X6 3/8 X 3/8 BRASS ST. ELBOW	3750X6 3/8 BRASS PIPE ST. TEE	WHD135 1/8 BRASS EXT SEAT DRAINCK	3300X2 1/8 BRASS PIPE COUPLING		

PRODUCT CATEGORY: O

**Brass Pipe Fittings**  
32 Items • 64 Pcs  
IBS No. 103R



Packaged in a Locking Steel Drawer for Easy Storage & Organization

IBS, Inc. SPECIALTY PRODUCTS FOR MAINTENANCE & REPAIR INDUSTRIALBOLTY.COM © © © 800-478-1906				Brass Pipe Fittings	
				3/8" & 1/2"	
				Assortment No. 103R-LGR	
3220X6X4 3/8 X 1/4 BRASS PIPE HX	3326X8 1/2 X CLOSE BRASS NIPPLE	3400X8 1/2 X 1/2 BRASS ST. ELBOW	3300X8 1/2 BRASS PIPE COUPLING		
3220X6X2 3/8 X 1/8 BRASS PIPE HX	3326X6 3/8 X CLOSE BRASS NIPPLE	3400X6 3/8 X 3/8 BRASS ST. ELBOW	3300X6 3/8 BRASS PIPE COUPLING		
3152X8 1/2 BRASS HEX HD PLUG	3220X8X6 1/2 X 3/8 BRASS PIPE HX	3350X8 1/2 BRASS 45DGR ST. ELBOW	3750X8 1/2 BRASS PIPE ST. TEE		
3152X6 3/8 BRASS HEX HD PLUG	3220X8X4 1/2 X 1/4 BRASS PIPE HX	3350X6 3/8 BRASS 45DGR ST. ELBOW	3750X6 3/8 BRASS PIPE ST. TEE		

PRODUCT CATEGORY: O

**Brass Pipe Fittings**  
3/8" & 1/2"  
17 Items • 64 Pcs  
IBS No. 103R-LGR



Packaged in a Locking Steel Drawer for Easy Storage & Organization

IBS, Inc. SPECIALTY PRODUCTS FOR MAINTENANCE & REPAIR INDUSTRIALBOLTY.COM © © © 800-478-1906				Brass Pipe Fittings	
				1/8" & 1/4"	
				Assortment No. 103R-SML	
3220X4X2 1/4 X 1/8 BRASS PIPE HX	3400X4 1/4 X 1/4 BRASS ST. ELBOW	3750X4 1/4 BRASS PIPE ST. TEE	WHD145 1/4 BRASS EXT. SEAT DRAIN COCK		
3152X4 1/4 BRASS HEX HD PLUG	3400X2 1/8 X 1/8 BRASS ST. ELBOW	3750X2 1/8 BRASS PIPE ST. TEE	WHD135 1/8 BRASS EXT. SEAT DRAIN COCK		
3152X2 1/8 BRASS HEX HD PLUG	3326X4 1/4 X CLOSE BRASS NIPPLE	3350X4 1/4 BRASS 45DGR ST. ELBOW	3300X4 1/4 BRASS PIPE COUPLING		
	3326X2 1/8 X CLOSE BRASS NIPPLE	3350X2 1/8 BRASS 45DGR ST. ELBOW	3300X2 1/8 BRASS PIPE COUPLING		

PRODUCT CATEGORY: O

**Brass Pipe Fittings**  
1/8" & 1/4"  
15 Items • 69 Pcs  
IBS No. 103R-SML



Packaged in a Locking Steel Drawer for Easy Storage & Organization

# IBS, INCORPORATED

## Assortments - Brass Pipe Fittings (O)



**IBS, Inc.**  
SPECIALTY PRODUCTS FOR MAINTENANCE & REPAIR  
INDUSTRIALBOLTY.COM • 800-670-1506

**SAE 45° Flare  
Brass Fittings**

Assortment No. 104R

42X8 1/2 SAE 45DGR BRASS FLARE	48X5 5/16 X 1/8 SAE 45DGR BRASS	48X8 1/2 X 3/8 SAE 45DGR BRASS	48X10X6 5/8 X 3/8 SAE 45DGR BRASS	49X5X4 5/16 X 1/4 SAE 90DGR BRASS	49X8X4 1/2 X 1/4 SAE 90DGR BRASS	54X4 1/4 X 1/8 SAE 45DGR BRASS	54X10 5/8 X 1/2 SAE 45DGR BRASS
42X6 3/8 SAE 45DGR BRASS FLARE	48X4X4 1/4 X 1/4 SAE 45DGR BRASS	48X6X6 3/8 X 3/8 SAE 45DGR BRASS	48X10 5/8 X 1/2 SAE 45DGR BRASS	49X5 5/16 X 1/4 SAE 90DGR BRASS	49X8 1/2 X 3/8 SAE 90DGR BRASS	49X10X6 5/8 X 3/8 SAE 90DGR BRASS	54X5 1/2 X 3/8 SAE 45DGR BRASS
42X5 5/16 SAE 45DGR BRASS FLARE	48X4 1/4 X 1/8 SAE 45DGR BRASS	48X6 3/8 X 1/4 SAE 45DGR BRASS	48X8X8 1/2 X 1/2 SAE 45DGR BRASS	49X4X4 1/4 X 1/4 SAE 90DGR BRASS	49X6X6 3/8 X 3/8 SAE 90DGR BRASS	49X10 5/8 X 1/2 SAE 90DGR BRASS	54X6 3/8 X 1/4 SAE 45DGR BRASS
42X4 1/4 SAE 45DGR BRASS FLARE	42X10 5/8 SAE 45DGR BRASS FLARE	48X5X4 5/8 X 1/4 SAE 45DGR BRASS	48X8X4 1/2 X 1/4 SAE 45DGR BRASS	49X4 1/4 X 1/8 SAE 90DGR BRASS	49X6 3/8 X 1/4 SAE 90DGR BRASS	49X8X8 1/2 X 1/2 SAE 90DGR BRASS	54X5 5/16 X 1/8 SAE 45DGR BRASS

PRODUCT CATEGORY: O

**SAE 45° Flare  
Brass Fittings**  
32 Items • 95 Pcs  
IBS No. 104R



Packaged in a Locking Steel Drawer  
for Easy Storage & Organization

**IBS, Inc.**  
SPECIALTY PRODUCTS FOR MAINTENANCE & REPAIR  
INDUSTRIALBOLTY.COM • 800-670-1506

**SAE 45° Flare  
Brass Fittings**

Assortment No. 104R-LGR

42X8 1/2 SAE 45DGR BRASS FLARE	48X8X4 1/2 X 1/4 SAE 45DGR BRASS	48X8X8 1/2 X 1/2 SAE 45DGR BRASS	48X10 5/8 X 1/2 SAE 45DGR BRASS
42X10 5/8 SAE 45DGR BRASS FLARE	48X8 1/2 X 3/8 SAE 45DGR BRASS	48X10X6 5/8 X 3/8 SAE 45DGR BRASS	
54X8 1/2 X 3/8 SAE 45DGR BRASS	49X8X4 1/2 X 1/4 SAE 90DGR BRASS	49X8X8 1/2 X 1/2 SAE 90DGR BRASS	49X10 5/8 X 1/2 SAE 90DGR BRASS
54X10 5/8 X 1/2 SAE 45DGR BRASS	49X8 1/2 X 3/8 SAE 90DGR BRASS	49X10X6 5/8 X 3/8 SAE 90DGR BRASS	

PRODUCT CATEGORY: O

**SAE 45° Flare  
Brass Fittings**  
14 Items • 36 Pcs  
IBS No. 104R-LGR



Packaged in a Locking Steel Drawer  
for Easy Storage & Organization

**IBS, Inc.**  
SPECIALTY PRODUCTS FOR MAINTENANCE & REPAIR  
INDUSTRIALBOLTY.COM • 800-670-1506

**SAE 45° Flare  
Brass Fittings**

Assortment No. 104R-SML

42X4 1/4 SAE 45DGR BRASS FLARE	42X5 5/16 SAE 45DGR BRASS FLARE	42X6 3/8 SAE 45DGR BRASS FLARE	54X4 1/4 X 1/8 SAE 45DGR BRASS
48X4 1/4 X 1/8 SAE 45DGR BRASS	48X5 5/16 X 1/8 SAE 45DGR BRASS	48X6 3/8 X 1/4 SAE 45DGR BRASS	
48X4X4 1/4 X 1/4 SAE 45DGR BRASS	48X5X4 5/16 X 1/4 SAE 45DGR BRASS	48X6X6 3/8 X 3/8 SAE 45DGR BRASS	54X5 5/16 X 1/8 SAE 45DGR BRASS
49X4 1/4 X 1/8 SAE 90DGR BRASS	49X5 5/16 X 1/8 SAE 90DGR BRASS	49X6 3/8 X 1/4 SAE 90DGR BRASS	
49X4X4 1/4 X 1/4 SAE 90DGR BRASS	49X5X4 5/16 X 1/4 SAE 90DGR BRASS	49X6X6 3/8 X 3/8 SAE 90DGR BRASS	54X6 3/8 X 1/4 SAE 45DGR BRASS

PRODUCT CATEGORY: O

**SAE 45° Flare Brass  
Fittings 1/4", 5/16" &  
3/8"**

18 Items • 58 Pcs  
IBS No. 104R-SML























Packaged in a Locking Steel Drawer  
for Easy Storage & Organization



# IBS, INCORPORATED

## Assortments - Brass Pipe Fittings (O)

ASSORTMENTS

IBS, Inc. SPECIALTY PRODUCTS FOR MAINTENANCE & REPAIR INDUSTRIALBOLT.COM © © © 800-478-1906					Small Push-On Hose Fittings
					Assortment No. 111R
10004B-102 1/4 X 1/8 BRASS PUSH-ON M. PIPE 	10004B-104 1/4 X 1/4 BRASS PUSH-ON M. PIPE 	10005B-102 5/16 X 1/8 PUSH-ON M. PIPE 	10005B-104 5/16 X 1/4 PUSH-ON M. PIPE 	10004B-Y04 1/4 PUSH-ON HOSE MENDER 	
10006B-104 3/8 X 1/4 PUSH-ON M. PIPE 	10006B-106 3/8 X 3/8 PUSH-ON M. PIPE 	10004B-404 1/4 X 1/4 PUSH-ON SAE FE. 	10004B-405 1/4 X 5/16 PUSH-ON SAE FE. 	10005B-Y05 5/16 PUSH-ON HOSE MENDER 	
10005B-405 5/16 X 5/16 PUSH-ON SAE 	10006B-405 3/8 X 5/16 PUSH-ON SAE 	10006B-406 3/8 X 3/8 PUSH-ON SAE 	10004B-B04 1/4 X 1/4 PUSH-ON M. INV. 	10006B-Y06 3/8 PUSH-ON HOSE MENDER 	
10004B-B05 1/4 X 5/16 PUSH-ON 	10005B-B04 5/16 X 1/4 PUSH-ON M. 	10005B-B05 5/16 X 5/16 PUSH-ON M. INV. 	10006B-B05 3/8 X 5/16 PUSH-ON M. 	10006B-B06 3/8 X 3/8 PUSH-ON M. INV. 	













PRODUCT CATEGORY: O

### Small Push-On Hose Fittings

20 Items • 88 Pcs  
IBS No. 111R



Packaged in a Locking Steel Drawer for Easy Storage & Organization

IBS, Inc. SPECIALTY PRODUCTS FOR MAINTENANCE & REPAIR INDUSTRIALBOLT.COM © © © 800-478-1906					Large Push-On Hose Fittings
					Assortment No. 112R
10008B-106 1/2 X 3/8 PUSH-ON M. PIPE 		10008B-108 1/2 X 1/2 PUSH-ON M. PIPE 		10008B-Y08 1/2 PUSH-ON HOSE MENDER 	
10010B-108 5/8 X 1/2 PUSH-ON M. PIPE 		10012B-112 3/4 X 3/4 PUSH-ON M. PIPE RIGID 		10010B-Y10 5/8 PUSH-ON HOSE MENDER 	
10008B-408 1/2 X 1/2 PUSH-ON SAE FE. SWIV 		10010B-410 5/8 X 5/8 PUSH-ON SAE FE. 		10012B-Y12 3/4 PUSH-ON HOSE MENDER 	
10012B-412 PUSH-ON SAE FEMALE SWIVEL 	10008B-B08 1/2 X 1/2 PUSH-ON M. INV 	10006B-606 3/8 X 3/8 PUSH-ON JIC FE. 			

PRODUCT CATEGORY: O

### Large Push-On Hose Fittings

12 Items • 51 Pcs  
IBS No. 112R



Packaged in a Locking Steel Drawer for Easy Storage & Organization

IBS, Inc. SPECIALTY PRODUCTS FOR MAINTENANCE & REPAIR INDUSTRIALBOLT.COM © © © 800-478-1906					Brass Draincocks & Shut-Off Valves
					Assortment No. 121R
WHD135 1/8 BRASS EXT. SEAT DRAIN COCK 	WHD145 1/4 BRASS EXT. SEAT DRAIN COCK 	WHD270 3/8 BRASS EXT. SEAT DRAIN COCK 	WHD130 1/8 BRASS INT. SEAT DRAIN COCK 	WHD108 1/2 BRASS EXT. SEAT DRAIN COCK 	
WHD-1424 1/8 INT. SEAT DRAIN VALVE BRASS 	WHD-1425 1/4 INT. SEAT DRAIN VALVE BRASS 	WHD-1426 3/8 INT. SEAT DRAIN VALVE BRASS 	6809 1/4 FE BRASS PIPE SHUT OFF 	WHD1423 5/8 X 3/8 PIPE TO HOSE SHUT 	
WHD6824 1/8 X 1/8 M. TO F. SHUT OFF 	6828 1/4 X 1/4 MARINE SHUT OFF 	WHD150 1/8 BRASS ANGLE BIB DRAIN COCK 	WHD6660 1/4 BRASS ANGLE BIB DRAIN COCK 	229KF SHUT OFF 	
WHD-1421 1/4 BRASS AIR TANK VALVE 	WHD6829 1/4 X 1/4 M TO F SHUT OFF 	WHD-6892 1/4 BRASS GROUND PLUG 	WHD-6893 3/8 BRASS GROUND PLUG 	WHD1422 3/8 X 3/8 PIPE TO HOSE SHUT 	

PRODUCT CATEGORY: O

### SAE 45° Flare Brass Fittings

20 Items • 34 Pcs  
IBS No. 121R



Packaged in a Locking Steel Drawer for Easy Storage & Organization



# IBS, INCORPORATED

## Assortments - Brass Pipe Fittings (O)



<b>IBS, Inc.</b> <small>SPECIALTY PRODUCTS FOR MAINTENANCE &amp; REPAIR  INDUSTRIALBOLTY.COM ☎ 800-678-1906</small>				<b>Air Brake Fittings for Hose</b>	
Assortment No. 149R					
<b>W15536</b> 3/8 X 1/4 AIR BRAKE MALE CONNECTOR WITH SPRING GUARD 	<b>W15539</b> 3/8 X 1/2 AIR BRAKE MALE CONNECTOR 	<b>W23907</b> 3/8 X 3/8 AIR BRAKE MALE CONNECTOR WITH SPRING GUARD 	<b>W33886</b> 1/2 X 1/2 AIR BRAKE MALE CONNECTOR WITH SPRING GUARD 		
		<b>W03624</b> 3/8 AIR BRAKE NUT 			<b>W33802</b> 1/2 AIR BRAKE NUT 
		<b>W16678</b> 3/8 AIR BRAKE HOSE MENDER 			
<b>W15535</b> 3/8 X 1/2 AIR BRAKE MALE CONNECTOR WITH SPRING GUARD 	<b>W03613</b> 3/8 AIR BRAKE NUT FOR SPRING GUARD 			<b>W33801</b> 1/2 AIR BRAKE SLEEVE 	
		<b>W15540</b> 3/8 X 1/4 AIR BRAKE MALE CONNECTOR 			
				<b>W24887</b> 3/8 X 3/8 AIR BRAKE MALE CONNECTOR 	

PRODUCT CATEGORY: O

### Air Brake Fittings for Hose

13 Items • 35 Pcs  
IBS No. 149R



Packaged in a Locking Steel Drawer  
for Easy Storage & Organization

<b>IBS, Inc.</b> <small>SPECIALTY PRODUCTS FOR MAINTENANCE &amp; REPAIR  INDUSTRIALBOLTY.COM ☎ 800-678-1906</small>						<b>Compression Brass Fittings</b>	
Assortment No. 177R							
<b>60X3</b> 3/16 OD BRASS COMP SLEEVE 	<b>60X4</b> 1/4 OD BRASS COMP SLEEVE 	<b>60X5</b> 5/16 OD BRASS COMP SLEEVE 	<b>60X6</b> 3/8 OD BRASS COMP SLEEVE 	<b>61X3</b> 3/16 OD BRASS COMP NUT 	<b>61X4</b> 1/4 OD BRASS COMP NUT 		
<b>61X5</b> 5/16 OD BRASS COMP NUT 	<b>61X6</b> 3/8 OD BRASS COMP NUT 	<b>62X3</b> 3/16 OD BRASS COMP UNION 	<b>62X4</b> 1/4 OD BRASS COMP UNION 	<b>62X5</b> 5/16 OD BRASS COMP UNION 	<b>62X6</b> 3/8 OD BRASS COMP UNION 		
<b>68X3</b> 3/16 X 1/8 BRASS COMP M CONN 	<b>68X4</b> 1/4 X 1/8 BRASS COMP M CONN 	<b>68X4X4</b> 1/4 X 1/4 BRASS COMP M CONN 	<b>68X5</b> 5/16 X 1/8 BRASS COMP M CONN 	<b>68X5X4</b> 5/16 X 1/4 BRASS COMP M CONN 	<b>68X6</b> 3/8 X 1/4 BRASS COMP M CONN 		
<b>69X3</b> 3/16 X 1/8 90DGR BRASS COMP M 	<b>69X4</b> 1/4 X 1/8 90DGR BRASS COMP M 	<b>69X4X4</b> 1/4 X 1/4 90DGR BRASS COMP M 	<b>69X5</b> 3/8 X 1/8 90DGR BRASS COMP M 	<b>69X5X4</b> 5/16 X 1/4 90DGR BRASS COMP M 	<b>69X6</b> 1/4 X 1/4 90DGR BRASS COMP M 		

PRODUCT CATEGORY: O

### Compression Brass Fittings

24 Items • 209 Pcs  
IBS No. 177R



Packaged in a Locking Steel Drawer  
for Easy Storage & Organization

<b>IBS, Inc.</b> <small>SPECIALTY PRODUCTS FOR MAINTENANCE &amp; REPAIR  INDUSTRIALBOLTY.COM ☎ 800-678-1906</small>						<b>Inverted Flare Brass Fittings</b>	
Assortment No. 178R							
<b>105X3</b> 3/16 INV TUBE NUT STEEL 	<b>105X4</b> 1/4 INV TUBE NUT STEEL 	<b>105X5</b> 5/16 INV TUBE NUT STEEL 	<b>105X6</b> 3/8 INV TUBE NUT STEEL 	<b>202X3</b> 3/16 X 1/8 INV M CONN BRASS 	<b>202X4</b> 1/4 X 1/8 INV M CONN BRASS 		
<b>202X4X4</b> 1/4 X 1/4 INV M CONN BRASS 	<b>202X5</b> 5/16 X 1/8 INV M CONN BRASS 	<b>202X5X4</b> 5/16 X 1/4 INV M CONN BRASS 	<b>202X6</b> 3/8 X 1/4 INV M CONN BRASS 	<b>402X3</b> 3/16 X 1/8 INV 90DGR ELBOW M 	<b>402X4</b> 1/4 X 1/8 INV 90DGR ELBOW M 		
<b>402X4X4</b> 1/4 X 1/4 INV 90DGR ELBOW M 	<b>402X5</b> 5/16 X 1/8 INV 90DGR ELBOW M 	<b>402X5X4</b> 5/16 X 1/4 INV 90DGR ELBOW M 	<b>402X6</b> 3/8 X 1/4 INV 90DGR ELBOW M 	<b>352X3</b> 3/16 X 1/8 INV 45DGR ELBOW M 	<b>352X4</b> 1/4 X 1/8 INV 45DGR ELBOW M 		
<b>352X5</b> 5/16 X 1/8 INV 45DGR ELBOW M 	<b>352X6</b> 3/8 X 1/4 INV 45DGR ELBOW M 	<b>302X3</b> 3/16 INV UNION BRASS 	<b>302X4</b> 1/4 INV UNION BRASS 	<b>302X5</b> 5/16 INV UNION BRASS 	<b>302X6</b> 3/8 INV UNION BRASS 		

PRODUCT CATEGORY: O

### Inverted Flare Brass Fittings

24 Items • 129 Pcs  
IBS No. 178R



Packaged in a Locking Steel Drawer  
for Easy Storage & Organization



# IBS, INCORPORATED

## Assortments - Brass Pipe Fittings (O)

ASSORTMENTS

IBS, Inc. SPECIALTY PRODUCTS FOR MAINTENANCE & REPAIR INDUSTRIALBOLTY.COM © © © 800-678-1906		Fuller Transmission Fittings Compression & Push-On 1/8" & 5/32"				Assortment No. 179R
660A 1/8 SLEEVE FULLER TRANS	669A 1/8X1/8 M ELBOW FULLER TRANS	668AS 1/8X1/16 M CONN FULLER TRANS	1169X2X3B 1/8X1/8 90DGR M SWIV ELB POLY	56822 1/8 X 1/8 M CONN POLY PUSH NP	1162X2 1/8 UNION POLY PUSH NP BRASS	
660B 5/32 SLEEVE FULLER TRANS	669B 5/32X1/8 M ELBOW FULLER TRANS	668A 1/8X1/8 M CONN FULLER TRANS	1169X3X2S 5/32X1/8 90DGR M SWIV ELB	56832 5/32 X 1/8 M CONN POLY PUSH	1162X3 5/32 UNION POLY PUSH NP BRASS	
661A 1/8 NUT FULLER TRANS	662A 1/8 UNION FULLER TRANS	668BS 5/32 X1/16 M CONN FULLER TRANS	1169X3X4S 5/32X1/4 90DGR M SWIV ELB	56834 5/32 X 1/4 M CONN POLY PUSH		
661B 5/32 NUT FULLER TRANS	662B 5/32 UNION FULLER TRANS	668B 5/32X1/8 M CONN FULLER TRANS				

PRODUCT CATEGORY: O

### Fuller Transmission Fittings Compression & Push-On

1/8" & 5/32"  
20 Items • 95 Pcs  
IBS No. 179R



Packaged in a Locking Steel Drawer for Easy Storage & Organization

IBS, Inc. SPECIALTY PRODUCTS FOR MAINTENANCE & REPAIR INDUSTRIALBOLTY.COM © © © 800-678-1906		Push Lock DOT Air Brake Fittings 1/4" & 3/8"		Assortment No. 180R
86842 1/4 X 1/8 POLY-MATIC DOT MALE	87942 1/4 X 1/8 POLY-MATIC DOT M	86244 1/4 POLY-MATIC DOT UNION		
86844 1/4 X 1/4 POLY-MATIC DOT MALE	87944 1/4 X 1/4 POLY-MATIC M SWIVEL	86266 3/8 POLY-MATIC DOT UNION		
86864 3/8 X 1/4 POLY-MATIC DOT MALE	87964 3/8 X 1/4 POLY-MATIC DOT M	88244 1/4 POLY-MATIC DOT BULK HEAD		
86866 3/8 X 3/8 POLY-MATIC DOT MALE	87966 3/8 X 3/8 POLY-MATIC DOT M	88266 3/8 POLY-MATIC DOT BULK HEAD		

PRODUCT CATEGORY: O

### Push-Lock DOT Air Brake Fittings

12 Items • 36 Pcs  
IBS No. 180R



Packaged in a Locking Steel Drawer for Easy Storage & Organization

IBS, Inc. SPECIALTY PRODUCTS FOR MAINTENANCE & REPAIR INDUSTRIALBOLTY.COM © © © 800-678-1906		Push Lock DOT Air Brake Fittings 1/4", 3/8" and 1/2"		Assortment No. 181R
87944 1/4 X 1/4 POLY-MATIC M SWIVEL ELBOW	87966 3/8 X 3/8 POLY-MATIC DOT M SWIVEL ELBOW	87988 1/2 X 1/2 POLY-MATIC DOT M SWIVEL ELBOW		
87942 1/4 X 1/8 POLY-MATIC DOT M SWIVEL ELBOW	87964 3/8 X 1/4 POLY-MATIC DOT M SWIVEL ELBOW	87986 1/2 X 3/8 POLY-MATIC DOT M SWIVEL ELBOW		
86844 1/4 X 1/4 POLY-MATIC DOT MALE CONNECTOR	86866 3/8 X 3/8 POLY-MATIC DOT MALE CONNECTOR	86888 1/2 X 1/2 POLY-MATIC DOT MALE CONNECTOR		
86842 1/4 X 1/8 POLY-MATIC DOT MALE CONNECTOR	86864 3/8 X 1/4 POLY-MATIC DOT MALE CONNECTOR	86886 1/2 X 3/8 POLY-MATIC DOT MALE CONNECTOR		
88244 1/4 POLY-MATIC DOT BULK HEAD UNION	88266 3/8 POLY-MATIC DOT BULK HEAD UNION	88288 1/2 POLY-MATIC DOT BULK HEAD UNION		
86244 1/4 POLY-MATIC DOT UNION	86266 3/8 POLY-MATIC DOT UNION	86288 1/2 POLY-MATIC DOT UNION		

PRODUCT CATEGORY: O

### Push-Lock DOT Air Brake Fittings

1/4", 3/8" & 1/2"  
18 Items • 45 Pcs  
IBS No. 181R



Packaged in a Locking Steel Drawer for Easy Storage & Organization

# IBS, INCORPORATED

## Assortments - Brass Pipe Fittings (O)



<b>IBS, Inc.</b> <small>SPECIALTY PRODUCTS FOR MAINTENANCE &amp; REPAIR  INDUSTRIALBOLT.COM 8 8 8 800-678-1996</small>					<b>Nylon Air Brake Fittings</b> 1/4" & 3/8"				
					192R				
1460X4 1/4 BRASS A/B SLEEVE	1461X4 1/4 BRASS A/B NUT	1462X4 1/4 BRASS A/B UNION	1468X4 1/4 X 1/8 BRASS A/B M CONN	1468X4X4 1/4 X 1/4 BRASS A/B M CONN					
1469X4 1/4 X 1/8 BRASS A/B 90DGR M CONN	1469X4X4 1/4 X 1/4 BRASS A/B 90DGR M CONN	1480X4 1/4 X 1/8 BRASS A/B 45DGR M CONN	1484X4 1/4 BRASS A/B INSERT	1460X6 3/8 BRASS A/B SLEEVE					
1461X6 3/8 BRASS A/B NUT	1462X6 3/8 BRASS A/B UNION	1468X6 3/8 X 1/4 BRASS A/B M CONN	1468X6X2 3/8 X 1/8 BRASS A/B M CONN	1468X6X6 3/8 X 3/8 BRASS A/B M CONN					
1469X6 3/8 X 1/4 BRASS A/B 90DGR M CONN	1469X6X2 3/8 X 1/8 BRASS A/B 90DGR M CONN	1469X6X6 3/8 X 3/8 BRASS A/B 90DGR M CONN	1480X6 3/8 X 1/4 BRASS A/B 45DGR M CONN	1484X6 3/8 BRASS A/B INSERT					

PRODUCT CATEGORY: O

### Nylon Air Brake Fittings

1/4" & 3/8"  
20 Items • 121 Pcs  
IBS No. 192R



Packaged in a Locking Steel Drawer for Easy Storage & Organization

<b>IBS, Inc.</b> <small>SPECIALTY PRODUCTS FOR MAINTENANCE &amp; REPAIR  INDUSTRIALBOLT.COM 8 8 8 800-678-1996</small>				<b>1/2" Nylon Air Brake Fittings</b>			
				Assortment No. 193R			
1460X8 1/2 BRASS A/B SLEEVE	1461X8 1/2 BRASS A/B NUT	1462X8 1/2 BRASS A/B UNION	1468X8 1/2 X 3/8 BRASS A/B M. CONN				
1468X8X4 1/2 X 1/4 BRASS A/B M. CONN	1468X8X8 1/2 X 1/2 BRASS A/B M. CONN	1469X8 1/2 X 3/8 BRASS A/B 90DGR	1469X8X4 1/2 X 1/4 BRASS A/B 90DGR				
1469X8X8 1/2 X 1/2 BRASS A/B 90DR	1480X8 1/2 X 3/8 BRASS A/B 45DGR	1484X8 1/2 BRASS A/B INSERT					

PRODUCT CATEGORY: O

### 1/2" Nylon Air Brake Fittings

11 Items • 68 Pcs  
IBS No. 193R



Packaged in a Locking Steel Drawer for Easy Storage & Organization

<b>IBS, Inc.</b> <small>SPECIALTY PRODUCTS FOR MAINTENANCE &amp; REPAIR  INDUSTRIALBOLT.COM 8 8 8 800-678-1996</small>					<b>Poly-Matic Nickel Plated Brass Fittings</b>				
					Assortment No. 197R				
56822 1/8 X 1/8 COMPOSITE M CONN	56842 1/4 X 1/8 COMPOSITE M CONN	56844 1/4 X 1/4 COMPOSITE M CONN	56862 3/8 X 1/8 COMPOSITE M CONN	56864 3/8 X 1/4 COMPOSITE M CONN					
56866 3/8 X 3/8 COMPOSITE M CONN	56886 1/2 X 3/8 COMPOSITE M CONN	1169X2X2S 1/2 X 1/8 90DGR M SWIV ELB POLY	1169X4X2S 1/4 X 1/8 90DGR M SWIV ELB POLY	1169X4X4S 1/4 X 1/4 90DGR M SWIV ELB POLY					
1169X6X2S 3/8 X 1/8 90DGR M SWIV POLY	1169X6X4S 3/8 X 1/4 90DGR M SWIV ELB POLY	1169X6X6S 3/8 X 3/8 90DGR M SWIV ELB POLY	1169X8X6S 1/2 X 3/8 90DGR M SWIV ELB POLY						
1162X2 1/8 UNION POLY PUSH NP BRASS	1162X4 1/4 UNION POLY PUSH NP BRASS	1162X6 3/8 UNION POLY PUSH NP BRASS	1162X8 1/2 UNION POLY PUSH NP BRASS						

PRODUCT CATEGORY: O

### Poly-Matic Nickel Plated Brass Fittings

18 Items • 44 Pcs  
IBS No. 197R



Packaged in a Locking Steel Drawer for Easy Storage & Organization



# IBS, INCORPORATED

## Assortments - Brass Pipe Fittings (O)

ASSORTMENTS

<b>IBS, Inc.</b> <small>SPECIALTY PRODUCTS FOR MAINTENANCE &amp; REPAIR  INDUSTRIALBOLT.COM • • • 800-678-1906</small>				Male/Female Pipe Thread Protectors
Assortment No. 203R				
18102 1/8 MALE NPT POLY PLUG 	18104 1/4 MALE NPT POLY PLUG 	18106 3/8 MALE NPT POLY PLUG 	18108 1/2 MALE NPT POLY PLUG 	
18112 3/4 MALE NPT POLY PLUG 	18116 1 MALE NPT POLY PLUG 	18120 1-1/4 MALE NPT POLY PLUG 	18124 1-1/2 MALE NPT POLY PLUG 	
18152 1/8 FEMALE NPT POLY CAP 	18154 1/4 FEMALE NPT POLY CAP 	18156 3/8 FEMALE NPT POLY CAP 	18158 1/2 FEMALE NPT POLY CAP 	
18162 3/4 FEMALE NPT POLY CAP 	18166 1 FEMALE NPT POLY CAP 	18170 1-1/4 FEMALE NPT POLY CAP 	18174 1-1/2 FEMALE NPT POLY CAP 	

PRODUCT CATEGORY: O

### Pipe Thread Protector Assortment

16 Items • 340 Pcs  
IBS No. 203R



Packaged in a Locking Steel Drawer for Easy Storage & Organization

<b>IBS, Inc.</b> <small>SPECIALTY PRODUCTS FOR MAINTENANCE &amp; REPAIR  INDUSTRIALBOLT.COM • • • 800-678-1906</small>			5/8" Air Brake Fittings for Nylon
Assortment No. 217R			
1460X10 5/8 BRASS A/B SLEEVE 	1461X10 5/8 BRASS A/B NUT 	1462X10 5/8 BRASS A/B UNION 	
1468X10 5/8 X 1/2 BRASS A/B M. CONN 	1468X10X6 5/8 X 3/8 BRASS A/B M CONN 	1468X10X12 5/8 X 3/4 BRASS A/B M CONN 	
1469X10 5/8 X 1/2 BRASS A/B 90DGR 	1469X10X6 5/8 X 3/8 BRASS A/B 90DGR 	1469X10X12 5/8 X 3/4 BRASS A/B 90DGR 	
1480X10 5/8 X 1/2 BRASS A/B 45DR 	1484X10 5/8 BRASS A/B INSERT 		

PRODUCT CATEGORY: O

### 5/8" Air Brake Fittings for Nylon Tubing

11 Items • 25 Pcs  
IBS No. 217R



Packaged in a Locking Steel Drawer for Easy Storage & Organization

<b>IBS, Inc.</b> <small>SPECIALTY PRODUCTS FOR MAINTENANCE &amp; REPAIR  INDUSTRIALBOLT.COM • • • 800-678-1906</small>					Long-Barb Push-On Fittings 1/8", 3/16", 1/4", 5/16"
Assortment No. 218R					
10403B-103 3/16 LONG BARB UNION 	10404B-104 1/4 LONG BARB UNION 	10405B-105 5/16 LONG BARB UNION 	10406B-104 3/8 X 1/4 LONG BARB UNION 	10406B-105 3/8 X 5/16 LONG BARB UNION 	
10502B-102 1/8 X 3/8 M. LONG BARB H. END 	10503B-102 3/16 X 1/8 M. LONG BARB H. END 	10503B-104 3/16 X 1/4 M. LONG BARB H. END 	10504B-102 1/4 X 1/8 M. LONG BARB H. END 	10504B-104 1/4 X 1/4 M LONG BARB HOSE END 	
10504B-106 1/4 X 3/8 M. LONG BARB H. END 	10505B-102 5/16 X 1/8 M. LONG BARB H. END 	10505B-104 5/16 X 1/4 M. LONG BARB H. END 	10502B-202 1/8 X 1/8 F. LONG BARB H. END 	10503B-202 3/16 X 1/8 F. LONG BARB H. END 	
10504B-202 1/4 X 1/8 F. LONG BARB H. END 	10504B-204 1/4 X 1/4 F. LONG BARB H. END 	10505B-202 5/16 X 1/8 F. LONG BARB H. END 	10505B-204 5/16 X 1/4 F. LONG BARB H. END 		

PRODUCT CATEGORY: O

### Push-On Hose Fittings 1/8", 3/16", 1/4" & 5/16"

19 Items • 78 Pcs  
IBS No. 218R



Packaged in a Locking Steel Drawer for Easy Storage & Organization

# IBS, INCORPORATED

## Assortments - Brass Pipe Fittings (O)



<b>Long-Barb Push-On Fittings</b> 3/8", 1/2, 3/4"			
Assortment No. 219R			
10406B-106 3/8 LONG BARB UNION	10408B-108 1/2 LONG BARB UNION	10410B-110 5/8 LONG BARB UNION	10412B-112 3/4 LONG BARB UNION
10506B-104 3/8 X 1/4 M. LONG BARB H. END	10506B-106 3/8 X 3/8 M. LONG BARB H. END	10508B-106 1/2 X 3/8 M. LONG BARB H. END	10508B-108 1/2 X 1/2 M. LONG BARB H. END
10510B-108 5/8 X 1/2 M. LONG BARB H. END	10512B-108 3/4 X 1/2 M LONG BARB HOSE	10512B-112 3/4 X 3/4 M. LONG BARB H. END	10506B-204 3/8 X 1/4 F. LONG BARB H. END
10506B-206 3/8 X 3/8 F. LONG BARB H. END	10508B-204 1/2 X 1/4 F. LONG BARB H. END	10508B-206 1/2 X 3/8 F. LONG BARB H. END	10508B-208 1/2 X 1/2 F. LONG BARB H. END

PRODUCT CATEGORY: O

### Push-On Hose Fittings 3/8", 1/2" & 3/4"

16 Items • 56 Pcs  
IBS No. 219R



Packaged in a Locking Steel Drawer for Easy Storage & Organization

<b>Poly-Push Composite Metric Fittings for Nylon Tubing</b> M4, M6 & M8					
Assortment No. 332R					
301202 M4 X 1/8SPT COMPOSITE M CONN	301212 M6 X 1/8SPT COMPOSITE M CONN	301213 M6 X 1/4SPT COMPOSITE M CONN	301218 M8 X 1/4SPT COMPOSITE M CONN	301219 M8 X 3/8SPT COMPOSITE M CONN	309250 M4 COMPOSITE STRAIGHT UNION
302202 M4 X 1/8SPT COMP M SWIV	302212 M6 X 1/8SPT COMP M SWIV	302213 M6 X 1/4SPT COMP M SWIV	302218 M8 X 1/4SPT COMP M SWIV	302219 M8 X 3/8SPT COMP M SWIV	309263 M6 COMPOSITE UNION CONN POLY
307202 M4 X 1/8SPT COMP M BRANCH	307212 M6 X 1/8SPT COMP M BRANCH	307213 M6 X 1/4SPT COMP M BRANCH	307218 M8 X 1/4SPT COMP M BRANCH	307219 M8 X 3/8SPT COMP M BRANCH	309268 M8 COMPOSITE STRAIGHT UNION
304250 M4 COMPOSITE UNION ELBOW POLY	304263 M6 COMPOSITE UNION ELBOW POLY	304268 M8 COMPOSITE UNION ELBOW POLY	305250 M4 COMPOSITE UNION TEE POLY	305263 M6 COMPOSITE UNION TEE POLY	305268 M8 COMPOSITE UNION TEE POLY

PRODUCT CATEGORY: O

### Poly-Push Composite Metric Fittings for Nylon Tubing

M4, M6 & M8  
24 Items • 39 Pcs  
IBS No. 332R



Packaged in a Locking Steel Drawer for Easy Storage & Organization

<b>Poly-Push Composite Metric Fittings for Nylon Tubing</b> M10 & M12				
Assortment No. 333R				
301223 M10 X 1/4SPT COMPOSITE M	301224 M10 X 3/8SPT COMPOSITE M	301225 M10 X 1/2SPT COMPOSITE M	301229 M12 X 3/8SPT COMPOSITE M	301230 M12 X 1/2SPT COMPOSITE M
302223 M10 X 1/4SPT COMP M SWIV ELB	302224 M10 X 3/8SPT COMP M SWIV ELB	302229 M12 X 3/8SPT COMP M SWIV ELB	302230 M12 X 1/2SPT COMP M SWIV ELB	
304272 M10 COMPOSITE UNION ELBOW	304275 M12 COMPOSITE UNION ELBOW	305272 M10 COMPOSITE UNION TEE POLY	305275 M12 COMPOSITE UNION TEE POLY	
309272 M10 COMPOSITE STRAIGHT UNION	309275 M12 COMPOSITE STRAIGHT UNION	307224 M10 X 3/8SPT COMP M BRANCH	307230 M12 X 1/2SPT COMP M BRANCH	

PRODUCT CATEGORY: O

### Poly-Push Composite Metric Fittings for Nylon Tubing

M10 & M12  
17 Items • 19 Pcs  
IBS No. 333R



Packaged in a Locking Steel Drawer for Easy Storage & Organization



# IBS, INCORPORATED

## Assortments - Brass Pipe Fittings (O)

ASSORTMENTS

IBS, Inc. SPECIALTY PRODUCTS FOR MAINTENANCE & REPAIR INDUSTRIALBOLT.COM © 2010 800-678-1996					Push Lock DOT Fittings 5/32", 1/4" & 3/8"				
					Assortment No. 334R				
86233 5/32 POLY-MATIC DOT UNION 	86244 1/4 POLY-MATIC DOT UNION 	86266 3/8 POLY-MATIC DOT UNION 	86444 1/4 POLY-MATIC DOT UNION TEE 	86466 3/8 POLY-MATIC DOT UNION TEE 					
86842 1/4 X 1/8 POLY-MATIC DOT MALE 	86844 1/4 X 1/4 POLY-MATIC DOT MALE 	86864 3/8 X 1/4 POLY-MATIC DOT MALE 	86866 3/8 X 3/8 POLY-MATIC DOT MALE 						
87242 1/4X1/8 POLY-MATIC DOT M SWIV 	87244 1/4X1/4 POLY-MATIC DOT M SWIV 	87264 3/8X1/4 POLY-MATIC DOT M SWIV 	87266 3/8X3/8 POLY-MATIC DOT M SWIV 						
87942 1/4 X 1/8 POLY-MATIC DOT M 	87944 1/4 X 1/4 POLY-MATIC M SWIVEL 	87964 3/8 X 1/4 POLY-MATIC DOT M 	87966 3/8 X 3/8 POLY-MATIC DOT M 						

PRODUCT CATEGORY: O

IBS, Inc. SPECIALTY PRODUCTS FOR MAINTENANCE & REPAIR INDUSTRIALBOLT.COM © 2010 800-678-1996					Push Lock DOT Fittings 3/8" & 1/2"				
					Assortment No. 335R				
86266 3/8 POLY-MATIC DOT UNION 	86288 1/2 POLY-MATIC DOT UNIONS 			86466 3/8 POLY-MATIC DOT UNION TEE 	86488 1/2 POLY-MATIC DOT UNION TEE 				
86866 3/8 X 3/8 POLY-MATIC DOT MALE 	86884 1/2 X 1/4 POLY-MATIC DOT MALE 	86886 1/2 X 3/8 POLY-MATIC DOT MALE 	86888 1/2 X 1/2 POLY-MATIC DOT MALE 						
87266 3/8X3/8 POLY-MATIC DOT M SWIV 	87284 1/2X1/4 POLY-MATIC DOT M SWIV 	87286 1/2X3/8 POLY-MATIC DOT M SWIV 	87288 1/2X1/2 POLY-MATIC DOT M SWIV 						
87966 3/8 X 3/8 POLY-MATIC DOT M 	87984 1/2 X 1/4 POLY-MATIC DOT M 	87986 1/2 X 3/8 POLY-MATIC DOT M 	87988 1/2 X 1/2 POLY-MATIC DOT M 						

PRODUCT CATEGORY: K

IBS, Inc. SPECIALTY PRODUCTS FOR MAINTENANCE & REPAIR INDUSTRIALBOLT.COM © 2010 800-678-1996						Poly-Push Composite Fractional Fittings for Nylon Tubing 1/8", 5/32", 1/4" & 5/16"					
						Assortment No. 336R					
56222 1/8 COMPOSITE STRAIGHT UNION 	56233 5/32 COMPOSITE STRAIGHT UNION 	56244 1/4 COMPOSITE STRAIGHT UNION 	56242 1/4 X 1/8 COMPOSITE UNION RED 	56255 5/16 COMPOSITE STRAIGHT UNION 							
56422 1/8 COMPOSITE UNION TEE POLY 	56444 1/4 COMPOSITE UNION TEE POLY 	56522 1/8 COMPOSITE UNION ELBOW 	56544 1/4 COMPOSITE UNION ELBOW 			57244 1/4 X 1/4 COMP M SWIV BR TEE 					
56822 1/8 X 1/8 COMPOSITE M CONN 	56824 1/8 X 1/4 COMPOSITE M CONN 	56832 5/32 X 1/8 COMPOSITE M CONN 	56842 1/4 X 1/8 COMPOSITE M CONN 	56844 1/4 X 1/4 COMPOSITE M CONN 	56854 5/16 X 1/4 COMPOSITE M CONN 						
57922 1/8 X 1/8 COMP M SWIV ELBOW 	57924 1/8 X 1/4 COMP M SWIV ELBOW 	57932 5/32 X 1/8 COMP M SWIV ELBOW 	57942 1/4 X 1/8 COMP M SWIV ELBOW 	57944 1/4 X 1/4 COMP M SWIV ELBOW 	57954 5/16 X 1/4 COMP M SWIV ELBOW 						

PRODUCT CATEGORY: O

### Poly-Matic DOT Air Brake Fittings

17 Items • 33 Pcs  
IBS No. 334R



Packaged in a Locking Steel Drawer for Easy Storage & Organization

### Poly-Matic DOT Air Brake Fittings

16 Items • 21 Pcs  
IBS No. 335R



Packaged in a Locking Steel Drawer for Easy Storage & Organization

### Poly-Push Composite Fractional Fittings for Nylon Tubing

1/8", 5/32", 1/4" & 5/16"  
22 Items • 41 Pcs  
IBS No. 336R



Packaged in a Locking Steel Drawer for Easy Storage & Organization

# IBS, INCORPORATED

## Assortments - Brass Pipe Fittings (O)



### Poly-Push Composite Fractional Fittings for Nylon Tubing

#### 3/8" & 1/2"

17 Items • 24 Pcs  
IBS No. 337R



Packaged in a Locking Steel Drawer for Easy Storage & Organization

### Hydraulic Hose Shields

10 Items • 25 Pcs  
IBS No. 367R



Packaged in a Locking Steel Drawer for Easy Storage & Organization

### Boss & For-Seal O-Ring Fittings Caps & Plugs

15 Items • 45 Pcs  
IBS No. 736R



Packaged in a Locking Steel Drawer for Easy Storage & Organization

<b>Poly-Push Composite Fractional Fittings for Nylon Tubing</b> 3/8" & 1/2" Assortment No. 337R				
56266 3/8 COMPOSITE STRAIGHT UNION 	56264 3/8 X 1/4 COMPOSITE UNION RED 	56288 1/2 COMPOSITE STRAIGHT UNION 	57264 3/8 X 1/4 COMP M SWIV BR TEE 	57286 1/2 X 3/8 COMP M SWIV BR TEE 
56466 3/8 COMPOSITE UNION TEE POLY 	56488 1/2 COMPOSITE UNION TEE POLY 	56566 3/8 COMPOSITE UNION ELBOW 	56588 1/2 COMPOSITE UNION ELBOW 	
56864 3/8 X 1/4 COMPOSITE M CONN 	56866 3/8 X 3/8 COMPOSITE M CONN 	56886 1/2 X 3/8 COMPOSITE M CONN 	56888 1/2 X 1/2 COMPOSITE M CONN 	
57964 3/8 X 1/4 COMP M SWIV ELBOW 	57966 3/8 X 3/8 COMP M SWIV ELBOW 	57986 1/2 X 3/8 COMP M SWIV ELBOW 	57988 1/2 X 1/2 COMP M SWIV ELBOW 	

PRODUCT CATEGORY: O

<b>Hydraulic Hose Shields</b> Assortment No. 367R			
18180 4" BLACK HOSE SHIELD 	18185 6" BLACK HOSE SHIELD 	18191 8" BLACK HOSE SHIELD 	18197 10" BLACK HOSE SHIELD 
18181 4" ORANGE HOSE SHIELD 	18186 6" ORANGE HOSE SHIELD 	18192 8" ORANGE HOSE SHIELD 	
18182 4" YELLOW HOSE SHIELD 	18187 6" YELLOW HOSE SHIELD 	18193 8" YELLOW HOSE SHIELD 	

PRODUCT CATEGORY: O

<b>Boss and For-Seal O-Ring Fittings Cap and Plugs</b> Assortment No. 736R				
7237X4 1/4 O-RING BOSS PLUG 	7237X6 3/8 O-RING BOSS PLUG 	7237X8 1/2 O-RING BOSS PLUG 	7237X10 5/8 O-RING BOSS PLUG 	7237X12 3/4 O-RING BOSS PLUG 
4229X4 1/4 FOR-SEAL PLUG 	4229X6 3/8 FOR-SEAL PLUG 	4229X8 1/2 FOR-SEAL PLUG 	4229X10 5/8 FOR-SEAL PLUG 	4229X12 3/4 FOR-SEAL PLUG 
4129X4 1/4 FOR-SEAL CAP 	4129X6 3/8 FOR-SEAL CAP 	4129X8 1/2 FOR-SEAL CAP 	4129X10 5/8 FOR-SEAL CAP 	4129X12 3/4 FOR-SEAL CAP 

PRODUCT CATEGORY: O

ASSORTMENTS



# IBS, INCORPORATED

## Assortments - Brass Pipe Fittings (O)

ASSORTMENTS

IBS, Inc. SPECIALTY PRODUCTS FOR MAINTENANCE & REPAIR INDUSTRIALBOLTY.COM © © © 800-678-1996					Assortment No. 737R
<b>CS315X4</b> 1/4 X 1/4 MALE JIC TO MALE O-RING BOSS 	<b>CS315X4X6</b> 1/4 X 3/8 MALE JIC TO MALE O-RING BOSS 	<b>CS315X6X4</b> 3/8 X 1/4 MALE JIC TO MALE O-RING BOSS 	<b>CS315X6</b> 3/8 X 3/8 MALE JIC TO MALE O-RING BOSS 	<b>CS315X6X8</b> 3/8 X 1/2 MALE JIC TO MALE O-RING BOSS 	
<b>CS315X8X6</b> 1/2 X 3/8 MALE JIC TO MALE O-RING BOSS 	<b>CS315X8</b> 1/2 X 1/2 MALE JIC TO MALE O-RING BOSS 	<b>CS315X12X8</b> 3/4 X 1/2 MALE JIC TO MALE O-RING BOSS 	<b>CS315X12</b> 3/4 X 3/4 MALE JIC TO MALE O-RING BOSS 		
<b>CS515X4</b> 1/4 MALE JIC TO MALE O-RING BOSS 90DG 	<b>CS515X6</b> 3/8 MALE JIC TO MALE O-RING BOSS 90DG 	<b>CS515X6X8</b> 3/8 X 1/2 MALE JIC TO MALE O-RING BOSS 90DG 	<b>CS515X8X6</b> 1/2 X 3/8 MALE JIC TO MALE O-RING BOSS 90DG 	<b>CS515X8</b> 1/2 MALE JIC TO MALE O-RING BOSS 90DG 	
<b>CS515X12</b> 3/4 MALE JIC TO MALE O-RING BOSS 90DG 					

PRODUCT CATEGORY: O

### Boss O-Ring Fittings

15 Items • 46 Pcs  
IBS No. 737R



Packaged in a Locking Steel Drawer for Easy Storage & Organization

IBS, Inc. SPECIALTY PRODUCTS FOR MAINTENANCE & REPAIR INDUSTRIALBOLTY.COM © © © 800-678-1996					Assortment No. 738R
<b>CS229X4</b> 1/4 JIC PLUG 	<b>CS129X4</b> 1/4 JIC CAP 	<b>CS305X4</b> 1/4 JIC UNION 	<b>CS205X4</b> 1/4 X 1/8 JIC M. CONN 	<b>CS205X8</b> 1/2 X 3/8 JIC M. CONN 	
<b>CS229X6</b> 3/8 JIC PLUG 	<b>CS129X6</b> 3/8 JIC CAP 	<b>CS305X6</b> 3/8 JIC UNION 	<b>CS205X4X4</b> 1/4 X 1/4 JIC M. CONN 	<b>CS205X8X8</b> 1/2 X 1/2 JIC M. CONN 	
<b>CS229X8</b> 1/2 JIC PLUG 	<b>CS129X8</b> 1/2 JIC CAP 	<b>CS305X8</b> 1/2 JIC UNION 	<b>CS205X6</b> 3/8 X 1/4 JIC M. CONN 		
<b>CS229X12</b> 3/4 JIC PLUG 	<b>CS129X12</b> 3/4 JIC CAP 	<b>CS305X12</b> 3/4 JIC UNION 	<b>CS205X6X6</b> 3/8 X 3/8 JIC M. CONN 		

PRODUCT CATEGORY: O

### JIC Fitting Adapters

18 Items • 52 Pcs  
IBS No. 738R



Packaged in a Locking Steel Drawer for Easy Storage & Organization

IBS, Inc. SPECIALTY PRODUCTS FOR MAINTENANCE & REPAIR INDUSTRIALBOLTY.COM © © © 800-678-1996					Assortment No. 739R
<b>9205X2X4</b> 1/8 X 1/4 FEMALE PIPE SWIVEL TO MALE PIPE 	<b>9205X4X4</b> 1/4 X 1/4 FEMALE PIPE SWIVEL TO MALE PIPE 	<b>9205X4X6</b> 1/4 X 3/8 FEMALE PIPE SWIVEL TO MALE PIPE 	<b>9205X6X4</b> 3/8 X 1/4 FEMALE PIPE SWIVEL TO MALE PIPE 	<b>9205X6X6</b> 3/8 X 3/8 FEMALE PIPE SWIVEL TO MALE PIPE 	
<b>9205X6X8</b> 3/8 X 1/2 FEMALE PIPE SWIVEL TO MALE PIPE 	<b>9205X8X6</b> 1/2 X 3/8 FEMALE PIPE SWIVEL TO MALE PIPE 	<b>9205X8X8</b> 1/2 X 1/2 FEMALE PIPE SWIVEL TO MALE PIPE 			
<b>9405X4X4</b> 1/4 X 1/4 FEMALE PIPE SWIVEL TO MALE PIPE 90DG 	<b>9405X4X6</b> 1/4 X 3/8 FEMALE PIPE SWIVEL TO MALE PIPE 90DG 	<b>9405X6X4</b> 3/8 X 1/4 FEMALE PIPE SWIVEL TO MALE PIPE 90DG 	<b>9405X6X6</b> 3/8 X 3/8 FEMALE PIPE SWIVEL TO MALE PIPE 90DG 	<b>9405X6X8</b> 3/8 X 1/2 FEMALE PIPE SWIVEL TO MALE PIPE 90DG 	
<b>9405X8X6</b> 1/2 X 3/8 FEMALE PIPE SWIVEL TO MALE PIPE 90DG 	<b>9405X8X8</b> 1/2 X 1/2 FEMALE PIPE SWIVEL TO MALE PIPE 90DG 				

PRODUCT CATEGORY: O

### JIC Swivel Fittings

15 Items • 30 Pcs  
IBS No. 739R



Packaged in a Locking Steel Drawer for Easy Storage & Organization



# IBS, INCORPORATED

## Assortments - Brass Pipe Fittings (O)



IBS, Inc. SPECIALTY PRODUCTS FOR MAINTENANCE & REPAIR INDUSTRIALBOLT.COM • • • 800-878-1906		Field Attachable Fittings	
20620-6-6 5/16 X 3/8 JIC 37DGR F STRAIGHT SWIVEL	20820-8-8 13/32 X 1/2 SAE 45DGR F STRAIGHT SWIVEL	27920-4-4 3/16 X 1/4 SAE 45DGR FLARE F SWIVEL 90DGR ELBOW	Assortment No. 750R
20620-8-8 13/32 X 1/2 JIC 37DGR F STRAIGHT SWIVEL	20820-10-10 1/2 X 5/8 SAE 45DGR F STRAIGHT SWIVEL	27920-6-6 5/16 X 3/8 SAE 45DGR FLARE F SWIVEL 90DGR ELBOW	
20820-4-4 3/16 X 1/4 SAE 45DGR F STRAIGHT SWIVEL	20120-8-8 13/32 X 1/2 MALE PIPE RIGID	27920-8-8 13/32 X 1/2 SAE 45DGR FLARE F SWIVEL 90DGR ELBOW	
20820-6-6 5/16 X 3/8 SAE 45DGR F STRAIGHT SWIVEL		27920-10-10 1/2 X 3/8 SAE 45DGR FLARE F SWIVEL 90DGR ELBOW	

PRODUCT CATEGORY: O

### Field Attachable Fittings

11 Items • 19 Pcs  
IBS No. 750R



Packaged in a Locking Steel Drawer for Easy Storage & Organization

IBS, Inc. SPECIALTY PRODUCTS FOR MAINTENANCE & REPAIR INDUSTRIALBOLT.COM • • • 800-878-1906		Spiral Hose Wrap	
19000 1/2 X 8 SIN BLK HOSE WRAP FOR 1/4ID HYD HOSE	19002 5/8 X 8 SIN RED HOSE WRAP FOR 1/4ID AND 3/8ID HYD HOSE	19004 3/4 X 8 SIN YELLOW HOSE WRAP FOR 3/8ID HYD HOSE	19006 1IN X 8 SIN GREEN HOSE WRAP FOR 1/2ID AND 5/8ID HYD HOSE
		19008 1-1/4IN X 8IN PURPLE HOSE WRAP FOR 3/4ID HYD HOSE	19010 1-1/2IN X 8IN GRAY HOSE WRAP FOR 1IN AND 1-1/4 IN HYD HOSE

PRODUCT CATEGORY: O

### Spiral Hose Wrap

6 Items • 21 Pcs  
IBS No. 777R



Packaged in a Locking Steel Drawer for Easy Storage & Organization

IBS, Inc. SPECIALTY PRODUCTS FOR MAINTENANCE & REPAIR INDUSTRIALBOLT.COM • • • 800-878-1906		Hydraulic O-Ring Assortment	
8X252 1/2 SPLIT FLANGE O-RING	12X252 3/4 SPLIT FLANGE O-RING	16X252 1" SPLIT FLANGE O-RING	20X252 1-1/4 SPLIT FLANGE O-RING
			24X252 1-1/2 SPLIT FLANGE O-RING
32X252 2" SPLIT FLANGE O-RING	4629X4 1/4 FOR-SEAL O-RING	4629X6 3/8 FOR-SEAL O-RING	4629X8 1/2 FOR-SEAL O-RING
			4629X10 5/8 FOR-SEAL O-RING
4629X12 3/4 FOR-SEAL O-RING	4629X16 1" FOR-SEAL O-RING	4629X20 1-1/4 FOR-SEAL O-RING	7629X4 1/4 O-RING BOSS STRAIGHT THREAD
			7629X6 3/8 O-RING BOSS STRAIGHT THREAD
7629X8 1/2 O-RING BOSS STRAIGHT THREAD	7629X10 5/8 O-RING BOSS STRAIGHT THREAD	7629X12 3/4 O-RING BOSS STRAIGHT THREAD	7629X16 1IN O-RING BOSS STRAIGHT THREAD

PRODUCT CATEGORY: O

### Hydraulic O-Ring Assortment

19 Items • 162 Pcs  
IBS No. 805R



Packaged in a Locking Steel Drawer for Easy Storage & Organization

ASSORTMENTS



# IBS, INCORPORATED

## Assortments - Brass Pipe Fittings (O)

ASSORTMENTS

**IBS, Inc.**  
SPECIALTY PRODUCTS FOR MAINTENANCE & REPAIR  
INDUSTRIALBOLT.COM © & © 200-678-1506

**Hydraulic Quick Couplers**

Assortment No. 825R

Hydraulic Quick Couplers

<p>137782 1/2 X 1/2 ISO-A F PIPE COUPLER HYDRAULIC QUICK DISCONNECT</p>	<p>137784 3/4 X 3/4 ISO-A F PIPE COUPLER HYDRAULIC QUICK DISCONNECT</p>	<p>137786 1 X 1 ISO-A F PIPE COUPLER HYDRAULIC QUICK DISCONNECT</p>	<p>137787 1 X 1 ISO-A F PIPE PLUG HYDRAULIC QUICK DISCONNECT</p>
<p>137783 1/2 X 1/2 ISO-A F PIPE PLUG HYDRAULIC QUICK DISCONNECT</p>	<p>137785 3/4 X 3/4 ISO-A F PIPE PLUG HYDRAULIC QUICK DISCONNECT</p>		

PRODUCT CATEGORY: O

### Hydraulic Quick Couplers

6 Items • 12 Pcs  
IBS No. 825R



Packaged in a Locking Steel Drawer for Easy Storage & Organization

**IBS, Inc.**  
SPECIALTY PRODUCTS FOR MAINTENANCE & REPAIR  
INDUSTRIALBOLT.COM © & © 200-678-1506

**Gladhands**

Assortment No. 826R

Gladhands

<p>393SER GLADHAND SERVICE</p>	<p>393EME GLADHAND EMERGENCY</p>	<p>393UNIV GLADHAND UNIVERSAL</p>	<p>37535 LOCTITE DIELECTRIC GREASE 30Z TUBE</p>
<p>394GLE GLADHAND SEAL SERVICE - BLUE</p>	<p>394GLR GLADHAND SEAL EMERGENCY - RED</p>	<p>394GL GLADHAND SEAL UNIVERSAL - BLACK</p>	

PRODUCT CATEGORY: O

### Glad Hands

7 Items • 22 Pcs  
IBS No. 826R



Packaged in a Locking Steel Drawer for Easy Storage & Organization

**IBS, Inc.**  
SPECIALTY PRODUCTS FOR MAINTENANCE & REPAIR  
INDUSTRIALBOLT.COM © & © 200-678-1506

**Composite DOT Push Connect Fittings - 1/4", 3/8" and 1/2"**

Assortment No. 829R

Composite DOT Push Connect Fittings - 1/4", 3/8" and 1/2"

<p>86018 1/4 X 1/4 COMPOSITE DOT 90DGR MALE ELBOW PUSH CONNECT</p>	<p>86022 3/8 X 3/8 COMPOSITE DOT 90DGR MALE ELBOW PUSH CONNECT</p>	<p>86026 1/2 X 1/2 COMPOSITE DOT 90DGR MALE ELBOW PUSH CONNECT</p>	
<p>86017 1/4 X 1/8 COMPOSITE DOT 90DGR MALE ELBOW PUSH CONNECT</p>	<p>86021 3/8 X 1/4 COMPOSITE DOT 90DGR MALE ELBOW PUSH CONNECT</p>	<p>86025 1/2 X 3/8 COMPOSITE DOT 90DGR MALE ELBOW PUSH CONNECT</p>	
<p>86004 1/4 X 1/4 COMPOSITE DOT MALE PUSH CONNECT</p>	<p>86008 3/8 X 3/8 COMPOSITE DOT MALE PUSH CONNECT</p>	<p>86012 1/2 X 1/2 COMPOSITE DOT MALE PUSH CONNECT</p>	
<p>86003 1/4 X 1/8 COMPOSITE DOT MALE PUSH CONNECT</p>	<p>86007 3/8 X 1/4 COMPOSITE DOT MALE PUSH CONNECT</p>	<p>86011 1/2 X 3/8 COMPOSITE DOT MALE PUSH CONNECT</p>	
<p>86086 1/4 X 9/16-18 COMPOSITE DOT BULKHEAD UNION PUSH CONNECT</p>	<p>86087 3/8 X 7/8-14 COMPOSITE DOT BULKHEAD UNION PUSH CONNECT</p>	<p>86088 1/2 X 1-12 COMPOSITE DOT BULKHEAD UNION PUSH CONNECT</p>	
<p>86072 1/4 COMPOSITE DOT UNION PUSH CONNECT</p>	<p>86073 3/8 COMPOSITE DOT UNION PUSH CONNECT</p>	<p>86074 1/2 COMPOSITE DOT UNION PUSH CONNECT</p>	

PRODUCT CATEGORY: O

### Composite Body DOT Air Brake Fittings

18 Items • 30 Pcs  
IBS No. 829R















Packaged in a Locking Steel Drawer for Easy Storage & Organization

# IBS, INCORPORATED

## Assortments - Brass Pipe Fittings (O)



 <b>IBS, Inc.</b> <small>SPECIALTY PRODUCTS FOR MAINTENANCE &amp; REPAIR                  INDUSTRIALBOLT.COM • 800-678-1906</small>				Air Brake Fittings For 3/8" Hose
<small>Assortment No. 844R</small>				
<b>W15536</b> 3/8 X 1/4 AIR BRAKE FOR HOSE MALE CONNECTOR W/ SPRING 	<b>W15540</b> 3/8 X 1/4 AIR BRAKE FOR HOSE MALE CONNECTOR 	<b>W16678</b> 3/8 AIR BRAKE FOR HOSE MENDER 	<b>W33470</b> 3/8 X 3/8 BRASS AIR HOSE CONN 	
<b>W23907</b> 3/8 X 3/8 AIR BRAKE FOR HOSE MALE CONNECTOR W/ SPRING 	<b>W24887</b> 3/8 X 3/8 AIR BRAKE FOR HOSE MALE CONNECTOR 	<b>W03624</b> 3/8 AIR BRAKE FOR HOSE NUT 	<b>W15992</b> 3/8 X 1/2 AIR BRAKE FOR HOSE INSERT 	
<b>W15535</b> 3/8 X 1/2 AIR BRAKE FOR HOSE MALE CONNECTOR W/ SPRING 	<b>W15539</b> 3/8 X 1/2 AIR BRAKE FOR HOSE MALE CONNECTOR 	<b>W03613</b> 3/8 AIR BRAKE FOR HOSE NUT FOR SPRING GUARD 	<b>W03610</b> 3/8 AIR BRAKE FOR HOSE SLEEVE 	











PRODUCT CATEGORY: O

### Air Brake Fittings for 3/8" Hose

12 Items • 30 Pcs  
IBS No. 844R



Packaged in a Locking Steel Drawer  
for Easy Storage & Organization

 <b>IBS, Inc.</b> <small>SPECIALTY PRODUCTS FOR MAINTENANCE &amp; REPAIR                  INDUSTRIALBOLT.COM • 800-678-1906</small>				Air Brake Fittings For 1/2" Hose
<small>Assortment No. 845R</small>				
<b>W33885</b> 1/2 X 3/8 AIR BRAKE FOR HOSE MALE CONNECTOR W/ SPRING 	<b>W33883</b> 1/2 X 3/8 AIR BRAKE FOR HOSE MALE CONNECTOR 	<b>W33887</b> 1/2 AIR BRAKE FOR HOSE MENDER 	<b>W33889</b> 1/2 X 1/2 AIR BRAKE FOR HOSE INSERT 	
<b>W33886</b> 1/2 X 1/2 AIR BRAKE FOR HOSE MALE CONNECTOR W/ SPRING 	<b>W33884</b> 1/2 X 1/2 AIR BRAKE FOR HOSE MALE CONNECTOR 	<b>W33802</b> 1/2 AIR BRAKE FOR HOSE NUT 	<b>W33801</b> 1/2 AIR BRAKE FOR HOSE SLEEVE 	
		<b>W33803</b> 1/2 AIR BRAKE FOR HOSE NUT FOR SPRING GUARD 		











PRODUCT CATEGORY: O

### Air Brake Fittings for 1/2" Hose

9 Items • 22 Pcs  
IBS No. 845R

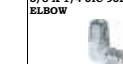
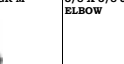

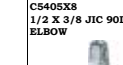
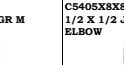
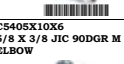
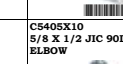
Packaged in a Locking Steel Drawer  
for Easy Storage & Organization

 <b>IBS, Inc.</b> <small>SPECIALTY PRODUCTS FOR MAINTENANCE &amp; REPAIR                  INDUSTRIALBOLT.COM • 800-678-1906</small>				SAE 37° JIC Flare 90° Elbows
<small>Assortment No. 846R</small>				
<b>C5405X4</b> 1/4 X 1/8 JIC 90DGR M ELBOW 	<b>C5405X4X4</b> 1/4 X 1/4 JIC 90DGR M ELBOW 	<b>C5405X5</b> 5/16 X 1/8 JIC 90DGR M ELBOW 	<b>C5405X5X4</b> 5/16 X 1/4 JIC 90DGR M ELBOW 	
<b>C5405X6X2</b> 3/8 X 1/8 JIC 90DGR M ELBOW 	<b>C5405X6</b> 3/8 X 1/4 JIC 90DGR M ELBOW 	<b>C5405X6X6</b> 3/8 X 3/8 JIC 90DGR M ELBOW 		
<b>C5405X8X4</b> 1/2 X 1/4 JIC 90DGR M ELBOW 	<b>C5405X8</b> 1/2 X 3/8 JIC 90DGR M ELBOW 	<b>C5405X8X8</b> 1/2 X 1/2 JIC 90DGR M ELBOW 		
<b>C5405X10X6</b> 5/8 X 3/8 JIC 90DGR M ELBOW 	<b>C5405X10</b> 5/8 X 1/2 JIC 90DGR M ELBOW 		<b>C5405X12</b> 3/4 X 3/4 JIC 90DGR M ELBOW 	

PRODUCT CATEGORY: O

### SAE 37° JIC Flare 90° Elbows

13 Items • 23 Pcs  
IBS No. 846R



Packaged in a Locking Steel Drawer  
for Easy Storage & Organization

ASSORTMENTS



# IBS, INCORPORATED

## Assortments - Brass Pipe Fittings (O)



For-Seal to Straight-Thread O-Ring Fittings

Assortment No. 847R

<p><b>4315X4</b> 1/4 X 1/4 MALE FACE SEAL TO STRAIGHT THREAD O-RING CONNECTOR</p> 	<p><b>4315X6</b> 3/8 X 3/8 MALE FACE SEAL TO STRAIGHT THREAD O-RING CONNECTOR</p> 	<p><b>4315X8</b> 1/2 X 1/2 MALE FACE SEAL TO STRAIGHT THREAD O-RING CONNECTOR</p> 	<p><b>4315X10</b> 3/4 X 3/4 MALE FACE SEAL TO STRAIGHT THREAD O-RING CONNECTOR</p> 	<p><b>4315X12</b> 5/8 X 5/8 MALE FACE SEAL TO STRAIGHT THREAD O-RING CONNECTOR</p> 
<p><b>4365X4</b> 1/4 45DGR FOR SEAL TO STRT THREAD O-RING CONN</p> 	<p><b>4365X6</b> 3/8 45DGR FOR SEAL TO STRT THREAD O-RING CONN</p> 	<p><b>4365X8</b> 1/2 45DGR FOR SEAL TO STRT THREAD O-RING CONN</p> 	<p><b>4365X10</b> 5/8 45DGR FOR SEAL TO STRT THREAD O-RING CONN</p> 	<p><b>4365X12</b> 3/4 45DGR FOR SEAL TO STRT THREAD O-RING CONN</p> 
<p><b>4515X4</b> 1/4 X 1/4 90DGR FOR-SEAL TO STRAIGHT THREAD O-RING CONN</p> 	<p><b>4515X6</b> 3/8 X 3/8 90DGR FOR-SEAL TO STRAIGHT THREAD O-RING CONN</p> 	<p><b>4515X8</b> 1/2 X 1/2 90DGR FOR-SEAL TO STRAIGHT THREAD O-RING CONN</p> 	<p><b>4515X10</b> 5/8 X 5/8 90DGR FOR-SEAL TO STRAIGHT THREAD O-RING CONN</p> 	<p><b>4515X12</b> 3/4 X 3/4 90DGR FOR-SEAL TO STRAIGHT THREAD O-RING CONN</p> 

PRODUCT CATEGORY: O

### For-Seal to Straight Thread O-Ring Fittings

15 Items • 22 Pcs  
IBS No. 847R



Packaged in a Locking Steel Drawer for Easy Storage & Organization

A  
S  
S  
O  
R  
T  
M  
E  
N  
T  
S

# IBS, INCORPORATED

## Assortments - Abrasives (PA)



IBS, Inc. SPECIALTY PRODUCTS FOR MAINTENANCE & REPAIR INDUSTRIALBOLT.COM • 800-878-1986					Flap Wheels
					Assortment No. 398R
65056 3/4 X 3/4 120G FLAP WHEEL 	65029 1 X 1 120G FLAP WHEEL 	65036 1-1/2 X 1 120G FLAP WHEEL 	65044 2 X 1 120G FLAP WHEEL 	65052 3 X 1 120G FLAP WHEEL 	
65055 3/4 X 3/4 80G FLAP WHEEL 	65025 1 X 1 80G FLAP WHEEL 	65034 1-1/2 X 1 80G FLAP WHEEL 	65042 2 X 1 80G FLAP WHEEL 	65050 3 X 1 80G FLAP WHEEL 	
65054 3/4 X 3/4 60G FLAP WHEEL 	65021 1 X 1 60G FLAP WHEEL 	65030 1-1/2 X 1 60G FLAP WHEEL 	65038 2 X 1 60G FLAP WHEEL 	65046 3 X 1 60G FLAP WHEEL 	
65053 3/4 X 3/4 40G FLAP WHEEL 	65023 1 X 1 40G FLAP WHEEL 	65032 1-1/2 X 1 40G FLAP WHEEL 	65037 2 X 1 40G FLAP WHEEL 	65045 3 X 1 40G FLAP WHEEL 	

PRODUCT CATEGORY: PA

### Flap Wheels

12 Items • 33 Pcs  
IBS No. 398R



Packaged in a Locking Steel Drawer  
for Easy Storage & Organization

IBS, Inc. SPECIALTY PRODUCTS FOR MAINTENANCE & REPAIR INDUSTRIALBOLT.COM • 800-878-1986				Roloc Style Surface Prep Discs with 1/4 Angle Air Die Grinder
				Assortment No. 501P
06521 2" Fine Surface Conditioning Disc 	06532 3" Medium Surface Conditioning Disc 	06535 3" Roloc Back Pad 	CA-14050 1/4 Angle Air Die Grinder 	
06522 2" Medium Surface Conditioning Disc 	06533 3" Coarse Surface Conditioning Disc 	06525 2" Roloc Back Pad 		
06523 2" Coarse Surface Conditioning Disc 		68024 3" 80 Grit Tapered Bristle Disc 		
09420 2" 80 Grit Zirconium Grinding Disc 	36699 3" 80 Grit Zirc Plus Grinding Disc 	68018 2" 50 Grit Tapered Bristle Disc 		
09415 2" 60 Grit Zirconium Grinding Disc 	36698 3" 60 Grit Zirc Plus Grinding Disc 	06531 3" Fine Surface Conditioning Disc 		
09410 2" 36 Grit Zirconium Grinding Disc 	36695 3" 36 Grit Zirc Plus Grinding Disc 			

PRODUCT CATEGORY: PA

### Roloc™ Style Surface Prep Discs with 1/4" Angle Air Die Grinder

17 Items • 64 Pcs  
IBS No. 501P



Packaged in a Locking Steel Drawer  
for Easy Storage & Organization

IBS, Inc. SPECIALTY PRODUCTS FOR MAINTENANCE & REPAIR INDUSTRIALBOLT.COM • 800-878-1986				Roloc Style Surface Prep Discs
				Assortment No. 504P
06521 2" Fine Surface Conditioning Disc 	06532 3" Medium Surface Conditioning Disc 	06535 3" Roloc Back Pad 		
06522 2" Medium Surface Conditioning Disc 	06533 3" Coarse Surface Conditioning Disc 	06525 2" Roloc Back Pad 		
06523 2" Coarse Surface Conditioning Disc 		68024 3" 80 Grit Tapered Bristle Disc 		
09420 2" 80 Grit Zirconium Grinding Disc 	36699 3" 80 Grit Zirc Plus Grinding Disc 	68018 2" 50 Grit Tapered Bristle Disc 		
09415 2" 60 Grit Zirconium Grinding Disc 	36698 3" 60 Grit Zirc Plus Grinding Disc 	06531 3" Fine Surface Conditioning Disc 		
09410 2" 36 Grit Zirconium Grinding Disc 	36695 3" 36 Grit Zirc Plus Grinding Disc 			

PRODUCT CATEGORY: PA

### 2" & 3" Roloc™ Surface Prep Assortment

16 Items • 66 Pcs  
IBS No. 504P



Packaged in a Locking Steel Drawer  
for Easy Storage & Organization



# IBS, INCORPORATED

## Assortments - Abrasives (PA)

ASSORTMENTS

 <b>IBS, Inc.</b> <small>SPECIALTY PRODUCTS FOR MAINTENANCE &amp; REPAIR          INDUSTRIALROLOTT.COM © © © 800-878-1906</small>				<b>Super Stripper Roloc™ Coating Removal Discs</b>				<small>Assortment No. 519P</small>			
<b>06525</b> 2 ROLOC BACKING PAD* 		<b>06535</b> 3 ROLOC BACKING PAD* 		<b>06545</b> 4 ROLOC BACKING PAD* 							
<b>06720</b> 2 ROLOC COATING REMOVAL DISC* 		<b>06730</b> 3 ROLOC COATING REMOVAL DISC* 		<b>06740</b> 4 ROLOC COATING REMOVAL DISC* 							

PRODUCT CATEGORY: PA

### Super Stripper Roloc™ Coating Removal Discs

6 Items • 15 Pcs  
IBS No. 519P



Packaged in a Locking Steel Drawer for Easy Storage & Organization

 <b>IBS, Inc.</b> <small>SPECIALTY PRODUCTS FOR MAINTENANCE &amp; REPAIR          INDUSTRIALROLOTT.COM © © © 800-878-1906</small>				<b>Roloc Surface Conditioning Discs</b>				<small>Assortment No. 523P</small>			
<b>06521</b> 2IN FINE ROLOC SURF COND DISC 		<b>06531</b> 3IN FINE ROLOC SURF COND DISC 		<b>06545</b> 4IN ROLOC BACKING PAD 							
<b>06522</b> 2IN MED ROLOC SURF COND DISC 		<b>06532</b> 3IN MED ROLOC SURF COND DISC 		<b>06542</b> 4IN MED ROLOC SURF COND DISC 							
<b>06523</b> 2IN CRS ROLOC SURF COND DISC 		<b>06533</b> 3IN CRS ROLOC SURF COND DISC 		<b>06543</b> 4IN CRS ROLOC SURF COND DISC 		<b>06535</b> 3IN ROLOC BACKING PAD 		<b>06525</b> 2IN ROLOC BACKING PAD 			











PRODUCT CATEGORY: PA

### Roloc™ Surface Conditioning Discs

11 Items • 56 Pcs  
IBS No. 523P



Packaged in a Locking Steel Drawer for Easy Storage & Organization

 <b>IBS, Inc.</b> <small>SPECIALTY PRODUCTS FOR MAINTENANCE &amp; REPAIR          INDUSTRIALROLOTT.COM © © © 800-878-1906</small>				<b>3" Roloc™ Total Surface Prep Discs</b>				<small>Assortment No. 529P</small>			
<b>40423</b> 3IN MED ROLOC X-TOUGH CERAMIC SURF DISC 		<b>40339</b> 3IN 80G ROLOC CERAMIC GRAIN GRIND DISC 		<b>38862</b> 3IN V FINE ROLOC HI STRENGTH SATIN DISC 		<b>06535</b> 3IN ROLOC BACKING PAD 					
<b>40422</b> 3IN CRS ROLOC X-TOUGH CERAMIC SURF DISC 		<b>40338</b> 3IN 60G ROLOC CERAMIC GRAIN GRIND DISC 		<b>38861</b> 3IN FINE ROLOC HI STRENGTH SATIN DISC 							
<b>06730</b> 3IN ROLOC SUPER STRIPPER COATING REMOVAL DISC 		<b>40335</b> 3IN 36G ROLOC CERAMIC GRAIN GRIND DISC 		<b>38860</b> 3IN MED ROLOC HI STRENGTH SATIN DISC 							

PRODUCT CATEGORY: PA

### 3" Roloc™ Total Surface Prep

10 Items • 58 Pcs  
IBS No. 529P



Packaged in a Locking Steel Drawer for Easy Storage & Organization

# IBS, INCORPORATED

## Assortments - Abrasives (PA)



**IBS, Inc.**  
SPECIALTY PRODUCTS FOR MAINTENANCE & REPAIR  
INDUSTRIALBOLTY.COM © © © 800-678-1906

Roloc Bristle Discs

Assortment No. 534P

<p>68018 2IN 50G TAPERED BRISTLE DISC ROLOC DISC GREEN 25000RPM</p>	<p>68025 3IN 50G TAPERED BRISTLE DISC ROLOC DISC GREEN 15000RPM</p>	<p>06535 3IN ROLOC BACKING PAD</p>	
<p>68017 2IN 80G TAPERED BRISTLE DISC ROLOC DISC YELLOW 25000RPM</p>	<p>68024 3IN 80G TAPERED BRISTLE DISC ROLOC DISC YELLOW 15000RPM</p>	<p>06525 2IN ROLOC BACKING PAD</p>	

PRODUCT CATEGORY: PA

### Roloc Bristle Discs & Backing Pads

6 Items • 12 Pcs  
IBS No. 534P



Packaged in a Locking Steel Drawer for Easy Storage & Organization

**IBS, Inc.**  
SPECIALTY PRODUCTS FOR MAINTENANCE & REPAIR  
INDUSTRIALBOLTY.COM © © © 800-678-1906

Trim-Kut Discs

Assortment No. 537P

<p>69336 3IN 36G MID ALLOY TRIM KUT DISC</p>	<p>69360 3IN 60G MID ALLOY TRIM-KUT DISC</p>	<p>69399 3IN 120G MID ALLOY TRIM-KUT DISC</p>	

PRODUCT CATEGORY: PA

### Trim-Kut Discs

4 Items • 76 Pcs  
IBS No. 537P



Packaged in a Locking Steel Drawer for Easy Storage & Organization

**IBS, Inc.**  
SPECIALTY PRODUCTS FOR MAINTENANCE & REPAIR  
INDUSTRIALBOLTY.COM © © © 800-678-1906

Roloc Surface Conditioning Discs w/ Angle Air Die Grinder

Assortment No. 541P

<p>06521 2 FINE ROLOC SURF COND DISC</p>	<p>06531 3 FINE ROLOC SURF COND DISC</p>	<p>40420 2 CRS ROLOC X-TOUGH CERAMIC</p>	<p>06535 3 ROLOC BACKING PAD</p>
<p>06522 2 MED ROLOC SURF COND DISC</p>	<p>06532 3 MED ROLOC SURF COND DISC</p>	<p>40421 2 MED ROLOC X-TOUGH CERAMIC</p>	
<p>06523 2 CRS ROLOC SURF COND DISC</p>	<p>06533 3 CRS ROLOC SURF COND DISC</p>	<p>40422 3 CRS ROLOC X-TOUGH CERAMIC</p>	<p>CA-14050 1/4 ANGLE AIR DIE GRINDER</p>
<p>06525 2 ROLOC BACKING PAD</p>	<p>40423 3 MED ROLOC X-TOUGH CERAMIC</p>		

PRODUCT CATEGORY: PA

### Roloc Surface Conditioning Discs with Angle Air Die Grinder

13 Items • 53 Pcs  
IBS No. 541P



Packaged in a Locking Steel Drawer for Easy Storage & Organization

ASSORTMENTS



# IBS, INCORPORATED

## Assortments - Abrasives (PA)

ASSORTMENTS

<b>IBS, Inc.</b> <small>SPECIALTY PRODUCTS FOR MAINTENANCE &amp; REPAIR  INDUSTRIALBOLT.COM © © © 800-678-1566</small>				Roloc Surface Conditioning Discs			
				Assortment No. 542P			
06521 2 FINE ROLOC SURF COND DISC 	06531 3 FINE ROLOC SURF COND DISC 	40420 2 CRS ROLOC X-TOUGH CERAMIC 	06535 3 ROLOC BACKING PAD 				
06522 2 MED ROLOC SURF COND DISC 		40421 2 MED ROLOC X-TOUGH CERAMIC 					
06523 2 CRS ROLOC SURF COND DISC 	06532 3 MED ROLOC SURF COND DISC 	40422 3 CRS ROLOC X-TOUGH CERAMIC 					
06525 2 ROLOC BACKING PAD 	06533 3 CRS ROLOC SURF COND DISC 	40423 3 MED ROLOC X-TOUGH CERAMIC 					

PRODUCT CATEGORY: PA

### Roloc Surface Conditioning Discs

12 Items • 52 Pcs  
**IBS No. 542P**



Packaged in a Locking Steel Drawer for Easy Storage & Organization

<b>IBS, Inc.</b> <small>SPECIALTY PRODUCTS FOR MAINTENANCE &amp; REPAIR  INDUSTRIALBOLT.COM © © © 800-678-1566</small>				2" & 3" Roloc Satin Discs			
				Assortment No. 546P			
38859 2" V FINE ROLOC HI STRENGTH 	38861 3" FINE ROLOC HI STRENGTH 	06535 3" ROLOC STYLE BACKING PAD 					
38858 2" FINE ROLOC HI STRENGTH 		06525 2" ROLOC STYLE BACKING PAD 					
38857 2" MED ROLOC HI STRENGTH 	38860 3" MED ROLOC HI STRENGTH 	38862 3" V FINE ROLOC HI STRENGTH 					

PRODUCT CATEGORY: O

### 2" & 3" Roloc Satin Discs

8 Items • 62 Pcs  
**IBS No. 546P**



Packaged in a Locking Steel Drawer for Easy Storage & Organization

<b>IBS, Inc.</b> <small>SPECIALTY PRODUCTS FOR MAINTENANCE &amp; REPAIR  INDUSTRIALBOLT.COM © © © 800-678-1566</small>				3" Roloc Grinding Discs			
				Assortment No. 548P			
09440 3 80G ROLOC ZIRC DISC* 	36699 3 80G ROLOC ZIRC+ GRINDING* 	40339 3 80G ROLOC CERAMIC GRAIN* 					
09435 3 60G ROLOC ZIRC DISC* 	36698 3 60G ROLOC ZIRC+ GRINDING* 	40338 3 60G ROLOC CERAMIC GRAIN* 					
09430 3 36G ROLOC ZIRC DISC* 	36695 3 36G ROLOC ZIRC+ GRINDING* 	40335 3 36G ROLOC CERAMIC GRAIN* 	06535 3 ROLOC BACKING PAD* 				

PRODUCT CATEGORY: PA

### 3" Roloc Grinding Discs

9 Items • 15 Pcs  
**IBS No. 548P**



Packaged in a Locking Steel Drawer for Easy Storage & Organization



# IBS, INCORPORATED

## Assortments - Abrasives (PA)



 <b>Stem Mounted Wire Brushes</b> 1/4" Shank Assortment No. 702R			
50074 1/2 .006 SOLID END BRUSH 1/4 SHANK 7/8 TRIM STEEL 	50078 1 .020 SOLID END BRUSH 1/4 SHANK 1-1/8 TRIM STEEL 	50066 3 .008 CIRCULAR FLARED END 1 SHANK CIRC CRIMP STEEL 	50067 1-1/2 .0118 CONFLX WIRE WHEEL 1/4" SHANK 
50077 3/4 .020 SOLID END BRUSH 1/4 SHANK 7/8 TRIM STEEL 	50065 1-1/2 FLARED END BRUSH 1/4 SHANK CIRC CRIMP STEEL 	04300 1-3/4 .006 WIRE CUP BRUSH 1/4 SHANK CRIMP 3/4 TRIM STEEL 	50069 3 .0118 CONFLX WIRE WHEEL 1/4 SHANK 

PRODUCT CATEGORY: PA

### Stem Mounted Wire Brushes

#### 1/4" SHANK

8 Items • 8 Pcs  
IBS No. 702R



Packaged in a Locking Steel Drawer for Easy Storage & Organization

 <b>Scratch Brushes</b> Assortment No. 703R	
50088 4 X 16 SHOE HANDLE SCRATCH BRUSH 	
50089 4 X 16 SS SHOE HANDLE SCRATCH BRUSH 	
50090 4 X 16 BRASS SHOE HANDLE SCRATCH BRUSH 	
50091 3 X 7 SS SMALL SCRATCH BRUSH 	50092 3 X 7 BRASS SMALL SCRATCH BRUSH 
50093 3 X 7 NYLON SMALL SCRATCH BRUSH 	44088 5/16 ACID BRUSH 
44089 3/8 ACID BRUSH 	44090 1/2 ACID BRUSH 













PRODUCT CATEGORY: PA

### Scratch Brushes

9 Items • 45 Pcs  
IBS No. 703R



Packaged in a Locking Steel Drawer for Easy Storage & Organization

 <b>Roloc™ Surface Conditioning Discs</b> 3/4" to 4" Assortment No. 705R			
06516 3/4 FINE ROLOC SURF COND DISC 	06521 2IN FINE ROLOC SURF COND DISC 	06531 3IN FINE ROLOC SURF COND DISC 	06542 4IN MED ROLOC SURF COND DISC 
06517 3/4 MED ROLOC SURF COND DISC 	06522 2IN MED ROLOC SURF COND DISC 	06532 3IN MED ROLOC SURF COND DISC 	
06518 3/4 CRS ROLOC SURF COND DISC 	06523 2IN CRS ROLOC SURF COND DISC 	06533 3IN CRS ROLOC SURF COND DISC 	06543 4IN CRS ROLOC SURF COND DISC 

PRODUCT CATEGORY: PA

### 3/4" - 4" Roloc Surface Conditioning Discs

11 Items • 49 Pcs  
IBS No. 705R



Packaged in a Locking Steel Drawer for Easy Storage & Organization

ASSORTMENTS



# IBS, INCORPORATED

## Assortments - Abrasives (PA)

ASSORTMENTS

<b>IBS, Inc.</b> <small>SPECIALTY PRODUCTS FOR MAINTENANCE &amp; REPAIR  INDUSTRIALBOLT.COM © © © 800-878-1506</small>				<b>Roloc™ Surface Conditioning Discs</b> 3/4" to 3"			
				<small>Assortment No. 707R</small>			
<b>06516</b> 3/4 FINE ROLOC SURF COND DISC  	<b>06517</b> 3/4 MED ROLOC SURF COND DISC  	<b>06518</b> 3/4 CRS ROLOC SURF COND DISC  	<b>06520</b> 3/4 ROLOC STYLE BACKING PAD  				
<b>06521</b> 2" FINE ROLOC SURF COND DISC  	<b>06522</b> 2" MED ROLOC STYLE SURF COND  	<b>06523</b> 2" CRS ROLOC STYLE SURF COND  	<b>06525</b> 2" ROLOC STYLE BACKING PAD  				
<b>06531</b> 3" FINE ROLOC SURF COND DISC  	<b>06532</b> 3" MED ROLOC STYLE SURF COND  	<b>06533</b> 3" CRS ROLOC STYLE SURF COND  	<b>06535</b> 3" ROLOC STYLE BACKING PAD  				

PRODUCT CATEGORY: PA

**Roloc Surface Conditioning Discs**  
3/4" to 3"  
**12 Items • 48 Pcs**  
**IBS No. 707R**



Packaged in a Locking Steel Drawer for Easy Storage & Organization

<b>IBS, Inc.</b> <small>SPECIALTY PRODUCTS FOR MAINTENANCE &amp; REPAIR  INDUSTRIALBOLT.COM © © © 800-878-1506</small>				<b>Flap Bands</b>			
				<small>Assortment No. 733R</small>			
<b>51022</b> 1-1/4 X 3/4 FLAP BAND 40G  	<b>51162</b> 1-3/4 X 1-3/16 FLAP BAND 40G  	<b>51262</b> 2-1/2 X 1-3/16 FLAP BAND 40G  					
<b>51024</b> 1-1/4 X 3/4 FLAP BAND 60G  	<b>51164</b> 1-3/4 X 1-3/16 FLAP BAND 60G  	<b>51264</b> 2-1/2 X 1-3/16 FLAP BAND 60G  					
<b>50950</b> 1-1/4 X 3/4 FLAP BAND RUBBER EXPANDING DRUM  	<b>50954</b> 1-3/4 X 1-3/16 FLAP BAND RUBBER EXPANDING DRUM  	<b>50956</b> 2-1/2 X 1-3/16 FLAP BAND RUBBER EXPANDING DRUM  					

PRODUCT CATEGORY: PA

**Flap Bands**  
**9 Items • 15 Pcs**  
**IBS No. 733R**



Packaged in a Locking Steel Drawer for Easy Storage & Organization

<b>IBS, Inc.</b> <small>SPECIALTY PRODUCTS FOR MAINTENANCE &amp; REPAIR  INDUSTRIALBOLT.COM © © © 800-878-1506</small>				<b>Flap Bands with Air Die Grinder w/Regulator</b>			
				<small>Assortment No. 734R</small>			
<b>51022</b> 1-1/4 X 3/4 FLAP BAND 40G  	<b>51162</b> 1-3/4 X 1-3/16 FLAP BAND 40G  	<b>51262</b> 2-1/2 X 1-3/16 FLAP BAND 40G  	<b>69283</b> 1/4 AIR DIE GRINDER W/REGULATOR  				
<b>51024</b> 1-1/4 X 3/4 FLAP BAND 60G  	<b>51164</b> 1-3/4 X 1-3/16 FLAP BAND 60G  	<b>51264</b> 2-1/2 X 1-3/16 FLAP BAND 60G  					
<b>50950</b> 1-1/4 X 3/4 FLAP BAND RUBBER EXPANDING DRUM  	<b>50954</b> 1-3/4 X 1-3/16 FLAP BAND RUBBER EXPANDING DRUM  	<b>50956</b> 2-1/2 X 1-3/16 FLAP BAND RUBBER EXPANDING DRUM  					

PRODUCT CATEGORY: PA

**Flap Bands with Air Die Grinder with Regulator**  
**9 Items • 15 Pcs**  
**IBS No. 734R**



Packaged in a Locking Steel Drawer for Easy Storage & Organization

# IBS, INCORPORATED

## Assortments - Abrasives (PA)



IBS, Inc. SPECIALTY PRODUCTS FOR MAINTENANCE & REPAIR INDUSTRIALBOLT.COM © © © 800-678-1506			2" & 3" Roloc Satin & Felt Discs	
Assortment No. 759R				
38857 2IN MED ROLOC HI STRENGTH SATIN DISC	38860 3IN MED ROLOC HI STRENGTH SATIN DISC	37755 2IN ROLOC MINI FELT FLAP DISC		
38858 2IN FINE ROLOC HI STRENGTH SATIN DISC	38861 3IN FINE ROLOC HI STRENGTH SATIN DISC	37757 3IN ROLOC MINI FELT FLAP DISC		
38859 2IN V FINE ROLOC HI STRENGTH SATIN DISC	38862 3IN V FINE ROLOC HI STRENGTH SATIN DISC	06525 2IN ROLOC BACKING PAD		
		06535 3IN ROLOC BACKING PAD		
		74206 GRAY POLISHING COMPOUND FOR FELT DISCS		

### 2" & 3" Satin & Felt Discs

12 Items • 52 Pcs  
IBS No. 759R

Packaged in a Locking Steel Drawer for Easy Storage & Organization

PRODUCT CATEGORY: PA

IBS, Inc. SPECIALTY PRODUCTS FOR MAINTENANCE & REPAIR INDUSTRIALBOLT.COM © © © 800-678-1506			Surface Conditioning Bands	
Assortment No. 774R				
51029 1/2 X 1/2 SURFACE CONDITIONING BAND COARSE	51034 1 X 1 SURFACE CONDITIONING BAND COARSE	51039 1-1/2 X 1 SURFACE CONDITIONING BAND COARSE		
51030 1/2 X 1/2 SURFACE CONDITIONING BAND MEDIUM	51035 1 X 1 SURFACE CONDITIONING BAND MEDIUM	51040 1-1/2 X 1 SURFACE CONDITIONING BAND MEDIUM		
51031 1/2 X 1/2 SURFACE CONDITIONING BAND VERY FINE	51036 1 X 1 SURFACE CONDITIONING BAND VERY FINE	51041 1-1/2 X 1 SURFACE CONDITIONING BAND VERY FINE		
51032 1/2 X 1/2 SURFACE CONDITIONING BAND DRUM	51037 1 X 1 SURFACE CONDITIONING BAND DRUM	51042 1-1/2 X 1 SURFACE CONDITIONING BAND DRUM		

### Surface Conditioning Bands

12 Items • 40 Pcs  
IBS No. 774R

Packaged in a Locking Steel Drawer for Easy Storage & Organization

PRODUCT CATEGORY: PA

IBS, Inc. SPECIALTY PRODUCTS FOR MAINTENANCE & REPAIR INDUSTRIALBOLT.COM © © © 800-678-1506			TriFlex Quick Change Discs	
Assortment No. 795R				
40351 2" 24G TRIFLEX QUICK CHANGE DISC	40352 2" 36G TRIFLEX QUICK CHANGE DISC	40353 2" 54G TRIFLEX QUICK CHANGE DISC		
40354 2" 80G TRIFLEX QUICK CHANGE DISC	40355 2" 120G TRIFLEX QUICK CHANGE DISC	06525 2 ROLOC BACKING PAD*		
40356 3" 24G TRIFLEX QUICK CHANGE DISC	40357 3" 36G TRIFLEX QUICK CHANGE DISC	40358 3" 54G TRIFLEX QUICK CHANGE DISC		
40359 3" 80G TRIFLEX QUICK CHANGE DISC	40360 3" 120G TRIFLEX QUICK CHANGE DISC	06535 3 ROLOC BACKING PAD*		

### Tri-Flex Quick Change Disc Assortment

12 Items • 34 Pcs  
IBS No. 795R

Packaged in a Locking Steel Drawer for Easy Storage & Organization

PRODUCT CATEGORY: PA

ASSORTMENTS



# IBS, INCORPORATED

## Assortments - Abrasives (PA)

ASSORTMENTS

**IBS, Inc.**  
SPECIALTY PRODUCTS FOR MAINTENANCE & REPAIR  
INDUSTRIALBOLTY.COM © © © 800-678-1506

Power Tube Brushes

Assortment 816R

50080 3/8" .006 POWER TUBE BRUSH	50081 1/2" .006 POWER TUBE BRUSH	50082 5/8" .005 POWER TUBE BRUSH	50083 3/4" .006 POWER TUBE BRUSH	50084 1" .006 POWER TUBE BRUSH	50085 1-1/4" .0104 POWER TUBE BRUSH
-------------------------------------	-------------------------------------	-------------------------------------	-------------------------------------	-----------------------------------	--

**Power Tube Brushes**  
6 Items • 6 Pcs  
IBS No. 816R



Packaged in a Locking Steel Drawer for Easy Storage & Organization

PRODUCT CATEGORY: PA

**IBS, Inc.**  
SPECIALTY PRODUCTS FOR MAINTENANCE & REPAIR  
INDUSTRIALBOLTY.COM © © © 800-678-1506

SilverBack Roloc Disc

Assortment No. 821R

50016 2IN 40G ROLOC SILVERBACK FLAP DISC	50017 2IN 60G ROLOC SILVERBACK FLAP DISC	50018 2IN 80G ROLOC SILVERBACK FLAP DISC	50019 2IN 120G ROLOC SILVERBACK FLAP DISC
50020 3IN 40G ROLOC SILVERBACK FLAP DISC	50021 3IN 60G ROLOC SILVERBACK FLAP DISC	50022 3IN 80G ROLOC SILVERBACK FLAP DISC	50023 3IN 120G ROLOC SILVERBACK FLAP DISC
06525 2IN ROLOC BACKING PAD	06535 3IN ROLOC BACKING PAD		

**Silverback Roloc Discs**  
10 Items • 22 Pcs  
IBS No. 821R



Packaged in a Locking Steel Drawer for Easy Storage & Organization

PRODUCT CATEGORY: PA

**IBS, Inc.**  
SPECIALTY PRODUCTS FOR MAINTENANCE & REPAIR  
INDUSTRIALBOLTY.COM © © © 800-678-1506

Solid Roloc Ceramic+ Grinding Discs

Assortment No. 827R

36600 2IN 36G SOLID ROLOC CERAMIC+ GRINDING DISC	36602 2IN 60G SOLID ROLOC CERAMIC+ GRINDING DISC	36603 2IN 80G SOLID ROLOC CERAMIC+ GRINDING DISC	36605 2IN 120G SOLID ROLOC CERAMIC+ GRINDING DISC
36607 3IN 36G SOLID ROLOC CERAMIC+ GRINDING DISC	36609 3IN 60G SOLID ROLOC CERAMIC+ GRINDING DISC	36610 3IN 80G SOLID ROLOC CERAMIC+ GRINDING DISC	36612 3IN 120G SOLID ROLOC CERAMIC+ GRINDING DISC
06525 2IN ROLOC BACKING PAD	06535 3IN ROLOC BACKING PAD		

**Solid Roloc Ceramic + Grinding Discs**  
10 Items • 42 Pcs  
IBS No. 827R



Packaged in a Locking Steel Drawer for Easy Storage & Organization

PRODUCT CATEGORY: PA

# IBS, INCORPORATED

## Assortments - Abrasives (PA)



 <b>Solid Roloc Zirconia+ Grinding Discs</b>			
Assortment No. 828R			
36620 2IN 36G SOLID ROLOC ZIRC+ GRINDING DISC 	36622 2IN 60G SOLID ROLOC ZIRC+ GRINDING DISC 	36623 2IN 80G SOLID ROLOC ZIRC+ GRINDING DISC 	36625 2IN 120G SOLID ROLOC ZIRC+ GRINDING DISC 
36627 3IN 36G SOLID ROLOC ZIRC+ GRINDING DISC 	36629 3IN 60G SOLID ROLOC ZIRC+ GRINDING DISC 	36630 3IN 80G SOLID ROLOC ZIRC+ GRINDING DISC 	36632 3IN 120G SOLID ROLOC ZIRC+ GRINDING DISC 
06525 2IN ROLOC BACKING PAD 	06535 3IN ROLOC BACKING PAD 		







PRODUCT CATEGORY: PA

### Solid Roloc Zirconia+ Grinding Discs

10 Items • 42 Pcs  
IBS No. 828R



Packaged in a Locking Steel Drawer for Easy Storage & Organization

 <b>Stem Thread Brushes</b>				
Assortment No. 839R				
50031 3/8" Ø12 1/4 STEM THREAD BRUSH COATED STEEL 	50032 1/2" Ø12 1/4 STEM THREAD BRUSH COATED STEEL 	50033 5/8" Ø12 1/4 STEM THREAD BRUSH COATED STEEL 	50034 3/4" Ø12 1/4 STEM THREAD BRUSH COATED STEEL 	50095 7/8" Ø12 1/4 STEM THREAD BRUSH COATED STEEL 















PRODUCT CATEGORY: PA

### Stem Thread Cleaning Brushes

5 Items • 5 Pcs  
IBS No. 839R



Packaged in a Locking Steel Drawer for Easy Storage & Organization

 <b>Ceramic Roloc Flex Flap and Mini Flap Discs</b>			
Assortment No. 841R			
67340 3IN 40GRIT CERAMIC FLEX FLAP ROLOC 	67360 3IN 60GRIT CERAMIC FLEX FLAP ROLOC 	67380 3IN 80GRIT CERAMIC FLEX FLAP ROLOC 	
64340 3IN 40GRIT CERAMIC MINI FLAP ROLOC 	64360 3IN 60GRIT CERAMIC MINI FLAP ROLOC 	64380 3IN 80GRIT CERAMIC MINI FLAP ROLOC 	
67240 2IN 40GRIT CERAMIC FLEX FLAP ROLOC 	67260 2IN 60GRIT CERAMIC FLEX FLAP ROLOC 	67280 2IN 80GRIT CERAMIC FLEX FLAP ROLOC 	06535 3IN ROLOC BACKING PAD 
64240 2IN 40GRIT CERAMIC MINI FLAP ROLOC 	64260 2IN 60GRIT CERAMIC MINI FLAP ROLOC 	64280 2IN 80GRIT CERAMIC MINI FLAP ROLOC 	06525 2IN ROLOC BACKING PAD 

PRODUCT CATEGORY: PA

### Ceramic Roloc Flex Flap & Mini Flap Discs

14 Items • 30 Pcs  
IBS No. 841R



Packaged in a Locking Steel Drawer for Easy Storage & Organization

ASSORTMENTS



# IBS, INCORPORATED

## Assortments - Abrasives (PA)



Sanding Belts  
1/2 x 18

Assortment No. 848R

35036 1/2 X 18 36G ZIRC+ SANDING BELT	
35060 1/2 X 18 60G ZIRC+ SANDING BELT	
35080 1/2 X 18 80G ZIRC+ SANDING BELT	35120 1/2 X 18 120G ZIRC+ SANDING BELT
35001 1/2 X 18 SURFACE CONDITIONING MATERIAL SANDING BELT COARSE	
35002 1/2 X 18 SURFACE CONDITIONING MATERIAL SANDING BELT MEDIUM	
35003 1/2 X 18 SURFACE CONDITIONING MATERIAL SANDING BELT VERY FINE	

PRODUCT CATEGORY: PA

**Sanding Belt Assortment**  
7 Items • 35 Pcs  
IBS No. 848R



**Packaged in a Locking Steel Drawer  
for Easy Storage & Organization**

A  
S  
S  
O  
R  
T  
M  
E  
N  
T  
S

# IBS, INCORPORATED

## Assortments - Taps, Burs & Blades (PT)



Special Purpose Reciprocating Saw Blades	
Assortment No. 393R	
<b>44906</b> 9 X 3/4 6TPI RECIP BIMETAL Wood, nail-embedded wood, compositions, plastic, cast aluminum, light gauge metals.	
<b>45699</b> 6 TUNGSTEN CARBIDE GRIT RECIP BLADE Cutting fiberglass, lathe, plaster, ceramics, laminates, marble and hardened steel.	<b>45899</b> 8 TUNGSTEN CARBIDE GRIT RECIP BLADE Cutting fiberglass, lathe, plaster, ceramics, laminates, marble and hardened steel.
<b>460906</b> 9 X .062 6TPI DEMOLITION BIMETAL RECIP BLADE Specially designed for the toughest demolition jobs. Cuts all woods, nail-embedded wood and metals.	
<b>461206</b> 12 X .062 6TPI DEMOLITION BIMETAL RECIP BLADE Specially designed for the toughest demolition jobs. Cuts all woods, nail-embedded wood and metals.	
<b>460910</b> 9 X .062 10TPI DEMOLITION BIMETAL RECIP BLADE Specially designed for the toughest demolition jobs. Cuts all woods, nail-embedded wood and metals.	
<b>461210</b> 12 X .062 10TPI DEMOLITION BIMETAL RECIP BLADE Specially designed for the toughest demolition jobs. Cuts all woods, nail-embedded wood and metals.	

PRODUCT CATEGORY: PA

### Special Purpose Reciprocating Saw Blades

7 items • 14 Pcs  
IBS No. 393R

Packaged in a Locking Steel Drawer for Easy Storage & Organization

Hi-Alloy Reciprocating Saw Blades	
Assortment No. 512P	
<b>441206</b> 12' 6TPI HI ALLOY RECIP BLADE Wood, nail-embedded wood, compositions plastic, cast aluminum, light gauge metals.	
<b>4481014</b> 8' 10-14TPI HI ALLOY RECIP BLADE All woods, plastic, cast aluminum, nail-embedded wood, soil pipe.	<b>44624</b> 6' 24TPI HI ALLOY RECIP BLADE Metal, 18 gauge and under. Trim & tubing. Galvanized pipe under 18 gauge.
<b>44614</b> 6' 14TPI HI ALLOY RECIP BLADE Heavy gauge metals 1/8" thick and above. Barstock and angles.	<b>44618</b> 6' 18TPI HI ALLOY RECIP BLADE Heavy gauge metals of 18 gauge to 1/8" thick conduit, pipe, channels and tubing.
<b>44610</b> 6' 10TPI HI ALLOY RECIP BLADE Wood, nail-embedded wood, compositions plastic, cast aluminum, light gauge metals.	<b>4461014</b> 6' 10-14TPI HI ALLOY RECIP All woods, plastic, cast aluminum, nail-embedded wood, soil pipe.
<b>44606</b> 6' 6TPI HI ALLOY RECIP BLADE Wood, nail-embedded wood, compositions plastic, cast aluminum, light gauge metals.	<b>44656</b> 6' 6TPI HI ALLOY RECIP BLADE Plaster with metal lathe plaster board, sheet rock, plaster walls. tooth design cuts both forward and on backward stroke.
<b>44414</b> 4' 14TPI HI ALLOY RECIP BLADE Heavy gauge metals 1/8" thick and above. Barstock and angles.	<b>44418</b> 4' 18TPI HI ALLOY RECIP BLADE Heavy gauge metals of 18 gauge to 1/8" thick conduit, pipe, channels and tubing.
<b>44424</b> 4' 24TPI HI ALLOY RECIP BLADE Metal, 18 gauge and under. Trim & tubing. Galvanized pipe under 18 gauge.	

PRODUCT CATEGORY: PA

### Hi-Alloy Reciprocating Saw Blades

12 items • 60 Pcs  
IBS No. 512P



Packaged in a Locking Steel Drawer for Easy Storage & Organization

Nitro-Carb Power Taps, Hex Dies and Drill Bits with Tools																									
Assortment No. 591P																									
<b>120922</b> Professional Tap Wrench	<b>120925</b> Professional 1" Hex Die Wrench																								
<table border="1"> <tr> <td> <b>129913</b>                              HSS Hex Die                         </td> <td> <b>129922</b>                              HSS Hex Die                         </td> </tr> <tr> <td> <b>17643</b>                              Nitro-Carb Power Tap                         </td> <td> <b>17644</b>                              Nitro-Carb Power Tap                         </td> </tr> <tr> <td> <b>16823</b>                              27/64 Drill Bit                         </td> <td> <b>16825</b>                              29/64 Drill bit                         </td> </tr> </table>	<b>129913</b> HSS Hex Die	<b>129922</b> HSS Hex Die	<b>17643</b> Nitro-Carb Power Tap	<b>17644</b> Nitro-Carb Power Tap	<b>16823</b> 27/64 Drill Bit	<b>16825</b> 29/64 Drill bit	<table border="1"> <tr> <td> <b>129912</b>                              HSS Hex Die                         </td> <td> <b>129921</b>                              HSS Hex Die                         </td> </tr> <tr> <td> <b>17641</b>                              Nitro-Carb Power Tap                         </td> <td> <b>17642</b>                              Nitro-Carb Power Tap                         </td> </tr> <tr> <td> <b>16820</b>                              3/8 Drill Bit                         </td> <td> <b>16821</b>                              25/64 Drill Bit                         </td> </tr> </table>	<b>129912</b> HSS Hex Die	<b>129921</b> HSS Hex Die	<b>17641</b> Nitro-Carb Power Tap	<b>17642</b> Nitro-Carb Power Tap	<b>16820</b> 3/8 Drill Bit	<b>16821</b> 25/64 Drill Bit												
<b>129913</b> HSS Hex Die	<b>129922</b> HSS Hex Die																								
<b>17643</b> Nitro-Carb Power Tap	<b>17644</b> Nitro-Carb Power Tap																								
<b>16823</b> 27/64 Drill Bit	<b>16825</b> 29/64 Drill bit																								
<b>129912</b> HSS Hex Die	<b>129921</b> HSS Hex Die																								
<b>17641</b> Nitro-Carb Power Tap	<b>17642</b> Nitro-Carb Power Tap																								
<b>16820</b> 3/8 Drill Bit	<b>16821</b> 25/64 Drill Bit																								
<table border="1"> <tr> <td> <b>129910</b>                              HSS Hex Die                         </td> <td> <b>129919</b>                              HSS Hex Die                         </td> <td> <b>129911</b>                              HSS Hex Die                         </td> <td> <b>129920</b>                              HSS Hex Die                         </td> </tr> <tr> <td> <b>17637</b>                              Nitro-Carb Power Tap                         </td> <td> <b>17638</b>                              Nitro-Carb Power Tap                         </td> <td> <b>17639</b>                              Nitro-Carb Power Tap                         </td> <td> <b>17640</b>                              Nitro-Carb Power Tap                         </td> </tr> <tr> <td> <b>16141</b>                              "G" Drill Bit                         </td> <td> <b>16143</b>                              "I" Drill Bit                         </td> <td> <b>16149</b>                              "O" Drill Bit                         </td> <td> <b>16152</b>                              "F" Drill Bit                         </td> </tr> </table>	<b>129910</b> HSS Hex Die	<b>129919</b> HSS Hex Die	<b>129911</b> HSS Hex Die	<b>129920</b> HSS Hex Die	<b>17637</b> Nitro-Carb Power Tap	<b>17638</b> Nitro-Carb Power Tap	<b>17639</b> Nitro-Carb Power Tap	<b>17640</b> Nitro-Carb Power Tap	<b>16141</b> "G" Drill Bit	<b>16143</b> "I" Drill Bit	<b>16149</b> "O" Drill Bit	<b>16152</b> "F" Drill Bit	<table border="1"> <tr> <td> <b>129917</b>                              HSS Hex Die                         </td> <td> <b>129908</b>                              HSS Hex Die                         </td> <td> <b>129909</b>                              HSS Hex Die                         </td> <td> <b>129918</b>                              HSS Hex Die                         </td> </tr> <tr> <td> <b>17633</b>                              Nitro-Carb Power Tap                         </td> <td> <b>17634</b>                              Nitro-Carb Power Tap                         </td> <td> <b>17635</b>                              Nitro-Carb Power Tap                         </td> <td> <b>17636</b>                              Nitro-Carb Power Tap                         </td> </tr> <tr> <td> <b>16099</b>                              #20 Drill Bit                         </td> <td> <b>16095</b>                              #16 Drill Bit                         </td> <td> <b>16086</b>                              #7 Drill Bit                         </td> <td> <b>16082</b>                              #3 Drill Bit                         </td> </tr> </table>	<b>129917</b> HSS Hex Die	<b>129908</b> HSS Hex Die	<b>129909</b> HSS Hex Die	<b>129918</b> HSS Hex Die	<b>17633</b> Nitro-Carb Power Tap	<b>17634</b> Nitro-Carb Power Tap	<b>17635</b> Nitro-Carb Power Tap	<b>17636</b> Nitro-Carb Power Tap	<b>16099</b> #20 Drill Bit	<b>16095</b> #16 Drill Bit	<b>16086</b> #7 Drill Bit	<b>16082</b> #3 Drill Bit
<b>129910</b> HSS Hex Die	<b>129919</b> HSS Hex Die	<b>129911</b> HSS Hex Die	<b>129920</b> HSS Hex Die																						
<b>17637</b> Nitro-Carb Power Tap	<b>17638</b> Nitro-Carb Power Tap	<b>17639</b> Nitro-Carb Power Tap	<b>17640</b> Nitro-Carb Power Tap																						
<b>16141</b> "G" Drill Bit	<b>16143</b> "I" Drill Bit	<b>16149</b> "O" Drill Bit	<b>16152</b> "F" Drill Bit																						
<b>129917</b> HSS Hex Die	<b>129908</b> HSS Hex Die	<b>129909</b> HSS Hex Die	<b>129918</b> HSS Hex Die																						
<b>17633</b> Nitro-Carb Power Tap	<b>17634</b> Nitro-Carb Power Tap	<b>17635</b> Nitro-Carb Power Tap	<b>17636</b> Nitro-Carb Power Tap																						
<b>16099</b> #20 Drill Bit	<b>16095</b> #16 Drill Bit	<b>16086</b> #7 Drill Bit	<b>16082</b> #3 Drill Bit																						
<table border="1"> <tr> <td> <b>129904</b>                              HSS Hex Die                         </td> <td> <b>129905</b>                              HSS Hex Die                         </td> <td> <b>129906</b>                              HSS Hex Die                         </td> <td> <b>129907</b>                              HSS Hex Die                         </td> </tr> <tr> <td> <b>17629</b>                              Nitro-Carb Power Tap                         </td> <td> <b>17630</b>                              Nitro-Carb Power Tap                         </td> <td> <b>17631</b>                              Nitro-Carb Power Tap                         </td> <td> <b>17632</b>                              Nitro-Carb Power Tap                         </td> </tr> <tr> <td> <b>16122</b>                              #43 Drill Bit                         </td> <td> <b>16113</b>                              #34 Drill Bit                         </td> <td> <b>16108</b>                              #29 Drill Bit                         </td> <td> <b>16102</b>                              #23 Drill Bit                         </td> </tr> </table>	<b>129904</b> HSS Hex Die	<b>129905</b> HSS Hex Die	<b>129906</b> HSS Hex Die	<b>129907</b> HSS Hex Die	<b>17629</b> Nitro-Carb Power Tap	<b>17630</b> Nitro-Carb Power Tap	<b>17631</b> Nitro-Carb Power Tap	<b>17632</b> Nitro-Carb Power Tap	<b>16122</b> #43 Drill Bit	<b>16113</b> #34 Drill Bit	<b>16108</b> #29 Drill Bit	<b>16102</b> #23 Drill Bit													
<b>129904</b> HSS Hex Die	<b>129905</b> HSS Hex Die	<b>129906</b> HSS Hex Die	<b>129907</b> HSS Hex Die																						
<b>17629</b> Nitro-Carb Power Tap	<b>17630</b> Nitro-Carb Power Tap	<b>17631</b> Nitro-Carb Power Tap	<b>17632</b> Nitro-Carb Power Tap																						
<b>16122</b> #43 Drill Bit	<b>16113</b> #34 Drill Bit	<b>16108</b> #29 Drill Bit	<b>16102</b> #23 Drill Bit																						

PRODUCT CATEGORY: PT

### Nitro-Carb Power Taps, Hex Dies & Drill Bits with Tools

12 items • 50 Pcs  
IBS No. 591P



Packaged in a Locking Steel Drawer for Easy Storage & Organization



# IBS, INCORPORATED

## Assortments - Taps, Burs & Blades (PT)

ASSORTMENTS

<b>IBS, Inc.</b> <small>SPECIALTY PRODUCTS FOR MAINTENANCE &amp; REPAIR          INDUSTRIALBOLT.COM • 800-878-1906</small>		<b>Nitro-Carb Plug/Power Taps, Hex Dies          and Drill Bits with Tools</b>	
Assortment No. 592P			
<p>120923 Professional Tap Wrench</p>		<p>120926 Professional 1-7/16" Hex Die Wrench</p>	
<p>129916 3/4-10 HSS Hex Die 17649 Nitro-Carb Power Tap 16842 21/32 Drill Bit</p>	<p>129925 3/4-16 HSS Hex Die 17650 Nitro-Carb Power Tap 16844 11/16 Drill bit</p>	<p>129915 5/8-11 HSS Hex Die 17647 Nitro-Carb Power Tap 16834 17/32 Drill Bit</p>	<p>129924 5/8-18 HSS Hex Die 17648 Nitro-Carb Power Tap 16836 9/16 Drill bit</p>
<p>129914 9/16-12 HSS Hex Die 17645 Nitro-Carb Plug Tap 16827 31/64 Drill Bit</p>	<p>129923 9/16-18 HSS Hex Die 17646 Nitro-Carb Plug Tap 16828 1/2 Drill bit</p>		

PRODUCT CATEGORY: PT

**Nitro-Carb Power  
Taps, Hex Dies & Drill  
Bits with Tools**  
 18 items • 20 Pcs  
**IBS No. 592P**



Packaged in a Locking Steel Drawer  
for Easy Storage & Organization

<b>IBS, Inc.</b> <small>SPECIALTY PRODUCTS FOR MAINTENANCE &amp; REPAIR          INDUSTRIALBOLT.COM • 800-878-1906</small>		<b>Hi-Alloy Reciprocating Saw Blades</b>	
Assortment No. 512P			
<p>441206 12" 6TPI HI ALLOY RECIP BLADE Wood, nail-embedded wood, compositions plastic, cast aluminum, light gauge metals.</p>		<p>44624 6" 24TPI HI ALLOY RECIP BLADE Metal, 18 gauge and under. Trim &amp; tubing. Galvanized pipe under 18 gauge.</p>	
<p>4481014 8" 10-14TPI HI ALLOY RECIP BLADE All woods, plastic, cast aluminum, nail-embedded wood, soil pipe.</p>		<p>44618 6" 18TPI HI ALLOY RECIP BLADE Heavy gauge metals of 18 gauge to 1/8" thick conduit, pipe, channels and tubing.</p>	
<p>44614 6" 14TPI HI ALLOY RECIP BLADE Heavy gauge metals 1/8" thick and above. Barstock and angles.</p>		<p>4461014 6" 10-14TPI HI ALLOY RECIP All woods, plastic, cast aluminum, nail-embedded wood, soil pipe.</p>	
<p>44610 6" 10TPI HI ALLOY RECIP BLADE Wood, nail-embedded wood, compositions plastic, cast aluminum, light gauge metals.</p>		<p>44656 6" 6TPI HI ALLOY RECIP BLADE Plaster with metal lathe plaster board, sheet rock, plaster walls. tooth design cuts both forward and on backward stroke.</p>	
<p>44414 4" 14TPI HI ALLOY RECIP BLADE Heavy gauge metals 1/8" thick and above. Barstock and angles.</p>		<p>44418 4" 18TPI HI ALLOY RECIP BLADE Heavy gauge metals of 18 gauge to 1/8" thick conduit, pipe, channels and tubing.</p>	
<p>44424 4" 24TPI HI ALLOY RECIP BLADE Metal, 18 gauge and under. Trim &amp; tubing. Galvanized pipe under 18 gauge.</p>			

PRODUCT CATEGORY: PT

**Metric Nitro-Carb  
Power Taps, Hex Dies  
& Drill Bits with Tools**  
 29 items • 29 Pcs  
**IBS No. 593P**



Packaged in a Locking Steel Drawer  
for Easy Storage & Organization

<b>IBS, Inc.</b> <small>SPECIALTY PRODUCTS FOR MAINTENANCE &amp; REPAIR          INDUSTRIALBOLT.COM • 800-878-1906</small>		<b>Maxi-Sharp Files</b>	
Assortment No. 699R			
<p>65018-10 10 MAXI-SHARP ALL PURPOSE</p>		<p>65019-10 10 MAXI-SHARP FLAT MULTI-KUT</p>	
<p>65001-10 10 MAXI-SHARP FLAT FILE</p>		<p>65003-10 10 MAXI-SHARP 1/2 RD FILE</p>	
<p>65000-10 10 MAXI-SHARP MILL FILE</p>			
<p>65002-10 10 MAXI-SHARP ROUND FILE</p>			
<p>65004-6 6 MAXI-SHARP TAPER FILE SLIM</p>		<p>65008-6 6 SCRUIZ-ON FILE HANDLE</p>	
<p>65009 FILE CARD WITH BRUSH</p>		<p>65008-10 10 SCRUIZ-ON FILE HANDLE</p>	

PRODUCT CATEGORY: PT

**Maxi Sharp Files**  
 10 items • 12 Pcs  
**IBS No. 699R**



Packaged in a Locking Steel Drawer  
for Easy Storage & Organization



# IBS, INCORPORATED















## Assortments - Taps, Burs & Blades (PT)



**IBS, Inc.**  
SPECIALTY PRODUCTS FOR MAINTENANCE & REPAIR  
INDUSTRIALBOLT.COM • • • 800-675-1506

**Advanced Bi-Metal Hole Saws**  
5/8" to 2"

Assortment No. 729R









29201 5/8 HOLE SAW ADVANCED EDGE 	29209 1-1/8 HOLE SAW ADVANCED EDGE 	29217 1-5/8 HOLE SAW ADVANCED EDGE 	29036 LSS 4 H.S. ARBOR 
29203 3/4 HOLE SAW ADVANCED EDGE 	29211 1-1/4 HOLE SAW ADVANCED EDGE 	29219 1-3/4 HOLE SAW ADVANCED EDGE 	29034 LSS 2 H.S. ARBOR 
29205 7/8 HOLE SAW ADVANCED EDGE 	29213 1-3/8 HOLE SAW ADVANCED EDGE 	29222 2" HOLE SAW ADVANCED EDGE 	29039 1/4 PILOT DRILL 
29207 1" HOLE SAW ADVANCED EDGE 	29215 1-1/2 HOLE SAW ADVANCED EDGE 		

PRODUCT CATEGORY: PT

**IBS, Inc.**  
SPECIALTY PRODUCTS FOR MAINTENANCE & REPAIR  
INDUSTRIALBOLT.COM • • • 800-675-1506

**Advanced Bi-Metal Hole Saws**  
2-1/8" to 4"

Assortment No. 730R



















29224 2-1/8 HOLE SAW ADVANCED EDGE 	29228 2-1/2 HOLE SAW ADVANCED EDGE 	29237 3-1/2 HOLE SAW ADVANCED EDGE 	29034 LSS 2 H.S. ARBOR 
29225 2-1/4 HOLE SAW ADVANCED EDGE 	29233 3" HOLE SAW ADVANCED EDGE 	29241 4" HOLE SAW ADVANCED EDGE 	29039 1/4 PILOT DRILL 

PRODUCT CATEGORY: PT

**IBS, Inc.**  
SPECIALTY PRODUCTS FOR MAINTENANCE & REPAIR  
INDUSTRIALBOLT.COM • • • 800-675-1506

**Advanced Bi-Metal Hole Saws**  
3/4" to 4"

Assortment No. 731R

29203 3/4 HOLE SAW ADVANCED EDGE 	29217 1-5/8 HOLE SAW ADVANCED EDGE 	29225 2-1/4 HOLE SAW ADVANCED EDGE 	29237 3-1/2 HOLE SAW ADVANCED EDGE 
29207 1" HOLE SAW ADVANCED EDGE 	29219 1-3/4 HOLE SAW ADVANCED EDGE 	29228 2-1/2 HOLE SAW ADVANCED EDGE 	29241 4" HOLE SAW ADVANCED EDGE 
29209 1-1/8 HOLE SAW ADVANCED EDGE 	29222 2" HOLE SAW ADVANCED EDGE 	29233 3" HOLE SAW ADVANCED EDGE 	29036 LSS 4 H.S. ARBOR 
29211 1-1/4 HOLE SAW ADVANCED EDGE 	29224 2-1/8 HOLE SAW ADVANCED EDGE 		29034 LSS 2 H.S. ARBOR 
29213 1-3/8 HOLE SAW ADVANCED EDGE 			29039 1/4 PILOT DRILL 
29215 1-1/2 HOLE SAW ADVANCED EDGE 			

PRODUCT CATEGORY: PT

**Advanced Bi-Metal Hole Saws**  
5/8" to 2"  
14 items • 15 Pcs  
IBS No. 729R



Packaged in a Locking Steel Drawer for Easy Storage & Organization

**Advanced Bi-Metal Hole Saws**  
2-1/8" to 4"  
8 Items • 8 Pcs  
IBS No. 730R



Packaged in a Locking Steel Drawer for Easy Storage & Organization

**Advanced Bi-Metal Hole Saws**  
3/4" to 4"  
18 Items • 19 Pcs  
IBS No. 731R



Packaged in a Locking Steel Drawer for Easy Storage & Organization

A  
S  
S  
O  
R  
T  
M  
E  
N  
T  
S



# IBS, INCORPORATED

## Assortments - Taps, Burs & Blades (PT)

ASSORTMENTS

<b>IBS, Inc.</b> <small>SPECIALTY PRODUCTS FOR MAINTENANCE &amp; REPAIR  INDUSTRIALBOLT.COM • 800-678-1906</small>				<b>Carbide Tipped Cutters</b> 3/16" Depth Assortment No. 762R			
19205 7/8 CARBIDE TIPPED CUTTER - 3/16" DEPTH 	19209 1-1/8 CARBIDE TIPPED CUTTER - 3/16" DEPTH 	19213 1-3/8 CARBIDE TIPPED CUTTER - 3/16" DEPTH 	19219 1-3/4 CARBIDE TIPPED CUTTER - 3/16" DEPTH 				
19223 2" CARBIDE TIPPED CUTTER - 3/16" DEPTH 							

PRODUCT CATEGORY: PT

### Carbide Tipped Cutters

1" Depth

5 Items • 5 Pcs  
**IBS No. 762R**



Packaged in a Locking Steel Drawer for Easy Storage & Organization

<b>IBS, Inc.</b> <small>SPECIALTY PRODUCTS FOR MAINTENANCE &amp; REPAIR  INDUSTRIALBOLT.COM • 800-678-1906</small>				<b>Carbide Tipped Cutters</b> 1" Depth Assortment No. 763R			
19250 5/8 CARBIDE TIPPED CUTTER - 1" DEPTH 	19252 3/4 CARBIDE TIPPED CUTTER - 1" DEPTH 	19254 7/8 CARBIDE TIPPED CUTTER - 1" DEPTH 	19256 1" CARBIDE TIPPED CUTTER - 1" DEPTH 				

PRODUCT CATEGORY: PT

### Carbide Tipped Cutters

1" Depth

4 Items • 4 Pcs  
**IBS No. 763R**



Packaged in a Locking Steel Drawer for Easy Storage & Organization

<b>IBS, Inc.</b> <small>SPECIALTY PRODUCTS FOR MAINTENANCE &amp; REPAIR  INDUSTRIALBOLT.COM • 800-678-1906</small>				<b>Carbide Tipped Cutters</b> 1" Depth Assortment No. 764R			
19254 7/8 CARBIDE TIPPED CUTTER - 1" DEPTH 	19258 1-1/8 CARBIDE TIPPED CUTTER - 1" DEPTH 	19262 1-3/8 CARBIDE TIPPED CUTTER - 1" DEPTH 	19268 1-3/4 CARBIDE TIPPED CUTTER - 1" DEPTH 				
19272 2" CARBIDE TIPPED CUTTER - 1" DEPTH 							

PRODUCT CATEGORY: PT

### Carbide Tipped Cutters

1" Depth

5 Items • 5 Pcs  
**IBS No. 764R**



Packaged in a Locking Steel Drawer for Easy Storage & Organization

# IBS, INCORPORATED

## Assortments - Taps, Burs & Blades (PT)



### Advanced Bi-Metal Hole Saws

5/8" to 2" with  
Rapid Core Ejecting Arbors  
15 Items • 15 Pcs  
IBS No. 782R



Packaged in a Locking Steel Drawer for Easy Storage & Organization

### Advanced Bi-Metal Hole Saws

2-1/8" to 4" with  
Rapid Core Ejecting Arbors  
8 Items • 8 Pcs  
IBS No. 783R



Packaged in a Locking Steel Drawer for Easy Storage & Organization

### Advanced Bi-Metal Hole Saws 3/4" to 4"

3/4" to 4" with Rapid Core Ejecting Arbors  
18 Items • 19 Pcs  
IBS No. 784R



Packaged in a Locking Steel Drawer for Easy Storage & Organization

<b>Advanced Bi-Metal Hole Saws 5/8" to 2"</b> with Rapid Core Ejecting Arbors Assortment No. 782R			
29201 5/8 HOLE SAW ADVANCED EDGE	29209 1-1/8 HOLE SAW ADVANCED EDGE	29217 1-5/8 HOLE SAW ADVANCED EDGE	29050 RAPID CORE EJECTING ARBOR FOR 1-1/4 TO 6 HOLE SAWS  29051 RAPID CORE EJECTING ARBOR FOR 9/16 - 1-3/16 DIAM HOLE SAWS  29052 PILOT DRILL BIT FOR 29050  29053 PILOT DRILL BIT FOR 29051
29203 3/4 HOLE SAW ADVANCED EDGE	29211 1-1/4 HOLE SAW ADVANCED EDGE	29219 1-3/4 HOLE SAW ADVANCED EDGE	
29205 7/8 HOLE SAW ADVANCED EDGE	29213 1-3/8 HOLE SAW ADVANCED EDGE	29222 2" HOLE SAW ADVANCED EDGE	
29207 1" HOLE SAW ADVANCED EDGE	29215 1-1/2 HOLE SAW ADVANCED EDGE		

PRODUCT CATEGORY: PT

<b>Advanced Bi-Metal Hole Saws 2-1/8" to 4"</b> with Rapid Core Ejecting Arbors Assortment No. 783R			
29224 2-1/8 HOLE SAW ADVANCED EDGE	29228 2-1/2 HOLE SAW ADVANCED EDGE	29237 3-1/2 HOLE SAW ADVANCED EDGE	29050 RAPID CORE EJECTING ARBOR FOR 1-1/4 TO 6 DIAM. HOLE SAWS
29225 2-1/4 HOLE SAW ADVANCED EDGE	29233 3" HOLE SAW ADVANCED EDGE	29241 4" HOLE SAW ADVANCED EDGE	
			29052 PILOT DRILL FOR 29050

PRODUCT CATEGORY: PT

<b>Advanced Bi-Metal Hole Saws 3/4" to 4"</b> with Rapid Core Ejecting Arbors Assortment No. 784R			
29203 3/4 HOLE SAW ADVANCED EDGE	29217 1-5/8 HOLE SAW ADVANCED EDGE	29225 2-1/4 HOLE SAW ADVANCED EDGE	29241 4" HOLE SAW ADVANCED EDGE
29207 1" HOLE SAW ADVANCED EDGE	29219 1-3/4 HOLE SAW ADVANCED EDGE	29228 2-1/2 HOLE SAW ADVANCED EDGE	
29209 1-1/8 HOLE SAW ADVANCED EDGE	29233 3" HOLE SAW ADVANCED EDGE		29050 RAPID CORE EJECTING ARBOR 1-1/4 - 6 DIAM HOLE SAW  29051 RAPID CORE EJECTING ARBOR FOR 9/16 - 1-3/16 DIAM HOLE SAW  29052 PILOT DRILL FOR 29050  29053 PILOT DRILL FOR 29051
29211 1-1/4 HOLE SAW ADVANCED EDGE	29222 2" HOLE SAW ADVANCED EDGE	29237 3-1/2 HOLE SAW ADVANCED EDGE	
29213 1-3/8 HOLE SAW ADVANCED EDGE	29224 2-1/8 HOLE SAW ADVANCED EDGE		
29215 1-1/2 HOLE SAW ADVANCED EDGE			

PRODUCT CATEGORY: PT

ASSORTMENTS



# IBS, INCORPORATED

## Assortments - Taps, Burs & Blades (PT)

ASSORTMENTS

<b>IBS, Inc.</b> SPECIALTY PRODUCTS FOR MAINTENANCE & REPAIR INDUSTRIALBOLT.COM © © © 800-678-1996		<b>Hi-Alloy Bi-Metal Hacksaw Blades</b>
		Assortment No. 785R
16395 12 18/14 HI-ALLOY HACKSAW BLADE		
16396 12 24/20 HI-ALLOY HACKSAW BLADE		
16398 12 32/26 HI-ALLOY HACKSAW BLADE		
16399 12 18/24/32 TRIPLE CUT BIMETAL HACKSAW BLADE		

PRODUCT CATEGORY: PT

<b>IBS, Inc.</b> SPECIALTY PRODUCTS FOR MAINTENANCE & REPAIR INDUSTRIALBOLT.COM © © © 800-678-1996		<b>Bore Blades and Demolition Blades</b>
		Assortment No. 801R
446710 6' 6X10TPI BORE BLADE. For metal and wood cutting.		448711 8' 10X14TPI BORE BLADE. For metal and wood cutting.
446711 6' 14X18TPI BORE BLADE. For metal and wood cutting.		4410710 10' 8/12X10TPI BORE BLADE. For metal and wood cutting.
448710 8' 6X10TPI BORE BLADE. For metal and wood cutting.		460906 9 X .062 6TPI DEMOLITION BIMETAL RECIP BLADE Specially designed for the toughest demolition jobs. Cuts all woods, nail-embedded wood and metals.
460910 9 X .062 10TPI DEMOLITION BIMETAL RECIP BLADE Specially designed for the toughest demolition jobs. Cuts all woods, nail-embedded wood and metals.		
461206 12 X .062 6TPI DEMOLITION BIMETAL RECIP BLADE Specially designed for the toughest demolition jobs. Cuts all woods, nail-embedded wood and metals.		
461210 12 X .062 10TPI DEMOLITION BIMETAL RECIP BLADE Specially designed for the toughest demolition jobs. Cuts all woods, nail-embedded wood and metals.		

PRODUCT CATEGORY: PT

<b>IBS, Inc.</b> SPECIALTY PRODUCTS FOR MAINTENANCE & REPAIR INDUSTRIALBOLT.COM © © © 800-678-1996		<b>Advanced Edge Power Reciprocating Saw Blades</b>
		Assortment No. 840R
470610 6IN X .042 10TPI ADVANDED EDGE POWER RECIP BLADE 1IN WIDTH		470910 9IN X .042 10TPI ADVANDED EDGE POWER RECIP BLADE 1IN WIDTH
471210 12IN X .042 10TPI ADVANDED EDGE POWER RECIP BLADE 1IN WIDTH		
470614 6IN X .042 14TPI ADVANDED EDGE POWER RECIP BLADE 1IN WIDTH		470914 9IN X .042 14TPI ADVANDED EDGE POWER RECIP BLADE 1IN WIDTH
471214 12IN X .042 14TPI ADVANDED EDGE POWER RECIP BLADE 1IN WIDTH		
470618 6IN X .042 18TPI ADVANDED EDGE POWER RECIP BLADE 1IN WIDTH		470918 9IN X .042 18TPI ADVANDED EDGE POWER RECIP BLADE 1IN WIDTH
471218 12IN X .042 18TPI ADVANDED EDGE POWER RECIP BLADE 1IN WIDTH		74172 TOOL EASE

PRODUCT CATEGORY: PT

### Hi-Alloy Bi-Metal Hacksaw Blades

4 Items • 20 Pcs  
IBS No. 785R



Packaged in a Locking Steel Drawer for Easy Storage & Organization

### Bore Blades & Demolition Blades

9 Items • 18 Pcs  
IBS No. 801R



Packaged in a Locking Steel Drawer for Easy Storage & Organization

### Advanced Edge Power Reciprocating Saw Blades with Tool Ease Lubricant Stick

10 Items • 21 Pcs  
IBS No. 840R



Packaged in a Locking Steel Drawer for Easy Storage & Organization

# IBS, INCORPORATED

## Assortments - Electrical (Q)



<b>IBS, Inc.</b> <small>SPECIALTY PRODUCTS FOR MAINTENANCE &amp; REPAIR  INDUSTRIALBOLTY.COM • • • 800-478-1988</small>					
Nylon Insulated Double Grip Solderless Terminal					
Assortment No. 101R					
61-SN 22-18 BUTT CONNECTOR	11-6SNB 22-18 X #6 RING TERMINAL	11-8SNB 22-18 X #8 RING TERMINAL	11-10NB 22-18 X #10 RING TERMINAL	31-10NB 22-18 X #10 SPADE TERMINAL	72F-250-32-NBL 16-14 FEMALE QUICK SLIDE
62-SN 16-14 BUTT CONNECTOR	12-6SNB 16-14 X #6 RING TERMINAL	12-10NB 16-14 X #10 RING TERMINAL	12-14SNB 16-14 X 1/4" RING TERMINAL	32-10NB 16-14 X #10 SPADE TERMINAL	72M-250-32-NBL 16-14 MALE QUICK SLIDE
63-SN 12-10 BUTT CONNECTOR	82F-156-NBL 16-14 FEMALE BULLET	82M-156-NB 16-14 MALE BULLET	33-10NB 12-10 X #10 SPADE TERMINAL	13-8SNB 12-10 X #8 RING TERMINAL	73M-250-32-NBL 12-10 MALE QUICK SLIDE
13-10NB 12-10 X #10 RING TERMINAL	13-14SNB 12-10 X 1/4" RING TERMINAL	13-56SNB 12-10 X 5/16" RING TERMINAL	13-38SNB 12-10 X 3/8" RING TERMINAL	13-500NB 12-10 X 1/2" RING TERMINAL	73F-250-32-NBL 12-10 FEMALE QUICK SLIDE

PRODUCT CATEGORY: Q

### Nylon Insulated Double Grip Solderless Terminals

24 Items • 270 Pcs  
IBS No. 101R



Packaged in a Locking Steel Drawer for Easy Storage & Organization

<b>IBS, Inc.</b> <small>SPECIALTY PRODUCTS FOR MAINTENANCE &amp; REPAIR  INDUSTRIALBOLTY.COM • • • 800-478-1988</small>	
Nylon Tie Wraps	
Assortment No. 107R	
15' 120lb. Black Nylon Tie B-14-120	
14-1/2' 50 lb. Black Nylon Tie B-14-50	
4' 18 lb. Black Nylon Tie B-4-18	
11' 50 lb. Black Nylon Tie B-11-50	
7-1/2' 50 lb. Clear Nylon Tie L-7-50	
8' 50 lb. Mountng Tie MH-7-50	
5-1/2' 40 lb. Clear Nylon Tie L-5-30	
7-1/2' 50 lb. Black Nylon Tie B-7-50	
4' 18 lb. Clear Nylon Tie L-4-18	
5-1/2' 40 lb. Black Nylon Tie B-5-30	

PRODUCT CATEGORY: Q

### Nylon Tie Wraps

10 Items • 750 Pcs  
IBS No. 107R



Packaged in a Locking Steel Drawer for Easy Storage & Organization

<b>IBS, Inc.</b> <small>SPECIALTY PRODUCTS FOR MAINTENANCE &amp; REPAIR  INDUSTRIALBOLTY.COM • • • 800-478-1988</small>					
Crimp & Seal Terminals w/ Torch & Butane Refill					
Assortment No. 109R					
			B5223 16-14 CRIMP & SEAL #8 RING TERM	B5224 16-14 CRIMP & SEAL #10 RING TERM	125738 + 95007 MICROTORCH BUTANE TORCH + REFILL
B5225 16-14 CRIMP & SEAL 1/4 RING TERM	B5228 16-14 CRIMP & SEAL #10 SPADE TERM	B5245 16-14 CRIMP & SEAL .250 FEMALE CONN	B5255 16-14 CRIMP & SEAL .250 MALE CONN	B5265 16-14 CRIMP & SEAL .156 MALE BULLET	
B5275 16-14 CRIMP & SEAL .156 FEMALE BULLET	B5324 12-10 CRIMP & SEAL #10 RING TERM	B5325 12-10 CRIMP & SEAL 1/4 RING TERM	B5327 12-10 CRIMP & SEAL 3/8 RING TERM	B5345 12-10 CRIMP & SEAL .250 FEMALE CONN	B280 22-18 SOLDER&SEAL SHRINK TUBE
B5355 12-10 CRIMP & SEAL .250 MALE CONN	B5110 20-18 CRIMP & SEAL BUTT CONNECTOR	B5210 16-14 CRIMP & SEAL BUTT CONNECTOR	B5310 12-10 CRIMP & SEAL BUTT CONNECTOR	B5100 22-24 CRIMP & SEAL BUTT CONNECTOR	B281 16-14 SOLDER&SEAL SHRINK TUBE
					B282 12-10 SOLDER&SEAL SHRINK TUBE

PRODUCT CATEGORY: Q

### Crimp & Seal Terminals w/ Torch & Butane Refill

21 Items • 315 Pcs  
IBS No. 109R



Packaged in a Locking Steel Drawer for Easy Storage & Organization

















ASSORTMENTS



















# IBS, INCORPORATED

## Assortments - Electrical (Q)













ASSORTMENTS

IBS, Inc. SPECIALTY PRODUCTS FOR MAINTENANCE & REPAIR INDUSTRIALBOLT.COM © & © 800-878-1906		ECOMAX Post Top Battery Terminals		
Assortment No. 129P				
E2107 ECOMAX BATT TERM 1+2 GA NEG 	E2111 ECOMAX BATT. TERM 2/0 GA. NEG. 	E2309 ECOMAX BATT. TERM. RT. EL. 1/0 NEG. 	B1110 5/16 X 1-1/4 TIN PLTD BATT 	
E2108 ECOMAX BATTERY TERM 1+2 GA POSITIVE 	E2112 ECOMAX BATT. TERM. 2/0 GA. POS. 	E2310 ECOMAX BATT. TERM. RT. EL. 1/0 POS. 		
E2109 ECOMAX BATT TERM 1/0 GA NEG 	E2113 ECOMAX BATT. TERM. 3/0 GA. NEG. 	E2311 ECOMAX BATT. TERM. RT. EL. 2/0 NEG. 	E2411 ECOMAX BATT. TERM. LT. EL. 2/0 NEG. 	E2211 ECOMAX BATT. TERM. FLAG 2/0 NEG. 
E2110 ECOMAX BATT TERM 1/0 GA POS 	E2114 ECOMAX BATT. TERM. 3/0 GA. POS. 	E2312 ECOMAX BATT. TERM. RT. EL. 2/0 POS. 	E2412 ECOMAX BATT. TERM. LT. EL. 2/0 POS. 	E2212 ECOMAX BATT. TERM. FLAG 2/0 POS. 

PRODUCT CATEGORY: Q

IBS, Inc. SPECIALTY PRODUCTS FOR MAINTENANCE & REPAIR INDUSTRIALBOLT.COM © & © 800-878-1906		Rubber Insulated & Nylon Clamps		
Assortment No. 141R				
7120A 1/4 NYLON CLAMP 	7122A 3/8 NYLON CLAMP 	7124A 1/2 NYLON CLAMP 	7126A 5/8 NYLON CLAMP 	
7314A 1/4 INSULATED CLAMP 1/4 STUD STAMP #4 	7315A 3/8 INSULATED CLAMP 1/4 STUD STAMP #6 	7316A 1/2 INSULATED CLAMP 1/4 STUD STAMP #8 	7318A 3/4 INSULATED CLAMP 1/4 STUD STAMP #12 	
7320A 1 INSULATED CLAMP 1/4 STUD STAMP #16 	7322A 1-1/4 INSULATED CLAMP 1/4 STUD STAMP #20 	7324A 1-1/2 INSULATED CLAMP 1/4 STUD STAMP #24 	7514A 1/4 INSULATED CLAMP 3/8 STUD STAMP #4 	
7516A 1/2 INSULATED CLAMP 3/8 STUD STAMP #8 	7518A 3/4 INSULATED CLAMP 3/8 STUD STAMP #12 	7520A 1 INSULATED CLAMP 3/8 STUD STAMP #16 	7522A 1-1/4 INSULATED CLAMP 3/8 STUD STAMP #18 	

PRODUCT CATEGORY: Q

IBS, Inc. SPECIALTY PRODUCTS FOR MAINTENANCE & REPAIR INDUSTRIALBOLT.COM © & © 800-878-1906		Nylon Clamps		
Assortment No. 145R				
7118A 1/8 NYLON CLAMP 	7119A 3/16 NYLON CLAMP 	7120A 1/4 NYLON CLAMP 		
7121A 5/16 NYLON CLAMP 	7122A 3/8 NYLON CLAMP 	7123A 7/16 NYLON CLAMP 		
7124A 1/2 NYLON CLAMP 	7125A 9/16 NYLON CLAMP 	7126A 5/8 NYLON CLAMP 		
7128A 3/4 NYLON CLAMP 	7129A 7/8 NYLON CLAMP 	7130A 1 NYLON CLAMP 		

PRODUCT CATEGORY: Q

**ECOMAX Post Top Battery Terminals**  
17 Items • 69 Pcs  
IBS No. 129P



Packaged in a Locking Steel Drawer for Easy Storage & Organization

**Rubber Insulated & Nylon Clamps**  
16 Items • 230 Pcs  
IBS No. 141R



Packaged in a Locking Steel Drawer for Easy Storage & Organization

**Nylon Clamps**  
12 Items • 525 Pcs  
IBS No. 145R



Packaged in a Locking Steel Drawer for Easy Storage & Organization

# IBS, INCORPORATED

## Assortments - Electrical (Q)



 <b>Rubber Insulated Clamps</b> 1/4" Mounting Hole		
Assortment No. 146R		
7314A 1/4 INSULATED CLAMP 1/4 STUD STAMP #4	7315A 3/8 INSULATED CLAMP 1/4 STUD STAMP #6	7316A 1/2 INSULATED CLAMP 1/4 STUD STAMP #8
7317A 5/8 INSULATED CLAMP 1/4 STUD STAMP #10	7318A 3/4 INSULATED CLAMP 1/4 STUD STAMP #12	7319A 7/8 INSULATED CLAMP 1/4 STUD STAMP #14
7320A 1 INSULATED CLAMP 1/4 STUD STAMP #16	7321A 1-1/8 INSULATED CLAMP 1/4 STUD STAMP #18	7322A 1-1/4 INSULATED CLAMP 1/4 STUD STAMP #20
7323A 1-3/8 INSULATED CLAMP 1/4 STUD STAMP #22	7324A 1-1/2 INSULATED CLAMP 1/4 STUD STAMP #24	7325A 1-5/8 INSULATED CLAMP 1/4 STUD STAMP #26

PRODUCT CATEGORY: Q

### Rubber Insulated Clamps

1/4" Mounting Hole  
 12 Items • 90 Pcs  
 IBS No. 146R



Packaged in a Locking Steel Drawer  
 for Easy Storage & Organization

 <b>Rubber Insulated Clamps</b> 3/8" Mounting Hole		
Assortment No. 147R		
7514A 1/4 INSULATED CLAMP 3/8 STUD STAMP #4	7515A 3/8 INSULATED CLAMP 3/8 STUD STAMP #6	7516A 1/2 INSULATED CLAMP 3/8 STUD STAMP #8
7517A 5/8 INSULATED CLAMP 3/8 STUD STAMP #10	7518A 3/4 INSULATED CLAMP 3/8 STUD STAMP #12	7519A 7/8 INSULATED CLAMP 3/8 STUD STAMP #14
7520A 1 INSULATED CLAMP 3/8 STUD STAMP #16	7522A 1-1/4 INSULATED CLAMP 3/8 STUD STAMP #18	

PRODUCT CATEGORY: Q

### Rubber Insulated Clamps

3/8 Mounting Hole  
 8 Items • 75 Pcs  
 IBS No. 147R



Packaged in a Locking Steel Drawer  
 for Easy Storage & Organization

 <b>Heavy Duty Wire Ends</b> for #8, #6 & #4 GA Wire				
Assortment No. 159R				
64-WP #8 BUTT CONNECTOR VINYL	65-WP #6 BUTT CONNECTOR VINYL	66-WP #4 BUTT CONNECTOR VINYL		
16-10-WN #4 RING TERM. 10 STUD NYLON	16-14-WN #4 RING TERM. 1/4 STUD NYLON	16-56-WN #8 RING TERM. 5/16 STUD NYLON	16-38-WN #4 RING TERM. 3/8 STUD NYLON	16-500S-WN #4 RING TERM 1/2 STUD NYLON
15-10S-WN #6 RING TERM. 10 STUD NYLON	15-14S-WN #6 RING TERM 1/4 STUD NYLON	15-56-WN #6 RING TERM. 5/16 STUD NYLON	15-38-WN #6 RING TERM 3/8 STUD NYLON	15-500S-WN #6 RING TERM 1/2 STUD NYLON
14-10S-WN #8 RING TERM. 10 STUD NYLON	14-14S-WN #8 RING TERM. 1/4 STUD NYLON	14-56-WN #8 RING TERM. 5/16 STUD NYLON	14-38-WN #8 RING TERM. 3/8 STUD NYLON	14-500S-WN #8 RING TERM. 1/2 STUD NYLON

PRODUCT CATEGORY: Q

### Heavy Duty Wire Ends for #8, #6 & #4 GA Wire

18 Items • 180 Pcs  
 IBS No. 159R



Packaged in a Locking Steel Drawer  
 for Easy Storage & Organization

ASSORTMENTS



# IBS, INCORPORATED

## Assortments - Electrical (Q)

ASSORTMENTS

**IBS, Inc.**  
SPECIALTY PRODUCTS FOR MAINTENANCE & REPAIR  
INDUSTRIALBOLTY.COM • • • 800-678-1506

Wire Nuts  
Assortment No. 198R

6X682 GRAY WIRE NUTS	6X683 BLUE WIRE NUT/REPLACES BLK	6X684 ORANGE WIRE NUTS	6X685 YELLOW WIRE NUT	6X686 RED WIRE NUT	TH450 AUTO WIRE CRIMPER/STRIPPER
6X687 YELLOW WIRE NUT WINGED	6X688 RED WIRE NUT WINGED	6X689 GRAY WIRE NUT WINGED	6X690 BLUE WIRE NUT WINGED	6X691 TAN WIRE NUT WINGED	
6X692 GREEN GROUNDING WIRE NUT WINGED					
973 O/B MULTI WIRE NUT	974 RED/YELLOW MULTI WIRE NUT	975 BLUE / GRAY MULTI WIRE NUT			



PRODUCT CATEGORY: Q

**Wire Nuts**  
15 Items • 256 Pcs  
IBS No. 198R



Packaged in a Locking Steel Drawer for Easy Storage & Organization

**IBS, Inc.**  
SPECIALTY PRODUCTS FOR MAINTENANCE & REPAIR  
INDUSTRIALBOLTY.COM • • • 800-678-1506

Wall Nuts & Lever Nuts  
Assortment No. 199R

773-162 2 WIRE WALL NUT	773-164 4 WIRE WALL NUT	773-166 6 WIRE WALL NUT	773-168 8 WIRE WALL NUT	773-173 3 WIRE WALL NUT	TH450 AUTO WIRE CRIMPER/STRIPPER
222-412 2 WIRE LEVER NUT	222-413 3 WIRE LEVER NUT	222-415 5 WIRE LEVER NUT			
221-2401 INLINE SPlice CLEAR LEVER NUT	221-412 2 WIRE CLEAR LEVER NUT	221-413 3 WIRE CLEAR LEVER NUT	221-415 5 WIRE CLEAR LEVER NUT		

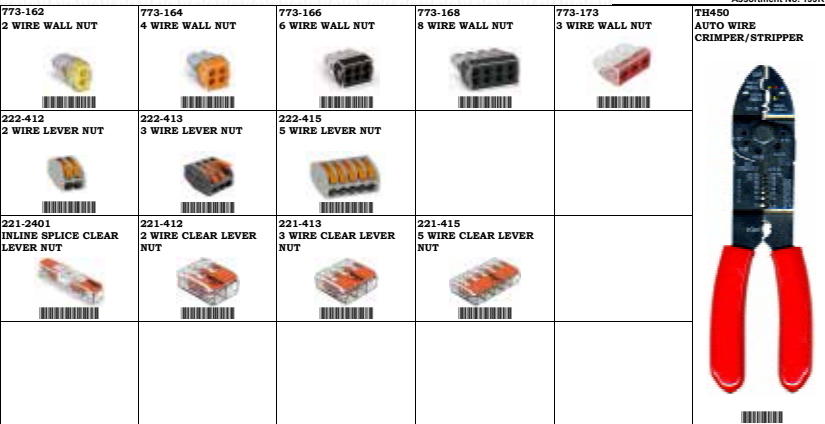

PRODUCT CATEGORY: Q

**Wall Nuts & Lever Nuts**

13 Items • 106 Pcs  
IBS No. 199R



Packaged in a Locking Steel Drawer for Easy Storage & Organization

**IBS, Inc.**  
SPECIALTY PRODUCTS FOR MAINTENANCE & REPAIR  
INDUSTRIALBOLTY.COM • • • 800-678-1506

Vinyl Insulated Solderless Terminals  
Assortment No. 201R

61-P 22-18 BUTT CONN VINYL	11-6P 22-18 RING TERM #6 STUD VINYL	11-8P 22-18 RING TERM #8 STUD VINYL	11-10P 22-18 RING TERM #10 STUD VINYL	31-10P 22-18 SPADE TERM #10 STUD	72P-250-32P 16-14 FEMALE QIK SLIDE VINYL
62-P 16-14 BUTT CONN VINYL	12-6P 16-14 RING TERM #6 STUD VINYL	12-10-P 16-14 RING TERM 10 STUD VINYL	12-14SP 16-14 RING TERM 1/4 STUD VINYL	32-10P 16-14 SPADE TERM 10 STUD VINYL	72M-250-32P 16-14 MALE QIK SLIDE VINYL
63-P 12-10 BUTT CONN VINYL	82F-156-NL 16-14 FEMALE SNAP PLUG VINYL	82M-156P 16-14 MALE SNAP PLUG VINYL	33-10P 12-10 SPADE TERM #10 STUD	13-8P 12-10 RING TERM #8 STUD VINYL	73M-250-32P 12-10 MALE QIK SLIDE VINYL
13-10P 12-10 RING TERM 10 STUD VINYL	13-14SP 12-10 RING TERM 1/4 STUD VINYL	13-56P 12-10 RING TERM 5/16 STUD VINYL	13-38P 12-10 RING TERM 3/8 STUD VINYL	13-500P 12-10 RING TERM 1/2 STUD VINYL	73F-250-32P 12-10 FEMALE QIK SLIDE VINYL

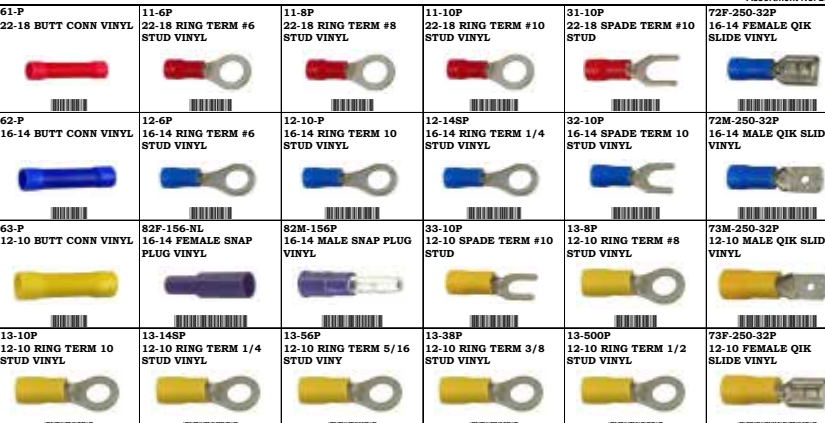

PRODUCT CATEGORY: Q

**Vinyl Insulated Solderless Terminals**

24 Items • 515 Pcs  
IBS No. 201R













Packaged in a Locking Steel Drawer for Easy Storage & Organization



# IBS, INCORPORATED

## Assortments - Electrical (Q)



IBS, Inc. SPECIALTY PRODUCTS FOR MAINTENANCE & REPAIR INDUSTRIALBOLT.COM © © © 800-678-1506		EcoMax Terminals Heavy Duty Lugs & Splices	
Assortment No. 202P			
BAL1038 1/0 X 3/8ST HVY DUTY TUBULAR LUG 	BAL1012 BATT TERM 1/0 X 1/2 STUD LUG HEAVY DUTY TUBULAR 	E2110 ECOMAX BATT TERM 1/0 GA POS 	E2109 ECOMAX BATT TERM 1/0 GA NEG 
BAL2038 2/0 X 3/8ST HVY DUTY TUBULAR LUG 	BAL2012 2/0 X 1/2ST HVY DUTY TUBULAR LUG 	E2112 ECOMAX BATT TERM 2/0 GA POS 	E2111 ECOMAX BATT TERM 2/0 GA NEG 
MS100 1/0GA HVY DUTY BUTT CONN 	MS200 2/0GA HVY DUTY BUTT CONN 		
B1110 5/16 X 1-1/4 BATT BOLT & NUT TIN PLATED 			















PRODUCT CATEGORY: Q

### EcoMax Terminals, Heavy Duty Lugs & Splices

11 Items • 75 Pcs  
IBS No. 202P



Packaged in a Locking Steel Drawer  
for Easy Storage & Organization

IBS, Inc. SPECIALTY PRODUCTS FOR MAINTENANCE & REPAIR INDUSTRIALBOLT.COM © © © 800-678-1506		Non-Insulated Butted Seam Top 24 Wire Ends			
Assortment No. 211R					
61S 22-18 BUTT CONN NON INSUL 	11-6 22-18 RING TERM. 6 STUD NO-INS 	11-8 22-18 RING TERM 8 STUD NO-INS 	11-10 22-18 RING TERM 10 STUD NO-INS 	31-10 22-18 SPADE TERM #10 STUD 	72F-250-32 16-14 FEMALE QUICK SLIDE 
62S 16-14 BUTT CONN NON INSULATED 	12-6 16-14 RING TERM. 6 STUD NO-INS 	12-10 16-14 RING TERM 10 STUD NO-INS 	12-14 16-14 RING TERM #14 STUD NO-IN 	32-10 16-14 #10 SPADE TERM 	72M-250-32 16-14 MALE QIK SLIDE NO INSUL. 
63S 12-10 BUTT CONN. NON INSUL 	82F-156-NL 16-14 FEMALE SNAP PLUG VINYL 	82M-156 16-14 MALE SNAP PLUG 	13-8 12-10 RING TERM 8 STUD NON-INS 	33-10 12-10 SPADE TERM #10 STUD 	73M-250-32 12-10 MALE QIK SLIDE NO INSUL. 
13-10 12-10 RING TERM #10 STUD NO-IN 	13-14 12-10 RING TERM 1/4 STUD 	13-56 12-10 RING TERM 5/16 STUD 	13-38 12-10 RING TERM. 3/8 STUD NO-1 	13-500 12-10 RING TERM 1/2 STUD 	73F-250-32 12-10 FEMALE QUICK SLIDE 











PRODUCT CATEGORY: Q

### Non-Insulated Butted Seam Top 24 Wire Ends

24 Items • 635 Pcs  
IBS No. 211R



Packaged in a Locking Steel Drawer  
for Easy Storage & Organization

IBS, Inc. SPECIALTY PRODUCTS FOR MAINTENANCE & REPAIR INDUSTRIALBOLT.COM © © © 800-678-1506		Grommet Kit	
Assortment No. 230R			
A-4410 5/32ID X 1/16 GROOVE RUBBER 	A-4413 3/16ID X 1/16 GROOVE RUBBER 	A-4414 3/16ID X 3/32 GROOVE RUBBER 	
A-16454 1/4ID X 1/16 GROOVE RUBBER 	A-4419 5/16ID X 1/16 GROOVE RUBBER 	A-4423 3/8ID X 1/16 GROOVE RUBBER 	
A-4428 1/2ID X 3/32 GROOVE RUBBER 	A-16458 1/2ID X 1/8 GROOVE RUBBER 	A-4432 5/8ID X 1/16 GROOVE RUBBER 	
A-4433 3/4ID X 1/16 GROOVE RUBBER 	A-4430 1/2ID X 1/4 GROOVE RUBBER 		

PRODUCT CATEGORY: Q

### Grommet Kit

11 Items • 220 Pcs  
IBS No. 230R



Packaged in a Locking Steel Drawer  
for Easy Storage & Organization



# IBS, INCORPORATED

## Assortments - Electrical (Q)

ASSORTMENTS

IBS, Inc.		Automotive Electrical Fuses						Assortment No. 290P
AGA15 AUTO FUSE	AGA20 AUTO FUSE	AGA30 AUTO FUSE		SFE7-1/2 AUTO FUSE GLASS TUBE	SFE14 AUTO FUSE GLASS TUBE	SFE20 AUTO FUSE GLASS TUBE	SFE30 AUTO FUSE GLASS TUBE	
AGC1 AUTO FUSE	AGC4 AUTO FUSE	AGC7-1/2 AUTO FUSE	AGC10 AUTO FUSE	AGC15 AUTO FUSE	AGC20 AUTO FUSE	AGC25 AUTO FUSE	AGC30 AUTO FUSE	
ATC5 AUTO FUSE	ATC10 AUTO FUSE	ATC15 AUTO FUSE	ATC20 AUTO FUSE	ATC25 AUTO FUSE	ATC30 AUTO FUSE	EL-12 HVY DUTY 2 PRONG TRUCK FLASHER FLASHER		
ATM5 AUTO FUSE	ATM10 AUTO FUSE	ATM15 AUTO FUSE	ATM20 AUTO FUSE	ATM25 AUTO FUSE	ATM30 AUTO FUSE	EL-13 HVY DUTY 3 PRONG TRUCK FLASHER		
19518 GLASS TUBE WATER-PROOF IN-LINE		19513 BLADE TYPE WATER-PROOF IN-LINE FUSE HLD			FP-C FUSE PULLER			
0690T 12 VOLT TESTER		1588A 3/8 TEST CLIP JAW		MAX20 20 AMP MAXI FUSE YELLOW	MAX30 30 AMP MAX FUSE GREEN	MAX40 40 AMP MAXI FUSE ORANGE		

PRODUCT CATEGORY: Q

**Automotive Electrical Fuses**  
37 Items • 235 Pcs  
IBS No. 290P



Packaged in a Locking Steel Drawer for Easy Storage & Organization

IBS, Inc.		Heavy Wall Shrink Tubing II		Assortment No. 295P
B3505 2-4/0GA X 6" BLACK HVY		B3405 2-4/0GA X 6" RED HVY WALL		
B3503 8-1/0GA X 6" BLACK HEAVY SHRINK TUBE		B3404 8-1/0 GA X 6" RED HEAVY SHRINK TUBE		
B3501 12-6GA X 6" BLACK HVY SHRINK		B3502 12-6GA X 6" RED HVY SHRINK		
B3508 8-2GA X 6" CLEAR SHRINK TUBE		B282 12-10 SOLDER&SEAL SHRINK TUBE		
B3507 14-8GA X 6" CLEAR SHRINK TUBE		B281 16-14 SOLDER&SEAL SHRINK TUBE		
B3506 18-12GA X 6" CLEAR SHRINK		B280 22-18 SOLDER&SEAL SHRINK TUBE		

PRODUCT CATEGORY: Q

**Heavy Wall Shrink Tubing II**  
12 Items • 86 Pcs  
IBS No. 295P



Packaged in a Locking Steel Drawer for Easy Storage & Organization

IBS, Inc.		FUSION™ Solder-On Battery Ends & Shrink Tubing		Assortment No. 296P
B11381 1/0 X 3/8 FUSION HVY WALL LUG	B21381 2/0 X 3/8 FUSION HVY WALL LUG	B3405 2-4/0GA X 6" RED HVY WALL	B3505 2-4/0GA X 6" BLACK HVY	
B2121 1/0 POS STRT FUSION BATTERY	B2123 2/0 POS STRT FUSION BATTERY			
B2120 1/0 NEG STRT FUSION BATTERY	B2122 2/0 NEG STRT FUSION BATTERY			

PRODUCT CATEGORY: Q

**Fusion Solder-On Battery Ends & Shrink Tubing**  
8 Items • 34 Pcs  
IBS No. 296P



Packaged in a Locking Steel Drawer for Easy Storage & Organization

# IBS, INCORPORATED

## Assortments - Electrical (Q)



IBS, Inc. SPECIALTY PRODUCTS FOR MAINTENANCE & REPAIR INDUSTRIALBOLT.COM • 800-670-1506		Automotive Shrink Tubing With MicroTorch Butane Torch Included Assortment No. 297R	
B281 16-14 SOLDER&SEAL SHRINK TUBE		B282 12-10 SOLDER/SEAL SHRINK TUBE	
B280 22-18 SOLDER&SEAL SHRINK TUBE		B279 24-22 SOLDER/SEAL SHRINK TUBE	
B3507 14-8GA X 6 CLEAR SHRINK TUBE*		B3508 8-2GA X 6 CLEAR SHRINK TUBE*	
B3302 1/4 X 12 CLEAR DUAL WALL*			
B3301 3/16 X 12 CLEAR DUAL WALL*			
B3300 1/8 X 12 CLEAR DUAL WALL*			

PRODUCT CATEGORY: Q

IBS, Inc. SPECIALTY PRODUCTS FOR MAINTENANCE & REPAIR INDUSTRIALBOLT.COM • 800-670-1506		Multilink Wire Ends Assortment No. 314R			
B5518 20-18 MULTILINK BUTT CONNECTOR		125702 20-18 MULTILINK #8 RING TERM		125703 20-18 MULTILINK #10 RING TERM	
B5514 16-14 MULTILINK BUTT CONNECTOR		125718 16-14 MULTILINK .250 MALE		125719 16-14 MULTILINK .250 FEMALE	
125705 16-14 MULTILINK #8 RING TERM		125707 16-14 MULTILINK 1/4 RING TERM		125708 16-14 MULTILINK 3/8 RING TERM	
B5510 12-10 MULTILINK BUTT CONNECTOR		125710 12-10 MULTILINK 1/4 RING TERM		125711 12-10 MULTILINK 3/8 RING TERM	
125706 16-14 MULTILINK #10 RING TERM		125720 12-10 MULTILINK .250 MALE		125721 12-10 MULTILINK .250 FEMALE	

PRODUCT CATEGORY: Q

IBS, Inc. SPECIALTY PRODUCTS FOR MAINTENANCE & REPAIR INDUSTRIALBOLT.COM • 800-670-1506		Crimp-N-Seal Terminals Assortment No. 316R			
B5225 16-14 CRIMP & SEAL 1/4 RING TERM		B5228 16-14 CRIMP & SEAL #10 SPADE TERM		B5245 16-14 CRIMP & SEAL .250 FEMALE CONN	
B5275 12-10 CRIMP & SEAL .156 FEMALE BULLET		B5324 12-10 CRIMP & SEAL #10 RING TERM		B5325 12-10 CRIMP & SEAL 1/4 RING TERM	
B5355 12-10 CRIMP & SEAL .250 MALE CONN		B5110 20-18 CRIMP & SEAL BUTT CONNECTOR		B5210 16-14 CRIMP & SEAL BUTT CONNECTOR	
B5223 16-14 CRIMP & SEAL #8 RING TERM		B5255 16-14 CRIMP & SEAL .250 MALE CONN		B5310 12-10 CRIMP & SEAL BUTT CONNECTOR	
B5224 16-14 CRIMP & SEAL #10 RING TERM		B5265 16-14 CRIMP & SEAL .156 MALE BULLET		B5100 24-22 CRIMP & SEAL BUTT CONNECTOR	
B280 22-18 SOLDER&SEAL SHRINK TUBE					
B281 16-14 SOLDER&SEAL SHRINK TUBE					
B282 12-10 SOLDER&SEAL SHRINK TUBE					

PRODUCT CATEGORY: Q

## Automotive Shrink Tubing

9 Items • 55 Pcs  
IBS No. 297R



Packaged in a Locking Steel Drawer for Easy Storage & Organization

## Multilink Wire Ends

19 Items • 145 Pcs  
IBS No. 314R



Packaged in a Locking Steel Drawer for Easy Storage & Organization

## Crimp-N-Seal Terminals

20 Items • 348 Pcs  
IBS No. 316R



Packaged in a Locking Steel Drawer for Easy Storage & Organization

A  
S  
S  
O  
R  
T  
M  
E  
N  
T  
S



# IBS, INCORPORATED

## Assortments - Electrical (Q)

ASSORTMENTS

















**IBS, Inc.**  
SPECIALTY PRODUCTS FOR MAINTENANCE & REPAIR  
INDUSTRIALBOLT.COM • 800-478-1506



**Multilink Wire Ends**  
With Microtorch Butane Torch & Refill Included

Assortment No. 324R

B5518 20-18 MULTILINK BUTT CONNECTOR	125702 20-18 MULTILINK #8 RING TERM	125703 20-18 MULTILINK #10 RING TERM	125713 20-18 MULTILINK #10 SPADE TERM	125738 MICROTORCH BUTANE TORCH
				
B5514 16-14 MULTILINK BUTT CONNECTOR	125714 16-14 MULTILINK #10 SPADE TERM	125718 16-14 MULTILINK .250 MALE	125719 16-14 MULTILINK .250 FEMALE	125715 12-10 MULTILINK #10 SPADE TERM
				
125705 16-14 MULTILINK #8 RING TERM	125706 16-14 MULTILINK #10 RING TERM	125707 16-14 MULTILINK 1/4 RING TERM	125708 16-14 MULTILINK 3/8 RING TERM	125720 12-10 MULTILINK .250 MALE
				
B5510 12-10 MULTILINK BUTT CONNECTOR	125709 12-10 MULTILINK #10 RING TERM	125710 12-10 MULTILINK 1/4 RING TERM	125711 12-10 MULTILINK 3/8 RING TERM	125721 12-10 MULTILINK .250 FEMALE
				

PRODUCT CATEGORY: Q

**Multilink Wire Ends**  
with Micro Butane Torch  
21 Items • 147 Pcs  
IBS No. 324R



















Packaged in a Locking Steel Drawer for Easy Storage & Organization



**IBS, Inc.**  
SPECIALTY PRODUCTS FOR MAINTENANCE & REPAIR  
INDUSTRIALBOLT.COM • 800-478-1506

**Automotive Bulbs**

Assortment No. 327R

B194 #194 12V INSTRUMENT / SIDE	B194NA 12V AMBER PARKING / SIDE	B1893 12V HD AUTO INSTRUMENT LIGHT	B1895 12V PARKING / SIDE MARKER	B53 12V AUTO INSTRUMENT LIGHT
				
B57 12V AUTO INSTRUMENT LIGHT	B1157 12V STOP - TURN - SIGNAL LIGHT	B1157NA 12V STOP - TAIL - SIGNAL LIGHT	B3157 12V STOP - TAIL - TURN LIGHT	B3157NA 12V STOP - TAIL - TURN LIGHT
				
B2057 12V STOP - TAIL - TURN LIGHT	B3057 12V STOP - TAIL - TURN LIGHT	B1156 12V FRONT & REAR TURN LIGHT	B3156 12V FRONT & REAR TURN LIGHT	
				
B916 12V PARKING / SIDE MARKER	B97 12V PARKING / LICENSE PLATE			
				

PRODUCT CATEGORY: Q

**Automotive Bulbs**  
16 Items • 160 Pcs  
IBS No. 327R









Packaged in a Locking Steel Drawer for Easy Storage & Organization

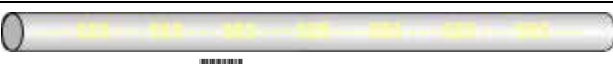

**IBS, Inc.**  
SPECIALTY PRODUCTS FOR MAINTENANCE & REPAIR  
INDUSTRIALBOLT.COM • 800-478-1506

**Automotive Shrink Tubing**  
12" Cut Lengths

Assortment No. 338R

B3313 14-4AWG HI FLOW ADHESIVE	
B3312 16-8AWG HI FLOW ADHESIVE	
B3311 22-10AWG HI FLOW ADHESIVE	
B3310 24-12AWG HI FLOW ADHESIVE	
B3301 3/16 X 12" CLEAR DUAL WALL	
B3300 1/8 X 12" CLEAR DUAL WALL	

PRODUCT CATEGORY: Q

**Automotive Shrink Tubing**  
12" Cut Lengths  
6 Items • 30 Pcs  
IBS No. 338R



Packaged in a Locking Steel Drawer for Easy Storage & Organization

# IBS, INCORPORATED

## Assortments - Electrical (Q)



IBS, Inc. SPECIALTY PRODUCTS FOR MAINTENANCE & REPAIR INDUSTRIALBOLTY.COM © © © 800-678-1906							Heavy Duty Truck Circuit Breakers
							Assortment No. 340R
CB1911-10 10AMP MAXI BREAKER	CB1911-20 20AMP MAXI BREAKER	CB1911-30 30AMP MAXI BREAKER	CB212-10 10AMP ATM MINI CIRCUIT BREAKER	CB212-15 15AMP ATM MINI CIRCUIT BREAKER	CB212-20 20AMP ATM MINI CIRCUIT BREAKER	CB212-25 25AMP ATM MINI CIRCUIT BREAKER	
CBC-15B 15AMP STUD MOUNTED	CBC-20B 20AMP STUD MOUNTED	CBC-30B 30AMP STUD MOUNTED	CBC-40B 40AMP STUD MOUNTED	CBC-50B 50AMP STUD MOUNTED	CCB-25 25AMP CIRCUIT BREAKER OE#	FCB-20 20AMP CIRCUIT BREAKER OE#	
UCB-10 10AMP UNIVERSAL CIRCUIT	UCB-15 15AMP UNIVERSAL CIRCUIT	UCB-20 20AMP UNIVERSAL CIRCUIT	UCB-25 25AMP UNIVERSAL CIRCUIT	UCB-30 30AMP UNIVERSAL CIRCUIT	CBF-20 20AMP CIRCUIT BREAKER-GLASS	CBF-30 30AMP CIRCUIT BREAKER-GLASS	
CB221-10 10AMP ATC BLADE BREAKER TYPE 1	CB221-15 15AMP ATC BLADE BREAKER TYPE 1	CB221-20 20AMP ATC BLADE BREAKER TYPE 1	CB221-30 30AMP ATC BLADE BREAKER TYPE 1	CB221-30 30AMP ATC STYLE CIRCUIT			

PRODUCT CATEGORY: Q

### Heavy Duty Truck Circuit Breakers

26 Items • 26 Pcs  
IBS No. 340R



Packaged in a Locking Steel Drawer for Easy Storage & Organization

IBS, Inc. SPECIALTY PRODUCTS FOR MAINTENANCE & REPAIR INDUSTRIALBOLTY.COM © © © 800-678-1906						LED Smart Fuses
						Assortment No. 364R
139212 ATM 5 Amp Mini / Amber	139214 ATM 10 Amp Mini / Red	139215 ATM 15 Amp Mini / Blue	139216 ATM 20 Amp Mini / Yellow	139217 ATM 25 Amp Mini / Clear	139447 ATM Mini In-Line Clear Cover Fuseholder	
139218 ATM 30 Amp Mini / Green		139222 ATC 5 Amp Amber	139224 ATC 10 Amp Red	139225 ATC 15 Amp Blue	139450 ATC In-Line Clear Cover Fuseholder	
139226 ATC 20 Amp Yellow	139227 ATC 25 Amp Clear	139228 ATC 30 Amp Green		139411 MAXI 20 Amp Yellow	139425 MAXI In-Line Fuseholder with Cover	
139412 MAXI 30 Amp Green	139413 MAXI 40 Amp Amber	139414 MAXI 50 Amp Red	139415 MAXI 60 Amp Blue	139416 MAXI 80 Amp Clear		

PRODUCT CATEGORY: Q

### LED Smart Fuses

22 Items • 76 Pcs  
IBS No. 364R



Packaged in a Locking Steel Drawer for Easy Storage & Organization

IBS, Inc. SPECIALTY PRODUCTS FOR MAINTENANCE & REPAIR INDUSTRIALBOLTY.COM © © © 800-678-1906		Black Nylon Ty-Raps with Metal Tabs
		Assortment No. 370R
104487 MINI CABLE TIE GUN		
104493 13IN 120LB BLACK NYLON TYRAP METAL TAB		
104492 14IN 50LB BLACK NYLON TYRAP METAL TAB		
104491 11IN 50LB BLACK NYLON TYRAP METAL TAB		
104490 7IN 50LB BLACK NYLON TYRAP METAL TAB		
104488 3-1/2 18LB BLACK NYLON TYRAP METAL TAB	104489 5-1/2 30LB BLACK NYLON TYRAP METAL TAB	

PRODUCT CATEGORY: Q

### Black Nylon Ty-Raps with Metal Tabs

7 Items • 251 Pcs  
IBS No. 370R



Packaged in a Locking Steel Drawer for Easy Storage & Organization



# IBS, INCORPORATED

## Assortments - Electrical (Q)

ASSORTMENTS

IBS, Inc. SPECIALTY PRODUCTS FOR MAINTENANCE & REPAIR INDUSTRIALBOLT.COM 800-678-1506					
Multilink Wire Ends					
Assortment No. 385R					
B5518 20-18 MULTILINK BUTT CONNECTOR	B5530 20-18 TO 16-14 MULTILINK STEP	B5514 16-14 MULTILINK BUTT CONNECTOR	B5540 16-14 TO 12-10 MULTILINK STEP	B5510 12-10 MULTILINK BUTT CONNECTOR	B5550 12-10 TO 8GA MULTILINK STEP
125702 20-18 MULTILINK #8 RING TERM	125713 20-18 MULTILINK #10 SPADE TERM	125705 16-14 MULTILINK #8 RING TERM	125714 16-14 MULTILINK #10 SPADE TERM	125709 12-10 MULTILINK #10 RING TERM	125715 12-10 MULTILINK #10 SPADE TERM
125703 20-18 MULTILINK #10 RING TERM	125716 20-18 MULTILINK .250 MALE	125706 16-14 MULTILINK #10 RING TERM	125718 16-14 MULTILINK .250 MALE	125710 12-10 MULTILINK 1/4 RING TERM	125720 12-10 MULTILINK .250 MALE
125704 20-18 MULTILINK 1/4 RING TERM	125717 20-18 MULTILINK .250 FEMALE	125707 16-14 MULTILINK 1/4 RING TERM	125719 16-14 MULTILINK .250 FEMALE	125711 12-10 MULTILINK 3/8 RING TERM	125721 12-10 MULTILINK .250 FEMALE

PRODUCT CATEGORY: Q

**Multilink Wire Ends**  
24 Items • 175 Pcs  
IBS No. 385R



Packaged in a Locking Steel Drawer for Easy Storage & Organization

IBS, Inc. SPECIALTY PRODUCTS FOR MAINTENANCE & REPAIR INDUSTRIALBOLT.COM 800-678-1506					
Crimp & Seal Wire Ends					
Assortment No. 386R					
B5110 20-18 CRIMP & SEAL BUTT CONNECTOR	B5115 20-18 CRIMP & SEAL 1/4 RING TERM	B5210 16-14 CRIMP & SEAL BUTT CONNECTOR	B5227 16-14 CRIMP & SEAL 3/8 RING TERM	B5310 12-10 CRIMP & SEAL BUTT CONNECTOR	B5327 12-10 CRIMP & SEAL 3/8 RING TERM
B5112 20-18 CRIMP & SEAL #6 RING TERM	B5118 20-18 #10 CRIMP & SEAL SPADE TERM	B5223 16-14 CRIMP & SEAL #8 RING TERM	B5228 16-14 CRIMP & SEAL #10 SPADE TERM	B5323 12-10 CRIMP & SEAL #8 RING TERM	B5331 12-10 CRIMP & SEAL #10 SPADE TERM
B5113 20-18 CRIMP & SEAL #8 RING TERM	B5155 20-18 CRIMP & SEAL .250 MALE CONN	B5224 16-14 CRIMP & SEAL #10 RING TERM	B5255 16-14 CRIMP & SEAL .250 MALE CONN	B5324 12-10 CRIMP & SEAL #10 RING TERM	B5355 12-10 CRIMP & SEAL .250 MALE CONN
B5114 20-18 CRIMP & SEAL #10 RING TERM	B5145 20-18 CRIMP & SEAL .250 FEMALE CONN	B5225 16-14 CRIMP & SEAL 1/4 RING TERM	B5245 16-14 CRIMP & SEAL .250 FEMALE CONN	B5325 12-10 CRIMP & SEAL 1/4 RING TERM	B5345 12-10 CRIMP & SEAL .250 FEMALE CONN

PRODUCT CATEGORY: Q

**Crimp & Seal Wire Ends**  
24 Items • 240 Pcs  
IBS No. 386R



Packaged in a Locking Steel Drawer for Easy Storage & Organization

IBS, Inc. SPECIALTY PRODUCTS FOR MAINTENANCE & REPAIR INDUSTRIALBOLT.COM 800-678-1506			
Fusion Battery Ends			
Assortment No. 387R			
B2117 4-GGA NEG STRT FUSION BATTERY	B21171 4-GGA POS STRT FUSION BATTERY	B2118 1-2GA NEG STRT FUSION BATTERY	B2119 1-2GA POS STRT FUSION BATTERY
B2120 1/0 NEG STRT FUSION BATTERY	B2121 1/0 POS STRT FUSION BATTERY	B2122 2/0 NEG STRT FUSION BATTERY	B2123 2/0 POS STRT FUSION BATTERY
B2124 3/0 NEG STRT FUSION BATTERY	B2125 3/0 POS STRT FUSION BATTERY	B2126 4/0 NEG STRT FUSION BATTERY	B2127 4/0 POS STRT FUSION BATTERY

PRODUCT CATEGORY: Q

**Fusion Battery Ends**  
12 Items • 22 Pcs  
IBS No. 387R



Packaged in a Locking Steel Drawer for Easy Storage & Organization

# IBS, INCORPORATED

## Assortments - Electrical (Q)



<b>IBS, Inc.</b> <small>SPECIALTY PRODUCTS FOR MAINTENANCE &amp; REPAIR  INDUSTRIALBOLTY.COM © © © 800-670-1506</small>				<b>Procell Alkaline Batteries</b>	
Assortment No. 395R					
<b>EN95</b> D SIZE PROCELL ALKALINE BATTERY 	<b>EN93</b> C SIZE PROCELL ALKALINE BATTERY 	<b>EN91</b> AA PROCELL ALKALINE BATTERY 	<b>EN92</b> AAA PROCELL ALKALINE BATTERY 	<b>EN22</b> 9 VOLT PROCELL ALKALINE BATTERY 	

PRODUCT CATEGORY: Q

## Procell Alkaline Batteries

5 Items • 46 Pcs  
**IBS No. 395R**



Packaged in a Locking Steel Drawer for Easy Storage & Organization

<b>IBS, Inc.</b> <small>SPECIALTY PRODUCTS FOR MAINTENANCE &amp; REPAIR  INDUSTRIALBOLTY.COM © © © 800-670-1506</small>				<b>Red 22-18 Electrical Connectors</b>	
Assortment No. 400R					
<b>61-SN</b> 22-18 BUTT CONN NYLON 	<b>61NBM</b> 22-18 MOISTURE RESIST BUTT CON 	<b>B5518</b> 20-18 MULTILINK BUTT CONNECTOR 	<b>31-6NB</b> 22-18 SPADE TERM 6 STUD NYLON 	<b>31-8NB</b> 22-18 SPADE TERM 8 STUD NYLON 	<b>31-10NB</b> 22-18 SPADE TERM 10 STUD NYLON 
<b>11-6SNB</b> 22-18 RING TERM 6 STUD NYLON 	<b>11-8SNB</b> 22-18 RING TERM 8 STUD NYLON 	<b>11-10NB</b> 22-18 RING TERM 10 STUD NYLON 	<b>11-14SNB</b> 22-18 RING TERM 1/4 STUD NYLON 	<b>11-56NB</b> 22-18 RING TERM. 5/16 STUD NYL 	<b>11-38NB</b> 22-18 RING TERM. 3/8 STUD NYLO 
<b>81M-156-NB</b> 22-18 MALE SNAP PLUG FULL NY 	<b>81F-156-NBL</b> 22-18 FEMALE SNAP PLUG FULL NY 	<b>71M-250-32-NBL</b> 22-18 MALE QIK SLIDE FULL 	<b>71F-250-32-NBL</b> 22-18 FEMALE QIK SLIDE FULL NY 	<b>71M-250-32-NB</b> 22-18 MALE QIK SLIDE NYLON 	<b>71F-250-32-NB</b> 22-18 FEMALE QIK SLIDE NYLON 
<b>71F-250-90-NBL</b> 22-18 1/4 90DGR F QUIK 	<b>81P-47-NB</b> 22-18 PIN TERMINAL NYLON 				

PRODUCT CATEGORY: Q

## Red 22-18 Electrical Connectors

20 Items • 215 Pcs  
**IBS No. 400R**



Packaged in a Locking Steel Drawer for Easy Storage & Organization

<b>IBS, Inc.</b> <small>SPECIALTY PRODUCTS FOR MAINTENANCE &amp; REPAIR  INDUSTRIALBOLTY.COM © © © 800-670-1506</small>				<b>Blue 16-14 Electrical Connectors</b>	
Assortment No. 401R					
<b>62-SN</b> 16-14 BUTT CONN NYLON 	<b>62NBM</b> 16-14 MOISTURE RESIST BUTT CON 	<b>B5514</b> 16-14 MULTILINK BUTT CONNECTOR 	<b>32-6NB</b> 16-14 SPADE TERM 6 STUD NYLON 	<b>32-8NB</b> 16-14 SPADE TERM 8 STUD NYLON 	<b>32-10NB</b> 16-14 SPADE TERM 10 STUD NYLON 
<b>12-6SNB</b> 16-14 RING TERM 6 STUD NYLON 	<b>12-8SNB</b> 16-14 RING TERM 8 STUD NYLON 	<b>12-10NB</b> 16-14 RING TERM 10 STUD NYLON 	<b>12-14SNB</b> 16-14 RING TERM 1/4 STUD NYLON 	<b>12-56SNB</b> 16-14 RING TERM 5/16 STUD NYLO 	<b>12-38NB</b> 16-14 RING TERM 3/8 STUD NYLON 
<b>82M-156-NB</b> 16-14 MALE SNAP PLUG NYLON 	<b>82F-156-NBL</b> 16-14 FEMALE SNAP PLUG FULL NY 	<b>72M-250-32-NBL</b> 16-14 MALE QIK SLIDE FULL 	<b>72F-250-32-NBL</b> 16-14 FEMALE QIK SLIDE FULL NY 	<b>72M-250-32-NB</b> 16-14 MALE QIK SLIDE NYLON 	<b>72F-250-32-NB</b> 16-14 FEMALE QIK SLIDE NYLON 
<b>72F-250-90-NBL</b> 16-14 90DGR 1/4 F QUIK 	<b>82P-47-NB</b> 16-14 PIN TERMINAL NYLON 				

PRODUCT CATEGORY: Q

## Blue 16-14 Electrical Connectors

20 Items • 215 Pcs  
**IBS No. 401R**



Packaged in a Locking Steel Drawer for Easy Storage & Organization

ASSORTMENTS



# IBS, INCORPORATED

## Assortments - Electrical (Q)

ASSORTMENTS

IBS, Inc. SPECIALTY PRODUCTS FOR MAINTENANCE & REPAIR INDUSTRIALBOLT.COM © & © 800-678-1906		Yellow 12-10 Electrical Connectors			Assortment No. 402R
63-5N 12-10 BUTT CONN NYLON	63NM 12-10 MOISTURE RESIST BUTT CON	B5510 12-10 MULTILINK BUTT CONNECTOR	33-8NB 12-10 SPADE TERM 8 STUD NYLON	33-10NB 12-10 SPADE TERM 10 STUD NYLON	
13-10NB 12-10 RING TERM 10 STUD NYLON	13-14SNB 12-10 RING TERM 1/4 STUD NYLON	13-56SNB 12-10 RING TERM 5/16 STUD NYLON	13-38SNB 12-10 RING TERM 3/8 STUD NYLON	13-50NB 12-10 RING TERM 1/2 STUD NYLON	
13-8SNB 12-10 RING TERM 8 STUD NYLON	73M-250-32-NBL 12-10 MALE QIK SLIDE FULL NYLON	73F-250-32-NBL 12-10 FEMALE QIK SLIDE FULL NY	73M-250-32-NB 12-10 MALE QIK SLIDE NYLON	73F-250-32-NB 12-10 FEMALE QIK SLIDE NYLON	
83P-55-NB 12-10 PIN TERMINAL NYLON					

PRODUCT CATEGORY: Q

### Yellow 12-10 Electrical Connectors

16 Items • 175 Pcs

IBS No. 402R



Packaged in a Locking Steel Drawer for Easy Storage & Organization

IBS, Inc. SPECIALTY PRODUCTS FOR MAINTENANCE & REPAIR INDUSTRIALBOLT.COM © & © 800-678-1906		Special Battery Ends			Assortment No. 642P
133328 8-6GA OEM POSITIVE BATTERY END	N7000 HVY DUTY TOP MOUNT BATT TERM	133338 POST TO SIDE MNT BATTERY END	133335 MARINE WING NUT BATTERY END	133336 MARINE WING NUT BATTERY END	
133329 8-6GA OEM NEGATIVE BATTERY END	133332 AUTOMOTIVE EMERGENCY POS.	133338 POST TO SIDE MNT BATTERY END	B6007 SIDE MNT BATTERY ACC. BOLT	B6024 TOP MNT BATTERY ACC. BOLT	
133330 4.2&1GA OEM POSITIVE BATTERY	133333 AUTOMOTIVE EMERGENCY NEG.	133339 SIDE MNT TO POST TOP BATT.	B1101 SIDE MOUNT BATT BOLT OEM	B1102 SIDE MOUNT BATT BOLT EX LONG	
133331 4.2&1GA OEM NEGATIVE BATTERY	133334 AUTOMOTIVE SIDE MNT EMERG	133339 SIDE MNT TO POST TOP BATT.	B1110 5/16 X 1-1/4 BATT BOLT & NUT TIN PLATED		

PRODUCT CATEGORY: Q

### Special Battery Ends

19 Items • 52 Pcs

IBS No. 642P



Packaged in a Locking Steel Drawer for Easy Storage & Organization

IBS, Inc. SPECIALTY PRODUCTS FOR MAINTENANCE & REPAIR INDUSTRIALBOLT.COM © & © 800-678-1906		Colored Cable Tie Wraps		Assortment No. 710R
BL-4-18 4' 18LB BLUE NYLON TIE		R-4-18 4' 18LB RED NYLON TIE		
Y-4-18 4' 18LB FLOURESCENT YELLOW NYLON TIE		L-4-18 4' 18LB NATURAL NYLON TIE		
B-7-50 7' 50LB BLACK NYLON TIE		B-4-18 4' 18LB BLACK NYLON TIE		
FB-7-50 7' 50LB FLOURESCENT BLUE NYLON TIE		L-7-50 7' 50LB NATURAL NYLON TIE		
FO-7-50 7' 50LB FLOURESCENT ORANGE NYLON TIE		FG-7-50 7' 50LB FLOURESCENT GREEN NYLON TIE		
FY-7-50 7' 50LB FLOURESCENT YELLOW NYLON TIE		FP-7-50 7' 50LB FLOURESCENT PINK NYLON TIE		

PRODUCT CATEGORY: Q

### Colored Cable Tie Wraps

12 Items • 1200 Pcs

IBS No. 710R



Packaged in a Locking Steel Drawer for Easy Storage & Organization



# IBS, INCORPORATED

## Assortments - Electrical (Q)



IBS, Inc. SPECIALTY PRODUCTS FOR MAINTENANCE & REPAIR INDUSTRIALBOLTY.COM © © © 800-678-1506				Electrical Tape
				Assortment No. 711R
145237 3/4 X 60FT BLUE ELECTRICAL TAPE 	145238 3/4 X 60FT GREEN ELECTRICAL TAPE 	145239 3/4 X 60FT WHITE ELECTRICAL TAPE 	B9211 1' X 30' FUSION TAPE 	
145240 3/4 X 60FT BROWN ELECTRICAL TAPE 	145241 3/4 X 60FT ORANGE ELECTRICAL TAPE 	145242 3/4 X 60FT YELLOW ELECTRICAL TAPE 	B9201 SILICONE TAPE - RED 	
145243 3/4 X 60FT GRAY ELECTRICAL TAPE 	145244 3/4 X 60FT RED ELECTRICAL TAPE 	N9010 3/4 X 60YD PVC ELECTRICAL 		

PRODUCT CATEGORY: Q

**Electrical Tape**  
11 Items • 20 Pcs  
IBS No. 711R



Packaged in a Locking Steel Drawer for Easy Storage & Organization

IBS, Inc. SPECIALTY PRODUCTS FOR MAINTENANCE & REPAIR INDUSTRIALBOLTY.COM © © © 800-678-1506				Blade Fuses
				ATM, ATC and MAX
				720R
ATM2 	ATM3 	ATM4 	ATM5 	
ATM7-1/2 	ATM10 	ATM15 	ATM20 	
ATM25 	ATM30 	ATC2 	ATC3 	
ATC4 	ATC5 	ATC7-1/2 	ATC10 	
ATC15 	ATC20 	ATC25 	ATC30 	
ATC40 				
MAX20 	MAX30 	MAX40 	MAX50 	
MAX60 	MAX70 	MAX80 	FP-C FUSE PULLER 	

PRODUCT CATEGORY: Q

**Blade Fuses**  
29 Items • 127 Pcs  
IBS No. 720R



Packaged in a Locking Steel Drawer for Easy Storage & Organization

IBS, Inc. SPECIALTY PRODUCTS FOR MAINTENANCE & REPAIR INDUSTRIALBOLTY.COM © © © 800-678-1506				12V Miniature Auto Bulb Assortment
				Assortment No. 722R
B37 14V AUTO AIR COURTESY DOME IND AUTOMOTIVE BULB GLASS WEDGE 	B53 12V AUTO INSTRUMENT INDICATOR AUTOMOTIVE BULB MINI BASE 	B57 12V AUTO INSTRUMENT INDICATOR AUTOMOTIVE BULB MINI BASE 	B67 12V PARKING DOME INDICATOR AUTOMOTIVE BULB MINI BASE 	
B89 12V PARKING DOME INSTRUMENT AUTOMOTIVE BULB MINI BASE 	B97 12V PARKING LICENSE PLATE AUTOMOTIVE BULB MINI BASE 	B194 12V INSTRUMENT SIDE MARKER AUTOMOTIVE BULB GLASS WEDGE 	B194NA 12V SIDE MARKER PARK AMBER AUTOMOTIVE BULB 	
B906 12V SIDE MARKER DOME AUTOMOTIVE BULB 	B912 12V SIDE MARKER DOME AUTOMOTIVE BULB 	B916 12V PARKING SIDE MARKER AUTOMOTIVE BULB 	B921 12V SIDE MARKER DOME AUTOMOTIVE BULB 	
B1156 12V FRONT REAR TURN LIGHT AUTOMOTIVE BULB 	B1157 12V STOP TURN SIGNAL LIGHT AUTOMOTIVE BULB 	B1157NA 12V STOP TAIL SIGNAL AMBER AUTOMOTIVE BULB 	B1893 14V HD INSTRUMENT MINI BASE AUTOMOTIVE BULB 	
B1895 12V PARKING SIDE MARKER AUTOMOTIVE BULB 	B2057 12V STOP TAIL TURN LIGHT AUTOMOTIVE BULB 	B3057 12V STOP TAIL TURN LIGHT AUTOMOTIVE BULB PLASTIC WEDGE 	B3156 12V FRONT REAR TURN LIGHT AUTOMOTIVE BULB PLASTIC WEDGE 	
B3157 12V STOP TAIL TURN LIGHT AUTOMOTIVE BULB PLASTIC WEDGE 	B3157NA 12V STOP TAIL TURN LIGHT AUTOMOTIVE BULB PLASTIC WEDGE 	B457A INSTRUMENT PANEL BULB SOCKET HOLDER 1/2 HOLE 	B458A INSTRUMENT PANEL BULB SOCKET HOLDER 5/8 HOLE 	

PRODUCT CATEGORY: Q

**12V Mini Auto Fuses**  
24 Items • 186 Pcs  
IBS No. 722R



Packaged in a Locking Steel Drawer for Easy Storage & Organization

ASSORTMENTS



# IBS, INCORPORATED

## Assortments - Electrical (Q)

ASSORTMENTS

IBS, Inc. SPECIALTY PRODUCTS FOR MAINTENANCE & REPAIR INDUSTRIALBOLT.COM © & D 800-878-1906		Automotive Fuse Holders & Accessories	
Assortment No. 723R			
139433 ATR MICRO2 ADD A LINE FUSE HOLDER 20AMP 16GA	139431 ATM 16GA IN LINE FUSE HOLDER 32V 20AMP	139422 12GA ATC FUSE HOLDER & COVER BLACK IN LINE	19513 BLADE TYPE WATER-PROOF IN-LINE FUSE HLDR
139434 ATR MICRO2 INLINE FUSE HOLDER 15AMP 16GA SIN LEADS	139420 ATM ADD A LINE FUSE HOLDER 32V 2 FUSE 30A	139427 ATC ADD A LINE FUSE HOLDER TAP 2 ATO/ATC MAX 30A	139425 MAXI IN-LINE FUSE HOLDER WITH COVER 32V 60A
139430 ATM LOW PROFILE ADD-A-LINE FUSE HOLDER	139447 14GA ATM FUSE HOLDER & COVER CLEAR MINI	139450 12GA ATC FUSE HOLDER & COVER CLEAR	139435 FMX INLINE FUSE HOLDER 60AMP 8GA 4IN LEADS 58V
139421 12GA ATM IN-LINE FUSE HOLDER W/ COVER 32V 30A	139428 ATM FUSE BLADE TAP .187 TAB	139429 ATC FUSE BLADE TAP .250 TAB	

PRODUCT CATEGORY: Q

### Automotive Fuse Holders & Accessories

15 Items • 75 Pcs  
IBS No. 723R



Packaged in a Locking Steel Drawer for Easy Storage & Organization

IBS, Inc. SPECIALTY PRODUCTS FOR MAINTENANCE & REPAIR INDUSTRIALBOLT.COM © & D 800-878-1906		Standard Cable Tie Wraps	
Assortment No. 724R			
L-4-18 4 18LB NATURAL NYLON TIE*	L-5-30 5-1/2 30LB NATURAL NYLON TIE*		
L-7-50 7 50LB NATURAL NYLON TIE*			
L-11-50 11 50LB NATURAL NYLON TIE*			
L-14-50 14 50LB NATURAL NYLON TIE*			
L-14-120 14 120LB NATURAL NYLON TIE*			
L-14-120 14 120LB NATURAL NYLON TIE*			

PRODUCT CATEGORY: Q

### Standard Cable Tie Wraps

6 Items • 600 Pcs  
IBS No. 724R



Packaged in a Locking Steel Drawer for Easy Storage & Organization

IBS, Inc. SPECIALTY PRODUCTS FOR MAINTENANCE & REPAIR INDUSTRIALBOLT.COM © & D 800-878-1906		Weather Resistant Cable Tie Wraps	
Assortment No. 725R			
B-4-18 4 18LB BLACK NYLON TIE*	B-5-30 5 30LB BLACK NYLON TIE*		
B-7-50 7 50LB BLACK NYLON TIE*			
B-11-50 11 50LB BLACK NYLON TIE*			
B-14-50 14 BLACK NYLON TIE*			
B-14-120 14 120LB BLACK NYLON TIE*			
B-14-120 14 120LB BLACK NYLON TIE*			

PRODUCT CATEGORY: Q

### Weather-Resistant Cable Tie Wraps

6 Items • 600 Pcs  
IBS No. 725R



Packaged in a Locking Steel Drawer for Easy Storage & Organization

# IBS, INCORPORATED

## Assortments - Electrical (Q)



<b>IBS, Inc.</b> <small>SPECIALTY PRODUCTS FOR MAINTENANCE &amp; REPAIR          INDUSTRIALBOLT.COM © © © 800-678-1506</small>		<b>Releasable Cable Tie Wraps</b>
<small>Assortment No. 726R</small>		
<b>RB-5-50</b> 5' 50LB BLACK RELEASABLE NYLON TIE		
<b>RB-8-50</b> 8' 50LB BLACK RELEASABLE NYLON TIE		
<b>RB-12-50</b> 12' 50LB BLACK RELEASABLE NYLON TIE		
<b>RB-14-50</b> 14' 50LB BLACK RELEASABLE NYLON TIE		
<b>141146</b> 29.5 200# YELLOW NYLON*		

PRODUCT CATEGORY: Q

### Releasable Cable Tie Wraps

5 Items • 310 Pcs  
IBS No. 726R



Packaged in a Locking Steel Drawer for Easy Storage & Organization

<b>IBS, Inc.</b> <small>SPECIALTY PRODUCTS FOR MAINTENANCE &amp; REPAIR          INDUSTRIALBOLT.COM © © © 800-678-1506</small>		<b>Mounting Tie Wraps</b>
<small>Assortment No. 727R</small>		
<b>SM-6-50</b> 6' 50LB STUD MOUNT CABLE TIE WRAP BLACK		
<b>PMB-8-50</b> 8' 50LB BLACK PUSH MOUNT CABLE TIE WRAP		
<b>BH-10-100</b> 9-5/8" 100LB BUTTON HD TIE WRAP BLACK		
<b>MH-7-50</b> 7' 50LB NATURAL MOUNTING NYLON TIE WRAP	<b>MBH-7-50</b> 7' 50LB BLACK NYLON MOUNTING TIE	
<b>MH-14-120</b> 14' 120LB NATURAL MOUNTING NYLON TIE WRAP		
<b>141140</b> 13IN DUAL CLAMP CABLE TIE BLACK		

PRODUCT CATEGORY: Q

### Cable & Tubing Mounting Cable Tie Wraps

7 Items • 255 Pcs  
IBS No. 727R



Packaged in a Locking Steel Drawer for Easy Storage & Organization

<b>IBS, Inc.</b> <small>SPECIALTY PRODUCTS FOR MAINTENANCE &amp; REPAIR          INDUSTRIALBOLT.COM © © © 800-678-1506</small>				<b>Silicone Sealing Tape</b>
<small>Assortment No. 743R</small>				
<b>B9201</b> TAPE SILICONE RED 1" X 36'	<b>B9202</b> TAPE SILICONE BLACK 1" X 36'	<b>B9204</b> TAPE SILICONE GRAY 1" X 36'	<b>B9205</b> TAPE SILICONE CLEAR 1" X 36'	
<b>B9206</b> TAPE SILICONE RED 2" X 10'	<b>B9207</b> TAPE SILICONE BLACK 2" X 10'	<b>B9208</b> TAPE SILICONE GRAY 2" X 10'	<b>B9209</b> TAPE SILICONE CLEAR 2" X 10'	

PRODUCT CATEGORY: Q

### Silicone Sealing Tape

8 Items • 8 Pcs  
IBS No. 743R



Packaged in a Locking Steel Drawer for Easy Storage & Organization

ASSORTMENTS



# IBS, INCORPORATED

## Assortments - Electrical (Q)

ASSORTMENTS

IBS, Inc. SPECIALTY PRODUCTS FOR MAINTENANCE & REPAIR INDUSTRIALBOLT.COM © © © 800-670-1506						Copper Tubular Lugs
						Assortment 755R
B8101 BATT TERM #8AWG #10 STUD LUG 	B6101 BATT TERM #6AWG #10 STUD LUG 	B4141 BATT TERM #4AWG 1/4 STUD LUG 	B2381 BATT TERM #2AWG 3/8 STUD LUG 	B10381 BATT TERM 1/0AWG 3/8 STUD LUG 	B30381 BATT TERM 3/0AWG 3/8 STUD LUG 	
B8141 BATT TERM #8AWG 1/4 STUD LUG 	B6141 BATT TERM #6AWG 1/4 STUD LUG 	B4561 BATT TERM #4AWG 5/16 STUD LUG 	B2503 BATT TERM #2AWG 1/2 STUD LUG 	B10501 BATT TERM 1/0AWG 1/2 STUD LUG 	B30501 BATT TERM 3/0AWG 1/2 STUD LUG 	
B8561 BATT TERM #8AWG 5/16 STUD LUG 	B6561 BATT TERM #6AWG 5/16 STUD LUG 	B4381 BATT TERM #4AWG 3/8 STUD LUG 	B1381 BATT TERM #1AWG 3/8 STUD LUG 	B20381 BATT TERM 2/0AWG 3/8 STUD LUG 	B40381 BATT TERM 4/0AWG 3/8 STUD LUG 	
B8383 BATT TERM #8AWG 3/8 STUD LUG 	B6583 BATT TERM #6AWG 3/8 STUD LUG 	B4503 BATT TERM #4AWG 1/2 STUD LUG 	B1501 BATT TERM #1AWG 1/2 STUD LUG 	B20501 BATT TERM 2/0AWG 1/2 STUD LUG 	B40501 BATT TERM 4/0AWG 1/2 STUD LUG 	

PRODUCT CATEGORY: Q

**Copper Tubular Lugs**  
24 Items • 120 Pcs  
IBS No. 755R



Packaged in a Locking Steel Drawer  
for Easy Storage & Organization

IBS, Inc. SPECIALTY PRODUCTS FOR MAINTENANCE & REPAIR INDUSTRIALBOLT.COM © © © 800-670-1506						Tin Plated Copper Tubular Lugs
						Assortment 760R
B8101P BATT TERM #8AWG #10 STUD LUG 	B6101P BATT TERM #6AWG #10 STUD LUG 	B4141P BATT TERM #4AWG 1/4 STUD LUG 	B2381P BATT TERM #2AWG 3/8 STUD LUG 	B10381P BATT TERM 1/0AWG 3/8 STUD LUG 	B30381P BATT TERM 3/0AWG 3/8 STUD LUG 	
B8141P BATT TERM #8AWG 1/4 STUD LUG 	B6141P BATT TERM #6AWG 1/4 STUD LUG 	B4561P BATT TERM #4AWG 5/16 STUD LUG 	B2503P BATT TERM #2AWG 1/2 STUD LUG 	B10501P BATT TERM 1/0AWG 1/2 STUD LUG 	B30501P BATT TERM 3/0AWG 1/2 STUD LUG 	
B8561P BATT TERM #8AWG 5/16 STUD LUG 	B6561P BATT TERM #6AWG 5/16 STUD LUG 	B4381P BATT TERM #4AWG 3/8 STUD LUG 	B1381P BATT TERM #1AWG 3/8 STUD LUG 	B20381P BATT TERM 2/0AWG 3/8 STUD LUG 	B40381P BATT TERM 4/0AWG 3/8 STUD LUG 	
B8383P BATT TERM #8AWG 3/8 STUD LUG 	B6583P BATT TERM #6AWG 3/8 STUD LUG 	B4503P BATT TERM #4AWG 1/2 STUD LUG 	B1501P BATT TERM #1AWG 1/2 STUD LUG 	B20501P BATT TERM 2/0AWG 1/2 STUD LUG 	B40501P BATT TERM 4/0AWG 1/2 STUD LUG 	

PRODUCT CATEGORY: Q

**Tin Plated Copper Tubular Lugs**  
24 Items • 120 Pcs  
IBS No. 760R



Packaged in a Locking Steel Drawer  
for Easy Storage & Organization

IBS, Inc. SPECIALTY PRODUCTS FOR MAINTENANCE & REPAIR INDUSTRIALBOLT.COM © © © 800-670-1506					Sealed Wire Connectors II
					Assortment No. 761R
B5560 26-24 TO 22-18 MULTILINK STEP BUTT CONNECTOR 	B5610 20-18 X 16-14 CRIMP & SEAL STEP BUTT CON 	B5716 20-18 HYDRALINK IN LINE BUTT CONNECTOR 	B5916 22-18 OPTISEAL BUTT CONNECTOR 	B5110 20-18 CRIMP & SEAL BUTT CONNECTOR 	
B5530 20-18 TO 16-14 MULTILINK STEP BUTT CONN 	B5620 16-14 12-10 CRIMP & SEAL STEP BUTT CON 	B5714 16-14 HYDRALINK IN LINE BUTT CONNECTOR 	B5914 16-14 OPTISEAL BUTT CONNECTOR 	B5210 16-14 CRIMP & SEAL BUTT CONNECTOR 	
B5540 16-14 TO 12-10 MULTILINK STEP BUTT CONN 	B5630 12-10 X 8GA CRIMP & SEAL STEP BUTT CONN 	B5710 12-10 HYDRALINK IN LINE BUTT CONNECTOR 	B5910 12-10 OPTISEAL BUTT CONNECTOR 	B5310 12-10 CRIMP & SEAL BUTT CONNECTOR 	
B5550 12-10 TO 8GA MULTILINK STEP BUTT CONN 	B5814 22-14 HYDRALINK CLOSED END CONNECTOR 	B5810 18-10 HYDRALINK CLOSED END CONNECTOR 			

PRODUCT CATEGORY: Q

**Sealed Wire Connectors II**  
17 Items • 145 Pcs  
IBS No. 761R



Packaged in a Locking Steel Drawer  
for Easy Storage & Organization

# IBS, INCORPORATED

## Assortments - Electrical (Q)



IBS, Inc. SPECIALTY PRODUCTS FOR MAINTENANCE & REPAIR INDUSTRIALBOLTY.COM 800-470-1506					Micro Fuses
					Assortment No. 766R
<b>ATR5</b> 5AMP MICRO2 FUSE 32V TAN FUSE 	<b>ATR7-1/2</b> 7-1/2AMP MICRO2 FUSE 32V BROWN FUSE 	<b>ATR10</b> 10AMP MICRO2 FUSE 32V RED FUSE 	<b>ATR15</b> 15AMP MICRO2 FUSE 32V BLUE FUSE 	<b>ATR20</b> 20AMP MICRO2 FUSE 32V YELLOW FUSE 	
<b>ATR25</b> 25AMP MICRO2 FUSE 32V CLEAR FUSE 	<b>ATR30</b> 30AMP MICRO2 FUSE 32V GREEN FUSE 	<b>ATL5</b> 5AMP MICRO3 FUSE 32V TAN FUSE 	<b>ATL7-1/2</b> 7-1/2AMP MICRO3 FUSE 32V BROWN FUSE 	<b>ATL10</b> 10AMP MICRO3 FUSE 32V RED FUSE 	
<b>ATL15</b> 15AMP MICRO3 FUSE 32V BLUE FUSE 	<b>FMM15</b> 15AMP MCASE FUSE 32V GREY 	<b>FMM20</b> 20AMP MCASE FUSE 32V BLUE 	<b>FMM25</b> 25AMP MCASE FUSE 32V WHITE 	<b>FMM30</b> 30AMP MCASE FUSE 32V PINK 	
<b>FMM40</b> 40AMP MCASE FUSE 32V GREEN 					

PRODUCT CATEGORY: Q

**Micro Fuses**  
16 Items • 135 Pcs  
IBS No. 766R



Packaged in a Locking Steel Drawer for Easy Storage & Organization

IBS, Inc. SPECIALTY PRODUCTS FOR MAINTENANCE & REPAIR INDUSTRIALBOLTY.COM 800-470-1506						Deutsch DT Connectors & Terminals with Crimping & Removal Tools
						Assortment No. 768R
<b>125104</b> DEUTSCH 2WAY RECEPTACLE HOUSING 	<b>125106</b> DEUTSCH 3WAY RECEPTACLE HOUSING 	<b>125108</b> DEUTSCH 4WAY RECEPTACLE HOUSING 	<b>125110</b> DEUTSCH 6WAY RECEPTACLE HOUSING 	<b>125112</b> DEUTSCH 8WAY RECEPTACLE HOUSING 	<b>125100</b> DEUTSCH 16-18GA SOCKET FOR PIN 	
<b>125105</b> DEUTSCH 2WAY PLUG HOUSING 	<b>125107</b> DEUTSCH 3WAY PLUG HOUSING 	<b>125109</b> DEUTSCH 4WAY PLUG HOUSING 	<b>125111</b> DEUTSCH 6WAY PLUG HOUSING 	<b>125113</b> DEUTSCH 8WAY PLUG HOUSING 	<b>125102</b> DEUTSCH 16-18GA PIN FOR RECEPTACLE 	
<b>125114</b> DEUTSCH 2WAY RECEPTACLE WEDGE 	<b>125116</b> DEUTSCH 3WAY RECEPTACLE WEDGE 	<b>125118</b> DEUTSCH 4WAY RECEPTACLE WEDGE 	<b>125120</b> DEUTSCH 6WAY FEMALE WEDGE 	<b>125122</b> DEUTSCH 8WAY FEMALE WEDGE 	<b>125101</b> DEUTSCH 14-16GA SOCKET FOR PLUG 	
<b>125115</b> DEUTSCH 2WAY PLUG WEDGE 	<b>125117</b> DEUTSCH 3WAY PLUG WEDGE 	<b>125119</b> DEUTSCH 4WAY PLUG WEDGE 	<b>125121</b> DEUTSCH 6WAY MALE WEDGE 	<b>125123</b> DEUTSCH 8WAY MALE WEDGE 	<b>125103</b> DEUTSCH 14-16GA PIN FOR RECEPTACLE 	

PRODUCT CATEGORY: Q

**Deutsch DT Connectors & Terminals with Crimping & Removal Tools**

26 Items • 134 Pcs  
IBS No. 768R



Packaged in a Locking Steel Drawer for Easy Storage & Organization

IBS, Inc. SPECIALTY PRODUCTS FOR MAINTENANCE & REPAIR INDUSTRIALBOLTY.COM 800-470-1506						Deutsch DT Connectors & Terminals
						Assortment No. 769R
<b>125104</b> DEUTSCH 2WAY RECEPTACLE HOUSING 	<b>125106</b> DEUTSCH 3WAY RECEPTACLE HOUSING 	<b>125108</b> DEUTSCH 4WAY RECEPTACLE HOUSING 	<b>125110</b> DEUTSCH 6WAY RECEPTACLE HOUSING 	<b>125112</b> DEUTSCH 8WAY RECEPTACLE HOUSING 	<b>125100</b> DEUTSCH 16-18GA SOCKET FOR PIN 	
<b>125105</b> DEUTSCH 2WAY PLUG HOUSING 	<b>125107</b> DEUTSCH 3WAY PLUG HOUSING 	<b>125109</b> DEUTSCH 4WAY PLUG HOUSING 	<b>125111</b> DEUTSCH 6WAY PLUG HOUSING 	<b>125113</b> DEUTSCH 8WAY PLUG HOUSING 	<b>125102</b> DEUTSCH 16-18GA PIN FOR RECEPTACLE 	
<b>125114</b> DEUTSCH 2WAY RECEPTACLE WEDGE 	<b>125116</b> DEUTSCH 3WAY RECEPTACLE WEDGE 	<b>125118</b> DEUTSCH 4WAY RECEPTACLE WEDGE 	<b>125120</b> DEUTSCH 6WAY FEMALE WEDGE 	<b>125122</b> DEUTSCH 8WAY FEMALE WEDGE 	<b>125101</b> DEUTSCH 14-16GA SOCKET FOR PLUG 	
<b>125115</b> DEUTSCH 2WAY PLUG WEDGE 	<b>125117</b> DEUTSCH 3WAY PLUG WEDGE 	<b>125119</b> DEUTSCH 4WAY PLUG WEDGE 	<b>125121</b> DEUTSCH 6WAY MALE WEDGE 	<b>125123</b> DEUTSCH 8WAY MALE WEDGE 	<b>125103</b> DEUTSCH 14-16GA PIN FOR RECEPTACLE 	

PRODUCT CATEGORY: Q

**Deutsch DT Connectors & Terminals**

24 Items • 132 Pcs  
IBS No. 769R



Packaged in a Locking Steel Drawer for Easy Storage & Organization

ASSORTMENTS



# IBS, INCORPORATED

## Assortments - Electrical (Q)

ASSORTMENTS

<b>IBS, Inc.</b> <small>SPECIALTY PRODUCTS FOR MAINTENANCE &amp; REPAIR  INDUSTRIALBOLT.COM © © © 800-670-1906</small>					<b>Metripack 280 Series  Electrical Connectors</b>
<small>Assortment No. 770R</small>					
125204 METRIPACK 1 PIN MALE CONNECTOR BODY	125208 METRIPACK 1 PIN FEMALE CONNECTOR BODY	125218 METRIPACK 1 PIN T.P.A. MALE & FEMALE	125201 METRIPACK GREEN CABLE SEAL 18-16 & 20-18 GAUGE	125212 METRIPACK 16-18 GAUGE MALE TERMINAL	
125205 METRIPACK 2 PIN MALE CONNECTOR BODY	125209 METRIPACK 2 PIN FEMALE CONNECTOR BODY	125219 METRIPACK 2 PIN T.P.A. MALE & FEMALE	125202 METRIPACK GRAY CABLE SEAL 14-16 GAUGE	125215 METRIPACK 16-18 GAUGE FEMALE TERMINAL	
125206 METRIPACK 3 PIN MALE CONNECTOR BODY	125210 METRIPACK 3 PIN FEMALE CONNECTOR BODY	125220 & 125221 METRIPACK 3 PIN T.P.A. MALE AND FEMALE	125203 METRIPACK BLUE CABLE SEAL 12-14 GAUGE	125213 METRIPACK 12-14 GAUGE MALE TERMINAL	
125207 METRIPACK 5 PIN MALE CONNECTOR BODY	125211 METRIPACK 5 PIN FEMALE CONNECTOR BODY	125222 & 125223 METRIPACK 5 PIN T.P.A. MALE AND FEMALE	125224 METRIPACK CAVITY PLUG	125216 METRIPACK 12-14 GAUGE FEMALE TERMINAL	

**PRODUCT CATEGORY: Q**

<b>IBS, Inc.</b> <small>SPECIALTY PRODUCTS FOR MAINTENANCE &amp; REPAIR  INDUSTRIALBOLT.COM © © © 800-670-1906</small>					<b>Metripack 280 Series  Electrical Connectors &amp; Tools</b>
<small>Assortment No. 771R</small>					
125204 METRIPACK 1 PIN MALE CONNECTOR BODY	125208 METRIPACK 1 PIN FEMALE CONNECTOR BODY	125218 METRIPACK 1 PIN T.P.A. MALE & FEMALE	125201 METRIPACK GREEN CABLE SEAL 18-16 & 20-18 GAUGE	125212 METRIPACK 16-18 GAUGE MALE TERMINAL	
125205 METRIPACK 2 PIN MALE CONNECTOR BODY	125209 METRIPACK 2 PIN FEMALE CONNECTOR BODY	125219 METRIPACK 2 PIN T.P.A. MALE & FEMALE	125202 METRIPACK GRAY CABLE SEAL 14-16 GAUGE	125215 METRIPACK 16-18 GAUGE FEMALE TERMINAL	
125206 METRIPACK 3 PIN MALE CONNECTOR BODY	125210 METRIPACK 3 PIN FEMALE CONNECTOR BODY	125220 & 125221 METRIPACK 3 PIN T.P.A. MALE AND FEMALE	125203 METRIPACK BLUE CABLE SEAL 12-14 GAUGE	125213 METRIPACK 12-14 GAUGE MALE TERMINAL	
125207 METRIPACK 5 PIN MALE CONNECTOR BODY	125211 METRIPACK 5 PIN FEMALE CONNECTOR BODY	125222 & 125223 METRIPACK 5 PIN T.P.A. MALE AND FEMALE	125224 METRIPACK CAVITY PLUG	125216 METRIPACK 12-14 GAUGE FEMALE TERMINAL	

**PRODUCT CATEGORY: Q**

<b>IBS, Inc.</b> <small>SPECIALTY PRODUCTS FOR MAINTENANCE &amp; REPAIR  INDUSTRIALBOLT.COM © © © 800-670-1906</small>					<b>Weatherpack Connectors  and Terminals</b>
<small>Assortment No. 772R</small>					
125307 WEATHERPACK 1 CAVITY SHROUD MALE	125309 WEATHERPACK 2 CAVITY SHROUD MALE	125311 WEATHERPACK 3 CAVITY SHROUD MALE	125313 WEATHERPACK 4 CAVITY SHROUD MALE	125315 WEATHERPACK 6 CAVITY SHROUD MALE	
125306 WEATHERPACK 1 CAVITY TOWER FEMALE	125308 WEATHERPACK 2 CAVITY TOWER FEMALE	125310 WEATHERPACK 3 CAVITY TOWER FEMALE	125312 WEATHERPACK 4 CAVITY TOWER FEMALE	125314 WEATHERPACK 6 CAVITY TOWER FEMALE	
125300 WEATHERPACK 20-18GA MALE TERMINAL	125302 WEATHERPACK 16-14GA MALE TERMINAL	125304 WEATHERPACK 12GA MALE TERMINAL	125201 METRIPACK AND WEATHERPACK SEAL	125203 METRIPACK AND WEATHERPACK SEAL	
125301 WEATHERPACK 20-18GA FEMALE TERMINAL	125303 WEATHERPACK 16-14GA FEMALE TERMINAL	125305 WEATHERPACK 12GA FEMALE TERMINAL	125202 METRIPACK WEATHERPACK SEAL	125224 METRIPACK & WEATHERPACK CAVITY PLUG	

**PRODUCT CATEGORY: Q**

## Metripack 280 Series

20 Items • 430 Pcs  
IBS No. 770R



Packaged in a Locking Steel Drawer  
for Easy Storage & Organization

## Metripack 280 Series with Crimping & Removal Tools

22 Items • 432 Pcs  
IBS No. 771R



Packaged in a Locking Steel Drawer  
for Easy Storage & Organization

## Weatherpack Series

20 Items • 329 Pcs  
IBS No. 772R



Packaged in a Locking Steel Drawer  
for Easy Storage & Organization

# IBS, INCORPORATED

## Assortments - Electrical (Q)



**IBS, Inc.**  
SPECIALTY PRODUCTS FOR MAINTENANCE & REPAIR  
INDUSTRIALBOLT.COM © © © 800-678-1506

### Weatherpack Connectors and Terminals with Tools

Assortment No. 773R

125307 WEATHERPACK 1 CAVITY SHROUD MALE	125309 WEATHERPACK 2 CAVITY SHROUD MALE	125311 WEATHERPACK 3 CAVITY SHROUD MALE	125313 WEATHERPACK 4 CAVITY SHROUD MALE	125315 WEATHERPACK 6 CAVITY SHROUD MALE	125325 WEATHERPACK 22-12GA CRIMPER 125326 WEATHERPACK TERM EXTRACTOR TOOL
125306 WEATHERPACK 1 CAVITY TOWER FEMALE	125308 WEATHERPACK 2 CAVITY TOWER FEMALE	125310 WEATHERPACK 3 CAVITY TOWER FEMALE	125312 WEATHERPACK 4 CAVITY TOWER FEMALE	125314 WEATHERPACK 6 CAVITY TOWER FEMALE	
125300 WEATHERPACK 20-18GA MALE TERMINAL	125302 WEATHERPACK 16-14GA MALE TERMINAL	125304 WEATHERPACK 12GA MALE TERMINAL	125201 METRIPACK/WEATHERPK SEAL GRN 18-16/20-18GA	125203 METRIPACK/WEATHERPK SEAL BLUE 14-12 GA	
125301 WEATHERPACK 20-18GA FEMALE TERMINAL	125303 WEATHERPACK 16-14GA FEMALE TERMINAL	125305 WEATHERPACK 12GA FEMALE TERMINAL	125202 METRIPACK/WEATHERPK SEAL GRAY 16-14 GAUGE	125224 METRIPACK/WEATHERPK CAVITY PLUG	

PRODUCT CATEGORY: Q

## Weatherpack Series with Crimping & Removal Tools

22 Items • 331 Pcs  
IBS No. 773R



Packaged in a Locking Steel Drawer for Easy Storage & Organization

**IBS, Inc.**  
SPECIALTY PRODUCTS FOR MAINTENANCE & REPAIR  
INDUSTRIALBOLT.COM © © © 800-678-1506

### Deutsch DT Connectors & Terminals

Assortment No. 780R

125104 DEUTSCH 2WAY FEMALE HOUSING	125106 DEUTSCH 3WAY FEMALE HOUSING	125108 DEUTSCH 4WAY FEMALE HOUSING	125110 DEUTSCH 6WAY FEMALE HOUSING	125112 DEUTSCH 8WAY FEMALE HOUSING	125100 DEUTSCH 16-18GA FEM TERMINAL
125105 DEUTSCH 2WAY MALE HOUSING	125107 DEUTSCH 3WAY MALE HOUSING	125109 DEUTSCH 4WAY MALE HOUSING	125111 DEUTSCH 6WAY MALE HOUSING	125113 DEUTSCH 8WAY MALE HOUSING	125102 DEUTSCH 16-18GA MALE TERMINAL
125114 DEUTSCH 2WAY FEMALE WEDGE	125116 DEUTSCH 3WAY FEMALE WEDGE	125118 DEUTSCH 4WAY FEMALE WEDGE	125120 DEUTSCH 6WAY FEMALE WEDGE	125122 DEUTSCH 8WAY FEMALE WEDGE	125101 DEUTSCH 14-16GA FEM TERMINAL
125115 DEUTSCH 2WAY MALE WEDGE	125117 DEUTSCH 3WAY MALE WEDGE	125119 DEUTSCH 4WAY MALE WEDGE	125121 DEUTSCH 6WAY MALE WEDGE	125123 DEUTSCH 8WAY MALE WEDGE	125103 DEUTSCH 14-16GA MALE TERMINAL

PRODUCT CATEGORY: Q

## Deutsch DT Connectors & Terminals II with Crimping & Removal Tools

26 Items • 134 Pcs  
IBS No. 780R



Packaged in a Locking Steel Drawer for Easy Storage & Organization

**IBS, Inc.**  
SPECIALTY PRODUCTS FOR MAINTENANCE & REPAIR  
INDUSTRIALBOLT.COM © © © 800-678-1506

### Metripack 280 Series Electrical Connectors & Tools

Assortment No. 781R

125204 METRIPACK 1 PIN MALE CONNECTOR BODY	125208 METRIPACK 1 PIN FEMALE CONNECTOR BODY	125218 METRIPACK 1 PIN T.P.A. MALE & FEMALE	125201 METRIPACK GREEN CABLE SEAL 18-16 & 20-18 GAUGE	125212 METRIPACK 16-18 GAUGE MALE TERMINAL	125325 - CRIMPING TOOL 125326 - REMOVAL TOOL
125205 METRIPACK 2 PIN MALE CONNECTOR BODY	125209 METRIPACK 2 PIN FEMALE CONNECTOR BODY	125219 METRIPACK 2 PIN T.P.A. MALE & FEMALE	125202 METRIPACK GRAY CABLE SEAL 18-16 GAUGE	125215 METRIPACK 16-18 GAUGE FEMALE TERMINAL	
125206 METRIPACK 3 PIN MALE CONNECTOR BODY	125210 METRIPACK 3 PIN FEMALE CONNECTOR BODY	125220 & 125221 METRIPACK 3 PIN T.P.A. MALE AND FEMALE	125203 METRIPACK BLUE CABLE SEAL 12-14 GAUGE	125213 METRIPACK 12-14 GAUGE MALE TERMINAL	
125207 METRIPACK 5 PIN MALE CONNECTOR BODY	125211 METRIPACK 5 PIN FEMALE CONNECTOR BODY	125222 & 125223 METRIPACK 5 PIN T.P.A. MALE AND FEMALE	125224 METRIPACK CAVITY PLUG	125216 METRIPACK 12-14 GAUGE FEMALE TERMINAL	

PRODUCT CATEGORY: Q

## Metripack 280 Series II with Crimping & Removal Tools

22 Items • 432 Pcs  
IBS No. 761R



Packaged in a Locking Steel Drawer for Easy Storage & Organization



# IBS, INCORPORATED

## Assortments - Electrical (Q)

ASSORTMENTS

IBS, Inc. SPECIALTY PRODUCTS FOR MAINTENANCE & REPAIR INDUSTRIALBOLT.COM • • • 800-670-1506		7" Colored Cable Tie Wraps	
BL-7-50 7" 50LB BLUE NYLON TIE		GY-7-50 7" 50LB GRAY NYLON TIE	
Y-7-50 7" 50LB YELLOW NYLON TIE		GR-7-50 7" 50LB GREEN NYLON TIE	
R-7-50 7" 50LB RED NYLON TIE		P-7-50 7" 50LB PURPLE NYLON TIE	
BR-7-50 7" 50LB BROWN NYLON TIE		FO-7-50 7" 50LB FLUORESCENT ORANGE NYLON TIE	
FB-7-50 7" 50LB FLUORESCENT BLUE NYLON TIE		FP-7-50 7" 50LB FLUORESCENT PINK NYLON TIE	
FY-7-50 7" 50LB FLUORESCENT YELLOW NYLON TIE		FG-7-50 7" 50LB FLUORESCENT GREEN NYLON TIE	

Assortment No. 786R

PRODUCT CATEGORY: Q

### 8" Colored Cable Tie Wraps

12 Items • 1200 Pcs  
IBS No. 786R



Packaged in a Locking Steel Drawer for Easy Storage & Organization

IBS, Inc. SPECIALTY PRODUCTS FOR MAINTENANCE & REPAIR INDUSTRIALBOLT.COM • • • 800-670-1506		Crimp & Seal Long Neck Terminals	
136025 22-18 CRIMP & SEAL #6 LONG NECK RING		136029 16-14 CRIMP & SEAL #8 LONG NECK RING	
136026 22-18 CRIMP & SEAL #8 LONG NECK RING		136030 16-14 CRIMP & SEAL #10 LONG NECK RING	
136027 22-18 CRIMP & SEAL #10 LONG NECK RING		136031 16-14 CRIMP & SEAL 1/4 LONG NECK RING	
136028 16-14 CRIMP & SEAL #6 LONG NECK RING		136032 16-14 CRIMP & SEAL 5/16 LONG NECK RING	
		136033 16-14 CRIMP & SEAL 3/8 LONG NECK RING	
		136034 12-10 CRIMP & SEAL #8 LONG NECK RING	
		136035 12-10 CRIMP & SEAL #10 LONG NECK RING	
		136036 12-10 CRIMP & SEAL 1/4 LONG NECK RING	
		136037 12-10 CRIMP & SEAL 5/16 LONG NECK RING	
		136038 12-10 CRIMP & SEAL 3/8 LONG NECK RING	

Assortment No. 790R

PRODUCT CATEGORY: Q

### Long Neck Crimp & Seal Terminals

14 Items • 140 Pcs  
IBS No. 790R



Packaged in a Locking Steel Drawer for Easy Storage & Organization

IBS, Inc. SPECIALTY PRODUCTS FOR MAINTENANCE & REPAIR INDUSTRIALBOLT.COM • • • 800-670-1506		Crimp & Seal Wire Ends w/ Long Neck Ring Terminals			
B5110 20-18 CRIMP & SEAL BUTT CONNECTOR		B5118 20-18 #10 CRIMP & SEAL SPADE TERM		136028 16-14 #6 CRIMP & SEAL LONG NECK RING	
136025 22-18 #6 CRIMP & SEAL LONG NECK RING		B5155 20-18 CRIMP & SEAL .250 MALE CONN		136029 16-14 #8 CRIMP & SEAL LONG NECK RING	
136026 22-18 #8 CRIMP & SEAL LONG NECK RING		B5145 20-18 CRIMP & SEAL .250 FEMALE CONN		136030 16-14 #10 CRIMP & SEAL LONG NECK RING	
136027 22-18 #10 CRIMP & SEAL LONG NECK RING		B5210 16-14 CRIMP & SEAL BUTT CONNECTOR		136031 16-14 1/4 CRIMP & SEAL LONG NECK RING	
		B5255 16-14 CRIMP & SEAL .250 MALE CONN		B5228 16-14 CRIMP & SEAL #10 SPADE TERM	
		136033 16-14 3/8 CRIMP & SEAL LONG NECK RING		B5255 16-14 CRIMP & SEAL .250 MALE CONN	
		B5310 12-10 CRIMP & SEAL BUTT CONNECTOR		136034 12-10 #8 CRIMP & SEAL LONG NECK RING	
		136038 12-10 3/8 CRIMP & SEAL LONG NECK RING		B5331 12-10 CRIMP & SEAL #10 SPADE TERM	
		136035 12-10 1/4 CRIMP & SEAL LONG NECK RING		B5355 12-10 CRIMP & SEAL .250 FEMALE CONN	
		B5245 16-14 CRIMP & SEAL .250 FEMALE CONN		136036 12-10 1/4 CRIMP & SEAL LONG NECK RING	
		136036 12-10 1/4 CRIMP & SEAL LONG NECK RING		B5345 12-10 CRIMP & SEAL .250 FEMALE CONN	

Assortment No. 791R

PRODUCT CATEGORY: Q

### Crimp & Seal Terminals with Long Neck Ring Terminals

24 Items • 240 Pcs  
IBS No. 791R



Packaged in a Locking Steel Drawer for Easy Storage & Organization



# IBS, INCORPORATED

## Assortments - Electrical (Q)



<b>Optiseal Terminals</b> <span style="float: right;">Assortment No. 793R</span>					
<b>B5916</b> 22-18 OPTISEAL BUTT CONNECTOR 	<b>136017</b> 22-18 TO 16-14 OPTISEAL STEP BUTT 	<b>B5914</b> 16-14 OPTISEAL BUTT CONNECTOR 	<b>136016</b> 16-14 TO 12-10 OPTISEAL STEP BUTT 	<b>B5910</b> 12-10 OPTISEAL BUTT CONNECTOR 	<b>136015</b> 12-10 TO 8GA OPTISEAL STEP BUTT CONNECTOR 
<b>136018</b> 24-22 TO 22-18 OPTISEAL STEP BUTT 	<b>136014</b> 22-18 #10 OPTISEAL RING TERMINAL 	<b>136007</b> 16-14 #8 OPTISEAL RING TERMINAL 	<b>136011</b> 16-14 3/8 OPTISEAL RING TERMINAL 	<b>136001</b> 12-10 #8 OPTISEAL RING TERMINAL 	<b>136005</b> 12-10 3/8 OPTISEAL RING TERMINAL 
<b>136012</b> 22-18 #6 OPTISEAL RING TERMINAL 	<b>136023</b> 22-18 .250 FEMALE OPTISEAL CONNECTOR 	<b>136008</b> 16-14 #10 OPTISEAL RING TERMINAL 	<b>136021</b> 16-14 .250 FEMALE OPTISEAL CONNECTOR 	<b>136002</b> 12-10 #10 OPTISEAL RING TERMINAL 	<b>136019</b> 12-10 .250 FEMALE OPTISEAL CONNECTOR 
<b>136013</b> 22-18 #8 OPTISEAL RING TERMINAL 	<b>136024</b> 22-18 .250 MALE OPTISEAL CONNECTOR 	<b>136009</b> 16-14 1/4 OPTISEAL RING TERMINAL 	<b>136039</b> 16-14 .250 MALE OPTISEAL CONNECTOR 	<b>136003</b> 12-10 1/4 OPTISEAL RING TERMINAL 	<b>136020</b> 12-10 .250 MALE OPTISEAL CONNECTOR 

PRODUCT CATEGORY: Q

## Optiseal Terminals

24 Items • 220 Pcs  
IBS No. 793R



Packaged in a Locking Steel Drawer for Easy Storage & Organization

<b>Low Profile and Releasable Cable Tie Wraps</b> <span style="float: right;">Assortment No. 796R</span>	
<b>BLP-14-120</b> 14IN 120LB BLACK NYLON LOW PROFILE TIE WRAP 	
<b>BLP-14-50</b> 14IN 50LB BLACK NYLON LOW PROFILE TIE WRAP 	
<b>RB-5-50</b> 5 50LB BLACK RELEASABLE NYLON TIE WRAP 	<b>BLP-11-50</b> 11IN 50LB BLACK NYLON LOW PROFILE TIE WRAP 
<b>RB-8-50</b> 8 50LB BLACK RELEASABLE NYLON TIE WRAP 	<b>BLP-7-50</b> 7IN 50LB BLACK NYLON LOW PROFILE TIE WRAP 
<b>RB-12-50</b> 12 50LB BLACK RELEASABLE NYLON TIE WRAP 	
<b>RB-14-50</b> 14 50LB BLACK RELEASABLE NYLON TIE WRAP 	

PRODUCT CATEGORY: Q

## Black Low Profile Cable Tie Wraps

8 Items • 700 Pcs  
IBS No. 796R



Packaged in a Locking Steel Drawer for Easy Storage & Organization

<b>Dual Wall Shrink Tubing</b> <span style="float: right;">Assortment No. 800R</span>	
<b>16486</b> 3/16 X 6IN BLACK DUAL WALL SHRINK TUBE 	<b>16481</b> 3/16 X 6IN RED DUAL WALL SHRINK TUBE 
<b>16487</b> 1/4 X 6IN BLACK DUAL WALL SHRINK TUBE 	<b>16482</b> 1/4 X 6IN RED DUAL WALL SHRINK TUBE 
<b>16488</b> 3/8 X 6IN BLACK DUAL WALL SHRINK TUBE 	<b>16483</b> 3/8 X 6IN RED DUAL WALL SHRINK TUBE 
<b>16489</b> 1/2 X 6IN BLACK DUAL WALL SHRINK TUBE 	<b>16484</b> 1/2 X 6IN RED DUAL WALL SHRINK TUBE 
<b>16490</b> 3/4 X 6IN BLACK DUAL WALL SHRINK TUBE 	<b>16492</b> 3/4 X 6IN RED DUAL WALL SHRINK TUBE 
<b>16491</b> 1IN X 6IN BLACK DUAL WALL SHRINK TUBE 	<b>16493</b> 1IN X 6IN RED DUAL WALL SHRINK TUBE 

PRODUCT CATEGORY: Q

## Dual Wall Shrink Tubing

12 Items • 72 Pcs  
IBS No. 800R



Packaged in a Locking Steel Drawer for Easy Storage & Organization

ASSORTMENTS



# IBS, INCORPORATED

## Assortments - Electrical (Q)

ASSORTMENTS

IBS, Inc. SPECIALTY PRODUCTS FOR MAINTENANCE & REPAIR INDUSTRIALBOLTY.COM 800-678-1996				Vinyl Coated Clamps			
				Assortment No. 802R			
16540 1/4ID 1/4 STUD VINYL COATED LOOM CLAMP	16531 1/2ID 1/4 STUD VINYL COATED LOOM CLAMP	16547 1ID 3/8 STUD VINYL COATED LOOM CLAMP	16548 1-1/2ID 3/8 STUD VINYL COATED LOOM CLAMP				
16541 5/16ID 3/8STUD VINYL COATED LOOM CLAMP	16534 5/8ID 1/4 STUD VINYL COATED LOOM CLAMP	16533 1-1/4ID 13/32 STUD VINYL COATED LOOM CLAMP		16550 2ID 3/8 STUD VINYL COATED LOOM CLAMP			
16530 3/8ID 1/4 STUD VINYL COATED LOOM CLAMP	16545 3/4ID 3/8 STUD VINYL COATED LOOM CLAMP						

PRODUCT CATEGORY: Q

### Vinyl Coated Clamps

10 Items • 197 Pcs  
IBS No. 802R



Packaged in a Locking Steel Drawer for Easy Storage & Organization

IBS, Inc. SPECIALTY PRODUCTS FOR MAINTENANCE & REPAIR INDUSTRIALBOLTY.COM 800-678-1996				ATR, ATL & ATM Low-Profile Fuses			
				Assortment No. 822R			
ATR5 5AMP MICRO2 FUSE 32V TAN FUSE	ATR7-1/2 7-1/2AMP MICRO2 FUSE 32V BROWN FUSE	ATR10 10AMP MICRO2 FUSE 32V RED FUSE	ATR15 15AMP MICRO2 FUSE 32V BLUE FUSE	ATR20 20AMP MICRO2 FUSE 32V YELLOW FUSE			
ATR25 25AMP MICRO2 FUSE 32V CLEAR FUSE	ATR30 30AMP MICRO2 FUSE 32V GREEN FUSE	ATL5 5AMP MICRO3 FUSE 32V TAN FUSE	ATL7-1/2 7-1/2AMP MICRO3 FUSE 32V BROWN FUSE	ATL10 10AMP MICRO3 FUSE 32V RED FUSE			
ATL15 15AMP MICRO3 FUSE 32V BLUE FUSE	ATM5LP AUTO FUSE ATM LOW PROFILE 5AMP	ATM7-1/2LP AUTO FUSE ATM LOW PROFILE 7-1/2AMP	ATM10LP AUTO FUSE ATM LOW PROFILE 10AMP	ATM15LP AUTO FUSE ATM LOW PROFILE 15AMP			
ATM20LP AUTO FUSE ATM LOW PROFILE 20AMP	ATM25LP AUTO FUSE ATM LOW PROFILE 25AMP	ATM30LP AUTO FUSE ATM LOW PROFILE 30AMP					

PRODUCT CATEGORY: Q

### ATR, ATL & ATM Low Profile Fuses

18 Items • 160 Pcs  
IBS No. 822R



Packaged in a Locking Steel Drawer for Easy Storage & Organization

IBS, Inc. SPECIALTY PRODUCTS FOR MAINTENANCE & REPAIR INDUSTRIALBOLTY.COM 800-678-1996				Micro Cartridge Fuses			
				Assortment No. 823R			
FMX-20 20AMP BLUE MAXI FUSE JCASE	FMX-25 25AMP WHITE MAXI FUSE JCASE	FMX-30 30AMP PINK MAXI FUSE JCASE	FMX-40 40AMP GREEN MAXI FUSE JCASE	FMX-50 50AMP RED MAXI FUSE JCASE	FMX-60 60AMP YELLOW MAXI FUSE JCASE		
FMX-20LP 20AMP BLUE LP MAXI FUSE JCASE LP - LOW PROFILE	FMX-25LP 25AMP WHITE LP MAXI FUSE JCASE LP - LOW PROFILE	FMX-30LP 30AMP PINK LP MAXI FUSE JCASE LP - LOW PROFILE	FMX-40LP 40AMP GREEN LP MAXI FUSE JCASE LP - LOW PROFILE	FMX-50LP 50AMP RED LP MAXI FUSE JCASE LP - LOW PROFILE	FMX-60LP 60AMP YELLOW LP MAXI FUSE JCASE LP - LOW PROFILE		
FMX-20LP	FMX-25LP	FMX-30LP	FMX-40LP	FMX-50LP	FMX-60LP		
FMM15 15AMP MCASE FUSE 32V GRAY	FMM20 20AMP MCASE FUSE 32V BLUE	FMM25 25AMP MCASE FUSE 32V WHITE	FMM30 30AMP MCASE FUSE 32V PINK	FMM40 40AMP MCASE FUSE 32V GREEN	FMS15 15AMP MCASE FUSE 32V GRAY SLOTTED		
FMS20 20AMP MCASE FUSE 32V BLUE SLOTTED	FMS25 25AMP MCASE FUSE 32V WHITE SLOTTED	FMS30 30AMP MCASE FUSE 32V PINK SLOTTED	FMS40 40AMP MCASE FUSE 32V GREEN SLOTTED	FMS50 50AMP MCASE FUSE 32V RED SLOTTED	FMS60 60AMP MCASE FUSE 32V YELLOW SLOTTED		
FMS20	FMS25	FMS30	FMS40	FMS50	FMS60		

PRODUCT CATEGORY: Q

### Micro Cartridge Fuses

24 Items • 48 Pcs  
IBS No. 823R



Packaged in a Locking Steel Drawer for Easy Storage & Organization

# IBS, INCORPORATED

## Assortments - Electrical (Q)



<b>Automotive Circuit Breakers</b> ATM & ATC							
Assortment No. 824R							
CB212-10 10AMP ATM MINI CIRC BREAKER II	CB212-15 15AMP ATM MINI CIRCUIT BREAKER II	CB212-20 20AMP ATM MINI CIRC BREAKER II	CB212-25 25AMP ATM MINI CIRC BREAKER II	CB212-30 30AMP ATM MINI CIRC BREAKER II	CB233-05 5AMP ATM MINI RESET CB TYPE III	CB233-10 10AMP ATM MINI RESET CB TYPE III	CB233-15 15AMP ATM MINI RESET CB TYPE III
CB233-20 20AMP ATM MINI RESET CB TYPE III	CB233-25 25AMP ATM MINI RESET CB TYPE III	CB233-30 30AMP ATM MINI RESET CB TYPE III	CB221-10 10AMP ATC CIRCUIT BREAKER TYPE I	CB221-15 15AMP ATC CIRCUIT BREAKER TYPE I	CB221-20 20AMP ATC CIRC BREAKER TYPE I	CB221-25 25AMP ATC CIRCUIT BREAKER TYPE I	CB221-30 30AMP ATC CIRCUIT BREAKER TYPE I
CB223-10 10AMP ATC 24V RESET CB TYPE III	CB223-15 15AMP ATC 24V RESET CB TYPE III	CB223-20 20AMP ATC 24V RESET CB TYPE III	CB223-25 25AMP ATC 24V RESET CB TYPE III	CB223-30 30AMP ATC 24V RESET CB TYPE III	CB227-10 10AMP ATC RESET CB TYPE III RED	CB227-15 15AMP ATC RESET CB TYPE III BLUE	CB227-20 20AMP ATC RESET CB TYPE III YELLOW
CB227-25 25AMP ATC RESET CB TYPE III WHITE	CB227-30 30AMP ATC RESET CB TYPE III GREEN	UCB-10 10AMP ATM CB SNAP OFF BLADES	UCB-15 15AMP ATM CB SNAP OFF BLADES	UCB-20 20AMP ATM CB SNAP OFF BLADES	UCB-25 25AMP ATM CB SNAP OFF BLADES	UCB-30 30AMP ATM CB SNAP OFF BLADES	

PRODUCT CATEGORY: Q

## Automotive Circuit Breakers ATM & ATC

31 Items • 46 Pcs  
IBS No. 824R



Packaged in a Locking Steel Drawer for Easy Storage & Organization

<b>Eco-Max Battery Ends &amp; Shrink Tubing</b>			
Assortment No. 835R			
BAL1038 1/0 X 3/8ST HVY DUTY TUBULAR	BAL2038 2/0 X 3/8ST HVY DUTY TUBULAR	B3405 2-4/0GA X 6' RED HVY WALL	B3505 2-4/0GA X 6' BLACK HVY
E2110 ECOMAX BATT TERM 1/0 GA POS	E2112 ECOMAX BATT TERM 2/0 GA POS		
E2109 ECOMAX BATT TERM 1/0 GA NEG	E2111 ECOMAX BATT TERM 2/0 GA NEG		

PRODUCT CATEGORY: Q

## EcoMax Battery Ends & Shrink Tubing

8 Items • 34 Pcs  
IBS No. 835R



Packaged in a Locking Steel Drawer for Easy Storage & Organization

<b>Multilink Wire Ends w/ Thermal Indicator Butt Connectors</b>					
Assortment No. 859R					
BT5518 20-18 MULTILINK BUTT CONNECTOR WITH THERMAL INDICATOR	B5530 20-18 TO 16-14 MULTILINK STEP	BT5514 16-14 MULTILINK BUTT CONNECTOR WITH THERMAL INDICATOR	B5540 16-14 TO 12-10 MULTILINK STEP	BT5510 12-10 MULTILINK BUTT CONNECTOR WITH THERMAL INDICATOR	B5550 12-10 TO 8GA MULTILINK STEP
125702 20-18 MULTILINK #8 RING TERM	125713 20-18 MULTILINK #10 SPADE TERM	125705 16-14 MULTILINK #8 RING TERM	125714 16-14 MULTILINK #10 SPADE TERM	125709 12-10 MULTILINK #10 RING TERM	125715 12-10 MULTILINK #10 SPADE TERM
125703 20-18 MULTILINK #10 RING TERM	125716 20-18 MULTILINK .250 MALE	125706 16-14 MULTILINK #10 RING TERM	125718 16-14 MULTILINK .250 MALE	125710 12-10 MULTILINK 1/4 RING TERM	125720 12-10 MULTILINK .250 MALE
125704 20-18 MULTILINK 1/4 RING TERM	125717 20-18 MULTILINK .250 FEMALE	125707 16-14 MULTILINK 1/4 RING TERM	125719 16-14 MULTILINK .250 FEMALE	125711 12-10 MULTILINK 3/8 RING TERM	125721 12-10 MULTILINK .250 FEMALE

PRODUCT CATEGORY: Q

## Multilink Wire Ends w/ Thermal Indicator Butt Connectors

24 Items • 175 Pcs  
IBS No. 859R



Packaged in a Locking Steel Drawer for Easy Storage & Organization

ASSORTMENTS



# IBS, INCORPORATED

## Assortments - Hose Clamps (R)



Two-Ear  
Hose Clamps

**Two-Ear Hose Clamps**  
**16 Items • 51 Pcs**  
**IBS No. 756R**



**Packaged in a Locking Steel Drawer  
 for Easy Storage & Organization**

Assortment No. 756R					
60041 5/32 TWO-EAR CLAMP .122-.161	60305 3/16 TWO-EAR CLAMP .134-.197	60507 1/4 TWO-EAR CLAMP .197-.276	60709 5/16 TWO-EAR CLAMP .276-.354	60811 3/8 TWO-EAR CLAMP .319-.433	61098 EAR CLAMP STANDARD JAW PINNERS CRIMPER
61113 1/2 TWO-EAR CLAMP .425-.512	61315 9/16 TWO-EAR CLAMP .492-.591	61518 5/8 TWO-EAR CLAMP .591-.709	61720 3/4 TWO-EAR CLAMP .638-.787	62023 7/8 TWO-EAR CLAMP .748-.906	
62327 1" TWO-EAR CLAMP.886- 1.063	62831 1-1/8 TWO-EAR CLAMP	63134 1-5/16 TWO-EAR CLAMP	63437 1-7/16 TWO-EAR CLAMP	63740 1-1/2 TWO-EAR CLAMP	

PRODUCT CATEGORY: R

A  
S  
S  
O  
R  
T  
M  
E  
N  
T  
S

# IBS, INCORPORATED

## Assortments - Adhesives (SA)



**IBS, Inc.**  
SPECIALTY PRODUCTS FOR MAINTENANCE & REPAIR  
INDUSTRIALBOLT.COM © © © 800-470-1906

**2-Part EZ-Poxy Sticks**  
Assortment No. 640P

74509 EZ-POXY CONCRETE STICK		
74508 EZ-POXY ALUMINUM STICK		
74507 EZ-POXY PLASTIC STICK		
74506 EZ-POXY WOOD STICK		
74505 EZ-POXY AQUA STICK		
74502 EZ-POXY STEEL STICK		

PRODUCT CATEGORY: SA

## 2-Part Easy Epoxy Sticks

6 Items • 6 Pcs  
IBS No. 640P



Packaged in a Locking Steel Drawer for Easy Storage & Organization

**IBS, Inc.**  
SPECIALTY PRODUCTS FOR MAINTENANCE & REPAIR  
INDUSTRIALBOLT.COM © © © 800-470-1906

**Loctite Thread Lockers**  
Assortment No. 671R

37087 LOCTITE 19GM BLUE		
37686 LOCTITE 19GM RED THREADLOCKER		
51604 LOCTITE TIGHT ANAEROBIC GEL		
21348 LOCTITE PRIMER-N AEROSOL 4.5OZ		
24231 LOCTITE REMOVABLE		
26231 LOCTITE HIGH STRENGTH		
29031 LOCTITE 50ML GREEN MEDIUM		
27240 LOCTITE 50ML HT TEMP HI		

PRODUCT CATEGORY: SA

## Loctite Thread Lockers

8 Items • 8 Pcs  
IBS No. 671R



Packaged in a Locking Steel Drawer for Easy Storage & Organization

**IBS, Inc.**  
SPECIALTY PRODUCTS FOR MAINTENANCE & REPAIR  
INDUSTRIALBOLT.COM © © © 800-470-1906

**Loctite Glues & Epoxies**  
Assortment No. 674R

39202 LOCTITE QUICKTITE INSTANT		
74510 MULTI-PURPOSE ADHESIVE 3.7 OZ E6000		
97434 FIXMASTER 2 PART 4 MINUTE		
EQ115 STATIC MIXER		
20251 LOCTITE 330 DEPEND ADHESIVE		
21425 LOCTITE .12 OZ FAST CURE		
96604 LOCTITE FIXMASTER FAST SET		
EQ016 DISPENSING GUN		

PRODUCT CATEGORY: SA

## Loctite Glues & Epoxies

8 Items • 12 Pcs  
IBS No. 674R



Packaged in a Locking Steel Drawer for Easy Storage & Organization

ASSORTMENTS



# IBS, INCORPORATED

## Assortments - Adhesives (SA)

ASSORTMENTS

IBS, Inc. SPECIALTY PRODUCTS FOR MAINTENANCE & REPAIR INDUSTRIALBOLT.COM • 800-678-1506		Loctite 10ml Threadlockers	
		Assortment No. 676R	
37087 LOCTITE 19GM BLUE THREADLOCKER STICK	37686 LOCTITE 19GM RED THREADLOCKER STICK	51604 LOCTITE TIGHT ANAEROBIC GEL 50ML	21348 LOCTITE PRIMER-N AEROSOL 4.5OZ
24221 BLUE REMOVEABLE THREADLOCKER 10ml	26221 262 RED HIGH STRENGTH THREADLOCKER 10ml	29021 290 GREEN MEDIUM THREADLOCKER 10ml	32526 2760 RED HIGH THREADLOCKER 10ml

PRODUCT CATEGORY: SA

**Loctite 10ml  
Threadlockers**  
8 Items • 8Pcs  
IBS No. 676R



Packaged in a Locking Steel Drawer  
for Easy Storage & Organization

IBS, Inc. SPECIALTY PRODUCTS FOR MAINTENANCE & REPAIR INDUSTRIALBOLT.COM • 800-678-1506		Loctite RTV Tube Assortment			
		Assortment 776R			
59530 LOCTITE SUPERFLEX 80ML TUBE RTV CLEAR	59430 LOCTITE SUPERFLEX 80ML TUBE RTV WHITE	59330 LOCTITE SUPERFLEX 80ML TUBE RTV BLACK	30560 LOCTITE SUPERFLEX 80ML TUBE RTV BLUE	59630 LOCTITE HI TEMP 80ML TUBE RTV RED	18718 LOCTITE GASKET MAKER 70ML TUBE RTV GRAY

PRODUCT CATEGORY: SA

**Loctite RTV Tube  
Assortment**  
6 Items • 12 Pcs  
IBS No. 776R



Packaged in a Locking Steel Drawer  
for Easy Storage & Organization

IBS, Inc. SPECIALTY PRODUCTS FOR MAINTENANCE & REPAIR INDUSTRIALBOLT.COM • 800-678-1506		Thread Locker, Anti-Seize & Dielectric Grease			
		Assortment 833R			
74242 MEDIUM STRENGTH THREADLOCKER GEL BLUE 35ML	74262 HIGH STRENGTH THREADLOCKER GEL RED 35ML	74151 ANTI SEIZE GEL ALUMINUM 35ML	74152 ANTI SEIZE GEL COPPER 35ML	74159 PTFE PIPE SEALANT GEL 35ML	74160 DIELECTRIC GREASE PUMP 35ML

PRODUCT CATEGORY: SA

**Thread Locker, Anti-  
Seize & Dielectric  
Grease**

6 Items • 12 Pcs  
IBS No. 833R

















Packaged in a Locking Steel Drawer  
for Easy Storage & Organization

# IBS, INCORPORATED

## Assortments - Coatings (SCO)



 <b>Industrial Markers</b>	
Assortment No. 695R	
96520 DURA INK 5 BLACK EXTENDED MICRO TIP 	96823 VALVE ACTION PAINT PEN-BLACK 
96023 DURA INK 15 BLACK FINE TIP 	96822 VALVE ACTION PAINT PEN- RED 
96022 DURA INK 15 RED FINE TIP 	96821 VALVE ACTION PAINT PEN-YELLOW 
96025 DURA INK 15 BLUE FINE TIP 	96820 VALVE ACTION PAINT PEN-WHITE 
96026 DURA INK 15 GREEN FINE TIP 	96575 DURA INK 20 BLACK RETRACTABLE BULLET TIP 
96283 DURA INK BLACK DUAL TIP MARKER 	96576 DURA INK 20 RED RETRACTABLE BULLET TIP 
96282 DURA INK RED DUAL TIP MARKER 	













PRODUCT CATEGORY: SCO

### Industrial Markers

13 Items • 27 Pcs  
IBS No. 695R

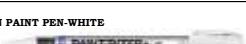
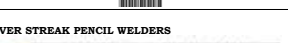

Packaged in a Locking Steel Drawer  
for Easy Storage & Organization

 <b>Industrial Markers &amp; Welder's Pencils</b>	
Assortment No. 807R	
96023 DURA INK 15 BLACK FINE BULLET TIP 	96823 VALVE ACTION PAINT PEN-BLACK 
96022 DURA INK 15 RED FINE TIP 	96822 VALVE ACTION PAINT PEN- RED 
96025 DURA INK 15 BLUE FINE TIP 	96821 VALVE ACTION PAINT PEN-YELLOW 
96026 DURA INK 15 GREEN FINE TIP 	96820 VALVE ACTION PAINT PEN-WHITE 
96101 MARKAL SILVER STREAK PENCIL WELDERS 	96575 DURA INK 20 BLACK RETRACTABLE BULLET TIP 
96006 MARKAL SILVER STREAK MECHANICAL WELDERS ROUND PENCIL 	96576 DURA INK 20 RED RETRACTABLE BULLET TIP 

PRODUCT CATEGORY: SCO

### Industrial Markers & Welder's Pencils

12 Items • 23 Pcs  
IBS No. 807R

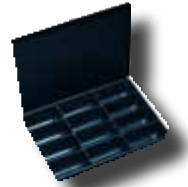

Packaged in a Locking Steel Drawer  
for Easy Storage & Organization

ASSORTMENTS



# IBS, INCORPORATED

## Assortments - Welding (SW)



**IBS Inc.**  
SPECIALTY PRODUCTS FOR MAINTENANCE & REPAIR  
INDUSTRIALBOLT.COM • 800-678-1906

### Vinculum Welding Electrode Assortment Steel & Cast Iron

Assortment No. 754R

<p><b>46015</b> <b>1/8 GROOVY VINCULUM</b> Premium High Speed Gouging And Chamfering Electrode</p>	<p>VINCULUM™ GROOVY is designed to remove metal fast and efficiently without special skills or special equipment, expensive gases or compressed gas. Color: Gray</p>	<p><b>Technical Data:</b> Current..... AC or DC Straight Polarity (Electrode-)</p>
<p><b>46031</b> <b>1/8 MRO CAST VINCULUM</b> Specially Designed for Dirty Cast Iron - The Problem Solver to Use When All Others Fail</p>	<p>Vinculum™ MRO CAST has a unique flux coating on alloyed cored wire which produces dense, strong crack resistant welds on all types of cast iron. Especially good for contaminated, oil-soaked, dirty base metal. Also recommended for joining cast iron to steel. Use on gray, ductile, malleable, and nodular cast iron. Deposits are machinable. Color: Dark Gray/Black</p>	<p><b>Technical Data:</b> Tensile Strength..... up to 75,000 psi (517N/mm<sup>2</sup>) Hardness..... Brinell 210 Current..... AC or DC Reverse Polarity (Electrode+)</p>
<p><b>46012</b> <b>1/8 HI ALLOY VINCULUM</b> A Superior Super Strength Electrode For Welding Alloy and Dissimilar Steels</p>	<p>VINCULUM™ Hi Alloy is designed to weld low, medium and high alloy steels where super strength and high quality welds are desirable. Color: Blue</p>	<p><b>Technical Data:</b> Tensile Strength - welded..... up to 120,000 psi work hardened..... up to 180,000 psi Yield strength..... up to 90,000 psi Elongation %..... approx. 28% Hardness (HRC)..... approx. 300 Current..... AC or DC Reverse Polarity (Electrode+)</p>
<p><b>46042</b> <b>1/8 VINCULUM DIVERSE-ALLOY</b> A Premium High Strength Electrode For Welding High Strength Low Alloy Steels and Abrasion</p>	<p>DIVERSE-ALLOY is excellent for welding most high-strength low alloy steels. It is recommended for the repair of heavy equipment and joints subjected to high stresses because of its high strength. The moisture resistant coating assures dense, crack free deposits for outstanding impact resistance at all temperatures, and X-ray quality welds. Color: White</p>	<p><b>Technical Data:</b> Tensile Strength..... up to 93,000 psi (70 kg/mm<sup>2</sup>) Elongation %..... approx. 32 Current..... AC or DC Reverse Polarity (Electrode+)</p>
<p><b>46004</b> <b>1/8 MID ALLOY VINCULUM</b> Premium General Purpose Alloy For Low Carbon Steels</p>	<p>Vinculum™ Mid Alloy is designed to operate on all welding machines, even small AC type transformers when the open circuit voltage is very low. The specially formulated coating protects the deposit from adverse conditions normally encountered in maintenance welding. An ideal electrode for field repair work and out of position welding. Color: Gold</p>	<p><b>Technical Data:</b> Tensile Strength..... up to 80,000 psi Yield Strength..... up to 68,000 psi Elongation %..... approx. 24% Current..... AC or DC either polarity</p>

PRODUCT CATEGORY: SW

## Vinculum Welding Electrodes Steel & Cast Iron

5 Items • 9 lbs  
IBS No. 754R



Packaged in a Locking Steel Drawer  
for Easy Storage & Organization

A  
S  
S  
O  
R  
T  
M  
E  
N  
T  
S



# IBS, INCORPORATED

## Assortments - Hardware / Springs (U)



IBS, Inc.		Universal Extension Springs	
SPECIALTY PRODUCTS FOR MAINTENANCE & REPAIR INDUSTRIALBOLTY.COM © P O BOX 678-1988		Assortment No. 115R	
47030 1/2 OD X 9-5/8 EXTENSION SPRING		47045 1-1/16 OD X 5-1/2" EXTENSION SPRING	
47031 5/8 OD X 8-1/2 EXTENSION SPRING		47044 19/32 OD X 5" EXTENSION SPRING	
47032 13/16 OD X 8-1/2 EXTENSION SPRING		47043 7/16 OD X 7" EXTENSION SPRING	
47033 1" OD X 8-1/2 EXTENSION SPRING		47042 21/64 OD X 5-7/8 EXTENSION SPRING	
47038 1/4 OD X 4" EXTENSION SPRING		47039 3/8 OD X 3" EXTENSION SPRING	
47034 1/2 OD X 1-5/8 EXTENSION SPRING		47040 7/16 OD X 4-1/2 EXTENSION SPRING	
47035 19/64 OD X 13/16 EXTENSION SPRING		47041 1/4 OD X 5" EXTENSION SPRING	
47036 11/32 OD X 1-13/32 EXTENSION SPRING		47046 23/32 OD X 3-3/16 EXTENSION SPRING	
47037 15/64 OD X 1-1/32 EXTENSION SPRING		47047 47/64 OD X 3-7/8 EXTENSION SPRING	

PRODUCT CATEGORY: U

IBS, Inc.		Universal Compression Springs	
SPECIALTY PRODUCTS FOR MAINTENANCE & REPAIR INDUSTRIALBOLTY.COM © P O BOX 678-1988		Assortment No. 116R	
47000 5/16 OD X 10 COMPRESSION"		47004 1/2 OD X 1 COMPRESSION	47005 5/16 OD X 1-19/32
47001 3/8 OD X 12 COMPRESSION"		47006 3/16 OD X 1 COMPRESSION"	47007 3/8 OD X 3/4 COMPRESSION
47002 5/8 OD X 12 COMPRESSION"		47008 1-1/64 OD X 3-1/8 COMPRESSION	
47003 7/8 OD X 12 COMPRESSION"		47009 11/16 OD X 4 COMPRESSION"	
47010 19/32 OD X 2-1/2 COMPRESSION	47011 5/8 OD X 2-3/4 COMPRESSION	47012 1/2 OD X 2-1/2 COMPRESSION	47013 7/16 OD X 2-7/8 COMPRESSION
47014 15/16 OD X 2-1/4 COMPRESSION	47015 7/8 OD X 2-1/32 COMPRESSION	47016 7/8 OD X 3 COMPRESSION SPRING"	47017 1-1/16 OD X 3-5/8 COMPRESSION

PRODUCT CATEGORY: U

IBS, Inc.		Roller Chain Links Offset Chain Links	
SPECIALTY PRODUCTS FOR MAINTENANCE & REPAIR INDUSTRIALBOLTY.COM © P O BOX 678-1988		Assortment No. 208P	
20135 #35 .375 PITCH CONN. LINK	20140 #40 .500 PITCH CONN. LINK	20141 #41 .500 PITCH CONN. LINK	20150 #50 .625 PITCH CONN. LINK
			20160 #60 .750 PITCH CONN. LINK
20180 #80 1.00 PITCH CONN. LINK			
20235 #35 .375 PITCH OFFSET (HALF)	20240 #40 .500 PITCH OFFSET (HALF)	20241 #41 .500 PITCH OFFSET (HALF)	20250 #50 .625 PITCH OFFSET (HALF)
			20260 #60 .750 PITCH OFFSET (HALF)
20280 #80 1.00 PITCH OFFSET (HALF)			
			20300 #1 CHAIN BREAKER

PRODUCT CATEGORY: U

### Universal Extension Springs

18 Items • 70 Pcs  
IBS No. 115R



Packaged in a Locking Steel Drawer for Easy Storage & Organization

### Universal Compression Springs

18 Items • 54 Pcs  
IBS No. 116R



Packaged in a Locking Steel Drawer for Easy Storage & Organization

### Roller Chain Links Offset Chain Links

13 Items • 67 Pcs  
IBS No. 208P













Packaged in a Locking Steel Drawer for Easy Storage & Organization

ASSORTMENTS



# IBS, INCORPORATED

## Assortments - Hardware / Springs (U)

IBS, Inc. SPECIALTY PRODUCTS FOR MAINTENANCE & REPAIR INDUSTRIALBOLLY.COM • • • 800-478-1906		Quick Links & Spring Links	
		Assortment No. 748R	
22040 1/8 QUICK LINK ZP 	22041 3/16 QUICK LINK ZP 	22042 1/4 QUICK LINK ZP 	
22043 5/16 QUICK LINK ZP 	22044 3/8 QUICK LINK ZP 	22045 1/2 QUICK LINK ZP 	
22047 3/16 SPRING LINK ZP 	22048 1/4 SPRING LINK ZP 	22049 5/16 SPRING LINK ZP 	
22050 3/8 SPRING LINK ZP 	22051 1/2 SPRING LINK ZP 		

PRODUCT CATEGORY: U

**Quick Links  
& Spring Links**  
**11 Items • 72 Pcs**  
**IBS No. 748R**



**Packaged in a Locking Steel Drawer  
for Easy Storage & Organization**

ASSORTMENTS

# IBS, INCORPORATED







## Assortments - Air Fittings (VA)



**IBS, Inc.**  
SPECIALTY PRODUCTS FOR MAINTENANCE & REPAIR  
INDUSTRIALBOLT.COM © © © 800-678-1906

Automotive Couplers,  
Plugs and Flexeel Repair Kit

Assortment No. 718R

C2 1/4 COUPLER 1/4 FPT AUTO 	130789 SPLICER FOR 3/8 POLYURETHANE 	130791 1/4NPT X 3/8 HOSE SWIV 	11420 HOSE & TUBING CUTTER UP TO 1-1/4 
C1 1/4 COUPLER 1/4 MPT AUTO 			
CP2 1/4 PLUG 1/4 FPT AUTO 			
CP1 1/4 PLUG 1/4 MPT AUTO 			

PRODUCT CATEGORY: VA

## Automotive Couplers, Plugs & Flexeel Repair Kit

9 Items • 36 Pcs  
IBS No. 717R

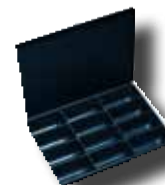



Packaged in a Locking Steel Drawer  
for Easy Storage & Organization

**IBS, Inc.**  
SPECIALTY PRODUCTS FOR MAINTENANCE & REPAIR  
INDUSTRIALBOLT.COM © © © 800-678-1906

Automotive Couplers,  
Plugs and Hose Repair Kit

Assortment No. 719R

C2 1/4 COUPLER 1/4 FPT AUTO 	VG-6 VINYL GUARD FOR 3/8 AIR HOSE 	AM7328 21/32 I.D. FERRULE BRASS 	11420 HOSE & TUBING CUTTER UP TO 1-1/4 
C1 1/4 COUPLER 1/4 MPT AUTO 		10406B-106 3/8 LONG BARB UNION 	
CP2 1/4 PLUG 1/4 FPT AUTO 	10506B-104 3/8 X 1/4 M. LONG BARB H. END 		
CP1 1/4 PLUG 1/4 MPT AUTO 			

PRODUCT CATEGORY: VA

## Automotive Couplers, Plugs & Hose Repair Kit

9 Items • 36 Pcs  
IBS No. 719R















Packaged in a Locking Steel Drawer  
for Easy Storage & Organization

**IBS, Inc.**  
SPECIALTY PRODUCTS FOR MAINTENANCE & REPAIR  
INDUSTRIALBOLT.COM © © © 800-678-1906

Pressure Washer  
Couplers, Plugs and Nozzles

Assortment No. 831R

CST3B 1/4 MPT STRAIGHT THRU COUPLER BRASS FOR PRESSURE WASHER 	CST5B 3/8 MPT STRAIGHT THRU COUPLER BRASS FOR PRESSURE WASHER 	130560 PRESSURE WASHER NOZZLE 0 DEGREE RED 
CST4B 1/4 FPT STRAIGHT THRU COUPLER BRASS FOR PRESSURE WASHER 	CST5B 3/8 FPT STRAIGHT THRU COUPLER BRASS FOR PRESSURE WASHER 	130561 PRESSURE WASHER NOZZLE 15 DEGREE YELLOW 
CPST3 1/4 MPT STRAIGHT THRU COUPLER PLUG STEEL FOR PRESSURE WASHER 	CPST5 3/8 MPT STRAIGHT THRU COUPLER PLUG STEEL FOR PRESSURE WASHER 	130562 PRESSURE WASHER NOZZLE 25 DEGREE GREEN 
CPST4 1/4 FPT STRAIGHT THRU COUPLER PLUG STEEL FOR PRESSURE WASHER 	CPST6 3/8 FPT STRAIGHT THRU COUPLER PLUG STEEL FOR PRESSURE WASHER 	130563 PRESSURE WASHER NOZZLE 40 DEGREE WHITE 

PRODUCT CATEGORY: VA

## Pressure Washer Couplers, Plugs & Nozzles

12 Items • 32 Pcs  
IBS No. 831R



Packaged in a Locking Steel Drawer  
for Easy Storage & Organization

ASSORTMENTS



# IBS, INCORPORATED

## Assortments - Grease Fittings (VG)

ASSORTMENTS

IBS, Inc. SPECIALTY PRODUCTS FOR MAINTENANCE & REPAIR INDUSTRIALBOLTY.COM 800-478-1906						Grease Fittings
						Assortment No. 124R
1641-B 1/4-28 TAPER TRD STRT ZERK	1652-B 1/4-28 TAPER TRD 11/16 ZERK	1680-B 1/4-28 TAPER TRD 31/32 STRT	1637-B 1/4-28 TAPER TRD 45 DGR ZERK	1911-B 1/4-28 TAPER TRD. 90 DGR ZERK	1610-B 1/8 NPT STRT ZERK	
1644-B 1/8 NPT SHORT STRT. ZERK	1607-B 1/8 NPT 1-1/4L STRT ZERK	1611-B 1/8 NPT 30DGR STRT ZERK	1688-B 1/8 NPT 45 DGR ZERK	1613-B 1/8 NPT 90DGR ZERK	1629-B 1/4 NPT 67-1/2 DGR ZERK	
1743-B 1/4 DRIVE ZERK BALL CHECK	1608-B 5/16 DRIVE ZERK BALL CHECK	1728-B 3/16 DRIVE ZERK BALL CHECK	1666-NB 3/8 DRIVER ZERK - NO BALL CHECK	1646-B 3/16 45DGR DRIVE ZERK		
1711-B 5/16-24 ZERK (LEAF SPRINGS)	1720-B 1/8 NPT STRT THREAD CUTTING	3038-B 1/4-28 NPT STRT THREAD CUTTING	5251 RUBBER ZERK CAP			

PRODUCT CATEGORY: VG

**Grease Fittings**  
21 Items • 180 Pcs  
IBS No. 124R



Packaged in a Locking Steel Drawer for Easy Storage & Organization

IBS, Inc. SPECIALTY PRODUCTS FOR MAINTENANCE & REPAIR INDUSTRIALBOLTY.COM 800-478-1906						Grease Fittings
						Assortment No. 225R
1641-B 1/4-28 TAPER TRD STRT ZERK	1652-B 1/4-28 TAPER TRD 11/16 ZERK	1637-B 1/4-28 TAPER TRD 45 DGR ZERK	1911-B 1/4-28 TAPER TRD. 90 DGR ZERK		317850-1F 18" LUB. HOSE	
1610-B 1/8 NPT STRT ZERK	1688-B 1/8 NPT 45 DGR ZERK	1613-B 1/8 NPT 90DGR ZERK				
1608-B 5/16 DRIVE ZERK BALL CHECK	1728-B 3/16 DRIVE ZERK BALL CHECK					
5251 RUBBER ZERK CAP			308730 1/8 NPT GREASE FITTING COUPLER			

PRODUCT CATEGORY: VG

**Grease Fittings**  
12 Items • 178 Pcs  
IBS No. 225R



Packaged in a Locking Steel Drawer for Easy Storage & Organization

IBS, Inc. SPECIALTY PRODUCTS FOR MAINTENANCE & REPAIR INDUSTRIALBOLTY.COM 800-478-1906						Metric Grease Fittings
						Assortment No. 232R
Z-1600 6MM X 1.0 STRT METRIC ZERK	Z-1621 6MM X 1.0 45DGR METRIC ZERK	Z-1690 6MM X 1.0 90DGR METRIC ZERK				
Z-2103 8MM X 1.0 STRT METRIC ZERK	Z-2104 8MM X 1.0 45DGR METRIC ZERK	Z-2105 8MM X 1.0 90DGR METRIC ZERK				
Z-2109 10MM X 1.0 STRT. METRIC ZERK	Z-2110 10MM X 1.0 45DGR METRIC ZERK	Z-2111 10MM X 1.0 90DGR METRIC ZERK				
5251 RUBBER ZERK CAP						

PRODUCT CATEGORY: VG

**Metric Grease Fittings**  
10 Items • 150 Pcs  
IBS No. 232R

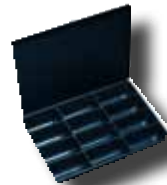























Packaged in a Locking Steel Drawer for Easy Storage & Organization

# IBS, INCORPORATED

## Assortments - Grease Fittings (VG)



 <b>IBS, Inc.</b> <small>SPECIALTY PRODUCTS FOR MAINTENANCE &amp; REPAIR</small> <small>INDUSTRIALMOLLY.COM • P.O. BOX 878-1906</small>		Grease Fittings Inch & Metric				Assortment No. 849R
1911-B 1/4-28 TAPER TRD 90 DGR ZERK 	1613-B 1/8 NPT 90 DGR ZERK 	1608-B 5/16 DRIVE ZERK BALL CHECK 	Z-1690 M6 X 1.0 90DGR METRIC ZERK 	Z-2105 8MM X 1.0 90DGR METRIC ZERK 	Z-2111 10MM X 1.0 90DGR METRIC ZERK 	
1637-B 1/4-28 TAPER TRD 45 DGR ZERK 	1688-B 1/8 NPT 45 DGR ZERK 	1743-B 1/4 DRIVE ZERK BALL CHECK 	Z-1621 M6 X 1.0 45DGR METRIC ZERK 	Z-2104 8S X 1.0 45DGR METRIC ZERK 	Z-2110 10MM X 1.0 45DGR METRIC ZERK 	
1652-B 1/4-28 TAPER TRD 11/16 ZERK 	1607-B 1/8 NPT 1-1/4L STRT ZERK 	1728-B 3/16 DRIVE ZERK BALL CHECK 	Z-1600 M6 X 1.0 STRT METRIC ZERK 	Z-2103 8S X 1.0 STRT METRIC ZERK 	Z-2109 10MM X 1.0 STRT. METRIC ZERK 	
1641-B 1/4-28 TAPER TRD STRT ZERK 	1610-B 1/8 NPT STRT ZERK 			5852 LINCOLN GREASE COUPLER 	5251 RUBBER ZERK CAP 	

PRODUCT CATEGORY: VG

## Inch & Metric Grease Fittings

22 Items • 166 Pcs  
 IBS No. 849R



Packaged in a Locking Steel Drawer  
 for Easy Storage & Organization

ASSORTMENTS



# IBS, INCORPORATED

## Assortments - Rivets & Inserts (W)

ASSORTMENTS

IBS, Inc. SPECIALTY PRODUCTS FOR MAINTENANCE & REPAIR INDUSTRIALBOLTY.COM • • • 800-678-1966		Rivet Code Explanation			Aluminum Blind Rivets	
Assortment No. 156R						
AB3-2A 3/32 .032-.125 ALUM/ALUM RIVET	AB3-4A 3/32 .126-.250 ALUM/ALUM RIVET	AB4-2A 1/8 .063-.125 ALUM/ALUM RIVET	AB4-3A 1/8 .126-.187 ALUM/ALUM RIVET	AB4-4A 1/8 .188-.250 ALUM/ALUM RIVET		
			AB5-3A 5/32 .126-.187 ALUM/ALUM RIVET	AB5-4A 5/32 .188-.250 ALUM/ALUM RIVET		
AB5-6A 5/32 .251-.375 ALUM/ALUM RIVET	AB5-8A 5/32 .376-.500 ALUM/ALUM RIVET	AB6-4A 3/16 .126-.250 ALUM/ALUM RIVET	AB6-6A 3/16 .251-.375 ALUM/ALUM RIVET	AB6-8A 3/16 .376-.500 ALUM/ALUM RIVET		
AB6-10A 3/16 .501-.625 ALUM/ALUM RIVET		ABL6-6A 3/16 .251-.375 LRG FLGE	ABL6-8A 3/16 .376-.500 LRG FLGE	ABL6-10A 3/16 .501-.625 LRG FLNGE		

PRODUCT CATEGORY: W

IBS, Inc. SPECIALTY PRODUCTS FOR MAINTENANCE & REPAIR INDUSTRIALBOLTY.COM • • • 800-678-1966		Rivet Code Explanation			Aluminum / Steel Blind Rivets	
Assortment No. 157R						
AB3-2 3/32 .032-.125 ALUM/STEEL	AB3-4 3/32 .126-.250 ALUM/STEEL	AB4-2 1/8 .063-.125 ALUM/STEEL RIVET	AB4-3 1/8 .126-.187 ALUM/STEEL RIVET	AB4-4 1/8 .188-.250 ALUM/STEEL RIVET		
			AB5-3 5/32 .126-.187 ALUM/STEEL	AB5-4 5/32 .188-.250 ALUM/STEEL		
AB5-6 5/32 .251-.375 ALUM/STEEL	AB5-8 5/32 .376-.500 ALUM/STEEL	AB6-4 3/16 .126-.250 ALUM/STEEL	AB6-6 3/16 .251-.375 ALUM/STEEL	AB6-8 3/16 .376-.500 ALUM/STEEL		
AB6-10 3/16 .501-.625 AI		ABL6-6 3/16 .251-.375 LRG FLGE	ABL6-8 3/16 .376-.500 LRG FLGE	ABL6-10 3/16 .501-.625 LRG FLGE		

PRODUCT CATEGORY: W

IBS, Inc. SPECIALTY PRODUCTS FOR MAINTENANCE & REPAIR INDUSTRIALBOLTY.COM • • • 800-678-1966		Rivet Code Explanation			Steel Blind Rivets	
Assortment No. 174R						
SB3-4 3/32 .126-.250 STEEL RIVET	SB4-2 1/8 .063-.125 STEEL RIVET	SB4-3 1/8 .126-.187 STEEL RIVET	SB4-4 1/8 .188-.250 STEEL RIVET			
			SB5-2 5/32 .062-.125 STEEL RIVET	SB5-4 5/32 .188-.250 STEEL RIVET		
SB5-6 5/32 .251-.375 STEEL RIVET	SB5-8 5/32 .376-.500 STEEL RIVET	SB6-4 3/16 .126-.250 STEEL RIVET	SB6-6 3/16 .251-.375 STEEL RIVET	SB6-8 3/16 .376-.500 STEEL RIVET		
SB6-10 3/16 .501-.625 STEEL RIVET		SBL6-6 3/16 .251-.375 LRG FLGE STEEL	SBL6-8 3/16 .376-.500 LRG FLGE STEEL	SBL6-10 3/16 .501-.625 LRG FLGE STEEL		

PRODUCT CATEGORY: W

### Aluminum Blind Rivets

16 Items • 1,050 Pcs  
IBS No. 156R



Packaged in a Locking Steel Drawer for Easy Storage & Organization

### Aluminum / Steel Blind Rivets

16 Items • 1,050 Pcs  
IBS No. 157R



Packaged in a Locking Steel Drawer for Easy Storage & Organization

### Steel Blind Rivets

15 Items • 975 Pcs  
IBS No. 174R



Packaged in a Locking Steel Drawer for Easy Storage & Organization

# IBS, INCORPORATED

## Assortments - Rivets & Inserts (W)



<b>Thread Repair Kit</b> <b>1/4-1/2 NC USS Heavy Wall</b> Assortment No. 212R					
					65999 INSERT TOOL FOR THD INSERTS 
65902 1/4-20 HVY WALL THD INSERT 	65903 5/16-18 HVY WALL THD INSERT 	65904 3/8-16 HVY WALL THD INSERT 	65905 7/16-14 HVY WALL THD INSERT 	65906 1/2-13 HVY WALL THD INSERT 	
Use With P/N 16158 X Drill P/N 17641 7/16-14 Tap	Use With P/N 17425 29/64 Drill P/N 17643 1/2-13 Tap	Use With P/N 16833 33/64 Drill P/N 17645 9/16-12 Tap	Use With P/N 16845 37/64 Drill P/N 17647 5/8-11 Tap	Use With: P/N 16845 45/64 Drill P/N 17650 3/4-16 Tap	

PRODUCT CATEGORY: W

<b>Thread Repair Kit</b> <b>1/4-1/2 NF SAE Heavy Wall</b> Assortment No. 213R					
					65999 INSERT TOOL FOR THD INSERTS 
66102 1/4-28 HVY WALL THD INSERT 	66103 5/16-24 HVY WALL THD INSERT 	66104 3/8-24 HVY WALL THD INSERT 	66105 7/16-20 HVY WALL THD INSERT 	66106 1/2-20 HVY WALL THD INSERT 	66108 5/8-18 HVY WALL THD INSERT 
Use With P/N 16158 X Drill P/N 17641 7/16-14 Tap	Use With P/N 17425 29/64 Drill P/N 17643 1/2-13 Tap	Use With P/N 16833 33/64 Drill P/N 17645 9/16-12 Tap	Use With P/N 16837 37/64 Drill P/N 17647 5/8-11 Tap	Use With P/N 16845 45/64 Drill P/N 17650 3/4-16 Tap	Use With P/N 16853 53/64 Drill P/N 17652 7/8-14 Tap

PRODUCT CATEGORY: W

<b>Thread Repair Kit</b> <b>1/4-1/2 NC USS Thin Wall</b> Assortment No. 214R					
					65999 INSERT TOOL FOR THD INSERTS 
65922 1/4-20 THIN WALL THD INSERTS 	65923 5/16-18 THIN WALL THD INSERTS 	65924 3/8-16 THIN WALL THD INSERTS 	65925 7/16-14 THIN WALL THD INSERTS 	65926 1/2-13 THIN WALL THD INSERTS 	
Use With P/N 16151 Q Drill P/N 17639 3/8-16 Tap	Use With P/N 16158 X Drill P/N 17641 7/16-14 Tap	Use With P/N 17425 29/64 Drill P/N 17643 1/2-13 Tap	Use With P/N 16833 33/64 Drill P/N 17645 9/16-12 Tap	Use With P/N 16837 37/64 Drill P/N 17647 5/8-11 Tap	

PRODUCT CATEGORY: W

### Thread Repair Kit

#### 1/4-12 NC USS Heavy Wall

6 Items • 81 Pcs  
IBS No. 212R

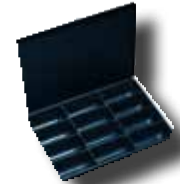

Packaged in a Locking Steel Drawer  
for Easy Storage & Organization

### Thread Repair Kit

#### 1/4-12 NF USS Heavy Wall

7 Items • 87 Pcs  
IBS No. 213R



Packaged in a Locking Steel Drawer  
for Easy Storage & Organization

### Thread Repair Kit

#### 1/4-1/2 NC USS Thin Wall

6 Items • 82 Pcs  
IBS No. 214R



Packaged in a Locking Steel Drawer  
for Easy Storage & Organization







ASSORTMENTS



# IBS, INCORPORATED

## Assortments - Rivets & Inserts (W)

ASSORTMENTS











IBS, Inc. SPECIALTY PRODUCTS FOR MAINTENANCE & REPAIR INDUSTRIALBOLTY.COM © © © 800-670-1506					Thread Repair Kit 1/4-1/2 NF SAE Thin Wall
					Assortment No. 215R
66122 1/4-28 THIN WALL THD INSERT 	66123 5/16-24 THIN WALL THD INSERT 	66124 3/8-24 THIN WALL THD INSERT 	66125 7/16-20 THIN WALL THD INSERT 	66126 1/2-20 THIN WALL THD INSERT 	
Use With P/N 16151 Q Drill P/N 17639 3/8-16 Tap	Use With P/N 16158 X Drill P/N 17641 7/16-14 Tap	Use With P/N 17425 29/64 Drill P/N 17643 1/2-13 Tap	Use With P/N 16833 33/64 Drill P/N 17645 9/16-12 Tap	Use With P/N 16837 37/64 Drill P/N 17647 5/8-11 Tap	
					65999 INSERT TOOL FOR THD INSERTS 

PRODUCT CATEGORY: W

**Thread Repair Kit**  
1/4-12 NF SAE Thin Wall  
6 Items • 82 Pcs  
IBS No. 215R



Packaged in a Locking Steel Drawer for Easy Storage & Organization













IBS, Inc. SPECIALTY PRODUCTS FOR MAINTENANCE & REPAIR INDUSTRIALBOLTY.COM © © © 800-670-1506			Multi-Grip Rivets
			Assortment No. 368R
170406 1/8 LARGE FLG SHORT MULTIGRIP 	170408 1/8 LARGE FLG LONG MULTIGRIP 	170508 5/32 LARGE FLG MULTIGRIP 	
170608 3/16 LARGE FLG SHORT MULTIGRIP 	170612 3/16 LARGE FLG LONG MULTIGRIP 		
171406 1/8 DOME HD SHORT MULTIGRIP 	171408 1/8 DOME HD LONG MULTIGRIP 	171508 5/32 DOME HD MULTIGRIP 	
171608 3/16 DOME HD SHORT MULTIGRIP 	171612 3/16 DOME HD LONG MULTIGRIP 		

PRODUCT CATEGORY: W

**Multi-Grip Rivets**  
10 Items • 1000 Pcs  
IBS No. 368R



Packaged in a Locking Steel Drawer for Easy Storage & Organization

IBS, Inc. SPECIALTY PRODUCTS FOR MAINTENANCE & REPAIR INDUSTRIALBOLTY.COM © © © 800-670-1506			Multi-Grip & Tri-Fold Rivets
			Assortment No. 369R
170406 1/8 LARGE FLG SHORT MULTIGRIP 	170408 1/8 LARGE FLG LONG MULTIGRIP 	170508 5/32 LARGE FLG MULTIGRIP 	
170608 3/16 LARGE FLG SHORT MULTIGRIP 	170612 3/16 LARGE FLG LONG MULTIGRIP 	171406 1/8 DOME HD SHORT MULTIGRIP 	
171408 1/8 DOME HD LONG MULTIGRIP 	171608 3/16 DOME HD SHORT MULTIGRIP 	171612 3/16 DOME HD LONG MULTIGRIP 	
17256 5/32 TRI-FOLD RIVET .040-.375 	17264 3/16 TRI-FOLD RIVET .062-.250 	17266 3/16 TRI-FOLD RIVET .187-.375 	

PRODUCT CATEGORY: W

**Multi-Grip & Tri-Fold Rivets**  
12 Items • 800 Pcs  
IBS No. 369R



Packaged in a Locking Steel Drawer for Easy Storage & Organization



# IBS, INCORPORATED

## Assortments - Rivets & Inserts (W)



**IBS, Inc.**  
SPECIALTY PRODUCTS FOR MAINTENANCE & REPAIR  
INDUSTRIALBOLT.COM © 2010 800-678-1906

Knurled Nutserts with Tool

Assortment No. 431P

49514 3/8-16 MANDREL & NOSEPIECE	49503 10-32 KNURLED GRIP SERT	49506 3/8-16 KNURLED GRIP SERT	49500 RIVET NUT GUN
49513 5/16-18 MANDREL & NOSEPIECE		NOTE: This size should be installed with Heavy Duty Nutsert Tool P/N 49550	
49512 1/4-20 MANDREL & NOSEPIECE	49502 10-24 KNURLED GRIP SERT	49505 5/16-18 KNURLED GRIP SERT	
49511 10-32 MANDREL & NOSEPIECE		NOTE: This size should be installed with Heavy Duty Nutsert Tool P/N 49550	
49510 10-24 MANDREL & NOSEPIECE	49501 8-32 KNURLED GRIP SERT	49504 1/4-20 KNURLED GRIP SERT	
49508 8-32 MANDREL & NOSEPIECE		NOTE: This size should be installed with Heavy Duty Nutsert Tool P/N 49550	

PRODUCT CATEGORY: W

### Knurled Nutserts with Tool

13 Items • 127 Pcs  
IBS No. 431P



Packaged in a Locking Steel Drawer for Easy Storage & Organization

**IBS, Inc.**  
SPECIALTY PRODUCTS FOR MAINTENANCE & REPAIR  
INDUSTRIALBOLT.COM © 2010 800-678-1906

Aluminum Nutserts

Assortment No. 432P

49514 3/8-16 MANDREL & NOSEPIECE	17503 10-32 ALUM RIVET NUT Drill Hole Size 9/32"	17506 3/8-16 ALUM RIVET NUT Drill Hole Size 1/2"	49500 RIVET NUT GUN
49513 5/16-18 MANDREL & NOSEPIECE			
49512 1/4-20 MANDREL & NOSEPIECE	17502 10-24 ALUM RIVET NUT Drill Hole Size 9/32"	17505 5/16-18 ALUM RIVET NUT Drill Hole Size 1/2"	
49511 10-32 MANDREL & NOSEPIECE	17501 8-32 ALUM RIVET NUT Drill Hole Size 1/4"		
49510 10-24 MANDREL & NOSEPIECE	17500 6-32 ALUM RIVET NUT Drill Hole Size 1/4"	17504 1/4-20 ALUM RIVET NUT Drill Hole Size 3/8"	
49508 8-32 MANDREL & NOSEPIECE	49507 6-32 MANDREL & NOSEPIECE		

PRODUCT CATEGORY: W

### Aluminum Nutserts

15 Items • 153 Pcs  
IBS No. 432P



Packaged in a Locking Steel Drawer for Easy Storage & Organization

**IBS, Inc.**  
SPECIALTY PRODUCTS FOR MAINTENANCE & REPAIR  
INDUSTRIALBOLT.COM © 2010 800-678-1906

Self-Tapping Threaded Inserts

Assortment No. 696R

65935 1/4-20 SELF-TAPPING THREAD INSERT (USE DRILL: V)	65936 5/16-18 SELF-TAPPING THREAD INSERT (USE DRILL: 29/64)	65937 3/8-16 SELF TAPPING THREAD INSERT (USE DRILL: 17/32)	65939 1/2-13 SELF TAPPING THREAD INSERT (USE DRILL: 11/16)
65945 M6-1.0 SELF-TAPPING THREAD INSERT (USE DRILL: V)	65946 M8-1.25 SELF-TAPPING THREAD INSERT (USE DRILL: 29/64)	65947 M10-1.5 SELF TAPPING THREAD INSERT (USE DRILL: 17/32)	65948 M12-1.75 SELF TAPPING THREAD INSERT (USE DRILL: 39/64)

PRODUCT CATEGORY: W

### Self-Tapping Threaded Inserts

8 Items • 60 Pcs  
IBS No. 696R



Packaged in a Locking Steel Drawer for Easy Storage & Organization

ASSORTMENTS



# IBS, INCORPORATED

## Assortments - Automotive (X)

ASSORTMENTS

IBS, Inc. SPECIALTY PRODUCTS FOR MAINTENANCE & REPAIR INDUSTRIALBOLTY.COM 800-878-1906						Universal Studs Black Oil Finish High Carbon - Heat Treated					
						Assortment No. 119R					
A-9668 1/4-28X1/2 X 1/4-20X1/2 OL 1-1/4 STUD	A-9669 1/4-28X3/4 X 1/4-20X1/2 OL 1-1/2 STUD	A-9670 1/4-28X1 X 1/4-20X1/2 OL 2" STUD	A-9673 5/16-24X1/2 X 5/16-18X3/8 OL 1" STUD	A-9675 5/16-24X5/8 X 5/16-18X3/4 OL 1-1/2 STUD	A-9690 3/8-24X2 X 3/8-16X5/8 OL 3" STUD						
A-9677 5/16-24X1 X 5/16-18X9/16 OL 2" STUD	A-9683 3/8-24X3/4 X 3/8-16X1/2 OL 1-1/2 STUD	A-9684 3/8-24X3/4 X 3/8-16X1/2 OL 1-3/4 STUD	A-9686 3/8-24X1 X 3/8-16X5/8 OL 2" STUD	A-9699 7/16-20X3/4 X 7/16-14X9/16 OL 1-3/4" STUD							
A-9701 7/16-20X7/8 X 7/16-14X3/4 OL 2" STUD	A-9712 7/16-20X1-3/8 X 7/16-14X3/4 OL 2-1/2 STUD	A-9715 7/16-20X1-13/16 X 7/16-14X3/4 OL 3 STUD		A-9727 1/2-20X3/4 X 1/2-13X3/4 OL 1-7/8 STUD	A-9745 5/8-18X1-1/4 X 5/8-11X1 OL 3" STUD						
A-9731 1/2-20X1 X 1/2-13X3/4 OL 2-1/2 STUD	A-9732 1/2-20X2 X 1/2-13X3/4 OL 3" STUD	A-9739 9/16-18X1-1/4 X 9/16-12X1 OL		A-9744 5/8-11X1-1/2 X 5/8-11X13/16							

PRODUCT CATEGORY: X

**Universal Studs**  
**BLACK OIL FINISH**  
High Carbon - Heat Treated  
**21 Items • 67 Pcs**  
**IBS No. 119R**



Packaged in a Locking Steel Drawer for Easy Storage & Organization

IBS, Inc. SPECIALTY PRODUCTS FOR MAINTENANCE & REPAIR INDUSTRIALBOLTY.COM 800-878-1906			Copper Washers		
			Assortment No. 160R		
D-725-001 1/4ID X 5/8OD COPPER WASHER	D-725-002 5/16ID X 11/16OD COPPER WASHER	D-725-003 3/8ID X 3/4OD COPPER WASHER			
D-725-004 7/16ID X 13/16OD COPPER WASHER	D-725-005 1/2ID X 7/8OD COPPER WASHER				
D-725-011 1/4ID X 7/16OD COPPER WASHER	D-725-012 5/16ID X 1/2OD COPPER WASHER	D-725-013 3/8ID X 9/16OD COPPER WASHER			
D-725-014 7/16ID X 5/8OD COPPER WASHER	D-725-015 1/2ID X 11/16OD COPPER WASHER				

PRODUCT CATEGORY: W

**Copper Washers**  
**10 Items • 250 Pcs**  
**IBS No. 160R**



Packaged in a Locking Steel Drawer for Easy Storage & Organization

IBS, Inc. SPECIALTY PRODUCTS FOR MAINTENANCE & REPAIR INDUSTRIALBOLTY.COM 800-878-1906								Nylon Connectors and Vacuum Caps							
								Assortment No. 301P							
A-12929 1/8 STRT VACUUM CONNECTOR	A-12937 3/16 X 3/16 NYLON VACUUM CONN	A-12931 1/4 X 1/4 NYLON VACUUM CONN	A-12946 5/16 X 5/16 NYLON VACUUM CONN	A-12934 3/8 X 3/8 NYLON VACUUM CONN	A-12930 1/8X3/16 NYLON VACUUM CONN	A-12936 1/8 X 1/4 NYLON VACUUM CONN	A-12935 3/16 X 1/4 NYLON VACUUM CONN								
A-12923 1/8 NYLON VACUUM CONN	A-12918 3/16 NYLON VACUUM CONN	A-17629 1/4 NYLON VACUUM TEE	A-12920 5/16 NYLON VACUUM CONN	A-12925 3/8 NYLON VACUUM CONN			A-12927 3/16 VACUUM Y" CONNECTOR								
A-12209 1/8 HI-TEMP RUBBER VACUUM	A-19000 3/16 HI-TEMP RUBBER VACUUM	A-19001 1/4 HI-TEMP RUBBER VACUUM	A-19003 3/8 HI-TEMP RUBBER VACUUM				A-11419 3/16 4-WAY VACUUM CONN								
A-12916 1/8X3/16X1/8 NYLON VACUUM CONN	A-12919 1/4X3/16X3/16 NYLON VACUUM CONN	A-12926 5/16X3/16X1/8 NYLON VACUUM CONN	A-12921 3/8X3/8X1/4 NYLON VACUUM TEE				A-12949 3/16 SWAY VACUUM CONNECTOR								

PRODUCT CATEGORY: X

**Nylon Connectors & Vacuum Caps**  
**24 Items • 310 Pcs**  
**IBS No. 301P**



Packaged in a Locking Steel Drawer for Easy Storage & Organization

# IBS, INCORPORATED

## Assortments - Automotive (X)



Automotive Drain Plugs				
Assortment No. 321R				
<b>A-14196</b> 1/2-20 OIL DRAIN PLUG 	<b>A-19130</b> 1/2 DRAIN PLUG 	<b>A-17145</b> 1/2-20 OVERSIZE DRAIN PLUG 	<b>A-18121</b> 1/2 OIL DRAIN PLUG 	<b>A-8285</b> 5/8-18 OVERSIZE DRAIN PLUG W/FIBRE 
<b>A-15527</b> M12-1.25 OIL DRAIN PLUG 	<b>A-14677</b> M12-1.75 OIL PAN PLUG 	<b>A-19024</b> 14MM DRAIN PLUG W/GASKET 	<b>A-16308</b> 14MM DRAIN PLUG 	<b>A-14678</b> M14 DRAIN PLUG 
<b>A-15528</b> 16MM DRAIN PLUG 	<b>A-15529</b> 18MM DRAIN PLUG 			

PRODUCT CATEGORY: X

## Automotive Drain Plugs

12 Items • 72 Pcs  
IBS No. 321R



Packaged in a Locking Steel Drawer for Easy Storage & Organization

Oil Drain Plug Gaskets				
Assortment No. 322R				
<b>A-18726</b> 12MM ID 22MM OD BLACK DRAIN 	<b>A-18665</b> DRAIN PLUG RUBBER GASKET M12-1.75 	<b>A-16996</b> 1/2 NYLON DRAIN PLUG GASKET 	<b>A-19538</b> 1/2ID X 3/4OD BLACK FIBER 	<b>A-8277</b> 1/2 NYLON GASKET 
<b>A-16026</b> 1/2 STEEL & RUBBER DRAIN PLUG 	<b>A-1918</b> 1/2 COPPER DRAIN WASHER 	<b>A-19545</b> 1/2 COPPER DRAIN PLUG GASKET 	<b>A-16682</b> 14MM DRAIN PLUG GASKET 	<b>A-16681</b> M14 NYLON DRAIN PLUG GASKET 
<b>A-18299</b> 14MM X 25MM RUBBER/STEEL FORD 	<b>A-19007</b> 14MMX20MM STEEL CRUSHABLE 	<b>A-16956</b> M14 ALUMINUM DRAIN PLUG GASKET 	<b>A-8278</b> 5/8 NYLON OIL DRAIN PLUG 	<b>A-17263</b> M16 COPPER WASHER 
<b>A-16683</b> M16.5 NYLON DRAIN PLUG GASKET 	<b>A-18829</b> M18 GREEN OIL DRAIN PLUG 	<b>A-17264</b> M18 COPPER WASHER 	<b>A-16955</b> 18MM ALUM OIL DRAIN PLUG 	<b>A-19139</b> 20MM STEEL OIL DRAIN PLUG 

PRODUCT CATEGORY: X

## Oil Drain Plug Gaskets

20 Items • 260 Pcs  
IBS No. 322R



Packaged in a Locking Steel Drawer for Easy Storage & Organization

X-mas Tree Retainers				
Assortment No. 343P				
<b>A-10831</b> GM 32234 Ford 35036 Chry 389190 5031321 AAC 626498 Black Nylon Fender & Bumper Shield Retainer Stem Dia: 5/16" Stem Length: 3/4" HD Dia: 11/16" GM, Ford, Chrysler & AAC 	<b>A-17664</b> GM 1011452 Chry 803082 8033940 Ford 300579-9 Black Nylon Hood Insulation Retainer Shield Retainer Bentley's Front Cable Shield Engine Splash Shield Radiators Side Air Blower GM 1589-0h 	<b>A-12992</b> 38900363 20421900 White Nylon Door Trim Panel Retainer Stem Dia: 5/16" HD Dia: 3/4" x 7/8" Stem Length: 3/4" GM 1983-0h 	<b>A-13945</b> 101953-9-9901 White Nylon Door Trim Panel Retainer Stem Dia: 5/16" HD Dia: 3/4" Stem Length: 3/4" Trucks 	<b>A-11130</b> 0307811 3077735 Black Nylon Hood Insulation Retainer Stem Dia: 5/16" HD Dia: 7/8" Stem Length: 3/4" GM 1984-0h 
<b>A-11146</b> GM 160306 Chry 6020441 Ford 3885775 Nylon Radiator Tank Fender & Bumper Shield Retainer Stem Dia: 5/16" HD Dia: 11/16" Stem Length: 13/16" GM, Ford & Chrysler 	<b>A-12737</b> 12307920 20374473 White Nylon Door Panel Retainer Access & Pinset 1982-0h GM Truck 1989-0h 	<b>A-11796</b> 30065781 White Nylon Door Trim Panel Retainer Stem Dia: 5/16" HD Dia: 3/4" Stem Length: 3/4" GM 1978-0h 	<b>A-19356</b> 120666731 White Nylon Front & Rear Door Trim Panel Retainer GM Trucks 910 & 915 1999-0h 	
<b>A-12766</b> 1631984 22512761 Black Nylon Fender End Stone Shield Retainer Stem Dia: 7/16" HD Dia: 3/8" Stem Length: 13/16" GM 1981-0h 	<b>A-19541</b> 65041351 Black Nylon Hood Insulation Retainer Chrysler M501 Stone & DuraGlas 1987-0h 	<b>A-12565</b> 1891923-91 Black Nylon Door Trim Panel Retainer Stem Dia: 5/16" HD Dia: 25/32" Stem Length: 13/16" Ford 1981-0h 	<b>A-17612</b> Black Nylon Chrysler 9504543 Ford 9807721-5 Trim Panel Retainer Ford Explorer 1993-0h Trunk Lid Latch Chrysler 1986-0h 	<b>A-12909</b> 328930-91 Black Nylon Trim Panel Retainer Stem Dia: 5/16" HD Dia: 7/8" Stem Length: 11/16" Ford 1985-0h 
<b>A-20189</b> GM 16074026 Ford N806113-8 Chry 6020383 Black Nylon Trim Panel Retainer 	<b>A-16818</b> GM 21294148 Chrysler 6651901 Black Nylon Trim Panel Retainer GM Saturn 1991-0h Blowing Door & L/R Gate Trim Panel Retainer Chrysler Mini Van 1987-0h 	<b>A-12137</b> 18195271 Black Nylon Radiator Against Panel Retainer GM 1977-0h 	<b>A-18391</b> 18195271 Black Nylon Trim Panel Retainer Chry Astro & GMC Saver Mini Van 1983-0h 	

PRODUCT CATEGORY: X

## X-Mas Tree Retainers

18 Items • 330 Pcs  
IBS No. 343P



Packaged in a Locking Steel Drawer for Easy Storage & Organization



# IBS, INCORPORATED

## Assortments - Automotive (X)

ASSORTMENTS



### Nylon Push/Screw Type Retainers

 <b>A-18119</b> (387943-S) Black Nylon Front & Rear Bumper Push-Type Retainer Head Dia: 20mm Stem Length: 25mm Fits into 1/8" Hole Honda 1990-On	 <b>A-13993</b> (20510029) Black Nylon Body Retainer Head Dia: 15/16" Fits 1/4" Hole GM 1984-On	 <b>A-14993</b> Hole Dia: 250" Panel Flange: 100-197" Flange Dia: 700" Stem Length: 900" GM: 22538004	 <b>A-17143</b> (91502-SM-0000) Black Nylon Push-Type Retainer Hd Dia: 20 mm Stem Length: 27mm Fits 10mm Hole Bumper Fascia Accord 1990-On	 <b>A-14698</b> (90688-SBC-003) Black Nylon Push-Type Retainer Hd Dia: 18mm Stem Length: 11 mm Fits 6 mm Hole
 <b>A-14997</b> (10053182) Black Nylon Push-Type Retainer Head Dia: 19/32" Stem Length: 13/32" Fits into 5/16" Hole GM 1987-On	 <b>A-14011</b> (14019226; 14071289) Black Nylon Radiator Overflow Bottle/Windshield Washer Bottle Retainer Hd Dia: 21/32" Fits 5/16" Hole GM 1981-On	 <b>A-14994</b> Hole Dia: 250" Panel Range: 100-240" Flange Dia: 1000" Stem Length: 900" Ford: N8048375	 <b>A-14697</b> (GM: 94196687; Honda: 90657-SA6-003; Mazda N304-13-356A) Black Nylon Push-Type Retainer Hd Dia: 14mm Stem Length: 11mm Fits 7mm Hole	
 <b>A-14992</b> (Ford: N803945S; Chry: 6502871) Black Nylon Push-Type Retainer Head Dia: 19/32" Stem Length: 29/32" Fits into 1/4" Hole Ford & Chrysler 1987-On	 <b>A-13994</b> (GM: 20570245; Ford: N8048143) Black Nylon Spare Tire Retainer Hd Dia: 1" Fits into 5/8 Hole Accord 1990 - On	 <b>A-17057</b> (90505-SM-4-003) Black Nylon Push-Type Retainer Head Dia: 18mm Stem Length: 21mm Fits into 5/8 Hole Accord 1990 - On	 <b>A-16000</b> (Honda: 90675-SB3-003; Mazda: FB01-56-994; Nissan: 63876-95595) Black Nylon Push Type Retainer Hd Dia: 20mm Stem Length: 9mm Fits 8mm Hole	
 <b>A-14260</b> (Toyota: 90467-05017; Mazda: 9925-20-6205; GM: 20429301) Black Nylon Push-Type Retainer Head Dia: 15mm Stem Length: 12mm Fits into 7mm Hole	 <b>A-17632</b> (Mazda: B092-51-833; Ford: M8-425-56143) Black Nylon Push-Type Retainer Head Dia: 18mm Stem Length: 12mm Fits into 3mm Hole Mazda & Ford Aspire	 <b>A-17222</b> (GM: 11561878; 21075606; Ford: FOLY14579-B) Black Nylon Push-Type Retainer Head Dia: 15mm Stem Length: 20mm Fits into 3mm Hole Saturn 1991 - On	 <b>A-16888</b> (Nissan: 63876-01402; Ford: NMA01-56145; NAD1-56145) Black Nylon Shield Retainer Hd Dia: 20mm(23/32") Stem Length: 18mm(23/32") Fits 8mm 5/16 Hole Nissan 1990-On Ford Probe & Aspire 1995-On	

PRODUCT CATEGORY: X

## Nylon Push Screw Type Retainers

17 Items • 155Pcs  
IBS No. 344P



Packaged in a Locking Steel Drawer for Easy Storage & Organization



### Black Trim Screws

 <b>A-10654</b> #8 X 1-1/4 PHIL OVAL SEMS T/S	 <b>A-12820</b> 8 X 3/4 PHIL PAN SEMS T/S B/O	 <b>A-12213</b> 8 X 1/2 PHIL FLT TOP WASH HD	 <b>A-12215</b> 8 X 3/4 PHIL FLT TOP WASH HD	 <b>A-12216</b> 8 X 1 PHIL FLT TOP WASH HD
 <b>A-12953</b> 10 X 3/4 PHIL FLT TOP WASH HD	 <b>A-12954</b> 10 X 1 PHIL FLT TOP WASH HD	 <b>A-10180</b> 8 X 1/2 PHIL PAN HD T/S B/O	 <b>A-10181</b> 8 X 3/4 PHIL PAN HD T/S B/O	 <b>A-10182</b> 8 X 3/4 PHIL PAN HD T/S B/O
 <b>A-11921</b> 10 X 1 1/2 PHIL PAN HD T/S B/O	 <b>A-11922</b> 10 X 3/4 PAN HD T/S B/O	 <b>A-11923</b> 10 X 1 PHIL PAN HD T/S B/O	 <b>A-10163</b> 8 X 1 1/2 PHIL OVAL T/S B/O	 <b>A-10165</b> 8 X 3/4 PHIL OVAL T/S B/O
 <b>A-11086</b> 10 X 3/4 PHIL OVAL T/S B/O	 <b>A-11088</b> 10 X 1 PHIL OVAL T/S B/O	 <b>A-12060</b> M4.2 X 20 PHIL WASHER HD T/S	 <b>A-15373</b> M4.2 X 20 HEX HD SEMS T/S B/O	 <b>A-12339</b> M6.3 X 25 HEX HD SEMS T/S B/O

PRODUCT CATEGORY: X

## Black Trim Screws

22 Items • 950 Pcs  
IBS No. 345P



Packaged in a Locking Steel Drawer for Easy Storage & Organization



### Metric Body Hardware

 <b>A-13613</b> M8 X 25 HEX HEAD SEMS T/S	 <b>A-12336</b> M8 X 25 HEX WASHER HD T/S	 <b>A-15780</b> M8 X 33 HEX HD SEMS T/S DOG PT	 <b>A-11641</b> M10 X 40 HEX HD SEMS T/S
 <b>A-11709</b> M8-1.25 HEX FLANGE LOCKNUT 17MM FLANGE	 <b>A-15334</b> M8-1.25 FREE SPINNING WASHER	 <b>A-12667</b> M8-1.25 GM "U" NUT	 <b>A-11630</b> M8-1.25 GM/FORD U NUT
 <b>A-12065</b> M6 X 25 HEX HEAD SEMS T/S	 <b>A-15818</b> M6 X 30 HEX HD SEMS T/S DOG PT	 <b>A-12160</b> M6 X 22 HEX HD SEMS T/S DOG PT	 <b>A-16893</b> M6 X 28 HEX HD SEMS T/S DOG PT
 <b>A-18251</b> HEX FLANGE LOCKNUT M6-1.0 THREAD	 <b>A-15329</b> M6-1.0 FREE SPINNING WASHER	 <b>A-12669</b> M6-1.0 GM/FORD "U" NUT	 <b>A-12575</b> M6-1.0 GM "U" NUT

PRODUCT CATEGORY: X

## Metric Body Hardware

19 Items • 215 Pcs  
IBS No. 346P



Packaged in a Locking Steel Drawer for Easy Storage & Organization

# IBS, INCORPORATED

## Assortments - Automotive (X)



<b>JIS Hex Head Capscrews</b>					
Assortment No. 697R					
10802 M8-1.25 X 16 JIS HEX C/S ZP	10803 M8-1.25 X 20 JIS HEX C/S ZP	10804 M8-1.25 X 25 JIS HEX C/S ZP	10805 M8-1.25 X 30 JIS HEX C/S ZP	10807 M8-1.25 X 40 JIS HEX C/S ZP	10811 M10-1.25 X 20 JIS HEX C/S ZP
10812 M10-1.25 X 25 JIS HEX C/S ZP	10813 M10-1.25 X 30 JIS HEX C/S ZP	10814 M10-1.25 X 35 JIS HEX C/S ZP	10815 M10-1.25 X 40 JIS HEX C/S ZP	10816 M10-1.25 X 45 JIS HEX C/S ZP	10817 M10-1.25 X 50 JIS HEX C/S ZP
10822 M12-1.25 X 25 JIS HEX C/S ZP	10823 M12-1.25 X 30 JIS HEX C/S ZP	10824 M12-1.25 X 35 HEX C/S JIS ZP	10825 M12-1.25 X 40 JIS HEX C/S ZP	10827 M12-1.25 X 50 JIS HEX C/S ZP	
10840 M8-1.25 JIS HEX NUT ZP	10841 M10-1.25 JIS HEX NUT ZP	10842 M12-1.25 JIS HEX NUT ZP			

### JIS Hex Head Capscrews

20 Items • 595 Pcs  
IBS No. 697R



Packaged in a Locking Steel Drawer  
for Easy Storage & Organization

PRODUCT CATEGORY: X

<b>Door Panel and Moulding Clips</b>				
Assortment No. 842R				
A-11612 WEATHERSTRIP RETAINER - GM FORD AMC	A-12571 FASCIA TO BUMPER RETAINER BLK FORD	A-12992 5/16 GM NYLON RET. DOOR TRIM PANEL	A-14021 FASCIA RETAINER BLK	A-15480 FORD INTERIOR TRIM PANEL RETAINER - BLACK NYLON
A-15668 FORD TRIM PANEL RETAINER	A-15670 GM DOOR PANEL RETAINER	A-15970 GM DOOR TRIM PANEL RETAINER WHITE NYLON	A-16017 WHITE NYLON TRIM PANEL RETAINER	A-17102 WHITE TRIM PANEL RETAINER
A-17339 LINCOLN WEATHERSTRIP RETAINER	A-18033 CHRYSLER WEATHERSTRIP RETAINER	A-18353 DOOR TRIM PANEL PUSH TYPE RETAINER	A-18848 YELLOW FORD DOOR TRIM PANEL RETAINER	A-19386 CHRYSLER TRIM PANEL RETAINER NYLON
A-19655 HOOD INSULATION RETAINER BLK FORD	A-19850 WEATHER STRIP RETAINER	A-21241 FORD TRIM BLK NYLON ROCKER, PILLER & FENDER LINER 7.5MM X 28MM		

### Door Panel & Moulding Clips

18 Items • 315 Pcs  
IBS No. 842R



Packaged in a Locking Steel Drawer  
for Easy Storage & Organization

PRODUCT CATEGORY: X

<b>Push-In Fasteners</b>				
Assortment No. 843R				
A-14260 TOYOTA PUSH-TYPE RETAINER 15MM HEAD DIA.	A-14369 MAZDA PUSH-TYPE RETAINER 20MM HD DIA. 9MM LENGTH	A-14753 PUSH-TYPE RETAINER 11/16 HEAD DIA. 7/8 LENGTH	A-16835 12MM SCREW RETAINER NYLON	A-17103 FASCIA RETAINING CLIP
A-17216 PUSH-TYPE RETAINER 20MM HEAD DIA. 20MM LENGTH	A-18030 CHRYSLER PUSH TYPE RTNR 11/16 HD 13/16 LGTH	A-18269 CHRYSLER LOWER SILL MOULDING CLIP	A-18310 GM REAR BUMPER FASCIA PUSH RETAINER	A-19244 FORD TRUNK TRIM PANEL RETAINER 1 HEAD DIA
A-19422 CHRYSLER FASCIA PUSH TYPE RETAINER 29/32 STM LENGTH	A-19801 GM PUSH-TYPE RETAINER	A-20191 FORD PUSH TYPE RETNR 16MM HD DIA 18MM STM LGTH	A-20349 NISSAN BUMPER CLIP PUSH TYPE RETAINER	A-20923 FORD & MAZDA PUSH TYPE RETAINER
A-21173 ACURA & HONDA PUSH TYPE RTNR BLK BUMPER & SPLASH SHIELD				

### Push-In Fasteners

16 Items • 135 Pcs  
IBS No. 843R



Packaged in a Locking Steel Drawer  
for Easy Storage & Organization

PRODUCT CATEGORY: X

ASSORTMENTS



# IBS, INCORPORATED

## Assortments - Automotive (X)

ASSORTMENTS



### Tire Valves and Caps Assortment

Assortment No. 861R

10963 TR# 413 Rubber Snap-In Valve 	10994 TR #600HP 1 1/4 High' Pressure Snap-In 	10970 TR #C-1, Short Std. Bore Valve Core, Black 	10972 TR #VC-3, Long Skirted Metal Dome Cap 
10964 TR# 414 Rubber Snap-In Valve 	10995 TR #602HP 2 High Pressure' Snap-In 	10971 TR #C-1, Short Std. Bore Valve Core, High Temp (Red) 	10973 TR #VC-8, Black Plastic Valve Cap 
10965 TR# 415 Rubber Snap-In Valve 	10991 TR# 801HP 1-1/4 High Pressure Snap-In, .625 Rim Hole 	10975 3/4 Metal Valve Extension 	10981 LONG SKIRTED GREEN PLASTIC VALVE CAP WITH SEAL 
10968 TR# 418 Rubber Snap-In Valve 	10992 TR# 802HP 2 HI Press Snap In .625 Rim Hole 	10976 1-1/4 Metal Valve Extension 	10986 Four-Way Valve Tool 

PRODUCT CATEGORY: X

**Tire Valves and Caps**  
16 Items • 210 Pcs  
IBS No. 861R



Packaged in a Locking Steel Drawer for Easy Storage & Organization



### Tire Repair Assortment

Assortment No. 862R

10907 1-3/4 (44mm) Small Round USA Universal Repair Units Radial or Bias 	10914 2-1/4 x 4 (57mm x 100mm) Radial 12, 1 Ply USA Style COI Radial Repair Unit 	10921 1-5/8 (42mm) Round, 5/32 (4mm) Round Stem Universal Quilled 	10926 Patch: 2-1/8 (55mm), Stem 1/4 (7.5mm) Lead-Wire Combination Unit 
10908 2-1/4 (57mm) Medium Round USA Universal Repair Units Radial or Bias 	10915 3-3/4 x 4 (95mm x 100mm) Radial 14, 1 Ply USA COI Radial Repair Unit 	10922 1-7/8 (47mm) Round, 7/32 (5.5mm) Round Stem Universal Quilled 	10918 4 (102mm) Fat, Brown String 
10909 3-1/4 (82mm) Large Round USA Universal Repair Units Radial or Bias 	10916 2-7/8 x 5 (72mm x 125mm) Radial 20, 2 Ply USA COI Radial Repair Unit 	10925 Patch: 1-5/8 (42mm), Stem: 3/16 (5mm) Lead-Wire Combination Unit 	10920 8 (204mm) Fat, Brown String 

PRODUCT CATEGORY: X

**Tire Repair**  
12 Items • 50 Pcs  
IBS No. 862R



Packaged in a Locking Steel Drawer for Easy Storage & Organization

# IBS, INCORPORATED

## Assortments - Anchors (Y)



IBS, Inc. SPECIALTY PRODUCTS FOR MAINTENANCE & REPAIR INDUSTRIALBOLT.COM © 9 0 300-678-1996		Hollow Wall Anchors & Fasteners		
Assortment No. 205R				
7698 6 X 1 PHIL PAN HD T/S ZP 		55230 4-6-8 X 1 WING SCREW PLASTIC 	55038 E-Z MINI ANCHOR ZINC 	
7717 8 X 1 PHIL PAN HD T/S ZP 	7719 8 X 1-1/2 PHIL PAN HD T/S ZP 	55231 8-10-12X1-1/4 WING SCREW 	55037 EZ-ANCHOR WHITE NYLON 	
7733 10 X 1 PHIL PAN HD T/S ZP 	7735 10 X 1-1/2 PHIL PAN HD T/S ZP 	55231 8-10-12X1-1/4 WING SCREW 	55036 EZ-ANCHOR ZINC 	55035 MUNGO JET PLUG EZ-ANCHOR 
7763 14 X 1 PHIL PAN HD T/S ZP 	7765 14 X 1-1/2 PHIL PAN HD T/S ZP 	55232 12-14-16X1-1/2 WING SCREW 	55240 E-Z TOGGLE STANDARD 	

PRODUCT CATEGORY: Y

### Hollow Wall Anchors & Fasteners

16 Items • 650 Pcs  
IBS No. 205R



Packaged in a Locking Steel Drawer for Easy Storage & Organization

IBS, Inc. SPECIALTY PRODUCTS FOR MAINTENANCE & REPAIR INDUSTRIALBOLT.COM © 9 0 300-678-1996		Concrete Screws with Drills & Installation Kit		
Assortment No. 273P				
55309 1/4 X 2-1/4 HWH CONCRETE SCREW 	55316 3/16X2-1/4 PHIL FLT CONCRETE SCREW 	55336 5/32X7 SDS HEX CARBIDE DRILL Use with 3/16 Screws 	55330 TOOL KIT FOR CONCRETE SCREWS 	
55308 1/4 X 1-3/4 HWH CONCRETE SCREW 	55315 3/16X1-3/4 PHIL FLT CONCRETE SCREW 	55338 3/16X7 SDS HEX CARBIDE DRILL Use with 1/4 Screws 		
55307 1/4 X 1-1/4 HWH CONCRETE SCREW 	55314 3/16X1-1/4 PHIL FLT CONCRETE SCREW 	55317 3/16X2-3/4 PHIL FLT CONCRETE SCREW 	55324 1/4X2-3/4 PHIL FLT CONCRETE SCREW 	
55300 3/16 X 1-1/4 HWH CONCRETE SCREW 	55310 1/4 X 2-3/4 HWH CONCRETE SCREW 			

PRODUCT CATEGORY: Y

### Concrete Screws with Drills & Installation Kit

13 Items • 253 Pcs  
IBS No. 273P



Packaged in a Locking Steel Drawer for Easy Storage & Organization

IBS, Inc. SPECIALTY PRODUCTS FOR MAINTENANCE & REPAIR INDUSTRIALBOLT.COM © 9 0 300-678-1996		Hollow Wall Anchors & Fasteners		
Assortment No. 397R				
55095 10-24 (3/16-24) HVY TOGGLE ANCHOR 	55096 1/4-20 HVY DUTY TOGGLE ANCHOR 	55093 1/2 TO 5/8 POLY TOGGLE 	143150 3/16 X 1-1/4 RAPIDRIVE PHIL PH CHROME ANCHOR SCREW 	
		55037 EZ-ANCHOR WHITE NYLON 		
		7719 8 X 1-1/2 PHIL PAN HD T/S ZP 	143152 3/16 X 1-1/4 RAPIDRIVE PHIL OH CHROME ANCHOR SCREW 	
9585 10-24 X 3 PHIL ROUND HD M/S ZP 	9608 1/4-20 X 4 PHIL ROUND HD M/S ZP 			

PRODUCT CATEGORY: Y

### Hollow Wall Anchors & Fasteners

9 Items • 180 Pcs  
IBS No. 397R



Packaged in a Locking Steel Drawer for Easy Storage & Organization



# **IBS, INCORPORATED**

## **Travel Tray Assortments Z03**

**A  
S  
S  
O  
R  
T  
M  
E  
N  
T  
S**





# IBS, INCORPORATED

## Travel Tray Assortments Z03

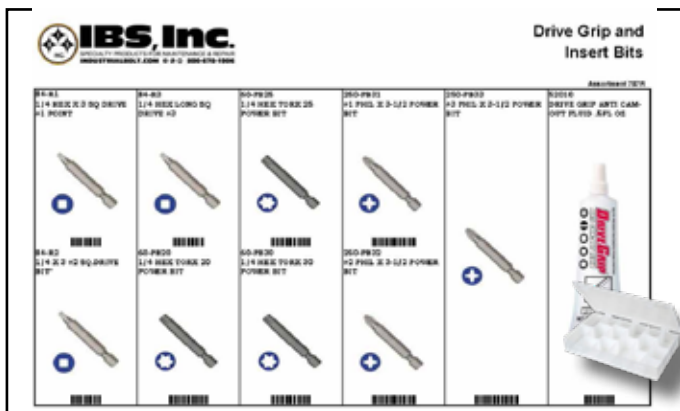

PRODUCT CATEGORY: E

**DRIVE GRIP & INSERT BITS**  
IBS No. 787R • 10 ITEMS • 19 Pcs

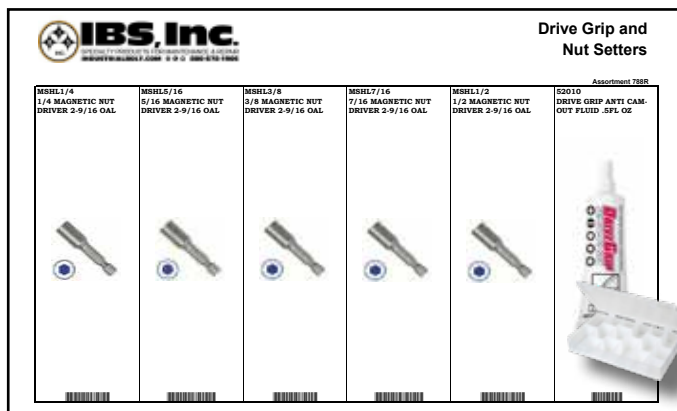

PRODUCT CATEGORY: E

**DRIVE GRIP & NUTSERTS**  
IBS No. 788R • 6 ITEMS • 9 Pcs



PRODUCT CATEGORY: E

**GRAB-IT DAMAGED SCREW REMOVER**  
IBS No. 794R • 5 ITEMS • 5 Pcs

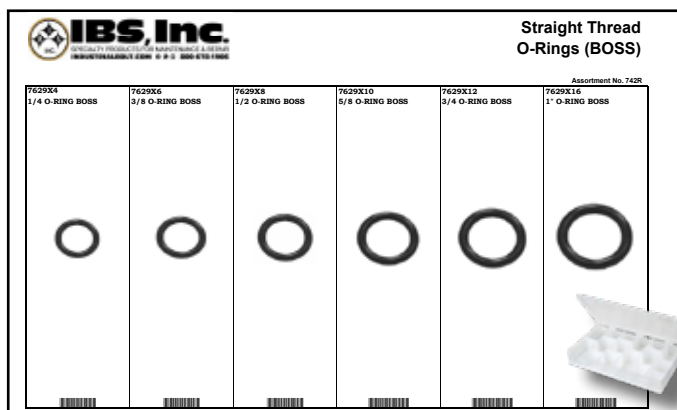

PRODUCT CATEGORY: O

**STRAIGHT THREAD BOSS O-RINGS**  
IBS No. 742R • 6 ITEMS • 135 Pcs

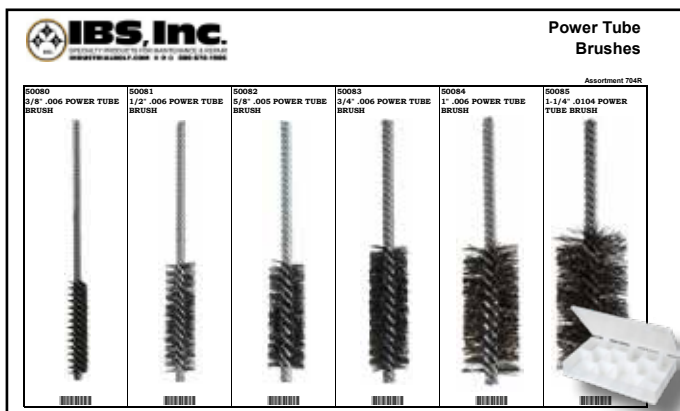

PRODUCT CATEGORY: PA

**POWER TUBE BRUSHES**  
IBS No. 704R • 6 ITEMS • 6 Pcs



PRODUCT CATEGORY: PD

**NITRO CARB DRAPS COARSE THREAD**  
IBS No. 17178 • 6 ITEMS • 6 Pcs

ASSORTMENTS



# IBS, INCORPORATED

## Travel Tray Assortments Z03

ASSORTMENTS



PRODUCT CATEGORY: PD

**NITRO CARB DRAPS METRIC THREAD**  
IBS No. 17179 • 4 ITEMS • 4 Pcs

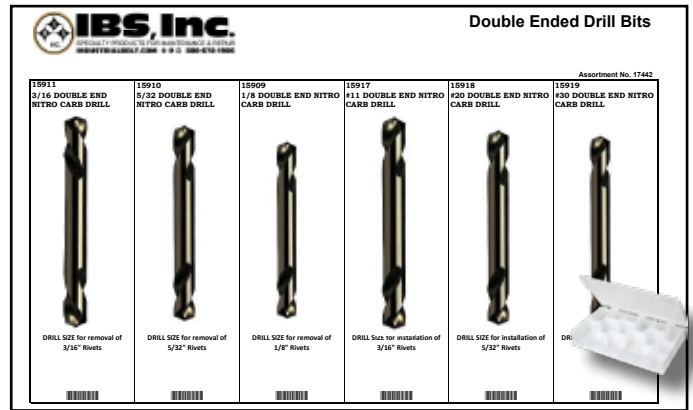

PRODUCT CATEGORY: PD

**DOUBLE-ENDED DRILL BITS**  
IBS No. 17442 • 6 ITEMS • 6 Pcs



PRODUCT CATEGORY: PD

**POWER OUT EXTRACTOR & LEFT HAND NITRO CARB DRILL BITS**  
IBS No. 745R • 10 ITEMS • 10 Pcs



PRODUCT CATEGORY: PD

**NITRO-CARB-STEP DRILLS**  
IBS No. 749R • 6 ITEMS • 6 Pcs

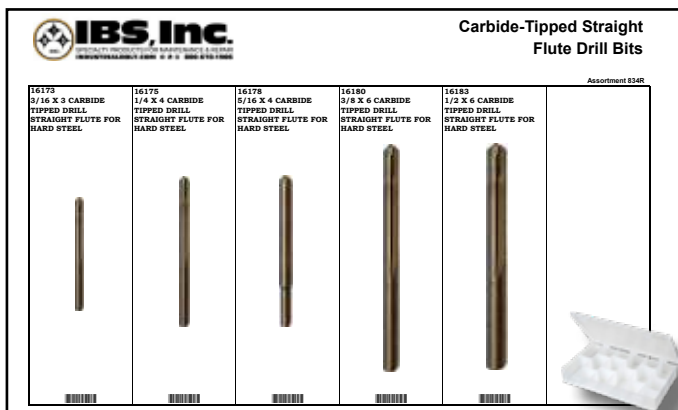

PRODUCT CATEGORY: PD

**CARBIDE-TIPPED STRAIGHT FLUTE DRILL BITS**  
IBS No. 834R • 5 ITEMS • 5 Pcs



PRODUCT CATEGORY: PD

**POWER-OUT EXTRACTORS & STUBBY LEFT HAND DRILL BITS**  
IBS No. 818R • 10 ITEMS • 10 Pcs

# IBS, INCORPORATED

## Travel Tray Assortments Z03

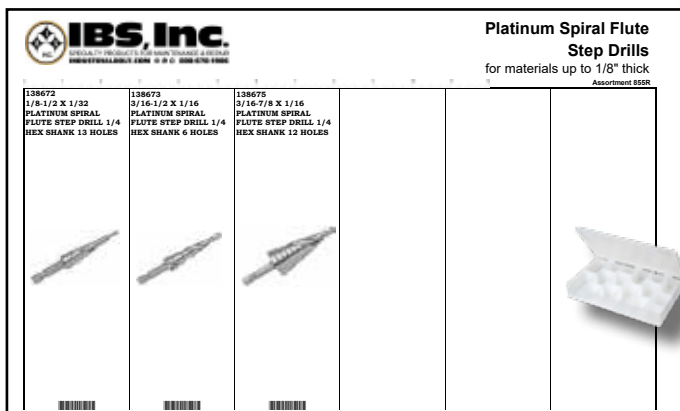

PRODUCT CATEGORY: PD

### PLATINUM SPIRAL FLUTE STEP DRILLS

IBS No. 855R • 3 ITEMS • 3 Pcs

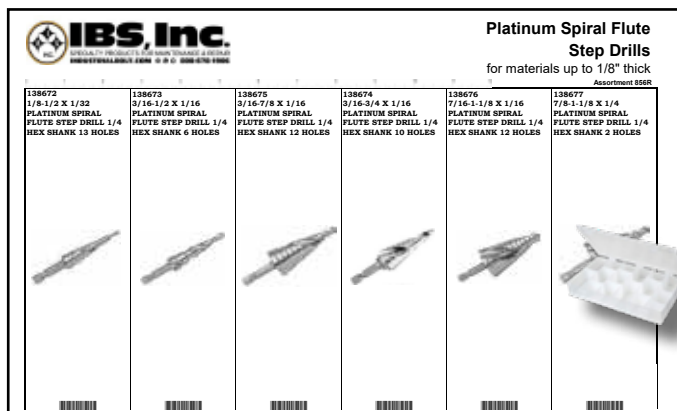

PRODUCT CATEGORY: PD

### PLATINUM SPIRAL FLUTE STEP DRILLS

IBS No. 856R • 6 ITEMS • 6 Pcs

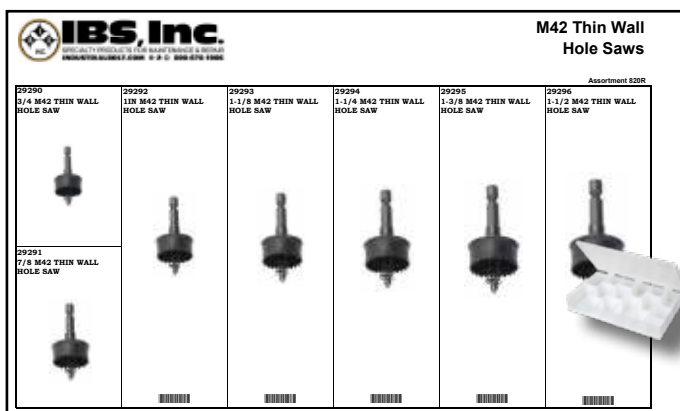

PRODUCT CATEGORY: PT

### M42 THIN WALL HOLE SAWS

IBS No. 820R • 7 ITEMS • 7 Pcs

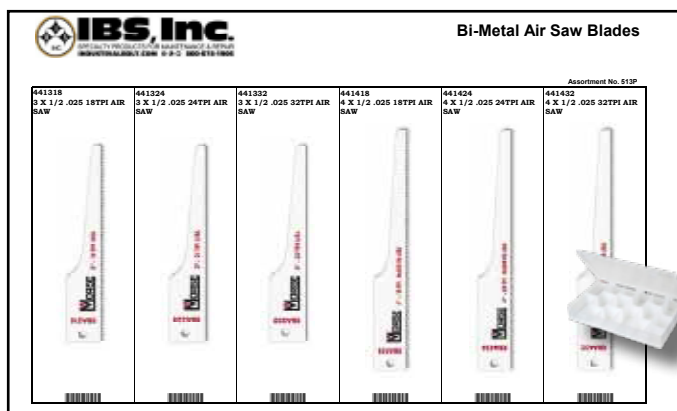

PRODUCT CATEGORY: PT

### BI-METAL AIR SAW BLADES

IBS No. 513P • 6 ITEMS • 30 Pcs

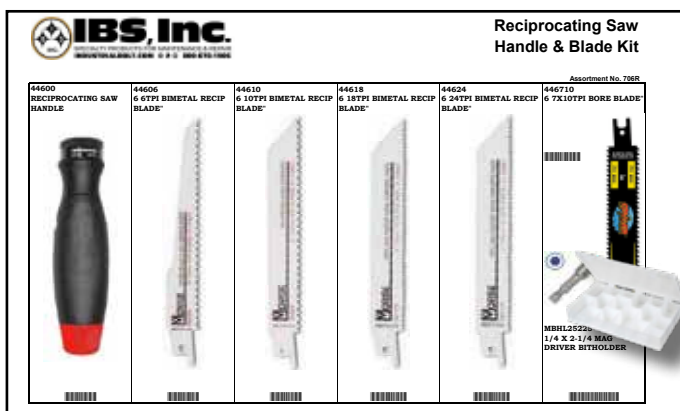

PRODUCT CATEGORY: PT

### RECIPROCATING SAW HANDLE BLADE KIT

IBS No. 706R • 7 ITEMS • 11 Pcs

ASSORTMENTS



# IBS, INCORPORATED

## Travel Tray Assortments Z03

ASSORTMENTS

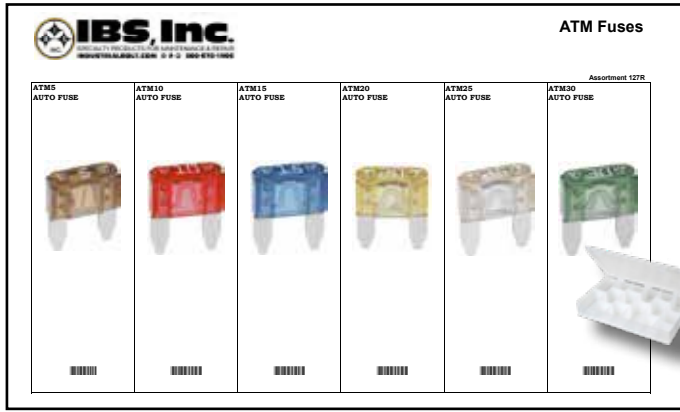

PRODUCT CATEGORY: Q

### ATM FUSES

IBS No. 127R • 6 ITEMS • 60 Pcs



PRODUCT CATEGORY: Q

### MAXI FUSES

IBS No. 128R • 7 ITEMS • 31 Pcs

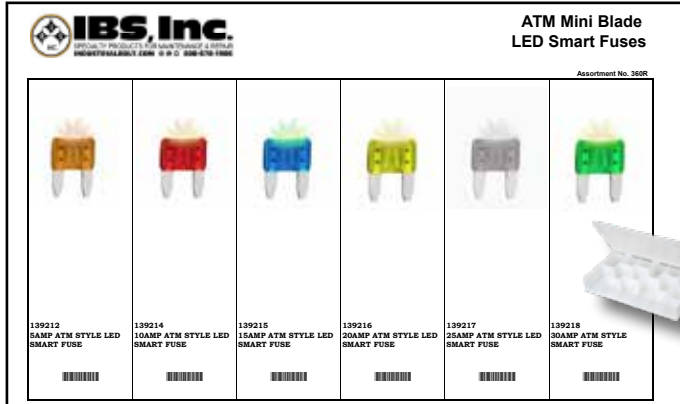

PRODUCT CATEGORY: Q

### ATM MINI BLADE LED SMART FUSES

IBS No. 360R • 6 ITEMS • 36 Pcs

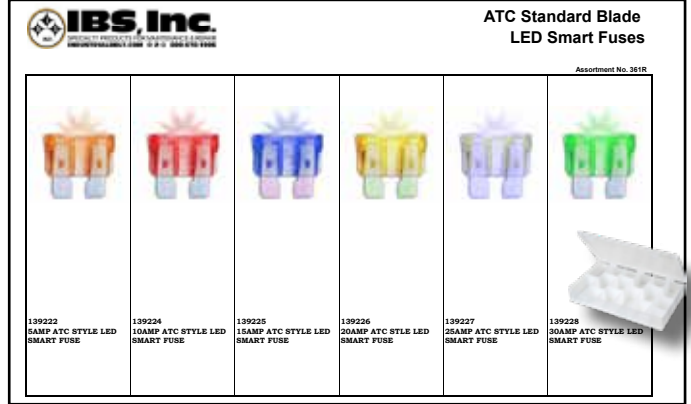

PRODUCT CATEGORY: Q

### ATC STANDARD BLADE LED FUSES

IBS No. 361R • 6 ITEMS • 42 Pcs



PRODUCT CATEGORY: Q

### MAXI BLADE LED SMART FUSES

IBS No. 362R • 6 ITEMS • 18 Pcs



PRODUCT CATEGORY: Q

### ATM LOW PROFILE FUSES

IBS No. 721R • 7 ITEMS • 35 Pcs

# IBS, INCORPORATED

## Travel Tray Assortments Z03

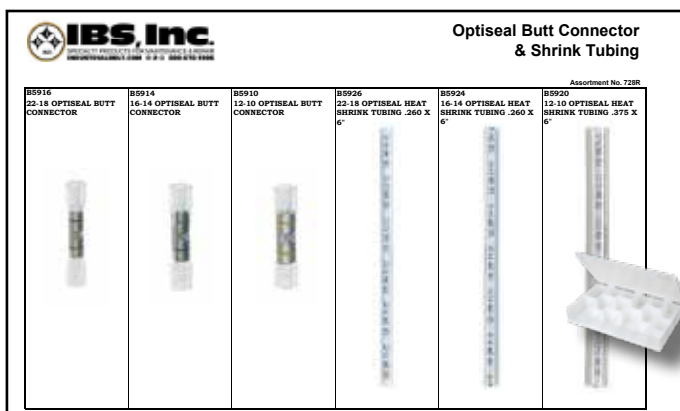

PRODUCT CATEGORY: Q

### OPTI-SEAL BUTT CONNECTORS & SHRINK TUBING

IBS No. 728R • 6 ITEMS • 100 Pcs

IBS No. 728R-1 • KIT WITH CRIMP TOOL

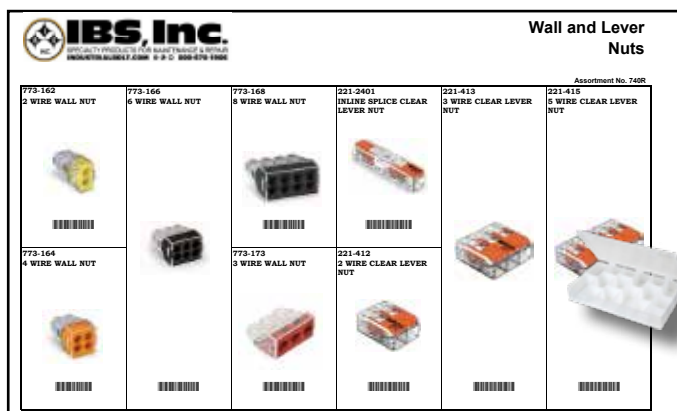

PRODUCT CATEGORY: Q

### WALL & LEVER NUTS

IBS No. 740R • 9 ITEMS • 105 Pcs

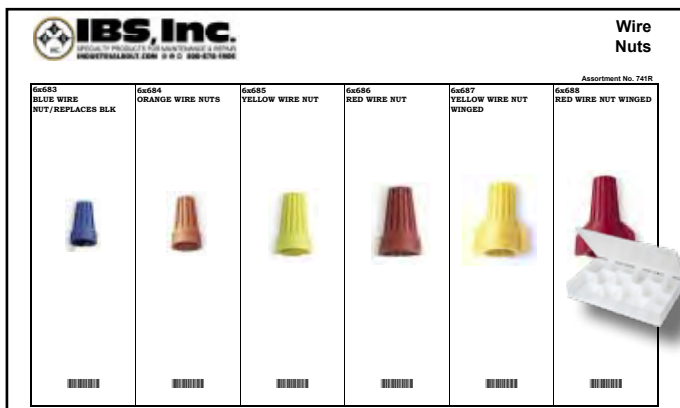

PRODUCT CATEGORY: Q

### WIRE NUTS

IBS No. 741R • 6 ITEMS • 90 Pcs

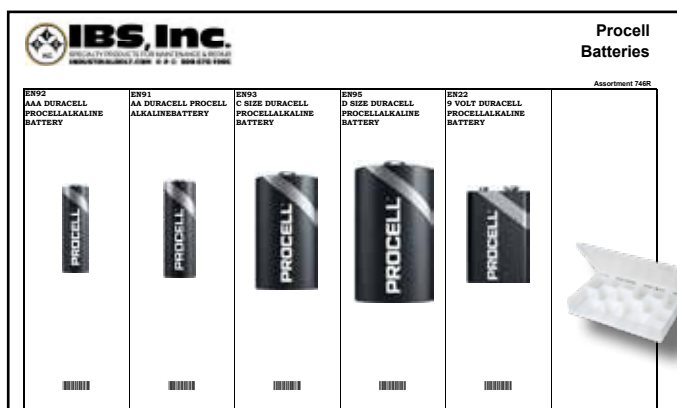

PRODUCT CATEGORY: Q

### PROCELL BATTERIES

IBS No. 746R • 5 ITEMS • 30 Pcs



PRODUCT CATEGORY: Q

### ATC FUSES

IBS No. 792R • 8 ITEMS • 40 Pcs

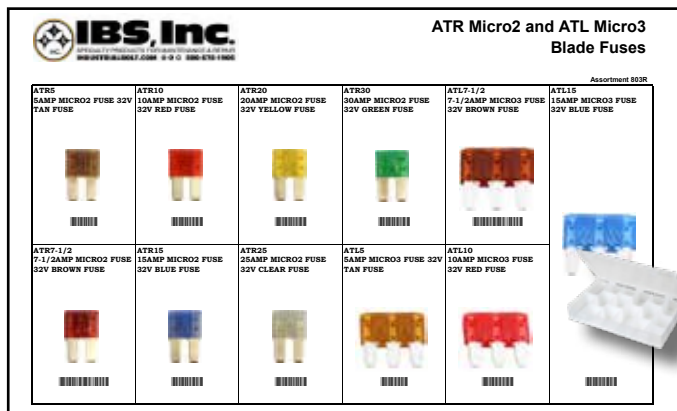

PRODUCT CATEGORY: Q

### ATR MICRO2 & ATL MICRO3 BLADE FUSES

IBS No. 803R • 11 ITEMS • 55 Pcs

ASSORTMENTS



# IBS, INCORPORATED

## Travel Tray Assortments Z03

ASSORTMENTS



PRODUCT CATEGORY: Q

**FMX FUSES**  
IBS No. 851R • 6 ITEMS • 12 Pcs

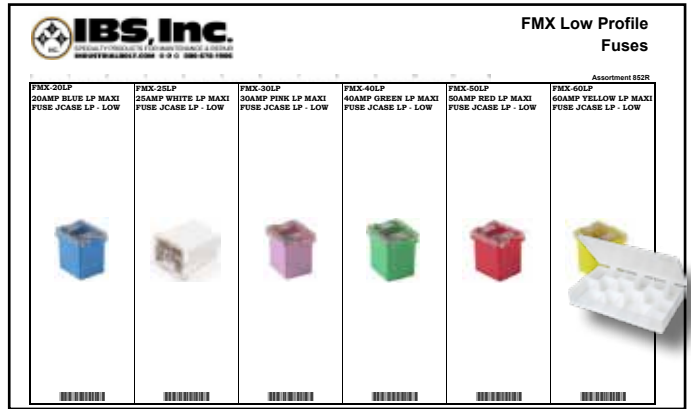

PRODUCT CATEGORY: Q

**FMX LOW PROFILE FUSES**  
IBS No. 852R • 6 ITEMS • 12 Pcs

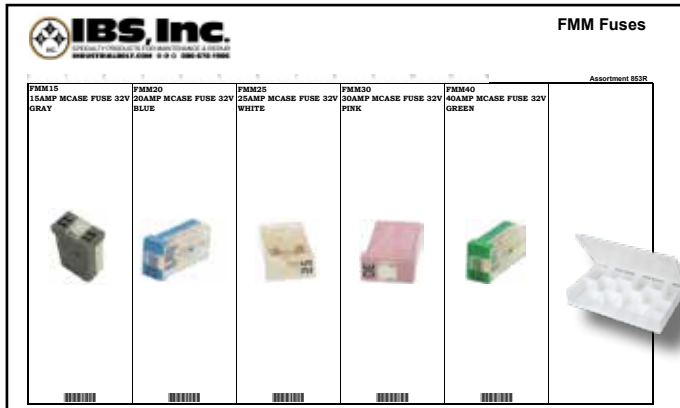

PRODUCT CATEGORY: Q

**FMM FUSES**  
IBS No. 853R • 5 ITEMS • 30 Pcs

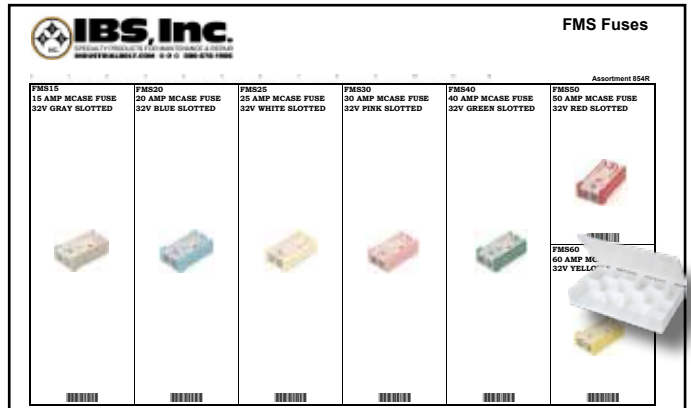

PRODUCT CATEGORY: Q

**FMS FUSES**  
IBS No. 854R • 7 ITEMS • 35 Pcs



PRODUCT CATEGORY: SA

**LOCTITE QUICK-STIX TRAVEL TRAY**  
IBS No. 673R • 6 ITEMS • 6 Pcs



PRODUCT CATEGORY: SA

**LOCTITE 10ML TRAVEL TRAY**  
IBS No. 747R • 6 ITEMS • 6 Pcs

# IBS, INCORPORATED

## Travel Tray Assortments Z03



PRODUCT CATEGORY: Q

**NO MESS THREADLOCKER  
TRAVEL TRAY**  
IBS No. 817R • 4 ITEMS • 4 Pcs



PRODUCT CATEGORY: Q

**THREADLOCKER, ANTI-SEIZE  
& DIELECTRIC GREASE TRAVEL TRAY**  
IBS No. 832R • 6 ITEMS • 12 Pcs



PRODUCT CATEGORY: SCO

**DURA-INK INDUSTRIAL MARKERS**  
IBS No. 694R • 7 ITEMS • 11 Pcs



PRODUCT CATEGORY: SCO

**QUIK STIK & PAINT MARKERS**  
IBS No. 806R • 6 ITEMS • 6 Pcs



PRODUCT CATEGORY: V

**PRESSURE WASHER NOZZLES**  
IBS No. 830R • 4 ITEMS • 4 Pcs

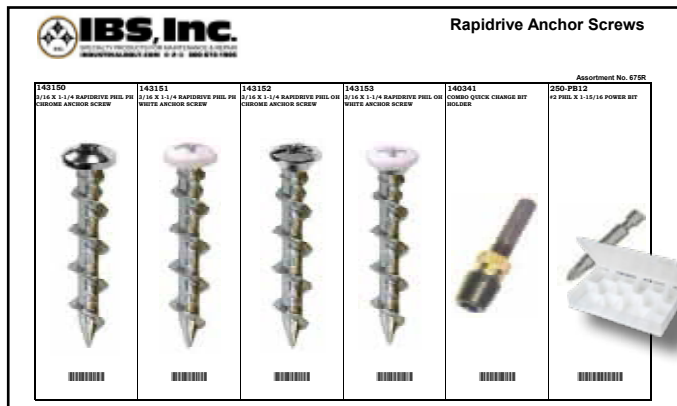

PRODUCT CATEGORY: Y

**RAPIDRIVE ANCHOR SCREWS**  
IBS No. 675R • 6 ITEMS • 205 Pcs

ASSORTMENTS



**A  
S  
S  
O  
R  
T  
M  
E  
N  
T  
S**