

PRODUCT CATALOG

**2023
EDITION**



800-678-1906
www.industrialbolt.com

 **IBS, Inc.**
SPECIALTY PRODUCTS FOR MAINTENANCE & REPAIR

P.O. BOX 1717, AUBURN, WASHINGTON 98071-1717 | 800-678-1906 | www.industrialbolt.com



Capscrews

A

Assortments

Grade 5

Coarse Thread - 40 Items A-24

Coarse Thread - 72 Items A-23

Fine Thread - 40 Items A-26

Fine Thread - 72 Items A-25, A-26

Grade 8

Coarse Thread - 40 Items A-14

Coarse Thread - 72 Items A-13, A-14

Coarse Thread - Plated - 40 Items A-17

Coarse Thread - Zinc Yellow Plated 72B A-16

Fine Thread - 72 Items A-19

Fine Thread - Plated 40 Items A-20

Hi-Alloy

Fine Thread - 72 Items A-10

C

Capscrews

Grade 5 A-21

N.C. 1/4 - 1/2 A-22

N.F. 1/4 - 1/2 A-25

Grade 8 A-11

N.C. 1/4 - 7/16 A-12

N.F. 9/16 - 1 A-18

Grade 8 - Plated

N.C. 1/4 - 1/2 A-15

High-Alloy A-4

N. C. 1/4 - 1/2 A-6

N. F. 1/4 - 1/2 A-9

F

Fasteners

Flange Bolts, Grade 8

Fine A-28

General Information

Grade 5 Hex Capscrews A-21

Grade 8 Flange Bolts A-27

Grade 8 Heat Treated Hex Capscrews A-11

High-Alloy Fastening System A-4

Thread Pitch Chart - National Coarse A-2

Thread Pitch Chart - National Fine A-3

Grade 8 Capscrews

Fine A-18

Grade 8 Capscrews - Plain

Coarse A-12

Grade 8 Capscrews - Plated

Coarse A-15

High-Alloy Capscrews

Coarse A-6

Fine A-9

Flange Bolts

Grade 8 A-27

N.C. 3/8 - 3/4 A-28

N.F. 1/2 - 5/8 A-28

T

Thread Pitch Chart - National Coarse A-2

Thread Pitch Chart - National Fine A-3



Thread Pitch Chart - National Coarse

C
A
P
S
C
R
E
W
S

1/4-20



7/8-9 9

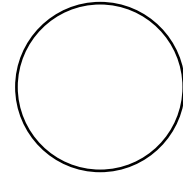
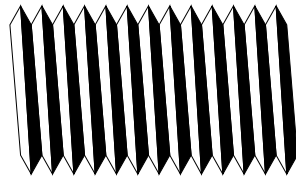

5/16-18



1"-8

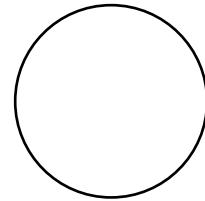
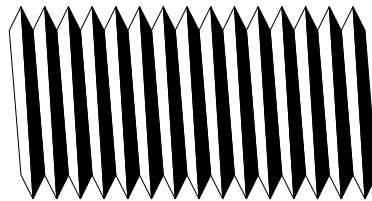

3/8-16



7/16-14



1-1/8"-7 7

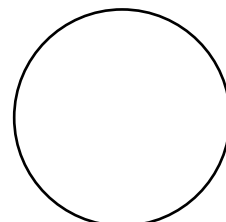
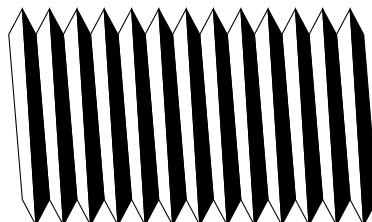

1/2-13

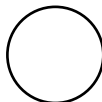
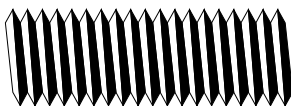

1-1/4"-7 7

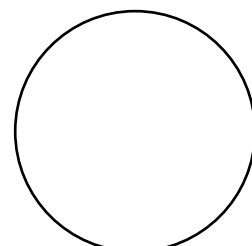
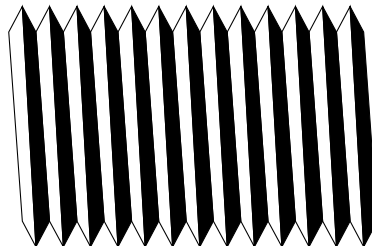

9/16-12

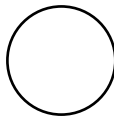
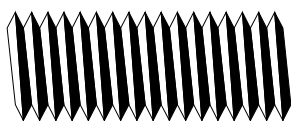

5/8-11

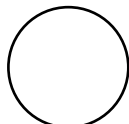
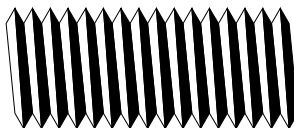

1-1/2"-6

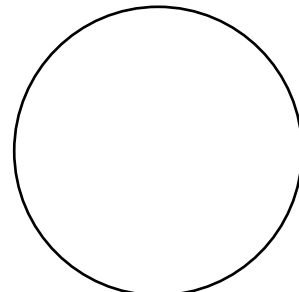
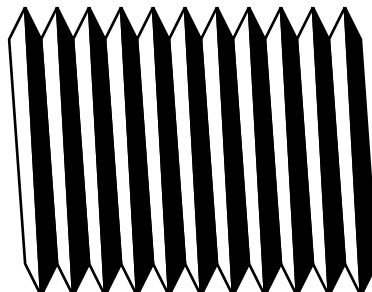



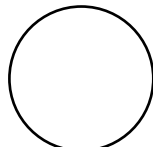
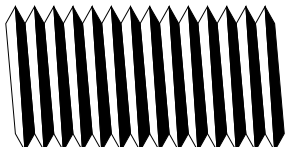





3/4-10

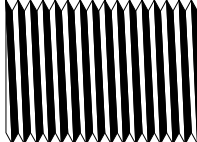
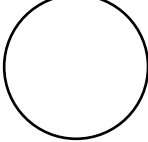

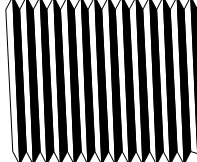
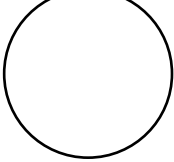
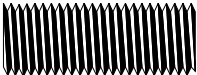

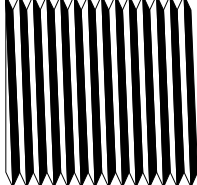
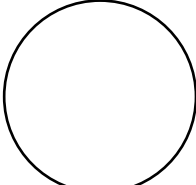
Thread Pitch Chart - National Fine

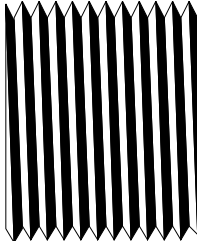
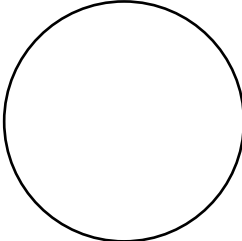
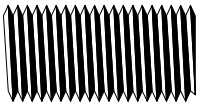
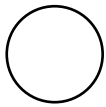
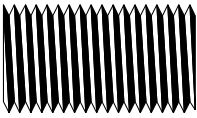
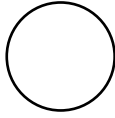
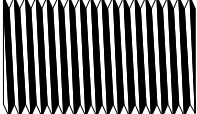
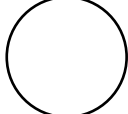
1/4-28			3/4-16		
5/16-24			7/8-14		
3/8-24			1"-14		
7/16-20			1-1/4"-12		
1/2-20					
9/16-18					
5/8-18					

C
A
P
S
C
R
E
W
S



IBS, INCORPORATED

Hi-Alloy Fastening System Gen'l Info

High-Alloy Fastening System

HIGH-ALLOY products are manufactured from special AISI alloy steels and undergo critically monitored heat treatments. This is done in order to provide the strongest off-the-shelf fastening system available. The HIGH-ALLOY fastening system is designed and engineered for use in high stress, severe service environments. The HIGH-ALLOY fastening system is designed for 180,000 to 200,000 psi ultimate tensile strength and having the minimum ductility of SAE J429 Grade 8 bolts for reduction in area and elongation. The High-Alloy fastening system is engineered and carefully manufactured to operate as a system consisting of a bolt, two washers (two styles available) and either a hex nut or a prevailing torque locknut. Each of these components contributes to the optimum performance and maximum reliability of the system.

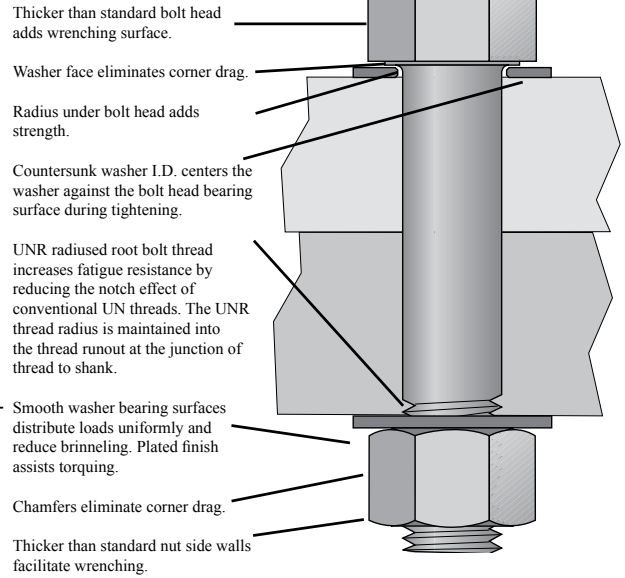

High-Alloy Fastening System Clamp Load

Assuming that the joint has been designed properly and the right fastener has been selected, bolts which are correctly tightened to required clamp loads rarely fail in service. Locknuts can preserve clamp loads by inhibiting loosening and nut backoff due to vibration. Clamp loads must exceed the maximum static or dynamic external loads that will be applied to the joint otherwise the fastener or joint may fail.

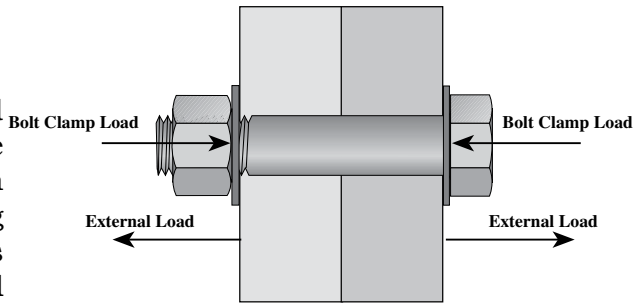

User Cautions:

Avoid fastener, and possible joint failure, by observing the following:

- 1) Do not substitute components in the High-Alloy fastening system. Non High-Alloy may not meet the system's requirements. IBS is not responsible for any failures in use of High-Alloy fastening system if substitutions are made of any component or finish of the system (i.e. bolt, nut, locknut or washer).
- 2) Do not alter the coatings as this can result in erratic and unpredictable clamp loads. Do not use supplementary lubricants.
- 3) Do not use the High-Alloy system in service environments exceeding 400°F. Any cadmium or zinc plated product is subject to degradation of corrosion resistance and possible liquid metal embrittlement at temperatures exceeding 400°F.
- 4) Discuss the use of High-Alloy bolts and washers in tapped holes with your IBS Rep. to establish correct tightening torques and methods. Excessive or insufficient clamp loads can cause major problems.
- 5) When tightening High-Alloy bolts, use the recommended torque values. The self lubricating features of the system reduce required torques so that in some instances they are below those needed to tighten Grade 8 bolts.

THE HIGH-ALLOY FASTENING SYSTEM IS DESIGNED AND MANUFACTURED TO BE USED AS A SYSTEM. NO SUBSTITUTIONS OR ALTERATIONS ARE TO BE MADE OF THE BOLT, NUT, WASHER OR FINISH.

C
A
P
S
C
R
E
W
S



High-Alloy Fastening System

Benefits

- 180,000 psi tensile strength is 20% greater than Grade 8.
- Can last 10 to 20 times as long as Grade 8 fasteners.
- Ductility equals or exceeds Grade 8.
- Greatly reduces down time.
- Reduces maintenance time and costs.
- Improved product performance.
- Lower mechanical failure costs.
- Bolts are zinc-plated and dichromate-coated to improve lubrication for controlled tightening and to inhibit corrosion. This reduces the torque needed to develop recommended high clamp loads and produces a 96-hour salt spray resistance to corrosion.

High-Alloy System Hardness Specifications		
Product	Diameter Range	Rockwell Hardness
Bolts	All	R/C 38-42
Nuts	1/4 thru 5/8	R/C 28-34
	3/4 thru 1-1/2	R/C 32-38
Washers	All	15N 82-85

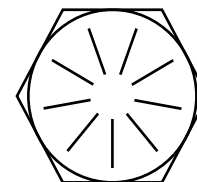

High-Alloy Bolt Head Marking

C
A
P
S
C
R
E
W
S

ALL HIGH-ALLOY BOLTS, NUTS AND WASHERS ARE TRACEABLE TO THEIR ORIGINAL PRODUCTION LOT. SAMPLES OF EACH LOT ARE KEPT ON FILE, WITH ALL DOCUMENTATION REGARDING BATCH DATE, QUALITY CONTROL INSPECTIONS AND TEST REPORTS.



IBS, INCORPORATED

Hi-Alloy Capscrews Nat'l Coarse A01

USS High-Alloy Capscrews NATIONAL COARSE — PLATED ZINC YELLOW



C
A
P
S
C
R
E
W
S

Length	1/4- 20 P/N	5/16- 18 P/N	3/8- 16 P/N	Qty	7/16- 14 P/N	1/2- 13 P/N	Qty	9/16- 12 P/N	5/8- 11 P/N	Qty	3/4- 10 P/N	Qty	7/8- 9 P/N	Pkg Qty	1-8 P/N	Pkg Qty	Length
1/2	101	116	—	100	—	—	—	—	—	—	—	—	—	—	—	—	1/2
3/4	102	117	136	100	—	172	50	—	—	—	—	—	—	—	—	—	3/4
1	103	118	137	100	155	173	50	—	215	25	—	20	—	—	—	—	1
1-1/4	104	119	138	100	156	174	50	—	216	25	—	20	—	—	—	—	1-1/4
1-1/2	105	120	139	100	157	175	50	197	217	25	245	20	—	15	299A	EA	1-1/2
1-3/4	106	121	140	100	158	176	50	—	218	25	246	20	—	15	—	EA	1-3/4
2	107	122	141	100	159	177	50	199	219	25	247	20	275	15	300	EA	2
2-1/4	108	123	142	50	160	178	25	200	220	25	248	10	276	10	—	EA	2-1/4
2-1/2	109	124	143	50	161	179	25	201	221	25	249	10	277	10	302	EA	2-1/2
2-3/4	110	125	144	50	162	180	25	202	222	25	250	10	—	10	302A	EA	2-3/4
3	111	126	145	25	163	181	25	203	223	25	251	10	279	10	303	EA	3
3-1/2	113	128	147	25	165	183	25	—	225	25	253	10	281	10	304	EA	3-1/2
4	115	130	149	25	167	185	25	207	227	25	255	10	283	10	305	EA	4
4-1/2	115A	131	150	15	168	186	10	208	228	10	256	5	284	5	306	EA	4-1/2
5	115D	132	151	15	—	187	10	209	229	10	257	5	285	5	307	EA	5
5-1/2	—	—	152	15	171	188	10	210	230	10	258	5	286	5	308	EA	5-1/2
6	—	134	153	15	171A	189	10	211	231	10	259	5	287	5	309	EA	6
6-1/2	—	—	—	—	—	189A	EA	—	232	EA	—	EA	—	EA	—	EA	6-1/2
7	—	—	—	—	—	190	EA	—	233	EA	261	EA	289	EA	311	EA	7
7-1/2	—	—	—	—	—	—	EA	—	234	EA	262	EA	—	EA	312	EA	7-1/2
8	—	—	—	—	—	191	EA	—	235	EA	263	EA	291	EA	313	EA	8
9	—	—	—	—	—	—	—	—	237	EA	265	EA	293	EA	315	EA	9
10	—	—	—	—	—	—	—	—	239	EA	267	EA	295	EA	317	EA	10

THE HIGH-ALLOY FASTENING SYSTEM IS DESIGNED AND MANUFACTURED TO BE USED AS A SYSTEM. NO SUBSTITUTIONS OR ALTERATIONS ARE TO BE MADE OF THE BOLT, NUT, WASHER OR FINISH.

IBS, INCORPORATED

Bin Assortments Z06



High Alloy Assortment

COARSE THREAD

PLATED ZINC YELLOW

IBS No. 890P

USS • 70 Items •

1,627 Pieces

USS Hi-Alloy Bolts, SAE

Hi-Alloy Flat Washers

USS Hi-Alloy Finished Nuts

USS Hi-Alloy Locknuts

- 180,000 psi tensile strength
- Can last 10 to 20 times longer than Grade 8.



890P • HI ALLOY ASSORTMENT • 72 Items

1/4-20 Hex Nut NT5202	5/16-18 Hex Nut NT5204	3/8-16 Hex Nut NT5206	7/16-14 Hex Nut NT5208	1/2-13 Hex Nut NT5212	9/16-12 Hex Nut NT5214	5/8-11 Hex Nut NT5216	3/4-10 Hex Nut NT5218
1/4 SAE FW 7400	5/16 SAE FW 7401	3/8 SAE FW 7402	7/16 SAE FW 7403	1/2 SAE FW 7404	9/16 SAE FW 7405	5/8 SAE FW 7406	3/4 SAE FW 7407
1/4-20 Lock Nut NT9403	5/16-18 Lock Nut NT9405	3/8-16 Lock Nut NT9407	7/16-14 Lock Nut NT9409	1/2-13 Lock Nut NT9413	9/16-12 Lock Nut NT9415	5/8-11 Lock Nut NT9417	3/4-10 Lock Nut NT9419
Open Stock	Open Stock	Open Stock	Open Stock	Open Stock	Open Stock	Open Stock	Open Stock
1/4 x 3/4 Capscrew 102	5/16 x 3/4 Capscrew 117	3/8 x 3/4 Capscrew 136	7/16 x 1 Capscrew 155	1/2 x 1 Capscrew 173		5/8 x 1-1/4 Capscrew 216	3/4 x 1-1/2 Capscrew 245
1/4 x 1 Capscrew 103	5/16 x 1 Capscrew 118	3/8 x 1 Capscrew 137	7/16 x 1-1/4 Capscrew 156	1/2 x 1-1/4 Capscrew 174	9/16 x 1-1/2 Capscrew 197	5/8 x 1-1/2 Capscrew 217	3/4 x 1-3/4 Capscrew 245
1/4 x 1-1/4 Capscrew 104	5/16 x 1-1/4 Capscrew 119	3/8 x 1-1/4 Capscrew 138	7/16 x 1-1/2 Capscrew 157	1/2 x 1-1/2 Capscrew 175		5/8 x 1-3/4 Capscrew 218	3/4 x 2 Capscrew 246
1/4 x 1-1/2 Capscrew 105	5/16 x 1-1/2 Capscrew 120	3/8 x 1-1/2 Capscrew 139	7/16 x 1-3/4 Capscrew 158	1/2 x 1-3/4 Capscrew 176	9/16 x 2 Capscrew 199	5/8 x 2 Capscrew 219	3/4 x 2-1/2 Capscrew 247
1/4 x 1-3/4 Capscrew 106	5/16 x 1-3/4 Capscrew 121	3/8 x 2 Capscrew 141	7/16 x 2 Capscrew 159	1/2 x 2 Capscrew 177	9/16 x 2-1/2 Capscrew 201	5/8 x 2-1/2 Capscrew 221	3/4 x 3 Capscrew 251
1/4 x 2 Capscrew 107	5/16 x 2 Capscrew 122	3/8 x 2-1/2 Capscrew 143	7/16 x 2-1/2 Capscrew 161	1/2 x 2-1/2 Capscrew 179	9/16 x 3 Capscrew 203	5/8 x 3 Capscrew 223	3/4 x 3-1/2 Capscrew 253

C
A
P
S
C
R
E
W
S

High Alloy Assortment

COARSE THREAD

PLATED ZINC YELLOW

IBS No. 891P

USS • 70 Items

1,627 Pieces

USS Hi-Alloy Bolts,

USS Hi-Alloy Flat Washers

USS Hi-Alloy Finished Nuts

USS Hi-Alloy Locknuts

- 180,000 psi tensile strength.
- Can last 10 to 20 times longer than Grade 8.



891P • HI ALLOY ASSORTMENT • 72 Items

1/4-20 Hex Nut NT5202	5/16-18 Hex Nut NT5204	3/8-16 Hex Nut NT5206	7/16-14 Hex Nut NT5208	1/2-13 Hex Nut NT5212	9/16-12 Hex Nut NT5214	5/8-11 Hex Nut NT5216	3/4-10 Hex Nut NT5218
1/4 USS FW 7016	5/16 USS FW 7017	3/8 USS FW 7018	7/16 USS FW 7019	1/2 USS FW 7020	9/16 USS FW 7021	5/8 USS FW 7022	3/4 USS FW 7023
1/4-20 Lock Nut NT9403	5/16-18 Lock Nut NT9405	3/8-16 Lock Nut NT9407	7/16-14 Lock Nut NT9409	1/2-13 Lock Nut NT9413	9/16-12 Lock Nut NT9415	5/8-11 Lock Nut NT9417	3/4-10 Lock Nut NT9419
Open Stock	Open Stock	Open Stock	Open Stock	Open Stock	Open Stock	Open Stock	Open Stock
1/4 x 3/4 Capscrew 102	5/16 x 3/4 Capscrew 117	3/8 x 3/4 Capscrew 136	7/16 x 1 Capscrew 155	1/2 x 1 Capscrew 173		5/8 x 1-1/4 Capscrew 216	3/4 x 1-1/2 Capscrew 245
1/4 x 1 Capscrew 103	5/16 x 1 Capscrew 118	3/8 x 1 Capscrew 137	7/16 x 1-1/4 Capscrew 156	1/2 x 1-1/4 Capscrew 174	9/16 x 1-1/2 Capscrew 197	5/8 x 1-1/2 Capscrew 217	3/4 x 1-3/4 Capscrew 246
1/4 x 1-1/4 Capscrew 104	5/16 x 1-1/4 Capscrew 119	3/8 x 1-1/4 Capscrew 138	7/16 x 1-1/2 Capscrew 157	1/2 x 1-1/2 Capscrew 175		5/8 x 1-3/4 Capscrew 218	3/4 x 2 Capscrew 247
1/4 x 1-1/2 Capscrew 105	5/16 x 1-1/2 Capscrew 120	3/8 x 1-1/2 Capscrew 139	7/16 x 1-3/4 Capscrew 158	1/2 x 1-3/4 Capscrew 176	9/16 x 2 Capscrew 199	5/8 x 2 Capscrew 219	3/4 x 2-1/2 Capscrew 249
1/4 x 1-3/4 Capscrew 106	5/16 x 1-3/4 Capscrew 121	3/8 x 2 Capscrew 141	7/16 x 2 Capscrew 159	1/2 x 2 Capscrew 177	9/16 x 2-1/2 Capscrew 201	5/8 x 2-1/2 Capscrew 221	3/4 x 3 Capscrew 251
1/4 x 2 Capscrew 107	5/16 x 2 Capscrew 122	3/8 x 2-1/2 Capscrew 143	7/16 x 2-1/2 Capscrew 161	1/2 x 2-1/2 Capscrew 179	9/16 x 3 Capscrew 203	5/8 x 3 Capscrew 223	3/4 x 3-1/2 Capscrew 253



IBS, INCORPORATED

Assortments Z08

High Alloy Assortment

COARSE THREAD

PLATED ZINC YELLOW

IBS No. 437P • 40 Items

965 Pieces

USS Hi-Alloy Bolts

SAE Hi-Alloy Flat Washers

USS Hi-Alloy Finished Nuts

USS Hi-Alloy Locknuts



- 180,000 psi tensile strength.
- Can last 10 to 20 times longer than Grade 8.

1/4-20 Hex Nut NT5202	1/4-20 Lock Nut NT9403	1/4 SAE FW 7400	1/4 x 3/4 Capscrew 102	1/4 x 1 Capscrew 103	1/4 x 1-1/4 Capscrew 104	1/4 x 1-1/2 Capscrew 105	1/4 x 2 Capscrew 107
5/16-18 Hex Nut NT5204	5/16-18 Lock Nut NT9405	5/16 SAE FW 7401	5/16 x 3/4 Capscrew 117	5/16 x 1 Capscrew 118	5/16 x 1-1/4 Capscrew 119	5/16 x 1-1/2 Capscrew 120	5/16 x 2 Capscrew 122
3/8-16 Hex Nut NT5206	3/8-16 Lock Nut NT9407	3/8 SAE FW 7402	3/8 x 1 Capscrew 137	3/8 x 1-1/4 Capscrew 138	3/8 x 1-1/2 Capscrew 139	3/8 x 2 Capscrew 141	3/8 x 2-1/2 Capscrew 143
7/16-14 Hex Nut NT5208	5/16-18 Lock Nut NT9409	7/16 SAE FW 7403	7/16 x 1 Capscrew 155	7/16 x 1-1/4 Capscrew 156	7/16 x 1-1/2 Capscrew 157	7/16 x 2 Capscrew 159	7/16 x 2-1/2 Capscrew 161
1/2-13 Hex Nut NT5212	1/2-13 Lock Nut NT9413	1/2 SAE FW 7404	1/2 x 1 Capscrew 173	1/2 x 1-1/4 Capscrew 174	1/2 x 1-1/2 Capscrew 175	1/2 x 2 Capscrew 177	1/2 x 2-1/2 Capscrew 179

High Alloy Assortment

COARSE THREAD

PLATED ZINC YELLOW

IBS No. 654P • 40 Items

965 Pieces

USS Hi-Alloy Bolts

USS Hi-Alloy Flat Washers

USS Hi-Alloy Finished Nuts

USS Hi-Alloy Locknuts



- 180,000 psi tensile strength.
- Can last 10 to 20 times longer than Grade 8.

1/4-20 Hex Nut NT5202	1/4-20 Lock Nut NT9403	1/4 USS FW 7016	1/4 x 3/4 Capscrew 102	1/4 x 1 Capscrew 103	1/4 x 1-1/4 Capscrew 104	1/4 x 1-1/2 Capscrew 105	1/4 x 2 Capscrew 107
5/16-18 Hex Nut NT5204	5/16-18 Lock Nut NT9405	5/16 USS FW 7017	5/16 x 3/4 Capscrew 117	5/16 x 1 Capscrew 118	5/16 x 1-1/4 Capscrew 119	5/16 x 1-1/2 Capscrew 120	5/16 x 2 Capscrew 122
3/8-16 Hex Nut NT5206	3/8-16 Lock Nut NT9407	3/8 USS FW 7018	3/8 x 1 Capscrew 137	3/8 x 1-1/4 Capscrew 138	3/8 x 1-1/2 Capscrew 139	3/8 x 2 Capscrew 141	3/8 x 2-1/2 Capscrew 143
7/16-14 Hex Nut NT5208	5/16-18 Lock Nut NT9409	7/16 USS FW 7019	7/16 x 1 Capscrew 155	7/16 x 1-1/4 Capscrew 156	7/16 x 1-1/2 Capscrew 157	7/16 x 2 Capscrew 159	7/16 x 2-1/2 Capscrew 161
1/2-13 Hex Nut NT5212	1/2-13 Lock Nut NT9413	1/2 USS FW 7020	1/2 x 1 Capscrew 173	1/2 x 1-1/4 Capscrew 174	1/2 x 1-1/2 Capscrew 175	1/2 x 2 Capscrew 177	1/2 x 2-1/2 Capscrew 179

C
A
P
S
C
R
E
W
S

IBS, INCORPORATED

Hi-Alloy Capscrews Nat'l Fine A02



SAE High-Alloy Capscrews

NATIONAL FINE — ZINC YELLOW



Length	1/4- 28 P/N	5/16- 24 P/N	3/8- 24 P/N	Qty	7/16- 20 P/N	1/2- 20 P/N	Qty	9/16- 18 P/N	5/8- 18 P/N	Qty	3/4- 16 P/N	Qty	7/8- 14 P/N	Qty	1 - 14 P/N	Qty	Length
1/2	325	345	364	100	—	—	—	—	—	—	—	—	—	—	—	—	1/2
3/4	326	346	365	100	—	404	50	—	—	—	—	—	—	—	—	—	3/4
1	327	347	366	100	386	405	50	—	450	25	—	—	—	—	—	—	1
1-1/4	328	348	367	100	387	406	50	431	451	25	—	—	—	—	—	—	1-1/4
1-1/2	329	349	368	100	388	407	50	432	452	25	477	20	—	—	—	—	1-1/2
1-3/4	330	350	369	100	389	408	50	433	453	25	478	20	—	—	—	—	1-3/4
2	331	351	370	100	390	409	50	434	454	25	479	20	500	15	—	EA	2
2-1/4	—	—	371	50	—	410	25	—	455	25	480	10	—	—	—	—	2-1/4
2-1/2	333	353	372	50	392	411	25	436	456	25	481	10	503	10	517	EA	2-1/2
2-3/4	—	—	—	—	—	—	—	—	457	25	—	10	—	—	—	—	2-3/4
3	335	355	374	25	395	413	25	438	458	25	483	10	504	10	518	EA	3
3-1/2	337	—	376	25	397	415	25	440	460	25	485	10	504A	10	519	EA	3-1/2
4	—	—	378	25	399	417	25	442	462	25	487	10	505	10	520	EA	4
4-1/2	—	—	—	15	—	418	10	—	463	10	488	5	506	5	521	EA	4-1/2
5	—	—	—	15	—	419	10	—	464	10	489	5	507	5	522	EA	5
5-1/2	—	—	—	15	—	—	10	—	465	10	490	5	508	5	523	EA	5-1/2
6	—	—	—	15	—	421	10	—	466	10	491	5	509	5	524	EA	6
6-1/2	—	—	—	—	—	—	EA	—	—	—	—	EA	—	—	—	—	6-1/2
7	—	—	—	—	—	—	—	—	468	—	493	EA	—	—	—	—	7
7-1/2	—	—	—	—	—	—	—	—	—	—	—	EA	—	—	—	—	7-1/2
8	—	—	—	—	—	—	—	—	470	—	495	EA	—	—	—	—	8
8-1/2	—	—	—	—	—	—	—	—	—	—	—	EA	—	—	—	—	8-1/2
9	—	—	—	—	—	—	—	—	472	—	496	EA	—	—	—	—	9
10	—	—	—	—	—	—	—	—	—	—	499	EA	—	—	—	—	10

THE HIGH-ALLOY FASTENING SYSTEM IS DESIGNED AND MANUFACTURED TO BE USED AS A SYSTEM. NO SUBSTITUTIONS OR ALTERATIONS ARE TO BE MADE OF THE BOLT, NUT, WASHER OR FINISH.

**C
A
P
S
C
R
E
W
S**



IBS, INCORPORATED

Bin Assortments Z06

High Alloy Assortment

FINE THREAD

PLATED ZINC YELLOW

IBS No. 892P • 72 Items
1,637 Pieces

SAE Hi-Alloy Bolts
SAE Hi-Alloy Flat Washers
SAE Hi-Alloy Finished Nuts
SAE Hi-Alloy Locknuts

- 180,000 psi tensile strength.
- Zinc-plated and dichromate coated.



1/4-28 Hex Nut NT5252	5/16-24 Hex Nut NT5254	3/8-24 Hex Nut NT5256	7/16-20 Hex Nut NT5258	1/2-20 Hex Nut NT5262	9/16-18 Hex Nut NT5264	5/8-18 Hex Nut NT5266	3/4-16 Hex Nut NT5268
1/4 SAE FW 7400	5/16 SAE FW 7401	3/8 SAE FW 7402	7/16 SAE FW 7403	1/2 SAE FW 7404	9/16 SAE FW 7405	5/8 SAE FW 7406	3/4 SAE FW 7407
1/4-28 Lock Nut NT9453	5/16-24 Lock Nut NT9455	3/8-24 Lock Nut NT9457	7/16-20 Lock Nut NT9459	1/2-20 Lock Nut NT9463	9/16-18 Lock Nut NT9465	5/8-18 Lock Nut NT9467	3/4-16 Lock Nut NT9469
Open Stock	Open Stock	Open Stock	Open Stock	Open Stock	Open Stock	Open Stock	Open Stock
1/4 x 3/4 Capscrew 326	5/16 x 3/4 Capscrew 346	3/8 x 3/4 Capscrew 365	7/16 x 1 Capscrew 386	1/2 x 1 Capscrew 405	9/16 x 1-1/4 Capscrew 431	5/8 x 1-1/4 Capscrew 451	3/4 x 1-1/2 Capscrew 477
1/4 x 1 Capscrew 327	5/16 x 1 Capscrew 347	3/8 x 1 Capscrew 366	7/16 x 1-1/4 Capscrew 387	1/2 x 1-1/4 Capscrew 406	9/16 x 1-1/2 Capscrew 432	5/8 x 1-1/2 Capscrew 452	3/4 x 1-3/4 Capscrew 478
1/4 x 1-1/4 Capscrew 328	5/16 x 1-1/4 Capscrew 348	3/8 x 1-1/4 Capscrew 367	7/16 x 1-1/2 Capscrew 388	1/2 x 1-1/2 Capscrew 407	9/16 x 1-3/4 Capscrew 433	5/8 x 1-3/4 Capscrew 453	3/4 x 2 Capscrew 479
1/4 x 1-1/2 Capscrew 329	5/16 x 1-1/2 Capscrew 349	3/8 x 1-1/2 Capscrew 368	7/16 x 1-3/4 Capscrew 389	1/2 x 1-3/4 Capscrew 408	9/16 x 2 Capscrew 434	5/8 x 2 Capscrew 454	3/4 x 2-1/2 Capscrew 481
1/4 x 1-3/4 Capscrew 330	5/16 x 1-3/4 Capscrew 350	3/8 x 2 Capscrew 370	7/16 x 2 Capscrew 390	1/2 x 2 Capscrew 409	9/16 x 2-1/2 Capscrew 436	5/8 x 2-1/2 Capscrew 456	3/4 x 3 Capscrew 483
1/4 x 2 Capscrew 331	5/16 x 2 Capscrew 351	3/8 x 2-1/2 Capscrew 372	7/16 x 2-1/2 Capscrew 392	1/2 x 2-1/2 Capscrew 411	9/16 x 3 Capscrew 438	5/8 x 3 Capscrew 458	3/4 x 3-1/2 Capscrew 485

C
A
P
S
C
R
E
W
S

High Alloy Assortment

FINE THREAD

PLATED ZINC YELLOW

IBS No. 893P • 72 Items
1,637 Pieces

SAE Hi-Alloy Bolts
USS Hi-Alloy Flat Washers
SAE Hi-Alloy Finished
Nuts
SAE Hi-Alloy Locknuts

- 180,000 psi tensile strength.
- Zinc-plated and dichromate coated.



1/4-28 Hex Nut NT5252	5/16-24 Hex Nut NT5254	3/8-24 Hex Nut NT5256	7/16-20 Hex Nut NT5258	1/2-20 Hex Nut NT5262	9/16-18 Hex Nut NT5264	5/8-18 Hex Nut NT5266	3/4-16 Hex Nut NT5268
1/4 USS FW 7016	5/16 USS FW 7017	3/8 USS FW 7018	7/16 USS FW 7019	1/2 USS FW 7020	9/16 USS FW 7021	5/8 USS FW 7022	3/4 USS FW 7023
1/4-28 Lock Nut NT9453	5/16-24 Lock Nut NT9455	3/8-24 Lock Nut NT9457	7/16-20 Lock Nut NT9459	1/2-20 Lock Nut NT9463	9/16-18 Lock Nut NT9465	5/8-18 Lock Nut NT9467	3/4-16 Lock Nut NT9469
Open Stock	Open Stock	Open Stock	Open Stock	Open Stock	Open Stock	Open Stock	Open Stock
1/4 x 3/4 Capscrew 326	5/16 x 3/4 Capscrew 346	3/8 x 3/4 Capscrew 365	7/16 x 1 Capscrew 386	1/2 x 1 Capscrew 405	9/16 x 1-1/4 Capscrew 431	5/8 x 1-1/4 Capscrew 451	3/4 x 1-1/2 Capscrew 477
1/4 x 1 Capscrew 327	5/16 x 1 Capscrew 347	3/8 x 1 Capscrew 366	7/16 x 1-1/4 Capscrew 387	1/2 x 1-1/4 Capscrew 406	9/16 x 1-1/2 Capscrew 432	5/8 x 1-1/2 Capscrew 452	3/4 x 1-3/4 Capscrew 478
1/4 x 1-1/4 Capscrew 328	5/16 x 1-1/4 Capscrew 348	3/8 x 1-1/4 Capscrew 367	7/16 x 1-1/2 Capscrew 388	1/2 x 1-1/2 Capscrew 407	9/16 x 1-3/4 Capscrew 433	5/8 x 1-3/4 Capscrew 453	3/4 x 2 Capscrew 479
1/4 x 1-1/2 Capscrew 329	5/16 x 1-1/2 Capscrew 349	3/8 x 1-1/2 Capscrew 368	7/16 x 1-3/4 Capscrew 389	1/2 x 1-3/4 Capscrew 408	9/16 x 2 Capscrew 434	5/8 x 2 Capscrew 454	3/4 x 2-1/2 Capscrew 481
1/4 x 1-3/4 Capscrew 330	5/16 x 1-3/4 Capscrew 350	3/8 x 2 Capscrew 370	7/16 x 2 Capscrew 390	1/2 x 2 Capscrew 409	9/16 x 2-1/2 Capscrew 436	5/8 x 2-1/2 Capscrew 456	3/4 x 3 Capscrew 483
1/4 x 2 Capscrew 331	5/16 x 2 Capscrew 351	3/8 x 2-1/2 Capscrew 372	7/16 x 2-1/2 Capscrew 392	1/2 x 2-1/2 Capscrew 411	9/16 x 3 Capscrew 438	5/8 x 3 Capscrew 458	3/4 x 3-1/2 Capscrew 485

IBS, INCORPORATED

Grade 8 General Information



Grade 8 Heat Treated Hex Capscrews

- All Grade 8 Capscrews Are Domestically Made.
- 150,000 PSI Minimum Tensile Strength.



**Grade 8 Bolt
Head Marking**

- E
L
I
M
I
N
A
T
E**
- STRETCHED BOLTS
 - STRIPPED THREADS
 - BENT OR BROKEN BOLTS
 - CRACKED OR DISHED WASHERS
 - UNMATCHED COMPONENTS
 - VIBRATION, HEAT, OR STRESS FATIGUE

**Rolled Threads
Smooth Burr Free,
For Easier Assembly
and Longer Life.**

**Chamfered
End For
Easy Thread
Engagement.**

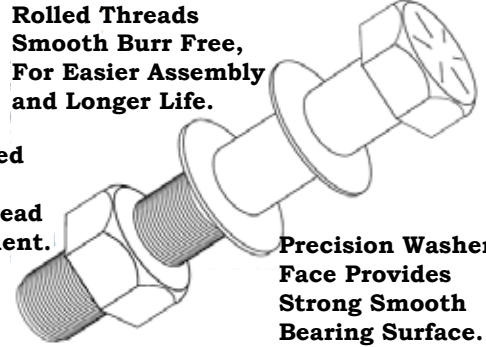

**Precision Washer
Face Provides
Strong Smooth
Bearing Surface.**

**C
A
P
S
C
R
E
W
S**



IBS, INCORPORATED

Grade 8 Capscrews Nat'l Coarse A05

**USS
Grade 8
Capscrews
NATIONAL
COARSE —
PLAIN**



**C
A
P
S
C
R
E
W
S**

Length	1/4- 20 P/N	5/16- 18 P/N	Qty	3/8- 16 P/N	Qty	7/16- 14 P/N	Qty	1/2- 13 P/N	Qty	9/16- 12 P/N	5/8- 11 P/N	Qty	3/4- 10 P/N	Qty	Length
1/2	1301	1325	100	1350	100	—	—	—	—	—	—	—	—	—	1/2
3/4	1303	1327	100	1352	100	—	—	1397	50	—	—	—	—	—	3/4
1	1304	1329	100	1354	100	1376	50	1398	50	1423	1440	25	1465	20	1
1-1/4	1305	1330	100	1355	100	1377	50	1399	50	1424	1441	25	1466	20	1-1/4
1-1/2	1306	1331	100	1356	100	1378	50	1400	50	1425	1442	25	1467	20	1-1/2
1-3/4	1307	1332	100	1357	100	1379	50	1401	50	1426	1443	25	1468	20	1-3/4
2	1308	1333	100	1358	100	1380	50	1402	50	1427	1444	25	1469	20	2
2-1/4	1309	1334	50	1359	50	1381	25	1403	25	1428	1445	25	1470	20	2-1/4
2-1/2	1310	1335	50	1360	50	1382	25	1404	25	1429	1446	25	1471	20	2-1/2
2-3/4	1311	1336	50	1361	50	1383	25	1405	25	1430	1447	25	1472	20	2-3/4
3	1312	1337	50	1362	50	1384	25	1406	25	1431	1448	25	1473	20	3
3-1/2	1314	1339	50	1364	25	1386	25	1408	25	1433	1450	25	1475	20	3-1/2
4	1316	1341	50	1366	25	1388	25	1410	25	1435	1452	25	1477	20	4
4-1/2	1317	1342	25	1367	25	1389	15	1411	15	1436	1453	15	1478	10	4-1/2
5	1318	1343	25	1368	25	1390	15	1412	15	1437	1454	15	1479	10	5
5-1/2	1319	1344	25	1369	25	—	—	1413	15	1438	1455	15	1480	10	5-1/2
6	1320	1345	25	1370	25	1392	15	1414	15	1439	1456	15	1481	10	6
6-1/2	—	—	—	1371	EA	—	—	1415	EA	—	—	—	1482	EA	6-1/2
7	—	—	—	1372	EA	—	—	1416	EA	—	1458	EA	1483	EA	7
8	1324	—	EA	1374	EA	—	—	1418	EA	—	1460	EA	1485	EA	8
9	—	—	—	—	—	—	—	—	—	—	1462	EA	1487	EA	9
10	—	—	—	—	—	—	—	—	—	—	1464	EA	1489	EA	10

Length	7/8-9 P/N	Qty	1-8 P/N	Qty	1-1/8- 7 P/N	1-1/4- 7 P/N	1-1/2- 6 P/N	Qty	Length
1-1/2	1489A	15	1510A	10	—	—	—	—	1-1/2
1-3/4	1489B	15	—	—	—	—	—	—	1-3/4
2	1490	15	1511	10	—	—	—	—	2
2-1/4	1491	15	1512	10	—	—	—	—	2-1/4
2-1/2	1492	15	1513	10	1532	1548	—	EA	2-1/2
2-3/4	1493	15	1514	10	—	—	—	—	2-3/4
3	1494	10	1515	10	1533	1549	1579	EA	3
3-1/2	1496	10	1517	10	1534	1550	1580	EA	3-1/2
4	1498	10	1519	10	1535	1551	1581	EA	4
4-1/2	1499	5	1520	5	1536	1552	1582	EA	4-1/2
5	1500	5	1521	5	1537	1553	1583	EA	5
5-1/2	1501	5	1522	5	1538	1554	1584	EA	5-1/2
6	1502	5	1523	5	1539	1555	1585	EA	6
6-1/2	—	—	1524	EA	—	1556	—	EA	6-1/2
7	1504	EA	1525	EA	1541	1557	—	EA	7
8	1506	EA	1527	EA	1543	1559	—	EA	8
9	1508	EA	1529	EA	1545	1561	—	EA	9
10	1510	EA	1531	EA	1547	1563	—	EA	10

All Grade 8 Bolts are traceable to their original production lot. Samples of each lot are kept on file, with all documentation regarding batch date, quality control inspections and test reports.

IBS, INCORPORATED

Bin Assortments Z06



884P • GRADE 8 ASSORTMENT • 72 Items

Grade 8 Assortment
COARSE THREAD - PLAIN
IBS No. 884P • 72 Items
3000 Pieces
USS Grade 8 Bolts
SAE HT Flat Washers
USS Grade 8 Finished Nuts
Alloy Lockwashers ZY

- 150,000 psi tensile strength.
- Heat treated.
- Domestically made.
- Plain Finish



1/4-20 Hex Nut 4010	5/16-18 Hex Nut 4011	3/8-16 Hex Nut 4012	7/16-14 Hex Nut 4013	1/2-13 Hex Nut 4014	9/16-12 Hex Nut 4015	5/8-11 Hex Nut 4016	3/4-10 Hex Nut 4017
1/4 SAE FW 7000	5/16 SAE FW 7001	3/8 SAE FW 7002	7/16 SAE FW 7003	1/2 SAE FW 7004	9/16 SAE FW 7005	5/8 SAE FW 7006	3/4 SAE FW 7007
1/4 Alloy LW 7086	5/16 Alloy LW 7087	3/8 Alloy LW 7088	7/16 Alloy LW 7089	1/2 Alloy LW 7090	9/16 Alloy LW 7091	5/8 Alloy LW 7092	3/4 Alloy LW 7093
Open Stock	Open Stock	Open Stock	Open Stock	Open Stock	Open Stock	Open Stock	Open Stock
1/4 x 3/4 Capscrew 1303	5/16 x 3/4 Capscrew 1327	3/8 x 3/4 Capscrew 1352	7/16 x 1 Capscrew 1376	1/2 x 1 Capscrew 1398	9/16 x 1-1/4 Capscrew 1424	5/8 x 1-1/4 Capscrew 1441	3/4 x 1-1/2 Capscrew 1467
1/4 x 1 Capscrew 1304	5/16 x 1 Capscrew 1329	3/8 x 1 Capscrew 1354	7/16 x 1-1/4 Capscrew 1377	1/2 x 1-1/4 Capscrew 1399	9/16 x 1-1/2 Capscrew 1425	5/8 x 1-1/2 Capscrew 1442	3/4 x 1-3/4 Capscrew 1468
1/4 x 1-1/4 Capscrew 1305	5/16 x 1-1/4 Capscrew 1330	3/8 x 1-1/4 Capscrew 1355	7/16 x 1-1/2 Capscrew 1378	1/2 x 1-1/2 Capscrew 1400	9/16 x 1-3/4 Capscrew 1426	5/8 x 1-3/4 Capscrew 1443	3/4 x 2 Capscrew 1469
1/4 x 1-1/2 Capscrew 1306	5/16 x 1-1/2 Capscrew 1331	3/8 x 1-1/2 Capscrew 1356	7/16 x 1-3/4 Capscrew 1379	1/2 x 1-3/4 Capscrew 1401	9/16 x 2 Capscrew 1427	5/8 x 2 Capscrew 1444	3/4 x 2-1/2 Capscrew 1471
1/4 x 1-3/4 Capscrew 1307	5/16 x 1-3/4 Capscrew 1332	3/8 x 2 Capscrew 1358	7/16 x 2 Capscrew 1380	1/2 x 2 Capscrew 1402	9/16 x 2-1/2 Capscrew 1429	5/8 x 2-1/2 Capscrew 1446	3/4 x 3 Capscrew 1473
1/4 x 2 Capscrew 1308	5/16 x 2 Capscrew 1333	3/8 x 2-1/2 Capscrew 1360	7/16 x 2-1/2 Capscrew 1382	1/2 x 2-1/2 Capscrew 1404	9/16 x 3 Capscrew 1431	5/8 x 3 Capscrew 1448	3/4 x 3-1/2 Capscrew 1475

C
A
P
S
C
R
E
W
S



IBS, INCORPORATED

Bin Assortments Z06

885P • GRADE 8 ASSORTMENT • 72 Items

Grade 8 Assortment

COARSE THREAD • PLAIN
IBS No. 885P • 72 Items
3000 Pieces

USS Grade 8 Bolts
USS HT Flat Washers
USS Grade 8 Finished Nuts
Alloy Lockwasher ZY

- 150,000 psi tensile strength
- Heat treated.
- Domestically made
- Plain Finish



1/4-20 Hex Nut 4010	5/16-18 Hex Nut 4011	3/8-16 Hex Nut 4012	7/16-14 Hex Nut 4013	1/2-13 Hex Nut 4014	9/16-12 Hex Nut 4015	5/8-11 Hex Nut 4016	3/4-10 Hex Nut 4017
1/4 USS FW 7030	5/16 USS FW 7031	3/8 USS FW 7032	7/16 USS FW 7033	1/2 USS FW 7034	9/16 USS FW 7035	5/8 USS FW 7036	3/4 USS FW 7037
1/4 Alloy LW 7086	5/16 Alloy LW 7087	3/8 Alloy LW 7088	7/16 Alloy LW 7089	1/2 Alloy LW 7090	9/16 Alloy LW 7091	5/8 Alloy LW 7092	3/4 Alloy LW 7093
Open Stock	Open Stock	Open Stock	Open Stock	Open Stock	Open Stock	Open Stock	Open Stock
1/4 x 3/4 Capscrew 1303	5/16 x 3/4 Capscrew 1327	3/8 x 3/4 Capscrew 1352	7/16 x 1 Capscrew 1376	1/2 x 1 Capscrew 1398	9/16 x 1-1/4 Capscrew 1424	5/8 x 1-1/4 Capscrew 1441	3/4 x 1-1/2 Capscrew 1467
1/4 x 1 Capscrew 1304	5/16 x 1 Capscrew 1329	3/8 x 1 Capscrew 1354	7/16 x 1-1/4 Capscrew 1377	1/2 x 1-1/4 Capscrew 1399	9/16 x 1-1/2 Capscrew 1425	5/8 x 1-1/2 Capscrew 1442	3/4 x 1-3/4 Capscrew 1468
1/4 x 1-1/4 Capscrew 1305	5/16 x 1-1/4 Capscrew 1330	3/8 x 1-1/4 Capscrew 1355	7/16 x 1-1/2 Capscrew 1378	1/2 x 1-1/2 Capscrew 1400	9/16 x 1-3/4 Capscrew 1426	5/8 x 1-3/4 Capscrew 1443	3/4 x 2 Capscrew 1469
1/4 x 1-1/2 Capscrew 1306	5/16 x 1-1/2 Capscrew 1331	3/8 x 1-1/2 Capscrew 1356	7/16 x 1-3/4 Capscrew 1379	1/2 x 1-3/4 Capscrew 1401	9/16 x 2 Capscrew 1427	5/8 x 2 Capscrew 1444	3/4 x 2-1/2 Capscrew 1471
1/4 x 1-3/4 Capscrew 1307	5/16 x 1-3/4 Capscrew 1332	3/8 x 2 Capscrew 1358	7/16 x 2 Capscrew 1380	1/2 x 2 Capscrew 1402	9/16 x 2-1/2 Capscrew 1429	5/8 x 2-1/2 Capscrew 1446	3/4 x 3 Capscrew 1473
1/4 x 2 Capscrew 1308	5/16 x 2 Capscrew 1333	3/8 x 2-1/2 Capscrew 1360	7/16 x 2-1/2 Capscrew 1382	1/2 x 2-1/2 Capscrew 1404	9/16 x 3 Capscrew 1431	5/8 x 3 Capscrew 1448	3/4 x 3-1/2 Capscrew 1475

Grade 8 Assortment

COARSE THREAD • PLAIN
IBS No. 435P • 40 Items - 2085 Pieces

USS Grade 8 Bolts
SAE HT Flat Washers
USS Grade 8 Finished Nuts
Alloy Lockwashers ZY

- 150,000 psi tensile strength.
- Domestically made.
- Heat treated.
- Plain Finish



1/4-20 Hex Nut 4010	1/4 Alloy LW 7086	1/4 SAE FW 7000	1/4 x 3/4 Capscrew 1303	1/4 x 1 Capscrew 1304	1/4 x 1-1/4 Capscrew 1305	1/4 x 1-1/2 Capscrew 1306	1/4 x 2 Capscrew 1308
5/16-18 Hex Nut 4011	5/16 Alloy LW 7087	5/16 SAE FW 7001	5/16 x 3/4 Capscrew 1327	5/16 x 1 Capscrew 1329	5/16 x 1-1/4 Capscrew 1330	5/16 x 1-1/2 Capscrew 1331	5/16 x 2 Capscrew 1333
3/8-16 Hex Nut 4012	3/8 Alloy LW 7088	3/8 SAE FW 7002	3/8 x 1 Capscrew 1354	3/8 x 1-1/4 Capscrew 1355	3/8 x 1-1/2 Capscrew 1356	3/8 x 2 Capscrew 1358	3/8 x 2-1/2 Capscrew 1360
7/16-14 Hex Nut 4013	5/16 Alloy LW 7089	7/16 SAE FW 7003	7/16 x 1 Capscrew 1376	7/16 x 1-1/4 Capscrew 1377	7/16 x 1-1/2 Capscrew 1378	7/16 x 2 Capscrew 1380	7/16 x 2-1/2 Capscrew 1382
1/2-13 Hex Nut 4014	1/2 Alloy LW 7090	1/2 SAE FW 7004	1/2 x 1 Capscrew 1398	1/2 x 1-1/4 Capscrew 1399	1/2 x 1-1/2 Capscrew 1400	1/2 x 2 Capscrew 1402	1/2 x 2-1/2 Capscrew 1404

Grade 8 Assortment

COARSE THREAD • PLAIN
IBS No. 653P • 40 Items - 2085 Pieces

USS Grade 8 Bolts
USS HT Flat Washers
USS Grade 8 Finished Nuts
Alloy Lock Washers ZY

- 150,000 psi tensile strength.
- Domestically made.
- Heat treated.
- Plain Finish



1/4-20 Hex Nut 4010	1/4 Alloy LW 7086	1/4 USS FW 7030	1/4 x 3/4 Capscrew 1303	1/4 x 1 Capscrew 1304	1/4 x 1-1/4 Capscrew 1305	1/4 x 1-1/2 Capscrew 1306	1/4 x 2 Capscrew 1308
5/16-18 Hex Nut 4011	5/16 Alloy LW 7087	5/16 USS FW 7031	5/16 x 3/4 Capscrew 1327	5/16 x 1 Capscrew 1329	5/16 x 1-1/4 Capscrew 1330	5/16 x 1-1/2 Capscrew 1331	5/16 x 2 Capscrew 1333
3/8-16 Hex Nut 4012	3/8 Alloy LW 7088	3/8 USS FW 7032	3/8 x 1 Capscrew 1354	3/8 x 1-1/4 Capscrew 1355	3/8 x 1-1/2 Capscrew 1356	3/8 x 2 Capscrew 1358	3/8 x 2-1/2 Capscrew 1360
7/16-14 Hex Nut 4013	5/16 Alloy LW 7089	7/16 USS FW 7033	7/16 x 1 Capscrew 1376	7/16 x 1-1/4 Capscrew 1377	7/16 x 1-1/2 Capscrew 1378	7/16 x 2 Capscrew 1380	7/16 x 2-1/2 Capscrew 1382
1/2-13 Hex Nut 4014	1/2 Alloy LW 7090	1/2 USS FW 7034	1/2 x 1 Capscrew 1398	1/2 x 1-1/4 Capscrew 1399	1/2 x 1-1/2 Capscrew 1400	1/2 x 2 Capscrew 1402	1/2 x 2-1/2 Capscrew 1404

C
A
P
S
C
R
E
W
S

IBS, INCORPORATED

Grade 8 C/S - Plated Nat'l Coarse A11



USS Grade 8 Capscrews NATIONAL COARSE — ZINC YELLOW



Length	1/4- 20 P/N	5/16- 18 P/N	Qty	3/8- 16 P/N	Qty	7/16- 14 P/N	1/2- 13 P/N	Qty	9/16- 12 P/N	5/8- 11 P/N	Qty	3/4- 10 P/N	Qty	7/8-9 P/N	Qty	1-8 P/N	Qty	Length
1/2	2401	2425	100	2450	100	—	—	—	—	—	—	—	—	—	—	—	—	1/2
3/4	2403	2427	100	2452	100	—	2497	50	—	—	—	—	—	—	—	—	—	3/4
1	2404	2429	100	2454	100	2476	2498	50	2523	2540	25	2565	20	—	—	—	—	1
1-1/4	2405	2430	100	2455	100	2477	2499	50	2524	2541	25	2566	20	—	—	—	—	1-1/4
1-1/2	2406	2431	100	2456	100	2478	2500	50	2525	2542	25	2567	20	2589A	15	2610A	10	1-1/2
1-3/4	2407	2432	100	2457	100	2479	2501	50	2526	2543	25	2568	20	2589B	15	—	—	1-3/4
2	2408	2433	100	2458	100	2480	2502	50	2527	2544	25	2569	20	2590	15	2611	10	2
2-1/4	2409	2434	50	2459	50	2481	2503	25	2528	2545	25	2570	20	2591	15	2612	10	2-1/4
2-1/2	2410	2435	50	2460	50	2482	2504	25	2529	2546	25	2571	20	2592	15	2613	10	2-1/2
2-3/4	2411	2436	50	2461	50	2483	2505	25	2530	2547	25	2572	20	2593	15	2614	10	2-3/4
3	2412	2437	50	2462	50	2484	2506	25	2531	2548	25	2573	20	2594	10	2615	10	3
3-1/2	2414	2439	50	2464	25	2486	2508	25	2533	2550	25	2575	20	2596	10	2617	10	3-1/2
4	2416	2441	50	2466	25	2488	2510	25	2535	2552	25	2577	20	2598	10	2619	10	4
4-1/2	2417	2442	25	2467	25	2489	2511	15	2536	2553	15	2578	10	2599	5	2620	5	4-1/2
5	2418	2443	25	2468	25	2490	2512	15	2537	2554	15	2579	10	2600	5	2621	5	5
5-1/2	2419	2444	25	2469	25	2491	2513	15	2538	2555	15	2580	10	2601	5	2622	5	5-1/2
6	2420	2445	25	2470	25	2492	2514	15	2539	2556	15	2581	10	2602	5	2623	5	6
7	—	—	—	—	—	—	2516	10	—	2558	5	2583	5	2604	1	2625	1	7
8	—	—	—	—	—	—	2518	10	—	2560	5	2585	5	2606	1	2627	1	8
9	—	—	—	—	—	—	—	—	—	2562	5	2587	1	2608	1	2629	1	9
10	—	—	—	—	—	—	—	—	—	2564	1	2589	1	2610	1	2631	1	10

ALL GRADE 8 BOLTS ARE TRACEABLE TO THEIR ORIGINAL PRODUCTION LOT. SAMPLES OF EACH LOT ARE KEPT ON FILE, WITH ALL DOCUMENTATION REGARDING BATCH DATE, QUALITY CONTROL INSPECTIONS AND TEST REPORTS.

**C
A
P
S
C
R
E
W
S**



IBS, INCORPORATED

Bin Assortments Z06

Grade 8 Assortment

**COARSE THREAD • PLATED
ZINC YELLOW**

**IBS No. 880P • 72 Items
3000 Pieces**

**USS Grade 8 Bolts, SAE
HT Flat Washers
USS Grade 8 Finished Nuts
Alloy Lock Washers**

- 150,000 psi tensile strength.
- Domestically made.
- Heat treated.
- Zinc Yellow Finish



880P • GRADE 8 ASSORTMENT • 72 Items

1/4-20 Hex Nut 4610	5/16-18 Hex Nut 4611	3/8-16 Hex Nut 4612	7/16-14 Hex Nut 4613	1/2-13 Hex Nut 4614	9/16-12 Hex Nut 4615	5/8-11 Hex Nut 4616	3/4-10 Hex Nut 4617
1/4 SAE FW 2660	5/16 SAE FW 2661	3/8 SAE FW 2662	7/16 SAE FW 2663	1/2 SAE FW 2664	9/16 SAE FW 2665	5/8 SAE FW 2666	3/4 SAE FW 2667
1/4 Alloy LW 7086	5/16 Alloy LW 7087	3/8 Alloy LW 7088	7/16 Alloy LW 7089	1/2 Alloy LW 7090	9/16 Alloy LW 7091	5/8 Alloy LW 7092	3/4 Alloy LW 7093
Open Stock	Open Stock	Open Stock	Open Stock	Open Stock	Open Stock	Open Stock	Open Stock
1/4 x 3/4 Capscrew 2403	5/16 x 3/4 Capscrew 2427	3/8 x 3/4 Capscrew 2452	7/16 x 1 Capscrew 2476	1/2 x 1 Capscrew 2498	9/16 x 1-1/4 Capscrew 2524	5/8 x 1-1/4 Capscrew 2541	3/4 x 1-1/2 Capscrew 2567
1/4 x 1 Capscrew 2404	5/16 x 1 Capscrew 2429	3/8 x 1 Capscrew 2454	7/16 x 1-1/4 Capscrew 2477	1/2 x 1-1/4 Capscrew 2499	9/16 x 1-1/2 Capscrew 2525	5/8 x 1-1/2 Capscrew 2542	3/4 x 1-3/4 Capscrew 2568
1/4 x 1-1/4 Capscrew 2405	5/16 x 1-1/4 Capscrew 2430	3/8 x 1-1/4 Capscrew 2455	7/16 x 1-1/2 Capscrew 2478	1/2 x 1-1/2 Capscrew 2500	9/16 x 1-3/4 Capscrew 2526	5/8 x 1-3/4 Capscrew 2543	3/4 x 2 Capscrew 2569
1/4 x 1-1/2 Capscrew 2406	5/16 x 1-1/2 Capscrew 2431	3/8 x 1-1/2 Capscrew 2456	7/16 x 1-3/4 Capscrew 2479	1/2 x 1-3/4 Capscrew 2501	9/16 x 2 Capscrew 2527	5/8 x 2 Capscrew 2544	3/4 x 2-1/2 Capscrew 2571
1/4 x 1-3/4 Capscrew 2407	5/16 x 1-3/4 Capscrew 2432	3/8 x 2 Capscrew 2458	7/16 x 2 Capscrew 2480	1/2 x 2 Capscrew 2502	9/16 x 2-1/2 Capscrew 2529	5/8 x 2-1/2 Capscrew 2546	3/4 x 3 Capscrew 2573
1/4 x 2 Capscrew 2408	5/16 x 2 Capscrew 2433	3/8 x 2-1/2 Capscrew 2460	7/16 x 2-1/2 Capscrew 2482	1/2 x 2-1/2 Capscrew 2504	9/16 x 3 Capscrew 2531	5/8 x 3 Capscrew 2548	3/4 x 3-1/2 Capscrew 2575

C
A
P
S
C
R
E
W
S

Grade 8 Assortment

**COARSE THREAD • PLATED
ZINC YELLOW**

**IBS No. 881P • 72 Items
3000 Pieces**

**USS Grade 8 Bolts
USS HT Flat Washers
USS Grade 8 Finished Nuts
Alloy Lock Washers**

- 150,000 psi tensile strength.
- Domestically made.
- Heat treated.
- Zinc Yellow Finish



881P • GRADE 8 ASSORTMENT • 72 Items

1/4-20 Hex Nut 4610	5/16-18 Hex Nut 4611	3/8-16 Hex Nut 4612	7/16-14 Hex Nut 4613	1/2-13 Hex Nut 4614	9/16-12 Hex Nut 4615	5/8-11 Hex Nut 4616	3/4-10 Hex Nut 4617
1/4 USS FW 2770	5/16 USS FW 2771	3/8 USS FW 2772	7/16 USS FW 2773	1/2 USS FW 2774	9/16 USS FW 2775	5/8 USS FW 2776	3/4 USS FW 2777
1/4 Alloy LW 7086	5/16 Alloy LW 7087	3/8 Alloy LW 7088	7/16 Alloy LW 7089	1/2 Alloy LW 7090	9/16 Alloy LW 7091	5/8 Alloy LW 7092	3/4 Alloy LW 7093
Open Stock	Open Stock	Open Stock	Open Stock	Open Stock	Open Stock	Open Stock	Open Stock
1/4 x 3/4 Capscrew 2403	5/16 x 3/4 Capscrew 2427	3/8 x 3/4 Capscrew 2452	7/16 x 1 Capscrew 2476	1/2 x 1 Capscrew 2498	9/16 x 1-1/4 Capscrew 2524	5/8 x 1-1/4 Capscrew 2541	3/4 x 1-1/2 Capscrew 2567
1/4 x 1 Capscrew 2404	5/16 x 1 Capscrew 2429	3/8 x 1 Capscrew 2454	7/16 x 1-1/4 Capscrew 2477	1/2 x 1-1/4 Capscrew 2499	9/16 x 1-1/2 Capscrew 2525	5/8 x 1-1/2 Capscrew 2542	3/4 x 1-3/4 Capscrew 2568
1/4 x 1-1/4 Capscrew 2405	5/16 x 1-1/4 Capscrew 2430	3/8 x 1-1/4 Capscrew 2455	7/16 x 1-1/2 Capscrew 2478	1/2 x 1-1/2 Capscrew 2500	9/16 x 1-3/4 Capscrew 2526	5/8 x 1-3/4 Capscrew 2543	3/4 x 2 Capscrew 2569
1/4 x 1-1/2 Capscrew 2406	5/16 x 1-1/2 Capscrew 2431	3/8 x 1-1/2 Capscrew 2456	7/16 x 1-3/4 Capscrew 2479	1/2 x 1-3/4 Capscrew 2501	9/16 x 2 Capscrew 2527	5/8 x 2 Capscrew 2544	3/4 x 2-1/2 Capscrew 2571
1/4 x 1-3/4 Capscrew 2407	5/16 x 1-3/4 Capscrew 2432	3/8 x 2 Capscrew 2458	7/16 x 2 Capscrew 2480	1/2 x 2 Capscrew 2502	9/16 x 2-1/2 Capscrew 2529	5/8 x 2-1/2 Capscrew 2546	3/4 x 3 Capscrew 2573
1/4 x 2 Capscrew 2408	5/16 x 2 Capscrew 2433	3/8 x 2-1/2 Capscrew 2460	7/16 x 2-1/2 Capscrew 2482	1/2 x 2-1/2 Capscrew 2504	9/16 x 3 Capscrew 2531	5/8 x 3 Capscrew 2548	3/4 x 3-1/2 Capscrew 2575

IBS, INCORPORATED

Assortments Z08



Grade 8 Assortment

COARSE THREAD

PLATED ZINC YELLOW

IBS No. 438P • 40 Items

1985 Pieces

USS Grade 8 Bolts

SAE HT Flat Washers

USS Grade 8 Finished Nuts

Alloy Lockwashers

- 150,000 psi tensile strength.
- Domestically made.
- Heat treated.
- Plated Finish



1/4-20 Hex Nut 4610	1/4 Alloy LW 7086	1/4 SAE FW 2660	1/4 x 3/4 Capscrew 2403	1/4 x 1 Capscrew 2404	1/4 x 1-1/4 Capscrew 2405	1/4 x 1-1/2 Capscrew 2406	1/4 x 2 Capscrew 2408
5/16-18 Hex Nut 4611	5/16 Alloy LW 7087	5/16 SAE FW 2661	5/16 x 3/4 Capscrew 2427	5/16 x 1 Capscrew 2429	5/16 x 1-1/4 Capscrew 2430	5/16 x 1-1/2 Capscrew 2431	5/16 x 2 Capscrew 2433
3/8-16 Hex Nut 4612	3/8 Alloy LW 7088	3/8 SAE FW 2662	3/8 x 1 Capscrew 2454	3/8 x 1-1/4 Capscrew 2455	3/8 x 1-1/2 Capscrew 2456	3/8 x 2 Capscrew 2458	3/8 x 2-1/2 Capscrew 2460
7/16-14 Hex Nut 4613	5/16 Alloy LW 7089	7/16 SAE FW 2663	7/16 x 1 Capscrew 2476	7/16 x 1-1/4 Capscrew 2477	7/16 x 1-1/2 Capscrew 2478	7/16 x 2 Capscrew 2480	7/16 x 2-1/2 Capscrew 2482
1/2-13 Hex Nut 4614	1/2 Alloy LW 7090	1/2 SAE FW 2664	1/2 x 1 Capscrew 2498	1/2 x 1-1/4 Capscrew 2499	1/2 x 1-1/2 Capscrew 2500	1/2 x 2 Capscrew 2502	1/2 x 2-1/2 Capscrew 2504

Grade 8 Assortment

COARSE THREAD

PLATED ZINC YELLOW

IBS No. 655P • 40 Items

1985 Pieces

USS Grade 8 Bolts

USS HT Flat Washers

USS Grade 8 Finished Nuts

Alloy Lockwashers

- 150,000 psi tensile strength.
- Domestically made.
- Heat treated.
- Plated Finish



1/4-20 Hex Nut 4610	1/4 Alloy LW 7086	1/4 USS FW 2770	1/4 x 3/4 Capscrew 2403	1/4 x 1 Capscrew 2404	1/4 x 1-1/4 Capscrew 2405	1/4 x 1-1/2 Capscrew 2406	1/4 x 2 Capscrew 2408
5/16-18 Hex Nut 4611	5/16 Alloy LW 7087	5/16 USS FW 2771	5/16 x 3/4 Capscrew 2427	5/16 x 1 Capscrew 2429	5/16 x 1-1/4 Capscrew 2430	5/16 x 1-1/2 Capscrew 2431	5/16 x 2 Capscrew 2433
3/8-16 Hex Nut 4612	3/8 Alloy LW 7088	3/8 USS FW 2772	3/8 x 1 Capscrew 2454	3/8 x 1-1/4 Capscrew 2455	3/8 x 1-1/2 Capscrew 2456	3/8 x 2 Capscrew 2458	3/8 x 2-1/2 Capscrew 2460
7/16-14 Hex Nut 4613	5/16 Alloy LW 7089	7/16 USS FW 2773	7/16 x 1 Capscrew 2476	7/16 x 1-1/4 Capscrew 2477	7/16 x 1-1/2 Capscrew 2478	7/16 x 2 Capscrew 2480	7/16 x 2-1/2 Capscrew 2482
1/2-13 Hex Nut 4614	1/2 Alloy LW 7090	1/2 USS FW 2774	1/2 x 1 Capscrew 2498	1/2 x 1-1/4 Capscrew 2499	1/2 x 1-1/2 Capscrew 2500	1/2 x 2 Capscrew 2502	1/2 x 2-1/2 Capscrew 2504

C
A
P
S
C
R
E
W
S



IBS, INCORPORATED

Grade 8 Capscrews Nat'l Fine A06

SAE Grade 8 Capscrews NATIONAL FINE - ZINC YELLOW



C
A
P
S
C
R
E
W
S

Length	1/4- 28 P/N	5/16- 24 P/N	3/8- 24 P/N	Qty	7/16- 20 P/N	1/2- 20 P/N	Qty	9/16- 18 P/N	5/8- 18 P/N	Qty	3/4- 16 P/N	Qty	7/8- 14 P/N	Qty	1-14 P/N	Qty	Length
1/2	1594	1615	1636	100	—	—	—	—	—	—	—	—	—	—	—	—	1/2
3/4	1596	1617	1638	100	1659	1678	50	—	—	—	—	—	—	—	—	—	3/4
1	1598	1619	1640	100	1661	1679	50	1700	1717	25	—	—	—	—	—	—	1
1-1/4	1599	1620	1641	100	1662	1680	50	1701	1718	25	1741	20	—	—	—	—	1-1/4
1-1/2	1600	1621	1642	100	1663	1681	50	1702	1719	25	1742	20	—	—	—	—	1-1/2
1-3/4	1601	1622	1643	100	1664	1682	50	1703	1720	25	1743	20	—	—	—	—	1-3/4
2	1602	1623	1644	100	1665	1683	50	1704	1721	25	1744	20	1761	15	1774	10	2
2-1/4	—	—	1645	50	1666	1684	25	1705	1722	25	1745	20	1762	15	1775	10	2-1/4
2-1/2	1604	1625	1646	50	1667	1685	25	1706	1723	25	1746	20	1763	15	1776	10	2-1/2
2-3/4	1605	1626	1647	50	1668	1686	25	1707	1724	25	1747	20	1764	15	1777	10	2-3/4
3	1606	1627	1648	50	1669	1687	25	1708	1725	25	1748	20	1765	10	1778	10	3
3-1/2	1608	1629	1650	50	1671	1689	25	1710	1727	25	1750	20	1767	10	1780	10	3-1/2
4	1610	1631	1652	25	1673	1691	25	1712	1729	25	1752	20	1769	10	1782	10	4
4-1/2	1611	1632	1653	25	1674	1692	15	1713	1730	15	1753	10	1770	5	1783	5	4-1/2
5	1612	1633	1654	25	1675	1693	15	1714	1731	15	1754	10	1771	5	1784	5	5
5-1/2	1613	1634	1655	25	1676	1694	15	1715	1732	15	1755	10	1772	5	1785	5	5-1/2
6	1614	1635	1656	25	1677	1695	15	1716	1733	15	1756	10	1773	5	1786	5	6
6-1/2	—	—	—	—	—	—	—	—	—	—	1757	EA	—	—	—	—	6-1/2
7	—	—	—	—	—	—	—	—	1735	EA	1758	EA	—	—	—	—	7

IBS, INCORPORATED

Bin Assortments Z06



Grade 8

Assortment

FINE THREAD

PLATED ZINC YELLOW

IBS No. 882P • 72 Items
2700 Pieces

SAE Grade 8 Bolts
SAE HT Flat Washers
SAE Grade 8 Finished Nuts
Alloy Lock Washers

- 150,000 psi tensile strength.
- Domestically made.
- Heat treated.



882P • GRADE 8 ASSORTMENT • 72 Items

1/4-28 Hex Nut 6640	5/16-24 Hex Nut 6641	3/8-24 Hex Nut 6642	7/16-20 Hex Nut 6643	1/2-20 Hex Nut 6644	9/16-18 Hex Nut 6645	5/8-18 Hex Nut 6646	3/4-16 Hex Nut 6647
1/4 SAE FW 2660	5/16 SAE FW 2661	3/8 SAE FW 2662	7/16 SAE FW 2663	1/2 SAE FW 2664	9/16 SAE FW 2665	5/8 SAE FW 2666	3/4 SAE FW 2667
1/4 Alloy LW 7086	5/16 Alloy LW 7087	3/8 Alloy LW 7088	7/16 Alloy LW 7089	1/2 Alloy LW 7090	9/16 Alloy LW 7091	5/8 Alloy LW 7092	3/4 Alloy LW 7093
Open Stock	Open Stock	Open Stock	Open Stock	Open Stock	Open Stock	Open Stock	Open Stock
1/4 x 3/4 Capscrew 1596	5/16 x 3/4 Capscrew 1617	3/8 x 3/4 Capscrew 1638	7/16 x 1 Capscrew 1661	1/2 x 1 Capscrew 1679	9/16 x 1-1/4 Capscrew 1701	5/8 x 1-1/4 Capscrew 1718	3/4 x 1-1/2 Capscrew 1742
1/4 x 1 Capscrew 1598	5/16 x 1 Capscrew 1619	3/8 x 1 Capscrew 1640	7/16 x 1-1/4 Capscrew 1662	1/2 x 1-1/4 Capscrew 1680	9/16 x 1-1/2 Capscrew 1702	5/8 x 1-1/2 Capscrew 1719	3/4 x 1-3/4 Capscrew 1743
1/4 x 1-1/4 Capscrew 1599	5/16 x 1-1/4 Capscrew 1620	3/8 x 1-1/4 Capscrew 1641	7/16 x 1-1/2 Capscrew 1663	1/2 x 1-1/2 Capscrew 1681	9/16 x 1-3/4 Capscrew 1703	5/8 x 1-3/4 Capscrew 1720	3/4 x 2 Capscrew 1744
1/4 x 1-1/2 Capscrew 1600	5/16 x 1-1/2 Capscrew 1621	3/8 x 1-1/2 Capscrew 1642	7/16 x 1-3/4 Capscrew 1664	1/2 x 1-3/4 Capscrew 1682	9/16 x 2 Capscrew 1704	5/8 x 2 Capscrew 1721	3/4 x 2-1/2 Capscrew 1746
1/4 x 1-3/4 Capscrew 1601	5/16 x 1-3/4 Capscrew 1622	3/8 x 2 Capscrew 1644	7/16 x 2 Capscrew 1665	1/2 x 2 Capscrew 1683	9/16 x 2-1/2 Capscrew 1706	5/8 x 2-1/2 Capscrew 1723	3/4 x 3 Capscrew 1748
1/4 x 2 Capscrew 1602	5/16 x 2 Capscrew 1623	3/8 x 2-1/2 Capscrew 1646	7/16 x 2-1/2 Capscrew 1667	1/2 x 2-1/2 Capscrew 1685	9/16 x 3 Capscrew 1708	5/8 x 3 Capscrew 1725	3/4 x 3-1/2 Capscrew 1750

Grade 8 Assortment

FINE THREAD

PLATED ZINC YELLOW

IBS No. 883P • 72 Items
2700 Pieces

SAE Grade 8 Bolts
USS HT Flat Washers
SAE Grade 8 Finished Nuts
Alloy Lock Washers

- 150,000 psi tensile strength.
- Domestically made.
- Heat treated.



883P • GRADE 8 ASSORTMENT • 72 Items

1/4-28 Hex Nut 6640	5/16-24 Hex Nut 6641	3/8-24 Hex Nut 6642	7/16-20 Hex Nut 6643	1/2-20 Hex Nut 6644	9/16-18 Hex Nut 6645	5/8-18 Hex Nut 6646	3/4-16 Hex Nut 6647
1/4 USS FW 2770	5/16 USS FW 2771	3/8 USS FW 2772	7/16 USS FW 2773	1/2 USS FW 2774	9/16 USS FW 2775	5/8 USS FW 2776	3/4 USS FW 2777
1/4 Alloy LW 7086	5/16 Alloy LW 7087	3/8 Alloy LW 7088	7/16 Alloy LW 7089	1/2 Alloy LW 7090	9/16 Alloy LW 7091	5/8 Alloy LW 7092	3/4 Alloy LW 7093
Open Stock	Open Stock	Open Stock	Open Stock	Open Stock	Open Stock	Open Stock	Open Stock
1/4 x 3/4 Capscrew 1596	5/16 x 3/4 Capscrew 1617	3/8 x 3/4 Capscrew 1638	7/16 x 1 Capscrew 1661	1/2 x 1 Capscrew 1679	9/16 x 1-1/4 Capscrew 1701	5/8 x 1-1/4 Capscrew 1718	3/4 x 1-1/2 Capscrew 1742
1/4 x 1 Capscrew 1598	5/16 x 1 Capscrew 1619	3/8 x 1 Capscrew 1640	7/16 x 1-1/4 Capscrew 1662	1/2 x 1-1/4 Capscrew 1680	9/16 x 1-1/2 Capscrew 1702	5/8 x 1-1/2 Capscrew 1719	3/4 x 1-3/4 Capscrew 1743
1/4 x 1-1/4 Capscrew 1599	5/16 x 1-1/4 Capscrew 1620	3/8 x 1-1/4 Capscrew 1641	7/16 x 1-1/2 Capscrew 1663	1/2 x 1-1/2 Capscrew 1681	9/16 x 1-3/4 Capscrew 1703	5/8 x 1-3/4 Capscrew 1720	3/4 x 2 Capscrew 1744
1/4 x 1-1/2 Capscrew 1600	5/16 x 1-1/2 Capscrew 1621	3/8 x 1-1/2 Capscrew 1642	7/16 x 1-3/4 Capscrew 1664	1/2 x 1-3/4 Capscrew 1682	9/16 x 2 Capscrew 1704	5/8 x 2 Capscrew 1721	3/4 x 2-1/2 Capscrew 1746
1/4 x 1-3/4 Capscrew 1601	5/16 x 1-3/4 Capscrew 1622	3/8 x 2 Capscrew 1644	7/16 x 2 Capscrew 1665	1/2 x 2 Capscrew 1683	9/16 x 2-1/2 Capscrew 1706	5/8 x 2-1/2 Capscrew 1723	3/4 x 3 Capscrew 1748
1/4 x 2 Capscrew 1602	5/16 x 2 Capscrew 1623	3/8 x 2-1/2 Capscrew 1646	7/16 x 2-1/2 Capscrew 1667	1/2 x 2-1/2 Capscrew 1685	9/16 x 3 Capscrew 1708	5/8 x 3 Capscrew 1725	3/4 x 3-1/2 Capscrew 1750

C
A
P
S
C
R
E
W
S



IBS, INCORPORATED

Assortments Z08

Grade 8 Assortment

FINE THREAD

PLATED ZINC YELLOW

**IBS No. 439P • 40 Items
1840 Pieces**

SAE Grade 8 Bolts

SAE HT Flat Washers

**SAE Grade 8 Finished Nuts
Alloy Lockwashers**

- 150,000 psi tensile strength.
- Domestically made.
- Heat treated.
- Plated Finish



1/4-28 Hex Nut 6640	1/4 Alloy LW 7086	1/4 SAE FW 2660	1/4 x 3/4 Capscrew 1596	1/4 x 1 Capscrew 1598	1/4 x 1-1/4 Capscrew 1599	1/4 x 1-1/2 Capscrew 1600	1/4 x 2 Capscrew 1602
5/16-24 Hex Nut 6641	5/16 Alloy LW 7087	5/16 SAE FW 2661	5/16 x 3/4 Capscrew 1617	5/16 x 1 Capscrew 1619	5/16 x 1-1/4 Capscrew 1620	5/16 x 1-1/2 Capscrew 1621	5/16 x 2 Capscrew 1623
3/8-24 Hex Nut 6642	3/8 Alloy LW 7088	3/8 SAE FW 2662	3/8 x 1 Capscrew 1640	3/8 x 1-1/4 Capscrew 1641	3/8 x 1-1/2 Capscrew 1642	3/8 x 2 Capscrew 1644	3/8 x 2-1/2 Capscrew 1646
7/16-20 Hex Nut 6643	5/16 Alloy LW 7089	7/16 SAE FW 2663	7/16 x 1 Capscrew 1661	7/16 x 1-1/4 Capscrew 1662	7/16 x 1-1/2 Capscrew 1663	7/16 x 2 Capscrew 1665	7/16 x 2-1/2 Capscrew 1667
1/2-20 Hex Nut 6644	1/2 Alloy LW 7090	1/2 SAE FW 2664	1/2 x 1 Capscrew 1679	1/2 x 1-1/4 Capscrew 1680	1/2 x 1-1/2 Capscrew 1681	1/2 x 2 Capscrew 1683	1/2 x 2-1/2 Capscrew 1685

Grade 8 Assortment

FINE THREAD

PLATED ZINC YELLOW

**IBS No. 656P • 40 Items
1840 Pieces**

SAE Grade 8 Bolts

USS HT Flat Washers

**SAE Grade 8 Finished Nuts
Alloy Lock Washers**

- 150,000 psi tensile strength.
- Domestically made.
- Heat treated.
- Plated Finish



1/4-28 Hex Nut 6640	1/4 Alloy LW 7086	1/4 USS FW 2770	1/4 x 3/4 Capscrew 1596	1/4 x 1 Capscrew 1598	1/4 x 1-1/4 Capscrew 1599	1/4 x 1-1/2 Capscrew 1600	1/4 x 2 Capscrew 1602
5/16-24 Hex Nut 6641	5/16 Alloy LW 7087	5/16 USS FW 2771	5/16 x 3/4 Capscrew 1617	5/16 x 1 Capscrew 1619	5/16 x 1-1/4 Capscrew 1620	5/16 x 1-1/2 Capscrew 1621	5/16 x 2 Capscrew 1623
3/8-24 Hex Nut 6642	3/8 Alloy LW 7088	3/8 USS FW 2772	3/8 x 1 Capscrew 1640	3/8 x 1-1/4 Capscrew 1641	3/8 x 1-1/2 Capscrew 1642	3/8 x 2 Capscrew 1644	3/8 x 2-1/2 Capscrew 1646
7/16-20 Hex Nut 6643	5/16 Alloy LW 7089	7/16 USS FW 2773	7/16 x 1 Capscrew 1661	7/16 x 1-1/4 Capscrew 1662	7/16 x 1-1/2 Capscrew 1663	7/16 x 2 Capscrew 1665	7/16 x 2-1/2 Capscrew 1667
1/2-20 Hex Nut 6644	1/2 Alloy LW 7090	1/2 USS FW 2774	1/2 x 1 Capscrew 1679	1/2 x 1-1/4 Capscrew 1680	1/2 x 1-1/2 Capscrew 1681	1/2 x 2 Capscrew 1683	1/2 x 2-1/2 Capscrew 1685

C
A
P
S
C
R
E
W
S



Grade 5 Hex Capscrews **Heat Treated • Zinc Plated**

Grade 5 Hex Capscrews are cold forged. Cold forging eliminates some negative effects such as porosity fatigue by increasing the overall strength of the metal and removing the risk of a loss of material integrity.

Increased quality and long life: Cold forged parts are capable of handling high stress. When the workpiece is forced beyond its yield or elastic limit, it is still able to retain its altered shape.

- REDUCES DOWN TIME DUE TO POOR FASTENER ASSEMBLIES
- REDUCES COSTLY WASTED MANHOURS
- REDUCES UNNECESSARY DAMAGE AND WEAR
- INCREASES EFFECTIVENESS OF EQUIPMENT AND MAINTENANCE PROGRAM

Cold Forging Process

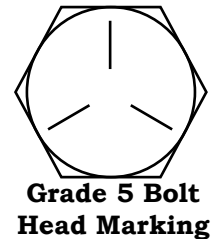
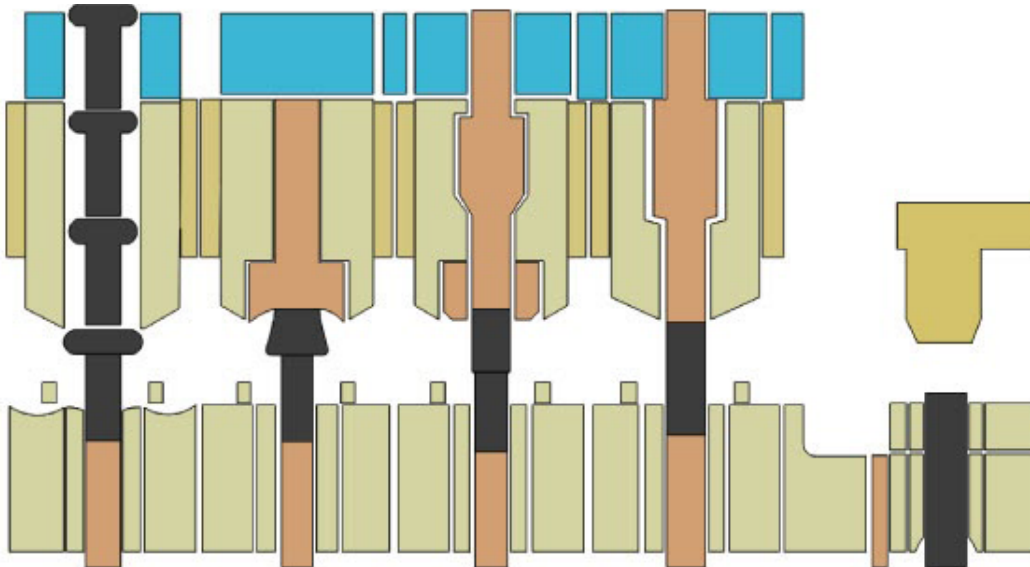



IBS, INCORPORATED

Grade 5 Capscrews Nat'l Coarse A07

USS Grade 5 Capscrews NATIONAL COARSE — ZINC



Length	1/4- 20 P/N	5/16- 18 P/N	3/8- 16 P/N	Qty	7/16- 14 P/N	1/2- 13 P/N	Qty	9/16- 12 P/N	5/8- 11 P/N	Qty	3/4- 10 P/N	Qty	7/8-9 P/N	1-8 P/N	Qty	Length
1/2	1900	1921	1942	100	—	—	—	—	—	—	—	—	—	—	—	1/2
3/4	1902	1923	1944	100	1967	1983	50	—	—	—	—	—	—	—	—	3/4
1	1904	1925	1946	100	1968	1984	50	2009	2024	25	2051	20	—	—	—	1
1-1/4	1905	1926	1947	100	1969	1985	50	2010	2025	25	2052	20	—	—	—	1-1/4
1-1/2	1906	1927	1948	100	1970	1986	50	2011	2026	25	2053	20	2072	—	10	1-1/2
1-3/4	1907	1928	1949	100	1971	1987	50	2012	2027	25	2054	20	2073	—	10	1-3/4
2	1908	1929	1950	100	1972	1988	50	2013	2028	25	2055	20	2074	2091	10	2
2-1/4	1909	1930	1951	50	1973	1989	25	2014	2029	25	2056	20	2075	2092	10	2-1/4
2-1/2	1910	1931	1952	50	1974	1990	25	2015	2030	25	2057	20	2076	2093	10	2-1/2
2-3/4	1911	1932	1953	50	1975	1991	25	2016	2031	25	2058	20	2077	2094	10	2-3/4
3	1912	1933	1954	50	1976	1992	25	2017	2032	25	2059	20	2078	2095	10	3
3-1/2	1914	1935	1956	50	1977	1994	25	2018	2034	25	2061	20	2080	2097	10	3-1/2
4	1916	1937	1958	50	1978	1996	25	2019	2036	25	2063	20	2082	2099	10	4
4-1/2	1917	1938	1959	25	1979	1997	15	2020	2037	15	2064	10	2083	2100	5	4-1/2
5	1918	1939	1960	25	1980	1998	15	2021	2038	15	2065	10	2084	2101	5	5
5-1/2	1919	1940	1961	25	1981	1999	15	2022	2039	15	2066	10	2085	2102	5	5-1/2
6	1920	1941	1962	25	1982	2000	15	2023	2040	15	2067	10	2086	2103	5	6
7			—	—	—	—	—	—	2041	—	—	—	—	2105	EA	7
8			—	—	—	—	—	—	—	—	—	—	—	2107	EA	8

CAPSCREWS

IBS, INCORPORATED

Bin Assortments Z06



850P • GRADE 5 ASSORTMENT • 72 Items

Grade 5 Capscrew Assortment

**COARSE THREAD
PLATED ZINC**

**IBS No. 850P • 72 Items
3340 Pieces**

**USS Grade 5 Bolts
SAE Flat Washers**

**USS Grade 5 Finished Nuts
Lockwashers**

- 120,000 psi Tensile Strength.
- Heat treated and Zinc plated.



1/4-20 Hex Nut 4100	5/16-18 Hex Nut 4101	3/8-16 Hex Nut 4102	7/16-14 Hex Nut 4103	1/2-13 Hex Nut 4104	9/16-12 Hex Nut 4105	5/8-11 Hex Nut 4106	3/4-10 Hex Nut 4107
1/4 SAE FW 7049	5/16 SAE FW 7050	3/8 SAE FW 7051	7/16 SAE FW 7052	1/2 SAE FW 7053	9/16 SAE FW 7054	5/8 SAE FW 7055	3/4 SAE FW 7056
1/4 Med LW 7105	5/16 Med LW 7106	3/8 Med LW 7107	7/16 Med LW 7108	1/2 Med LW 7109	9/16 Med LW 7110	5/8 Med LW 7111	3/4 Med LW 7112
Open Stock	Open Stock	Open Stock	Open Stock	Open Stock	Open Stock	Open Stock	Open Stock
1/4 x 3/4 Capscrew 1902	5/16 x 3/4 Capscrew 1923	3/8 x 3/4 Capscrew 1944	7/16 x 1 Capscrew 1968	1/2 x 1 Capscrew 1984	9/16 x 1-1/4 Capscrew 2010	5/8 x 1-1/4 Capscrew 2025	3/4 x 1-1/2 Capscrew 2053
1/4 x 1 Capscrew 1904	5/16 x 1 Capscrew 1925	3/8 x 1 Capscrew 1946	7/16 x 1-1/4 Capscrew 1969	1/2 x 1-1/4 Capscrew 1985	9/16 x 1-1/2 Capscrew 2011	5/8 x 1-1/2 Capscrew 2026	3/4 x 1-3/4 Capscrew 2054
1/4 x 1-1/4 Capscrew 1905	5/16 x 1-1/4 Capscrew 1926	3/8 x 1-1/4 Capscrew 1947	7/16 x 1-1/2 Capscrew 1970	1/2 x 1-1/2 Capscrew 1986	9/16 x 1-3/4 Capscrew 2012	5/8 x 1-3/4 Capscrew 2027	3/4 x 2 Capscrew 2055
1/4 x 1-1/2 Capscrew 1906	5/16 x 1-1/2 Capscrew 1927	3/8 x 1-1/2 Capscrew 1948	7/16 x 1-3/4 Capscrew 1971	1/2 x 1-3/4 Capscrew 1987	9/16 x 2 Capscrew 2013	5/8 x 2 Capscrew 2028	3/4 x 2-1/2 Capscrew 2057
1/4 x 1-3/4 Capscrew 1907	5/16 x 1-3/4 Capscrew 1928	3/8 x 2 Capscrew 1950	7/16 x 2 Capscrew 1972	1/2 x 2 Capscrew 1988	9/16 x 2-1/2 Capscrew 2015	5/8 x 2-1/2 Capscrew 2030	3/4 x 3 Capscrew 2059
1/4 x 2 Capscrew 1908	5/16 x 2 Capscrew 1929	3/8 x 2-1/2 Capscrew 1952	7/16 x 2-1/2 Capscrew 1974	1/2 x 2-1/2 Capscrew 1990	9/16 x 3 Capscrew 2017	5/8 x 3 Capscrew 2032	3/4 x 3-1/2 Capscrew 2061

851P • GRADE 5 ASSORTMENT • 72 Items

Grade 5 Capscrew Assortment

**COARSE THREAD
PLATED ZINC**

**IBS No. 851P • 72 Items
3340 Pieces**

**USS Grade 5 Bolts
USS Flat Washers**

**USS Grade 5 Finished Nuts
Lockwashers**

- 120,000 psi Tensile Strength.
- Heat treated and Zinc plated.



1/4-20 Hex Nut 4100	5/16-18 Hex Nut 4101	3/8-16 Hex Nut 4102	7/16-14 Hex Nut 4103	1/2-13 Hex Nut 4104	9/16-12 Hex Nut 4105	5/8-11 Hex Nut 4106	3/4-10 Hex Nut 4107
1/4 USS FW 7063	5/16 USS FW 7064	3/8 USS FW 7065	7/16 USS FW 7066	1/2 USS FW 7067	9/16 USS FW 7068	5/8 USS FW 7069	3/4 USS FW 7070
1/4 Med LW 7105	5/16 Med LW 7106	3/8 Med LW 7107	7/16 Med LW 7108	1/2 Med LW 7109	9/16 Med LW 7110	5/8 Med LW 7111	3/4 Med LW 7112
Open Stock	Open Stock	Open Stock	Open Stock	Open Stock	Open Stock	Open Stock	Open Stock
1/4 x 3/4 Capscrew 1902	5/16 x 3/4 Capscrew 1923	3/8 x 3/4 Capscrew 1944	7/16 x 1 Capscrew 1968	1/2 x 1 Capscrew 1984	9/16 x 1-1/4 Capscrew 2010	5/8 x 1-1/4 Capscrew 2025	3/4 x 1-1/2 Capscrew 2053
1/4 x 1 Capscrew 1904	5/16 x 1 Capscrew 1925	3/8 x 1 Capscrew 1946	7/16 x 1-1/4 Capscrew 1969	1/2 x 1-1/4 Capscrew 1985	9/16 x 1-1/2 Capscrew 2011	5/8 x 1-1/2 Capscrew 2026	3/4 x 1-3/4 Capscrew 2054
1/4 x 1-1/4 Capscrew 1905	5/16 x 1-1/4 Capscrew 1926	3/8 x 1-1/4 Capscrew 1947	7/16 x 1-1/2 Capscrew 1970	1/2 x 1-1/2 Capscrew 1986	9/16 x 1-3/4 Capscrew 2012	5/8 x 1-3/4 Capscrew 2027	3/4 x 2 Capscrew 2055
1/4 x 1-1/2 Capscrew 1906	5/16 x 1-1/2 Capscrew 1927	3/8 x 1-1/2 Capscrew 1948	7/16 x 1-3/4 Capscrew 1971	1/2 x 1-3/4 Capscrew 1987	9/16 x 2 Capscrew 2013	5/8 x 2 Capscrew 2028	3/4 x 2-1/2 Capscrew 2057
1/4 x 1-3/4 Capscrew 1907	5/16 x 1-3/4 Capscrew 1928	3/8 x 2 Capscrew 1950	7/16 x 2 Capscrew 1972	1/2 x 2 Capscrew 1988	9/16 x 2-1/2 Capscrew 2015	5/8 x 2-1/2 Capscrew 2030	3/4 x 3 Capscrew 2059
1/4 x 2 Capscrew 1908	5/16 x 2 Capscrew 1929	3/8 x 2-1/2 Capscrew 1952	7/16 x 2-1/2 Capscrew 1974	1/2 x 2-1/2 Capscrew 1990	9/16 x 3 Capscrew 2017	5/8 x 3 Capscrew 2032	3/4 x 3-1/2 Capscrew 2061

CAPSCREWS



IBS, INCORPORATED

Assortments Z08

Grade 5 Capscrew Assortment

COARSE THREAD — PLATED ZINC
IBS No. 651P • 40 Items
2285 Pieces
USS Grade 5 Bolts
SAE Flat Washers
USS Grade 5 Finished Nuts
Lockwashers



1/4-20 Hex Nut 4100	1/4 Med LW 7105	1/4 SAE FW 7049	1/4 x 3/4 Capscrew 1902	1/4 x 1 Capscrew 1904	1/4 x 1-1/4 Capscrew 1905	1/4 x 1-1/2 Capscrew 1906	1/4 x 2 Capscrew 1908
5/16-18 Hex Nut 4101	5/16 Med LW 7106	5/16 SAE FW 7050	5/16 x 3/4 Capscrew 1923	5/16 x 1 Capscrew 1925	5/16 x 1-1/4 Capscrew 1926	5/16 x 1-1/2 Capscrew 1927	5/16 x 2 Capscrew 1929
3/8-16 Hex Nut 4102	3/8 Med LW 7107	3/8 SAE FW 7051	3/8 x 1 Capscrew 1946	3/8 x 1-1/4 Capscrew 1947	3/8 x 1-1/2 Capscrew 1948	3/8 x 2 Capscrew 1950	3/8 x 2-1/2 Capscrew 1952
7/16-14 Hex Nut 4103	5/16 Med LW 7108	7/16 SAE FW 7052	7/16 x 1 Capscrew 1968	7/16 x 1-1/4 Capscrew 1969	7/16 x 1-1/2 Capscrew 1970	7/16 x 2 Capscrew 1972	7/16 x 2-1/2 Capscrew 1974
1/2-13 Hex Nut 4104	1/2 Med LW 7109	1/2 SAE FW 7053	1/2 x 1 Capscrew 1984	1/2 x 1-1/4 Capscrew 1985	1/2 x 1-1/2 Capscrew 1986	1/2 x 2 Capscrew 1988	1/2 x 2-1/2 Capscrew 1990

Grade 5 Capscrew Assortment

COARSE THREAD • PLATED ZINC
IBS No. 430P • 40 Items
2285 Pieces
USS Grade 5 Bolts
USS Flat Washers
USS Grade 5 Finished Nuts
Lockwashers



1/4-20 Hex Nut 4100	1/4 Med LW 7105	1/4 USS FW 7063	1/4 x 3/4 Capscrew 1902	1/4 x 1 Capscrew 1904	1/4 x 1-1/4 Capscrew 1905	1/4 x 1-1/2 Capscrew 1906	1/4 x 2 Capscrew 1908
5/16-18 Hex Nut 4101	5/16 Med LW 7106	5/16 USS FW 7064	5/16 x 3/4 Capscrew 1923	5/16 x 1 Capscrew 1925	5/16 x 1-1/4 Capscrew 1926	5/16 x 1-1/2 Capscrew 1927	5/16 x 2 Capscrew 1929
3/8-16 Hex Nut 4102	3/8 Med LW 7107	3/8 USS FW 7065	3/8 x 1 Capscrew 1946	3/8 x 1-1/4 Capscrew 1947	3/8 x 1-1/2 Capscrew 1948	3/8 x 2 Capscrew 1950	3/8 x 2-1/2 Capscrew 1952
7/16-14 Hex Nut 4103	5/16 Med LW 7108	7/16 USS FW 7066	7/16 x 1 Capscrew 1968	7/16 x 1-1/4 Capscrew 1969	7/16 x 1-1/2 Capscrew 1970	7/16 x 2 Capscrew 1972	7/16 x 2-1/2 Capscrew 1974
1/2-13 Hex Nut 4104	1/2 Med LW 7109	1/2 USS FW 7067	1/2 x 1 Capscrew 1984	1/2 x 1-1/4 Capscrew 1985	1/2 x 1-1/2 Capscrew 1986	1/2 x 2 Capscrew 1988	1/2 x 2-1/2 Capscrew 1990

C
A
P
S
C
R
E
W
S

IBS, INCORPORATED

Grade 5 Capscrews Nat'l Fine A08



SAE Grade 5 Capscrews

NATIONAL FINE — ZINC

Length	1/4-28	5/16-24	3/8-24	Qty	7/16-20	1/2-20	Qty	9/16-18	5/8-18	Qty	3/4-16	Qty	7/8-14	1-14	Qty	Length
	P/N	P/N	P/N		P/N	P/N		P/N	P/N		P/N		P/N	P/N		
1/2	2200	2221	—	100	—	—	—	—	—	—	—	—	—	—	—	1/2
3/4	2202	2223	2243	100	—	2282	50	—	—	—	—	—	—	—	—	3/4
1	2204	2225	2245	100	2264	2283	50	2304	2320	25	—	—	—	—	—	1
1-1/4	2205	2226	2246	100	2265	2284	50	2305	2321	25	2343	20	—	—	—	1-1/4
1-1/2	2206	2227	2247	100	2266	2285	50	2306	2322	25	2344	20	—	—	—	1-1/2
1-3/4	2207	2228	2248	100	2267	2286	50	2307	2323	25	2345	20	—	—	—	1-3/4
2	2208	2229	2249	100	2268	2287	50	2308	2324	25	2346	20	2367	2380	10	2
2-1/4	—	2230	2250	50	—	2288	25	2309	2325	25	2347	20	2368	2381	10	2-1/4
2-1/2	2210	2231	2251	50	2270	2289	25	2310	2326	25	2348	20	2369	2382	10	2-1/2
2-3/4	—	—	—	50	—	2290	25	2311	2327	25	2349	20	2370	2383	10	2-3/4
3	2212	2233	2253	50	2272	2291	25	2312	2328	25	2350	20	2371	2384	10	3
3-1/2	2214	2235	2255	50	2274	2293	25	2314	2330	25	2352	20	2373	2386	10	3-1/2
4	2216	2237	2257	50	2276	2295	25	2315	2332	25	2354	20	2375	2388	10	4
4-1/2	—	—	2258	25	2277	2296	15	2316	2333	15	2355	10	2376	2389	5	4-1/2
5	—	—	2259	25	2278	2297	15	2317	2334	15	2356	10	2377	2390	5	5
5-1/2	—	—	2260	25	2279	—	15	2318	2335	15	2357	10	2378	2391	5	5-1/2
6	—	—	2261	25	2280	2299	15	2319	2336	15	2358	10	2379	2392	5	6

CAPSCREWS

Grade 5 Capscrew Assortment

FINE THREAD • PLATED

IBS No. 852P • 72 Items
2910 Pieces

SAE Grade 5 Bolts

SAE Flat Washers

SAE Grade 5 Finished Nuts
Lockwashers

- 120,000 psi Tensile Strength
- Heat treated and Zinc plated.



852P • GRADE 5 ASSORTMENT • 72 Items

1/4-28 Hex Nut 4110	5/16-24 Hex Nut 4111	3/8-24 Hex Nut 4112	7/16-20 Hex Nut 4113	1/2-20 Hex Nut 4114	9/16-18 Hex Nut 4115	5/8-18 Hex Nut 4116	3/4-16 Hex Nut 4117
1/4 SAE FW 7049	5/16 SAE FW 7050	3/8 SAE FW 7051	7/16 SAE FW 7052	1/2 SAE FW 7053	9/16 SAE FW 7054	5/8 SAE FW 7055	3/4 SAE FW 7056
1/4 Med LW 7105	5/16 Med LW 7106	3/8 Med LW 7107	7/16 Med LW 7108	1/2 Med LW 7109	9/16 Med LW 7110	5/8 Med LW 7111	3/4 Med LW 7112
Open Stock	Open Stock	Open Stock	Open Stock	Open Stock	Open Stock	Open Stock	Open Stock
1/4 x 3/4 Capscrew 2202	5/16 x 3/4 Capscrew 2223	3/8 x 3/4 Capscrew 2243	7/16 x 1 Capscrew 2264	1/2 x 1 Capscrew 2283	9/16 x 1-1/4 Capscrew 2305	5/8 x 1-1/4 Capscrew 2321	3/4 x 1-1/2 Capscrew 2344
1/4 x 1 Capscrew 2204	5/16 x 1 Capscrew 2225	3/8 x 1 Capscrew 2245	7/16 x 1-1/4 Capscrew 2265	1/2 x 1-1/4 Capscrew 2284	9/16 x 1-1/2 Capscrew 2306	5/8 x 1-1/2 Capscrew 2322	3/4 x 1-3/4 Capscrew 2345
1/4 x 1-1/4 Capscrew 2205	5/16 x 1-1/4 Capscrew 2226	3/8 x 1-1/4 Capscrew 2246	7/16 x 1-1/2 Capscrew 2266	1/2 x 1-1/2 Capscrew 2285	9/16 x 1-3/4 Capscrew 2307	5/8 x 1-3/4 Capscrew 2323	3/4 x 2 Capscrew 2346
1/4 x 1-1/2 Capscrew 2206	5/16 x 1-1/2 Capscrew 2227	3/8 x 1-1/2 Capscrew 2247	7/16 x 1-3/4 Capscrew 2267	1/2 x 1-3/4 Capscrew 2286	9/16 x 2 Capscrew 2308	5/8 x 2 Capscrew 2324	3/4 x 2-1/2 Capscrew 2348
1/4 x 1-3/4 Capscrew 2207	5/16 x 1-3/4 Capscrew 2228	3/8 x 2 Capscrew 2249	7/16 x 2 Capscrew 2268	1/2 x 2 Capscrew 2287	9/16 x 2-1/2 Capscrew 2310	5/8 x 2-1/2 Capscrew 2326	3/4 x 3 Capscrew 2350
1/4 x 2 Capscrew 2208	5/16 x 2 Capscrew 2229	3/8 x 2-1/2 Capscrew 2251	7/16 x 2-1/2 Capscrew 2270	1/2 x 2-1/2 Capscrew 2289	9/16 x 3 Capscrew 2312	5/8 x 3 Capscrew 2328	3/4 x 3-1/2 Capscrew 2352



IBS, INCORPORATED

Assortments Z08

853P • GRADE 5 ASSORTMENT • 72 Items

Grade 5 Capscrew Assortment

**FINE THREAD
PLATED ZINC**

**IBS No. 853P • 72 Items
2910 Pieces**

**SAE Grade 5 Bolts
USS Flat Washers
SAE Grade 5 Finished Nuts
Lockwashers**

- 120,000 psi Tensile Strength.
- Heat treated and Zinc plated.



1/4-28 Hex Nut 4110	5/16-24 Hex Nut 4111	3/8-24 Hex Nut 4112	7/16-20 Hex Nut 4113	1/2-20 Hex Nut 4114	9/16-18 Hex Nut 4115	5/8-18 Hex Nut 4116	3/4-16 Hex Nut 4117
1/4 USS FW 7063	5/16 USS FW 7064	3/8 USS FW 7065	7/16 USS FW 7066	1/2 USS FW 7067	9/16 USS FW 7068	5/8 USS FW 7069	3/4 USS FW 7070
1/4 Med LW 7105	5/16 Med LW 7106	3/8 Med LW 7107	7/16 Med LW 7108	1/2 Med LW 7109	9/16 Med LW 7110	5/8 Med LW 7111	3/4 Med LW 7112
Open Stock	Open Stock	Open Stock	Open Stock	Open Stock	Open Stock	Open Stock	Open Stock
1/4 x 3/4 Capscrew 2202	5/16 x 3/4 Capscrew 2223	3/8 x 3/4 Capscrew 2243	7/16 x 1 Capscrew 2264	1/2 x 1 Capscrew 2283	9/16 x 1-1/4 Capscrew 2305	5/8 x 1-1/4 Capscrew 2321	3/4 x 1-1/2 Capscrew 2344
1/4 x 1 Capscrew 2204	5/16 x 1 Capscrew 2225	3/8 x 1 Capscrew 2245	7/16 x 1-1/4 Capscrew 2265	1/2 x 1-1/4 Capscrew 2284	9/16 x 1-1/2 Capscrew 2306	5/8 x 1-1/2 Capscrew 2322	3/4 x 1-3/4 Capscrew 2345
1/4 x 1-1/4 Capscrew 2205	5/16 x 1-1/4 Capscrew 2226	3/8 x 1-1/4 Capscrew 2246	7/16 x 1-1/2 Capscrew 2266	1/2 x 1-1/2 Capscrew 2285	9/16 x 1-3/4 Capscrew 2307	5/8 x 1-3/4 Capscrew 2323	3/4 x 2 Capscrew 2346
1/4 x 1-1/2 Capscrew 2206	5/16 x 1-1/2 Capscrew 2227	3/8 x 1-1/2 Capscrew 2247	7/16 x 1-3/4 Capscrew 2267	1/2 x 1-3/4 Capscrew 2286	9/16 x 2 Capscrew 2308	5/8 x 2 Capscrew 2324	3/4 x 2-1/2 Capscrew 2348
1/4 x 1-3/4 Capscrew 2207	5/16 x 1-3/4 Capscrew 2228	3/8 x 2 Capscrew 2249	7/16 x 2 Capscrew 2268	1/2 x 2 Capscrew 2287	9/16 x 2-1/2 Capscrew 2310	5/8 x 2-1/2 Capscrew 2326	3/4 x 3 Capscrew 2350
1/4 x 2 Capscrew 2208	5/16 x 2 Capscrew 2229	3/8 x 2-1/2 Capscrew 2251	7/16 x 2-1/2 Capscrew 2270	1/2 x 2-1/2 Capscrew 2289	9/16 x 3 Capscrew 2312	5/8 x 3 Capscrew 2328	3/4 x 3-1/2 Capscrew 2352

C
A
P
S
C
R
E
W
S

Grade 5 Capscrew Assortment

FINE THREAD — PLATED ZINC

**IBS No. 433P • 40 Items
1985 Pieces**

**SAE Grade 5 Bolts
SAE Flat Washers
SAE Grade 5 Finished Nuts
Lockwashers**



1/4-28 Hex Nut 4110	1/4 Med LW 7105	1/4 SAE FW 7049	1/4 x 3/4 Capscrew 2202	1/4 x 1 Capscrew 2204	1/4 x 1-1/4 Capscrew 2205	1/4 x 1-1/2 Capscrew 2206	1/4 x 2 Capscrew 2208
5/16-24 Hex Nut 4111	5/16 Med LW 7106	5/16 SAE FW 7050	5/16 x 3/4 Capscrew 2223	5/16 x 1 Capscrew 2225	5/16 x 1-1/4 Capscrew 2226	5/16 x 1-1/2 Capscrew 2227	5/16 x 2 Capscrew 2229
3/8-24 Hex Nut 4112	3/8 Med LW 7107	3/8 SAE FW 7051	3/8 x 1 Capscrew 2245	3/8 x 1-1/4 Capscrew 2246	3/8 x 1-1/2 Capscrew 2247	3/8 x 2 Capscrew 2249	3/8 x 2-1/2 Capscrew 2251
7/16-20 Hex Nut 4113	5/16 Med LW 7108	7/16 SAE FW 7052	7/16 x 1 Capscrew 2264	7/16 x 1-1/4 Capscrew 2265	7/16 x 1-1/2 Capscrew 2266	7/16 x 2 Capscrew 2268	7/16 x 2-1/2 Capscrew 2270
1/2-20 Hex Nut 4114	1/2 Med LW 7109	1/2 SAE FW 7053	1/2 x 1 Capscrew 2283	1/2 x 1-1/4 Capscrew 2284	1/2 x 1-1/2 Capscrew 2285	1/2 x 2 Capscrew 2287	1/2 x 2-1/2 Capscrew 2289

Grade 5 Capscrew Assortment

FINE THREAD • PLATED ZINC

**IBS No. 652P • 40 Items
1985 Pieces**

**SAE Grade 8 Bolts
USS Flat Washers
SAE Grade 5 Finished Nuts
Lockwashers**



1/4-28 Hex Nut 4110	1/4 Med LW 7105	1/4 USS FW 7063	1/4 x 3/4 Capscrew 2202	1/4 x 1 Capscrew 2204	1/4 x 1-1/4 Capscrew 2205	1/4 x 1-1/2 Capscrew 2206	1/4 x 2 Capscrew 2208
5/16-24 Hex Nut 4111	5/16 Med LW 7106	5/16 USS FW 7064	5/16 x 3/4 Capscrew 2223	5/16 x 1 Capscrew 2225	5/16 x 1-1/4 Capscrew 2226	5/16 x 1-1/2 Capscrew 2227	5/16 x 2 Capscrew 2229
3/8-24 Hex Nut 4112	3/8 Med LW 7107	3/8 USS FW 7065	3/8 x 1 Capscrew 2245	3/8 x 1-1/4 Capscrew 2246	3/8 x 1-1/2 Capscrew 2247	3/8 x 2 Capscrew 2249	3/8 x 2-1/2 Capscrew 2251
7/16-20 Hex Nut 4113	5/16 Med LW 7108	7/16 USS FW 7066	7/16 x 1 Capscrew 2264	7/16 x 1-1/4 Capscrew 2265	7/16 x 1-1/2 Capscrew 2266	7/16 x 2 Capscrew 2268	7/16 x 2-1/2 Capscrew 2270
1/2-20 Hex Nut 4114	1/2 Med LW 7109	1/2 USS FW 7067	1/2 x 1 Capscrew 2283	1/2 x 1-1/4 Capscrew 2284	1/2 x 1-1/2 Capscrew 2285	1/2 x 2 Capscrew 2287	1/2 x 2-1/2 Capscrew 2289

IBS, INCORPORATED

Grade 8 Flange Bolts A10



Grade 8 Flange Bolts

GENERAL INFORMATION

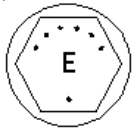

Flange Bolt Head Marking

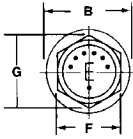

E Size	F WAF*	G WAC*	B Flange Diam.	K Flange Thickness	H Height	H ₁ Hex Height	L _t Thread Length
3/8	9/16	0.65	0.81	0.06	0.39	0.25	1.00
1/2	3/4	0.87	1.07	0.08	0.51	0.34	1.25
5/8	15/16	1.08	1.33	0.10	0.62	0.42	1.50
3/4	1-1/8	1.29	1.59	0.11	0.73	0.51	1.75

WAF - width across flats; WAC = width across corners

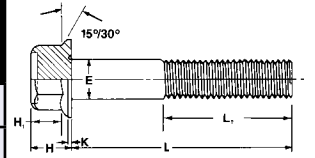

Flanged Fastener Advantages

GREATER BEARING AREA

Flange screws have about four times the bearing area of hex screws. This means that clamp loads are distributed over a larger surface, reducing the possibility of the fastener brinelling into the bearing area and thus becoming loose. Comparison is based on minimum bearing areas as specified by ANSI Standard B18.2 Hex Cap Screws and IFI Standard 111 Hex Flange Screws.

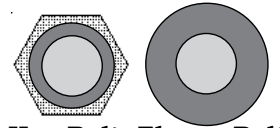

Hex Bolt Flange Bolt
Darker area is the bearing surface. The flange bolt has 4 times the bearing area of the hex bolt.

Better Coverage of Irregular Holes Lower Bearing Stress

Flange screws offer superior coverage and lower bearing stress for irregular holes. For example: with an 11/16" hole elongated 1/8", a 5/8" dia. flange screw offers seven times the bearing area of a 5/8" dia. hex screw, with much lower stress on the bearing area. Comparisons based on SAE Grade 8 screws tightened to a clamp load of 20,300 lbs., and SAE Grade 5 screws tightened to a clamp load of 14,400 lbs.



5/8" FLANGED SCREW

1.1882 sq. in. Fastener Diam. Area
 - .4572 sq. in. - Hole Area
 .7310 sq. in. Bearing Area



5/8" HEX SCREW

.5599 sq. in.
 - .4572 sq. in.
 .1027 sq. in.

Flanged Screw has 7 times the Bearing Area of the Hex Screw.

Bearing Area

27,800 psi Bearing Area Stress (Grade 8) 198,000 psi
 19,700 psi Bearing Area Stress (Grade 5) 140,000 psi

Bearing Stress on the Flanged Screw is 7 times less than the Hex Screw.

Elimination of Washers

There are no separate washers to handle and install. That speeds assembly rates. You don't have to worry about washers failing or being forgotten. And, often, you can use shorter length screws.

Weight and Size Reduction

The added rigidity of a flange may allow the use of smaller, lighter nuts.

During final tightening the screw stretches and the nut bearing face tends to dilate, creating above average loads in the nut threads adjacent to the bearing area. If the joint is subject to severe overload, or if too low a grade nut is used, progressive thread shear can occur. Flange nuts, with their added mass at the bearing area, resist this tendency to dilate. This feature can permit the use of smaller across flats nuts with weight reduction savings up to 49%. This is true of both free-running and prevailing torque flange locknuts.

C
A
P
S
C
R
E
W
S



IBS, INCORPORATED

Grade 8 Flange Bolts A10

USS Grade 8 Flange Bolts

NATIONAL COARSE



Length	1/4-20 P/N	Qty	5/16-18 P/N	Qty	3/8-16 P/N	Qty	1/2-13 P/N	Qty	5/8-11 P/N	Qty	3/4-10 P/N	Qty	Length
3/4	3110	25	3120	25	—	—	—	—	—	—	—	—	3/4
1	3111	25	3121	25	3200	25	—	—	—	—	—	—	1
1-1/4	3112	25	3122	25	3201	25	3210	25	3220	25	—	—	1-1/4
1-1/2	3113	25	3123	25	3202	25	3211	25	3221	25	—	—	1-1/2
1-3/4	3114	25	3124	25	3203	25	3212	25	3222	25	—	—	1-3/4
2	3115	25	3125	25	3204	25	3213	25	3223	25	3230	20	2
2-1/4	—	—	—	—	—	—	3214	25	3224	25	3231	20	2-1/4
2-1/2	3116	25	3126	25	3206	25	3215	25	3225	25	3232	20	2-1/2
2-3/4	—	—	—	—	—	—	3140	25	3226	25	—	—	2-3/4
3	3117	25	3127	25	3130	25	3217	25	3227	25	3180	10	3
3-1/2	—	—	—	—	3131	10	3141	10	3229	25	3181	5	3-1/2
4	—	—	—	—	3132	10	3142	10	3160	10	3182	5	4
4-1/2	—	—	—	—	—	—	3143	10	3161	10	3183	2	4-1/2
5	—	—	—	—	—	—	3144	10	3162	10	3184	2	5

SAE Grade 8 Flange Bolts

NATIONAL FINE



Length	1/2-20 P/N	Qty	5/8-18 P/N	Qty	3/4-16 P/N	Qty	Length
1-1/2	3234	25	3291	25	—	—	1-1/2
1-3/4	3236	25	3292	25	—	—	1-3/4
2	3237	25	3293	25	3297	20	2
2-1/4	3237A	25	3170	10	—	—	2-1/4
2-1/2	3238	25	3294	25	3299	20	2-1/2
2-3/4	3150	25	3171	10	—	—	2-3/4
3	3151	25	3172	10	3190	10	3
3-1/2	3152	10	3173	10	—	—	3-1/2
4	3153	10	3174	10	3191	5	4
4-1/2	3154	10	3175	10	—	—	4-1/2
5	3155	10	3176	10	3192	2	5

C
A
P
S
C
R
E
W
S

Grade 8 Flange Bolt

Assortment

IBS No. 811R • 15 ITEMS • 405
PIECES

IBS, Inc. SPECIALTY PRODUCTS FOR MAINTENANCE & REPAIR INDUSTRIALBOLT.COM © 2012 800-870-1000					Hex Flange Bolts
					Assortment No. 811R
3198 1/4-20 FLANGE LOCK NUT GR.G PLN	3110 1/4-20 X 3/4 GR8 HEX FLANGE BOLT PLN	3111 1/4-20 X 1 GR8 HEX FLANGE BOLT PLN	3112 1/4-20 X 1-1/4 GR8 HEX FLANGE BOLT PLN	3113 1/4-20 X 1-1/2 GR8 HEX FLANGE BOLT PLN	
3199 5/16-18 FLANGE LOCK NUT GR.G PLN	3120 5/16-18 X 3/4 GR8 HEX FLANGE BOLT PLN	3121 5/16-18 X 1 GR8 HEX FLANGE BOLT PLN	3122 5/16-18 X 1-1/4 GR8 HEX FLANGE BOLT PLN	3123 5/16-18 X 1-1/2 GR8 HEX FLANGE BOLT PLN	
4000 3/8-16 FLANGE LOCK NUT GR.G PLN	3200 3/8-16 X 1 GR8 HEX FLANGE BOLT PLN	3201 3/8-16 X 1-1/4 GR8 HEX FLANGE BOLT PLN	3202 3/8-16 X 1-1/2 GR8 HEX FLANGE BOLT PLN	3204 3/8-16 X 2 GR8 HEX FLANGE BOLT PLN	



Hex Nuts

A

Assortments

- Machine Screw Sized Nuts & Washers B-2
- Miscellaneous Nuts
 - Machine Screw Nuts, Wing Nuts & Cap Nuts Assortmen B-2

F

Fasteners

- Cap Nuts B-10
- Coupling Nuts B-11
- Flange Nuts
 - Stover B-5
- Heavy Hex Nuts B-10
- Hex Jam Nuts B-9
- Hex Nuts
 - Finished B-7
 - Grade 5 B-6
 - Grade 8, Finished B-6
 - Hi-Alloy B-3
- High Nuts
 - Grade 8 B-10
- Kep Nuts B-10
- Lock Nuts, Hi-Alloy
 - Coarse B-4
- Machine Screw Nuts B-10
- Nyloc Jam Nuts B-9
- Nylon Locknuts
 - Grade 5, Zinc Plated B-8
 - Grade 8, Plain B-8
 - Grade 8, Zinc Yellow B-8
- “Tee” Nuts B-11
- Torque Locknuts
 - Grade C B-5
- Whiz Lock Nuts B-10
- Wing Nut - Nyloc B-11
- Wing Nuts B-11

N

Nuts, Flange

- Stover B-5

Nuts, Hex B-3

- Finished
 - Grade 5 B-6
 - Grade 8 B-6
 - Zinc Plated B-7
- Grade 8
 - High Nuts B-10
- Heavy B-10
- High-Alloy B-3

Nuts, Lock

- Grade C B-5
- High-Alloy N.C. B-4
- Nylon, Grade 5
 - Zinc Plated B-8
- Nylon, Grade 8
 - Plain B-8
 - Zinc Yellow B-8

Nuts, Miscellaneous

- Cap B-10
- Coupling B-11
- Jam
 - Hex B-9
 - Nyloc B-9
- Kep B-10
- Machine Screw B-10
- Tee B-11
- Whiz Lock B-10
- Wing B-11
- Wing Nut
 - Nyloc B-11



IBS, INCORPORATED

High-Alloy Hex Nuts B01 & B03



High-Alloy Hex Nuts (B01)

NATIONAL COARSE & NATIONAL FINE

- Cadmium-plated and dichromate-coated to improve lubrication for controlled tightening.
- 20% stronger than SAE Grade 8!
- Use of special alloys and heat treatments reduces the danger of split nuts and stripping of nuts.

Top View



Side View

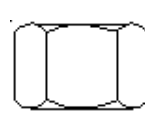

L9 HT Hex Nut



NATIONAL COARSE

IBS No.	Tap Size	WAF	Thickness	Qty
NT5202	1/4-20	7/16	1/4	100
NT5204	5/16-18	1/2	19/64	50
NT5206	3/8-16	9/16	3/8	50
NT5208	7/16-14	11/16	7/16	25
NT5212	1/2-13	3/4	1/2	25
NT5214	9/16-12	7/8	9/16	25
NT5216	5/8-11	15/16	41/64	25
NT5218	3/4-10	1-1/8	3/4	20
NT5220	7/8-9	1-5/16	7/8	15
NT5222	1-8	1-1/2	1	10
NT5226	1-1/8-7	1-11/16	1-5/32	EA
NT5228	1-1/4-7	1-7/8	1-17/64	EA
NT5232	1-1/2-6	2-1/4	1-1/2	EA

NATIONAL FINE

IBS No.	Tap Size	WAF	Thickness	Qty
NT5252	1/4-28	7/16	1/4	100
NT5254	5/16-24	1/2	19/64	100
NT5256	3/8-24	9/16	3/8	50
NT5258	7/16-20	11/16	7/16	50
NT5262	1/2-20	3/4	1/2	25
NT5264	9/16-18	7/8	9/16	25
NT5266	5/8-18	15/16	41/64	25
NT5268	3/4-16	1-1/8	3/4	20
NT5270	7/8-14	1-5/16	7/8	15
NT5272	1-14	1-1/2	1	10
NT5276	1-1/8-12	1-11/16	1-5/32	EA
NT5278	1-1/4-12	1-7/8	1-17/64	EA
NT5282	1-1/2-12	2-1/4	1-1/2	EA

HEX NUTS



High-Alloy Lock Nuts (B03)

National Coarse & National Fine

- Cadmium plated and dichromate coated - ensures uniform tightening
- Inhibits loosening caused by vibration
- Reduced danger of split or stripped nuts

Top View

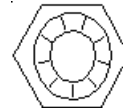

Side View

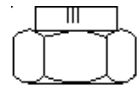

Nine dashes identify Heat Treated L9 Stover® locknuts. Features registered stover design.

L9 STOVER NATIONAL COARSE

IBS No.	Tap Size	W.A.F.	Thickness	Qty
NT9403	1/4-20	7/16	1/4	100
NT9405	5/16-18	1/2	19/64	50
NT9407	3/8-16	9/16	3/8	50
NT9409	7/16-14	11/16	7/16	25
NT9413	1/2-13	3/4	1/2	25
NT9415	9/16-12	7/8	9/16	25
NT9417	5/8-11	15/16	41/64	25
NT9419	3/4-10	1-1/8	3/4	20
NT9421	7/8-9	1-5/16	7/8	15
NT9423	1-8	1-1/2	1	10
NT9427	1-1/8-7	1-11/16	1-5/32	EA
NT9429	1-1/4-7	1-7/8	1-17/64	EA
NT9433	1-1/2-6	2-1/4	1-1/2	EA

L9 STOVER NATIONAL FINE

IBS No.	Tap Size	W.A.F.	Thickness	Qty
NT9453	1/4-28	7/16	1/4	100
NT9455	5/16-24	1/2	19/64	50
NT9457	3/8-24	9/16	3/8	50
NT9459	7/16-20	11/16	7/16	25
NT9463	1/2-20	3/4	1/2	25
NT9465	9/16-18	7/8	9/16	25
NT9467	5/8-18	15/16	41/64	25
NT9469	3/4-16	1-1/8	3/4	20
NT9471	7/8-14	1-5/16	7/8	15
NT9473	1-14	1-1/2	1	10
NT9477	1-1/8-12	1-11/16	1-5/32	EA
NT9479	1-1/4-12	1-7/8	1-17/64	EA
NT9483	1-1/2-12	2-1/4	1-1/2	EA

THE HIGH-ALLOY FASTENING SYSTEM IS DESIGNED AND MANUFACTURED TO BE USED AS A SYSTEM. NO SUBSTITUTIONS OR ALTERATIONS ARE TO BE MADE OF THE BOLT, NUT, WASHER OR FINISH.

IBS, INCORPORATED

Grade C Lock Nuts B07 & Stover Flange Nuts B05



Grade C Prevailing Torque Locknuts

Strongest locking power available

Ideal for applications where shock and vibration is a problem



This patented, prevailing torque locknut gets its exceptionally high locking ability from the controlled deformation of its upper threads. The design is unique in that it features a true round shape at the bearing face, which allows for easier starting, and changes to an oval shape at the top. As the nut is tightened the deformed top threads are deflected, causing them to conform to the shape of the screw. This creates an increased frictional drag and results in increased locking power.

The Spring Action (top threads conforming to the screw shape) distributes the clamping forces over the largest possible surface area. This ensures minimum wear, burnishing, and avoids permanent set. This balanced design is what provides the locknut with its high performance and reusability qualities.

NATIONAL COARSE

IBS No.	Size	W.A.F.	Qty
4026	1/4-20	7/16	100
4027	5/16-18	1/2	100
4028	3/8-16	9/16	100
4029	7/16-14	11/16	100
4030	1/2-13	3/4	50
4031	9/16-12	7/8	50
4032	5/8-11	15/16	25
4033	3/4-10	1-1/8	20
4034	7/8-9	1-5/16	15
4035	1-8	1-1/2	10

NATIONAL FINE

IBS No.	Size	W.A.F.	Qty
6035	1/4-28	7/16	100
6036	5/16-24	1/2	100
6037	3/8-24	9/16	100
6038	7/16-20	11/16	100
6039	1/2-20	3/4	50
6040	9/16-18	7/8	50
6041	5/8-18	15/16	25
6042	3/4-16	1-1/8	20
6043	7/8-14	1-5/16	15
6044	1-14	1-1/2	10

Stover Flange Lock Nuts

GRADE G — 150,000 PSI TENSILE STRENGTH

- Top crimp with a built-in washer provides wider clamping area
- Nut must be wrenched into place
- Used in high-vibration applications (truck frames)
- Proof load strength of 150,000 psi min
- Rockwell Hardness: 1/4" to 5/8": Rc 24/32; 3/4" and larger: Rc 26/34
- Sizes range from 1/4" to 1"
- Meets ASME B18.16.6 (IFI 100/107) standards



IBS No.	Size	C W.A.F.	F Flange Diam	D Overall Thickness	B Hex Height	K Flange Thickness	Qty
3198	1/4-20	7/16	0.560	.0.300	0.140	0.040	100
3199	5/16-18	1/2	0.680	0.365	0.170	0.050	100
4000	3/8-16	9/16	0.810	0.425	0.200	0.060	100
4001	1/2-13	3/4	1.070	0.555	0.260	0.080	50
4002	5/8-11	15/16	1.330	0.690	0.320	0.100	25
4003	3/4-10	1-1/8	1.585	0.750	0.380	0.110	25
4007	1/2-20	3/4	1.070	0.555	0.260	0.080	50
4008	5/8-18	15/16	1.330	0.690	0.320	0.100	25
4009	3/4-16	1-1/8	1.563	0.750	0.594	0.156	20

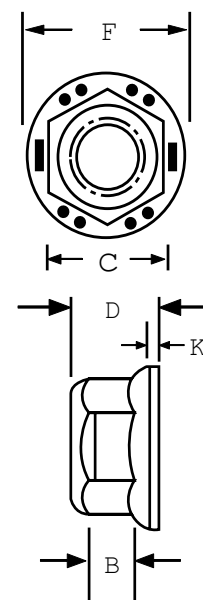

HEX NUTS



IBS, INCORPORATED

Finished Hex Nuts Zinc Plated

Grade 8 Finished Hex Nuts (B06)

150,000 PSI MINIMUM TENSILE STRENGTH

- Exceeds original equipment specifications.
- Made of High Strength Alloy Steel giving them 30% more holding power.
- Eliminates stripping threads, vibration, heat and stress fatigue.
- Plated nuts are Zinc and Yellow Baked.



NATIONAL COARSE

IBS No.		Size	W.A.F.	Qty
Plain	Plated			
4010	4610	1/4-20	7/16	100
4011	4611	5/16-18	1/2	100
4012	4612	3/8-16	9/16	100
4013	4613	7/16-14	11/16	100
4014	4614	1/2-13	3/4	100
4015	4615	9/16-12	7/8	50
4016	4616	5/8-11	15/16	50
4017	4617	3/4-10	1-1/8	25
4018	4618	7/8-9	1-5/16	25
4019	4619	1-8	1-1/2	20
4020	—	1-1/8-7	1-11/16	EA
4021	—	1-1/4-7	1-7/8	EA
4023	—	1-1/2-6	2-1/4	EA

NATIONAL FINE

IBS No.		Size	W.A.F.	Qty
Plain	Plated			
6021	6640	1/4-28	7/16	100
6022	6641	5/16-24	1/2	100
6023	6642	3/8-24	9/16	100
6024	6643	7/16-20	11/16	100
6025	6644	1/2-20	3/4	100
6026	6645	9/16-18	7/8	25
6027	6646	5/8-18	15/16	50
6028	6647	3/4-16	1-1/8	25
6029	6648	7/8-14	1-5/16	25
6030	6649	1-14	1-1/2	20
6031	—	1-1/8-12	1-11/16	EA
6032	—	1-1/4-12	1-7/8	EA
—	—	—	—	—

HEX NUTS

Grade 5 Hex Nuts (B10)

- Proof Load 120,000 psi.
- Hardness HRB 86-93.
- Zinc Plated to protect against corrosion.
- Manufactured and Tested according to AISI Specifications.



NATIONAL COARSE

IBS No.	Size	W.A.F.	Qty
4100	1/4-20	7/16	100
4101	5/16-18	1/2	100
4102	3/8-16	9/16	100
4103	7/16-14	11/16	100
4104	1/2-13	3/4	100
4105	9/16-12	7/8	50
4106	5/8-11	15/16	50
4107	3/4-10	1-1/8	25
4108	7/8-9	1-5/16	25
4109	1 - 8	1-1/2	10

NATIONAL FINE

IBS No.	Size	W.A.F.	Qty
4110	1/4-28	7/16	100
4111	5/16-24	1/2	100
4112	3/8-24	9/16	100
4113	7/16-20	11/16	100
4114	1/2-20	3/4	100
4115	9/16-18	7/8	50
4116	5/8-18	15/16	50
4117	3/4-16	1-1/8	25
4118	7/8-14	1-5/16	25
4119	1 - 14	1-1/2	10

IBS, INCORPORATED

Finished Hex Nuts Zinc Plated



Finished Hex Nuts (B09)

- Specially formulated high quality nut steel manufactured on the most modern close tolerance cold forming equipment.
- Dependability insured by strict quality control.
- Zinc plating protects against rust and corrosion.



NATIONAL COARSE

IBS No.	Size	W.A.F.	Qty
4050	1/4-20	7/16	100
4051	5/16-18	1/2	100
4052	3/8-16	9/16	100
4053	7/16-14	11/16	100
4054	1/2-13	3/4	100
4055	9/16-12	7/8	50
4056	5/8-11	15/16	50
4057	3/4-10	1-1/8	25
4058	7/8-9	1-5/16	25
4059	1-8	1-1/2	10
4060	1-1/8-7	1-11/16	EA
4061	1-1/4-7	1-7/8	EA
4063	1-1/2-6	2-1/4	EA

NATIONAL FINE

IBS No.	Size	W.A.F.	Qty
6074	1/4-28	7/16	100
6075	5/16-24	1/2	100
6076	3/8-24	9/16	100
6077	7/16-20	11/16	100
6078	1/2-20	3/4	100
6079	9/16-18	7/8	25
6080	5/8-18	15/16	25
6081	3/4-16	1-1/8	25
6082	7/8-14	1-5/16	25
6083	1-14	1-1/2	10

H
E
X

N
U
T
S



IBS, INCORPORATED

Nylon Locknuts

Grade 8 Nylon Locknuts (B08)

The locking collar, which has an inside diameter smaller than the diameter of the bolt, is un-threaded and elastic. This allows the bolt to impress a mating thread into the collar and the resulting compressive forces exert a constant friction grip on the bolt. As downward thrust is exerted the lower flanks of the bolt thread are brought into a firm metal-to-metal contact with the matching threads on the nut thus eliminating axial play which may normally occur. Even after repeated usage the elastic collar still retains its grip.



- Locks in any position on the bolt.
- Vibration and shock proof.
- Locking collar will not gall bolt thread.
- Nylon seals out moisture and retards rust and corrosion of the thread area.
- This material is resistant to oil, fats, gasoline, and other destructive chemical agents.

NATIONAL COARSE

IBS No.		Dimensions			
Plain (Black)	Zinc Yellow	Tap Size	W.A.F.	Ht.	Qty
4040	4140	1/4-20	7/16	5/16	25
4041	4141	5/16-18	1/2	11/32	25
4042	4142	3/8-16	9/16	29/64	25
4043	4143	7/16-14	5/8	29/64	25
4044	4144	1/2-13	3/4	19/32	25
4045	4145	9/16-12	7/8	41/64	10
4046	4146	5/8-11	15/16	3/4	10
4047	4147	3/4-10	1-1/16	7/8	10
4048	4148	7/8-9	1-1/4	63/64	5
4049	4149	1-8	1-7/16	1-3/64	5

NATIONAL FINE

IBS No.		Description			
Plain (Black)	Zinc Yellow	Tap Size	W.A.F.	Ht.	Qty
6049	6249	1/4-28	7/16	5/16	25
6050	6250	5/16-24	1/2	11/32	25
6051	6251	3/8-24	9/16	29/64	25
6052	6252	7/16-20	5/8	29/64	25
6053	6253	1/2-20	3/4	19/32	25
6054	6254	9/16-18	7/8	41/64	10
6055	6255	5/8-18	15/16	3/4	10
6056	6256	3/4-16	1-1/16	7/8	10
6057	6257	7/8-14	1-1/4	63/64	5
6058	6258	1-14	1-7/16	1-3/64	5

HEX NUTS

Grade 2 Nylon Locknuts (B12)

Zinc Plated



NATIONAL COARSE

IBS No.	Tap Size	W.A.F.	Ht.	Qty
5000	4-40	1/4	5/32	100
5001	6-32	5/16	11/64	100
5002	8-32	11/32	7/32	100
5003	10-24	3/8	15/64	100
5003A	12-24	7/16	5/16	100
5004	1/4-20	7/16	5/16	100
5005	5/16-18	1/2	11/32	100
5006	3/8-16	9/16	29/64	100
5007	7/16-14	5/8	29/64	100
5008	1/2-13	3/4	19/32	50
5009	9/16-12	7/8	41/64	50
5010	5/8-11	15/16	3/4	25
5011	3/4-10	1-1/16	7/8	25
5012	7/8-9	1-1/4	63/64	25
5013	1-8	1-7/16	1-3/64	10

NATIONAL FINE

IBS No.	Tap Size	W.A.F.	Ht.	Qty
—	—	—	—	—
—	—	—	—	—
—	—	—	—	—
6099	10-32	3/8	15/64	100
—	—	—	—	—
6100	1/4-28	7/16	5/16	100
6101	5/16-24	1/2	11/32	100
6102	3/8-24	9/16	29/64	100
6103	7/16-20	5/8	29/64	100
6104	1/2-20	3/4	19/32	50
6105	9/16-18	7/8	41/64	50
6106	5/8-18	15/16	3/4	25
6107	3/4-16	1-1/16	7/8	25
6108	7/8-14	1-1/4	63/64	25
6109	1-14	1-7/16	1-3/64	10

IBS, INCORPORATED

Miscellaneous Nuts B35



Hex Jam Nuts

- Jam nuts are thin nuts used under full-sized nuts to develop locking action.
- Zinc plated to protect against rust and corrosion.



NATIONAL COARSE

IBS No.	Tap Size	WAF	Thickness	Qty
4085	1/4-20	7/16	5/32	100
4086	5/16-18	1/2	3/16	100
4087	3/8-16	9/16	7/32	100
4088	7/16-14	11/16	1/4	50
4089	1/2-13	3/4	5/16	50
4090	5/8-11	15/16	3/8	25
4091	3/4-10	1-1/8	27/64	25

NATIONAL FINE

IBS No.	Tap Size	WAF	Thickness	Qty
6085	1/4-28	7/16	5/32	100
6086	5/16-24	1/2	3/16	100
6087	3/8-24	9/16	7/32	100
6088	7/16-20	11/16	1/4	50
6089	1/2-20	3/4	5/16	50
6091	5/8-18	15/16	3/8	25
6092	3/4-16	1-1/8	27/64	25

Nyloc Jam Nuts

- Thin jam nuts with nylon locking rings
- Lock in any position on bolt
- Zinc plated to prevent rust and corrosion



NATIONAL COARSE

IBS No.	Tap Size	WAF	Thickness	Qty
5020	1/4-20	7/16	3/16	100
5021	5/16-18	1/2	1/4	100
5022	3/8-16	9/16	17/64	100
5024	1/2-13	3/4	5/16	50
5026	5/8-11	15/16	3/8	50
5027	3/4-10	1-1/8	13/32	25

NATIONAL FINE

IBS No.	Tap Size	WAF	Thickness	Qty
6114	1/4-28	7/16	3/16	100
6115	5/16-24	1/2	1/4	100
6116	3/8-24	9/16	17/64	100
6118	1/2-20	3/4	5/16	50
6120	5/8-18	15/16	3/8	50
6121	3/4-16	1-1/8	13/32	25

Machine Screw Nuts

**MEETS OR EXCEEDS
AMERICAN STANDARD B18.6.3**

ZINC PLATED FOR CORROSION RESISTANCE



IBS No.	Tap Size	WAF	Thickness	Pkg Qty
5032	4-40	1/4	3/32	200
5033	6-32	5/16	7/64	200
5034	8-32	11/32	1/8	200
5035	10-24	3/8	1/8	200
5036	10-32	3/8	1/8	200
5037	12-24	7/16	5/32	200
5038	1/4-20	7/16	3/16	100
5039	5/16-18	1/2	7/32	100

Heavy Hex Nuts

- Heavier and wider to provide greater bearing area.
- Ideal for heavy duty applications with severe stress and vibration.
- Excellent for oversize holes and certain boiler applications.
- Conforms to all industry standards



IBS No.	Tap Size	W.A.F.	Height	Pkg Qty
4070	1/4-20	1/2	13/64	100
4071	5/16-18	9/16	19/64	100
4072	3/8-16	11/16	23/64	100
4073	7/16-14	3/4	27/64	50
4074	1/2-13	7/8	31/64	50
4076	5/8-11	1-1/16	39/64	25
4077	3/4-10	1-1/4	47/64	25
4078	7/8-9	1-7/16	55/64	25
4079	1-8	1-5/8	63/64	25

HEX NUTS



IBS, INCORPORATED

Machine Screw Nuts B14 / Misc. Nuts B35

Cap Nuts

NICKEL PLATED



IBS No.	Tap Size	Pkg Qty
5075	6-32	100
5076	8-32	100
5077	10-24	100
5079	1/4-20	100
5080	5/16-18	100
5081	3/8-16	50

Whiz Lock Nuts

- Serrated flange provides locking action



IBS No.	Tap Size	Flange O.D.	Pkg Qty
5066	10-24		100
5068	1/4-20	19/32	100
5069	5/16-18	43/64	100
5070	3/8-16	3/4	100

High Nuts Grade 8

150,000 PSI MIN. TENSILE STRENGTH

- Special design gives added strength.
- 40% More thread engagement.
- 40% Higher than ordinary nuts.



IBS No.	Tap Size	W.A.F.	Height	Pkg Qty
6063	7/16-20	5/8	17/32	50
6064	1/2-20	3/4	11/16	50
6066	5/8-18	15/16	27/32	25
6067	3/4-16	1-1/16	1	25
6068	7/8-14	1-1/4	1-5/32	10
6069	1-14	1-7/16	1-5/16	10

Coupling Nuts

- Zinc plated to protect against rust and corrosion



IBS No.	Tap Size	Length	W.A.F.	Pkg Qty
6011 *	1/4-20	7/8	3/8	50
6012 *	5/16-18	7/8	7/16	50
6013 *	3/8-16	1-1/8	1/2	50
6014 *	1/2-13	1-1/4	5/8	50
6015	5/8-11	2-1/8	13/16	20
6016	3/4-10	2-1/4	3/4	20

* Economy - shorter in length than standard units

Keop Nuts



- Combination standard hex nuts and standard lockwasher.
- Eliminates putting separate lockwasher in position.
- Lockwasher spins free under tension, preventing surface marring or galling.

IBS No.	Tap Size	WAF	Thickness	Pkg Qty
5056	6-32	5/16	7/64	100
5057	8-32	11/32	1/8	100
5058	10-24	3/8	1/8	100
5059	10-32	3/8	1/8	100
5060	1/4-20	7/16	3/16	100
5061	5/16-18	1/2	17/64	100
5062	3/8-16	9/16	3/8	100

Wing Nuts



- Cold forged steel.
- Zinc plated for protection from rust and
- Ideal for applications where quick hand assembly is desired or needed, i.e.:
 - Light or precision machinery: eliminates the chance of over-tightening, causing thread stripping or parts damage.
 - Power Tools: circular saw blade angle adjustment.
 - Carburetor Air Filter Hold Down Nut and more!

IBS No.	Tap Size	Pkg Qty
5086	8-32	100
5087	10-24	100
5088	10-32	100
5089	1/4-20	100
5090	5/16-18	100
5091	3/8-16	100
5092	1/2-13	50

Wing Nut - Nyloc

- Zinc Plated to protect against rust and corrosion.
- Nylon locking ring locks in any position on bolt.
- Locking collar will not gall bolt thread or remove plating.
- Vibration and shock proof.

IBS No.	Size	Pkg Qty
5095	3/8-16	25



HEX NUTS

IBS, INCORPORATED

Miscellaneous Nuts B35



“Tee” Nuts

3 Prong - Wood Type



- Pronged nut stays where it's put.
- Zinc plated for protection from rust and corrosion.
- Great for picnic tables and wooden lawn furniture.

IBS No.	Tap Size	Barrel	Flange	Pkg Qty
6000	6-32	1/4	9/16	100
6001	8-32	1/4	3/4	100
6002	10-24	5/16	23/32	100
6004	1/4-20	7/16	25/32	100
6006	3/8-16	7/16	1-1/16	100

Machine Screw Nuts, Wing Nuts & Cap Nuts (A02)

IBS No. 126R • 18 Items - 1225 Pcs.

IBS, Inc. SPECIALTY PRODUCTS FOR MAINTENANCE & REPAIR INDUSTRIALDOLY.COM © 2008 800-878-1906		Machine Screw Nuts, Wing Nuts & Cap Nuts		
Assortment No. 126R				
5076 8-32 CAP NUT ZP 	5032 4-40 HEX MACHINE SCREW NUT ZP 	5036 10-32 HEX MACHINE SCREW NUT ZP 	5086 8-32 WING NUT ZP 	5089 1/4-20 WING NUT ZP
5077 10-24 CAP NUT ZP 	5033 6-32 HEX MACHINE SCREW NUT ZP 	5037 12-24 HEX MACHINE SCREW NUT ZP 	5087 10-24 WING NUT ZP 	5090 5/16-18 WING NUT ZP
5079 1/4-20 CAP NUT NP 	5034 8-32 HEX MACHINE SCREW NUT ZP 	5038 1/4-20 HEX MACHINE SCREW NUT 	5088 10-32 WING NUT ZP 	5091 3/8-16 WING NUT ZP
5080 5/16-18 CAP NUT NP 	5035 10-24 HEX MACHINE SCREW NUT ZP 	5039 5/16-18 HEX MACHINE SCREW NUT 		

Machine Screw Sized Nuts & Washers (A02)

IBS No. 392R • 20 Items • 2600 Pcs

IBS, Inc. SPECIALTY PRODUCTS FOR MAINTENANCE & REPAIR INDUSTRIALDOLY.COM © 2008 800-878-1906		Machine Screw Nuts & Washers			
Assortment No. 392R					
7100 #4 MEDIUM LOCKWASHER ZP 	7101 #6 MEDIUM LOCKWASHER ZP 	7102 #8 MEDIUM LOCKWASHER ZP 	7103 #10 MEDIUM LOCKWASHER ZP 	7104 #12 MEDIUM LOCKWASHER ZP 	7105 1/4 MEDIUM LOCKWASHER ZP
7044 #4 SAE FLAT WASHER ZP 	7045 #6 SAE FLAT WASHER ZP 	7046 #8 SAE FLAT WASHER ZP 	7047 #10 SAE FLAT WASHER ZP 	7048 #12 SAE FLAT WASHER ZP 	7049 1/4 SAE FLAT WASHER ZP
5032 4-40 HEX MACHINE SCREW NUT ZP 	5033 6-32 HEX MACHINE SCREW NUT ZP 	5034 8-32 HEX MACHINE SCREW NUT ZP 	5035 10-24 HEX MACHINE SCREW NUT ZP 	5036 10-32 HEX MACHINE SCREW NUT ZP 	5038 1/4-20 HEX MACHINE SCREW NUT
5037 12-24 HEX MACHINE SCREW NUT ZP 	5001 6-32 NYLOC NUT ZP 	5002 8-32 NYLOC NUT ZP 	5003 10-24 NYLOC NUT ZP 	6099 10-32 NYLOC NUT ZP 	5004 1/4-20 NYLOC NUT ZP

HEX NUTS



H
E
X
N
U
T
S



Washers

A

Assortments

- Flat Washer
 - Copper C-9
 - Fender Washer C-7
 - Heavy Duty C-4
- Lock Washer
 - Internal & External Star Washer C-8
 - Sur-Lock Vibration-Resistant Washers C-6

B

Back-Up Washers

- Aluminum Round C-8

F

Fasteners

- Washers, Flat
 - Copper C-9
 - Fender C-7
 - Finishing C-8
 - Heat Treated SAE C-2
 - Heat Treated USS C-3
 - Heavy Duty C-4
 - Hi-Alloy C-2
- Washers, Lock
 - Alloy C-6
 - High Collar C-6
 - Internal & External Tooth C-8
 - Medium C-6
 - Sur-Lock Washers C-5

G

Gaskets

- Drain Plug C-9

W

Washers, Flat

- Copper C-9
- Fender C-7
- Finishing C-8
- Heat Treated, SAE - Plain & Plated C-2, C-3
- Heavy Duty C-4
- High-Alloy C-2
- Standard
 - USS C-3

Washers, Lock

- Alloy C-6
- External Tooth C-8
- High Collar C-6
- Internal Tooth C-8
- Medium C-6
- Sur-Lock Washers C-5



IBS, INCORPORATED

Washers C01, C02 & C05

High-Alloy Washers (C01)

- Thicker than standard washers to prevent cupping and dishing and to assure a consistent clamp load.
- Special high-alloy hardened material minimizes crushing of bearing surfaces.
- Zinc Yellow Per ASTM B633 plated to resist corrosion & assist torquing.
- Heat treated to Rockwell "C" 40-45.
- Provides smooth bearing surfaces and uniform load distribution to reduce brinelling.



SAE HIGH-ALLOY FLAT WASHERS

IBS No.	Size	I.D.	O.D.	Thick	Qty
7400	1/4	9/32	5/8	.056 / .071	100
7401	5/16	11/32	11/16	.056 / .071	100
7402	3/8	13/32	13/16	.090 / .112	100
7403	7/16	15/32	59/64	.090 / .112	50
7404	1/2	17/32	1-1/16	.090 / .112	50
7405	9/16	19/32	1-11/64	.090 / .112	25
7406	5/8	21/32	1-5/16	.146 / .174	25
7407	3/4	13/16	1-15/32	.146 / .174	20
7408	7/8	15/16	1-3/4	.146 / .174	15
7409	1	1-1/16	2	.146 / .174	10



USS HIGH-ALLOY FLAT WASHERS

IBS No.	Size	I.D.	O.D.	Thick	Qty
7016	1/4	17/64	3/4	.065 / .080	100
7017	5/16	21/64	7/8	.079 / .093	100
7018	3/8	25/64	1	.079 / .093	100
7019	7/16	29/64	1-1/4	.090 / .106	50
7020	1/2	17/32	1-3/8	.122 / .146	50
7021	9/16	19/32	1-1/2	.122 / .146	25
7022	5/8	41/64	1-3/4	.136 / .160	25
7023	3/4	25/32	2	.136 / .160	20
7024	7/8	57/64	2-1/4	.136 / .160	15
7025	1	1-3/32	2-1/2	.136 / .160	10

THE HIGH-ALLOY FASTENING SYSTEM IS DESIGNED AND MANUFACTURED TO BE USED AS A SYSTEM. NO SUBSTITUTIONS OR ALTERATIONS ARE TO BE MADE OF THE BOLT, NUT, WASHER OR FINISH.

Heat Treated SAE Flat Washers (C02 & C05)

- Meets S.A.E. close tolerance specifications.
- Eliminates common washer failures such as dishing, bellying or cracking.
- Through hardened (quenched & tempered) to R/C 38-45.
- Made of heat treated alloy.
- Controlled ductility to eliminate cracking and splitting.
- Maximum strength for use with all grades of cap screws.
- Plated washers are Zinc (Standard) and Yellow Baked (Heat Treated).



HEAT TREATED SAE FLAT WASHERS (C02)

IBS No.	Zinc Yellow Plated		Size	I.D.	O.D.	Thick	Qty
	Plain	Zinc Yellow Plated					
7000	2660	1/4	5/16	5/8	1/16	200	
7001	2661	5/16	3/8	11/16	1/16	100	
7002	2662	3/8	13/32	13/16	1/16	100	
7003	2663	7/16	15/32	15/16	1/16	100	
7004	2664	1/2	17/32	1-1/16	7/64	100	
7005	2665	9/16	19/32	1-3/16	7/64	100	
7006	2666	5/8	21/32	1-5/16	7/64	100	
7007	2667	3/4	13/16	1-1/2	9/64	50	
7008	2668	7/8	15/16	1-3/4	9/64	25	
7009	2669	1	1-1/16	2	9/64	25	
7010	—	1-1/8	1-1/4	2-1/4	9/64	EA	
7011	—	1-1/4	1-3/8	2-1/2	9/64	EA	
7013	—	1-1/2	1-5/8	3	9/64	EA	



STANDARD SAE FLAT WASHERS (C05)

IBS No.	Size	I.D.	O.D.	Thick	Qty
7044	#4	3/32	9/32	3/64	100
7045	#6	1/8	3/8	3/64	100
7046	#8	3/16	15/32	3/64	100
7047	#10	7/32	1/2	3/64	100
7048	#12	1/4	9/16	3/64	100
7049	1/4	9/32	5/8	1/16	200
7050	5/16	11/32	11/16	1/16	100
7051	3/8	13/32	13/16	1/16	100
7052	7/16	7/16	15/16	1/16	100
7053	1/2	1/2	1-1/16	3/32	100
7054	9/16	9/16	1-3/16	3/32	100
7055	5/8	5/8	1-5/16	3/32	100
7056	3/4	3/4	1-1/2	9/64	50
7057	7/8	7/8	1-3/4	9/64	25
7058	1	1	2	9/64	25

W
A
S
H
E
R
S

IBS, INCORPORATED

USS Flat Washers HT C04 & Std C06



Heat Treated Flat USS Washers

- U.S. Standard dimensions for applications requiring extra bearing surface in oversize or slotted holes for high strength applications.
- Eliminates common washer failures such as dishing, bellying or cracking.
- Through hardened (quenched & tempered) to R/C 38-45.
- Made of heat treated alloy.
- Controlled ductility to eliminate cracking and splitting.
- Maximum strength for use with all grades of cap screws.
- Plated washers are Zinc (Standard) and Yellow Baked (Heat Treated).
- Certificates of compliance to ASTM Designation F-436 available on request.



USS PLAIN



USS ZINC YELLOW

IBS No.	Size	I.D.	O.D.	Thick	Qty	IBS No.	Size	I.D.	O.D.	Thick	Qty
7030	1/4"	5/16"	3/4"	.066 / .072	100	2770	1/4"	5/16"	3/4"	.066 / .072	100
7031	5/16"	3/8"	7/8"	.064 / .080	100	2771	5/16"	3/8"	7/8"	.064 / .080	100
7032	3/8"	7/16"	1"	.064 / .080	100	2772	3/8"	7/16"	1"	.064 / .080	100
7033	7/16"	1/2"	1-1/4"	.064 / .080	100	2773	7/16"	1/2"	1-1/4"	.064 / .080	100
7034	1/2"	9/16"	1-3/8"	.097 / .121	100	2774	1/2"	9/16"	1-3/8"	.097 / .121	100
7035	9/16"	5/8"	1-1/2"	.097 / .121	50	2775	9/16"	5/8"	1-1/2"	.097 / .121	50
7036	5/8"	11/16"	1-3/4"	.122 / .146	50	2776	5/8"	11/16"	1-3/4"	.122 / .146	50
7037	3/4"	13/16"	2"	.122 / .146	50	2777	3/4"	13/16"	2"	.122 / .146	50
7038	7/8"	15/16"	2-1/4"	.136 / .160	25	2778	7/8"	15/16"	2-1/4"	.136 / .160	25
7039	1"	1-1/16"	2-1/2"	.136 / .160	25	2779	1"	1-1/16"	2-1/2"	.136 / .160	25



Standard Flat Washers USS (Zinc Plated)

IBS No.	Size	I.D.	O.D.	Thick	Qty	IBS No.	Size	I.D.	O.D.	Thick	Qty
7063	1/4"	5/16"	3/4"	1/16"	200	7070	3/4"	13/16"	2"	5/32"	25
7064	5/16"	3/8"	7/8"	5/64"	100	7071	7/8"	15/16"	2-1/4"	11/64"	25
7065	3/8"	7/16"	1"	5/64"	100	7072	1"	1-1/16"	2-1/2"	11/64"	25
7066	7/16"	1/2"	1-1/4"	5/64"	100	7073	1-1/8"	1-1/4"	2-3/4"	11/64"	EA
7067	1/2"	9/16"	1-3/8"	7/64"	100	7074	1-1/4"	1-3/8"	3"	11/64"	EA
7068	9/16"	5/8"	1-1/2"	7/64"	50	7076	1-1/2"	1-5/8"	3-1/2"	3/16"	EA
7069	5/8"	11/16"	1-3/4"	9/64"	50						

W
A
S
H
E
R
S



IBS, INCORPORATED

Heavy Duty Flat Washers C16

Heavy Duty Flat Washers (Plain)

- Heat treated to Rockwell 38-45.
- Through hardened (quenched and tempered).
- For use with High-Alloy or Grade 8 capscrews.
- Up to 50% thicker than ordinary washers.
- Uniform hardness for greater reliability.
- Won't dish out or crack.
- High torque fastening.
- Less failure under heavy work load.



IBS No.	Size	I.D.	O.D.	Thick	Qty
7300	1/4	17/64	9/16	.090 - .110	50
7301	5/16	11/32	5/8	.090 - .110	50
7302	3/8	13/32	13/16	.090 - .110	25
7303	7/16	15/32	13/16	.090 - .110	25
7304	1/2	17/32	1	.156 - .188	25
7305	9/16	19/32	1-3/32	.156 - .188	10
7306	5/8	21/32	1-3/16	.170 - .195	10
7307	3/4	25/32	1-7/16	.170 - .195	10
7308	7/8	15/16	1-5/8	.235 - .265	10
7309	1	1-1/8	1-7/8	.235 - .265	10
7310	1-1/8	1-3/16	2-1/8	.235 - .265	EA
7311	1-1/4	1-5/16	2-1/4	.235 - .265	EA
7312	1-1/2	1-9/16	2-5/8	.235 - .265	EA

Heavy Duty Flat Washer Assortment

IBS No. 117R • 10 Items - 330 Pcs













IBS, Inc.

SPECIALTY PRODUCTS FOR MAINTENANCE & REPAIR
 INDUSTRIALBOLT.COM © © © 800-678-1906

Heavy Duty Flat Washers

Assortment No. 117R

7303 7/16 HVY DUTY FLAT WASHER PLN 	7307 3/4 HVY DUTY FLAT WASHER PLN 		
7302 3/8 HVY DUTY FLAT WASHER PLN 	7306 5/8 HVY DUTY FLAT WASHER PLN 		
7301 5/16 HVY DUTY FLAT WASHER PLN 	7305 9/16 HVY DUTY FLAT WASHER PLN 	7309 1 HVY DUTY FLAT WASHER PLN 	
7300 1/4 HVY DUTY FLAT WASHER PLN 	7304 1/2 HVY DUTY FLAT WASHER PLN 	7308 7/8 HVY DUTY FLAT WASHER PLN 	

W
A
S
H
E
R
S

IBS, INCORPORATED

Lockwashers C07



Sur-Lock Washers

Sold in Pairs

Sur-Lock washers offer a **safe bolt locking system** that does not rely on traditional techniques to secure the fastener by utilizing tension instead of friction to secure bolted joints. The design is simple and ensures easy installation.

Sur-Lock's system consists of two identical washers which have **inclined cams** on one side and a **series of ridges** on the other. On installation the two cam sides are mated together and placed between the nut and the joint material. Under vibration the nut will attempt to rotate loose, but as the angle of the cams is greater than the pitch angle of the thread on the bolt, the interlocking cams and the non-slip ridges of the washer work together to create a jamming effect. This effect **prevents loosening** and further **locks the assembly**, thereby maintaining joint integrity. Once applied and installed correctly, Sur-Lock Washers will ensure that the fastener remains secure and that **nuts and bolts do not require re-tightening**.

FEATURES & BENEFITS:

- No need for locking nuts, flat or lock washers - minimize inventory and assembly time.
- Retains torque and tension better than any other fastener locking system - resists breaking and loss of shear and tensile strength for less failure.
- Provides maximum safety that keeps equipment and those around it safe from failure.
- Locking function is not affected by lubrication and therefore can be tightened without the need to clean or dry an application and won't deteriorate or loosen around oils.
- Can be used with Grade 2, 5, 8 and even stronger bolts.
- Sur-Lock washers are also reusable - saves time, money and minimizes replacement costs.
- Heat treated to Mil Spec MIL-H-6875H 2.
- Vibration proof to Mil Spec MIL-STD-1312, Vibration Test 7.

WHERE TO USE SUR-LOCK WASHERS

Automotive • Construction • Off-Road • Agriculture • Marine • Trucking • Mining
Offshore • Railroad • Power Plants • Manufacturing • Processing • Utilities



IBS No.	Size	I.D.	O.D.	Pkg	IBS No.	Size	I.D.	O.D.	Pkg
7250	1/4 (M6)	.262	.495	50	7255	9/16 (M14)	.572	1.128	10
7251	5/16 (M8)	.326	.628	50	7256	5/8 (M16)	.651	1.247	10
7252	3/8 (M10)	.409	.705	25	7257	3/4 (M20)	.820	1.381	10
7253	7/16 (M11)	.450	.880	20	7258	7/8 (M22)	.883	1.470	5
7254	1/2 (M12)	.510	1.005	20	7259	1" (M24)	1.015	1.626	5

WASHERS ARE SOLD IN PAIRS (I.E. PKG 50 = 50 PAIRS / 100 PCS)

How to Install

To install the washer, simply mate the cams together and place between the nut and joint material.

As the nut is tightened, one half of the washer is seated to the joint material and the other half to the nut.

As with most fastening devices, washers should only be used against flat, relatively smooth surfaces.

As a loosening moment occurs, one washer rotates with the nut, however since the cam rise angle exceeds the bolt thread angle this results in a locking action.

When the bolt elongates due to vibration and shock, the nut will attempt to rotate loose. As one half of the washer tries to rotate with the nut, the interlocking cams work against each other and maintain the preload and lock the assembly.

Assembly Examples



SUR-LOCK washers Through holes require two pairs of SUR-LOCK washers.



On stud bolts SUR- DO NOT USE with LOCKS lock the nut washers that are not & eliminate the need captivated in place. for adhesives.

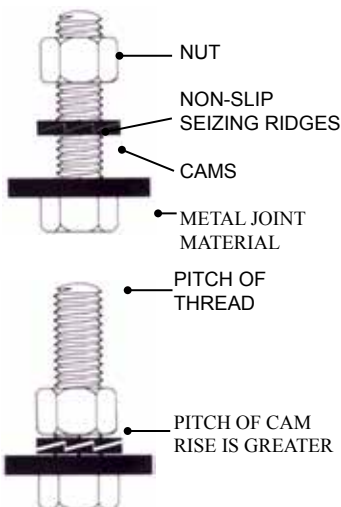

WASHERS



IBS, INCORPORATED

Lockwashers C07

Sur-Lock Washers Assortment

IBS No. 698R • 10 Items • 100 Pcs

WHERE TO USE SUR-LOCK WASHERS

Sur-Lock Washers

Assortment No. 698R

<p style="font-size: 8px;">7250 1/4 & M6 SUR-LOCK WASHER PAIR</p>	<p style="font-size: 8px;">7251 5/16 & M8 SUR-LOCK WASHER PAIR</p>	<p style="font-size: 8px;">7252 3/8 & M10 SUR-LOCK WASHER PAIR</p>	<p style="font-size: 8px;">7253 7/16 & M11 SUR-LOCK WASHER PR</p>
<p style="font-size: 8px;">7254 1/2 & M12 SUR-LOCK WASHER PAIR</p>	<p style="font-size: 8px;">7255 9/16 & M14 SUR-LOCK WASHER PR</p>	<p style="font-size: 8px;">7256 5/8 & M16 SUR-LOCK WASHER PAIR</p>	<p style="font-size: 8px;">7257 3/4 & M20 SUR-LOCK WASHER PAIR</p>
<p style="font-size: 8px;">7258 7/8 & M22 SUR-LOCK WASHER PAIR</p>	<p style="font-size: 8px;">7259 1" & M24 SUR-LOCK WASHER PAIR</p>		

W
A
S
H
E
R
S

Alloy Lockwashers (Yellow Zinc Plated)



- Yellow zinc plated for easy identification.
- Spring tempered, high carbon spring steel.
- Springs back to normal position without loss of locking power.
- Non-linking.
- Use with Grade 8 capscrews

IBS No.	Size	O.D.	Qty	IBS No.	Size	O.D.	Qty
7086	1/4	1/2	200	7091	9/16	31/32	100
7087	5/16	9/16	100	7092	5/8	1-1/16	50
7088	3/8	21/32	100	7093	3/4	1-1/4	50
7089	7/16	3/4	100	7094	7/8	1-7/16	25
7090	1/2	7/8	100	7095	1	1-13/16	25

High Collar Lockwashers (Plain)



For Socket

Head Capscrews

- High carbon double heat-treated spring steel.
- Springs back to normal position without loss of locking power.
- Non-linking

IBS No.	Size	Qty	IBS No.	Size	Qty
7145	#8	100	7150	3/8	100
7146	#10	100	7151	7/16	100
7148	1/4	100	7152	1/2	50
7149	5/16	100	7154	5/8	50

Medium Lockwashers (Zinc Plated)



- Spring tempered, high carbon spring steel.
- Springs back to normal position without loss of locking power.
- Non-linking

IBS No.	Size	O.D.	Qty	IBS No.	Size	O.D.	Qty
7100	#4	3/16	200	7109	1/2	7/8	100
7101	#6	1/4	200	7110	9/16	31/32	100
7102	#8	5/16	200	7111	5/8	1-1/16	100
7103	#10	11/32	200	7112	3/4	1-1/4	50
7104	#12	3/8	200	7113	7/8	1-7/16	25
7105	1/4	1/2	200	7114	1	1-5/8	25
7106	5/16	9/16	100	7115	1-1/8	1-13/16	EA
7107	3/8	11/16	100	7116	1-1/4	2	EA
7108	7/16	3/4	100	7118	1-1/2	2-13/32	EA

IBS, INCORPORATED

Fender Washers C15



Fender Washers

- Zinc plated to protect against rust and corrosion.
- Tumbled to remove burrs and sharp corners.
- Heavy Duty Fender Washers are over 50% thicker than regular style.

FENDER WASHERS

IBS No.	Bolt	I.D.	O.D.	Thick	Qty
7224	3/16	7/32	1/2	3/64	100
7225	3/16	7/32	3/4	3/64	100
7226	3/16	7/32	1	3/64	100
7227	3/16	7/32	1-1/4	3/64	100
7222	3/16	7/32	1-1/2	3/64	100
7228	1/4	17/64	9/16	3/64	100
7229	1/4	9/32	1	3/64	100
7230	1/4	9/32	1-1/4	3/64	100
7231	1/4	9/32	1-1/2	3/64	50
7223	1/4	9/32	2	3/64	50
7236	5/16	11/32	1-1/4	3/64	50
7232	5/16	11/32	1-1/2	3/64	50
7233	3/8	13/32	1-1/4	3/64	50
7234	3/8	13/32	1-1/2	3/64	50
7238	3/8	13/32	2	3/64	50
7239	1/2	17/32	1	3/64	50
7235	1/2	17/32	2	3/64	50

Regular

IBS No. 7229



Heavy Duty

IBS No. 7245

Fender Washer Assortment (Z02)

IBS No. 320R • 11 Items - 700 Pieces

Arranged in a large 12 compartment metal drawer



HEAVY DUTY FENDER WASHERS

IBS No.	Bolt	I.D.	O.D.	Thick	Qty
7244	3/16	7/32	1	1/8	50
7245	1/4	9/32	1-1/8	1/8	50
7246	5/16	11/32	1-1/4	1/8	50
7247	3/8	13/32	2	1/8	50
7248	1/2	9/16	2	1/8	50

WASHERS



IBS, INCORPORATED

Star Washers C11 & Finishing Washers C13

WASHERS

Internal & External Tooth Lockwashers (C11)

ZINC CHROMATE PLATING



Internal Tooth			External Tooth		
IBS No.	Size	Qty	IBS No.	Size	Qty
7161	#4	100	7179	#4	100
7162	#6	100	7180	#6	100
7163	#8	100	7181	#8	100
7164	#10	100	7182	#10	100
7165	#12	100	7183	#12	100
7166	1/4	100	7184	1/4	100
7167	5/16	100	7185	5/16	100
7168	3/8	100	7186	3/8	100
7169	7/16	100	7187	7/16	100
7170	1/2	100	7188	1/2	100
7171	9/16	100	7189	9/16	100
7172	5/8	100	7190	5/8	100
7173	3/4	100	7191	3/4	100
			7175A	1-1/8	100

Finishing Washers (C13) Countersunk Type



- Brass washer resists corrosion indefinitely.
- Nickel plating gives attractive finish.

IBS No.	Size	O.D.	Qty	IBS No.	Size	O.D.	Qty
				7200	#10	19/32	100
7198	#6	7/16	100	7201	#12	11/16	100
7199	#8	17/32	100	7202	#14	11/16	100

Back-Up Washers (W01)

ALUMINUM ROUND

Back-Up Washers are .056" thick for use when fastening soft materials or to compensate for oversize holes where access to both sides of the work is possible.



IBS No.	Size	Dia.	Thick	Qty
AS-8	1/8	3/8	.056	100
AS-9	5/32	7/16	.056	100
AS-10	3/16	1/2	.056	100

Internal & External Star Washer Assortment

IBS No. 797R • 24 Items - 700 Pieces

Arranged in a Locking Steel Drawer for Easy Storage & Organization

Internal and External Star Washers

Assortment No. 797R

<p style="font-size: x-small;">7162 #6 STAR WASHER INTERNAL ZP</p>	<p style="font-size: x-small;">7163 #8 STAR WASHER INTERNAL ZP</p>	<p style="font-size: x-small;">7164 #10 STAR WASH INTERNAL ZP</p>	<p style="font-size: x-small;">7165 #12 STAR WASHER INTERNAL ZP</p>	<p style="font-size: x-small;">7166 1/4 STAR WASHER INTERNAL ZP</p>	<p style="font-size: x-small;">7167 5/16 STAR WASHER INTERNAL ZP</p>
<p style="font-size: x-small;">7168 3/8 STAR WASHER INTERNAL ZP</p>	<p style="font-size: x-small;">7169 7/16 STAR WASHER INTERNAL ZP</p>	<p style="font-size: x-small;">7170 1/2 STAR WASHER INTERNAL ZP</p>	<p style="font-size: x-small;">7171 9/16 STAR WASHER INTERNAL ZP</p>	<p style="font-size: x-small;">7172 5/8 STAR WASHER INTERNAL ZP</p>	<p style="font-size: x-small;">7173 3/4 STAR WASHER INTERNAL ZP</p>
<p style="font-size: x-small;">7180 #6 STAR WASHER EXTERNAL ZP</p>	<p style="font-size: x-small;">7181 #8 STAR WASHER EXTERNAL ZP</p>	<p style="font-size: x-small;">7182 #10 STAR WASHER EXTERNAL ZP</p>	<p style="font-size: x-small;">7183 #12 STAR WASHER EXTERNAL ZP</p>	<p style="font-size: x-small;">7184 1/4 STAR WASHER EXTERNAL ZP</p>	<p style="font-size: x-small;">7185 5/16 STAR WASHER EXTERNAL ZP</p>
<p style="font-size: x-small;">7186 3/8 STAR WASHER EXTERNAL ZP</p>	<p style="font-size: x-small;">7187 7/16 STAR WASHER EXTERNAL ZP</p>	<p style="font-size: x-small;">7188 1/2 STAR WASHER EXTERNAL ZP</p>	<p style="font-size: x-small;">7189 9/16 STAR WASHER EXTERNAL ZP</p>	<p style="font-size: x-small;">7190 5/8 STAR WASHER EXTERNAL ZP</p>	<p style="font-size: x-small;">7191 3/4 STAR WASHER EXTERNAL ZP</p>

IBS, INCORPORATED

Assortments Z02



Automotive Fasteners X05

Copper Washers



IBS No.	I.D.	O.D.	Thick	Qty
D-725-001	1/4	5/8	1/16	25
D-725-002	5/16	11/16	1/16	25
D-725-003	3/8	3/4	1/16	25
D-725-004	7/16	13/16	1/16	25
D-725-005	1/2	7/8	1/16	25
D-725-011	1/4	7/16	1/32	50
D-725-012	5/16	1/2	1/32	50
D-725-013	3/8	9/16	1/32	50
D-725-014	7/16	5/8	1/32	50
D-725-015	1/2	11/16	1/32	50

Drain Plug Gaskets



IBS No.	Size	O.D.	Thick	Material	Qty
D-095-001	1/2	3/4	3/32	Copper	25
D-095-002	5/8	1	3/32	Copper	25

Copper Washer Assortment

IBS No. 160R • 10 Items - 150 Pcs

Arranged in a Locking Steel Drawer for Easy Storage & Organization























IBS, Inc.

SPECIALTY PRODUCTS FOR MAINTENANCE & REPAIR
INDUSTRIALBOLT.COM © © © 800-678-1906

Copper Washers

Assortment No. 160R

<p>D-725-001 1/4ID X 5/8OD COPPER WASHER</p>  	<p>D-725-002 5/16ID X 11/16OD COPPER WASHER</p>  	<p>D-725-003 3/8ID X 3/4OD COPPER WASHER</p>  
<p>D-725-004 7/16ID X 13/16OD COPPER WASHER</p>  	<p>D-725-005 1/2ID X 7/8OD COPPER WASHER</p>  	
<p>D-725-011 1/4ID X 7/16OD COPPER WASHER</p>  	<p>D-725-012 5/16ID X 1/2OD COPPER WASHER</p>  	<p>D-725-013 3/8ID X 9/16OD COPPER WASHER</p>  
<p>D-725-014 7/16ID X 5/8OD COPPER WASHER</p>  	<p>D-725-015 1/2ID X 11/16OD COPPER WASHER</p>  	

WASHERS



W
A
S
H
E
R
S



Miscellaneous Bolts

C

Carriage Bolts D-3

E

Elevator Bolts D-2

F

Fasteners

Bolts

Carriage Bolts D-3

Lag Screws D-3

Plow Bolts Grade 5 D-2

Plow Bolts Grade 8 D-2

Shaker Screen Bolts D-3

L

Lag Screws D-3

P

Plow Bolts

Grade 5 D-2

Grade 8 D-2

S

Shaker Screen Bolts D-3

M
I
S
C
E
L
L
A
N
E
O
U
S
B
O
L
T
S



IBS, INCORPORATED

Plow Bolts D05

M
I
S
C
E
L
L
A
N
E
O
U
S
B
O
L
T
S

Plow Bolts Grade 5

For use on farm machinery and industrial equipment where smaller diameter plow bolts are used.

- 120,000 psi Tensile Strength.
- Hardened sharp square corners to prevent turning in the blade.
- Clean, sharp burr free threads.



Size	3/8-16	Qty	1/2-13	Qty
1-1/2	3670	100	3673F	10
1-3/4			3673G	10
2			3674	10
2-1/2			3675	10

Plow Bolts Grade 8

No. 3 Round Head with Extra-Thick Dome

- 150,000 psi minimum tensile strength.
- Domed head for greater resistance to abrasion and “pull-through”.
- Will not “freeze-up”.
- Can be quickly and easily removed and re-used.
- Exclusive Bronze-Bond finish resists rust and corrosion.
- Meets or exceeds all O.E.M. specifications.



Size	5/8-11	Qty	3/4-10	Qty	7/8-9	Qty	1-8	Qty	1-1/4-7	Qty
1-1/2										
1-3/4										
2	3602	25	3613	20						
2-1/4	3603	25	3614	20						
2-1/2	3604	25	3615	20	3632	10	3645	10		
2-3/4	3605	25	3616	20	3633	10	3646	10		
3	3606	25	3617	20	3634	10	3647	10	3656	10
3-1/4							3648	10		
3-1/2	3607	25	3619	20	3637	10	3649	10		10
3-3/4									3660	
4			3621	20	3639	10	3651	25	3661	10
4-1/2							3652	10		
5			3622	20						
6			3623	20						

Miscellaneous Bolts

Elevator Bolts (D02)

- Ideal for conveyors, machine repair & bowling alley sweeps
- Zinc plated to protect against corrosion
- Large round head
- Full formed square neck
- Clean sharp rolled threads



ELEVATOR BOLTS

Size	1/4-20	Qty	5/16-18	Qty	3/8-16	Qty
1	3266	100	3276	50		
1-1/4	3267	100				
1-1/2	3268	100	3278	50	3287	50
2	3269	100	3280	50		
2-1/2			3281	50		



Carriage Bolts (D03)

- Zinc plated to protect against corrosion.
- Square, sharp neck prevents bolt from turning when nut is tightened.
- Large, round head.
- A307, Grade A, Low Carbon.
- 60,000 psi tensile strength.



Size	10-24	Qty	1/4-20	Qty	5/16-18	Qty	3/8-16	Qty	1/2-13	Qty
3/4	3300	100	3308	100	3330	100	3351	100		
1	3301	100	3309	100	3331	100	3352	100	3380	50
1-1/4	3302	100	3310	100	3332	100	3353	100		
1-1/2	3303	100	3311	100	3333	100	3354	100	3382	50
1-3/4			3312	100			3355	100	3383	50
2			3313	100	3335	100	3356	100	3384	50
2-1/2			3315	100	3337	100	3358	50	3386	50
3			3317	100	3339	100	3360	50	3388	50
3-1/2			3318	100	3340	50	3361	50	3389	50
4			3319	50	3341	50	3362	50	3390	25
4-1/2									3391	25
5									3392	25

Grade 5 Shaker Screen Bolts (D06) (Heat Treated Carriage Bolts)

- 125,000 psi minimum tensile strength.
- Made of special alloy steel.
- Fully threaded.
- Reduces wear and eliminated breakage.
- Triple heat treated and stress relieved for increased life.
- Ideal for use in mines, concrete plants, quarries, etc.



Size	1/2-13	Qty	5/8-11	Qty	3/4-10	Qty
1-1/2	3700	50				
2	3701	50				
2-1/2	3702	25	3711	25		
3	3703	25	3713	25		
3-1/2	3704	25	3714	25		
4	3705	25	3715	25	3722	20
4-1/2			3716	25	3723	20
5	3706	25	3717	25	3724	20
6	3708	25	3718	20	3726	20

Lag Screws (D04)

- Zinc plated to protect against corrosion
- Accepts any standard wrench
- Clean, well formed threads
- Deep threads with wide pitch
- Cleanly trimmed head



Size	1/4	Qty	5/16	Qty	3/8	Qty	1/2	Qty
1	3500	100	3513	100	3530	100		
1-1/4								
1-1/2	3502	100	3517	100	3532	100	3546	50
1-3/4								
2	3504	100	3519	100	3534	100	3547	50
2-1/2	3505	100	3520	100	3535	50	3548	50
3	3506	100	3521	100	3536	50	3549	50
3-1/2	3507	100	3522	50	3537	50	3550	25
4	3508	100	3523	50	3538	50	3551	25
5					3540	50	3553	25
6					3542	50	3555	25

M I S C E L L A N E O U S B O L T S



IBS, INCORPORATED

Miscellaneous Bolts

**M
I
S
C
E
L
L
A
N
E
O
U
S

B
O
L
T
S**



Tapping Screws & Driver Bits

A

Adhesives

DriveGrip Anti Cam-Out Fluid E-22

Assortments

Adhesives

Drive Grip & Insert bits E-23, E-24

DriveGrip & Nutserts E-23

Driver Bits E-18, E-21

Grabit Damaged Screw Remover & DriveGrip E-24

Impact Torsion Bits

42 Pc Impact Torsion Bit Set E-20

Impact Torsion Phillips & Square Bit Assortment E-21

Impact Torsion Torx & Bit Holders Assortment E-21

Screws, Tapping

Phillips Flat Head E-5

Phillips Pan Head E-4

Phil Oval Head T/S S.S. Assortment E-6

Phil Pan & K-Lath TeknScrews E-12

Screws, TekS

Phil Pan Hd E-12

C

Combo Quick Change Bit Holder E-15

D

Driver Bits

Flexible Extension E-26

General Information E-15, E-19

Grabit Drill-Out Broken Bolt Extractor Set E-25

GRABIT PRO Damaged Screw Remover E-24, E-25

Hex Drive Nut-Setters E-15, E-19

Phillips Recess Insert Bits E-16, E-19

Phillips Recess Power Bits E-16, E-19

Security E-17

Hex Driver Bits E-17

Phillips Driver Bits E-17

Torx Driver Bits E-17

Slotted Screw Style Insert E-16

Slotted Screw Style Power Bits E-16

Spin-It-Out Damaged Screw Removers E-17, E-20

Square Drive Sockets E-17

Square Recess Bits E-16, E-20

Tools & Accessories

Combo Quick Change Bit Holder E-15

Torx Insert Bits E-16, E-20

Torx Power Bits E-16, E-20

E

Extractors

Screw Extractors, Sets

Grabit Drill-Out Broken Bolt Extractor Set E-25

F

Fasteners

Screws, Drywall

Phillips Bugle Head E-9

Screws, Tapping

Hole Size Recommendations E-3

HWH, Sur-Grip E-7

Phillips Flat Head E-5

Phillips Oval Head E-6

Phillips Pan Head E-4

Slotted Pan Head E-3

Square Drive, Flat Head E-7

Screws, TekS

Hex Washer Head E-10

Hex Washer Head, Stainless Steel E-14

HWH TekS w/Neobond Washer E-12

Phillips Pan Hd, ZP E-12

Serrated Hex Washer Head E-10

Square Drive Pan Head E-13

Stainless Steel

Phillips Tapping Screws Oval Head E-6

Phillips Tapping Screws Pan Head E-4, E-6

I

Impact Torsion Bits E-19

Assortments

42 Pc Impact Torsion Bit Set E-20

Impact Torsion Phillips & Square Bit Assortment E-21

Impact Torsion Torx & Bit Holders Assortment E-21

Drivers & Adapters

HD Magnetic Bit & Screw Holder E-19

Hex Sq Drive Socket Adapter E-19

Magnetic Driver Bit Holder E-19

Magnetic Impact Nut Driver E-19

Quick Release Impact Magnetic Bit Holder E-19

Phillips Drive

Phillips Impact Insert Bits E-19

Phillips Impact Recess Power Bits E-19

Square Drive

Square Impact Insert Bits E-20

Square Impact Recess Power Bits E-20

Torx Drive

Hex Torx 1-5/16" Impact Power Bits E-20

Torx Impact Insert Bits E-20

S

Screw Extractors, Sets

Grabit Drill-Out Broken Bolt Extractor Set E-25

Screws

Drywall Screws

Phillips Bugle Head



IBS, INCORPORATED

Index

T
A
P
P
I
N
G
S
C
R
E
W
S

Dacrotized E-9

Zinc Yellow E-9

Stainless Steel

Phillips Oval Head Tapping Screws E-6

Phil Pan Head E-4, E-6

Tapping

HWH Slotted E-8

HWH Sur-Grip E-7

Phillips Flat Head E-5

Phillips Oval Head E-6

Phillips Pan Head E-4

Slotted Pan Head E-3

Square Drive, Flat Head E-7

Teks

Hex Washer Head E-10

Hex Washer Head, Stainless Steel E-14

HWH w/Neobond Washer E-12

K-Lath Modified Truss Head Screw (E16) E-14

Phillips Pan Head, ZP E-12

Serrated Hex Washer Head E-10

Square Drive Pan Head E-13

T

Teks

K-Lath Modified Truss Head Screw (E16) E-14

Tools

Combo Quick Change Bit Holder E-15

Driver Bits

Flexible Extension E-26

Flexible Extension E-26

IBS, INCORPORATED

Tapping Screws, General Information



Tapping Screw Hole Size Recommendations

Thickness of Metal			Pierced Hole	Drilled or Clean Punched Hole		Thickness of Metal			Pierced Hole	Drilled or Clean Punched Hole	
Screw Dia.	USS Gauge No.	Equiv	Hole Dia.	Hole Dia.	Drill Size	Screw Dia.	USS Gauge No.	Equiv	Hole Dia	Hole Dia.	Drill Size
4 .112	28	.0156	.086	.0860	44	8 .163	26	.0188	.131	.1160	—
	26	.1088	.086	.0860	44		24	.0250	.131	.1160	32
	24	.0250	.093	.0890	43		22	.0313	.131	.1160	32
	22	.0313	.098	.0935	42		20	.0375	.136	.1285	32
	20	.0375	.100	.0935	42		18	.0500	.140	.1440	30
6 .137	28	.0156	.106	.1040	37	4 .112	26	.0188	.144	.1440	27
	26	.0188	.106	.1040	37		24	.0250	.144	.1440	27
	24	.0250	.106	.1065	36		22	.0313	.144	.1440	27
	22	.0313	.110	.1065	36		20	.0375	.147	.1440	27
	20	.0375	.110	.1100	35		18	.0500	.155	.1660	27
7 .151	26	.1088	.121	.1160	32	12 .212	24	.1025	.185	.1660	19
	24	.0250	.121	.1160	32		22	.0313	.185	.1660	19
	22	.0313	.121	.1160	32		20	.0375	.185	.1695	19
	20	.0375	.121	.1160	32		18	.0500	.185	.1850	18
	18	.0500	.121	.1200	31	14 .243	22	.0313	.209	.1850	13
	16	.0625	—	.1285	30		20	.0375	.209	.1910	13
							18	.0500	.209	.1910	11
						16	.0625	—	.1990	8	

TAPPING SCREWS

Slotted Pan Head Tapping Screws (E01)



- Zinc plated for corrosion resistance.
- Sharp, hardened threads.
- Sharp lead point.
- Deep, twist resistant slots.
- Greater resistance to breakage and snapping.

Length	Diameter						
	#4	#6	#7	#8	#10	#12	#14
1/4		7510					
3/8	7502	7512		7537	7553		
1/2	7503	7513	7526	7538	7554	7570	7585
5/8		7514		7539	7555	7571	7586
3/4		7515	7528	7540	7556	7572	7587
1		7517	7530	7542	7558	7574	7589
1-1/4				7543	7559	7575	7590
1-1/2				7544	7560	7576	7591
Qty	100	100	100	100	100	100	100



IBS, INCORPORATED

Phillips Tapping Screws E03

Phillips Pan Head Tapping Screws (E03)



- Zinc plated to resist corrosion.
- Type AB thread design for increased thread engagement and tighter assemblies.
- Sharp lead point and hardened threads.
- Greater resistance to snapping and breakage.

Length	Diameter					
	#4	#6	#8	#10	#12	#14
1/4	7681	7691	7710			
3/8	7683	7693	7712	7728		
1/2	7684	7694	7713	7729	7744	7759
5/8		7695	7714	7730	7745	7760
3/4	7686	7696	7715	7731	7746	7761
1		7698	7717	7733	7748	7763
1-1/4		7699	7718	7734	7749	7764
1-1/2		7700	7719	7735	7750	7765
1-3/4			7720	7736		7766
2			7721	7737	7752	7767
2-1/2				7738	7753*	7768*
3				7739	7754*	7769*
Pkg Qty	100	100	100	100	100/50*	100/50*

Phillips Pan Head Tapping Screws (Z02)

IBS No. 113R • 24 Items - 1500 Pieces

Packaged in a locking steel drawer for easy storage & organization.

Phillips ID Chart

Assortment No. 113R

Part No.	Part No.	Part No.	Part No.	Part No.	Part No.
7693 6 X 3/8 PHIL PAN HD T/S ZP	7698 6 X 1" PHIL PAN HD T/S ZP	7717 8 X 1" PHIL PAN HD T/S ZP	7733 10 X 1" PHIL PAN HD T/S ZP	7748 12 X 1" PHIL PAN HD T/S ZP	7761 14 X 3/4 PHIL PAN HD T/S ZP
7694 6 X 1/2 PHIL PAN HD T/S ZP	7713 8 X 1/2 PHIL PAN HD T/S ZP	7729 10 X 1/2 PHIL PAN HD T/S ZP	7735 10 X 1-1/2 PHIL PAN HD T/S ZP	7749 12 X 1-1/4 PHIL PAN HD T/S ZP	7763 14 X 1" PHIL PAN HD T/S ZP
7695 6 X 5/8 PHIL PAN HD T/S ZP	7714 8 X 5/8 PHIL PAN HD T/S ZP	7730 10 X 5/8 PHIL PAN HD T/S ZP	7744 12 X 1-1/2 PHIL PAN HD T/S ZP	7750 12 X 1-1/2 PHIL PAN HD T/S ZP	7764 14 X 1-1/4 PHIL PAN HD T/S ZP
7696 6 X 3/4 PHIL PAN HD T/S ZP	7715 8 X 3/4 PHIL PAN HD T/S ZP	7731 10 X 3/4 PHIL PAN HD T/S ZP	7746 12 X 3/4 PHIL PAN HD T/S ZP	7760 14 X 5/8 PHIL PAN HD T/S ZP	7765 14 X 1-1/2 PHIL PAN HD T/S ZP

TAPPING SCREWS

Phillips Pan Head Tapping Screws SS (I22)



Length	Diameter				
	#6	#8	#10	#12	#14
3/8	12528	12537	12546		
1/2	12529	12538	12547	12557	12567
5/8	12530	12539	12548	12558	12568
3/4	12531	12540	12549	12559	12569
1	12532	12541	12550	12560	12570
1-1/4	12533	12542*	12551*	12561	12571
1-1/2	12534	12543*	12552*	12562	12572
2			12554*	12564	12574
Pkg Qty	100	100/50*	100/50*	50	50

Phillips Pan Head Tapping Screws - Black Oxide (X05)



Length	Diameter			Length
	#6	#8	#10	
3/8	A-16889			3/8
1/2	A-11917	A-10180	A-11921	1/2
3/4	A-11918	A-10181	A-11922	3/4
1	A-11919	A-10182	A-11923	1
1-1/4		A-10183	A-11924	1-1/4
1-1/2			A-12800	1-1/2
Pkg Qty	100	100	100	Pkg Qty

IBS, INCORPORATED

Phillips Tapping Screws E03



Phillips Flat Head Tapping Screws



- Zinc plated for corrosion resistance.
- Fully threaded for use with plastic, sheet metal, and wood.
- Type AB thread gives 7% more tensile strength and 50% more holding power.
- Easier starting with sharp lead point.
- Finished flat head provides attractive, flush fit in sheet metal or wood.
- Use where flush fit is necessary for operation, safety and cleanliness.

Length	Diameter					
	#4	#6	#8	#10	#12	#14
1/4	7774					
3/8	7776	7785				
1/2	7777	7786	7803	7818		
5/8		7787	7804	7819	7833	
3/4	7779	7788	7805	7820	7834	7847
1		7790	7807	7822	7836	7849
1-1/4		7791	7808	7823	7837	7850
1-1/2		7792	7809	7824	7838	7851
1-3/4			7810			
2			7811	7826	7840	7853*
2-1/2				7827	7841*	7854*
3				7828	7842*	
Pkg Qty	100	100	100	100	100/50*	100/50*

Phillips Flat Head Tapping Screws (Z02)

IBS No. 166R • 24 Items
1550 Pieces

Packaged in a locking steel drawer for easy storage & organization.

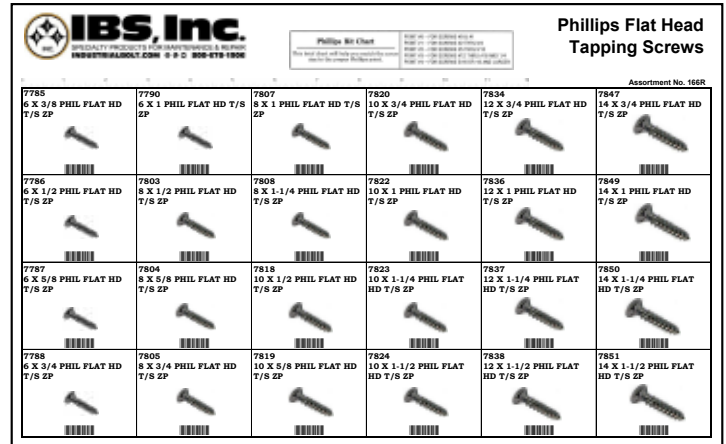

Phillips Flat Head Tapping Screws, SS (I22)

- 18-8 Stainless Steel for maximum strength and corrosion resistance.
- Fully threaded for use with plastic, sheet metal, and wood.
- Type AB thread gives 7% more tensile strength and 50% more holding power.
- Easier starting with sharp lead point.
- Finished flat head provides attractive, flush fit in sheet metal or wood.
- Use where flush fit is necessary for operation, safety and cleanliness.

Length	Diameter					Length
	#6	#8	#10	#12	#14	
3/8	12588	12597	12606			3/8
1/2	12589	12598	12607	12618		1/2
3/4	12591	12600	12609	12620	12630	3/4
1	12592	12601	12610	12621	12631	1
1-1/4	12593	12602	12611	12622	12632	1-1/4
1-1/2	12594	12603	12612	12623	12633	1-1/2
2			12614	12625	12635	2
3					NS	3
Pkg Qty	50	50	50	50	50	Pkg Qty

TAPPING SCREWS



IBS, INCORPORATED

Phillips Tapping Screws E03

TAPPING SCREWS

Phillips Oval Head Tapping Screws



- Zinc plated for corrosion resistance.
- Sharp lead point.
- Sharp, hardened threads.
- Type AB thread design for increased thread engagement and tighter assemblies.
- Greater resistance to breakage and snapping.
- Use on automotive interiors for a finished look.

Length	Diameter					
	#4	#6	#8	#10	#12	#14
3/8	7860	7865	7882			
1/2	7861	7866	7883	7894	7908	
5/8		7867	7884	7895	7909	
3/4	7863	7868	7885	7896	7910	7919
1		7869	7886	7897	7911	7920
1-1/4		7870	7887	7898	7912	
1-1/2			7888	7899	7913	7922*
2				7900		
Pkg Qty	100	100	100	100	100	100/50*

Phillips Oval Head Tapping Screws - Black Oxide (X05)



Length	Diameter		
	#6	#8	#10
1/2	A-12795	A-10163	A-11084
3/4	A-12796	A-10165	A-11086
1	A-12797	A-10167	A-11088
1-1/4		A-10169	
Pkg Qty	100	100	100

Phil Pan & Oval Head T/S - Black Oxide Assortment (Z02)

IBS No. 767R • 24 Items

1100 Pieces

Packaged in a locking steel drawer for easy storage & organization.

IBS Inc. Phillips Bit Chart						Phillips Pan and Oval Head Tapping Screws - Black Oxide
Assortment 767R						
A-16889 6 X 3/8 PHIL PAN HD T/S B/O	A-11917 6 X 1/2 PHIL PAN HD T/S B/O	A-11918 6 X 3/4 PHIL PAN HD T/S B/O	A-11919 6 X 1 PHIL PAN HD T/S B/O	A-10180 8 X 1/2 PHIL PAN HD T/S B/O	A-10181 8 X 3/4 PHIL PAN HD T/S B/O	
A-10182 8 X 1 PHIL PAN HD T/S B/O	A-10183 8 X 1-1/4 PHIL PAN HD T/S B/O	A-12799 8 X 1-1/2 PHIL PAN HD T/S B/O	A-11921 10 X 1/2 PHIL PAN HD T/S B/O	A-11922 10 X 3/4 PHIL PAN HD T/S B/O	A-11923 10 X 1 PHIL PAN HD T/S B/O	
A-11924 10 X 1-1/4 PHIL PAN HD T/S B/O	A-12800 10 X 1-1/2 PHIL PAN HD T/S B/O	A-12795 6 X 1/2 PHIL OVAL HD T/S B/O	A-12796 6 X 3/4 PHIL OVAL HD T/S B/O	A-12797 6 X 1 PHIL OVAL HD T/S B/O	A-10163 8 X 1 PHIL OVAL HD T/S B/O	
A-10165 8 X 3/4 PHIL OVAL HD T/S B/O	A-10167 8 X 1 PHIL OVAL HD T/S B/O	A-10169 8 X 1-1/4 PHIL OVAL HD T/S B/O	A-11084 10 X 1/2 PHIL OVAL HD T/S B/O	A-11086 10 X 3/4 PHIL OVAL HD T/S B/O	A-11088 10 X 1 PHIL OVAL HD T/S B/O	

Phillips Oval Head Tapping Screws SS (I22)



Length	Diameter				
	#6	#8	#10	#12	#14
1/2	12649	12658	12667	12677	12687
5/8	12650	12659	12668	12678	
3/4	12651	12660	12669	12679	12689
1	12652	12661	12670	12680	12690
1-1/4	12653	12662	12671	12681*	12691
1-1/2	—	12663	12672	12682*	12692
Pkg Qty	100	100	100	100/50*	50

Assortment (Z02) IBS No. 171R

24 Items • 1075 Pieces

Packaged in a locking steel drawer for easy storage & organization.

IBS Inc. Phillips Bit Chart						Stainless Steel Phillips Oval Head Tapping Screws
Assortment No. 171R						
12649 6 X 1/2 PHIL OVAL T/S SS	12651 6 X 3/4 PHIL OVAL T/S SS	12653 8 X 1 PHIL OVAL T/S SS	12655 8 X 1-1/4 PHIL OVAL T/S SS	12657 8 X 1-1/2 PHIL OVAL T/S SS	12659 10 X 1/2 PHIL OVAL T/S SS	
12661 10 X 3/4 PHIL OVAL T/S SS	12663 10 X 1 PHIL OVAL T/S SS	12665 10 X 1-1/4 PHIL OVAL T/S SS	12667 10 X 1-1/2 PHIL OVAL T/S SS	12669 12 X 1/2 PHIL OVAL T/S SS	12671 12 X 3/4 PHIL OVAL T/S SS	
12673 12 X 1 PHIL OVAL T/S SS	12675 14 X 1/2 PHIL OVAL T/S SS	12677 14 X 3/4 PHIL OVAL T/S SS	12679 14 X 1 PHIL OVAL T/S SS	12681 14 X 1-1/4 PHIL OVAL T/S SS	12683 14 X 1-1/2 PHIL OVAL T/S SS	
12685 14 X 1-1/2 PHIL OVAL T/S SS	12687 16 X 1/2 PHIL OVAL T/S SS	12689 16 X 3/4 PHIL OVAL T/S SS	12691 16 X 1 PHIL OVAL T/S SS	12693 16 X 1-1/4 PHIL OVAL T/S SS	12695 16 X 1-1/2 PHIL OVAL T/S SS	

IBS, INCORPORATED

Square Drive Tapping Screws E06



Square Drive Pan Head Tapping Screws Assortment (Z02)

IBS No. 162R • 24 Items • 1250 Pieces
 Packaged in a locking steel drawer for easy storage & organization.



- Zinc plated for corrosion resistance.
- Made from hardened steel.
- Sharp lead point.
- Greater resistance to snapping and breakage.

Length	Diameter				
	#6	#8	#10	#12	#14
3/8	7934				
1/2	7935	7947	7962	7977	7992
5/8	7936	7948	7963	7978	7993
3/4	7937	7949	7964	7979	7994
1	7938	7950	7965	7980	7995
1-1/4		7951	7966	7981	7996
1-1/2	7940	7952	7967	7982	7997
2		7954	7969	7984*	7999
2-1/2				7986*	8001
Pkg Qty	100	100	100	100/50*	50

IBS Inc. Square Drive Pan Head Tapping Screws Assortment No. 162R					
7934	7935	7936	7937	7938	7939
6 X 3/8 SQUARE DR PAN HD T/S	6 X 1/2 SQUARE DR PAN HD T/S	6 X 5/8 SQUARE DR PAN HD T/S	8 X 1/2 SQUARE DR PAN HD T/S	8 X 3/4 SQUARE DR PAN HD T/S	8 X 5/8 SQUARE DR PAN HD T/S
7940	7941	7942	7943	7944	7945
10 X 1/2 SQUARE DR PAN HD T/S	10 X 3/4 SQUARE DR PAN HD T/S	10 X 5/8 SQUARE DR PAN HD T/S	12 X 1/2 SQUARE DR PAN HD T/S	12 X 3/4 SQUARE DR PAN HD T/S	12 X 5/8 SQUARE DR PAN HD T/S
7946	7947	7948	7949	7950	7951
14 X 1/2 SQUARE DR PAN HD T/S	14 X 3/4 SQUARE DR PAN HD T/S	14 X 5/8 SQUARE DR PAN HD T/S	16 X 1/2 SQUARE DR PAN HD T/S	16 X 3/4 SQUARE DR PAN HD T/S	16 X 5/8 SQUARE DR PAN HD T/S
7952	7953	7954	7955	7956	7957
18 X 1/2 SQUARE DR PAN HD T/S	18 X 3/4 SQUARE DR PAN HD T/S	18 X 5/8 SQUARE DR PAN HD T/S	20 X 1/2 SQUARE DR PAN HD T/S	20 X 3/4 SQUARE DR PAN HD T/S	20 X 5/8 SQUARE DR PAN HD T/S

Square Drive Flat Head Tapping Screws



Length	Diameter			
	#6	#8	#10	#12
1/2	8008	8019		
3/4	8010	8021	8036	8054
1	8011	8022	8037	
1-1/4			8038	8056*
1-1/2	8013	8024	8039	
2		8026	8041	
Pkg Qty	100	100	100	100/50*

Sur-Grip Slotted Tapping Screws

WHILE SUPPLIES LAST

- Vibration proof connection.
- Increased thread engagement.
- Increased resistance to strip-out.
- Full diameter threads draw the work material up into the serrated bearing surface area.



Length	Length			Length
	8-18	10-16	1/4-14	
5/8	22532	22546		5/8
3/4	22536			3/4
1	22538			1
1-1/2			22570	1-1/2
Qty	100	100	50	Qty
Hex Size	1/4	5/16	3/8	Hex Size

TAPPING SCREWS



IBS, INCORPORATED

Hex Head Tapping Screws E13

Slotted HWH Tapping Screws



- Installs quickly and easily with either a screwdriver or wrench.
- Type "AB" thread for better gripping.
- Washer face protects metal against wrench disfigurements.
- Zinc plated to protect against rust and corrosion.

Length	Diameter					
	#6	#8	#10	#12	#14	5/16
1/4	8097					
3/8	8098	8110	8127			
1/2	8099	8111	8128	8143	8158	
5/8	8100	8112	8129		8159	
3/4	8101	8113	8130	8145	8160	8174
1	8102	8114	8131	8146	8161	8175
1-1/4		8115	8132	8147	8162	8176
1-1/2		8116	8133	8148	8163	8177
1-3/4						
2		8118	8135	8150	8165	
2-1/2					8166*	
3					8167*	
Qty	100	100	100	100	100 /50*	50
Hex Size	1/4	1/4	5/16	5/16	3/8	1/2

Assortment (Z02)

IBS No. 152R • 24 Items • 1325 Pcs
 Packaged in a locking steel drawer for easy storage & organization.

IBS, Inc.						Hex Washer Head Tapping Screws																	
Assortment No. 152R																							
8097 6 X 1/4 SLTD HEX WASHER HD Hex Size 1/4"	8098 6 X 3/8 SLTD HEX WASHER HD Hex Size 1/4"	8099 6 X 1/2 SLTD HEX WASHER HD Hex Size 1/4"	8101 6 X 3/4 SLTD HEX WASHER HD Hex Size 1/4"	8102 6 X 1 SLTD HEX WASHER HD T/S Hex Size 1/4"	8160 14 X 3/4 SLTD HEX WASHER HD Hex Size 3/8"	8110 8 X 3/8 SLTD HEX WASHER HD Hex Size 1/4"	8111 8 X 1/2 SLTD HEX WASHER HD Hex Size 1/4"	8113 8 X 3/4 SLTD HEX WASHER HD Hex Size 1/4"	8114 8 X 1 SLTD HEX WASHER HD T/S Hex Size 1/4"	8115 8 X 1-1/4 SLTD HEX WASHER HD Hex Size 1/4"	8161 14 X 1 SLTD HEX WASHER HD T/S Hex Size 3/8"	8127 10 X 3/8 SLTD HEX WASHER HD Hex Size 5/16"	8128 10 X 1/2 SLTD HEX WASHER HD Hex Size 5/16"	8129 10 X 5/8 SLTD HEX WASHER HD Hex Size 5/16"	8130 10 X 3/4 SLTD HEX WASHER HD Hex Size 5/16"	8131 10 X 1 SLTD HEX WASHER HD T/S Hex Size 5/16"	8162 14 X 1-1/4 SLTD HEX WASHER HD Hex Size 3/8"	8133 10 X 1-1/2 SLTD HEX WASHER HD Hex Size 5/16"	8143 12 X 1/2 SLTD HEX WASHER HD Hex Size 5/16"	8145 12 X 3/4 SLTD HEX WASHER HD Hex Size 5/16"	8146 12 X 1 SLTD HEX WASHER HD T/S Hex Size 5/16"	8148 12 X 1-1/2 SLTD HEX WASHER HD Hex Size 5/16"	8163 14 X 1-1/2 SLTD HEX WASHER HD Hex Size 3/8"
8127 10 X 3/8 SLTD HEX WASHER HD Hex Size 5/16"	8128 10 X 1/2 SLTD HEX WASHER HD Hex Size 5/16"	8129 10 X 5/8 SLTD HEX WASHER HD Hex Size 5/16"	8130 10 X 3/4 SLTD HEX WASHER HD Hex Size 5/16"	8131 10 X 1 SLTD HEX WASHER HD T/S Hex Size 5/16"	8162 14 X 1-1/4 SLTD HEX WASHER HD Hex Size 3/8"	8133 10 X 1-1/2 SLTD HEX WASHER HD Hex Size 5/16"	8143 12 X 1/2 SLTD HEX WASHER HD Hex Size 5/16"	8145 12 X 3/4 SLTD HEX WASHER HD Hex Size 5/16"	8146 12 X 1 SLTD HEX WASHER HD T/S Hex Size 5/16"	8148 12 X 1-1/2 SLTD HEX WASHER HD Hex Size 5/16"	8163 14 X 1-1/2 SLTD HEX WASHER HD Hex Size 3/8"												

TAPPING SCREWS

Hex Washer Head Thread Cutting Screws E09



- Type "F"
- Deep thread cutting slots for cleaner threads and positive chip ejection.
- Hardened threads.
- Zinc plated to protect against rust and corrosion.
- Used on all trailer bodies and walk-in panel trucks.

Length	Diameter					
	8-32	10-24	12-24	1/4-20	5/16-18	3/8-16
Drill	#26	#17	#8	#1	"L"	"T"
3/8	8206					
1/2	8207	8214	8219	8223	8228	
5/8		8215				
3/4	8209	8216	8220	8225	8229	8232
1	8211	8217	8221	8226	8230	8233
1-1/4				8227	8231	8234
1-1/2						8235
Qty	100	100	100	100	50	25
Hex Size	1/4	5/16	5/16	3/8	1/2	9/16

Assortment (Z02)

IBS No. 150R • 20 Items • 380 Pcs
 Packaged in a locking steel drawer for easy storage & organization.

IBS, Inc.						Hex Washer Head Thread Cutting Screws Type "F"													
Assortment No. 150R																			
8207 8-32 X 1/2 HWH T/C TYPE F ZP Hex Size 1/4"	8209 8-32 X 3/4 HWH T/C TYPE F ZP Hex Size 1/4"	8211 8-32 X 1 HWH T/C TYPE F ZP Hex Size 1/4"	8214 10-24 X 1/2 HWH T/C TYPE F ZP Hex Size 5/16"	8215 10-24 X 5/8 HWH T/C TYPE F ZP Hex Size 5/16"	8216 10-24 X 3/4 HWH T/C TYPE F ZP Hex Size 5/16"	8217 10-24 X 1 HWH T/C TYPE F ZP Hex Size 5/16"	8220 12-24 X 3/4 HWH T/C TYPE F ZP Hex Size 5/16"	8221 12-24 X 1 HWH T/C TYPE F ZP Hex Size 5/16"	8223 12-24 X 1 1/2 HWH T/C TYPE F ZP Hex Size 3/8"	8225 1/4-20 X 3/4 HWH T/C TYPE F ZP Hex Size 3/8"	8226 1/4-20 X 1 HWH T/C TYPE F ZP Hex Size 3/8"	8227 1/4-20 X 1-1/4 HWH T/C TYPE F ZP Hex Size 3/8"	8229 5/16-18 X 3/4 HWH T/C TYPE F ZP Hex Size 1/2"	8230 5/16-18 X 1 HWH T/C TYPE F ZP Hex Size 1/2"	8231 3/8-16 X 1-1/4 HWH T/C TYPE F ZP Hex Size 9/16"	8232 3/8-16 X 1 HWH T/C TYPE F ZP Hex Size 9/16"	8233 3/8-16 X 1 HWH T/C TYPE F ZP Hex Size 9/16"	8234 3/8-16 X 1-1/4 HWH T/C TYPE F ZP Hex Size 9/16"	8235 3/8-16 X 1-1/2 HWH T/C TYPE F ZP Hex Size 9/16"
8227 1/4-20 X 1-1/4 HWH T/C TYPE F ZP Hex Size 3/8"	8229 5/16-18 X 3/4 HWH T/C TYPE F ZP Hex Size 1/2"	8230 5/16-18 X 1 HWH T/C TYPE F ZP Hex Size 1/2"	8231 3/8-16 X 1-1/4 HWH T/C TYPE F ZP Hex Size 9/16"	8232 3/8-16 X 1 HWH T/C TYPE F ZP Hex Size 9/16"	8233 3/8-16 X 1 HWH T/C TYPE F ZP Hex Size 9/16"	8234 3/8-16 X 1-1/4 HWH T/C TYPE F ZP Hex Size 9/16"	8235 3/8-16 X 1-1/2 HWH T/C TYPE F ZP Hex Size 9/16"												

IBS, INCORPORATED

Deck Screws E11



Flat Head Deck Screws

Torx® Drive



- Type “F” self cutting threads.
- Phosphate and oil finish.
- Torx® design gives positive torque control and higher wrenchability.
- Optimum driver-fastener alignment.
- No cam-out (driver pre-spinning).
- No head damage or distortion.
- Speeds assembly and provides efficient, economical fastening.
- Used on truck and bus bodies.

Length	1/4 Dia	5/16 Dia
	Bit Size	
	T30	T40
1-1/2	8281	
2	8282	8285
2-1/2	8283*	8286
3	8284*	8287
Qty	100/50*	50

Phillips Drive



- Self-tapping.
- Type “F” self-cutting threads.
- Zinc plated to protect against rust and corrosion.
- Heat treated.

Length	Bit Size	Dia	Zinc Plate
1-1/2	#3	1/4	8290
2	#3	1/4	8291
2-1/2	#3	1/4	8292
Qty			100

Drywall Screws E17

Phillips Bugle Head Drywall Screws



- Used for fastening drywall to wood studs.
- Fastens wood to wood fixtures.
- Available in Black Phosphate or Yellow Zinc plate when additional weather resistance is needed.

Length	ZINC YELLOW		BLACK PHOSPHATE		Length
	Diameter		Diameter		
	#6	#8	#6	#8	
1	8650		8660		1
1-1/4	8651		8661		1-1/4
1-5/8	8652		8662		1-5/8
1-1/2					1-1/2
2	8653		8663		2
2-1/4			8664		2-1/4
2-1/2				8665	2-1/2
3		8654		8666	3
Qty	100	100	100	100	Qty

T
A
P
P
I
N
G

S
C
R
E
W
S



IBS, INCORPORATED

Teks® Screws E16

Serrated Hex Washer Head Tek® Screws



For unmatched performance against strip-out and vibration loosening in sheet metal applications, you can rely on Serrated HWH Tek® Screws. Even after removal and reinsertion, they maintain their strong holding power for more solid assemblies and greater integrity in the finished product.

- Serrations under the head grab materials and resist loosening from vibration creating a stronger hold reducing the chance of failure or pullout.
- Manufactured to SAE J78 Specifications
- Case hardened to Rockwell C50-56
- #2 Drill Point
- Steel Zinc Plated

Assortment (Z02)
IBS No. 173R • 16 Items • 900 Pieces
Packaged in a locking steel drawer for easy storage & organization.

TAPPING SCREWS

Length	Diameter			
	8-18	10-16	12-14	1/4-14
1/2	23630	23644		
5/8	23632	23646	23654	23664
3/4	23636	23648	23656	23666
1	23638	23650	23658	23668
1-1/4				
1-1/2			23660*	23670
2				23672
Pkg Qty	100	100	100 / *50	50
Hex Size	1/4	5/16	5/16	3/8

IBS, Inc. INDUSTRIAL PRODUCTS DIVISION				Serrated Hex Washer Head TEK/Drill Point Screws			
Assortment No. 173R							
23630 8-18 X 1/2 HWH SERRATED TEK ZP HEX SIZE: 1/4"	23644 10-16 X 1/2 HWH SERRATED TEK ZP HEX SIZE: 5/16"	23654 12-14 X 5/8 HWH SERRATED TEK ZP HEX SIZE: 5/16"	23666 1/4-14 X 3/4 HWH SERRATED TEK ZP HEX SIZE: 3/8"				
23632 8-18 X 5/8 HWH SERRATED TEK ZP HEX SIZE: 1/4"	23646 10-16 X 5/8 HWH SERRATED TEK ZP HEX SIZE: 5/16"	23656 12-14 X 3/4 HWH SERRATED TEK ZP HEX SIZE: 5/16"	23668 1/4-14 X 1 HWH SERRATED TEK ZP HEX SIZE: 3/8"				
23636 8-18 X 3/4 HWH SERRATED TEK ZP HEX SIZE: 1/4"	23648 10-16 X 3/4 HWH SERRATED TEK ZP HEX SIZE: 5/16"	23658 12-14 X 1 HWH SERRATED TEK ZP HEX SIZE: 5/16"	23670 1/4-14 X 1-1/2 HWH SERRATED TEK ZP HEX SIZE: 3/8"				
23638 8-18 X 1 HWH SERRATED TEK ZP HEX SIZE: 1/4"	23650 10-16 X 1 HWH SERRATED TEK ZP HEX SIZE: 5/16"	23660 12-14 X 1-1/2 HWH SERRATED TEK ZP HEX SIZE: 5/16"	23672 1/4-14 X 2 HWH SERRATED TEK ZP HEX SIZE: 3/8"				

IBS, INCORPORATED

Teks® Screw Assortments Z02



Hex Washer Head Tek® Screws

- Forged drill point starts and drills its own hole without center punching - will not walk.
- Self-tapping threads actually form their own threads.
- Zinc plated to protect against rust and corrosion.
- Eliminates hole alignment problems.
- Drills, taps and fastens in one easy motion.
- Fasten metal to metal and a wide range of other materials including wood, synthetics and mechanical components to metal

Assortment
IBS No. 709R • 20 Items
1075 Pieces
Packaged in a locking steel drawer for
easy storage & organization.

Length	Diameter				
	6-20	8-18	10-16	12-14	1/4-14
3/8	84356				
1/2	84358	8436	8440		
5/8					
3/4	84359	8438	8442	8449	8452
1	84357	8439	8443	8450	8453
1-1/4		84390	84431	84501	84531
1-1/2		84392	8445	8451	8454
2		84397	84452	84511	8455*
2-1/2			8446	84512	8456*
3			8447	84513	8457*
4					8458*
Pkg Qty	100	100	100	100	100 / 50*
Hex Size	1/4	1/4	5/16	5/16	3/8

IBS, Inc.
SPECIALTY PRODUCTS FOR MAINTENANCE & SERVICE
 WWW.IBSINC.COM © 92 800-878-1998

Hex Washer Head Teks Screws

Assortment No. 709R

8436 8-18 X 1/2 HEX WASHER HD TEK ZP	8438 8-18 X 3/4 HEX WASHER HD TEK ZP	8439 8-18 X 1 HEX WASHER HD TEK ZP	84390 8-18 X 1-1/4 HEX WASHER HD TEK ZP	84392 8-18 X 1-1/2 HEX WASHER HD TEK ZP
Hex Size: 1/4"	Hex Size: 1/4"	Hex Size: 1/4"	Hex Size: 1/4"	Hex Size: 1/4"
8440 10-16 X 1/2 HEX WASHER HD TEK ZP	8442 10-16 X 3/4 HEX WASHER HD TEK ZP	8443 10-16 X 1 HEX WASHER HD TEK ZP	84431 10-16 X 1-1/4 HEX WASHER HD TEK ZP	8445 10-16 X 1-1/2 HEX WASHER HD TEK ZP
Hex Size: 5/16"	Hex Size: 5/16"	Hex Size: 5/16"	Hex Size: 5/16"	Hex Size: 5/16"
8449 12-14 X 3/4 HEX WASHER HD TEK ZP	8450 12-14 X 1 HEX WASHER HD TEK ZP	84501 12-14 X 1-1/4 HEX WASHER HD TEK ZP	8451 12-14 X 1-1/2 HEX WASHER HD TEK ZP	84511 12-14 X 2 HEX WASHER HD TEK ZP
Hex Size: 5/16"	Hex Size: 5/16"	Hex Size: 5/16"	Hex Size: 5/16"	Hex Size: 5/16"
8452 1/4-14 X 3/4 HEX WASHER HD TEK ZP	8453 1/4-14 X 1 HEX WASHER HD TEK ZP	84531 1/4-14 X 1-1/4 HWH TEK ZP	8454 1/4-14 X 1-1/2 HEX WASHER HD TEK ZP	8455 1/4-14 X 2 HEX WASHER HD TEK ZP
Hex Size 3/8"	Hex Size 3/8"	Hex Size 3/8"	Hex Size 3/8"	Hex Size 3/8"

T
A
P
P
I
N
G

S
C
R
E
W
S



IBS, INCORPORATED

Tek® Screws E16

Phillips Pan Head Tek® Screws

- Forged drill point starts and drills its own hole without center punching - will not walk.
- Self-tapping threads actually form their own threads.
- Zinc plated to protect against rust and corrosion.
- Eliminates hole alignment problems.
- Drills, taps and fastens in one easy motion.
- Fasten metal to metal and a wide range of other materials including wood, synthetics and mechanical components to metal.



Length	Diameter			Length
	6-20	8-18	10-16	
1/2	8427	8428	8433	1/2
3/4	8426	8430	8435	3/4
1	8425	8431	84351	1
1-1/2		8432	8437	1-1/2
Qty	100	100	100	Qty

Phil Pan & K-Lath Tek Screws Assortment (Z02)

IBS No. 778R • 17 Items — 1250 Pcs
 Packaged in a locking steel drawer for easy storage & organization.

IBS Inc. PHILLIPS PAN HEAD & K-LATH TEK SCREWS Assortment No. 778R

Part No.	Description	Part No.	Description	Part No.	Description	Part No.	Description	Part No.	Description
8427	6-20 X 1/2 PHIL PAN HD TEK ZP	8426	6-20 X 3/4 PHIL PAN HD TEK ZP	8425	6-20 X 1 PHIL PAN HD TEK ZP	8428	8-18 X 1/2 PHIL PAN HD TEK ZP	8430	8-18 X 3/4 PHIL PAN HD TEK ZP
8431	8-18 X 1 PHIL PAN HD TEK ZP	8432	8-18 X 1-1/2 PHIL PAN HD TEK ZP	8433	10-16 X 1/2 PHIL PAN HD TEK ZP	8435	10-16 X 3/4 PHIL PAN HD TEK ZP	84351	10-16 X 1 PHIL PAN HD TEK ZP
8437	10-16 X 1-1/2 PHIL PAN HD TEK ZP	12790	8 X 1-1/2 PHIL K-LATH TEK ZP	12791	8 X 3/4 PHIL K-LATH TEK ZP	12792	8 X 1 PHIL K-LATH TEK ZP	12793	8 X 1-1/4 PHIL K-LATH TEK ZP
12794	8 X 1-5/8 PHIL K-LATH TEK ZP	12795	8 X 2 PHIL K-LATH TEK ZP						

HWH Tek® Screws with Neoprene Washer



Length	Diameter		Length
	#10	#14	
3/4	8528	8549	3/4
1	8530	8550	1
Qty	100	100	Qty
Hex Size	5/16	3/8	Hex Size

Phillips Pan Head Tek® Screws, SS



Length	Diameter				
	#6	#8	#10	#12	#14
1/2	12740	12745	12750		
3/4	12741	12746	12751	12755	12760
1	12742	12747	12752*	12756	12761
1-1/4				12757*	12762*
1-1/2		12748*	12753*	12758*	12763*
2'					12764*
Qty	100	100/50*	100/50*	50/25*	50/25*

Phil Pan Hd Tek® S.S. Assortment (Z08)

IBS No. 310R • 21 Items — 825 Pcs
 Packaged in a locking steel drawer for easy storage & organization.

IBS Inc. PHILLIPS PAN HEAD TEK SCREWS Assortment No. 310R

Part No.	Description	Part No.	Description	Part No.	Description	Part No.	Description	Part No.	Description
12740	6 X 1/2 PHIL PAN TEK SS	12741	6 X 3/4 PHIL PAN TEK SS	12742	6 X 1 PHIL PAN TEK SS	12745	8 X 1/2 PHIL PAN TEK SS	12746	8 X 3/4 PHIL PAN TEK SS
12747	8 X 1 PHIL PAN TEK SS	12748	8 X 1-1/2 PHIL PAN TEK SS	12750	10 X 1/2 PHIL PAN TEK SS	12751	10 X 3/4 PHIL PAN TEK SS	12752	10 X 1 PHIL PAN TEK SS
12753	10 X 1-1/2 PHIL PAN TEK SS	12755	12 X 3/4 PHIL PAN TEK SS	12756	12 X 1 PHIL PAN TEK SS	12757	12 X 1-1/4 PHIL PAN TEK SS	12758	12 X 1-1/2 PHIL PAN TEK SS
12760	14 X 3/4 PHIL PAN TEK SS	12761	14 X 1 PHIL PAN TEK SS	12762	14 X 1-1/4 PHIL PAN TEK SS	12763	14 X 1-1/2 PHIL PAN TEK SS	12764	14 X 2 PHIL PAN TEK SS

TAPPING SCREWS

IBS, INCORPORATED

Tek® Screws SS I23



Square Drive Pan Head Tek® Screws

Assortment (Z08)

IBS No. 312R • 14 Items • 650 Pcs
Packaged in a locking steel drawer for
easy storage & organization.

Length	Diameter			Length
	8-18	10-16	12-14	
1/2	8627	8633		1/2
5/8				5/8
3/4	8629	8635	8640	3/4
1	8630	8636	8641	1
1-1/4	8631	8637	8642	1-1/4
1-1/2	8632	8638	8643	1-1/2
2		8639		2
Use with Bit	#2 Sq Drive 250R2 or 250-R12	#2 Sq Drive 250R2 or 250-R12	#3 Sq Drive 250R3 or 250-R13	Use with Bit
Qty	100	100	50	Qty

IBS, Inc.		Square Drive Pan Head TEK Screws	
SPECIALTY PRODUCTS FOR MAINTENANCE & REPAIR		Assortment No. 312R	
8627 8 X 1/2 SQUARE DRIVE PN TEK ZP	8629 8 X 3/4 SQUARE DRIVE PN TEK ZP	8630 8 X 1 SQUARE DRIVE PAN TEK ZP	8631 8 X 1-1/4 SQUARE DRIVE PAN TEK
8632 8 X 1-1/2 SQUARE DRIVE PAN TEK	8633 10 X 1/2 SQUARE DRIVE PAN TEK	8635 10 X 3/4 SQUARE DRIVE PAN TEK	8636 10 X 1 SQUARE DRIVE PAN TEK ZP
8637 10 X 1-1/4 SQUARE DRIVE PAN	8638 10 X 1-1/2 SQUARE DRIVE PAN	8640 12 X 3/4 SQUARE DRIVE PAN TEK	8641 12 X 1 SQUARE DRIVE PAN TEK ZP
8642 12 X 1-1/4 SQUARE DRIVE PAN	8643 12 X 1-1/2 SQUARE DRIVE PAN		



Square Drive Pan Head Tek® Screws SS

Assortment (Z08)

IBS No. 313R • 20 Items • 590 Pcs
Packaged in a locking steel drawer for
easy storage & organization.

Length	Diameter				
	#6	#8	#10	#12	#14
3/8	12800	12804			
1/2	12801	12805	12811		
5/8		12806	12812		
3/4	12802	12807	12813	12818	12823
1	12803	12808	12814	12819	12824
1-1/4		12809*	12815	12820*	12825
1-1/2		12810*	12816	12821*	12826
1-3/4					
2			12817	12822*	12827
Use with Bit	#1 Sq Drive 250R1 or 250R11	#2 Sq Drive 250R2 or 250-R12	#2 Sq Drive 250R2 or 250-R12	#3 Sq Drive 250R3 or 250-R13	
Qty	50	100/50*	50	50/25*	25

IBS, Inc.		Stainless Steel Square Drive Pan Head TEK Screws	
SPECIALTY PRODUCTS FOR MAINTENANCE & REPAIR		Assortment No. 313R	
12801 6 X 1/2 SQUARE DR PAN TEK	12802 6 X 3/4 SQUARE DR PAN TEK	12803 6 X 1 SQUARE DR PAN TEK SCREW	12805 8 X 1/2 SQUARE DR PAN TEK
12807 8 X 3/4 SQUARE DR PAN TEK	12808 8 X 1 SQUARE DR PAN TEK SCREW	12810 8 X 1-1/2 SQUARE DR PAN TEK	12811 10 X 1/2 SQUARE DR PAN TEK
12813 10 X 3/4 SQUARE DR PAN TEK	12814 10 X 1 SQUARE DR PAN TEK	12816 10 X 1-1/2 SQUARE DR PAN TEK	12817 10 X 2 SQUARE DR PAN TEK
12818 12 X 3/4 SQUARE DR PAN TEK	12819 12 X 1 SQUARE DR PAN TEK	12821 12 X 1-1/2 SQUARE DR PAN TEK	12822 12 X 2 SQUARE DR PAN TEK
12823 14 X 3/4 SQUARE DR PAN TEK	12824 14 X 1 SQUARE DR PAN TEK	12826 14 X 1-1/2 SQUARE DR PAN TEK	12827 14 X 2 SQUARE DR PAN TEK

TAPPING SCREWS



IBS, INCORPORATED

Tek® Screws SS I23

Hex Washer Head Tek® Screws, SS

SS Assortment (Z08)

IBS No. 311R • 13 Items — 525 Pcs
Packaged in a locking steel drawer for
easy storage & organization.



Length	Diameter					Length
	#6	#8	#10	#12	#14	
1/2		12770	12774			1/2
3/4	12768	12771	12775	12780	12785	3/4
1	12769	12772	12776	12781	12786	1
1-1/4		12773	12777	12782	12787	1-1/4
1-1/2		12830	12778	12783	12788	1-1/2
2`		12831	12832	12784	12789	2
2-1/2			12833	12835	12838	2-1/2
3			12834	12836	12839	3
4				12837	12840	4
Qty		100	50	25	25	Qty
Hex Size		1/4	5/16	5/16	3/8	Hex Size

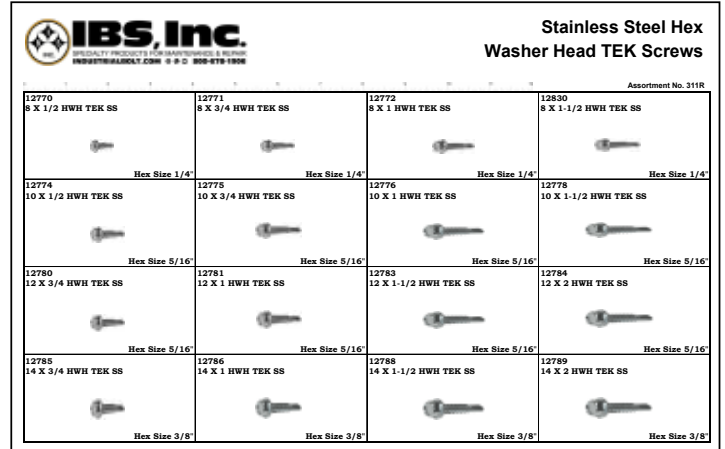

T
A
P
P
I
N
G
S
C
R
E
W
S

K-Lath Modified Truss Head Screw (E16)



- Commonly known as K-Lath Screw, modified truss head screws are used for a variety of wood and 20-16 gauge metal applications.
- For attaching metal lath in stucco and other applications to steel studs.

Length	Diameter
	#8
1/2	12790
3/4	12791
1	12792
1-1/4	12793
1-5/8	12794
2`	12795
Qty	100



Driver Bits

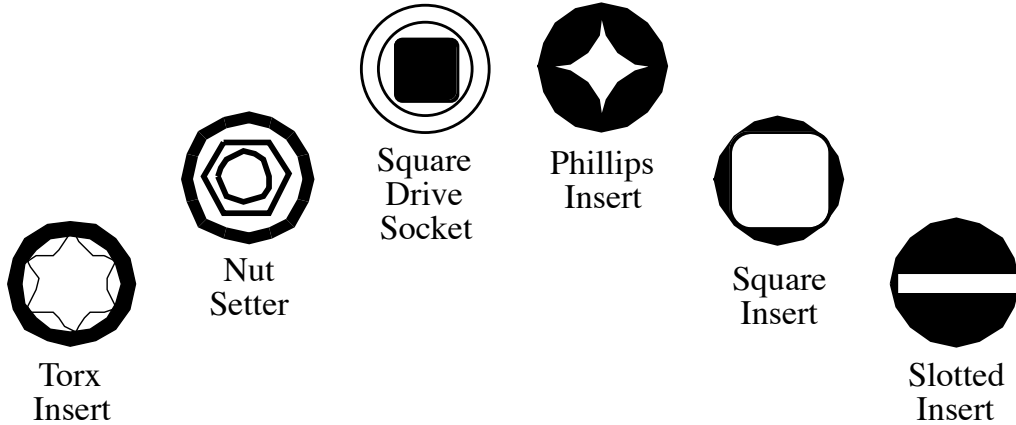

- Insert bits "float" slightly in the holder, providing easier alignment with the screw recess and reduced bit wear.
- Bits are precision-built of special shock-resistant, heat-treated and tempered steel to insure the proper combination of hardness and toughness.

1/4" Hex Drive Nut-Setters & Bit Holders

- For driving hex head self drilling fasteners & insert bits
- Magnetic



IBS No.	Description	Broached Hex Size	Nose Dia.	Qty
MSH1/4	1/4 Hex Drive - Short	1/4 x 1-1/4	7/16	1
MSH5/16	1/4 Hex Drive - Short	5/16 x 1-3/4	1/2	1
MSH3/8	1/4 Hex Drive - Short	3/8 x 1-3/4	9/16	1
MSHL1/4	1/4 Hex Drive - Long	1/4 x 2-9/16	7/16	1
MSHL5/16	1/4 Hex Drive - Long	5/16 x 2-9/16	1/2	1
MSHL3/8	1/4 Hex Drive - Long	3/8 x 2-9/16	9/16	1
MSHL7/16	1/4 Hex Drive - Long	7/16 x 2-9/16	5/8	1
MSHL1/2	1/4 Hex Drive - Long	1/2 x 2-9/16	3/4	1
MBHL25225	Bit Holder - 2-1/4 Long	1/4 x 2-1/4	3/8	1
MBHL2530	Bit Holder - 3 Long	1/4 x 3	3/8	1
MBHL2560	Bit Holder - 6 Long	1/4 x 6	3/8	1
MBHL25120	Bit Holder - 12 Long	1/4 x 12	3/8	1

Combo Quick Change Bit Holder

IBS No. 140341

- Quick change chuck design provides fast and easy changeout of accessories.
- Accepts all 1/4" quick change accessories — including standard 1" insert bits!
- Quick snap design for one handed assembly.
- Pull sleeve backward to release - easy removal!





IBS, INCORPORATED

Driver Bits P12

T
A
P
P
I
N
G
S
C
R
E
W
S

Slotted Screw Style Insert Bits



IBS No.	Screw Size	Shank	Length	Qty
250SS4	#4	1/4	1	1
250SS5	#5	1/4	1	1
250SS6	#6	1/4	1	1
250SS8	#8	1/4	1	1
250SS10	#10	1/4	1	1
250SS12	#12	1/4	1	1

Slotted Screw Style Power Bits



IBS No.	Screw Size	Shank	Length	Qty
250SSP6	6-8	1/4	1-15/16	1
250SSP8	8-10	1/4	1-15/16	1
250SSP63	6-8	1/4	3	1
250SSP83	8-10	1/4	3	1
250SSP66	6-8	1/4	6	1
250SSP106	10-12	1/4	6	1

Square Recess Insert Bits



IBS No.	Point Size	Shank	Length	Qty
250R1	1	1/4	1	1
250R2	2	1/4	1	1
250R3	3	1/4	1	1

Square Recess Power Bits



IBS No.	Point Size	Shank	Length	Qty
250-R11	1	1/4	1-15/16	1
250-R12	2	1/4	1-15/16	1
250-R13	3	1/4	1-15/16	1
84-R1	1	1/4	3	1
84-R2	2	1/4	3	1
84-R3	3	1/4	3	1
250-R61	1	1/4	6	1
250-R62	2	1/4	6	1
250-R63	3	1/4	6	1

Phillips Recess Insert Bits



IBS No.	Point Size	Shank	Length	Qty
250-PB1	1	1/4	1	1
250-PB2	2	1/4	1	1
250-PB3	3	1/4	1	1
312PB2	2	5/16	1-1/4	1
312PB3	3	5/16	1-1/4	1

Phillips Recess Power Bits



IBS No.	Point Size	Shank	Length	Qty
250-PB11	1	1/4	1-15/16	1
250-PB12	2	1/4	1-15/16	1
250-PB13	3	1/4	1-15/16	1
250-PB31	1	1/4	3-1/2	1
250-PB32	2	1/4	3-1/2	1
250-PB33	3	1/4	3-1/2	1
250-PB61	1	1/4	6	1
250-PB62	2	1/4	6	1
250-PB63	3	1/4	6	1

Torx Insert Bits



IBS No.	Point Size	Shank	Length	Qty
60-T15	T15	1/4	1	1
60-T20	T20	1/4	1	1
60-T25	T25	1/4	1	1
60-T30	T30	1/4	1	1
60-T40	T40	1/4	1	1
61-T30	T30	5/16	1-1/4	1
61-T40	T40	5/16	1-1/4	1

Torx Power Bits



IBS No.	Point Size	Shank	Length	Qty
60-PB15	T15	1/4	1-15/16	1
60-PB20	T20	1/4	1-15/16	1
60-PB25	T25	1/4	1-15/16	1
60-PB30	T30	1/4	1-15/16	1
60-PB40	T40	1/4	1-15/16	1



Security Hex Driver Bits



1/4 x 1 HEX WITH PIN SECURITY DRIVER BITS

IBS No.	Size	Use With	Qty
12944	3/32	#4 Screws	2
12945	1/8	#6 Screws	2
12946	5/32	1/8 - 1/4 Screws	2
12947	3/16	5/16 Screws	2
12948	7/32	3/8 Screws	2

Security Torx Driver Bits



1/4 x 1 TORX WITH PIN SECURITY DRIVER BITS

IBS No.	Size	Use With	Qty
12936	T9	#5 - #6 Screws	2
12937	T10	#6 - #8 Screws	2
12938	T15	#8 - #10 Screws	2
12939	T20	#8 Screw	2
12940	T25	#10 - #12 Screws	2
12942	T30	1/4 Screw	2
12943	T40	5/16 - 3/8 Screw	2

Security Phillips Driver Bits



1/4 x 1 PHILLIPS WITH PIN SECURITY DRIVER BITS

IBS No.	Size	Use With	Qty
12949	#2	#5 - #10 Screws	2
12950	#3	#12-#16 & 1/4 Screws	2

Square Drive Sockets



SQUARE DRIVE SOCKETS - 1/4 HEX SHANK

IBS No.	Description	Nose Dia.	Qty
SSA-5	3" External Adapter with Ball Lock	1/4	1
SSA-4	4" External Adapter with Durable Pin Lock	1/4	1
SSA-6	3" External Adapter with Durable Pin Lock	3/8	1
SSA-7	2" External Adapter with Durable Pin Lock	1/2	1

Spin-It-Out Damaged Screw Removers (T03)

The perfect tool for removing stripped and broken or damaged screws. The Spin-It-Out Damaged Screw Remover is extremely easy to operate. A Spin-It-Out extractor bit and a drill motor in reverse make light work of removing stripped out Phillips, Torx, Square Drive, Posi-Drive or even Tri-Wing head screws.

- Removes stripped and broken screws, saving time and money.
- The serrated design on the tip aggressively bites into damaged screws or drills into broken bolts helping to make broken screw removal faster and easier.
- Made of high quality M2 high speed steel for exceptional strength, making them strong enough to drill into hardened bolts.
- Number size corresponds with the number sizes of Phillips Head Screws.



SPIN-IT-OUT DAMAGED SCREW REMOVERS

IBS No.	Description	Qty
133310	Spin-It-Out 5 Pc Set	1

SPIN-IT-OUT REPLACEMENT BITS

IBS No.	Description	Qty
133311	#0 Spin-It-Out Extractor Bit	1
133312	#1 Spin-It-Out Extractor Bit	1
133313	#2 Spin-It-Out Extractor Bit	1
133314	#3 Spin-It-Out Extractor Bit	1
133315	#4 Spin-It-Out Extractor Bit	1

TAPPING SCREWS



























IBS, INCORPORATED

Assortments (Z02)

Driver Bits Assortment

IBS No. 641P • 24 Items • 62 Pcs.











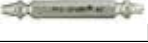







Packaged in a locking steel drawer for easy storage & organization.

IBS, Inc. SPECIALTY PRODUCTS FOR MAINTENANCE & REPAIR INDUSTRIALBOLT.COM 800-678-1906					Insert Driver Bits
Assortment No. 641P					
MSH1/4 1/4 MAGNETIC NUT DRIVER 	MSHL5/16 5/16 MAGNETIC NUT DRIVER 	250-PB3 1/4 HEX PHILLIPS BITS #3 	60-T20 1/4 HEX TORX 20 	250R1 1/4 HEX SQ DRIVE #1 	MBHL25225 1/4 X 2-1/4 MAG. DRIVER BIT 
MSH5/16 5/16 MAGNETIC NUT DRIVER 	MSHL3/8 3/8 MAGNETIC NUT DRIVER 	250-PB11 #1 PHIL X 1-15/16 POWER BIT 	60-T25 1/4 HEX TORX 25 	250R2 1/4 HEX SQ DRIVE #2 	133319 #2 GRABIT BIT 
MSH3/8 3/8 MAGNETIC NUT DRIVER 	250-PB1 1/4 HEX PHILLIPS BITS #1 	250-PB12 #2 PHIL X 1-15/16 POWER BIT 	60-T30 1/4 HEX TORX 30 	250R3 1/4 HEX SQ DRIVE #3 	133320 #3 GRABIT BIT 
MSHL1/4 1/4 MAGNETIC NUT DRIVER 	250-PB2 1/4 HEX PHILLIPS BIT #2 	250-PB13 #3 PHIL X 1-15/16 POWER BIT 	60-T40 1/4 HEX TORX 40 	SSA-5 1/4 HEX-1/4 SQ DR 2-9/16" EXT 	140341 COMBO QUICK CHANGE BIT HOLDER 

Power Bits Assortment

IBS No. 712R • 17 Items • 30 Pcs.

Packaged in a locking steel drawer for easy storage & organization.

IBS, Inc. SPECIALTY PRODUCTS FOR MAINTENANCE & REPAIR INDUSTRIALBOLT.COM 800-678-1906					Power Bits
Assortment No. 712R					
133319 #2 GRABIT BIT 	250SSP63 1/4 X 3 #6-8 SLOT POWER BIT 	250SSP66 1/4x6 #6-8 SLOT POWER BIT 			
140341 COMBO QUICK CHANGE BIT HOLDER 	250SSP83 1/4 X 3 #8-10 SLOT POWER BIT 	250SSP106 1/4 X 6 #10-12 SLOT POWER BIT 			
250-PB11 #1 PHIL X 1-15/16 POWER BIT 	250-PB31 #1 PHIL X 3-1/2 POWER BIT 	250-PB61 #1 X 6 PHILLIPS POWER DRIVER 			
250-PB12 #2 PHIL X 1-15/16 POWER BIT 	250-PB32 #2 PHIL X 3-1/2 POWER BIT 	250-PB62 #2 X 6 PHILLIPS POWER DRIVER 			
250-PB13 #3 PHIL X 1-15/16 POWER BIT 	250-PB33 #3 PHIL X 3-1/2 POWER BIT 	250-PB63 #3 X 6 PHILLIPS POWER DRIVER 			
MBHL25225 1/4 X 2-1/4 MAG. DRIVER BIT 	MBHL2530 1/4 X 3 MAG DRIVER BIT HOLDER 	MBHL2560 1/4 X 6 MAG DRIVER BIT HOLDER 			

TAPPING SCREWS



Impact Torsion Bits

- Innovatively designed flex tech torsion zone absorbs high torque stress and reduces bit fracture make these bits perfect for use with impact drivers for faster and easier screw driving and assembly saving time and money.
- Proprietary tool steel and heat treat process for maximum strength and durability ensures superior service life even under extreme conditions saving money in bits and change-out time.
- Hardened S2 Modified Impact Resistant Steel for extended bit life.
- CNC milled magnetic tips make for precision mating with screws offering a supreme grip with minimal slippage for faster, easier and safer screw driving saving time and money.

1/4" Impact Torsion Hex Drive Nut-Setters & Bit Holders

Magnetic Impact Nut Driver



IBS No.	Size	Length	Qty
21055	1/4	2-9/16"	1
21056	5/16	2-9/16"	1
21057	3/8	2-9/16"	1
21058	7/16	2-9/16"	1
21059	1/2	2-9/16"	1

Magnetic Driver Bit Holder



IBS No.	Size	Length	Qty
21060	1/4	3"	1
21061	1/4	6"	1

Hex Sq Drive Socket Adapter



IBS No.	Hex	Square Drive	Extension	Qty
21062	1/4	1/4	2-9/16"	1
21063	1/4	3/8	2-9/16"	1
21064	1/4	1/2	2-7/8"	1

Phillips Impact Insert Bits



IBS No.	Point Size	Shank	Length	Qty
21001	1	1/4	1	1
21002	2	1/4	1	1
21003	3	1/4	1	1

Phillips Impact Recess Power Bits



IBS No.	Point Size	Shank	Length	Qty
21004	1	1/4	1-15/16	1
21005	2	1/4	1-15/16	1
21006	3	1/4	1-15/16	1
21007	1	1/4	3-1/2	1
21008	2	1/4	3-1/2	1
21009	3	1/4	3-1/2	1
21010	1	1/4	6	1
21011	2	1/4	6	1
21012	3	1/4	6	1

Quick Release Impact Magnetic Bit Holder



IBS No.	Description	Qty
21066	Quick Release Impact Magnetic Bit Holder	1

HD Magnetic Bit & Screw Holder



IBS No.	Description	Qty
21065	Heavy Duty Magnetic Bit & Screw Holder	1

TAPPING SCREWS



IBS, INCORPORATED

Impact Torsion Bits P12

T
A
P
P
I
N
G

S
C
R
E
W
S

Square Impact Insert Bits



IBS No.	Sq Size	Shank	Length	Qty
21017	#1	1/4	1	1
21018	#2	1/4	1	1
21019	#3	1/4	1	1

Square Impact Recess Power Bits



IBS No.	Point Size	Shank	Length	Qty
21020	1	1/4	1-15/16	1
21021	2	1/4	1-15/16	1
21022	3	1/4	1-15/16	1
21024	1	1/4	3	1
21025	2	1/4	3	1
21026	3	1/4	3	1
21027	1	1/4	6	1
21028	2	1/4	6	1
21029	3	1/4	6	1

Hex Torx Impact Power Bits



IBS No.	Point Size	Shank	Length	Qty
21037	T15	1/4	1-15/16"	1
21038	T20	1/4	1-15/16"	1
21039	T25	1/4	1-15/16"	1
21040	T30	1/4	1-15/16"	1
21041	T40	1/4	1-15/16"	1
21042	T15	1/4	3-1/2"	1
21043	T20	1/4	3-1/2"	1
21044	T25	1/4	3-1/2"	1
21045	T30	1/4	3-1/2"	1
21046	T40	1/4	3-1/2"	1
21047	T15	1/4	6"	1
21048	T20	1/4	6"	1
21049	T25	1/4	6"	1
21050	T30	1/4	6"	1
21051	T40	1/4	6"	1

Torx Impact Insert Bits



IBS No.	Point Size	Shank	Length	Qty
21031	T15	1/4	1"	1
21032	T20	1/4	1"	1
21033	T25	1/4	1"	1
21034	T30	1/4	1"	1
21035	T40	1/4	1"	1

42 Pc Impact Torsion Bit Set

IBS No. 21071 • 42 Items • 24 Pcs.



- **Innovatively designed flex tech torsion zone absorbs high torque stress and reduces bit fracture** make these bits perfect for use with impact drivers for faster and easier screw driving and assembly saving time and money.
- **Proprietary tool steel and heat treat process for maximum strength and durability** ensures superior service life even under extreme conditions saving money in bits and change-out time.
- **Hardened S2 Modified Impact Resistant Steel** for extended bit life.
- **CNC milled magnetic tips make for precision mating with screws offering a supreme grip with minimal slippage** for faster, easier and safer screw driving saving time and money.

SET INCLUDES

- Magnetic bit drivers
- Socket Adapters,
- Phillips, Square, Slotted and Torx Bits in multiple sizes

IBS, INCORPORATED

























Assortments Z02



Impact Torsion Phillips & Square Bit Assortment

IBS No. 812R • 24 Items • 37 Pcs.





















Packaged in a locking steel drawer for easy storage & organization.

 IBS, Inc. <small>SPECIALTY PRODUCTS FOR MAINTENANCE & REPAIR INDUSTRIALBOLT.COM © 300-678-1506</small>		Impact Torsion Phillips and Square Bits	
Assortment No. 812R			
21001 #1 PHILLIPS INSERT BIT 	21004 #1 X 1-15/16 PHILLIPS POWER BIT 	21007 #1 X 3-1/2 PHILLIPS POWER BIT 	21010 #1 X 6 PHILLIPS POWER BIT 
21002 #2 PHILLIPS INSERT BIT 	21005 #2 X 1-15/16 PHILLIPS POWER BIT 	21008 #2 X 3-1/2 PHILLIPS POWER BIT 	21011 #2 X 6 PHILLIPS POWER BIT 
21003 #3 PHILLIPS INSERT BIT 	21006 #3 X 1-15/16 PHILLIPS POWER BIT 	21009 #3 X 3-1/2 PHILLIPS POWER BIT 	21012 #3 X 6 PHILLIPS POWER BIT 
21017 #1 SQUARE INSERT BIT 	21020 #1 X 1-15/16 SQUARE POWER BIT 	21024 #1 X 3-1/2 SQUARE POWER BIT 	21027 #1 X 6 SQUARE POWER BIT 
21018 #2 SQUARE INSERT BIT 	21021 #2 X 1-15/16 SQUARE POWER BIT 	21025 #2 X 3-1/2 SQUARE POWER BIT 	21028 #2 X 6 SQUARE POWER BIT 
21019 #3 SQUARE INSERT BIT 	21022 #3 X 1-15/16 SQUARE POWER BIT 	21026 #3 X 3-1/2 SQUARE POWER BIT 	21029 #3 X 6 SQUARE POWER BIT 

Impact Torsion Torx & Bit Holders Assortment

IBS No. 813R • 24 Items • 31 Pcs.

Packaged in a locking steel drawer for easy storage & organization.

 IBS, Inc. <small>SPECIALTY PRODUCTS FOR MAINTENANCE & REPAIR INDUSTRIALBOLT.COM © 300-678-1506</small>		Impact Torsion Torx and Bit Holders	
Assortment No. 813R			
21031 T15 TORX INSERT BIT 	21037 T15 X 1-15/16 TORX POWER BIT 	21042 T15 X 3-1/2 TORX POWER BIT 	21047 T15 X 6 TORX POWER BIT 
21032 T20 TORX INSERT BIT 	21038 T20 X 1-15/16 TORX POWER BIT 	21043 T20 X 3-1/2 TORX POWER BIT 	21048 T20 X 6 TORX POWER BIT 
21033 T25 TORX INSERT BIT 	21039 T25 X 1-15/16 TORX POWER BIT 	21044 T25 X 3-1/2 TORX POWER BIT 	21049 T25 X 6 TORX POWER BIT 
21034 T30 TORX INSERT BIT 	21040 T30 X 1-15/16 TORX POWER BIT 	21045 T30 X 3-1/2 TORX POWER BIT 	21050 T30 X 6 TORX POWER BIT 
21035 T40 TORX INSERT BIT 	21041 T40 X 1-15/16 TORX POWER BIT 	21046 T40 X 3-1/2 TORX POWER BIT 	21051 T40 X 6 TORX POWER BIT 
21065 HEAVY DUTY MAGNETIC BIT AND SCREW HOLDER	21066 COMBO QUICK CHANGE BIT HOLDER 3"	21060 1/4 X 3 MAGNETIC DRIVER BIT HOLDER	21061 1/4 X 6 MAGNETIC DRIVER BIT HOLDER

TAPPING SCREWS



IBS, INCORPORATED

Sealants & Adhesives S02

DriveGrip Anti Cam-Out Fluid

IBS No. 52010 0.5 FL oz. Tube

Drive Grip makes removing and tightening screws and other fasteners a breeze. A single drop creates a positive grip between the metal surfaces of the fastener head and drive tool. Works great in applications where fastener heads or drives are worn or damaged.

Drive Grip increases the grip strength between the fastener head and tool by as much as **700%** and virtually eliminates tool wear, rounding and deforming of fasteners

APPLICATIONS:

- Aids in the removal of rusted or “frozen-in-place” screws and bolts that won’t budge.
- Use Drive Grip in conjunction with all types of screwdrivers, hex keys, pliers, channel locks, vise grips, sockets, as well as open-end and box-end wrenches

BENEFITS:

- Economical: Spares the time and expense involved with drilling out screws, using “easy outs” or possibly having to re-tap holes.
- Simplifies Operation: Works with standard screwdrivers, reducing the need for specially designed screwdrivers, reamers, or drilling out damaged screws.
- Averts injury: Helps reduce fatigue and extreme effort that leads to injury.
- Protects Surrounding Surfaces: Prevents driver slippage.



Works with all types of screws:

Phillips™, Slotted, Hex, Square, Torx®



No need to drill out or use pliers on stubborn screws.

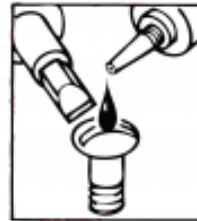

Prevents screwdriver from slipping and causing damage.

T
A
P
P
I
N
G
S
C
R
E
W
S

IBS, INCORPORATED

Assortments Z02



DriveGrip & Insert Bits Assortment

IBS No. 787R 10 Items • 19 Pcs















Packaged in a locking plastic travel tray for easy storage & organization

					Drive Grip and Insert Bits
Assortment 787R					
84-R1 1/4 HEX X 3 SQ DRIVE #1 POINT  	84-R3 1/4 HEX LONG SQ DRIVE #3  	60-PB25 1/4 HEX TORX 25 POWER BIT  	250-PB31 #1 PHIL X 3-1/2 POWER BIT  	250-PB33 #3 PHIL X 3-1/2 POWER BIT  	52010 DRIVE GRIP ANTI CAM OUT FLUID .5FL OZ  
84-R2 1/4 X 3 #2 SQ.DRIVE BIT  	60-PB20 1/4 HEX TORX 20 POWER BIT  	60-PB30 1/4 HEX TORX 30 POWER BIT  	250-PB32 #2 PHIL X 3-1/2 POWER BIT  		

DriveGrip & Nutserts Assortment

IBS No. 788R 6 Items • 9 Pcs

Packaged in a locking travel tray for easy storage & organization

					Drive Grip and Nut Setters
Assortment 788R					
MSHL1/4 1/4 MAGNETIC NUT DRIVER 2-9/16 OAL  	MSHL5/16 5/16 MAGNETIC NUT DRIVER 2-9/16 OAL  	MSHL3/8 3/8 MAGNETIC NUT DRIVER 2-9/16 OAL  	MSHL7/16 7/16 MAGNETIC NUT DRIVER 2-9/16 OAL  	MSHL1/2 1/2 MAGNETIC NUT DRIVER 2-9/16 OAL  	52010 DRIVE GRIP ANTI CAM OUT FLUID .5FL OZ  
					

TAPPIING SCREWS



IBS, INCORPORATED

Driver Bits P12

GrabitPro[®] Damaged Screw Remover

The GrabitPro quickly and easily removes most damaged screws such as Hex, Phillips, Torx, and Square Drive from wood, plastic or metal up to 3 inches in length. The serrated extracting end of the tool results in greater torque for hard to remove bolts and screws. The design of the shaft make them compatible with "quick change" chuck systems or can be chucked directly into a drill. Good for multiple extractions with a single tool.

FEATURES & BENEFITS

- The two ended design with a drill bit and extractor in one tool eliminates the need for multiple tools saving time and money.
- There is no bolt preparation required, such as grinding, smoothing, cutting, center punching or pre-drilling, making for a faster and more convenient repair.
- Self-centering drill tip eliminates walking or wandering, saving time and frustration.
- Works on jagged, uneven, and rough breaks where standard drills could chip or break.
- Tempered twice for extra hardness proving a tools with a longer life resulting in multiple extractions per tool saving time and money.
- Four (4) piece kit. Removes screw sizes AN4 to AN24, bolt sizes SAE 10 to 12, 1/4", 5/16", and 3/8" (Metric M5 to M10).
- Made in the U.S.A.

T
A
P
P
I
N
G
S
C
R
E
W
S

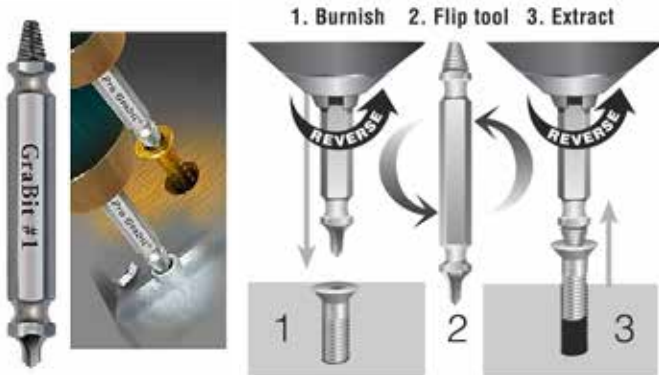

OPERATING INSTRUCTIONS

Burnishing

1. Insert GRABIT directly into drill or chuck - burnishing end is showing.
2. Set drill for reverse.
3. Place burnishing end of tool into damaged screw head until smooth.
4. NOTE: Burnishing end is not to be used to drill a hole.

Removing

1. Remove burnishing end from chuck, flip tool, replace into drill chuck — Remover end now showing.
2. Maintain reverse setting.
3. Place Remover end of tool into now smooth screw head.
4. Apply firm downward pressure, drill at slow speed. Apply lowest level of power to the hand drill.
5. Remover end of GRABIT will thread into screw head and remove.

IBS No.	Description	Qty	For Screw Sizes
133318	#1 Grabit Pro	1	No. 4 to No. 7
133319	#2 Grabit Pro	1	No 8 to No. 10
133320	#3 Grabit Pro	1	No. 11 to No. 14
133321	#4 Grabit Pro	1	No. 16 to No. 24

Grabit Damaged Screw Remover & DriveGrip Assortment

IBS No. 794R 5 Items • 5 Pcs
Packaged in a locking plastic travel tray for easy storage & organization



WARNING:

Always wear safety glasses when operating or near power tools. Cutting tools may shatter when broken.



Grabit® Drill-Out Broken Bolt Extractor Set

Removing stripped screws and bolts can be a frustrating experience, and now there's a solution! This 4 pc extractor kit removes broken bolts from as small as 1/4" to 1/2" (6mm-12mm) and can drill up to Grade 8 or 10.9 class fasteners. Each Drill-Out is a drill bit and extractor in one and is uniquely designed to drill into the rough surfaces when bolts break.

SINGLE STEP EXTRACTION FAST & EASY TO USE

A drill bit and extractor in one tool, the DRILL-OUT creates a unique interaction between drill bit and extractor, resulting in maximum impact and break out ability. Broken bolts and studs are removed quickly and easily without damaging the fastener threads.

- **Unique drill tip** allows the tool to stay on center.
- **Self-centering drill tip eliminates** walking or wandering.
- **No grinding, center punching or pilot hole** required.
- **Works** on jagged, uneven and rough breaks.
- **Tempered twice for extra hardness;** resulting in multiple extractions per tool.
- **Made from the highest quality M2 HSS Steel.**
- **MADE IN THE USA.**



IBS No.	Description	Qty
133309	Grab-It Drill Out Extractor 4 Pc Set 1/4" to 1/2" (6mm to 12mm)	1

USE IN REVERSE ONLY WHILE DRILLING OR EXTRACTING

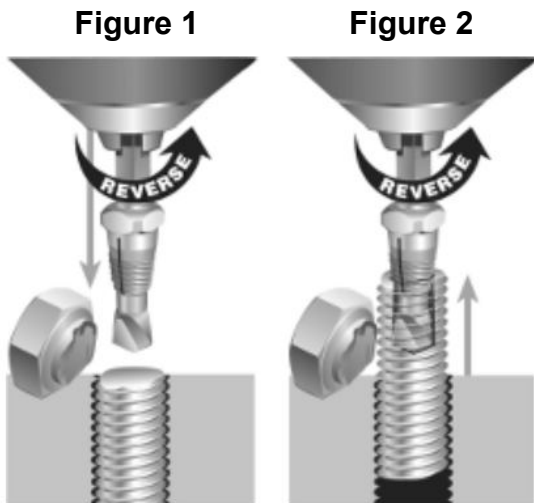

DRILLING:

1. Choose the correct size DRILL-OUT.
2. Secure round end in the drill chuck and tighten.
3. Thread collet/extractor back against drill chuck.
4. Set drill in reverse and begin drilling at the suggested RPM's.(see Figure 1)

REMEMBER: Hole must be straight & on center.

DO NOT allow collet/extractor to move down toward tip while drilling.

5. Stop drilling just before the collet/extractor reaches the broken bolt. (See Figure 2)
6. Apply penetrating oil to help loosen bolt.

WARNING:

Always wear safety glasses when operating or near power tools. Cutting tools may shatter when broken.

TAPPING SCREWS



IBS, INCORPORATED

Driver Bits P12

Flexible Extension



T
A
P
P
I
N
G
S
C
R
E
W
S

Flexible drive bit or drill bit extension holds any 1/4" hex shank bit to access tight or hard to reach areas. Can be used for drilling, driving, tapping or with any rotary tool with a 1/4" hex shank.

- Flexible extension flexes to a full 90 degrees allowing for access in tight and hard to reach areas saving time and money.
- Easy load quick disconnect provides fast and easy changeout of accessories and holds them in place eliminating lost tools.
- Outer cover does not rotate so it can be used safely at any speed and held by hand directing the operation exactly where it needs to be.
- 11" long for optimal reach and control.
- Rated for 13 ft. lbs. of torque makes this a powerful tool for most jobs.
- Can be used with standard 1" insert bits and power bits for added convenience and versatility.
- Standard 1/4" shank fits standard electric and cordless drills or screwdrivers.

FLEXIBLE EXTENSION

IBS No.	Description	Qty
73614	Flexible Extension	1



Wood Screws General Information

- **Sharp, leader points for easy entry.**
- **Sharp, hardened threads.**
- **Deep, twist resistant slots.**
- **Greater resistance to snapping and breakage.**
- **Made of zinc plated steel to prevent corrosion.**

When using screws to join wood, it is necessary to bore pilot holes, especially in hardwoods. Pilot holes make it easier to drive the screws and reduce the chance of damaging either the screws or the wood.

Bore the holes large enough so that they freely accommodate the screw shank in the first piece of wood. In the second piece of wood bore the holes slightly smaller than the thread diameters to a depth of half the length of the threaded portion. The screw length should be at least 1/8" less than the combined measurement of the joined material.

WOOD SCREW HOLE SIZE RECOMMENDATIONS

Screw Size	Pilot Holes		Soft Woods		Shank Clearance Holes		Countersink
	Twist Drill	Drill GA No. ²	Twist Bit ¹	Drill GA No. ²	Twist Bit ¹	Drill GA No. ²	Auger Bit No. ³
0	1/32	66	1/64	75	1/16	52	—
1	—	57	1/32	71	5/16	47	—
2	—	54	1/32	65	3/32	42	3
3	1/16	53	3/64	58	7/64	37	4
4	1/16	53	3/64	58	7/64	37	4
5	5/64	47	1/16	53	1/8	30	4
6	—	44	1/16	52	9/64	27	5
7	—	39	1/16	51	5/32	22	5
8	7/64	35	5/64	48	11/64	18	6
9	7/64	33	5/64	45	3/16	14	6
10	1/8	31	3/32	43	3/16	10	6
11	—	29	3/32	40	13/64	4	7
12	—	25	7/64	38	7/32	2	7
14	3/16	14	7/64	32	1/4	D	8
16	—	10	9/64	29	17/64	I	9
18	13/64	6	9/64	26	19/64	N	10
20	7/32	3	11/64	19	21/64	P	11
24	1/4	D	3/16	15	3/8	V	12

¹Nearest size in fractions of an inch.
²To be used for maximum holding power.
³To counterbore for sinking head (by 16ths).

WOOD SCREWS



IBS, INCORPORATED

Wood Screws

PHILLIPS FLAT HEAD (F03)



Length	Diameter						
	#4	#5	#6	#8	#10	#12	#14
1/2			8797	8811			
5/8			8798	8812			
3/4	8789	9794	8799	8813	8829	8845	
1	8790	8796	8801	8815	8831	8846	
1-1/4			8802	8816	8832	8847	8860
1-1/2			8803	8817	8833	8848	8861
1-3/4				8818	8834		
2			8805	8819	8835	8850	8863
2-1/2				8821	8837	8851	8864
3				8823	8839	8852	8865

W
O
O
D

S
C
R
E
W
S



Machine Screws

E

Fasteners

Machine Screws

Hex Head Machine Screws G-2

Hex Head Unslotted G-2

Phillips Flat Head G-5

Phillips Pan Head G-4

Phillips Round Head G-3

Slotted Round Head G-3

Metric Machine Screws

Phillips Pan Head Metric Machine Screws G-5

Slotted Pan Head Metric Machine Screws G-3

Stainless Steel

Phillips Flat Head Machine Screws SS G-5

Phillips Oval Head Machine Screws SS G-6

Phillips Pan Head Machine Screws SS (G-4

S

Screws, Machine

Hex Head Unslotted G-2

Metric

Phillips Pan Head Metric Machine Screws G-5

Slotted Pan Head Metric Machine Screws G-3

Phillips

Flat Head G-5

Pan Head G-4

Round Head G-3

Slotted

Round Head G-3

Stainless

Phillips Flat Head G-5

Phillips Oval Head G-6

Phillips Pan Head G-4



IBS, INCORPORATED

Hex Head Machine Screws G03

Measurement of Machine Screws

The length of all screws is measured from the largest diameter of the bearing surface to the extreme point.

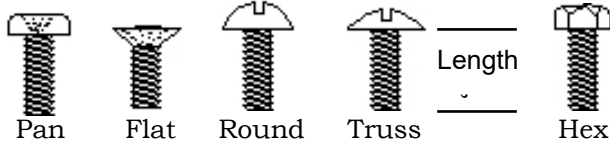

Threads Per Inch Table

THREADS PER INCH TABLE

Size	Coarse UNC	Fine UNF	Basic Major Dia.
0	—	80	.0600
1	64	72	.0730
2	56	64	.0860
3	48	56	.0990
4	40	48	.1120
5	40	44	.1250
6	32	40	.1380
8	32	36	.1640
10	24	32	.1900
12	24	28	.2160
1/4	20	28	.2500
5/16	18	24	.3125

MACHINE SCREWS

Hex Head Unslotted Machine Screws



Zinc Plated (G03)

- Zinc plated for anti-rust protection.
- Sharp hex head prevents wrench slippage.
- Threads are feather-free for faster, easier assembly.
- **SOLD IN PACKAGES OF 100.**

HEX HEAD UNSLOTTED MACHINE SCREWS

Size	4-40	6-32	8-32	10-24	10-32	1/4-20
1/4	NS	9669	9679	NS	NS	
3/8	NS	9671	9681	9693	9707	
1/2	NS	9672	9682	9694	9708	NS
3/4	NS	9674	9684	9696	9710	NS
1		NS	9686	9698	9712	NS
1-1/4			NS		NS	NS
1-1/2			9688	NS	9714	NS
2				NS	9715	NS

Stainless Steel (I25)

- Deep twist-resistant slots eliminate screwdriver slippage.
- Threads are feather-free for faster and easier assemblies.
- Stainless steel construction.

Size	6-32	8-32	10-24	10-32	Qty
1/4					-
3/8	NS	NS	NS	NS	-
1/2	12701	12709	12717	12727	50
5/8	NS	NS	NS	NS	-
3/4	12703	12711	12719	12729	50
1	12704	12712	12721	12731	50
1-1/4			NS	NS	-
1-1/2			NS	NS	-
2			NS		-

IBS, INCORPORATED

Slotted Machine Screws G01



Slotted Round Head



- Deep, twist-resistant slots eliminate screw driver slippage
- Threads are feather-face for faster and easier assemblies.
- Zinc plated for anti-rust protection.
- **SOLD IN PACKAGES OF 100.**

Size	2-56	4-40	6-32	8-32	10-24	10-32	12-24	1/4-20	5/16-18	3/8-16	Size
1/4	NS	9016	9041	9061	9081	9105					1/4
3/8	NS	9018	9043	9063	9083	9107	NS	9147			3/8
1/2	NS	9019	9044	9064	9084	9108	9132	9148	NS		1/2
5/8		NS	9045	9065	9085	9109	NS	9149			5/8
3/4		9021	9046	9066	9086	9110	9134	9150	NS	9192	3/4
1		9023	9048	9068	9088	9112	9136	9152	NS	9194	1
1-1/4		NS	9049	9069	9089	9113	9137	9153	NS	NS	1-1/4
1-1/2		9025	9050	9070	9090	9114	9138	9154	NS	NS	1-1/2
1-3/4			NS	NS	NS	NS		9155	NS	NS	1-3/4
2			9052	9072	9116	9116	9140	9156	NS	NS	2
2-1/2			9054	NS	9118	9118	NS	9158	NS	NS	2-1/2
3			9056	NS	9120	9120	NS	9160	NS	NS	3
4			9058		NS	NS		9162	NS	NS	4
5								NS	NS	NS	5

Slotted Round Head Machine Screws (Z02)

IBS No. 105R • 24 Items
2050 Pcs

IBS, Inc. Slotted Round Head Machine Screws					
Assortment No. 105R					
5033 6-32 HEX MACHINE SCREW NUT ZP	5034 8-32 HEX MACHINE SCREW NUT ZP	5036 10-32 HEX MACHINE SCREW NUT ZP	5035 10-24 HEX MACHINE SCREW NUT ZP	9089 10-24 X 1-1/4 SLTD ROUND HD	9134 12-24 X 3/4 SLTD ROUND HD M/S
9044 6-32 X 1/2 SLTD ROUND HD M/S	9064 8-32 X 1/2 SLTD ROUND HD M/S	9108 10-32 X 1/2 SLTD ROUND HD M/S	9084 10-24 X 1/2 SLTD ROUND HD M/S	9090 10-24 X 1-1/2 SLTD ROUND HD	9136 12-24 X 1-1/2 SLTD ROUND HD M/S ZP
9046 6-32 X 3/4 SLTD ROUND HD M/S	9066 8-32 X 3/4 SLTD ROUND HD M/S	9110 10-32 X 3/4 SLTD ROUND HD M/S	9086 10-24 X 3/4 SLTD ROUND HD M/S	5037 12-24 HEX MACHINE SCREW NUT ZP	9137 12-24 X 1-1/4 SLTD ROUND HD
9048 6-32 X 1 SLTD ROUND HD M/S ZP	9068 8-32 X 1 SLTD ROUND HD M/S ZP	9112 10-32 X 1 SLTD ROUND HD M/S ZP	9088 10-24 X 1 SLTD ROUND HD M/S ZP	9132 10-24 X 1-1/2 SLTD ROUND HD M/S	9138 12-24 X 1-1/2 SLTD ROUND HD

Metric Slotted Pan Head Machine Screws (H11)

- Threads are feather-face for faster and easier assemblies.
- Zinc plated for anti-rust protection.
- **SOLD IN PACKAGES OF 100.**



Size	M3 x .5	M4 x .7	M5 x .8	M6 x 1.0
M6	10628	10645	10664	
M8	10629	10646	10665	
M10	10630	10647	10666	10687
M12	10631	10648	10667	10688
M16	10633	10650	10669	10690
M20	10635	10652	10671	10692
M22		10654	10673	
M25		10655	10674	10694

Phillips Round Head (G02)

- Threads are feather-face for faster and easier assemblies.
- Zinc plated for anti-rust protection.
- Phillips drive provides for strip-free driving.
- **SOLD IN PACKAGES OF 100.**



Size	6-32	8-32	10-24	10-32	1/4-20
1/4	9565	9573	NS	NS	
3/8	9567	9575	9583	9590	NS
1/2	9568	9576	9584	9591	9599
3/4	9570	9578	9586	9593	9601
1	NS	9580	9588	9595	9603
1-1/2	NS	NS	NS	NS	9605
2	NS	NS	NS	NS	9607
3			9585		9598
4			9587		9608

MACHINE SCREWS

IBS, INCORPORATED

Phillips Machine Screws G02



Metric Phillips Pan Head Machine Screws (H12)

- Threads are feather-face for faster and easier assemblies.
- Zinc plated for anti-rust protection.
- **SOLD IN PACKAGES OF 100.**



Assortment with Flat Washers & Nuts (Z02)

IBS No. 715R • 24 Items - 1,455 Pcs

Size	M4 x .7	M5 x .8	M6 x 1.0	M8 x 1.25
M6	10711			
M8	10712	601		
M10	10713	602	10730	
M12	10714	603	10731	
M14				
M16	10716	604	10733	10750
M20	10718	606	10735	10752
M25	10720	607	10737	10754
M30	10721	608	10738	10755

IBS Inc. SPECIALTY PRODUCTS & MANUFACTURING & SERVICE INDUSTRIAL MARKETING CORP. 9-9-0 800-878-1888						Metric Phillips Pan Head Machine Screws Flat Washers & Nuts					
Assortment No. 715R											
10713 M4-.7 X 10 PHIL PAN M/S ZP	10716 M4-.7 X 16 PHIL PAN M/S ZP	10718 M4-.7 X 20 PHIL PAN M/S ZP	10721 M4-.7 X 30 PHIL PAN M/S ZP	10664 M4 FLAT WASHER ZP	10699 M4-.7 FIN HEX NUT CL8 ZP	602 M5-.8 X 10 PHIL PAN M/S ZP	604 M5-.8 X 16 PHIL PAN M/S ZP	606 M5-.8 X 20 PHIL PAN M/S ZP	608 M5-.8 X 30 PHIL PAN M/S ZP	10665 M5 FLAT WASHER ZP	10600 M5-.8 FIN HEX NUT CL8 ZP
10730 M6-1.0 X 10 PHIL PAN M/S ZP	10733 M6-1.0 X 16 PHIL PAN M/S ZP	10735 M6-1.0 X 20 PHIL PAN M/S ZP	10738 M6-1.0 X 30 PHIL PAN M/S ZP	10666 M6 FLAT WASHER ZP	10601 M6-1.0 FIN HEX NUT CL8 ZP	10750 M8-1.25 X 16 PHIL PAN M/S ZP	10752 M8-1.25 X 20 PHIL PAN M/S ZP	10754 M8-1.25 X 25 PHIL PAN M/S ZP	10755 M8-1.25 X 30 PHIL PAN M/S ZP	10668 M8 FLAT WASHER ZP	10603 M8-1.25 FIN HEX HUT CL8 ZP

Phillips Flat Head (G02)

- Threads are feather-face for faster and easier assemblies.
- Zinc plated for anti-rust protection.
- Phillips drive provides for strip-free driving.
- **SOLD IN PACKAGES OF 100.**



Assortment (Z02)

IBS No. 391R • 20 Items - 1,655 Pcs

Size	6-32	8-32	10-24	10-32	1/4-20
1/4	9610	9620	NS	NS	NS
3/8	9612	9622	NS	9637	NS
1/2	9613	9623	9630	9638	9645
3/4	9615	9625	9632	9640	9647
1	9617	9627	9634	9642	9649
1-1/2	9618	9628	9635	9643	9651
2	9619	9629	9636	9644	9653
3			9639		
4			9641		

IBS Inc. PHILLIPS FLAT HEAD					Phillips Flat Head Machine Screws				
Assortment No. 391R									
9612 6-32 X 3/8 PHIL FLAT HD M/S ZP	9622 8-32 X 3/8 PHIL FLAT HD M/S ZP	9630 10-24 X 1/2 PHIL FLAT HD M/S	9638 10-32 X 1/2 PHIL FLAT HD M/S	9647 1/4-20 X 3/4 PHIL FLAT HD M/S	9613 6-32 X 1/2 PHIL FLAT HD M/S ZP	9623 8-32 X 1/2 PHIL FLAT HD M/S ZP	9632 10-24 X 3/4 PHIL FLAT HD M/S	9640 10-32 X 3/4 PHIL FLAT HD M/S	9649 1/4-20 X 1 PHIL FLAT HD M/S ZP
9615 6-32 X 3/4 PHIL FLAT HD M/S ZP	9625 8-32 X 3/4 PHIL FLAT HD M/S ZP	9634 10-24 X 1 PHIL FLAT HD M/S ZP	9642 10-32 X 1 PHIL FLAT HD M/S ZP	9651 1/4-20 X 1-1/2 PHIL FLAT HD M/S	9617 6-32 X 1 PHIL FLAT HD M/S ZP	9627 8-32 X 1 PHIL FLAT HD M/S ZP	9637 10-32 X 3/8 PHIL FLAT HD M/S	9645 1/4-20 X 1/2 PHIL FLAT HD M/S	9653 1/4-20 X 2 PHIL FLAT HD M/S ZP

Phillips Flat Head Machine Screws SS (I18)

- Threads are feather-face for faster and easier assemblies.
- Stainless steel construction.
- Phillips drive provides for strip-free driving.



Size	6-32	8-32	10-24	10-32	1/4-20	Qty
1/4	12271	NS	NS	NS	NS	50
3/8	12273	12287	12301	12314	12326	50
1/2	12275	12289	12303	12316	12328	50
3/4	12277	12291	12305	12318	12330	50
1	12279	12293	12307	12320	12332	50
1-1/4	NS	12294	12308	12321	12333	25
1-1/2	NS	12295	12309	12322	12334	25
2	NS	NS	NS	NS	12335	25

MACHINE SCREWS



IBS, INCORPORATED

Phillips Machine Screws SS I18

Phillips Oval Head Machine Screws SS (I18)

- Threads are feather-face for faster and easier assemblies.
- Stainless steel construction.
- Phillips drive provides for strip-free driving.



PHILLIPS OVAL HEAD MACHINE SCREWS SS

Size	4-40	6-32	8-32	10-24	10-32	1/4-20	Qty
1/4	NS	12376					50
3/8	NS	12378	12392	NS			50
1/2	NS	12380	12394	12408	12421	12433	50
5/8	NS		NS		12422		50
3/4	NS	12382	12396	12410	12423	12435	50
1	NS	12384	12398	12412	12425	12437	50
1-1/4				12414	NS	12438	25
1-1/2			12400		12427	12439	25
2						12440	25

M
A
C
H
I
N
E
S
C
R
E
W
S



Metric Fasteners

A

Assortments

- Class 8.8 Metric
 - 440P•Fasteners - 40B H-7
 - 480P•Fasteners - 72B H-8
- Class 10.9 Metric
 - 481P•Fasteners - 72B H-10
- J.I.S. Fasteners Assortment H-18
- Machine Screw Sized Nuts & Washers H-19
- Screws, Machine
 - Metric Phillips Pan Hd Machine Screws,
Flat Washers & Nuts H-14
 - Phillips Flat Head Machine Screws H-14
- Socket Set Screw
 - Metric H-21

C

Capscrews

- Fine Pitch Class 10.9 H-11
- Metric H-15
 - Cl 8.8 Crse Thread H-6, H-9, H-11, H-15, H-16
 - Fine Pitch Class 8.8 H-6
 - Fine Thread Class 10.9 Zinc Plated H-11
 - Reg Pitch Class 8.8 ZP H-6
- Metric Socket H-16
- Set Screws H-16

F

Fasteners

- Metric
 - Conversion of Fasteners H-3
 - Converting PSI to MPa H-4
 - General Information H-2
 - Mechanical Properties Defined H-5
- Metric Capscrews
 - Coarse Thread Class 8.8 ZP H-6, H-9, H-11, H-15, H-16
- Metric Hex Flange Bolts
 - 10.9 Zinc Plate H-19
- Metric Hex Nuts H-12
- Metric Stainless Steel
 - Capscrews H-20
 - Finished Hex Nuts H-20
 - Flat Washers H-20
 - Lock Washers H-20
 - Socket Head Capscrews H-20
 - Socket Set Screws H-21

- Metric Washers H-13
 - Flat H-13
 - Hard H-13
 - Lock H-13
 - Spring H-13

Fasteners, Steel

- JIS B1180, Heat Treated
 - Class 8.8 Zinc Plated H-17

H

Hex Nuts

- Metric H-12
- Metric, Finished
 - Fine Pitch, Class 8, ZP H-12
 - Reg. Pitch, Class 8, ZP H-12
 - Reg. Pitch, Class 10, Pln H-12
- Metric, Gr C Lock Nut
 - Reg Pitch, Class 8, ZP H-12
 - Reg Pitch, Class 10, ZP H-12
- Metric, Nyloc
 - Reg Pitch, Class 6/8, ZP H-12

J

J.I.S Fasteners

- Steel H-17, H-19

M

Metric

- Conversion Chart H-3
- General Information H-2

Metric Washers

- Flat H-13
- Hard H-13
- Lock H-13
- Spring H-13

S

Stainless Steel

- Metric H-20, H-21

W

Washers

- Metric
 - Flat H-13
 - Hard, Class 10 H-13
 - Lock Washers H-13
 - Spring H-13



IBS, INCORPORATED

Metric Information & Tables

General Information

The international system of units (commonly known as the metric system) is accepted and used world wide as the modern system of units for measurement. It is used as the international standard for all areas of science, technology, and trade.

GLOSSARY OF TERMS

- SI The International System of Units
- ISO The International Organization of Standards
- ANSI American National Standards Institute
- ASTM American Society for Testing and Materials
- ASME American Society of Mechanical Engineers
- DIN West German National Standards
- IFI Industrial Fasteners Institute
- meter (m) SI unit for length
- mega (M) SI prefix for 1 000 000 units (i.e. 1000000 = 1 MPa)
- kilo (k) SI prefix for 1000 units (i.e. 1000 m = 1 km)
- milli (m) SI prefix for 0.001 units (i.e. 0.001 m = 1 mm)
- Pitch (P) Distance between two threads in mm.
- newton (N) SI unit for force
- N/mm² newtons per square millimeter
- pascal (Pa) SI unit for mechanical pressure/stress
- MPa Megapascal (1 MPa = 1 N/mm²)
- R_m Ultimate tensile strength

METRICS

Conversion Table US Units to Metric

Type of Dimension	Metric		Converted			For quick ref
	Unit	Symbol	from:	to:	factor	Approx. factor
linear	millimeter	mm	inch	mm	25.4	25 mm = 1 in.
	meter	m	foot	m	0.3048	300 mm = 1 ft.
area	sq. millimeter	mm ²	in. ²	mm ²	645.16	645 mm ² = 1 in. ²
	sq. meter	m ²	ft. ²	m ²	0.0929	1 m ² = 11 ft. ²
Stress or pressure	megapascal	MPa N/mm ²	psi	MPa	0.00689	1 MPa = 145 psi 7 MPa = 1000 psi
temperature	Degree Celsius	°C	°F	°C	0.556 (°F-32)	0°C = 32°F 20°C = 68°F 100°C = 212°F
torque	Newton meter	Nm	in-oz in-lb ft-lb	Nm	0.00706 0.11298 1.3558	1 Nm = 140 in oz 1 Nm = 9 in lb 1.4 Nm = 1 ft lb 1 Nm = 0.75 ft lb
force	Newton	N	oz. lb.	N	0.278 4.448	1 N = 3.6 oz 4.4N = 1 lb 1 kN = 225 lb

IBS, INCORPORATED

Metric Information & Tables



Conversion of Fasteners

Specifications for metric fasteners incorporate both linear measurements and mechanical requirements so it is imperative that one looks at factors other than just the nearest major diameter of the thread. The table below compares the physical data for U.S. Grades 5 and 8 and Metric Property Classes 8.8 and 10.9. As can be seen, converting a 3/4-10 bolt to M20 results in a 13.7% stronger bolt, but converting a 1/2-13 to M12 will be 11% lower. It is important to consider this when joints are calculated with regard to high utilization of the yield stress.

When selecting fastener property classes, diameter/pitch combinations and sizes it is best to choose those which have a high usage frequency as these will generally have greater availability. Conversion to metric should be used as an opportunity to simplify your fastener program for improved economy and service.

Comparison Chart

U.S. Standard Grades and Metric Strength Classes

Tensile Load Comparison

Tensile Load in kN = $A_s \times R_m$ (1 kN = 224.8 lbs.)†

Thread Size	Major Diam mm	Stress Area mm ²	Thread Size	Stress Area mm ²	SAE Grade 5	8.8	SAE Grade 8	10.9
5-40	3.175	5.14	M3	5.03	4.25	4.02	5.32	5.23
6-32	3.505	5.86	M3.5	6.78	4.85	5.42	6.06	7.05
8-32	4.166	9.04	M4	8.78	7.48	7.02	9.35	9.13
10-24	4.826	11.31	M5	14.20	9.36	11.36	11.70	14.77
1/4-20	6.350	20.50	M6	20.10	16.97	16.08	21.21	20.90
5/16-18	7.938	33.80	M8	36.60	27.97	29.28	34.97	38.06
3/8-16	9.525	50.00	M10	58.00	41.38	46.40	51.72	60.32
7/16-14	11.112	68.60			56.77		70.97	
1/2-13	12.700	91.50	M12	84.30	75.72	67.44	94.65	87.67
9/16-12	14.288	117.00	M14	115.00	96.83	92.00	121.03	119.60
5/8-11	15.875	146.00	M16	157.00	120.83	125.60	151.03	163.28
			M18	192.00		159.36		199.68
3/4-10	19.050	216.00	M20	245.00	178.76	203.35	223.45	254.80
7/8-9	22.225	298.00	M22	303.00	246.62	251.49	308.28	315.12
1-8	25.400	391.00	M24	353.00	323.28	292.99	404.48	367.12
			M27	459.00		380.97		477.36
1 1/8-7	28.575	492.00	M30	561.00	356.27	465.63	508.96	583.44
1 1/4-7	31.750	625.00			452.28		646.55	
1 3/8-6	34.925	745.00			539.48		770.69	
			M36	817.00		678.11		849.68
1 1/2-6	38.100	907.00			656.79		938.27	

† A_s = stress area R_m = min. tensile strength

CONVERT BOTH UNC & UNF TO M (COARSE).
AVOID USING METRIC FINE THREADS WHENEVER POSSIBLE.

M
E
T
R
I
C
S



IBS, INCORPORATED

Metric Information & Tables

Converting PSI to MPa

PSI	MPa	PSI	MPa	PSI	MPa
86000	592.9	96000	661.9	130000	896.3
87000	599.8	97000	668.8	135000	930.8
88000	606.7	98000	675.7	140000	965.3
89000	613.6	99000	682.6	145000	999.7
90000	620.5	100000	689.5	150000	1034.2
91000	627.4	105000	723.9	160000	1103.2
92000	634.3	110000	758.4	170000	1172.1
93000	641.2	115000	792.9	180000	1241.1
94000	648.1	120000	827.4	190000	1310.0
95000	655.0	125000	861.8	200000	1379.0

Conversion factor
 1 psi = 0.00689 MPa (N/mm²)
 1 MPa (N/mm²) = 145 psi

YIELD LOAD COMPARISON

Yield Load in kN = As x Rp 0.2 (1 kN = 224.8 lbs)⊃>†								
Thread Size	Major Diam. mm	Stress Area mm ²	Thread Size	Stress Area mm ²	SAE Grade 5	8.8	SAE Grade 8	10.9
5-40	3.175	5.14	M3	5.03	3.26	3.22	4.61	4.73
6-32	3.505	5.86	M3.5	6.78	3.72	4.34	5.25	6.37
8-32	4.166	9.04	M4	8.78	5.74	5.62	8.10	8.25
10-24	4.826	11.31	M5	14.20	7.18	9.09	10.14	13.35
1/4-20	6.350	20.50	M6	20.10	13.01	12.86	18.38	18.89
5/16-18	7.938	33.80	M8	36.60	21.45	23.42	30.30	34.40
3/8-16	9.525	50.00	M10	58.00	31.72	37.12	44.83	54.52
7/16-14	11.112	68.60			43.53		61.50	
1/2-13	12.700	91.50	M12	84.30	58.05	53.95	82.03	79.24
9/16-12	14.288	117.00	M14	115.00	74.23	73.60	104.90	108.10
5/8-11	15.875	146.00	M16	157.00	92.63	100.48	130.90	147.58
			M18	192.00		126.72		180.48
3/4-10	19.050	216.00	M20	245.00	137.05	161.70	193.65	230.30
7/8-9	22.225	298.00	M22	303.00	189.08	199.98	267.17	284.82
1-8	25.400	391.00	M24	353.00	248.08	232.98	350.55	331.82
			M27	459.00		302.94		431.46
1 1/8-7	28.575	492.00			274.84		441.10	
			M30	561.00		370.26		527.34
1 1/4-7	31.750	625.00			349.14		560.34	
1 3/8-6	34.925	745.00			416.17		667.93	
			M36	817.00		539.22		767.98
1 1/2-6	38.100	907.00			506.67		813.17	

[†] As = stress area Rp 0.2 = min. yield strength

METRICS



Mechanical Properties Defined

Tensile strength R_m

Tensile strength on full size screws determines how much stress a screw must withstand without breaking. It is calculated as follows:

$$R_{M \text{ screw}} = \frac{F \text{ max}}{A_s} = \frac{N}{\text{mm}^2}$$

A_s = nominal stress area, which is the actual cross section that carries the load. The screw must break in this general area or in the shank when tested for tensile strength.

Yield strength R_p

Yield strength is the amount of resistance of a material to plastic deformation. In general terms, yield strength determines how much stress a screw must withstand without being permanently elongated. This applies to relatively soft materials.

0.2 limit $R_{p0.2}$ ($\sigma_{0.2}$)

The yield point of somewhat harder materials is not sharply pronounced. It is then replaced by the stress at which the permanent elongation is 0.2%. This, too, is expressed in N/mm².

Metric Tap & Clearance Hole Drill Size Chart

Metric Size	Pitch		Drill Sizes				Clearance Hole	
	Coarse	Fine	M-Coarse	U.S.	M-Fine	U.S.	Metric	U.S.
3	0.5		2.5	#40			3.4	#29
3.5	0.6		2.9	#33			3.9	#24
4	0.7		3.3	#30			4.5	#16
5	0.8		4.2	#19			5.5	7/32
6	1		5.0	#9			6.6	G
8	1.25	1	6.8	17/64	7	J	9.0	T
10	1.5	1.25	8.5	Q	8.8	11/32 (T)	11.0	27/64
12	1.75	1.25 (1.5)	10.2	J	10.8	27/64 (Z)	13.5	17/32
14	2	1.5	12.0	15/32	12.5	1/2	15.5	39/64
16	2	1.5	14.0	35/64	14.5	37/64	17.5	11/16
18	2.5	1.5	15.5	39/64	16.5	21/32	20.0	51/64
20	2.5	1.5	17.5	11/16	18.5	47/64	22.0	55/64
22	2.5	1.5	19.5	49/64	20.5	13/16	24.0	15/16
24	3	2	21.0	53/64	22.0	7/8	26.0	1 1/64
27	3	2	24.0	15/16	25.0	63/64	30.0	1 11/64
30	3.5	2	26.5	1 3/64	28.0	1 7/64	33.0	1 9/32
36	4	3	32.0	1 1/4	33.0	1 19/64	39.0	1 9/16

«Note» Use metric drill sizes whenever possible. The listed US drill sizes are as close they possibly can be. However, they may not be adequate in all circumstances.

METRICS



IBS, INCORPORATED

Metric Capscrews Class 8.8 H01

Metric Capscrews (H01)

Regular Pitch • Class 8.8 • Zinc Plated



Length	M4 (.7)	M5 (.8)	M6 (1.0)	M7 (1.0)	M8 (1.25)	M10 (1.5)	M12 (1.75)	M14 (2.0)	M16 (2.0)	M18 (2.5)	M20 (2.5)	Length
8	10000											8
10	10001	10018	10036		10078							10
12	10002	10019	10037		10079							12
14			10038									14
16	10004	10021	10039	10063	10081	10106	10132					16
20	10006	10023	10041	10065	10083	10108	10133					20
25	10008	10026	10044	10068	10086	10111	10136	10156				25
30	10012	10029	10047	10071	10089	10114	10138	10159	10172		10205	30
35	10013*	10030*	10048	10072	10090	10115	10139	10160				35
40	10014*	10031*	10049		10091	10116	10140	10161	10174		10207	40
45			10050◇		10092◇	10117◇	10141	10162	10175			45
50		10033◇	10051◇		10093◇	10118◇	10142	10163	10176	10196	10209	50
55						10119◇						55
60			10053◇		10095◇	10120◇	10144	10165	10178	10198	10211	60
65					10096◇	10121◇	10145					65
70					10097◇	10122◇	10146	10167	10180		10213	70
75					10098◇	10123◇						75
80							10148				10215	80
90							10150				10216	90
QTY	100/50*	100/50* 25◇	50/25◇	50	50/25◇	50/25◇	25	25	25	25	10	QTY

METRICS

Metric Capscrews (H06)

Fine Pitch • Class 8.8 • Plain



Length	M8 (1.0)	M10 (1.0)	M10 (1.25)	M12 (1.5)	M12 (1.25)	M14 (1.5)	Length
10	10441						10
16	10444						16
20	10446	10465	10480	10502			20
25	10449	10468	10483	10505	10524		25
30	10452	10471	10486	10508	10527	10543	30
35	10453	10472	10487	10509	10528	10544	35
40	10454	10473	10488	10510	10529	10545	40
45	10455◇						45
50	10456◇	10475◇	10490◇	10512	10531	10547	50
60	10458◇		10492◇	10514	10533	10549	60
70			10494◇		10535		70
80	10462◇		10496◇				80
QTY	50/25◇	50/25◇	50/25◇	25	25	25	QTY

IBS, INCORPORATED

Metric C/S Reg. Pitch Cl. 8.8 H01



Metric Capscrews & Nuts Class 8.8 (Z02)

IBS No. 122R • 24 Items - 500 Pieces



IBS, Inc. SPECIALTY PRODUCTS FOR MAINTENANCE & REPAIR INDUSTRIALMARKET.COM © P.O. BOX 470-1000						Metric Cap Screws & Nuts Class 8.8	
Assortment No. 122R							
10601 M6-1.0 FIN HEX NUT CLS ZP	10603 M8-1.25 FIN HEX NUT CLS ZP	10091 M8-1.25 X 40 HEX C/S 8.8 ZP	10605 M10-1.5 FIN HEX NUT CLS ZP	10116 M10-1.5 X 40 HEX C/S 8.8 ZP	10606 M12-1.75 FIN HEX NUT CLS ZP		
10047 M6-1.0 X 30 HEX C/S 8.8 ZP	10086 M8-1.25 X 25 HEX C/S 8.8 ZP	10093 M8-1.25 X 50 HEX C/S 8.8 ZP	10111 M10-1.5 X 25 HEX C/S 8.8 ZP	10118 M10-1.5 X 50 HEX C/S 8.8 ZP	10140 M12-1.75 X 40 HEX C/S 8.8 ZP		
10048 M6-1.0 X 35 HEX C/S 8.8 ZP	10089 M8-1.25 X 30 HEX C/S 8.8 ZP	10095 M8-1.25 X 60 HEX C/S 8.8 ZP	10114 M10-1.5 X 30 HEX C/S 8.8 ZP	10120 M10-1.5 X 60 HEX C/S 8.8 ZP	10142 M12-1.75 X 50 HEX C/S 8.8 ZP		
10049 M6-1.0 X 40 HEX C/S 8.8 ZP	10090 M8-1.25 X 35 HEX C/S 8.8 ZP	10097 M8-1.25 X 70 HEX C/S 8.8 ZP	10115 M10-1.5 X 35 HEX C/S 8.8 ZP	10122 M10-1.5 X 70 HEX C/S 8.8 ZP	10144 M12-1.75 X 60 HEX C/S 8.8 ZP		

8.8 Metric Capscrew Assortments (Z06)

IBS No. 143P • 72 Items
2453 Pieces

Arranged in a labeled
18 drawer metal cabinet



8.8 METRIC CAPSCREW ASSORTMENT

Capscrews	Hex Nuts	Flat & Lock Washers
M5-0.8 x 10, 12, 20, 25, 30, 40	M5-.08	M5
M6-1.0 x 10, 16, 20, 25, 30, 40, 50	M6-1.0	M6
M8-1.25 x 16, 20, 25, 30, 35, 40, 45, 50, 60	M8-1.25	M8
M10-1.5 x 20, 25, 30, 35, 40, 45, 50, 60	M10-1.5	M10
M12-1.75 x 20, 25, 30, 35, 40, 50, 60	M12-1.75	M12
M14-2.0 x 25, 30, 35, 40, 50, 60	M14-2.0	M14
M16-2.0 x 30, 35, 40, 50, 60, 70	M16-2.0	M16

METRICS

Metric 8.8 Hex Capscrews, Nuts & Washers (Z06)

IBS No. 440P • 40 Items
1,680 pieces
Arranged in a labeled
40 hole bin



Metric 8.8 Fasteners

IBS, Inc. SPECIALTY PRODUCTS FOR MAINTENANCE & REPAIR INDUSTRIALMARKET.COM © P.O. BOX 470-1000								Metric 8.8 Fasteners	
Assortment No. 440P									
10600 M5-.8 FIN HEX NUT CLS ZP	10565 M6 FLAT WASHER ZP	10581 M8 LOCKWASHER ZP	10018 M5-.8 X 10 HEX C/S 8.8 ZP	10019 M5-.8 X 12 HEX C/S 8.8 ZP	10023 M5-.8 X 20 HEX C/S 8.8 ZP	10026 M5-.8 X 25 HEX C/S 8.8 ZP	10029 M5-.8 X 30 HEX C/S 8.8 ZP		
10601 M6-1.0 FIN HEX NUT CLS ZP	10566 M6 FLAT WASHER ZP	10582 M8 LOCKWASHER ZP	10037 M6-1.0 X 12 HEX C/S 8.8 ZP	10039 M6-1.0 X 16 HEX C/S 8.8 ZP	10041 M6-1.0 X 20 HEX C/S 8.8 ZP	10044 M6-1.0 X 25 HEX C/S 8.8 ZP	10047 M6-1.0 X 30 HEX C/S 8.8 ZP		
10603 M8-1.25 FIN HEX NUT CLS ZP	10568 M8 FLAT WASHER ZP	10584 M8 LOCKWASHER ZP	10081 M8-1.25 X 16 HEX C/S 8.8 ZP	10083 M8-1.25 X 20 HEX C/S 8.8 ZP	10086 M8-1.25 X 25 HEX C/S 8.8 ZP	10089 M8-1.25 X 30 HEX C/S 8.8 ZP	10091 M8-1.25 X 40 HEX C/S 8.8 ZP		
10605 M10-1.5 FIN HEX NUT CLS ZP	10569 M10 FLAT WASHER ZP	10585 M10 LOCKWASHER ZP	10108 M10-1.5 X 20 HEX C/S 8.8 ZP	10111 M10-1.5 X 25 HEX C/S 8.8 ZP	10114 M10-1.5 X 30 HEX C/S 8.8 ZP	10116 M10-1.5 X 40 HEX C/S 8.8 ZP	10118 M10-1.5 X 50 HEX C/S 8.8 ZP		
10606 M12-1.75 FIN HEX NUT CLS ZP	10570 M12 FLAT WASHER ZP	10586 M12 LOCKWASHER ZP	10133 M12-1.75 X 20 HEX C/S 8.8 ZP	10138 M12-1.75 X 30 HEX C/S 8.8 ZP	10140 M12-1.75 X 40 HEX C/S 8.8 ZP	10142 M12-1.75 X 50 HEX C/S 8.8 ZP	10144 M12-1.75 X 60 HEX C/S 8.8 ZP		



IBS, INCORPORATED

Bin Assortments Z06

Metric 8.8 Fasteners

Metric 8.8 Hex Capscrews, Nuts & Washers

IBS No. 808P • 72 Items
3,275 pieces
Arranged in a labeled
80 hole bin



Assortment No. 808P							
10600 M5-8 FIN HEX NUT CL8 ZP	10601 M6-1.0 FIN HEX NUT CL8 ZP	10603 M8-1.25 FIN HEX NUT CL8 ZP	10605 M10-1.5 FIN HEX NUT CL8 ZP	10606 M12-1.75 FIN HEX NUT CL8 ZP	10607 M14-2.0 FIN HEX NUT CL8 ZP	10608 M16-2.0 FIN HEX NUT CL8 ZP	10610 M20-2.5 FIN HEX NUT CL8 ZP
10565 M5 FLAT WASHER ZP	10566 M6 FLAT WASHER ZP	10568 M8 FLAT WASHER ZP	10569 M10 FLAT WASHER ZP	10570 M12 FLAT WASHER ZP	10571 M14 FLAT WASHER ZP	10572 M16 FLAT WASHER ZP	10573 M20 FLAT WASHER ZP
10581 M5 LOCKWASHER ZP	10582 M6 LOCKWASHER ZP	10584 M8 LOCKWASHER ZP	10585 M10 LOCKWASHER ZP	10586 M12 LOCKWASHER ZP	10587 M14 LOCKWASHER ZP	10588 M16 LOCKWASHER ZP	10590 M20 LOCKWASHER ZP
10018 M5-1.0 X 12 HEX C/S 8.8 ZP	10037 M6-1.0 X 12 HEX C/S 8.8 ZP	10081 M8-1.25 X 16 HEX C/S 8.8 ZP	10108 M10-1.5 X 20 HEX C/S 8.8 ZP	10136 M12-1.75 X 25 HEX C/S 8.8 ZP	10159 M14-2.0 X 30 HEX C/S 8.8 ZP	10172 M16-2.0 X 30 HEX C/S 8.8 ZP	10205 M20-2.5 X 30 HEX C/S 8.8 ZP
10019 M5-8 X 12 HEX C/S 8.8 ZP	10039 M6-1.0 X 16 HEX C/S 8.8 ZP	10083 M8-1.25 X 20 HEX C/S 8.8 ZP	10111 M10-1.5 X 25 HEX C/S 8.8 ZP	10138 M12-1.75 X 30 HEX C/S 8.8 ZP	10160 M14-2.0 X 35 HEX C/S 8.8 ZP	10174 M16-2.0 X 40 HEX C/S 8.8 ZP	10207 M20-2.5 X 40 HEX C/S 8.8 ZP
10021 M5-8 X 16 HEX C/S 8.8 ZP	10041 M6-1.0 X 20 HEX C/S 8.8 ZP	10086 M8-1.25 X 25 HEX C/S 8.8 ZP	10114 M10-1.5 X 30 HEX C/S 8.8 ZP	10139 M12-1.75 X 35 HEX C/S 8.8 ZP	10161 M14-2.0 X 40 HEX C/S 8.8 ZP	10175 M16-2.0 X 45 HEX C/S 8.8 ZP	10209 M20-2.5 X 50 HEX C/S 8.8 ZP
10023 M5-8 X 20 HEX C/S 8.8 ZP	10044 M6-1.0 X 25 HEX C/S 8.8 ZP	10089 M8-1.25 X 30 HEX C/S 8.8 ZP	10115 M10-1.5 X 35 HEX C/S 8.8 ZP	10140 M12-1.75 X 40 HEX C/S 8.8 ZP	10162 M14-2.0 X 45 HEX C/S 8.8 ZP	10176 M16-2.0 X 50 HEX C/S 8.8 ZP	10211 M20-2.5 X 60 HEX C/S 8.8 ZP
10026 M5-8 X 25 HEX C/S 8.8 ZP	10047 M6-1.0 X 30 HEX C/S 8.8 ZP	10091 M8-1.25 X 40 HEX C/S 8.8 ZP	10116 M10-1.5 X 40 HEX C/S 8.8 ZP	10142 M12-1.75 X 50 HEX C/S 8.8 ZP	10163 M14-2.0 X 50 HEX C/S 8.8 ZP	10178 M16-2.0 X 60 HEX C/S 8.8 ZP	10213 M20-2.5 X 70 HEX C/S 8.8 ZP
10029 M5-8 X 30 HEX C/S 8.8 ZP	10049 M6-1.0 X 40 HEX C/S 8.8 ZP	10093 M8-1.25 X 50 HEX C/S 8.8 ZP	10118 M10-1.5 X 50 HEX C/S 8.8 ZP	10144 M12-1.75 X 60 HEX C/S 8.8 ZP	10165 M14-2.0 X 60 HEX C/S 8.8 ZP	10180 M16-2.0 X 70 HEX C/S 8.8 ZP	10215 M20-2.5 X 80 HEX C/S 8.8 ZP
10031 M5-8 X 40 HEX C/S 8.8 ZP	10051 M6-1.0 X 50 HEX C/S 8.8 ZP	10095 M8-1.25 X 60 HEX C/S 8.8 ZP	10120 M10-1.5 X 60 HEX C/S 8.8 ZP	10146 M12-1.75 X 70 HEX C/S 8.8 ZP	10167 M14-2.0 X 70 HEX C/S 8.8 ZP	10182 M16-2.0 X 80 HEX C/S 8.8 ZP	10216 M20-2.5 X 90 HEX C/S 8.8 ZP

M
E
T
R
I
C
S

IBS, INCORPORATED

Metric C/S Reg. Pitch Cl. 10.9 - H02



Metric Capscrews

Regular Pitch • Class 10.9 • Zinc Plated



Length	M6 (1.0)	M8 (1.25)	M10 (1.5)	M12 (1.75)	M14 (2.0)	M16 (2.0)	M20 (2.5)	M24 (3.0)	M30 (3.0)	Length
12	10250									12
16	10252	10270	10291							16
20	10254	10271	10292	10315						20
25	10257	10272	10293	10316						25
30	10258	10273	10294	10317	10340	10358	10374			30
35	10259	10274	10295	10318	10341	10359	10375			35
40	10260	10275	10296	10319	10342	10360	10376	10389		40
45	10261	10276	10297	10320	10343	10361	10377			45
50	10262	10277	10298	10321	10344	10362	10378	10391		50
55		10278								55
60	10265	10279	10300	10323	10346	10364	10380	10392		60
70	10266	10281	10302	10325	10347	10366	10382	10393		70
75			10303	10326	103470	10367				75
80	10267	10282	10304	10327	10348	10368	10384	10395		80
90	10268	10283	10305	10328	10349	10370	10385	10396		90
100	10269	10284	10306	10329	10350	10371	10387	10397	103984	100
110		10285	10307	10330	10351	10372	10388	103970	103985	110
120		10286	10308	10331	10352	10373	103880	103971	103986	120
130						103730	103881	103972	103987	130
140						103731	103882	103973	103988	140
150						103732	103883	103974	103989	150
160						103733	103884	103975	103990	160
170						103734		103976		170
180						103735	103886	103977	103992	180
190						103736		103978		190
200						103737	103888	103979	103994	200
QTY	50	50	50	25	25	25	10	10	5	QTY

M
E
T
R
I
C
S

10.9 Metric Capscrew Assortment (Z06)

IBS No. 144P • 68 Items

1323 Pieces

Arranged in a labeled
18 drawer metal cabinet.



Capscrews	Hex Nuts	Flat & Lock Washers
M6-1.0 x 12, 16, 20, 25, 30, 25, 40, 45, 50	M6-1.0	M6
M8-1.25 x 16, 20, 25, 30, 35, 40, 45, 50, 60, 70	M8-1.25	M8
M10-1.5 x 20, 25, 30, 35, 40, 45, 50, 60, 70	M10-1.5	M10
M12-1.75 x 25, 30, 35, 40, 50, 60, 70	M12-1.75	M12
M16-2.0 x 35, 40, 50, 60, 70, 80, 90	M16-2.0	M16



IBS, INCORPORATED

Bin Assortments Z06

**Metric 10.9 Hex Capscrews,
Nuts & Washers**
COARSE THREAD — ZINC PLATED
IBS No. 441P • 40 Items - 900 pieces
Arranged in a labeled 40 hole bin



IBS, Inc.								Metric 10.9 Fasteners							
Assortment No. 441P															
10410 M6-1.0 FIN HEX NUT CL10 ZP	10430 M6 HARD WASH TP200 ZP	10582 M6 LOCKWASHER ZP	10292 M6-1.0 X 16 HEX C/S 10.9 ZP	10294 M6-1.0 X 20 HEX C/S 10.9 ZP	10297 M6-1.0 X 25 HEX C/S 10.9 ZP	10298 M6-1.0 X 30 HEX C/S 10.9 ZP	10299 M6-1.0 X 40 HEX C/S 10.9 ZP	10411 M6-1.25 FIN HEX NUT CL10 ZP	10431 M6 HARD WASH TP200 ZP	10584 M6 LOCKWASHER ZP	10271 M6-1.25 X 20 HEX C/S 10.9 ZP	10272 M6-1.25 X 25 HEX C/S 10.9 ZP	10273 M6-1.25 X 30 HEX C/S 10.9 ZP	10275 M6-1.25 X 40 HEX C/S 10.9 ZP	10277 M6-1.25 X 50 HEX C/S 10.9 ZP
10412 M6-1.5 FIN HEX NUT CL10 ZP	10432 M6 HARD WASH TP200 ZP	10585 M6 LOCKWASHER ZP	10293 M6-1.5 X 20 HEX C/S 10.9 ZP	10294 M6-1.5 X 25 HEX C/S 10.9 ZP	10295 M6-1.5 X 30 HEX C/S 10.9 ZP	10296 M6-1.5 X 40 HEX C/S 10.9 ZP	10298 M6-1.5 X 50 HEX C/S 10.9 ZP	10413 M6-1.75 FIN HEX NUT CL10 ZP	10433 M6 HARD WASH TP200 ZP	10586 M6 LOCKWASHER ZP	10316 M6-1.75 X 25 HEX C/S 10.9 ZP	10317 M6-1.75 X 30 HEX C/S 10.9 ZP	10318 M6-1.75 X 35 HEX C/S 10.9 ZP	10319 M6-1.75 X 40 HEX C/S 10.9 ZP	10321 M6-1.75 X 50 HEX C/S 10.9 ZP
10415 M6-2.0 FIN HEX NUT CL10 ZP	10435 M6 HARD WASH TP200 ZP	10588 M6 LOCKWASHER ZP	10358 M6-2.0 X 30 HEX C/S 10.9 ZP	10359 M6-2.0 X 35 HEX C/S 10.9 ZP	10360 M6-2.0 X 40 HEX C/S 10.9 ZP	10362 M6-2.0 X 50 HEX C/S 10.9 ZP	10364 M6-2.0 X 60 HEX C/S 10.9 ZP								

**Metric 10.9 Hex
Capscrews, Nuts &
Washers**
IBS No. 810P • 72 Items
1,716 pieces
Arranged in a labeled 80 hole bin



IBS, Inc.								Metric 10.9 Fasteners							
Assortment No. 810P															
10410 M6-1.0 FIN HEX NUT CL10 ZP	10411 M6-1.25 FIN HEX NUT CL10 ZP	10412 M6-1.5 FIN HEX NUT CL10 ZP	10413 M6-1.75 FIN HEX NUT CL10 ZP	10414 M6-2.0 FIN HEX NUT CL10 ZP	10415 M6-2.5 FIN HEX NUT CL10 ZP	10416 M6-3.0 FIN HEX NUT CL10 ZP	10417 M6-3.5 FIN HEX NUT CL10 ZP	10430 M6 HARD WASH TP200 ZP	10431 M6 HARD WASH TP200 ZP	10432 M6 HARD WASH TP200 ZP	10433 M6 HARD WASH TP200 ZP	10434 M6 HARD WASH TP200 ZP	10435 M6 HARD WASH TP200 ZP	10437 M6 HARD WASH TP200 ZP	10438 M6 HARD WASH TP200 ZP
10582 M6 LOCKWASHER ZP	10584 M6 LOCKWASHER ZP	10585 M6 LOCKWASHER ZP	10586 M6 LOCKWASHER ZP	10587 M6 LOCKWASHER ZP	10588 M6 LOCKWASHER ZP	10590 M6 LOCKWASHER ZP	10591 M6 LOCKWASHER ZP	10250 M6-1.0 X 12 HEX C/S 10.9 ZP	10270 M6-1.25 X 16 HEX C/S 10.9 ZP	10292 M6-1.5 X 20 HEX C/S 10.9 ZP	10316 M6-1.75 X 25 HEX C/S 10.9 ZP	10340 M6-2.0 X 30 HEX C/S 10.9 ZP	10360 M6-2.5 X 40 HEX C/S 10.9 ZP	10376 M6-3.0 X 40 HEX C/S 10.9 ZP	10389 M6-3.5 X 40 HEX C/S 10.9 ZP
10252 M6-1.0 X 16 HEX C/S 10.9 ZP	10271 M6-1.25 X 20 HEX C/S 10.9 ZP	10293 M6-1.5 X 25 HEX C/S 10.9 ZP	10317 M6-1.75 X 30 HEX C/S 10.9 ZP	10341 M6-2.0 X 35 HEX C/S 10.9 ZP	10361 M6-2.5 X 45 HEX C/S 10.9 ZP	10378 M6-3.0 X 50 HEX C/S 10.9 ZP	10391 M6-3.5 X 50 HEX C/S 10.9 ZP	10254 M6-1.0 X 20 HEX C/S 10.9 ZP	10272 M6-1.25 X 25 HEX C/S 10.9 ZP	10294 M6-1.5 X 30 HEX C/S 10.9 ZP	10318 M6-1.75 X 35 HEX C/S 10.9 ZP	10342 M6-2.0 X 40 HEX C/S 10.9 ZP	10362 M6-2.5 X 50 HEX C/S 10.9 ZP	10380 M6-3.0 X 60 HEX C/S 10.9 ZP	10392 M6-3.5 X 60 HEX C/S 10.9 ZP
10257 M6-1.0 X 25 HEX C/S 10.9 ZP	10273 M6-1.25 X 30 HEX C/S 10.9 ZP	10295 M6-1.5 X 35 HEX C/S 10.9 ZP	10319 M6-1.75 X 40 HEX C/S 10.9 ZP	10344 M6-2.0 X 50 HEX C/S 10.9 ZP	10364 M6-2.5 X 60 HEX C/S 10.9 ZP	10382 M6-3.0 X 70 HEX C/S 10.9 ZP	10393 M6-3.5 X 70 HEX C/S 10.9 ZP	10258 M6-1.0 X 30 HEX C/S 10.9 ZP	10274 M6-1.25 X 35 HEX C/S 10.9 ZP	10296 M6-1.5 X 40 HEX C/S 10.9 ZP	10321 M6-1.75 X 50 HEX C/S 10.9 ZP	10346 M6-2.0 X 60 HEX C/S 10.9 ZP	10366 M6-2.5 X 70 HEX C/S 10.9 ZP	10384 M6-3.0 X 80 HEX C/S 10.9 ZP	10395 M6-3.5 X 80 HEX C/S 10.9 ZP
10260 M6-1.0 X 40 HEX C/S 10.9 ZP	10275 M6-1.25 X 40 HEX C/S 10.9 ZP	10298 M6-1.5 X 50 HEX C/S 10.9 ZP	10323 M6-1.75 X 60 HEX C/S 10.9 ZP	10347 M6-2.0 X 70 HEX C/S 10.9 ZP	10368 M6-2.5 X 80 HEX C/S 10.9 ZP	10385 M6-3.0 X 90 HEX C/S 10.9 ZP	10396 M6-3.5 X 90 HEX C/S 10.9 ZP	10262 M6-1.0 X 50 HEX C/S 10.9 ZP	10277 M6-1.25 X 50 HEX C/S 10.9 ZP	10300 M6-1.5 X 60 HEX C/S 10.9 ZP	10325 M6-1.75 X 70 HEX C/S 10.9 ZP	10348 M6-2.0 X 80 HEX C/S 10.9 ZP	10370 M6-2.5 X 90 HEX C/S 10.9 ZP	10387 M6-3.0 X 100 HEX C/S 10.9 ZP	10397 M6-3.5 X 100 HEX C/S 10.9 ZP

M
E
T
R
I
C
S

IBS, INCORPORATED

Metric C/S FINE Pitch Cl. 10.9 H13



Metric Hex Capscrews

Fine Thread • Class 10.9 • Zinc Plated



Length	M8 (1.0)	M10 (1.25)	M12 (1.5)	M14 (1.5)	M16 (1.5)	Length
20	18271	18292	18315			20
25	18272	18293	18316			25
30	18273	18294		18340		30
35	18274	18295	18318	18341	18359	35
40	18275	18296	18319	18342	18360	40
45					18361	45
50	18277	18298	18321	18344	18362	50
60	18279	18300	18323	18346	18364	60
70	18291	18302	18325	18347	18366	70
80		18304	18327	18348		80
90			18328	18349	18370	90
100			18329	18350	18371	100
110						110
120				18352	18373	120
QTY	50	50	25	25	25	QTY

METRICS

**Metric 10.9 Hex
Capscrews, Nuts &
Washers**
FINE THREAD — ZINC PLATED
IBS No. 442P • 40 Items
802 pieces
Arranged in a labeled 40 hole bin



IBS, Inc. QUALITY PRODUCTS • SUPPORTED SERVICE WWW.IBSINC.COM • 800-875-1188				Metric Hex Head Cap Screws 10.9 Fine Thread Zinc Plated			
Assortment No. 442P							
10401 M8-1.0 FIN HEX NUT CL10 ZP	10568 M8 FLAT WASHER ZP	10584 M8 LOCKWASHER ZP	18271 M8-1.0 X 20 HEX C/S 10.9 ZP	18272 M8-1.0 X 25 HEX C/S 10.9 ZP	18273 M8-1.0 X 30 HEX C/S 10.9 ZP	18275 M8-1.0 X 40 HEX C/S 10.9 ZP	18277 M8-1.0 X 50 HEX C/S 10.9 ZP
10402 M10-1.25 FIN HEX NUT CL10 ZP	10569 M10 FLAT WASHER ZP	10585 M10 LOCKWASHER ZP	18292 M10-1.25 X 20 HEX C/S 10.9 ZP	18293 M10-1.25 X 25 HEX C/S 10.9 ZP	18294 M10-1.25 X 30 HEX C/S 10.9 ZP	18296 M10-1.25 X 40 HEX C/S 10.9 ZP	18298 M10-1.25 X 50 HEX C/S 10.9 ZP
10403 M12-1.5 FIN HEX NUT CL10 ZP	10570 M12 FLAT WASHER ZP	10586 M12 LOCKWASHER ZP	18315 M12-1.5 X 20 HEX C/S 10.9 ZP	18317 M12-1.5 X 30 HEX C/S 10.9 ZP	18319 M12-1.5 X 40 HEX C/S 10.9 ZP	18321 M12-1.5 X 50 HEX C/S 10.9 ZP	18323 M12-1.5 X 60 HEX C/S 10.9 ZP
10404 M14-1.5 FIN HEX NUT CL10 ZP	10571 M14 FLAT WASHER ZP	10587 M14 LOCKWASHER ZP	18340 M14-1.5 X 30 HEX C/S 10.9 ZP	18342 M14-1.5 X 40 HEX C/S 10.9 ZP	18344 M14-1.5 X 50 HEX C/S 10.9 ZP	18346 M14-1.5 X 60 HEX C/S 10.9 ZP	18347 M14-1.5 X 70 HEX C/S 10.9 ZP
10405 M16-1.5 FIN HEX NUT CL10 ZP	10572 M16 FLAT WASHER ZP	10588 M16 LOCKWASHER ZP	18360 M16-1.5 X 40 HEX C/S 10.9 ZP	18362 M16-1.5 X 50 HEX C/S 10.9 ZP	18364 M16-1.5 X 60 HEX C/S 10.9 ZP	18366 M16-1.5 X 70 HEX C/S 10.9 ZP	18370 M16-1.5 X 80 HEX C/S 10.9 ZP



IBS, INCORPORATED

Metric Hex Nuts

Metric Hex Nuts



FINISHED HEX NUTS CLASS 8 (H09)

FINISHED HEX NUTS CLASS 10 (H03)

IBS No.	Reg Pitch • Class 8 • ZP	Qty
	Size	
10597	M3 (.5)	100
10599	M4 (.7)	100
10600	M5 (.8)	100
10601	M6 (1.0)	100
10602	M7 (1.0)	100
10603	M8 (1.25)	100
10605	M10 (1.5)	50
10606	M12 (1.75)	50
10607	M14 (2.0)	25
10608	M16 (2.0)	10
10609	M18 (2.5)	10
10610	M20 (2.5)	10
10611	M24 (3.0)	10
IBS No.	Fine Pitch • Class 8 • ZP	Qty
	Size	
10615	M8 (1.0)	100
10616	M10 (1.0)	50
10617	M10 (1.25)	50
10618	M12 (1.5)	50
10619	M12 (1.25)	50
10620	M14 (1.5)	50

IBS No.	Reg Pitch • Class 10 • ZP	Qty
	Size	
10410	M6 (1.0)	100
10411	M8 (1.25)	100
10412	M10 (1.5)	50
10413	M12 (1.75)	50
10414	M14 (2.0)	25
10415	M16 (2.0)	25
10416	M20 (2.5)	25
10417	M24 (3.0)	25
10418	M30 (3.5)	10
IBS No.	Fine Pitch • Class 10 • ZP	Qty
	Size	
10401	M8 (1.0)	100
10402	M10 (1.25)	50
10403	M12 (1.5)	50
10404	M14 (1.5)	25
10405	M16 (1.5)	25



FLANGE NUTS (H15)

IBS No.	Reg Pitch • Class 10 • ZP	Qty
	Size	
30800	M6 (1.0)	50
30801	M8 (1.25)	50
30802	M10 (1.5)	50
30803	M12 (1.75)	50



GRADE C LOCK NUTS (H15)

IBS No.	Reg Pitch • Class 10 • ZP	Qty
	Size	
10420	M6 (1.0)	25
10421	M8 (1.25)	25
10422	M10 (1.5)	25
10423	M12 (1.75)	10
10424	M14 (2.0)	10
10425	M16 (2.0)	10
10426	M20 (2.5)	10
10427	M24 (3.0)	10



NYLOC HEX NUTS CLASS 6/8 (H15)

NYLOC HEX NUTS CLASS 10 (H15)

IBS No.	Reg Pitch • Class 6/8 • ZP	Qty
	Size	
749	M4 (.7)	100
750	M5 (.8)	100
751	M6 (1.0)	100
752	M8 (1.25)	100
753	M10 (1.5)	50
754	M12 (1.75)	50
755	M14 (2.0)	50
756	M16 (2.0)	50
757	M20 (2.5)	25
758	M24 (3.0)	25

IBS No.	Reg Pitch • Class 10 • ZP	Qty
	Size	
4751	M6 (1.0)	100
4752	M8 (1.25)	100
4753	M10 (1.5)	50
4754	M12 (1.75)	50
4755	M14 (2.0)	50
4756	M16 (2.0)	50
4757	M20 (2.5)	25
4758	M24 (3.0)	25
4759	M30 (3.5)	10

METRICS

IBS, INCORPORATED

Metric Machine Screws



Metric Washers



**METRIC FLAT WASHERS
(H21)**

IBS No.	Size	ID (mm)	OD (mm)	Pkg Qty
10562	M3	3.2	7	100
10564	M4	4.3	9	100
10565	M5	5.3	10	100
10566	M6	6.4	12	100
10567	M7	7.4	14	100
10568	M8	8.4	16	100
10569	M10	10.5	20	100
10570	M12	13	24	100
10571	M14	15	28	50
10572	M16	17	30	50
10575	M18	19	34	25
10573	M20	21	37	25
10574	M24	25	44	25
10576	M30	31	56	10



**METRIC LOCK WASHERS
(H08)**

IBS No.	Size	ID (mm)	OD (mm)	Pkg Qty
10580	M4	4.1	7.6	100
10581	M5	5.1	9.2	100
10582	M6	6.1	11.8	100
10583	M7	7.1	12.8	100
10584	M8	8.1	14.8	100
10585	M10	10.2	18.1	100
10586	M12	12.2	21.1	100
10587	M14	14.2	24.1	50
10588	M16	16.2	27.4	50
10589	M18	18.2	29.4	25
10590	M20	20.2	33.6	25
10591	M24	24.5	40	25
10592	M30	30.5	48.2	10



**METRIC HI-COLLAR
LOCK WASHERS (H08)**

IBS No.	Size	ID (mm)	OD (mm)	Pkg Qty
10880	M4	4.1	7	100
10881	M5	5.1	8.8	100
10882	M6	6.1	9.9	100
10883	M8	8.1	12.7	100
10884	M10	10.2	16	100
10885	M12	12.2	18	100
10886	M14	14.2	21.1	50
10887	M16	16.2	24.4	50
10888	M18	18.2	26.4	25
10889	M20	20.2	30.6	25
10890	M24	24.5	35.9	25



**METRIC HARD WASHERS
(H05)**

IBS No.	Size	ID (mm)	OD (mm)	Pkg Qty
10429	M5	5.3	10	100
10430	M6	6.4	12	100
10431	M8	8.4	16	100
10432	M10	10.5	20	100
10433	M12	13	24	100
10434	M14	15	28	50
10435	M16	17	30	50
10436	M18	19	34	25
10437	M20	21	37	25
10438	M24	25	44	25
10439	M30	31	56	10



**METRIC SPRING
WASHERS (H15)**

IBS No.	Size	ID (mm)	OD (mm)	Pkg Qty
870	M4	4.3	8	100
871	M5	5.3	10	100
872	M6	6.4	11	100
873	M8	8.4	15	100
874	M10	10.5	18	100
875	M12	13	24	100

M
E
T
R
I
C
S



IBS, INCORPORATED

Assortments Z02

Metric Machine Screws



PHILLIPS PAN HEAD MACHINE SCREWS 4.8 (H12)

Length	M4 (.7)	M5 (.8)	M6 (1.0)	M8 (1.25)
6	10711			
8	10712	601		
10	10713	602	10730	
12	10714	603	10731	
14				
16	10716	604	10733	10750
20	10718	606	10735	10752
22				
25	10720	607	10737	10754
30	10721	608	10738	10755
35				
40				
QTY	100	100	100	100



Metric Phillips Pan Hd Machine Screws, Flat Washers & Nuts

IBS No. 715R • 24 Items • 1,445 Pieces

IBS, Inc. <small>SPECIALTY PRODUCTS FOR MAINTENANCE & REPAIR</small> <small>INDUSTRIALONLY.COM © © © 800-678-1866</small>						Metric Phillips Pan Head Machine Screws Flat Washers & Nuts					
						Assortment No. 715R					
10713 M4-.7 X 10 PHIL PAN M/S ZP	10716 M4-.7 X 16 PHIL PAN M/S ZP	10718 M4-.7 X 20 PHIL PAN M/S ZP	10721 M4-.7 X 30 PHIL PAN M/S ZP	10564 M4 FLAT WASHER ZP	10599 M4-.7 FIN HEX NUT CL8 ZP	602 M5-.8 X 10 PHIL PAN M/S ZP	604 M5-.8 X 16 PHIL PAN M/S ZP	606 M5-.8 X 20 PHIL PAN M/S ZP	608 M5-.8 X 30 PHIL PAN M/S ZP	10565 M5 FLAT WASHER ZP	10600 M5-.8 FIN HEX NUT CL8 ZP
10730 M6-1.0 X 10 PHIL PAN M/S ZP	10733 M6-1.0 X 16 PHIL PAN M/S ZP	10735 M6-1.0 X 20 PHIL PAN M/S ZP	10738 M6-1.0 X 30 PHIL PAN M/S ZP	10566 M6 FLAT WASHER ZP	10601 M6-1.0 FIN HEX NUT CL8 ZP	10750 M8-1.25 X 16 PHIL PAN M/S ZP	10752 M8-1.25 X 20 PHIL PAN M/S ZP	10754 M8-1.25 X 25 PHIL PAN M/S ZP	10755 M8-1.25 X 30 PHIL PAN M/S ZP	10568 M8 FLAT WASHER ZP	10603 M8-1.25 FIN HEX NUT CL8 ZP

METRICS

IBS, INCORPORATED

Metric Socket Products H17



Metric Socket Capscrews

Class 12.9



Length (mm)	M3	M4	M5	M6	M8	M10	M12	M14	M16	M20	M24	Length (mm)
10		815	82200	8242								10
12	810	816	822	824A	828	833						12
16	812	818	823	824B	82800	834	83600					16
20	814	820	823A	824C	829	835	83601					20
25		821	824	824D	829A	835A	836	839				25
30		82105	82400	825	830	835B	836A	83901				30
35		82106	82401	826	830A	835C	83602	840	84110			35
40		82107	82402	827	831	835D	836B	841	84111	845		40
45		82108	82403	82700	83100	83500	83603	84100	84112	846		45
50		82109	82404	827B	832	83501	837A	84101	842	847	860	50
60				82702	83201	83503	838	84103	84201	849	862	60
70				82703	83202	83504	83800	84104	84202	850	863	70
75									843			75
80						83505	83801	84105	84300	851	864	80
90						83506	83802	84106	84301	852	865	90
100						83507	83803	84107	84302	853	866	100
110									84303	854	867	110
120									84304	855	868	120
130									84305	856	869	130
140									84306	857	86900	140
150									84307	858	86901	150
Pkg Qty	25	25	25	25	25	25	10	10	10	5	5	Pkg Qty

METRICS

Metric 12.9 Socket Head Capscrews (Z02)

IBS No. 266R • 24 Items • 475 Pieces



IBS, Inc. SPECIALTY PRODUCTS FOR MAINTENANCE & REPAIR INDUSTRIALBOLT.COM © © © 800-878-1906						Metric 12.9 Socket Head Capscrews					
Assortment No. 266R											
816 M4 X 12 SOCKET HD C/S ALLOY	818 M4 X 16 SOCKET HD C/S ALLOY	820 M4 X 20 SOCKET HD C/S ALLOY	821 M4 X 25 SOCKET HD C/S ALLOY	822 M5 X 12 SOCKET HD C/S ALLOY	823 M5 X 16 SOCKET HD C/S ALLOY	823A M5 X 20 SOCKET HD C/S ALLOY	824 M5 X 25 SOCKET HD C/S ALLOY	824A M6 X 12 SOCKET HD C/S ALLOY	824B M6 X 16 SOCKET HD C/S ALLOY	824C M6 X 20 SOCKET HD C/S ALLOY	824D M6 X 25 SOCKET HD C/S ALLOY
825 M6 X 30 SOCKET HD C/S ALLOY	827 M6 X 40 SOCKET HD C/S ALLOY	829 M8 X 20 SOCKET HD C/S ALLOY	829A M8 X 25 SOCKET HD C/S ALLOY	830 M8 X 30 SOCKET HD C/S ALLOY	830A M8 X 35 SOCKET HD C/S ALLOY	831 M8 X 40 SOCKET HD C/S ALLOY	835 M10 X 20 SOCKET HD C/S ALLOY	835A M10 X 25 SOCKET HD C/S ALLOY	835B M10 X 30 SOCKET HD C/S ALLOY	835C M10 X 35 SOCKET HD C/S ALLOY	835D M10 X 40 SOCKET HD C/S ALLOY



IBS, INCORPORATED

Metric Socket Products H17

Metric Flat Socket



Cap screws
Class 12.9

Length	M4	M5	M6	M8	M10	Length
12	84345	84360	84370			12
16	84346	84361	84371			16
20	84347	84362	84372	84381	84391	20
25	84348	84363	84373	84382	84393	25
30			84374	84383	84394	30
35				84384	84395	35
40			84375	84385	84396	40
QTY	25	25	25	25	25	QTY

Metric Flat Socket Capscrews

Class 12.9 (Z02)
IBS No. 267R • 24 Items
435 Pieces



IBS, Inc. SPECIALTY PRODUCTS FOR MAINTENANCE & REPAIR INDUSTRIALALLOY.COM P O BOX 850-870-1908						Metric 12.9 Flat Socket Head Cap Screws
						Assortment No. 267R
84345 M4 X 12 FLAT SOCKET C/S ALLOY	84346 M4 X 16 FLAT SOCKET C/S ALLOY	84347 M4 X 20 FLAT SOCKET C/S ALLOY	84348 M4 X 25 FLAT SOCKET C/S ALLOY	84360 M5 X 12 FLAT SOCKET C/S ALLOY	84361 M5 X 16 FLAT SOCKET C/S ALLOY	
84362 M5 X 20 FLAT SOCKET C/S ALLOY	84363 M5 X 25 FLAT SOCKET C/S ALLOY	84370 M6 X 12 FLAT SOCKET C/S ALLOY	84371 M6 X 16 FLAT SOCKET C/S ALLOY	84372 M6 X 20 FLAT SOCKET C/S ALLOY	84373 M6 X 25 FLAT SOCKET C/S ALLOY	
84374 M6 X 30 FLAT SOCKET C/S ALLOY	84375 M6 X 40 FLAT SOCKET C/S ALLOY	84381 M8 X 20 FLAT SOCKET C/S ALLOY	84382 M8 X 25 FLAT SOCKET C/S ALLOY	84383 M8 X 30 FLAT SOCKET C/S 12.9	84384 M8 X 35 FLAT SOCKET C/S 12.9	
84385 M8 X 40 FLAT SOCKET C/S ALLOY	84391 M10 X 20 FLAT SOCKET C/S ALLOY	84392 M10 X 25 FLAT SOCKET C/S ALLOY	84394 M10 X 30 FLAT SOCKET C/S ALLOY	84395 M10 X 35 FLAT SOCKET C/S ALLOY	84396 M10 X 40 FLAT SOCKET C/S 12.9	

METRICS

Metric Socket Set Screws

Cup Point • Class 12.9



Length	M6	M8	M10	M12	Length
6	785				6
8	786	792			8
10	787	793	797		10
12	788	794	798	804	12
16	789	795	799	805	16
20	790	796	800	806	20
25			802	807	25
30				807A	30
35			803	808	35
40				809	40
QTY	25	25	25	25	QTY

IBS, INCORPORATED

Automotive Rivets & Fasteners H04



J.I.S Fasteners

J.I.S. B1180 • STEEL • HEAT TREATED • I.S.O. CLASS 8.8 & 10.9 • ZINC PLATED

J.I.S. fasteners have a smaller hex dimension (across the flats) than DIN or ISO metric fasteners. They fit in those tight spots where the hex of an ISO or DIN fastener is too large. J.I.S. fasteners are OEM equipment on many GM and Japanese import car applications, as well as Japanese imported equipment and machinery.



J.I.S. Hex Head Bolts 8.8

IBS No.	Dia & Pitch	Length	Qty.
M8-1.25 (Width Across the Flats; 12mm)			
10801	8mm-1.25	12mm	100
10802	8mm-1.25	16mm	100
10803	8mm-1.25	20mm	100
10804	8mm-1.25	25mm	50
10805	8mm-1.25	30mm	50
10806	8mm-1.25	35mm	50
10807	8mm-1.25	40mm	50
10809	8mm-1.25	50mm	50
M10-1.25 (Width Across the Flats; 14mm)			
10811	10mm-1.25	20mm	50
10812	10mm-1.25	25mm	50
10813	10mm-1.25	30mm	25
10814	10mm-1.25	35mm	25
10815	10mm-1.25	40mm	25
10816	10mm-1.25	45mm	25
10817	10mm-1.25	50mm	25
10818	10mm-1.25	60mm	25
M12-1.25 (Width Across the Flats; 17mm)			
10821	12mm-1.25	20mm	50
10822	12mm-1.25	25mm	25
10823	12mm-1.25	30mm	25
10824	12mm-1.25	35mm	25
10825	12mm-1.25	40mm	25
10827	12mm-1.25	50mm	25



J.I.S. Hex Flange Bolts 10.9

IBS No.	Dia & Pitch	Length	Qty.
M6-1.00 (Width Across the Flats; 10mm)			
10850	6mm-1.00	12mm	100
10851	6mm-1.00	16mm	100
10852	6mm-1.00	20mm	100
10856	6mm-1.00	25mm	100
10853	6mm-1.00	30mm	100
10854	6mm-1.00	35mm	100
10855	6mm-1.00	40mm	100
M8-1.25 (Width Across the Flats; 12mm)			
10860	8mm-1.25	12mm	50
10861	8mm-1.25	16mm	50
10862	8mm-1.25	20mm	50
10863	8mm-1.25	25mm	50
10864	8mm-1.25	30mm	50
10865	8mm-1.25	35mm	50
10866	8mm-1.25	40mm	50
M10-1.25 (Width Across the Flats; 14mm)			
10870	10mm-1.25	16mm	25
10871	10mm-1.25	20mm	25
10872	10mm-1.25	25mm	25
10873	10mm-1.25	30mm	25
10874	10mm-1.25	35mm	25
10875	10mm-1.25	40mm	25
10876	10mm-1.25	45mm	25
10877	10mm-1.25	50mm	25



J.I.S. Small Hex Nuts

IBS No.	Dia & Pitch	WAF	Qty.
10840	8mm-1.25	12mm	100
10841	10mm-1.25	14mm	100
10842	12mm-1.25	17mm	100



J.I.S. Hex Flange Nuts - Serrated

IBS No.	Dia & Pitch	WAF	Qty.
10845	6mm-1.00	10mm	100
10843	8mm-1.25	12mm	100
10844	10mm-1.25	14mm	100

METRICS



IBS, INCORPORATED

Assortments Z02

J.I.S. Hex Head Capscrews Assortment





















IBS No. 697R • 20 Pieces • 595 Items

Packaged in a locking steel drawer for easy storage & organization



JIS Hex Head Capscrews

Assortment No. 697R

<p>10802 M8-1.25 X 16 JIS HEX C/S ZP</p> 	<p>10803 M8-1.25 X 20 JIS HEX C/S ZP</p> 	<p>10804 M8-1.25 X 25 JIS HEX C/S ZP</p> 	<p>10805 M8-1.25 X 30 JIS HEX C/S ZP</p> 	<p>10807 M8-1.25 X 40 JIS HEX C/S ZP</p> 	<p>10811 M10-1.25 X 20 JIS HEX C/S ZP</p> 
<p>10812 M10-1.25 X 25 JIS HEX C/S ZP</p> 	<p>10813 M10-1.25 X 30 JIS HEX C/S ZP</p> 	<p>10814 M10-1.25 X 35 JIS HEX C/S ZP</p> 	<p>10815 M10-1.25 X 40 JIS HEX C/S ZP</p> 	<p>10816 M10-1.25 X 45 JIS HEX C/S ZP</p> 	<p>10817 M10-1.25 X 50 JIS HEX C/S ZP</p> 
<p>10822 M12-1.25 X 25 JIS HEX C/S ZP</p> 	<p>10823 M12-1.25 X 30 JIS HEX C/S ZP</p> 	<p>10824 M12-1.25 X 35 HEX C/S JIS ZP</p> 	<p>10825 M12-1.25 X 40 JIS HEX C/S ZP</p> 	<p>10827 M12-1.25 X 50 JIS HEX C/S ZP</p> 	
<p>10840 M8-1.25 JIS HEX NUT ZP</p> 	<p>10841 M10-1.25 JIS HEX NUT ZP</p> 	<p>10842 M12-1.25 JIS HEX NUT ZP</p> 			

Metric J.I.S. Flange Bolts Assortment





















IBS No. 779R • 24 Pieces • 605 Items

Packaged in a locking steel drawer for easy storage & organization

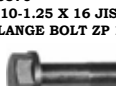
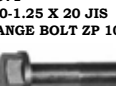

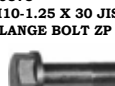
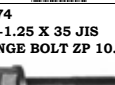
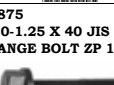
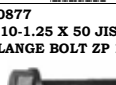
Metric JIS Flange Bolts

Assortment No. 779R

<p>10850 M6-1.0 X 12 JIS FLANGE BOLT ZP 10.9</p> 	<p>10851 M6-1.0 X 16 JIS FLANGE BOLT ZP 10.9</p> 	<p>10852 M6-1.0 X 20 JIS FLANGE BOLT ZP 10.9</p> 	<p>10856 M6-1.0 X 25 JIS FLANGE BOLT ZP 10.9</p> 	<p>10853 M6-1.0 X 30 JIS FLANGE BOLT ZP 10.9</p> 	<p>10854 M6-1.0 X 35 JIS FLANGE BOLT ZP 10.9</p> 
<p>10855 M6-1.0 X 40 JIS FLANGE BOLT ZP 10.9</p> 	<p>10860 M8-1.25 X 12 JIS FLANGE BOLT ZP 10.9</p> 	<p>10861 M8-1.25 X 16 JIS FLANGE BOLT ZP 10.9</p> 	<p>10862 M8-1.25 X 20 JIS FLANGE BOLT ZP 10.9</p> 	<p>10863 M8-1.25 X 25 JIS FLANGE BOLT ZP 10.9</p> 	<p>10864 M8-1.25 X 30 JIS FLANGE BOLT ZP 10.9</p> 
<p>10865 M8-1.25 X 35 JIS FLANGE BOLT ZP 10.9</p> 	<p>10866 M8-1.25 X 40 JIS FLANGE BOLT ZP 10.9</p> 	<p>10870 M10-1.25 X 16 JIS FLANGE BOLT ZP 10.9</p> 	<p>10871 M10-1.25 X 20 JIS FLANGE BOLT ZP 10.9</p> 	<p>10872 M10-1.25 X 25 JIS FLANGE BOLT ZP 10.9</p> 	<p>10873 M10-1.25 X 30 JIS FLANGE BOLT ZP 10.9</p> 
<p>10874 M10-1.25 X 35 JIS FLANGE BOLT ZP 10.9</p> 	<p>10875 M10-1.25 X 40 JIS FLANGE BOLT ZP 10.9</p> 	<p>10877 M10-1.25 X 50 JIS FLANGE BOLT ZP 10.9</p> 	<p>10845 M6-1.0 JIS SERR FLANGE NUT ZP</p> 	<p>10843 M8-1.25 JIS SERR FLANGE NUT ZP</p> 	<p>10844 M10-1.25 JIS SERR FLANGE NUT ZP</p> 



M
E
T
R
I
C
S

IBS, INCORPORATED

Metric Hex Flange Bolts H07



Metric Hex Flange Bolts 10.9 • ZINC PLATED

Flange bolts are often used in vehicle frames, especially in trucks and anywhere a head bolt is required. They can speed up assembly because of the stop the washer head creates when using socket tools and eliminates the need for a washer. They render four times the bearing area than that of a standard hex screw.



METRIC HEX FLANGE BOLTS

Length	M6-1.0	M8-1.25	M10-1.5	M12-1.75	Qty	Length
W.A.F.*	8MM	10MM	13MM	15MM		
16	30402	30510			10	16
20	30403	30511	30620		10	20
25	30404	30512	30621	30730	10	25
30	30405	30513	30622	30731	10	30
35	30406	30514	30623	30732	10	35
40	30407	30515	30624	30733	10	40
45	30408	30516	30625	30734	10	45
50	30409	30517	30626	30735	10	50
60		30519	30627	30736	10	60
70		30520	30628	30737	10	70
80		30521		30738	10	80
90				30739	10	90
100				30740	10	100
110				30741	10	110
120				30742	10	120

* W.A.F. = With Across Flat

Metric 10.9 Flange Bolt Assortment (Z02)

IBS No. 810R • 20 Items • 515 Pcs





















Packaged in a locking steel drawer for easy storage & organization



IBS, Inc.
SPECIALTY PRODUCTS FOR MAINTENANCE & REPAIR
INDUSTRIALBOLT.COM 800-678-1906

Metric 10.9 Hex Flange Bolts - Zinc Plated

Assortment No.810R

<p>30800 M6-1.0 HEX FLANGE NUT CL10 ZP</p> 	<p>30402 M6-1.0 X 16 HEX FLANGE BOLT 10.9 ZP</p> 	<p>30403 M6-1.0 X 20 HEX FLANGE BOLT 10.9 ZP</p> 	<p>30404 M6-1.0 X 25 HEX FLANGE BOLT 10.9 ZP</p> 	<p>30405 M6-1.0 X 30 HEX FLANGE BOLT 10.9 ZP</p> 
<p>30801 M8-1.25 HEX FLANGE NUT CL10 ZP</p> 	<p>30510 M8-1.25 X 16 HEX FLANGE BOLT 10.9 ZP</p> 	<p>30511 M8-1.25 X 20 HEX FLANGE BOLT 10.9 ZP</p> 	<p>30512 M8-1.25 X 25 HEX FLANGE BOLT 10.9 ZP</p> 	<p>30513 M8-1.25 X 30 HEX FLANGE BOLT 10.9 ZP</p> 
<p>30802 M10-1.5 HEX FLANGE NUT CL10 ZP</p> 	<p>30620 M10-1.5 X 20 HEX FLANGE BOLT 10.9 ZP</p> 	<p>30621 M10-1.5 X 25 HEX FLANGE BOLT 10.9 ZP</p> 	<p>30622 M10-1.5 X 30 HEX FLANGE BOLT 10.9 ZP</p> 	<p>30624 M10-1.5 X 40 HEX FLANGE BOLT 10.9 ZP</p> 
<p>30803 M12-1.75 HEX FLANGE NUT CL10 ZP</p> 	<p>30730 M12-1.75 X 25 HEX FLANGE BOLT 10.9 ZP</p> 	<p>30731 M12-1.75 X 30 HEX FLANGE BOLT 10.9 ZP</p> 	<p>30733 M12-1.75 X 40 HEX FLANGE BOLT 10.9 ZP</p> 	<p>30735 M12-1.75 X 50 HEX FLANGE BOLT 10.9 ZP</p> 

METRICS



IBS, INCORPORATED

Metric Stainless Steel H19

Metric Stainless Steel Fasteners



STAINLESS STEEL METRIC CAPSCREWS

Length	M4	M5	M6	M8	M10	Qty	M12	M14	M16	Qty	Length
10			91451	92010		25					10
12	908		915	92012		25					12
16	909	911	915A	921	929	25					16
20	910	912	916	922	930	25	93610	93620	93630	10	20
25		913	917	923	931	25	93611	93621	93631	10	25
30		914	918	924	932	25	93612	93622	93632	10	30
35			919	925	933	25	93613	93623	93633	10	35
40			920	926	934	25	93614	93624	93634	10	40
45					935	25	93615		93635	10	45
50					936	25	93616	93626	93636	10	50



FIN HEX NUTS SS

IBS No.	Size	Qty
960	M4	100
961	M5	100
962	M6	100
963	M8	100
964	M10	100
965	M12	25
966	M14	25
967	M16	25



NYLON INSERT LOCK NUTS SS

IBS No.	Size	Qty
980	M4	100
981	M5	100
982	M6	100
983	M8	50
984	M10	25
985	M12	25
986	M14	10
987	M16	10



FLAT WASHER SS

IBS No.	Size	Qty
940	M4	100
941	M5	100
942	M6	100
943	M8	100
944	M10	100
945	M12	25
946	M14	25
947	M16	25



LOCK WASHERS

IBS No.	Size	Qty
950	M4	100
951	M5	100
952	M6	100
953	M8	100
954	M10	100
955	M12	25
956	M14	25
957	M16	25

METRICS



STAINLESS STEEL METRIC SOCKET HEAD CAPSCREWS

Length	M4	M5	M6	M8	Qty	M10	Qty	M12	Qty	Length
10	96850	96855	96860	96870	25					10
16	96851	96856	96861	96871	25					16
20	96852	96857	96862	96872	25	96880	15	96890	10	20
25	96853	96858	96863	96873	25	96881	15	96891	10	25
30			96864	96874	25	96882	15	96892	10	30
35				96875	25	96883	15	96893	10	35
40				96876	25	96884	15	96894	10	40
45				96877	25	96885	15	96895	10	45
Key Size	3mm	4mm	5mm	6mm		8mm		10mm		Key Size













Metric Stainless Steel Socket Set Screws

Length	M4	M5	M6	M8	M10	M12	Length
6	96900	96905					6
8	96901	96906	96910				8
10	96902	96907	96911	96915			10
12	96903	96908	96912	96916	96920		12
16			96913	96917	96921	96925	16
20				96918	96922	96926	20
25					96923	96927	25
30						96928	30
QTY	25	25	25	25	15	10	QTY

Metric Socket Set Screw Assortment Stainless Steel (Z02)

IBS No. 405R • 24 Items • 206 Pieces



 IBS, Inc. <small>SPECIALTY PRODUCTS FOR MAINTENANCE & REPAIR INDUSTRIALBOLTY.COM © © © 800-878-1566</small>						Stainless Steel Metric Socket Set Screws Assortment No. 405R					
96900 M4 X 6 SOC SET SCREW SS  Hex Key: 2mm	96905 M5 X 6 SOC SET SCREW SS  Hex Key: 2.5mm	96910 M6 X 8 SOC SET SCREW SS  Hex Key: 3mm	96915 M8 X 10 SOC SET SCREW SS  Hex Key: 4mm	96920 M10 X 12 SOC SET SCREW SS  Hex Key: 5mm	96925 M12 X 16 SOC SET SCREW SS  Hex Key: 6mm						
96901 M4 X 8 SOC SET SCREW SS  Hex Key: 2mm	96906 M5 X 8 SOC SET SCREW SS  Hex Key: 2.5mm	96911 M6 X 10 SOC SET SCREW SS  Hex Key: 3mm	96916 M8 X 12 SOC SET SCREW SS  Hex Key: 4mm	96921 M10 X 16 SOC SET SCREW SS  Hex Key: 5mm	96926 M12 X 20 SOC SET SCREW SS  Hex Key: 6mm						
96902 M4 X 10 SOC SET SCREW SS  Hex Key: 2mm	96907 M5 X 10 SOC SET SCREW SS  Hex Key: 2.5mm	96912 M6 X 12 SOC SET SCREW SS  Hex Key: 3mm	96917 M8 X 16 SOC SET SCREW SS  Hex Key: 4mm	96922 M10 X 20 SOC SET SCREW SS  Hex Key: 5mm	96927 M12 X 25 SOC SET SCREW SS  Hex Key: 6mm						
96903 M4 X 12 SOC SET SCREW SS  Hex Key: 2mm	96908 M5 X 12 SOC SET SCREW SS  Hex Key: 2.5mm	96913 M6 X 16 SOC SET SCREW SS  Hex Key: 3mm	96918 M8 X 20 SOC SET SCREW SS  Hex Key: 4mm	96923 M10 X 25 SOC SET SCREW SS  Hex Key: 5mm	96928 M12 X 30 SOC SET SCREW SS  Hex Key: 6mm						

METRICS



IBS, INCORPORATED

Metric Stainless Steel H19

**M
E
T
R
I
C
S**



Stainless Steel Fasteners

A

Assortments, Stainless

- Button Head Socket Capscrews, SS I-7
- Cotter Pins SS I-15
- Fender Washer, SS I-4
- Flat Socket Head Capscrews, SS I-7
- Flat Socket Head Capscrews, SS Assortment I-7
- Grade 8
 - Coarse Thread - Plated - 40 Items I-5
- Screws, Machine
 - SS Phillips Pan Head Machine Screws with Hex Nuts I-8
- Screws, Security
 - Button Socket Machine Screws with PinStainless Ste I-13
 - Button Socket Security Machine Stainless Steel I-13
 - Button Socket Security Tapping ScrewsStainless Ste I-14
- Screws, Socket Head I-6
- Screws, Tapping
 - Phil Oval Head T/S S.S. Assortment I-10
 - SS Phillips Pan Head Sheet Metal Screws I-10
- Screws, Tek
 - HWH Tek® S.S. Assortment I-11
 - Square Drive Pan Hd Tek® S.S. I-12
- Socket Head Capscrews I-6

C

Capscrews

- Stainless Steel
 - Button Hd Soc Security I-13
 - Button Head Socket C/S SS I-7
 - Flat Head Socket C/S SS I-7
 - Flat Socket Head Capscrews, SS Assortment I-7
 - Hex Head I-5
 - Socket Head I-6, I-7

Cotter Pins

- Stainless Steel I-15

D

Driver Bits, Security

- Long Security Hex Driver Bits I-14

E

Fasteners

- General Information
 - Stainless Steel I-2
- Sizing Chart
 - Commercial Flat Washers SS I-3
 - Square Drive Pan Head Tek Screws SS I-12
- Stainless Steel
 - Button Socket Capscrews with PinStainless Steel Se I-13
 - Button Socket Tapping Screws with PinStainless Ste I-13

- Cotter Pins I-15
- Fender Washer I-4
- Finished Hex Nuts I-3
- Hex Head Cap Screws I-5
- Machine Screw Nuts I-3
- Medium Lockwasher I-3
- Nylon Insert Lock Nuts I-3
- Phillips Machine Screws Flat Head I-9
- Phillips Machine Screws Oval Head I-9
- Phillips Machine Screws Pan Head I-8
- Phillips Tapping Screws Flat Head I-10
- Phillips Tapping Screws Oval Head I-10, I-11
- Phillips Tapping Screws Pan Head I-9
- Socket Head Capscrews I-6, I-7
- Socket Set Screws I-8
- Trim Hex Head Machine Screws I-6
- Wing Nuts I-3

H

Hex Nuts

- Finished
 - Stainless Steel I-3
- Machine Screw
 - Stainless Steel I-3

L

Lock Nuts

- Nylon
- Stainless Steel I-3

M

Miscellaneous Nuts

- Breakaway Security Nuts SS I-14
- Wing Nut
 - Stainless Steel I-3

S

Screws, Machine

- Stainless Steel
 - Phillips Flat Head I-9
 - Phil Pan Head I-8
 - Trim Hex Head I-6

Screws, Security

- Button Socket Capscrews with PinStainless Steel Se I-13
- Button Socket Tapping Screws with PinStainless Ste I-13

Screws, Tapping

- Stainless Steel
 - Button Soc Security I-13
 - Phil Flat Head I-10
 - Phil Oval Head I-10
 - Phil Pan Head I-9

Set Screws

- Socket
 - Stainless Steel I-8

Square Drive Pan Hd Tek® S.S. I-12

S
T
A
I
N
L
E
S
S



Stainless Steel I-2

I

Teks Screws

Square Drive Pan Head

Stainless I-12

Tools

Hex Security Wrenches I-14

W

Washers, Flat

Stainless Steel

Fender I-4

Stainless Steel, Commercial I-3

Washers, Lock

Stainless Steel, Medium I-3

Stainless Steel

Stainless Steels (Iron alloys) generally contain from 12 to 30 per cent Chromium and from 0 to 20 per cent Nickel. This formulation can then be further modified by additions of Carbon and other minor elements. These additions are made to obtain specific effects; i.e. to control mechanical properties or to improve corrosion resistance. As a result stainless steel fasteners possess superior strength and offer considerable resistance to corrosion and elevated temperatures over plain carbon and lower alloy type fasteners.

Stainless steels may be divided into three general classifications:

1. **Martensitic.** Straight chromium, hardenable. Martensitic stainless steel contain from 12 to 20 percent chromium. They may be cold worked with reasonably good result and hot forged with limitations. They are generally used because of their ability to be hardened and tempered by heat treatment. They are also magnetic. Commonly these are the Type 410 and 416 fastening alloys.
2. **Ferritic.** Straight chromium, non-hardenable. These may be hot forged with better results than the Martensitic Steels and may also be cold worked with reasonably good results. These are magnetic and are not hardenable by heat treatment. These are more economical than Austenitic steels but do not have the corrosion resistance that they offer. These are typically Types 430 and 430F fasteners.
3. **Austenitic.** Chrome-nickel, non-hardenable. These make up the 18-8 (or 300) series of fasteners. 18-8 was the original chrome-nickel ratio, but many modifications have been made in the ratio. Small percentages of molybdenum, columbium, or titanium may be added to obtain special characteristics; i.e. increased corrosion resistance, to grain growth when welded, etc. These are not hardenable by heat treatment, non-magnetic, and offer the greatest resistance to corrosion. Some grades are highly resistant to heat. All grades of austenitic work harden very rapidly at room temperature and some grades hot forge fairly well.

Stainless steel fasteners have almost as many uses as there are problems of corrosion, temperature and strength. Stainless steel is a very versatile metal due in part to its high tensile strength, corrosion resistant qualities and ability to attain a mirror-like finish. It is typically used in the petroleum, chemical, food, plumbing, transportation and oil equipment industries. These are just a few of its applications.

S
T
A
I
N
L
E
S
S

IBS, INCORPORATED

Hex Nuts & Washers SS I01 - I08



Finished Hex Nuts (I01)



IBS No.	Size	Pkg Qty
11011	1/4-20	100
11012	5/16-18	100
11013	3/8-16	50
11014	7/16-14	50
11015	1/2-13	25
11016	5/8-11	25
11017	3/4-10	25

Machine Screw Nuts (I01)



IBS No.	Size	Pkg Qty
11001	4-40	100
11002	6-32	100
11003	8-32	100
11004	10-24	100
11005	10-32	100
11006	12-24	100
11007	1/4-20	100

Nylon Insert Lock Nuts (I05)



IBS No.	Size	Pkg Qty
11052	6-32	100
11053	8-32	100
11054	10-24	100
11055	10-32	100
11056	1/4-20	50
11057	5/16-18	50
11058	3/8-16	25
11058A	7/16-14	25
11059	1/2-13	10
11060	5/8-11	10
11061	3/4-10	10

Wing Nuts SS (I05)



IBS No.	Size	Pkg Qty
11069	1/4-20	25
11070	5/16-18	25
11071	3/8-16	25

Medium Lockwasher SS (I08)



IBS No.	Size	Pkg Qty
11117	#4	100
11118	#6	100
11119	#8	100
11120	#10	100
11121	#12	100
11122	1/4	100
11123	5/16	100
11124	3/8	100
11125	7/16	50
11126	1/2	50
11127	5/8	50
11128	3/4	25

Commercial Flat Washers SS (I07)



IBS No.	Size	O.D.	I.D.	THK	Qty
11097	#4	.312	.125	.031	100
11098	#6	.373	.156	.031	100
11099	#8	.373	.172	.031	100
11100	#10	.435	.203	.031	100
11101	#12	.560	.250	.050	100
11102	1/4	.747	.304	.065	100
11103	5/16	.875	.312	.065	100
11104	3/8	1.000	.391	.062	100
11105	7/16	1.125	.500	.062	50
11106	1/2	1.250	.562	.062	50
11107	5/8	1.500	.688	.079	50
11108	3/4	1.750	.812	.089	25

AN960 Flat Washers SS (I07)



IBS No.	Size	O.D.	I.D.	THK	Qty
11132	1/4	.500	.265	.062	100
11133	5/16	.562	.328	.062	100
11134	3/8	.625	.390	.062	100
11135	7/16	.750	.453	.062	50
11136	1/2	.875	.516	.062	50
11137	5/8	1.187	.641	.062	50
11138	3/4	1.312	.766	.0937	25

S T A I N L E S S



IBS, INCORPORATED

Hex Nuts & Washers SS I01 - I08

Fender Washer SS (I07)



IBS No.	Size	Pkg Qty
12074	10 X 1	100
12075	1/4 X 1	100
12076	1/4 X 1-1/4	100
12077	1/4 X 1-1/2	100
12078	1/4 X 2	25
12079	5/16 X 1	100
12080	5/16 X 1-1/2	100
12081	5/16 X 2	25
12082	3/8 X 1-1/2	50
12083	3/8 X 2	25
12084	1/2 X 2	25

Fender Washer, SS Assortment (Z02)

IBS No. 850R • 11 ITEMS 345 PIECES

Packaged in a locking steel drawer for easy storage & organization



























IBS, Inc.
SPECIALTY PRODUCTS FOR MAINTENANCE & REPAIR
INDUSTRIALBOLT.COM © © © 800-678-1506

Fender Washers
Stainless Steel

Assortment No. 850R

<p>12074 10 X 1 FENDER WASHER SS</p>  	<p>12075 1/4 X 1 FENDER WASHER SS</p>  	<p>12076 1/4 X 1-1/4 FENDER WASHER SS</p>  
<p>12077 1/4 X 1-1/2 FENDER WASHER SS</p>  	<p>12078 1/4 X 2 FENDER WASHER SS</p>  	<p>12079 5/16 X 1 FENDER WASHER SS</p>  
<p>12080 5/16 X 1-1/2 FENDER WASHER SS</p>  	<p>12081 5/16 X 2 FENDER WASHER SS</p>  	<p>12082 3/8 X 1-1/2 FENDER WASHER SS</p>  
<p>12083 3/8 X 2 FENDER WASHER SS</p>  	<p>12084 1/2 X 2 FENDER WASHER SS</p>  	

S
T
A
I
N
L
E
S
S

IBS, INCORPORATED

NC Hex Hd C/S SS I12



Hex Head Cap Screws SS National Coarse



Size	1/4-20		5/16-18		3/8-16		7/16-14		1/2-13		5/8-11		3/4-10		Size
	IBS No.	Qty	IBS No.	Qty	IBS No.	Qty	IBS No.	Qty	IBS No.	Qty	IBS No.	Qty	IBS No.	Qty	
1/2	11340	50	11360	50	11380	50									1/2
3/4	11342	50	11362	50	11382	50									3/4
1	11344	50	11364	50	11384	50	11400	25	11412	25					1
1-1/4	11345	50	11366	50	11386	50	11402	25	11414	25	11433	15			1-1/4
1-1/2	11346	50	11367	50	11387	50	11403	25	11415	25	11434	15	11454	10	1-1/2
1-3/4	11347	50	11368	50	11388	50	11404	25			11435	15			1-3/4
2	11348	50	11369	50	11389	50	11405	25	11417	25	11436	15	11456	10	2
2-1/2	11350	25	11371	25	11391	25	11407	10	11419	10	11438	10	11458	10	2-1/2
3			11373	25	11393	25	11409	10	11421	10	11440	10	11460	10	3
3-1/2			11375	10	11395	10			11423	10	11442	10			3-1/2
4									11425	10	11444	10			4

Stainless Steel Assortment (Z06) IBS No. 445P • 40 Items - 1,316 Pieces USS SS BOLTS, COMMERCIAL SS FLAT WASHERS USS SS FINISHED NUTS, SS LOCKWASHERS

445P • STAINLESS STEEL ASSORTMENT • 40 Items

1/4-20 Hex Nut	1/4 Med LW	1/4 Com FW	1/4 x 1/2 Capscrew	1/4 x 3/4 Capscrew	1/4 x 1 Capscrew	1/4 x 1-1/4 Capscrew	1/4 x 1-1/2 Capscrew	11011	11122	11102	11340	11342	11344	11345	11346
5/16-18 Hex Nut	5/16 Med LW	5/16 Com FW	5/16 x 1/2 Capscrew	5/16 x 3/4 Capscrew	5/16 x 1 Capscrew	5/16 x 1-1/4 Capscrew	5/16 x 1-1/2 Capscrew	11012	11123	11103	11360	11362	11364	11366	11367
3/8-16 Hex Nut	3/8 Med LW	3/8 Com FW	3/8 x 1/2 Capscrew	3/8 x 3/4 Capscrew	3/8 x 1 Capscrew	3/8 x 1-1/4 Capscrew	3/8 x 1-1/2 Capscrew	11013	11124	11104	11380	11382	11384	11386	11387
7/16-14 Hex Nut	5/16 Med LW	7/16 Com FW	7/16 x 1 Capscrew	7/16 x 1-1/4 Capscrew	7/16 x 1-1/2 Capscrew	7/16 x 1-3/4 Capscrew	7/16 x 2 Capscrew	11014	11125	11105	11400	11402	11403	11404	11405
1/2-13 Hex Nut	1/2 Med LW	1/2 Com FW	1/2 x 1 Capscrew	1/2 x 1-1/4 Capscrew	1/2 x 1-1/2 Capscrew	1/2 x 2 Capscrew	1/2 x 2-1/2 Capscrew	11015	11126	11106	11412	11414	11415	11417	11419

S
T
A
I
N
L
E
S
S



IBS, INCORPORATED

Socket C/S SS (I13)

Trim Hex Head Machine Screws SS (I25)

• Deep Twist-Resistant Slots eliminate screwdriver slippage.

• Threads Are Feather-Free for faster and easier assemblies.



Size	6-32 IBS No.	8-32 IBS No.	10-24 IBS No.	10-32 IBS No.	Pkg Qty	Size
1/4					50	1/4
3/8	NS*	NS*	NS*	NS*	50	3/8
1/2	12701	12709	12717	12727	50	1/2
5/8	NS*	NS*	NS*	NS*	50	5/8
3/4	12703	12711	12719	12729	50	3/4
1	12704	12712	12721	12731	50	1
1-1/4			NS*	NS*	25	1-1/4
1-1/2			NS*	NS*	25	1-1/2
2			NS*		25	2

* Product may be ordered as a non-stock item

STAINLESS



Socket Head C/S SS (I13)

Size	6-32 IBS No.	8-32 IBS No.	10-24 IBS No.	10-32 IBS No.	1/4-20 IBS No.	5/16-18 IBS No.	3/8-16 IBS No.	1/2-13 IBS No.	Pkg Qty	Size
1/4	11500								100	1/4
1/2	11501	11504	11512	11520	11526				50	1/2
3/4	11502	11505	11513	11521	11528	11539	11550	11560	50	3/4
1	11503	11506	11514	11522	11530	11541	11552	11562	50	1
1-1/4					11531				50	1-1/4
1-1/2		11508	11516	11523	11532	11544	11553	11564	50	1-1/2
2		11510	11518	11525	11534	11546	11556	11566	25	2
2-1/2								11567	10	2-1/2
3								11568	10	3

Socket Head Capscrews, SS Assortment (Z02)

IBS No. 836R • 24 ITEMS 850 PIECES

Packaged in a locking steel drawer for easy storage & organization



IBS, Inc.
SPECIALTY PRODUCTS FOR MAINTENANCE & REPAIR
INDUSTRIALBOLT.COM © © © 800-678-1906

Socket Screw Size	Hex Size
1/4"	3/16"
3/8"	1/2"
1/2"	3/4"
5/8"	1 1/8"
3/4"	1 1/4"
1"	1 3/8"
1 1/4"	1 7/8"
1 1/2"	2"
2"	2 1/4"
2 1/2"	3"

Stainless Steel Socket Head Cap Screws

Assortment No. 836R

<p>11501 6-32 X 1/2 SOCKET HD C/S SS</p>	<p>11503 6-32 X 1 SOCKET HD C/S SS</p>	<p>11504 8-32 X 1/2 SOCKET HD C/S SS</p>	<p>11505 8-32 X 3/4 SOCKET HD C/S SS</p>	<p>11506 8-32 X 1 SOCKET HD C/S SS</p>	<p>11512 10-24 X 1/2 SOCKET HD C/S SS</p>
<p>11513 10-24 X 3/4 SOCKET HD C/S SS</p>	<p>11514 10-24 X 1 SOCKET HD C/S SS</p>	<p>11520 10-32 X 1/2 SOCKET HD C/S SS</p>	<p>11521 10-32 X 3/4 SOCKET HD C/S SS</p>	<p>11522 10-32 X 1 SOCKET HD C/S SS</p>	<p>11526 1/4-20 X 1/2 SOCKET HD C/S SS</p>
<p>11528 1/4-20 X 3/4 SOCKET HD C/S SS</p>	<p>11530 1/4-20 X 1 SOCKET HD C/S SS</p>	<p>11532 1/4-20 X 1-1/2 SOCKET HD C/S SS</p>	<p>11534 1/4-20 X 2 SOCKET HD C/S SS</p>	<p>11539 5/16-18 X 3/4 SOCKET HD C/S SS</p>	<p>11541 5/16-18 X 1 SOCKET HD C/S SS</p>
<p>11544 5/16-18 X 1-1/2 SOCKET HD C/S SS</p>	<p>11552 3/8-16 X 1 SOCKET HD C/S SS</p>	<p>11553 3/8-16 X 1-1/2 SOCKET HD C/S SS</p>	<p>11556 3/8-16 X 2 SOCKET HD C/S SS</p>		



Flat Head Socket C/S SS (I13)

Size	#6 IBS No.	#8 IBS No.	#10-24 IBS No.	10-32 IBS No.	1/4-20 IBS No.	5/16-18 IBS No.	3/8-16 IBS No.	1/2-13 IBS No.	Pkg Qty	Size
1/4	11950	11955	11960						100	1/4
3/8	11951	11956	11961	11965					100	3/8
1/2	11952	11957	11962	11966	11970				50	1/2
3/4	11953	11958	11963	11967	11971	11976	11981		50	3/4
1	11954	11959	11964	11968	11972	11977	11982	11986	50	1
1-1/4					11973	11978	11983		50	1-1/4
1-1/2					11974	11979	11984	11988	50	1-1/2
2					11975	11980	11985	11989	25	2

Flat Socket Head Capscrews, SS Assortment (Z02)

IBS No. 838R • 24 ITEMS 1080 PIECES

Packaged in a locking steel drawer for easy storage & organization



IBS Inc.		Stainless Steel Flat Socket Cap Screws	
PRECISION PRODUCTS FOR MAINTENANCE & REPAIR		ASSORTMENT NO. 838R	
11982 6-32 X 1/2 FLAT SOCKET C/S SS	11983 6-32 X 3/4 FLAT SOCKET C/S SS	11984 6-32 X 1 FLAT SOCKET C/S SS	11987 8-32 X 1/2 FLAT SOCKET C/S SS
11985 10-24 X 1/2 FLAT SOCKET C/S SS	11986 10-24 X 3/4 FLAT SOCKET C/S SS	11988 10-24 X 1 FLAT SOCKET C/S SS	11991 8-32 X 1 FLAT SOCKET C/S SS
11990 1/4-20 X 1/2 FLAT SOCKET C/S SS	11991 1/4-20 X 3/4 FLAT SOCKET C/S SS	11992 1/4-20 X 1 FLAT SOCKET C/S SS	11994 1/4-20 X 1-1/2 FLAT SOCKET C/S SS
11978 5/16-18 X 1-1/4 FLAT SOCKET C/S SS	11979 5/16-18 X 1-1/2 FLAT SOCKET C/S SS	11981 3/8-16 X 3/4 FLAT SOCKET C/S SS	11982 3/8-16 X 1 FLAT SOCKET C/S SS
			11983 3/8-16 X 1-1/4 FLAT SOCKET C/S SS
			11984 3/8-16 X 1-1/2 FLAT SOCKET C/S SS

Button Head Socket C/S SS (I13)



Size	6-32 IBS No.	8-32 IBS No.	10-24 IBS No.	10-32 IBS No.	1/4-20 IBS No.	5/16-18 IBS No.	3/8-16 IBS No.	1/2-13 IBS No.	Pkg Qty	Size
1/4	11900	11905	11910						100	1/4
3/8	11901	11906	11911	11915					100	3/8
1/2	11902	11907	11912	11916	11920				50	1/2
3/4	11903	11908	11913	11917	11921	11926	11931		50	3/4
1	11904	11909	11914	11918	11922	11927	11932	11936	50	1
1-1/4					11923	11928	11933		50	1-1/4
1-1/2					11924	11929	11934	11938	50	1-1/2
2					11925	11930	11935	11939	25	2

Button Head Socket Capscrews, SS Assortment (Z02)

IBS No. 837R • 24 ITEMS 1060 PIECES

Packaged in a locking steel drawer for easy storage & organization



IBS Inc.		Stainless Steel Button Socket Cap Screws	
PRECISION PRODUCTS FOR MAINTENANCE & REPAIR		ASSORTMENT NO. 837R	
11902 6-32 X 1/2 BUTTON SOCKET C/S SS	11903 6-32 X 3/4 BUTTON SOCKET C/S SS	11904 6-32 X 1 BUTTON SOCKET C/S SS	11907 8-32 X 1/2 BUTTON SOCKET C/S SS
11912 10-24 X 1/2 BUTTON SOCKET C/S SS	11913 10-24 X 3/4 BUTTON SOCKET C/S SS	11914 10-24 X 1 BUTTON SOCKET C/S SS	11916 10-24 X 1/2 BUTTON SOCKET C/S SS
11920 1/4-20 X 1/2 BUTTON SOCKET C/S SS	11921 1/4-20 X 3/4 BUTTON SOCKET C/S SS	11922 1/4-20 X 1 BUTTON SOCKET C/S SS	11924 1/4-20 X 1-1/2 BUTTON SOCKET C/S SS
11928 5/16-18 X 1-1/4 BUTTON SOCKET C/S SS	11929 5/16-18 X 1-1/2 BUTTON SOCKET C/S SS	11931 3/8-16 X 3/4 BUTTON SOCKET C/S SS	11932 3/8-16 X 1 BUTTON SOCKET C/S SS
			11933 3/8-16 X 1-1/4 BUTTON SOCKET C/S SS
			11934 3/8-16 X 1-1/2 BUTTON SOCKET C/S SS

STAINLESS



IBS, INCORPORATED

Socket C/S SS (I13)

Socket Set Screws SS (I13)



Size	10-24 IBS No.	10-32 IBS No.	1/4-20 IBS No.	5/16-18 IBS No.	3/8-16 IBS No.	1/2-13 IBS No.	Pkg Qty	Size
1/4	12963	12978	12991	13007			25	1/4
3/8			12993	13009	13022	13035	25	3/8
1/2	12967	12982	12995	13011	*NS	13037	25	1/2

* Product may be ordered as a non-stock item

Phillips Pan Head Machine Screws SS (I18)



Size	6-32 IBS No.	8-32 IBS No.	10-24 IBS No.	10-32 IBS No.	1/4-20 IBS No.	Pkg Qty	Size
1/4	12160					50	1/4
3/8	12162	12176			12216	50	3/8
1/2	12164	12178	12191	12205	12218	50	1/2
5/8			12192	12206	12219	50	5/8
3/4	12166	12180	12193	12207	12220	50	3/4
1	12168	12182	12195	12209	12222	50	1
1-1/4		12183	12196	12210	12223	25	1-1/4
1-1/2	12170	12184	12197	12211	12224	25	1-1/2
2				12212	12225	25	2

12225* Product may be ordered as a non-stock item

S
T
A
I
N
L
E
S
S

SS Phillips Pan Head Machine Screws with Hex Nuts (Z02)

IBS No. 194R • 24 ITEMS 1150 PIECES
Packaged in a locking steel drawer for easy storage & organization



IBS, Inc.						Stainless Steel Phillips Pan Head Machine Screws with Hex Nuts					
Assortment No. 194R											
11002 6-32 MACHINE SCREW NUT SS	11003 8-32 MACHINE SCREW NUT SS	11006 10-32 MACHINE SCREW NUT SS	11004 10-24 MACHINE SCREW NUT SS	12196 10-24 X 1-1/4 PHIL PAN M/S SS	12220 1/4-20 X 3/4 PHIL PAN M/S SS	12164 6-32 X 1/2 PHIL PAN M/S SS	12178 8-32 X 1/2 PHIL PAN M/S SS	12205 10-32 X 1/2 PHIL PAN M/S SS	12191 10-24 X 1/2 PHIL PAN M/S SS	12197 10-24 X 1-1/2 PHIL PAN M/S SS	12222 1/4-20 X 1 PHIL PAN M/S SS
12166 6-32 X 3/4 PHIL PAN M/S SS	12180 8-32 X 3/4 PHIL PAN M/S SS	12207 10-32 X 3/4 PHIL PAN M/S SS	12193 10-24 X 3/4 PHIL PAN M/S SS	11007 1/4-20 MACHINE SCREW NUT SS	12223 1/4-20 X 1-1/4 PHIL PAN M/S SS	12168 6-32 X 1 PHIL PAN M/S SS	12182 8-32 X 1 PHIL PAN M/S SS	12209 10-32 X 1 PHIL PAN M/S SS	12195 10-24 X 1 PHIL PAN M/S SS	12215 1/4-20 X 1/2 PHIL PAN M/S SS	12224 1/4-20 X 1-1/2 PHIL PAN M/S SS



Phillips Flat Head Machine Screws SS



Size	6-32 IBS No.	8-32 IBS No.	10-24 IBS No.	10-32 IBS No.	1/4-20 IBS No.	Pkg Qty	Size
1/4	12271	NS*	NS*	NS*	NS*	50	1/4
3/8	12273	12287	12301	12314	12326	50	3/8
1/2	12275	12289	12303	12316	12328	50	1/2
5/8	NS*	NS*	NS*	NS*	NS*	50	5/8
3/4	12277	12291	12305	12318	12330	50	3/4
1	12279	12293	12307	12320	12332	50	1
1-1/4	NS*	12294	12308	12321	12333	25	1-1/4
1-1/2	NS*	12295	12309	12322	12334	25	1-1/2
2	NS*	NS*	NS*	NS*	12335	25	2

Phillips Oval Head Machine Screws SS



Size	4-40 IBS No.	6-32 IBS No.	8-32 IBS No.	10-24 IBS No.	10-32 IBS No.	1/4-20 IBS No.	Pkg Qty	Size
1/4	NS*	12376	NS*	NS*	NS*	NS*	50	1/4
3/8	NS*	12378	12392	NS*	NS*	NS*	50	3/8
1/2	NS*	12380	12394	12408	12421	12433	50	1/2
5/8	NS*	NS*	NS*	NS*	12422	NS*	50	5/8
3/4	NS*	12382	12396	12410	12423	12435	50	3/4
1	NS*	12384	12398	12412	12425	12437	50	1
1-1/4	NS*	NS*	NS*	NS*	NS*	12438	25	1-1/4
1-1/2	NS*	NS*	12400	12414	12427	12439	25	1-1/2
2	NS*	NS*	NS*	NS*	NS*	12440	25	2

* Product may be ordered as a non-stock item

Phillips Pan Head Tapping Screws SS



Size	#6 IBS No.	#8 IBS No.	#10 IBS No.	#12 IBS No.	#14 IBS No.	Pkg Qty	Size
3/8	12528	12537	12546			50	3/8
1/2	12529	12538	12547	12557	12567	50	1/2
5/8	12530	12539	12548	12558	12568	50	5/8
3/4	12531	12540	12549	12559	12569	50	3/4
1	12532	12541	12550	12560	12570	50	1
1-1/4	12533	12542	12551	12561	12571	50	1-1/4
1-1/2	12534	12543	12552	12562	12572	50	1-1/2
2			12554	12564	12574	50	2

S
T
A
I
N
L
E
S
S



IBS, INCORPORATED

Phillips T/S SS I22

SS Phillips Pan Head Tapping Screws

IBS No. 195R • 24 ITEMS • 1200 PIECES
Packaged in a locking steel drawer for easy storage & organization



IBS, Inc.		Stainless Steel Phillips Pan Head Sheet Metal Screws			
SPECIALTY PRODUCTS FOR MAINTENANCE & REPAIR		Assortment No. 195R			
12528 6 X 3/8 PHIL PAN T/S SS	12532 6 X 1 PHIL PAN T/S SS	12541 8 X 1 PHIL PAN T/S SS	12550 10 X 1 PHIL PAN T/S SS	12560 12 X 1 PHIL PAN T/S SS	12569 14 X 3/4 PHIL PAN T/S SS
12529 6 X 1/2 PHIL PAN T/S SS	12535 8 X 1/2 PHIL PAN T/S SS	12547 10 X 1/2 PHIL PAN T/S SS	12552 10 X 1-1/2 PHIL PAN T/S SS	12561 12 X 1-1/4 PHIL PAN T/S SS	12570 14 X 1-1/4 PHIL PAN T/S SS
12530 6 X 5/8 PHIL PAN T/S SS	12539 8 X 5/8 PHIL PAN T/S SS	12548 10 X 5/8 PHIL PAN T/S SS	12557 12 X 1/2 PHIL PAN T/S SS	12562 12 X 1-1/2 PHIL PAN T/S SS	12571 14 X 1-1/4 PHIL PAN T/S SS
12531 6 X 3/4 PHIL PAN T/S SS	12540 8 X 3/4 PHIL PAN T/S SS	12549 10 X 3/4 PHIL PAN T/S SS	12559 12 X 3/4 PHIL PAN T/S SS	12568 14 X 5/8 PHIL PAN T/S SS	12572 14 X 1-1/2 PHIL PAN T/S SS

Phillips Flat Head Tapping Screws SS



Size	#6 IBS No.	#8 IBS No.	#10 IBS No.	#12 IBS No.	#14 IBS No.	Pkg Qty	Size
3/8	12588	12597	12606			50	3/8
1/2	12589	12598	12607	12618		50	1/2
3/4	12591	12600	12609	12620	12630	50	3/4
1	12592	12601	12610	12621	12631	50	1
1-1/4	12593	12602	12611	12622	12632	50	1-1/4
1-1/2	12594	12603	12612	12623	12633	50	1-1/2
2			12614	12625	12635	50	2
3					NS*	50	3

* Product may be ordered as a non-stock item

Phillips Oval Head Tapping Screws SS



Size	#6 IBS No.	#8 IBS No.	#10 IBS No.	#12 IBS No.	#14 IBS No.	Pkg Qty	Size
1/2	12649	12658	12667	12677	12687	50	1/2
5/8	12650	12659	12668	12678		50	5/8
3/4	12651	12660	12669	12679	12689	50	3/4
1	12652	12661	12670	12680	12690	50	1
1-1/4	12653	12662	12671	12681	12691	50	1-1/4
1-1/2		12663	12372	12682	12692	50	1-1/2

Phil Oval Head Tapping Screws, Stainless Steel

IBS No. 171R • 24 Items • 1075 Pcs
Packaged in a locking steel drawer for easy storage & organization



IBS, Inc.		Stainless Steel Phillips Oval Head Tapping Screws			
SPECIALTY PRODUCTS FOR MAINTENANCE & REPAIR		Assortment No. 171R			
12649 6 X 1/2 PHIL OVAL T/S SS	12653 6 X 1-1/4 PHIL OVAL T/S SS	12661 8 X 1 PHIL OVAL T/S SS	12665 10 X 3/4 PHIL OVAL T/S SS	12679 12 X 3/4 PHIL OVAL T/S SS	12689 14 X 3/4 PHIL OVAL T/S SS
12650 6 X 5/8 PHIL OVAL T/S SS	12658 8 X 1/2 PHIL OVAL T/S SS	12662 8 X 1-1/4 PHIL OVAL T/S SS	12670 10 X 1 PHIL OVAL T/S SS	12680 12 X 1 PHIL OVAL T/S SS	12690 14 X 1 PHIL OVAL T/S SS
12651 6 X 3/4 PHIL OVAL T/S SS	12659 8 X 5/8 PHIL OVAL T/S SS	12667 10 X 1/2 PHIL OVAL T/S SS	12671 10 X 1-1/4 PHIL OVAL T/S SS	12681 12 X 1-1/4 PHIL OVAL T/S SS	12691 14 X 1-1/4 PHIL OVAL T/S SS
12652 6 X 1 PHIL OVAL T/S SS	12660 8 X 3/4 PHIL OVAL T/S SS	12668 10 X 5/8 PHIL OVAL T/S SS	12672 10 X 1-1/2 PHIL OVAL T/S SS	12682 12 X 1-1/2 PHIL OVAL T/S SS	12692 14 X 1-1/2 PHIL OVAL T/S SS

S
T
A
I
N
L
E
S
S

IBS, INCORPORATED

Teks Screws SS (I23)



Hex Washer Head Tek Screws SS (I23)



Size	#6 IBS No.	#8 IBS No.	#10 IBS No.	#12 IBS No.	#14 IBS No.	Pkg Qty	Size
1/2		12770	12774			50	1/2
3/4	12768	12771	12775	12780	12785	50	3/4
1	12769	12772	12776	12781	12786	50	1
1-1/4		12773	12777	12782	12787	25	1-1/4
1-1/2		12830	12778	12783	12788	25	1-1/2
2		12831	12832	12784	12789	25	2
2-1/2			12833	12835	12838	25	2-1/2
3			12834	12836	12839	25	3
4				12837	12840	25	4

HWH Tek[®] S.S. Assortment (Z02)

IBS No. 311R • 13 Items • 525 Pcs
Packaged in a locking steel drawer for easy storage & organization



IBS, Inc. SPECIALTY PRODUCTS FOR MAINTENANCE & SERVICE INDUSTRIALBUILD.COM © 2013 300-670-1300				Stainless Steel Hex Washer Head TEK Screws			
Assortment No. 311R							
12770 8 X 1/2 HWH TEK SS Hex Size 1/4"	12771 8 X 3/4 HWH TEK SS Hex Size 1/4"	12772 8 X 1 HWH TEK SS Hex Size 1/4"	12830 8 X 1-1/2 HWH TEK SS Hex Size 1/4"	12774 10 X 1/2 HWH TEK SS Hex Size 5/16"	12775 10 X 3/4 HWH TEK SS Hex Size 5/16"	12776 10 X 1 HWH TEK SS Hex Size 5/16"	12778 10 X 1-1/2 HWH TEK SS Hex Size 5/16"
12780 12 X 3/4 HWH TEK SS Hex Size 5/16"	12781 12 X 1 HWH TEK SS Hex Size 5/16"	12783 12 X 1-1/2 HWH TEK SS Hex Size 5/16"	12784 12 X 2 HWH TEK SS Hex Size 5/16"	12785 14 X 3/4 HWH TEK SS Hex Size 5/16"	12786 14 X 1 HWH TEK SS Hex Size 5/16"	12788 14 X 1-1/2 HWH TEK SS Hex Size 5/16"	12789 14 X 2 HWH TEK SS Hex Size 5/16"

Phillips Pan Head Tek Screws SS (I23)



Length	Diameter				
	#6	#8	#10	#12	#14
1/2	12740	12745	12750		
3/4	12741	12746	12751	12755	12760
1	12742	12747	12752*	12756	12761
1-1/4				12757*	12762*
1-1/2		12748*	12753*	12758*	12763*
2"					12764*
Qty	100	100/50*	100/50*	50/25*	50/25*

Phil Pan Hd Tek[®] S.S. Assortment (Z02)

IBS No. 310R • 21 Items • 825 Pcs
Packaged in a locking steel drawer for easy storage & organization



IBS, Inc. SPECIALTY PRODUCTS FOR MAINTENANCE & SERVICE INDUSTRIALBUILD.COM © 2013 300-670-1300				Stainless Steel Phillips Pan Head TEK Screws		
Assortment No. 310R						
12740 6 X 1/2 PHIL PAN TEK SS	12741 6 X 3/4 PHIL PAN TEK SS	12742 6 X 1 PHIL PAN TEK SS	12745 8 X 1/2 PHIL PAN TEK SS	12746 8 X 3/4 PHIL PAN TEK SS	12747 8 X 1 PHIL PAN TEK SS	12750 10 X 1/2 PHIL PAN TEK SS
12748 8 X 1-1/2 PHIL PAN TEK SS	12751 10 X 3/4 PHIL PAN TEK SS	12752 10 X 1 PHIL PAN TEK SS	12755 10 X 1-1/4 PHIL PAN TEK SS	12756 12 X 1 PHIL PAN TEK SS	12757 12 X 1-1/4 PHIL PAN TEK SS	12758 12 X 1-1/2 PHIL PAN TEK SS
12753 10 X 1-1/2 PHIL PAN TEK SS	12755 12 X 3/4 PHIL PAN TEK SS	12756 12 X 1 PHIL PAN TEK SS	12757 12 X 1-1/4 PHIL PAN TEK SS	12758 12 X 1-1/2 PHIL PAN TEK SS	12760 14 X 3/4 PHIL PAN TEK SS	12761 14 X 1 PHIL PAN TEK SS
12762 14 X 1-1/4 PHIL PAN TEK SS	12763 14 X 1-1/2 PHIL PAN TEK SS	12764 14 X 2 PHIL PAN TEK SS				

S T A I N L E S S



IBS, INCORPORATED

Teks Screws SS (I23)

Square Drive Pan Head Teks Screws SS



Size	#6 IBS No.	#8 IBS No.	#10 IBS No.	#12 IBS No.	#14 IBS No.	Pkg Qty	Size
3/8	12800	12804				50	3/8
1/2	12801	12805	12811			50	1/2
5/8		12806	12812			50	5/8
3/4	12802	12807	12813	12818	12823	50	3/4
1	12803	12808	12814	12819	12824	50	1
1-1/4		12809	12815	12820	12825	50	1-1/4
1-1/2		12810	12816	12821	12826	50	1-1/2
2			12817	12822	12827	50	2

**Square Drive Pan Hd Teks®
S.S. Assortment (Z02)**
IBS No. 313R • 20 Items • 590 Pcs
Packaged in a locking steel drawer for easy
storage & organization



IBS, Inc.
SPECIALTY PRODUCTS FOR MAINTENANCE & REPAIR
INDUSTRIALMARKET.COM © © © 800-675-1908

**Stainless Steel Square Drive
Pan Head TEK Screws**

Assortment No. 313R

12801 6 X 1/2 SQUARE DR PAN TEK	12802 6 X 3/4 SQUARE DR PAN TEK	12803 6 X 1 SQUARE DR PAN TEK SCREW	12805 8 X 1/2 SQUARE DR PAN TEK	12807 8 X 3/4 SQUARE DR PAN TEK
12808 8 X 1 SQUARE DR PAN TEK SCREW	12810 8 X 1-1/2 SQUARE DR PAN TEK	12811 10 X 1/2 SQUARE DR PAN TEK	12813 10 X 3/4 SQUARE DR PAN TEK	12814 10 X 1 SQUARE DR PAN TEK
12816 10 X 1-1/2 SQUARE DR PAN TEK	12817 10 X 2 SQUARE DR PAN TEK	12818 12 X 3/4 SQUARE DR PAN TEK	12819 12 X 1 SQUARE DR PAN TEK	12821 12 X 1-1/2 SQUARE DR PAN TEK
12822 12 X 2 SQUARE DR PAN TEK	12823 14 X 3/4 SQUARE DR PAN TEK	12824 14 X 1 SQUARE DR PAN TEK	12826 14 X 1-1/2 SQUARE DR PAN TEK	12827 14 X 2 SQUARE DR PAN TEK

S
T
A
I
N
L
E
S
S



Button Socket Machine Screws with Pin Stainless Steel Security Screws



Size	6-32 IBS No.	Pkg Qty	8-32 IBS No.	Pkg Qty	10-24 IBS No.	Pkg Qty	10-32 IBS No.	Pkg Qty	14-20 IBS No.	Pkg Qty	Size
1/2	12850	50	12853	50	12857	50	12863	50	12869	25	1/2
5/8					12858	50	12864	50	12870	25	5/8
3/4	12851	50	12854	50	12859	50	12865	50	12871	25	3/4
1	12852	50	12855	50	12860	25	12866	25	12872	25	1
1-1/4					12861	25	12867	25	12873	25	1-1/4
1-1/2			12856	25	12862	25	12868	25	12874	25	1-1/2
2									12875	10	2
Use with 1/8 Driver Bit IBS No. 12945			Use with 5/32 Driver Bit IBS No. 12946								

Button Socket Machine Screws with Pin Stainless Steel Security Screws Asst (Z02)

IBS No. 388R • 19 Items • 162 Pcs
Packaged in a locking steel drawer for easy storage & organization



IBS, Inc. QUALITY PRODUCTS FOR MAINTENANCE & REPAIR WWW.IBSINC.COM 800-850-1100		Stainless Steel Button Socket Security Machine Screws								
Assortment No. 388R										
12850 6-32 X 1/2 SEC BS C/S SS 1/8 DRIVE	12851 6-32 X 3/4 SEC BS C/S SS 1/8 DRIVE	12852 6-32 X 1 SEC BS C/S SS 1/8 DRIVE	12853 8-32 X 1/2 SEC BS C/S SS 5/32 DRIVE	12854 8-32 X 3/4 SEC BS C/S SS 5/32 DRIVE	12855 8-32 X 1 SEC BS C/S SS 5/32 DRIVE	12857 10-24 X 1/2 SEC BS C/S SS 5/32 DRIVE	12859 10-24 X 3/4 SEC BS C/S SS 5/32 DRIVE	12860 10-24 X 1 SEC BS C/S SS 5/32 DRIVE	12863 10-32 X 1/2 SEC BS C/S SS 5/32 DRIVE	12864 10-32 X 3/4 SEC BS C/S SS 5/32 DRIVE
12865 10-32 X 3/4 SEC BS C/S SS 5/32 DRIVE	12866 10-32 X 1 SEC BS C/S SS 5/32 DRIVE	12871 1/4-20 X 3/4 SEC BS C/S SS 5/32 DRIVE	12872 1/4-20 X 1 SEC BS C/S SS 5/32 DRIVE	12874 1/4-20 X 1-1/2 SEC BS C/S SS 5/32 DRIVE	12880 10-24 SECURITY BREAKAWAY NUT	12881 1/4-20 SECURITY BREAKAWAY NUT	12945 1/8 HEX W/PIN 1/4 HEX DRIVER	12946 5/32 HEX W/PIN 1/4 HEX DRIVER		

Button Socket Tapping Screws with Pin Stainless Steel Security Screws



Size	#6 IBS No.	Pkg Qty	#8 IBS No.	Pkg Qty	#10 IBS No.	Pkg Qty	Size
3/8	12900	50	12904	50			3/8
1/2	12901	50	12905	50	12910	25	1/2
5/8							5/8
3/4	12902	25	12906	25	12911	25	3/4
1	12903	25	12907	25	12912	25	1
1-1/4			12908	25	12913	25	1-1/4
1-1/2			12909	25	12914	25	1-1/2
2					12915	25	2
Use with 1/8 Driver Bit IBS No. 12945		Use 5/32 Driver Bit IBS No. 12946					

S
T
A
I
N
L
E
S
S



IBS, INCORPORATED

Security Screws SS (I26)

Button Socket Security Tapping Screws SS Asst (Z02)

IBS No. 389R • 18 Items • 232 Pcs
Packaged in a locking steel drawer for easy storage & organization



IBS, Inc.		Stainless Steel Button Socket Security Tapping Screws		
Assortment No. 389R				
12900 6 X 3/8 SEC BS C/S SS 1/8 DRIVE	12901 6 X 1/2 SEC BS C/S SS 1/8 DRIVE	12902 6 X 3/4 SEC BS C/S SS 1/8 DRIVE	12903 6 X 1 SEC BS C/S SS 1/8 DRIVE	12904 8 X 3/8 SEC BS C/S SS 5/32 DRIVE
12905 8 X 1/2 SEC BS C/S SS 5/32 DRIVE	12906 8 X 3/4 SEC BS C/S SS 5/32 DRIVE	12907 8 X 1 SEC BS C/S SS 5/32 DRIVE	12908 8 X 1-1/4 SEC BS C/S SS 5/32 DRIVE	12909 8 X 1-1/2 SEC BS C/S SS 5/32 DRIVE
12910 10 X 1/2 SEC BS C/S SS 5/32 DRIVE	12911 10 X 3/4 SEC BS C/S SS 5/32 DRIVE	12912 10 X 1 SEC BS C/S SS 5/32 DRIVE	12913 10 X 1-1/4 SEC BS C/S SS 5/32 DRIVE	12914 10 X 1-1/2 SEC BS C/S SS 5/32 DRIVE
12915 10 X 2 SEC BS C/S SS 5/32 DRIVE			12945 1/8 HEX W/PIN 1/4 HEX DRIVER	12946 5/32 HEX W/PIN 1/4 HEX DRIVER

Breakaway Security Nuts



IBS No.	Size	Pkg Qty
12880	10-24	25
12881	1/4-20	25

Hex Security Wrenches (P12)



IBS No.	Size	Use With	Pkg Qty
12920	1/8	#6 Screws	2
12922	5/32	#8 & #10 Screws	2

Long Security Hex Driver Bits (P12)



IBS No.	Size	Use With	Pkg Qty
12944	3/32		2
12945	1/8	#6 Screws	2
12946	5/32	1/8 - 1/4 Screws	2
12947	3/16		2
12948	7/32		2

S
T
A
I
N
L
E
S
S

IBS, INCORPORATED

Cotter Pins SS (I27)



Cotter Pins SS

Dia.	Length	IBS No.	Qty	Dia.	Length	IBS No.	Qty	Dia.	Length	IBS No.	Qty
1/16	1/2	13300	100	1/8	3/4	13315	100	3/16	1-1/2	13332	25
	3/4	13301	100		1	13316	100		2	13334	25
	1	13302	100		1-1/2	13318	50		2-1/2	13335	25
	1-1/2	13304	100		2	13320	50		3	13336	10
	2	13306	100		2-1/2	13321	50				
3/32	3/4	13308	100	5/32	3	13322	25				
	1	13309	100		1	13323	50				
	1-1/2	13311	100		1-1/2	13325	25				
	2	13313	50		2	13327	25				
					2-1.2	13328	25				
				3	13329	10					



Cotter Pins SS (Z02)

IBS No. 798R • 18 Items • 232 Pcs

Packaged in a locking steel drawer for easy storage & organization

S T A I N L E S S

IBS, Inc. <small>SPECIALTY PRODUCTS FOR MAINTENANCE & REPAIR INDUSTRIALBOLT.COM © 800-678-1906</small>						Stainless Steel Cotter Pins					
Assortment No. 798R											
13300 1/16 X 1/2 COTTER PIN SS 	13306 1/16 X 2 COTTER PIN SS 	13313 3/32 X 2 COTTER PIN SS 	13320 1/8 X 2 COTTER PIN SS 	13325 5/32 X 1-1/2 COTTER PIN SS 	13332 3/16 X 1-1/2 COTTER PIN SS 						
13301 1/16 X 3/4 COTTER PIN SS 	13308 3/32 X 3/4 COTTER PIN SS 	13315 1/8 X 3/4 COTTER PIN SS 	13321 1/8 X 2-1/2 COTTER PIN SS 	13327 5/32 X 2 COTTER PIN SS 	13334 3/16 X 2 COTTER PIN SS 						
13302 1/16 X 1 COTTER PIN SS 	13309 3/32 X 1 COTTER PIN SS 	13316 1/8 X 1 COTTER PIN SS 	13322 1/8 X 3 COTTER PIN SS 	13328 5/32 X 2-1/2 COTTER PIN SS 	13335 3/16 X 2-1/2 COTTER PIN SS 						
13304 1/16 X 1-1/2 COTTER PIN SS 	13311 3/32 X 1-1/2 COTTER PIN SS 	13318 1/8 X 1-1/2 COTTER PIN SS 	13323 5/32 X 1 COTTER PIN SS 	13329 5/32 X 3 COTTER PIN SS 	13336 3/16 X 3 COTTER PIN SS 						



**S
T
A
I
N
L
E
S
S**



Rings & Pins

A

Assortments

- Clevis Pin K-5
- E-Clips, Regular & Reinforced K-13
- Hitch Pin K-9, K-10, K-11
- Key Stock K-21
- O-Ring
 - Metric K-15, K-17
 - Metric O-Rings K-17
 - Metric O-Ring Splice Kit K-17
 - Nitrile Air Conditioning O-Ring Assortment K-20
 - Standard K-14, K-19
 - Standard O-Rings K-15
 - Standard O-Ring Splice Kit K-15
- Viton
 - Viton O-Rings K-19
 - Viton O-Ring Splice Kit K-19
- Retaining Ring K-12
- Roll Pin K-3
- Snapper & Lynch Pins K-22
- Woodruff Key K-4

B

Ball Joints

- Assemblies K-8
- “Flat Top” K-8
- Quick Disconnect K-8
- Rod End K-7

C

- Cotter Pins K-2

D

- Dowel Pins K-21

H

- Hitch Pins K-9

K

- Key Stock, Square K-21

L

- Lynch Pins K-22

O

O-Rings

- Cord Material K-15
- “O” Ring Cord K-15
- Metric K-16
- Splice Kit K-17
- Nitrile Air Conditioning O-Rings K-20
- Splice Kit K-17
- Standard K-14, K-18, K-20
- “O” Ring Cord K-15
- Viton K-18, K-20
- Viton O-Ring Splice Kit K-19

R

Retaining Rings

- “E” Type K-13
- Reinforced K-13
- External K-12
- Internal K-12

Roll Pins K-3

S

Snapper Pins K-22

Spring Pins

- Rolled K-3. *See also* Roll Pins

W

Woodruff Keys K-4

Y

Yoke Ends

- Drop Forged K-6



IBS, INCORPORATED

Cotter Pins K01



Cotter Pins

Extended Prong - Chisel Point Steel

Dia.	Length	IBS No.	Qty	Dia.	Length	IBS No.	Qty	Dia.	Length	IBS No.	Qty	Dia.	Length	IBS No.	Qty	
1/16 O.D. .063	1/2	13467	100	7/64 O.D. .109	3/4	13518	100	3/16 O.D. .188	3/4	13557	50	3/8 O.D. .375	2	13616	10	
	3/4	13468	100		1	13519	100		1	13558	50		2-1/2	13618	10	
	1	13469	100		1-1/2	13521	100		1-1/2	13560	50		3	13619	10	
	1-1/2	13471	100		2	13523	50		2	13562	25		4	13621	10	
	2	13473	50		1/2	13503	100		2-1/2	13564	25		5	13623	10	
5/64 O.D. .078	3/4	13492	100	3/4	13504	100	3	13565	25	6	13624		10	7/16 O.D. .438	2-1/2	13629
	1	13493	100	1	13505	100	1/4 O.D. .250	1	13570	25	3	13630	10			
	1-1/2	13495	100	1-1/4	13506	100		1-1/2	13572	25	3-1/2	13631	10			
2	13497	50	1-1/2	13507	100	2		13574	10	4	13632	10				
3/32 O.D. .094	1/2	13479	100	1-3/4	13508	50		2-1/2	13576	10	1/2 O.D. .500	3	13641	10		
	3/4	13480	100	2	13509	50		3	13577	10		4	13643	10		
	1	13481	100	2-1/2	13511	50		4	13579	10		5	13645	10		
	1-1/4	13482	100	3	13512	50	5	13581	10	6	13646	10				
	1-1/2	13483	100	5/32 O.D. .156	1	13532	100	2	13602	10						
2	13485	50	1-1/4		13533	100	2-1/2	13604	10							
1/8 O.D. .125	1-1/2	13498	100		1-1/2	13534	100	3	13605	10						
	1	13499	100		1-3/4	13535	50	4	13607	10						
	1-1/4	13500	100		2	13536	50	5	13609	10						
	1-1/2	13501	100	2-1/2	13538	50	6	13610	10							
	1-3/4	13502	50	3	13539	25										
	2	13503	50													

RINGS & PINS

Cotter Pin Assortment (Z02)

IBS No. 125R • 24 Items - 1545 Pieces
Packaged in a locking steel drawer for easy storage & organization

IBS, Inc. Cotter Pins					
Assortment No. 125R					
13469 1/16 X 1 COTTER PIN ZP	13471 1/16 X 1-1/2 COTTER PIN ZP	13473 1/16 X 2 COTTER PIN ZP	13481 3/32 X 1 COTTER PIN ZP	13483 3/32 X 1-1/2 COTTER PIN ZP	13577 1/4 X 3 COTTER PIN ZP
13485 3/32 X 2 COTTER PIN ZP	13522 5/32 X 1 COTTER PIN ZP	13534 5/32 X 1-1/2 COTTER PIN ZP	13505 1/8 X 1 COTTER PIN ZP	13507 3/16 X 1-1/2 COTTER PIN ZP	13812 1/8 X 3 COTTER PIN ZP
13509 1/8 X 2 COTTER PIN ZP	13536 5/32 X 2 COTTER PIN ZP	13539 5/32 X 3 COTTER PIN ZP	13558 3/16 X 1 COTTER PIN ZP	13560 3/16 X 1-1/2 COTTER PIN ZP	13565 3/16 X 3 COTTER PIN ZP
13562 3/16 X 2 COTTER PIN ZP	13572 1/4 X 1-1/2 COTTER PIN ZP	13574 1/4 X 2 COTTER PIN ZP	13602 5/16 X 2 COTTER PIN ZP	13616 3/8 X 2 COTTER PIN ZP	13618 3/8 X 2-1/2 COTTER PIN ZP

Cotter Pin Assortment (Z02)

LARGE DIAMETER — LONG LENGTH
IBS No. 155R • 13 Items - 115 Pieces
Packaged in a locking steel drawer for easy storage & organization

IBS, Inc. Cotter Pins	
Large Diameter Long Length	
Assortment No. 155R	
13646 1/2 X 6 COTTER PIN ZP	13645 1/2 X 5 COTTER PIN ZP
13624 3/8 X 6 COTTER PIN ZP	13643 1/2 X 4 COTTER PIN ZP
13623 3/8 X 5 COTTER PIN ZP	13579 1/4 X 4 COTTER PIN ZP
13621 3/8 X 4 COTTER PIN ZP	13581 1/4 X 5 COTTER PIN ZP
13605 5/16 X 3 COTTER PIN ZP	13609 5/16 X 5 COTTER PIN ZP
13641 1/2 X 3 COTTER PIN ZP	13604 5/16 X 2-1/2 COTTER PIN ZP
	13607 5/16 X 4 COTTER PIN ZP

IBS, INCORPORATED

Roll Pins K02

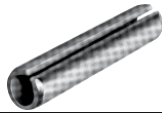

Roll Pins

ZINC PLATED CARBON SPRING STEEL

Dia.	Length	IBS No.	Qty	Dia.	Length	IBS No.	Qty	Dia.	Length	IBS No.	Qty	Dia.	Length	IBS No.	Qty
1/16	1/4	13652	25	1/8	3/8	13690	25	7/32	3/4	13738	25	5/16	3/4	13767	15
	1/2	13655	25		3/4	13694	25		1	13740	25		1	13769	15
	3/4	13658	25		1	13696	25		1-1/4	13742	25		1-1/4	13771	15
	1	13660	25		1-1/4	13698	25		1-1/2	13744	25		1-1/2	13773	15
			1-1/2		13622	25	1-3/4		13746	25	1-3/4		13775	15	
			1-3/4		13612	25				2	13776	15			
5/64	1/4	13663	25	5/32	1/2	13705	25	1/4	3/4	13751	15	3/8	3/4	13783	15
	1/2	13666	25		3/4	13708	25		1-1/4	13755	15		1	13785	15
	3/4	13669	25		1	13710	25		1-1/2	13757	15		1-1/2	13789	15
	1	13671	25		1-1/4	13712	25		1-3/4	13759	15		1-3/4	13791	15
1-1/2	13675	25	1-1/2		13714	25	2		13760	15	2		13792	15	
			2	13717	25	2-1/4	13761		15	2-1/4	13793	15			
3/32	3/8	13679	25	3/16	5/8	13722	25			2-1/2	13762	15	1/2	1-1/2	13813
	1/2	13680	25		3/4	13723	25	3	13764	15	1-3/4	13815		10	
	5/8	13682	25		1	13725	25			2	13816	10			
	3/4	13683	25		1-1/4	13727	25			2-1/2	13818	10			
	1	13685	25		1-1/2	13729	25								
	1-1/4	13687	25		2	13732	25								
1-1/2	13688	25													

Roll Pin Assortment

IBS No. 165R • 24 Items - 845 Pieces

Packaged in a locking steel drawer for easy storage & organization

IBS, Inc. SPECIALTY PRODUCTS FOR MAINTENANCE & REPAIR INDUSTRIALBOLT.COM © © © 800-678-1906						Roll Pins
						Assortment No. 165R
13652 1/16 X 1/4 ROLL PIN ZP	13655 1/16 X 1/2 ROLL PIN ZP	13658 1/16 X 3/4 ROLL PIN ZP	13663 5/64 X 1/4 ROLL PIN ZP	13666 5/64 X 1/2 ROLL PIN ZP	13669 5/64 X 3/4 ROLL PIN ZP	
13679 3/32 X 3/8 ROLL PIN ZP	13683 3/32 X 3/4 ROLL PIN ZP	13685 3/32 X 1 ROLL PIN ZP	13690 1/8 X 3/8 ROLL PIN ZP	13696 1/8 X 1 ROLL PIN ZP	13698 1/8 X 1-1/4 ROLL PIN ZP	
13705 5/32 X 1/2 ROLL PIN ZP	13710 5/32 X 1 ROLL PIN ZP	13714 5/32 X 1-1/2 ROLL PIN ZP	13722 3/16 X 5/8 ROLL PIN ZP	13725 3/16 X 1 ROLL PIN ZP	13732 3/16 X 2 ROLL PIN ZP	
13738 7/32 X 3/4 ROLL PIN ZP	13744 7/32 X 1-1/2 ROLL PIN ZP	13746 7/32 X 1-3/4 ROLL PIN ZP	13753 1/4 X 1 ROLL PIN ZP	13760 1/4 X 2 ROLL PIN ZP	13764 1/4 X 3 ROLL PIN ZP	

RINGS & PINS



IBS, INCORPORATED

Woodruff Keys K05



Woodruff Keys

MACHINED FROM 1035 STEEL

IBS No.	Industry #	Size	Qty	IBS No.	Industry #	Size	Pkg Qty
13951	#2	3/32 x 1/2	25	13966	#13	3/16 x 1	15
13952	#3	1/8 x 1/2	25	13968	#15	1/4 x 1	15
13953	#4	3/32 x 5/8	25	13969	B	5/16 x 1	10
13954	#5	1/8 x 5/8	25	13970	#152	3/8 x 1	10
13955	#6	5/32 x 5/8	25	13971	#16	3/16 x 1-1/8	15
13956	#61	3/16 x 5/8	25	13973	#18	1/4 x 1-1/8	10
13957	#7	1/8 x 3/4	25	13974	C	5/16 x 1-1/8	10
13958	#8	5/32 x 3/4	25	13975	#19	3/16 x 1-1/4	10
13959	#9	3/16 x 3/4	25	13977	#21	1/4 x 1-1/4	10
13960	#91	1/4 x 3/4	25	13983	D	5/16 x 1-1/4	10
13961	#10	5/32 x 7/8	25	13984	E	3/8 x 1-1/4	10
13962	#11	3/16 x 7/8	15	13978	#22	1/4 x 1-3/8	10
13963	#12	7/32 x 7/8	15	13982	#126	3/16 x 2-1/2	15
13964	A	1/4 x 7/8	15	—	—	—	—

Woodruff Key Assortment

























IBS No. 148R • 24 Items - 185 Pieces

Packaged in a locking steel drawer for easy storage & organization



Woodruff Keys

Assortment No. 148R

<p>13951 #2 3/32 X 1/2 WOODRUFF KEY</p> 	<p>13957 #7 1/8 X 3/4 WOODRUFF KEY</p> 	<p>13956 #61 3/16 X 5/8 WOODRUFF KEY</p> 	<p>13971 #16 3/16 X 1-1/8 WOODRUFF KEY</p> 	<p>13968 #15 1/4 X 1 WOODRUFF KEY</p> 	<p>13974 #C 5/16 X 1-1/8 WOODRUFF KEY</p> 
<p>13953 #4 3/32 X 5/8 WOODRUFF KEY</p> 	<p>13955 #6 5/32 X 5/8 WOODRUFF KEY</p> 	<p>13959 #9 3/16 X 3/4 WOODRUFF KEY</p> 	<p>13975 #19 3/16 X 1-1/4 WOODRUFF KEY</p> 	<p>13973 #18 1/4 X 1-1/8 WOODRUFF KEY</p> 	<p>13983 #D 5/16 X 1-1/4 WOODRUFF KEY</p> 
<p>13952 #3 1/8 X 1/2 WOODRUFF KEY</p> 	<p>13958 #8 5/32 X 3/4 WOODRUFF KEY</p> 	<p>13962 #11 3/16 X 7/8 WOODRUFF KEY</p> 	<p>13960 #91 1/4 X 3/4 WOODRUFF KEY</p> 	<p>13977 #21 1/4 X 1-1/4 WOODRUFF KEY</p> 	<p>13970 #152 3/8 X 1 WOODRUFF KEY</p> 
<p>13954 #5 1/8 X 5/8 WOODRUFF KEY</p> 	<p>13961 #10 5/32 X 7/8 WOODRUFF KEY</p> 	<p>13966 #13 3/16 X 1 WOODRUFF KEY</p> 	<p>13964 #A 1/4 X 7/8 WOODRUFF KEY</p> 	<p>13969 #B 5/16 X 1 WOODRUFF KEY</p> 	<p>13978 #22 1/4 X 1-3/8 WOODRUFF KEY</p> 

RINGS & PINS

IBS, INCORPORATED

Clevis Pins K03



Clevis Pins

For temporary or permanent fastening of all kinds.



Dia.	Length	IBS No.	Qty	Dia.	Length	IBS No.	Qty	Dia.	Length	IBS No.	Qty	Dia.	Length	IBS No.	Qty
3/16 Hole Size .094	3/4	13831	10	5/16 Hole Size .141	1	13851	10	7/16 Hole Size .156	1	13876	5	5/8 Hole Size .156	1-1/2	13902	5
	1	13832	10		1-1/4	13854	10		1-1/4	13879	5		1-3/4	13903	5
	1-1/2	13837	10		1-1/2	13856	10		1-1/2	13881	5		2	13904	5
	1-3/4	13839	10		2	13859	10		1-3/4	13883	5				
1/4 Hole Size .094	3/4	13842	10	3/8 Hole Size .156	1	13862	10	1/2 Hole Size .156	2	13884	5				
	1	13843	10		1-1/4	13865	10		1	13887	5				
	1-1/8	13844	10		1-3/8	13866	10		1-1/4	13890	5				
	1-1/4	13846	10		1-1/2	13867	10		1-3/8	13891	5				
	1-1/2	13848	10		1-3/4	13869	10		1-1/2	13892	5				
				2	13870	5	1-3/4	13894	5	2	13895	5			
				2-1/2	13873	5	2	13895	5	2-1/2	13898	5			

Clevis Pins Assortment

132R • 24 Items • 129 Pieces

Packaged in a locking steel drawer for easy storage & organization

IBS, Inc. SPECIALTY PRODUCTS FOR MAINTENANCE & REPAIR INDUSTRIALBOLT.COM © © © 800-578-1958						Clevis Pins
Assortment No. 132R						
13831 3/16 X 3/4 CLEVIS PIN	13832 3/16 X 1 CLEVIS PIN	13837 3/16 X 1-1/2 CLEVIS PIN	13843 1/4 X 1 CLEVIS PIN	13848 1/4 X 1-1/2 CLEVIS PIN	13911 1/4 X 2 UNIVERSAL CLEVIS PIN	
13851 5/16 X 1 CLEVIS PIN	13856 5/16 X 1-1/2 CLEVIS PIN	13859 5/16 X 2 CLEVIS PIN	13867 3/8 X 1-1/2 CLEVIS PIN	13870 3/8 X 2 CLEVIS PIN	13915 5/16 X 2 UNIV CLEVIS PIN	
13873 3/8 X 2-1/2 CLEVIS PIN	13881 7/16 X 1-1/2 CLEVIS PIN	13884 7/16 X 2 CLEVIS PIN	13892 1/2 X 1-1/2 CLEVIS PIN	13895 1/2 X 2 CLEVIS PIN	13918 3/8 X 2 UNIVERSAL CLEVIS PIN	
13898 1/2 X 2-1/2 CLEVIS PIN	13902 5/8 X 1-1/2 CLEVIS PIN	13904 5/8 X 2 CLEVIS PIN	13922 7/16 X 2-1/2 UNIV CLEVIS PIN	13928 1/2 X 3 UNIV CLEVIS PIN	13932 5/8 X 3 UNIV CLEVIS PIN	

Universal Clevis Pins



Universal pins have a series of holes which make them adaptable to varying lengths.

Excess length may be trimmed off if desired.

Dia.	Length	IBS No.	Qty	Dia.	Length	IBS No.	Qty	Dia.	Length	IBS No.	Qty	Dia.	Length	IBS No.	Qty
1/4	2	13911	5	3/8	2	13918	5	1/2	2	13926	5	5/8	3	13932	5
5/16	2	13915	5	7/16	2	13921	5		2-1/2	13927	5				
				2-1/2	13922	5	3		13928	5					



IBS, INCORPORATED

Clevis Pins K03

Drop Forged Yoke Ends

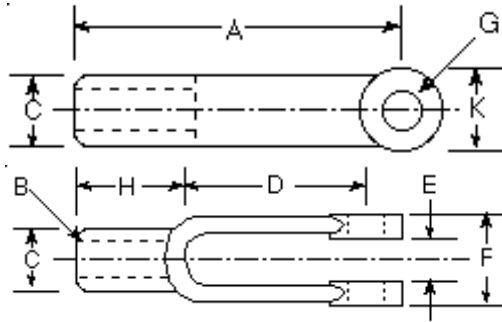

IBS No.	A	B	C	D	E	F	G	H	K	Pkg Qty
A-10737	2	1/4-28	7/16	1-1/4	9/32	5/8	1/4	3/4	1/2	1
A-10738	2-1/4	5/16-24	1/2	1-7/16	11/32	3/4	5/16	13/16	19/32	1
A-10739	2-1/2	3/8-24	5/8	1-5/8	7/16	7/8	3/8	7/8	11/16	1
A-10740	2-7/8	7/16-20	23/32	1-7/8	1/2	1	7/16	1	13/16	1
A-10741	3	1/2-20	13/16	1-7/8	9/16	1-1/8	1/2	1-1/8	15/16	1
A-10742	5	5/8-18	1-1/16	3-11/16	11/16	1-3/8	5/8	1-1/4	1-1/4	1



BRAKE TYPE YOKE
for Type 30

IBS No.	Size	Pin	Pkg Qty
53003	5/8-18	5/8	1

Female Rods Ends, Yoke Ends, Clevis & Cotter Pins & Jam Nuts (Z02)

142R • 18 Items • 247 Pieces

Packaged in a locking steel drawer for easy storage & organization

IBS, Inc. <small>SPECIALTY PRODUCTS FOR MAINTENANCE & REPAIR INDUSTRIALBOLT.COM © 2013 800-678-1906</small>		Female Rod Ends, Yoke Ends, Clevis Pins, Cotter Pins & Jam Nuts	
Assortment No. 142R			
A-12034 10-32 RH F. BALL JOINT W/STUD 	A-10737 1/4-28 DROP FORGED-ADJ YOKE END 	13843 1/4 X 1 CLEVIS PIN 	13480 3/32 X 3/4 COTTER PIN ZP 5036 10-32 HEX MACHINE SCREW NUT ZP
A-12035 1/4-28 RH F. BALL JOINT W/STUD 	A-10738 5/16-24 DROP FORG-ADJ YOKE END 	13854 5/16 X 1-1/4 CLEVIS PIN 	13505 1/8 X 1 COTTER PIN ZP 6085 1/4-28 HEX JAM NUT NF ZP
A-12036 5/16-24 RH F. BALL JOINT 	A-10739 3/8-24 DROP FORGED ADJ YOKE END 	13865 3/8 X 1-1/4 CLEVIS PIN 	13532 5/32 X 1 COTTER PIN ZP 6086 5/16-24 HEX JAM NUT NF ZP
A-12037 3/8-24 RH F. BALL JOINT W/STUD 	A-10741 1/2-20 DROP FORGED ADJ YOKE END 	13891 1/2 X 1-3/8 CLEVIS PIN 	13532 5/32 X 1 COTTER PIN ZP 6087 3/8-24 HEX JAM NUT NF ZP

RINGS & PINS



Rod End Ball Joints

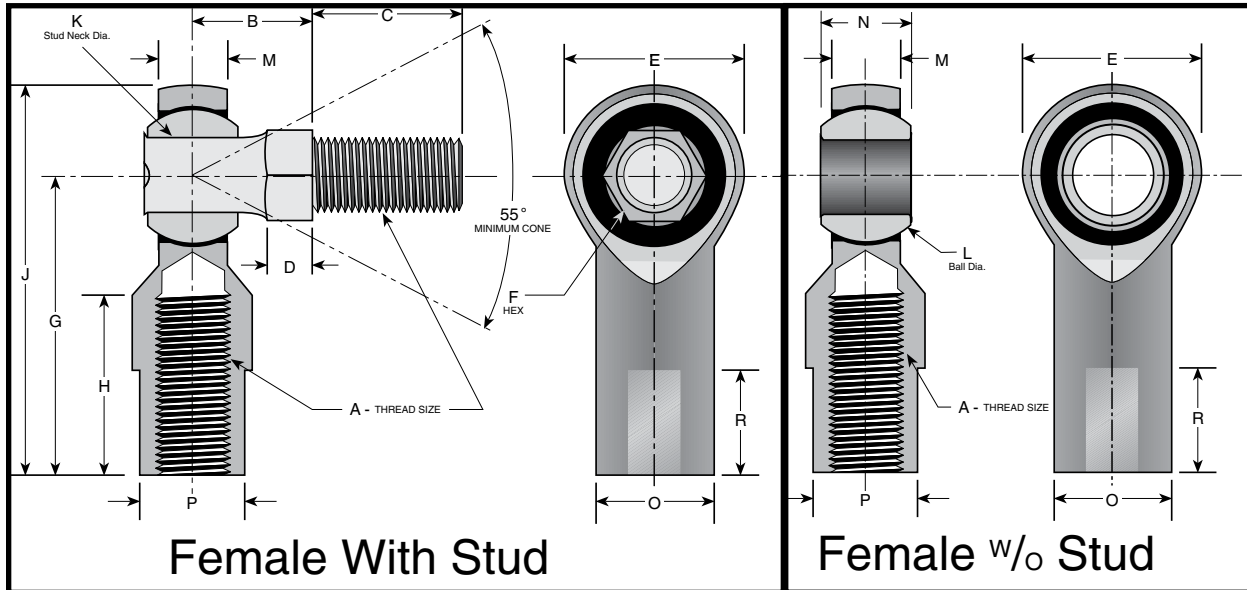

Bearing Raceway - Locked in by annular groove-trunnion design. Made of fiber reinforced nylon.

Threaded Stud - Made from medium carbon steel - same as high strength grade 5 capscrews. Cadmium plated .0002 min., plus clear dichromate. **SOLD IN QTYS OF 1**

Outer Member (Housing) - Low carbon steel, cadmium plated .0002 min., plus clear dichromate.

Spherical Ball - Precision made from selected low carbon steel-case hardened .007 minimum deep - file hard. Cadmium plated .0002 minimum.

FEMALE WITH STUDS

IBS No.	Thread	B	C	D	E	F	G	H	J	K	L	M	N	O	P	
A-12034	10-32	.437	.437	.156	.625	.312	1.062	.562	1.375	.189	.438	.250	.312	.406	.312	
A-12035	1/4-28	.469	.562	.156	.750	.375	1.312	.750	1.387	.250	.516	.281	.375	.469	.375	
A-12036	5/16-24	.531	.687	.187	.875	.437	1.375	.750	1.812	.312	.625	.344	.437	.500	.437	
A-12037	3/8-24	.625	.875	.218	1.00	.500	1.625	.937	2.125	.375	.719	.406	.500	.687	.562	
A-12286	3/8-24	LEFT HAND THREAD				ALL OTHER DIMENSIONS SAME AS ABOVE										
A-12491	7/16-20	.844	1.062	.312	1.125	.625	1.812	1.032	2.375	.437	.812	.437	.562	.750	.625	
A-12038	1/2-20	.875	1.125	.312	1.312	.625	2.125	1.187	2.781	.500	.938	.500	.625	.875	.750	
A-12288	5/8-18	1.00	1.125	.375	1.50	.750	2.50	1.50	3.25	.625	1.125	.562	.750	1.00	.875	

FEMALE WITHOUT STUDS

5/8	Thread	Bore	E	G	J	L	K	M	N	O	P	R	Thread	Qty
A-12277	1/4-28	.250	.750	1.312	.750	1.687	.516	.281	.375	.469	.375	.406	Left	1
A-12026	1/4-28	.250	.750	1.312	.750	1.687	.516	.281	.375	.469	.375	.406	Right	1
A-12027	5/16-24	.3125	.875	1.375	.750	1.812	.625	.344	.437	.500	.437	.500	Right	1
A-12028	3/8-24	.375	1.000	1.625	.937	2.125	.719	.406	.500	.687	.562	.562	Right	1
A-12279	3/8-24	.377	ALL OTHER DIMENSIONS SAME AS ABOVE										Left	1
A-12029	1/2-20	.500	1.312	2.125	1.187	2.781	.938	.500	.625	.875	.750	.687	Right	1

BALL JOINTS SOLD IN UNIT QUANTITIES OF ONE (1)



IBS, INCORPORATED

Clevis Pins K03

Ball Joint Assemblies

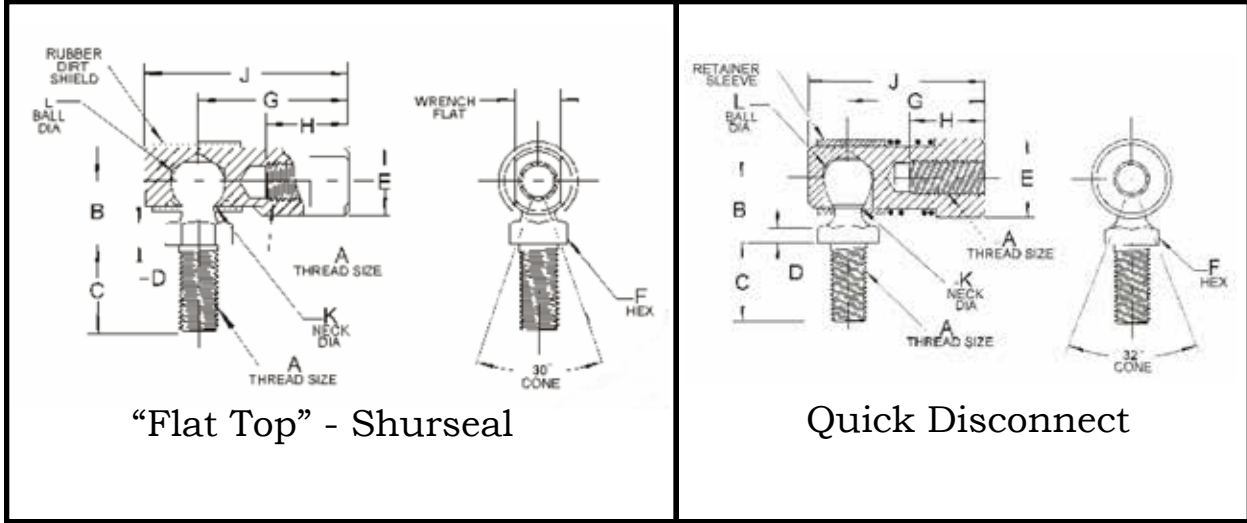

“Flat Top” - Shurseal

Quick Disconnect

“Flat Top” - Shurseal

This is a heavy duty ball joint with a high strength design and good wear resistance. It comes with an oil and ozone resistant rubber dirt shield to protect against abrasive dirt. It is designed for standard wrench sizes and the “Flat Top” alignment guide provides a mechanical and visual aid for aligning the ball stud in its vertical position for maximum movement in all directions. They are made of low carbon, free machining steel with ball studs case hardened to a depth of .005 to .008. Plated and clear dichromate treated for corrosion resistance.



FLAT TOP SHURSEAL BALL JOINT ASSEMBLIES

IBS No.	Thread	B	C	D	E	F	G	H	J	K	L	Wrench
A-12039	1/4-28	15/32	9/16	1/8	7/16	3/8	31/32	17/32	1-5/16	.208	.347	3/8
A-12040	5/16-24	17/32	11/16	5/32	1/2	7/16	1-1/8	19/32	1-9/16	.250	.405	7/16

Quick Disconnect

This is a high strength, quick disconnect assembly with good wear characteristics. To operate, the closed end steel retaining sleeve is pushed laterally along the body member. This compresses the spring and allows the simple removal or assembly of the male ball stud. This is an improved design which features a “key hole” cut out of the retaining sleeve which insures that the assembly can only be put together with the sleeve positively aligned with the ball cavity. The assembly is automatically aligned when the spring is released, eliminating the possibility of partial closure.



QUICK DISCONNECT BALL JOINT ASSEMBLIES

IBS No.	Thread	B	C	D	E	F	G	H	J	K	L
A-12044	1/4-28	15/32	9/16	1/8	9/16	3/8	31/32	17/32	1-1/4	.192	.347
A-12045	5/16-24	17/32	11/16	5/32	5/8	7/16	1-1/8	19/32	1-29/64	.224	.405

BALL JOINT ASSEMBLIES SOLD IN UNIT QUANTITIES OF ONE (1)



Hitch Pins K06

Hitch Pins

Hairpin Cotter



- Made of top quality spring wire.
- Ideal where quick assembly and disassembly is required.
- Reusable, strong, secure and convenient.

IBS No.	Industry Number	Wire Diameter	Drill Hole Size	Min. Shaft Diameter	Max Shaft Diameter	Overall Length	Inside Eye Diameter	Pkg Qty
15530	231	.028	1/32	1/8	5/32	.600	.093	25
15520	221	.047	1/16	1/8	3/16	19/32	1/8	25
15521	222	.062	5/64	1/4	1/2	1-5/16	5/16	25
15524	225	.072	5/64	5/16	3/8	1-3/32	9/64	25
15512	213	.080	3/32	1/4	3/8	1-3/16	1/4	25
15516	217	.080	3/32	3/8	1/2	1-9/16	5/16	25
15506	207	.093	7/64	1/4	5/8	2-5/16	5/8	25
15527	228	.093	7/64	3/8	1/2	2	5/8	25
15513	214	.093	7/64	3/8	3/4	2-1/2	7/16	25
15514	215	.125	9/64	1/2	3/4	1-9/16	7/16	25
15515	216	.125	9/64	1/2	3/4	1-15/16	7/16	25
15510	211	.125	9/64	7/16	3/4	2-9/16	9/16	25
15526	227	.125	9/64	5/8	3/4	2-1/2	1/2	25
15501	202	.125	9/64	3/4	3/4	3-1/8	1	25
15500	201	.148	5/32	1/2 x 5/8	7/8	3	1/2	25
15508	209	.148	5/32	3/4	1-1/8	3-5/16	7/8	25
15509	210	.148	5/32	5/8	1	2-15/16	3/4	25
15528	229	.177	3/16	3/4	1-1/16	3-1/2	1	25
15505	206	.177	3/16	5/8	1	3-1/4	7/8	25
15507	208	.177	3/16	7/8	1-1/4	3-3/4	7/8	25
15518	219	.243	17/64	3/4	1	4	15/16	15

RINGS & PINS

Hitch Pin Assortment

IBS No. 240R
16 Items
600 Pieces

Packaged in a locking steel drawer for easy storage & organization

Hitch Pin Clips
Assortment No. 240R

<small>15530</small> <small>1/32 X 9/16 HITCH PIN 31P</small> 	<small>15520</small> <small>3/64 X 19/32 HITCH PIN 21P</small> 	<small>15521</small> <small>1/16 X 1-5/16 HITCH PIN 22P</small> 	<small>15524</small> <small>5/64 X 1-3/32 HITCH PIN 25P</small>
<small>15512</small> <small>3/32 X 1-3/16 HITCH PIN 13P</small> 	<small>15516</small> <small>3/32 X 1-9/16 HITCH PIN 17P</small> 	<small>15506</small> <small>3/32 X 2-5/16 HITCH PIN 7P</small> 	<small>15513</small> <small>3/32 X 2-1/2 HITCH PIN 14P</small>
<small>15515</small> <small>1/8 X 1-15/16 HITCH PIN 16P</small> 	<small>15510</small> <small>1/8 X 2-9/16 HITCH PIN 11P</small> 	<small>15526</small> <small>1/8 X 2-1/2 HITCH PIN 27P</small> 	<small>15509</small> <small>5/32 X 2-15/16 HITCH PIN 10P</small>
<small>15505</small> <small>3/16 X 3-1/4 HITCH PIN 6P</small> 	<small>15507</small> <small>3/16 X 3-3/4 HITCH PIN 8P</small> 	<small>15528</small> <small>3/16 X 3-1/2 HITCH PIN 29P</small> 	<small>15518</small> <small>1/4 X 4 HITCH PIN 19P</small>



IBS, INCORPORATED

Hitch Pins K06

Hitch Pin Chart

RINGS & PINS

226	232	221	231	236	237	223	225	233	213	230	222
.032 X 7/16	.042 X 7/16	.047 X 19/32	.028 X .600	.054 X 3/4	.054 X 7/8	.042 X 1	.072 X 1-3/32	.093 X 1-1/8	.080 X 1-3/16	.105 X 1-1/4	.062 X 1-5/16

				*Plain Finish
201	204	202	206	234
.148 X 3	.162 X 3	.125 X 3-1/8	.177 X 3-1/4	.250 X 3-1/4

212	229	208	219	220
.162 X 3-7/16	.177 X 3-1/2	.177 X 3-3/4	.243 X 4	.310 X 4-1/16



Hitch Pin Chart

224	218	217	215	203	239	216	228
.047 X 1-9/16	.062 X 1-9/16	.080 X 1-9/16	.125 X 1-9/16	.093 X 1-5/8	.072 X 1-7/8	.125 X 1-15/16	.093 X 2

205	207	214	227	211	238	210
.162 X 2-3/16	.093 X 2-5/16	.093 X 2-1/2	.125 X 2-1/2	.125 X 2-9/16	.125 X 2-7/8	.148 X 2-15/16

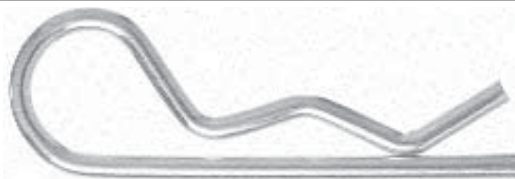

209

.148 X 3-5/16

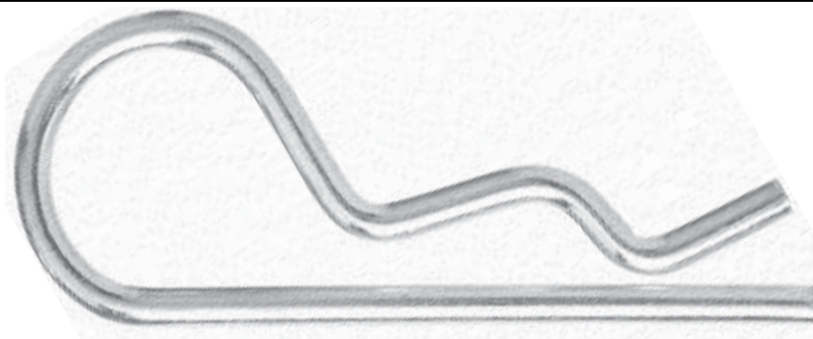

235

.243 X 5-1/8

R
I
N
G
S
&
P
I
N
S



IBS, INCORPORATED

Retaining Rings K08

Internal Retaining Rings

GROOVE REQUIRED IN BORE
Bright Zinc Chromate



IBS No.	Housing Dia.	Groove Dia.	Groove Thick	Pkg Qty
A-8688	1/4	.268	.018	50
A-8689	5/16	.330	.018	50
A-8690	3/8	.397	.029	50
A-8691	7/16	.461	.029	50
A-8692	1/2	.530	.039	50
A-8693	9/16	.596	.039	50
A-8694	5/8	.665	.039	50
A-8695	3/4	.796	.039	50
A-8696	7/8	.931	.046	50
A-8697	1	1.066	.046	50
A-8698	1-1/8	1.197	.056	50
A-8699	1-1/4	1.330	.056	50

External Retaining Rings

GROOVE REQUIRED ON SHAFT
Bright Zinc Chromate



IBS No.	Shaft Dia.	Groove Dia.	Groove Thick	Pkg Qty
A-8701	1/4	.230	.029	50
A-8702	5/16	.290	.029	50
A-8703	3/8	.352	.029	50
A-8704	7/16	.412	.029	50
A-8705	1/2	.468	.039	50
A-8706	9/16	.530	.039	50
A-8707	5/8	.588	.039	50
A-10120	11/16	.646	.046	50
A-8708	3/4	.704	.046	50
A-10121	13/16	.762	.046	50
A-8709	7/8	.821	.046	50
A-10122	15/16	.882	.046	50
A-8710	1	.940	.046	50
A-10123	1-1/16	.998	.056	50
A-8711	1-1/8	1.059	.056	50
A-10124	1-3/16	1.118	.056	50
A-8712	1-1/4	1.176	.056	50
A-10125	1-1/2	1.406	.056	25
A-10126	1-3/4	1.650	.068	25
A-10127	2	1.886	.068	10
A-10128	2-1/4	2.120	.068	10
A-10129	2-1/2	2.360	.068	10

Retaining Ring Assortment (Z02)

IBS No. 163R • 29 Items • 10 Pieces

Packaged in a locking steel drawer for easy storage & organization

Internal and External Retaining Rings

Assortment No. 163R

A-8701 1/4 EXTERNAL SNAP RING	A-8702 5/16 EXT SNAP RING	A-8703 3/8 EXT SNAP RING	A-8704 7/16 EXT SNAP RING	A-8705 1/2 EXT SNAP RING	A-8706 9/16 EXT SNAP RING	A-8707 5/8 EXT SNAP RING	A-10120 11/16 EXT. SNAP RING
A-8708 3/4 EXT SNAP RING	A-10121 13/16 EXT E-CLIP RETAINING RIN	A-8709 7/8 EXT SNAP RING	A-10122 15/16 EXT. SNAP RING	A-8710 1" EXTERNAL SNAP RING	A-10123 1-1/16 EXT. SNAP RING	A-8711 1-1/8 EXT SNAP RING	A-10124 1-3/16 EXT. SNAP RING
A-8712 1-1/4 EXT SNAP RING	A-8688 1/4 INT SNAP RING	A-8689 5/16 INTERNAL SNAP RING	A-8690 3/8 INT SNAP RING	A-8691 7/16 INT SNAP RING	A-8692 1/2 INTERNAL SNAP RING	A-8693 9/16 INT SNAP RING	A-8694 5/8 INT SNAP RING
A-8695 3/4 INT SNAP RING	A-8696 7/8 INT SNAP RING	A-8697 1 INT SNAP RING	A-8698 1-1/8 INTERNAL SNAP RING	A-8699 1-1/4 INT SNAP RING			

RINGS & PINS

IBS, INCORPORATED

Retaining Rings K08



RINGS & PINS

"E" Type Retaining Rings STANDARD



IBS No.	Shaft Dia.	Groove Dia.	Groove Width	Pkg Qty
A-8824	1/16	.052	.012	25
A-8825	3/32	.074	.018	25
A-8826	1/8	.095	.018	25
A-10130	9/64	.105	.018	25
A-10131	5/32	.116	.029	25
A-10132	11/64	.127	.029	25
A-8827	3/16	.147	.029	25
A-10133	7/32	.188	.029	25
A-8828	1/4	.210	.029	25
A-3824	5/16	.250	.029	25
A-8829	3/8	.303	.039	25
A-8830	7/16	.343	.039	25
A-5602	1/2	.396	.046	25
A-5603	5/8	.485	.046	25
A-8831	3/4	.625	.056	25
A-8832	7/8	.675	.056	25
A-8833	1	.835	.056	25

"E" Type Retaining Rings REINFORCED



IBS No.	Shaft Dia.	Groove Dia.	Groove Width	Pkg Qty
A-3165	1/8	.095	.018	25
A-10134	5/32	.116	.029	25
A-3166	3/16	.147	.029	25
A-10135	7/32	.188	.029	25
A-3167	1/4	.210	.029	25
A-3628	5/16	.250	.039	25
A-5600	3/8	.303	.039	25
A-2672	7/16	.343	.039	25
A-8837	1/2	.396	.046	25
A-5601	9/16	.437	.046	25

"E" Clips Assortment REGULAR & REINFORCED

IBS No. 161R • 27 Items • 1,345 Pieces

Packaged in a locking steel drawer for easy storage & organization

"E" Clips Regular & Reinforced

Assortment No. 161R

<small>A-8824</small> 1/16 E-CLIP RETAINING RING 	<small>A-8825</small> 3/32 E-CLIP RETAINING RING 	<small>A-8826</small> 1/8 E-CLIP RETAINING RING 	<small>A-10130</small> 9/64 E-CLIP RETAINING RING 	<small>A-10131</small> 5/32 E-CLIP RETAINING RING 	<small>A-10132</small> 11/64 E-CLIP RETAINING RING 	<small>A-8827</small> 3/16 E-CLIP RETAINING RING 	<small>A-10133</small> 7/32 E-CLIP RETAINING RING
<small>A-8828</small> 1/4 E-CLIP RETAINING RING 	<small>A-3824</small> 5/16 E-CLIP RETAINING RING 	<small>A-8829</small> 3/8 E-CLIP RETAINING RING 	<small>A-8830</small> 7/16 E-CLIP RETAINING RING 	<small>A-5602</small> 1/2 E-CLIP RETAINING RING 	<small>A-5603</small> 5/8 E-CLIP RETAINING RING 	<small>A-8831</small> 3/4 E-CLIP RETAINING RING 	<small>A-8832</small> 7/8 E-CLIP RETAINING RING
<small>A-8833</small> 1" E-CLIP RETAINING RING 						<small>A-3165</small> 1/8 HVY E-CLIP RETAINING RING 	<small>A-10134</small> 5/32 HVY E-CLIP RETAINING RING
<small>A-3166</small> 3/16 HVY E-CLIP RETAINING RING 	<small>A-10135</small> 7/32 HVY E-CLIP RETAINING RING 	<small>A-3167</small> 1/4 HVY E-CLIP RETAINING RING 	<small>A-3628</small> 5/16 HVY E-CLIP RETAINING RING 	<small>A-5600</small> 3/8 HVY E-CLIP RETAINING RING 	<small>A-2672</small> 7/16 HVY E-CLIP RETAINING RING 	<small>A-8837</small> 1/2 HVY E-CLIP RETAINING RING 	<small>A-5601</small> 9/16 HVY E-CLIP RETAINING RING



IBS, INCORPORATED

O-Rings K09

O-Rings

BUNA-N70 (NITRILE) BASE ELASTOMER



- Excellent Resistance to petroleum products.
- Temperature Range -65°F to +275°F.
- Superior to most elastomers with regard to compression set or cold flow, tear and abrasion resistance.

1/16 THICK

IBS No.	I.D.	O.D.	Ind No.	Qty	IBS No.	I.D.	O.D.	Ind No.	Qty	IBS No.	I.D.	O.D.	Ind No.	Qty
15545	1/8	1/4	006	25	15551	3/8	1/2	012	25	15556A	3/4	7/8	018	25
15546	5/32	9/32	007	25	15552	7/16	9/16	013	25	15556A1	13/16	15/16	019	25
15547	3/16	5/16	008	25	15553	1/2	5/8	014	25	15556B	15/16	1-1/16	021	25
15548	7/32	11/32	009	25	15554	9/16	11/16	015	25	15556C	1-1/16	1-3/16	023	25
15549	1/4	3/8	010	25	15555	5/8	3/4	016	25	15556D	1-3/16	1-5/16	025	25
15550	5/16	7/16	011	25	15556	11/16	13/16	017	25	15556E	1-1/4	1-3/8	026	25

3/32 THICK

IBS No.	I.D.	O.D.	Ind No.	Qty	IBS No.	I.D.	O.D.	Ind No.	Qty	IBS No.	I.D.	O.D.	Ind No.	Qty
15557	3/8	9/16	110	25	15560	9/16	3/4	113	25	15563	3/4	15/16	116	25
15558	7/16	5/8	111	25	15561	5/8	13/16	114	25	—	—	—	—	—
15559	1/2	11/16	112	25	15562	11/16	7/8	115	25	—	—	—	—	—

1/8 THICK

IBS No.	I.D.	O.D.	Ind No.	Qty	IBS No.	I.D.	O.D.	Ind No.	Qty	IBS No.	I.D.	O.D.	Ind No.	Qty
15564	3/4	1	210	25	15573	1-5/16	1-9/16	219	25	15582	2-1/4	2-1/2	228	15
15565	3/16	1-1/16	211	25	15574	1-3/8	1-5/8	220	25	15583	2-3/8	2-5/8	229	15
15566	7/8	1-1/8	212	25	15575	1-7/16	1-11/16	221	25	15584	2-1/2	2-3/4	230	15
15567	15/16	1-3/16	213	25	15576	1-1/2	1-3/4	222	25	15585	2-5/8	2-7/8	231	15
15568	1	1-1/4	214	25	15577	1-5/8	1-7/8	223	25	15586	2-3/4	3	232	15
15569	1-1/16	1-5/16	215	25	15578	1-3/4	2	224	25	15587	2-7/8	3-1/8	233	15
15570	1-1/8	1-3/8	216	25	15579	1-7/8	2-1/8	225	25	15588	3	3-1/4	234	15
15571	1-3/16	1-7/16	217	25	15580	2	2-1/4	226	15	15589A	4-1/4	4-1/2	244	10
15572	1-1/4	1-1/2	218	25	15581	2-1/8	2-3/8	227	15	15604	5-1/8	5-3/8	251	10

3/16 THICK

IBS No.	I.D.	O.D.	Ind No.	Qty	IBS No.	I.D.	O.D.	Ind No.	Qty	IBS No.	I.D.	O.D.	Ind No.	Qty
15605	1-1/2	1-7/8	325	10	15609	2	2-3/8	329	10	15613	2-1/2	2-7/8	333	10
15606	1-5/8	2	326	10	15610	2-1/8	2-1/2	330	10	15614	2-5/8	3	334	10
15607	1-3/4	2-1/8	327	10	15611	2-1/4	2-5/8	331	10	—	—	—	—	—
15608	1-7/8	2-1/4	328	10	15612	2-3/8	2-5/8	332	10	—	—	—	—	—

Standard O-Rings (Z02)

IBS No. 164R • 30 Items • 805 Pieces

Packaged in a locking steel drawer for easy storage & organization

IBS, Inc. SPECIALTY PRODUCTS FOR MAINTENANCE & REPAIR INDUSTRIALBOLTY.COM © © © 800-870-1000										Standard O-Rings					
Assortment No. 164R															
15545 #006 1/16 WL 1/8 ID O-RING	15549 #010 1/16 WL 1/4 ID O-RING	15558 #111 3/32 WL 7/16 ID O-RING	15562 #115 3/32 WL 11/16 ID O-RING	15566 #212 1/8 WL 7/8 ID O-RING	15570 #218 1/8 WL 1-1/8 ID O-RING	15574 #220 1/8 WL 1-3/8 ID O-RING	15606 #326 3/16 WL 1-5/8 ID O-RING	15546 #007 1/16 WL 5/32 ID O-RING	15550 #011 1/16WL 5/16ID X 7/16OD	15559 #112 3/32 WL 1/2 ID O-RING	15563 #116 3/32 WL 3/4 ID O-RING	15567 #213 1/8 WL 15/16 ID O-RING	15571 #217 1/8 WL 1-3/16 ID O-RING	15575 #221 1/8 WL 1-7/16 ID O-RING	15607 #327 3/16 WL 1-3/4 ID O-RING
15547 #008 1/16 WL 3/16 ID O-RING	15551 #012 1/16 WL 3/8 ID O-RING	15560 #113 3/32 WL 9/16 ID O-RING	15564 #210 1/8 WL 3/4 ID O-RING	15568 #214 1/8 WL 1 ID O-RING	15572 #218 1/8 WL 1-1/4 ID O-RING	15576 #222 1/8 WL 1-1/2 ID O-RING	15548 #009 1/16 WL 7/32 ID O-RING	15557 #110 3/32 WL 3/8 ID O-RING	15561 #114 3/32 WL 5/8 ID O-RING	15565 #211 1/8 WL 13/16 ID O-RING	15569 #215 1/8 WL 1-1/16 ID O-RING	15573 #219 1/8 WL 1-5/16 ID O-RING	15605 #325 3/16 WL 1-1/2 ID O-RING		

IBS, INCORPORATED

O-Rings K09



Standard O-Rings

IBS No. 15615 • 37 Items • 513 Pcs



- Two compartment plastic carrying case with molded handle.
- Removable locking pegs for storing O-rings and to prevent them from falling off if the case gets tipped.
- Built in gauges for sizing O-rings.
- Includes Sizes #006 through #012, #110 through #116, #210 through #222, #325 through #334.

STANDARD O-RING KIT

IBS No.	Description	Qty
15615	Standard O-Ring Kit	1

“O” Ring Cord

Buna-N Cord Material
70 Durometer • Sold in 4’ lengths



O-RING CORD

IBS No.	Description	Qty
15540	1/16" (.070) x 4'	1
15541	3/32" (.103) x 4'	1
15542	1/8" (.139) x 4'	1
15543	3/16" (.210) x 4'	1
15544	1/4" (.275") x 4'	1

Standard O-Ring Splice Kit

IBS No. 15535 • 8 Items • 10 Pcs

Each kit contains O-Ring cord, splicing jig, razor, glue and detailed instructions for making O-Rings to your specifications.

Material: Buna N70

Kit includes: one 7 foot length of each of the following AS568 cross-sections: .070", .103", .139", .210", and .275".



STANDARD O-RING SPLICE KIT

IBS No.	Description	Qty
15535	O-Ring Splice Kit	1

RINGS & PINS



IBS, INCORPORATED

O-Rings K09

Metric O-Rings

BUNA-N70 (NITRILE) BASE ELASTOMER



- Excellent Resistance to petroleum products.
- Temperature Range -65°F to +275°F.
- Superior to most elastomers with regard to compression set or cold flow, tear and abrasion resistance.

1.5MM THICK

IBS No.	I.D.	O.D.	Qty	IBS No.	I.D.	O.D.	Qty	IBS No.	I.D.	O.D.	Qty
15700	3.0	6.0	10	15702	7.0	10.0	10	15704	11.0	14.0	10
15701	5.0	8.30	10	15703	9.0	12.0	10	—	—	—	—

2.0MM THICK

IBS No.	I.D.	O.D.	Qty	IBS No.	I.D.	O.D.	Qty	IBS No.	I.D.	O.D.	Qty
15705	6.0	10.0	10	15708	12.0	16.0	10	15711	20.0	24.0	10
15706	8.0	12.0	10	15709	14.0	18.0	10	—	—	—	—
15707	10.0	14.0	10	15710	18.0	22.0	10	—	—	—	—

2.4MM THICK

IBS No.	I.D.	O.D.	Qty	IBS No.	I.D.	O.D.	Qty	IBS No.	I.D.	O.D.	Qty
15712	6.3	11.1	10	15714	11.8	16.4	10	15716	17.3	22.1	10
15713	8.3	13.1	10	15715	13.3	18.1	10	—	—	—	—

2.5MM THICK

IBS No.	I.D.	O.D.	Qty	IBS No.	I.D.	O.D.	Qty	IBS No.	I.D.	O.D.	Qty
15717	5.0	10.0	10	15719	10.0	15.0	10	15721	15.0	20.0	10
15718	7.0	12.0	10	15720	12.0	17.0	10	—	—	—	10

3.0MM THICK

IBS No.	I.D.	O.D.	Qty	IBS No.	I.D.	O.D.	Qty	IBS No.	I.D.	O.D.	Qty
15722	10.0	16.0	10	15727	20.2	26.2	10	15732	26.2	32.2	10
15723	12.0	18.0	10	15728	22.0	28.0	10	15733	28.0	34.0	10
15724	14.0	20.0	10	15729	22.2	28.2	10	15734	30.2	36.2	10
15725	16.0	22.0	10	15730	24.2	30.2	10	15735	32.0	38.0	10
15726	18.0	24.0	10	15731	25.0	31.0	10	15736	38.0	44.0	10

4.0MM THICK

IBS No.	I.D.	O.D.	Qty	IBS No.	I.D.	O.D.	Qty	IBS No.	I.D.	O.D.	Qty
15737	25.0	33.0	10	15741	36.0	44.0	10	15745	45.0	53.0	10
15738	30.0	38.0	10	15742	38.0	46.0	10	15746	50.0	58.0	10
15739	32.0	40.0	10	15743	40.0	48.0	10	—	—	—	—
15740	35.0	43.0	10	15744	44.0	52.0	10	—	—	—	—

5.0MM THICK

IBS No.	I.D.	O.D.	Qty	IBS No.	I.D.	O.D.	Qty	IBS No.	I.D.	O.D.	Qty
15747	25.0	35.0	10	15749	35.0	45.0	10	15751	45.0	55.0	10
15748	30.0	40.0	10	15750	40.0	50.0	10	15752	50.0	60.0	10

R
I
N
G
S
&
P
I
N
S

IBS, INCORPORATED

Assortments Z02



Metric O-Rings

1.5MM TO 3.0 MM

184R • 30 ITEMS • 220 Pcs.

Packaged in a locking steel drawer for easy storage & organization



IBS, Inc. SPECIALTY PRODUCTS & SERVICES INDUSTRIAL MARK CORP. P.O. BOX 470-1006							Metric O-Rings 1.5mm to 3.0mm
							Assortment No. 184R
15700 3.0 X 1.5 METRIC O RING	15701 5.0 X 1.5 METRIC O RING	15702 7.0 X 1.5 METRIC O RING	15703 9.0 X 1.5 METRIC O RING	15704 11.0 X 1.5 METRIC O RING	15705 6.0 X 2.0 METRIC O RING	15706 8.0 X 2.0 METRIC O RING	15707 10.0 X 2.0 METRIC O RING
15708 12.0 X 2.0 METRIC O RING	15709 14.0 X 2.0 METRIC O RING	15712 6.3 X 2.4 METRIC O RING	15713 8.3 X 2.4 METRIC O RING	15714 11.8 X 2.4 METRIC O RING	15715 13.3 X 2.4 METRIC O RING	15716 17.3 X 2.4 METRIC O RING	15717 5.0 X 2.5 METRIC O RING
15718 7.0 X 2.5 METRIC O RING	15719 10.0 X 2.5 METRIC O RING	15720 12.0 X 2.5 METRIC O RING	15721 15.0 X 2.5 METRIC O RING	15722 10.0 X 3.0 METRIC O RING	15723 12.0 X 3.0 METRIC O RING	15724 14.0 X 3.0 METRIC O RING	15725 16.0 X 3.0 METRIC O RING
15726 18.0 X 3.0 METRIC O RING	15727 20.2 X 3.0 METRIC O RING	15729 22.2 X 3.0 METRIC O RING	15730 24.2 X 3.0 METRIC O RING	15732 26.2 X 3.0 METRIC O RING	15734 30.2 X 3.0 METRIC O RING		

Metric O-Rings

2.0MM TO 5.0 MM

185R • 24 ITEMS • 76 Pcs.

Packaged in a locking steel drawer for easy storage & organization



IBS, Inc. SPECIALTY PRODUCTS & SERVICES INDUSTRIAL MARK CORP. P.O. BOX 470-1006							Metric O-Rings 2.0mm to 5.0mm Large Diameter
							Assortment No. 185R
15710 16.0 X 2.0 METRIC O RING	15711 20.0 X 2.0 METRIC O RING	15728 22.0 X 3.0 METRIC O RING	15731 25.0 X 3.0 METRIC O RING	15733 28.0 X 3.0 METRIC O RING	15734 30.2 X 3.0 METRIC O RING	15734 30.2 X 3.0 METRIC O RING	
15735 32.2 X 3.0 METRIC O RING	15736 38.0 X 3.0 METRIC O RING	15737 25.0 X 4.0 METRIC O RING	15738 30.0 X 4.0 METRIC O RING	15739 32.0 X 4.0 METRIC O RING	15740 35.0 X 4.0 METRIC O RING	15740 35.0 X 4.0 METRIC O RING	
15741 36.0 X 4.0 METRIC O RING	15742 38.0 X 4.0 METRIC O RING	15743 40.0 X 4.0 METRIC O RING	15744 44.0 X 4.0 METRIC O RING	15745 45.0 X 4.0 METRIC O RING	15746 50.0 X 4.0 METRIC O RING	15746 50.0 X 4.0 METRIC O RING	
15747 25.0 X 5.0 METRIC O RING	15748 30.0 X 5.0 METRIC O RING	15749 35.0 X 5.0 METRIC O RING	15750 40.0 X 5.0 METRIC O RING	15751 45.0 X 5.0 METRIC O RING	15752 50.0 X 5.0 METRIC O RING	15752 50.0 X 5.0 METRIC O RING	

Metric O-Rings (K09)

IBS No. 15753 • 30 Items • 385 Pcs



- Two compartment plastic carrying case with molded handle.
- Removable locking pegs for storing O-rings and to prevent them from falling off if the case gets tipped.
- Built in gauges for sizing O-rings.
- Sizes and quantities include: **16 each** (2mm cross section) in ID's of 3,4,5,6,7,8,10, **13 each** (2.5mm cross-section) in ID's of 10, 11, 12, 14, 16, 17, 19, **12 each** (3mm cross-section) in ID's of 20, 22, 24, 25, 26, 27, 28, 30, 32, 33, 35, 36, 38 **11 each** (3mm cross-section) in ID's of 19 **9 each** (4mm cross-section) in ID's of 38, 41, 44

IBS No.	Description	Qty
15753	Metric O-Ring Kit	1

Metric O-Ring Splice Kit (K09)

IBS No. 15536 • 11 Items • 11 Pcs

Each kit contains O-Ring cord, splicing jig, razor, glue and detailed instructions for making O-Rings to your specifications. Material: Buna N70
Kit includes: one 7 foot length of each of the following metric cross-sections: 1.5mm, 2mm, 2.5mm, 3.0mm, 3.5mm, 4mm, 5mm, 5.7mm, and 8.4mm.



IBS No.	Description	Qty
15536	Metric O-Ring Splice Kit	1

RINGS & PINS



IBS, INCORPORATED

O-Rings K09

Viton O-Rings

VITON COMPOUND BASE ELASTOMER



- Excellent Resistance to higher temperatures, petroleum oils, gasoline.
- Temperature Range -15°F to +400°F.
- Wide Range of chemical resistance.
- Very good ozone, weather and aging resistance.

1/16 THICK

IBS No.	I.D.	O.D.	Ind No.	Qty	IBS No.	I.D.	O.D.	Ind. No.	Qty	IBS No.	I.D.	O.D.	Ind. No.	Qty
30006	1/8	1/4	006	25	30012	3/8	1/2	012	25	30018	3/4	7/8	018	25
30007	5/32	9/32	007	25	30013	7/16	9/16	013	25	30019	13/16	15/16	019	25
30008	3/16	5/16	008	25	30014	1/2	5/8	014	25	30021	15/16	1-1/16	021	25
30009	7/32	11/32	009	25	30015	9/16	11/16	015	25	30023	1-1/16	1-3/16	023	25
30010	1/4	3/8	010	25	30016	5/8	3/4	016	25	30025	1-3/16	1-5/16	025	25
30011	5/16	7/16	011	25	30017	11/16	13/16	017	25	30026	1-1/4	1-3/8	026	25

3/32 THICK

IBS No.	I.D.	O.D.	Ind No.	Qty	IBS No.	I.D.	O.D.	Ind. No.	Qty	IBS No.	I.D.	O.D.	Ind. No.	Qty
30110	3/8	9/16	110	25	30113	9/16	3/4	113	25	30116	3/4	15/16	116	25
30111	7/16	5/8	111	25	30114	5/8	13/16	114	25	—	—	—	—	—
30112	1/2	11/16	112	25	30115	11/16	7/8	115	25	—	—	—	—	—

1/8 THICK

IBS No.	I.D.	O.D.	Ind No.	Qty	IBS No.	I.D.	O.D.	Ind. No.	Qty	IBS No.	I.D.	O.D.	Ind. No.	Qty
30210	3/4	1	210	25	30219	1-5/16	1-9/16	219	25	30228	2-1/4	2-1/2	228	15
30211	3/16	1-1/16	211	25	30220	1-3/8	1-5/8	220	25	30229	2-3/8	2-5/8	229	15
30212	7/8	1-1/8	212	25	30221	1-7/16	1-11/16	221	25	30230	2-1/2	2-3/4	230	15
30213	15/16	1-3/16	213	25	30222	1-1/2	1-3/4	222	25	30231	2-5/8	2-7/8	231	15
30214	1	1-1/4	214	25	30223	1-5/8	1-7/8	223	25	30232	2-3/4	3	232	15
30215	1-1/16	1-5/16	215	25	30224	1-3/4	2	224	25	30233	2-7/8	3-1/8	233	15
30216	1-1/8	1-3/8	216	25	30225	1-7/8	2-1/8	225	25	30234	3	3-1/4	234	15
30217	1-3/16	1-7/16	217	25	30226	2	2-1/4	226	15	—	—	—	—	—
30218	1-1/4	1-1/2	218	25	30227	2-1/8	2-3/8	227	15	—	—	—	—	—

3/16 THICK

IBS No.	I.D.	O.D.	Ind No.	Qty	IBS No.	I.D.	O.D.	Ind. No.	Qty	IBS No.	I.D.	O.D.	Ind. No.	Qty
30325	1-1/2	1-7/8	325	10	30329	2	2-3/8	329	10	30333	2-1/2	2-7/8	333	10
30326	1-5/8	2	326	10	30330	2-1/8	2-1/2	330	10	30334	2-5/8	3	334	10
30327	1-3/4	2-1/8	327	10	30331	2-1/4	2-5/8	331	10	—	—	—	—	—
30328	1-7/8	2-1/4	328	10	30332	2-3/8	2-5/8	332	10	—	—	—	—	—

R
I
N
G
S
&
P
I
N
S

IBS, INCORPORATED

O-Rings K09



Viton O-Rings Assortment

IBS No. 735R • 30 Items - 360 Pieces

Packaged in a locking steel drawer for easy storage & organization

IBS, Inc. SPECIALTY PRODUCTS FOR MAINTENANCE & REPAIR INDUSTRIALBOLT.COM • 800-878-1906		Viton O-Rings					
							Assortment No. 735R
30006 #006 1/16 WL 1/8 ID VITON O-RING	30010 #010 1/16 WL 1/4 ID VITON O-RING	30111 #111 3/32 WL 7/16 ID VITON O-RING	30115 #115 3/32 WL 11/16 ID VITON O-RING	30212 #212 1/8 WL 7/8 ID VITON O-RING	30216 #216 1/8 WL 1-1/8 ID VITON O-RING	30220 #220 1/8 WL 1-3/8 ID VITON O-RING	30326 #326 3/16 WL 1-5/8 ID VITON O-RING
30007 #007 1/16 WL 5/32 ID VITON O-RING	30011 #011 1/16 WL 5/16 ID VITON O-RING	30112 #112 3/32 WL 1/2 ID VITON O-RING	30116 #116 3/32 WL 3/4 ID VITON O-RING	30213 #213 1/8 WL 15/16 ID VITON O-RING	30217 #217 1/8 WL 1-3/16 ID VITON O-RING	30221 #221 1/8 WL 1-7/16 ID VITON O-RING	30327 #327 3/16 WL 1-3/4 ID VITON O-RING
30008 #008 1/16 WL 3/16 ID VITON O-RING	30012 #012 1/16 WL 3/8 ID VITON O-RING	30113 #113 3/32 WL 9/16 ID VITON O-RING	30210 #210 1/8 WL 3/4 ID VITON O-RING	30214 #214 1/8 WL 1" ID VITON O-RING	30218 #218 1/8 WL 1-1/4 ID VITON O-RING	30222 #222 1/8 WL 1-1/2 ID VITON O-RING	
30009 #009 1/16 WL 7/32 ID VITON O-RING	30110 #110 3/32 WL 3/8 ID VITON O-RING	30114 #114 3/32 WL 5/8 ID VITON O-RING	30211 #211 1/8 WL 13/16 ID VITON O-RING	30215 #215 1/8 WL 1-1/16 ID VITON O-RING	30219 #219 1/8 WL 1-5/16 ID VITON O-RING	30325 #325 3/16 WL 1-1/2 ID VITON O-RING	

Viton O-Rings

IBS No. 30615 • 30 Items • 180 Pcs



- Two compartment plastic carrying case with molded handle.
- Removable locking pegs for storing O-rings and to prevent them from falling off if the case gets tipped.
- Built in gauges for sizing O-rings.
- Sizes and quantities include:
 - 10 each** in ID's of 006, 007, 008, 009, 010, 011, 012, 110, 111, 112, 113, 114
 - 5 each** in ID's of 115, 116, 210, 212, 213, & 214.
 - 2 each** in ID's of 216, 217, 218, 219, 220, 221, 222, 325, 326, 327.

VITON O-RING KIT

IBS No.	Description	Qty
30615	Viton O-Ring Kit	1

Viton O-Ring Splice Kit

IBS No. 15537 • 12 Items • 12 Pcs

Each kit contains O-Ring cord, splicing jig, razor, glue and detailed instructions for making O-Rings to your specifications.

Material: Viton (Fluorocarbon)

Kit includes: one 7 foot length of each of the following: 1/16" (.070), 3/32" (.103), 1/8" (.139), 3/16" (.210), 1/4" (.275).



METRIC O-RING SPLICE KIT

IBS No.	Description	Qty
15537	Viton O-Ring Splice Kit	1

RINGS & PINS



IBS, INCORPORATED

O-Rings K09

Nitrile Air Conditioning O-Rings

FOR USE WITH R12 & R13 REFRIGERANT



IBS No.	I.D.	O.D	Thickness	OEM No.	Qty
A-17604	.290"	.432	.071"	Ford: 391396	25
A-18646	.375"	.500	.063"	—	25
A-17605	.400"	.546	.073"	Ford: 391397	25
A-17606	.509"	.655	.073"	Ford: 391304	25
A-17607	.617"	.769	.076"	Ford: 391305	15
A-18647	.688"	.813	.063"	—	25
A-18134	4.5mm	7.3mm	1.4mm	Nissan: 92472-N8200	25
A-18135	6mm	9.6mm	1.8mm	Nissan: 92470-N8200	25
A-18136	6.5mm	9.5mm	1.5mm	Toyota: 90099-14044	25
A-18137	6.6mm	10.2mm	1.8mm	Acura: 80873-ST7-000	25
A-18138	7.7mm	11.3mm	1.8mm	Nissan: 92474-N8200	25
A-18140	10.7mm	15.5mm	2.4mm	Acura: 80872-ST7-000 Nissan: 92475-W1000	25
A-18139	10.8mm	14.4mm	1.8mm	Nissan: 92471-N8200	25
A-18141	13.3mm	18.1mm	2.4mm	Acura: 80871-ST7-000	25
A-18143	13.4mm	17.2mm	1.9mm	Toyota: 90099-14045	15
A-18142	14mm	17.6mm	1.8mm	Nissan: 92473-N8200	25
A-18144	14.8mm	19.6mm	2.4mm	Nissan: 92475-W2100	15
A-19235	13/16"	1-1/16"	1/8"	—	10

Nitrile Air Conditioning O-Ring Assortment

IBS No. 804R • 18 Items - 180 Pieces



















Packaged in a locking steel drawer for easy storage & organization



IBS, Inc.
SPECIALTY PRODUCTS FOR MAINTENANCE & REPAIR
INDUSTRIALDOLT.COM 800-678-1906

A/C O-Rings
Nitrile for use with R134A & R12 Refrigerant

Assortment No. 804R

<p>A-18134 4.5MM X 7.3MM X 1.4MM NITRILE A/C O-RING</p> 	<p>A-18135 6MM X 9.6MM X 1.8MM NITRILE A/C O-RING</p> 	<p>A-18136 6.5MM X 9.5MM 1.5MM NITRILE A/C O-RING</p> 	<p>A-18137 6.6MM X 10.2MM X 1.8MM NITRILE A/C O-RING</p> 	<p>A-17604 .290 X .432 X .071 NITRILE A/C O-RING</p> 
<p>A-18138 7.7MM X 11.3MM X 1.8MM NITRILE A/C O-RING</p> 	<p>A-18646 .375 X .500 X .063 NITRILE A/C O-RING</p> 	<p>A-17605 .400 X .546 X .073 NITRILE A/C O-RING</p> 	<p>A-18140 10.7MM X 15.5MM X 2.4MM NITRILE A/C O-RING</p> 	<p>A-18139 10.8MM X 14.4MM X 1.8MM NITRILE A/C O-RING</p> 
<p>A-17606 .509 X .655 X .073 NITRILE A/C O-RING</p> 	<p>A-18141 13.3MM X 18.1MM X 2.4MM NITRILE A/C O-RING</p> 	<p>A-18143 13.4MM X 17.2MM X 1.9MM NITRILE A/C O-RING</p> 	<p>A-18142 14MM X 17.6MM X 1.8MM NITRILE A/C O-RING</p> 	<p>A-18144 14.8MM X 19.6MM X 2.4MM NITRILE A/C O-RING</p> 
<p>A-17607 .617 X .769 X .076 NITRILE A/C O-RING</p> 	<p>A-18647 .688 X .813 X .063 NITRILE A/C O-RING</p> 	<p>A-19235 13/16 X 1-1/16 X 1/8 NITRILE A/C O-RING</p> 		

RINGS & PINS

IBS, INCORPORATED

Square Key Stock K10 & Dowel Pins K12



Square Key Stock 12" LONG

- Oversized .000 to +.002.
- Zinc plated.



IBS No.	Width	Length	Pkg Qty
15620	3/32	12	1
15621	1/8	12	1
15622	5/32	12	1
15623	3/16	12	1
15624	7/32	12	1
15625	1/4	12	1
15626	9/32	12	1
15627	5/16	12	1
15628	3/8	12	1
15629	7/16	12	1
15630	1/2	12	1
15631	9/16	12	1
15632	5/8	12	1
15634	3/4	12	1
15636	7/8	12	1
15637	1	12	1

Key Stock Assortment (Z02)

IBS No. 118R • 11 Items - 21 Pieces
Arranged in a 12 Compartment
Mountable Rack

- 3 Each of 1/8", 3/16", 1/4"
- 2 Each of 5/16", 3/8", 7/16", 1/2"
- 1 Each of 5/8", 3/4", 7/8", 1"



Dowel Pins

PRECISION GROUND • ALLOY STEEL



IBS No.	Diameter	Length	Pkg Qty
15640	1/8	3/4	25
15642	1/8	1	25
15652	3/16	3/4	25
15654	3/16	1	25
15656	3/16	1-1/2	25
15658	3/16	2	25
15662	1/4	1/2	25
15664	1/4	3/4	25
15666	1/4	1	25
15668	1/4	1-1/2	25
15670	1/4	2	25
15678	5/16	1	25
15686	3/8	3/4	15
15688	3/8	1	15
15690	3/8	1-1/2	15
15692	3/8	2	15
15698	1/2	2-1/2	10
15699	1/2	3	10

RINGS & PINS



IBS, INCORPORATED

Miscellaneous Pins K11

Snapper Pins

QUICK CONNECT AND DISCONNECT



- Retainer Wire made from Tempered M-B Spring Wire.
- Shank made from 1010 Carbon Steel.
- Entire unit is zinc plated.

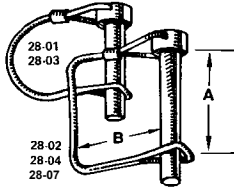

IBS No.	Pin Diam.	Usable Length (A)	Clearance B	Pkg Qty
28-01	1/4	1-3/4	1-1/2	5
28-07	1/4	2-1/2	1-1/2	5
28-02	5/16	2-1/2	1-5/8	5
28-03	3/8	1-3/8	1-1/2	5
28-04	3/8	2-1/4	1-1/2	5

Lynch Pins

FORGED TO PROVIDE MAXIMUM STRENGTH

- Zinc Plated and Dichromate Dipped for corrosion resistance.
- Self-locking ring designed for security and easy removal.

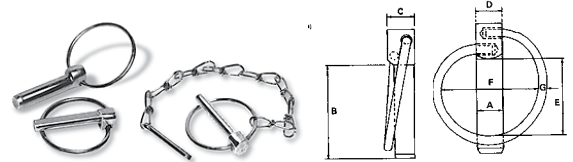

IBS No.	Description	A	B	C	D	E	F	G	Pkg Qty
63-01	Standard Pin	3/16	1-9/16	33/64	23/64	1-19/64	1-13/32	9/64	5
63-02	Standard Pin	1/4	1-9/16	33/64	23/64	1-19/64	1-13/32	9/64	5
A-11736	Standard Pin	1/4	1-3/4	1/2	1/4	1-5/16	1-9/16	9/64	5
63-03	Standard Pin	5/16	1-9/16	33/64	13/32	1-19/64	1-15/32	9/64	5
63-04	Standard Pin	7/16	1-9/16	9/16	29/64	1-23/64	1-17/32	9/64	5
63-05	Standard Pin HD Ring	7/16	1-3/4	9/16	29/64	1-23/64	1-43/64	.018	5
63-11	Standard Pin Chain & Cotter	7/16	1-9/16	9/16	29/64	1-23/64	1-17-32	9/64	5

Snapper & Lynch Pins Assortment (Z02)

IBS No. 394R • 11 Items • 33 Pieces

Packaged in a locking steel drawer for easy storage & organization

Snapper & Lynch Pins

Assortment No. 394R

<p>28-01 1/4 X 1-3/4 SNAPPER PIN</p>	<p>63-01 3/16 X 1-9/16 LYNCH PIN</p>	<p>63-04 7/16 X 1-9/16 LYNCH PIN</p>
<p>28-02 5/16 X 2-1/2 SNAPPER PIN</p>	<p>63-02 1/4 X 1-9/16 LYNCH PIN</p>	<p>63-05 7/16 X 1-3/4 LYNCH PIN</p>
<p>28-03 3/8 X 1-3/8 SNAPPER PIN</p>	<p>A-11736 1/4 X 1-3/4 LYNCH PIN</p>	<p>63-11 7/16 x 1-9/16 LYNCH PIN</p>
<p>28-04 3/8 X 2-1/4 SNAPPER PIN</p>	<p>63-03 5/16 X 1-9/16 LYNCH PIN</p>	

RINGS & PINS



Socket Products

A

Assortments

- Button Head Socket Capscrews 1/4-20 to 1/2-13 L-5**
- Button Head Socket Capscrews 4-40 to 10-32 L-5**
- Flat Head Socket Capscrews 1/4-20 to 1/2-13 L-4**
- Flat Head Socket Capscrews 4-40 to 10-32 L-4**
- Metric 12.9**
 - Flat Hd Socket Capscrews L-10
 - Socket Head Capscrews L-9
- Metric, Stainless**
 - Socket Set Screws L-10
- SAE Socket Set Screws L-7**
- Socket Head Capscrew L-3**
- Socket Head Capscrews 4-40 to 10-32 L-3**
- Socket Set Screw**
 - Metric L-10
- USS Socket Set Screws L-7**

C

Capscrews

- Button Head Socket**
 - National Coarse L-5
- Flat Head Socket**
 - National Coarse L-4
- Metric**
 - Socket L-9, L-10
 - Stainless Steel L-11
- Socket Head**
 - National Coarse L-2

National Fine L-2

S

- Set Screws**
 - Socket L-6**
 - Metric L-10
 - Nat'l coarse L-6
 - Square Head L-6**
- Set Screws**
 - Metric**
 - Stainless L-11
- Socket Keys**
 - Hex L-11**
- Stainless Steel**
 - Metric L-11**
- Stripper Bolts L-8**

**S
O
C
K
E
T

S
C
R
E
W
S**

Socket Products

**Manufactured From High Grade Alloy Steel
(AISI-4037 or AISI-4140)**

The type of alloy steel used is that which is best suited to meet the physical and mechanical properties as required by the specification ANSI B-18.3 1982.

SOCKET HEAD CAP SCREWS TENSILE & YIELD STRENGTH IN PSI

Diameter	Minimum Tensile Strength	Minimum Yield Strength
#0 - #10	195,000	175,000
1/4" - 7/16"	190,000	170,000
1/2"	185,000	165,000
5/8"	180,000	155,000
3/4" - 7/8"	175,000	150,000
1"	170,000	145,000
1-1/4" - 1-1/2"	160,000	135,000



IBS, INCORPORATED

Socket Products L01

SOCKET SCREWS



Socket Head Capscrews

Class 3 Thread Fit • National Coarse

Length (in.)	4-40	6-32	8-32	10-24	1/4-20	5/16-18	3/8-16	7/16-14	1/2-13	5/8-11	3/4-10	1-8	Length (in.)
1/4	14440	14450	14560										1/4
3/8	14441	14451	14561	14570	14580								3/8
1/2	14442	14452	14562	14571	14581	14596	14612						1/2
5/8	14443	14453	14563	14572	14582	14597							5/8
3/4	14444	14454	14564	14573	14583	14598	14614		14641				3/4
1		14455	14565	14574	14584	14599	14615	14630	14642				1
1-1/4			14566	14576	14585	14600	14616	14631	14643				1-1/4
1-1/2			14567	14577	14586	14601	14617	14632	14644	14658	14670		1-1/2
1-3/4					14587	14602	14618		14645	14659	14671		1-3/4
2				14579	14588	14603	14619	14634	14646	14660	14672	14432	2
2-1/2					14590	14605	14621	14636	14648*	14662	14674	14433	2-1/2
3					14592	14607	14623	14638	14650*	14664	14676	14434	3
3-1/2							14624		14651*	14665	14678	14435	3-1/2
4							14625	14639	14652*	14666	14679	14436	4
5												14438	5
6												14439	6
Pkg Qty	25	25 *10	25 *10	25	25	25	25	25 *10	25 *10	10	10	10	Pkg Qty



Socket Head Capscrews

Class 3 Thread Fit • National Fine

Length (in.)	10-32	1/4-28	5/16-24	3/8-24	1/2-20	5/8-18	Length (in.)
3/8	14680						3/8
1/2	14681	14690	14700				1/2
5/8	14682	14691	14701				5/8
3/4	14683	14692	14702	14712			3/4
1	14684	14693	14703	14713	14725		1
1-1/4	14685	14694	14704	14714	14726	14734	1-1/4
1-1/2	14686	14695	14705	14715	14727	14735	1-1/2
1-3/4						14736	1-3/4
2	14688			14717	14729	14737	2
2-1/2					14730	14738	2-1/2
3					14731		3
Pkg Qty	25	25	25	25	25	25	Pkg Qty

IBS, INCORPORATED























Assortments Z02



Socket Head Capscrews

IBS No. 167R

24 Items • 925 Pieces

























 IBS, Inc. <small>SPECIALTY PRODUCTS FOR MAINTENANCE & REPAIR INDUSTRIALBOLT.COM • © © 800-678-1906</small>						Hex Socket Head Cap Screws					
Assortment No. 167R											
14450 6-32 X 1/4 SOCKET HD C/S ALLOY 	14454 6-32 X 3/4 SOCKET HD C/S ALLOY 	14562 8-32 X 1/2 SOCKET HD C/S ALLOY 	14681 10-32 X 1/2 SOCKET HD C/S 	14571 10-24 X 1/2 SOCKET HD C/S 	14685 10-32 X 1-1/4 SOCKET HD C/S 						
14451 6-32 X 3/8 SOCKET HD C/S ALLOY 	14455 6-32 X 1 SOCKET HD C/S ALLOY 	14563 8-32 X 5/8 SOCKET HD C/S ALLOY 	14682 10-32 X 5/8 SOCKET HD C/S 	14572 10-24 X 5/8 SOCKET HD C/S 	14686 10-32 X 1-1/2 SOCKET HD C/S 						
14452 6-32 X 1/2 SOCKET HD C/S ALLOY 	14560 8-32 X 1/4 SOCKET HD C/S ALLOY 	14564 8-32 X 3/4 SOCKET HD C/S ALLOY 	14683 10-32 X 3/4 SOCKET HD C/S 	14573 10-24 X 3/4 SOCKET HD C/S 	14576 10-24 X 1-1/4 SOCKET HD C/S 						
14453 6-32 X 5/8 SOCKET HD C/S ALLOY 	14561 8-32 X 3/8 SOCKET HD C/S ALLOY 	14565 8-32 X 1 SOCKET HD C/S ALLOY 	14684 10-32 X 1 SOCKET HD C/S ALLOY 	14574 10-24 X 1 SOCKET HD C/S ALLOY 	14577 10-24 X 1-1/2 SOCKET HD C/S 						

Socket Head Capscrews

4-40 to 10-32

IBS No. 371R

23 Items • 1100 Pieces





















 IBS, Inc. <small>SPECIALTY PRODUCTS FOR MAINTENANCE & REPAIR INDUSTRIALBOLT.COM • © © 800-678-1906</small>						Socket Head Cap Screws 4-40 to 10-32					
Assortment No. 371R											
14440 4-40 X 1/4 SOCKET HD C/S ALLOY 	14441 4-40 X 3/8 SOCKET HD C/S ALLOY 	14442 4-40 X 1/2 SOCKET HD C/S ALLOY 	14443 4-40 X 5/8 SOCKET HD C/S ALLOY 	14444 4-40 X 3/4 SOCKET HD C/S ALLOY 	14450 6-32 X 1/4 SOCKET HD C/S ALLOY 						
14451 6-32 X 3/8 SOCKET HD C/S ALLOY 	14452 6-32 X 1/2 SOCKET HD C/S ALLOY 	14453 6-32 X 5/8 SOCKET HD C/S ALLOY 	14454 6-32 X 3/4 SOCKET HD C/S ALLOY 	14561 8-32 X 3/8 SOCKET HD C/S ALLOY 	14562 8-32 X 1/2 SOCKET HD C/S ALLOY 						
14563 8-32 X 5/8 SOCKET HD C/S ALLOY 	14564 8-32 X 3/4 SOCKET HD C/S ALLOY 	14565 8-32 X 1 SOCKET HD C/S ALLOY 	14570 10-24 X 3/8 SOCKET HD C/S 	14571 10-24 X 1/2 SOCKET HD C/S 	14573 10-24 X 3/4 SOCKET HD C/S 						
14574 10-24 X 1 SOCKET HD C/S ALLOY 	14680 10-32 X 3/8 SOCKET HD C/S 	14681 10-32 X 1/2 SOCKET HD C/S 	14683 10-32 X 3/4 SOCKET HD C/S 	14684 10-32 X 1 SOCKET HD C/S ALLOY 							

Socket Head Capscrews

1/4-20 to 1/2-13

IBS No. 372R

19 Items • 401 Pieces

 IBS, Inc. <small>SPECIALTY PRODUCTS FOR MAINTENANCE & REPAIR INDUSTRIALBOLT.COM • © © 800-678-1906</small>						Socket Head Cap Screws 1/4-20 to 1/2-13					
Assortment No. 372R											
14581 1/4-20 X 1/2 SOCKET HD C/S 	14583 1/4-20 X 3/4 SOCKET HD C/S 	14584 1/4-20 X 1 SOCKET HD C/S ALLOY 	14585 1/4-20 X 1-1/4 SOCKET HD C/S 	14586 1/4-20 X 1-1/2 SOCKET HD C/S 							
14596 5/16-18 X 1/2 SOCKET HD C/S 	14598 5/16-18 X 3/4 SOCKET HD C/S 	14599 5/16-18 X 1 SOCKET HD C/S 	14600 5/16-18 X 1-1/4 SOCKET HD C/S 	14601 5/16-18 X 1-1/2 SOCKET HD C/S 							
14614 3/8-16 X 3/4 SOCKET HD C/S 	14615 3/8-16 X 1 SOCKET HD C/S ALLOY 	14616 3/8-16 X 1-1/4 SOCKET HD C/S 	14617 3/8-16 X 1-1/2 SOCKET HD C/S 	14619 3/8-16 X 2 SOCKET HD C/S ALLOY 							
14642 1/2-13 X 1 SOCKET HD C/S ALLOY 	14643 1/2-13 X 1-1/4 SOCKET HD C/S 	14644 1/2-13 X 1-1/2 SOCKET HD C/S 	14646 1/2-13 X 2 SOCKET HD C/S ALLOY 								

S
O
C
K
E
T

S
C
R
E
W
S



IBS, INCORPORATED

Socket Products L01

SOCKET SCREWS



Flat Head Socket Cap Screws

CLASS 3 THREAD FIT • NATIONAL COARSE

Length	4-40	6-32	8-32	10-24	1/4-20	5/16-18	3/8-16	7/16-14	1/2-13	5/8-11	3/4-10	Length
1/4	147390	147399										1/4
3/8	147391	147400	147410	147420								3/8
1/2	147392	147401	147411	147421	14750	14760	14770					1/2
5/8	147393	147402	147412	147422								5/8
3/4	147394	147403	147413	147423	14752	14762	14772		14786			3/4
1			147414	147424	14753	14763	14773		14787			1
1-1/4				147425	14754	14764	14774	14781	14788	14797		1-1/4
1-1/2				147426	14755	14765	14775	14780	14789	14798	14804	1-1/2
1-3/4							14776		14790		14805	1-3/4
2							14777	14784	14791	14800	14806	2
2-1/2									14793*	14801	14807	2-1/2
3									14794*	14802	14809	3
Qty	25	25	25	25	25	25	25	25	25/*10	25	25	Qty



Flat Head Socket Cap Screws

CLASS 3 THREAD FIT • NATIONAL FINE

Length	10-32	1/4-28	5/16-24	3/8-24	1/2-20	Length
3/8	14815					3/8
1/2	14816	14825	14832			1/2
5/8	14817					5/8
3/4	14818	14826	14833	14837		3/4
1	14819	14827	14834	14838	14843	1
1-1/4	14820	14828	14835	14839	14844	1-1/4
1-1/2	14821	14829	14836	14840	14845	1-1/2
1-3/4					14846	1-3/4
2					14847	2
Qty	25	25	25	25	25	Qty

Flat Head Socket Capscrews 4-40 to 10-32 (Z02)

IBS No. 373R • 24 Items • 1051 Pieces

Flat Head Socket Capscrews 1/4-20 to 1/2-13 (Z02)

IBS No. 374R • 19 Items • 356 Pieces

IBS, Inc. Flat Head Socket Capscrews 4-40 - 10-32

Assortment No. 373R

147390 4-40 X 1/4 FLAT SOCKET C/S	147391 4-40 X 3/8 FLAT SOCKET C/S	147392 4-40 X 1/2 FLAT SOCKET C/S	147393 4-40 X 5/8 FLAT SOCKET C/S	147394 4-40 X 3/4 FLAT SOCKET C/S	147399 6-32 X 1/4 FLAT SOCKET HD C/S
147400 6-32 X 1/8 FLAT SOCKET C/S	147401 6-32 X 1/2 FLAT SOCKET C/S	147402 6-32 X 5/8 FLAT SOCKET C/S	147403 6-32 X 3/4 FLAT SOCKET C/S	147410 8-32 X 3/8 FLAT SOCKET C/S	147411 8-32 X 1/2 FLAT SOCKET C/S
147412 8-32 X 5/8 FLAT SOCKET C/S	147413 8-32 X 3/4 FLAT SOCKET C/S	147414 8-32 X 1 FLAT SOCKET C/S ALLOY	147420 10-24 X 3/8 FLAT SOCKET C/S	147421 10-24 X 1/2 FLAT SOCKET C/S	147423 10-24 X 3/4 FLAT SOCKET HD
147424 10-24 X 1 FLAT SOCKET HD C/S	14815 10-32 X 3/8 FLAT SOCKET C/S	14816 10-32 X 1/2 FLAT SOCKET C/S	14818 10-32 X 3/4 FLAT SOCKET C/S	14819 10-32 X 1 FLAT SOCKET C/S	

IBS, Inc. Flat Head Socket Capscrews 1/4-20 - 1/2-13

Assortment No. 374R

14750 1/4-20 X 1/2 FLAT SOCKET C/S	14752 1/4-20 X 3/4 FLAT SOCKET C/S	14753 1/4-20 X 1 FLAT SOCKET C/S	14754 1/4-20 X 1-1/4 FLAT SOCKET C/S	14755 1/4-20 X 1-1/2 FLAT SOCKET C/S
14760 5/16-18 X 1/2 FLAT SOCKET C/S	14762 5/16-18 X 3/4 FLAT SOCKET C/S	14763 5/16-18 X 1 FLAT SOCKET C/S	14764 5/16-18 X 1-1/4 FLAT SOCKET C/S	14765 5/16-18 X 1-1/2 FLAT SOCKET C/S
14772 3/8-16 X 3/4 FLAT SOCKET C/S	14773 3/8-16 X 1 FLAT SOCKET C/S	14774 3/8-16 X 1-1/4 FLAT SOCKET C/S	14775 3/8-16 X 1-1/2 FLAT SOCKET C/S	14777 3/8-16 X 2 FLAT SOCKET C/S
14787 1/2-13 X 1 FLAT SOCKET C/S	14788 1/2-13 X 1-1/4 FLAT SOCKET C/S	14789 1/2-13 X 1-1/2 FLAT SOCKET C/S	14791 1/2-13 X 2 FLAT SOCKET C/S	

IBS, INCORPORATED

Socket Products L01



Button Head Socket Cap Screws

CLASS 3 THREAD FIT • NATIONAL COARSE & FINE



Length (in.)	4-40	6-32	8-32	10-24	10-32	1/4-20	5/16-18	3/8-16	1/2-13	5/8-11	Length (in.)
1/4	148911	148915	148920	148925	148930						1/4
3/8	148912	148916	148921	148926	148931	14915	14920				3/8
1/2	148913	148917	14902	14907	14911	14916	14921	14926			1/2
5/8		148918	14903	14908	148932	14917	14922	14927			5/8
3/4			14904	14909	14912	14918	14923	14928			3/4
1				14910	14913	14919	14924	14929	14932		1
1-1/4								14930	14933	14937	1-1/4
1-1/2									14934	14938	1-1/2
1-3/4										14939	1-3/4
2									14935	14940	2
Pkg Qty	25	25	25	25	25	25	25	25	10	10	Pkg Qty

Button Head Socket Capscrews 4-40 to 10-32 (Z02)
IBS No. 376R
25 Items • 1051 Pieces

IBS, Inc. SPECIALTY PRODUCTS FOR MAINTENANCE & REPAIR INDUSTRIALBOLT.COM © © © 800-678-1506						Button Head Socket Cap Screws 4-40 to 10-32 Assortment No. 376R					
148911 4-40 X 1/4 BUTTON SOC C/S Hex Key: 1/16"	148912 4-40 X 3/8 BUTTON SOC C/S Hex Key: 1/16"	148913 4-40 X 3/8 BUTTON SOC C/S Hex Key: 1/16"	148915 6-32 X 3/8 BUTTON SOC C/S Hex Key: 1/12"	148916 6-32 X 3/8 BUTTON SOC C/S Hex Key: 5/64"	148917 6-32 X 1/2 BUTTON SOC C/S Hex Key: 5/64"						
148918 6-32 X 5/8 BUTTON SOC C/S Hex Key: 5/64"	148920 8-32 X 1/4 BUTTON SOC C/S Hex Key: 3/32"	148921 8-32 X 3/8 BUTTON SOC C/S Hex Key: 3/32"	14902 8-32 X 1/2 BUTTON SOC C/S Hex Key: 3/32"	14903 8-32 X 5/8 BUTTON SOC C/S Hex Key: 3/32"	14904 8-32 X 3/4 BUTTON SOC C/S Hex Key: 3/32"						
148925 10-24 X 1/4 BUTTON SOC C/S Hex Key: 1/8"	148926 10-24 X 3/8 BUTTON SOC C/S Hex Key: 1/8"	14907 10-24 X 1/2 BUTTON SOC C/S Hex Key: 1/8"	14908 10-24 X 5/8 BUTTON SOC C/S Hex Key: 1/8"	14909 10-24 X 3/4 BUTTON SOC C/S Hex Key: 1/8"	14910 10-24 X 1 BUTTON SOC C/S Hex Key: 3/32"						
148930 10-32 X 1/4 BUTTON SOC C/S Hex Key: 1/8"	148931 10-32 X 1/4 BUTTON SOC C/S Hex Key: 1/8"	14911 10-32 X 1/2 BUTTON SOC C/S Hex Key: 1/8"	148932 10-32 X 5/8 BUTTON SOC C/S Hex Key: 1/8"	14912 10-32 X 3/4 BUTTON SOC C/S Hex Key: 1/8"	14913 10-32 X 1 BUTTON SOC C/S Hex Key: 1/8"						

Button Head Socket Capscrews 1/4-20 to 1/2-13
IBS No. 377R
20 Items • 377 Pieces

IBS, Inc. SPECIALTY PRODUCTS FOR MAINTENANCE & REPAIR INDUSTRIALBOLT.COM © © © 800-678-1506					Button Head Socket Capscrews 1/4-20 to 1/2-13 Assortment No. 377R				
14915 1/4-20 X 3/8 BUTTON SOCKET C/S Hex Key 5/32"	14916 1/4-20 X 1/2 BUTTON SOCKET C/S Hex Key 5/32"	14917 1/4-20 X 5/8 BUTTON SOCKET C/S Hex Key 5/32"	14918 1/4-20 X 3/4 BUTTON SOCKET C/S Hex Key 5/32"	14919 1/4-20 X 1 BUTTON SOCKET C/S Hex Key 5/32"					
14920 5/16-18 X 3/8 BUTTON SOCKET C/S Hex Key 3/16"	14921 5/16-18 X 1/2 BUTTON SOCKET C/S Hex Key 3/16"	14922 5/16 X 5/8 BUTTON SOCKET C/S Hex Key 3/16"	14923 5/16-18 X 3/4 BUTTON SOCKET C/S Hex Key 3/16"	14924 5/16-18 X 1 BUTTON SOCKET C/S Hex Key 3/16"					
14926 3/8-16 X 1/2 BUTTON SOCKET C/S Hex Key 7/32"	14927 3/8-16 X 5/8 BUTTON SOCKET C/S Hex Key 7/32"	14928 3/8-16 X 3/4 BUTTON SOCKET C/S Hex Key 7/32"	14929 3/8-16 X 1 BUTTON SOCKET C/S Hex Key 7/32"	14930 3/8-16 X 1-1/4 BUTTON SOCKET C/S Hex Key 7/32"					
14932 1/2-13 X 1 BUTTON SOCKET C/S Hex Key 5/16"	14933 1/2-13 X 1-1/4 BUTTON SOCKET C/S Hex Key 5/16"	14934 1/2-13 X 1-1/2 BUTTON SOCKET C/S Hex Key 5/16"	14935 1/2-13 X 2 BUTTON SOCKET C/S Hex Key 5/16"						

S O C K E T S C R E W S



IBS, INCORPORATED

Socket Products L01

Square Head Set Screws — Cup Point



Length (in.)	1/4-20	5/16-18	3/8-16	7/16-14	1/2-13	5/8-11	3/4-10	Length (in.)
3/4	14051	14056A	14064					3/4
1	14052	14057	14065	14070				1
1-1/2	14053	14059	14067	14071	14077	14087	14095	1-1/2
2		14061	14069	14072	14078	14088	14096	2
2-1/2					14079	14089	14097	2-1/2
3					14080	14090	14098	3
4					14081	14092	14099	4
Pkg Qty	25	25	25	25	25	10	10	Pkg Qty

Socket Set Screws — Knurled Point

Our Socket Set Screws are now featuring a knurled point for better gripping and staying power. Only the 5/8-11 and 1/2-20 set screws will remain stocked in cup point.

NATIONAL COARSE

Length (in.)	6-32	8-32	10-24	10-32	1/4-20	5/16-18	3/8-16	7/16-14	1/2-13	Length (in.)
3/16	14167	14177	14187	14198						3/16
1/4	14168	14178	14188	14199	14212	14226*	14310			1/4
5/16	14169	14179			14213	14227	14311*			5/16
3/8	14170	14180	14190	14201	14214	14228	14312	14325*		3/8
7/16						14229*				7/16
1/2	14171	14182	14191	14203	14216	14300	14314	14326*	14335	1/2
5/8						14301	14315		14336	5/8
3/4					14218	14302	14316	14328*	14337	3/4
1					14220	14304	14318		14338	1
1-1/4										1-1/4
Pkg Qty	25	25	25	25	25	25	25	25	25	Pkg Qty

NATIONAL FINE

Length (in.)	1/4-28	5/16-24	3/8-24	1/2-20	Length (in.)
1/4	14361	14370			1/4
5/16	14362	14371			5/16
3/8	14363	14372	14382		3/8
1/2	14365	14374	14384	14398	1/2
5/8			14385	14399	5/8
3/4	14366	14376	14386	14400	3/4
1			14387	14401	1
Pkg Qty	25	25	25	25	Pkg Qty



S
O
C
K
E
T

S
C
R
E
W
S















IBS, INCORPORATED

Assortments Z02



USS Socket Set Screws - NC National Coarse

IBS No. 190R • 32 Items • 490 Pieces

IBS, Inc. SPECIALTY PRODUCTS FOR MAINTENANCE & REPAIR INDUSTRIALBOLT.COM 800-678-1906		Socket Set Screws Knurled Point Thread						Assortment No. 190R
14168 6-32 X 1/4 SOC SET KNURLED PT 	14169 6-32 X 5/16 SOC SET KNURLED PT 	14170 6-32 X 3/8 SOC SET KNURLED PT 	14178 8-32 X 1/4 SOC SET KNURLED PT 	14179 8-32 X 5/16 SOC SET KNURLED PT 	14180 8-32 X 3/8 SOC SET KNURLED PT 	14182 8-32 X 1/2 SOC SET KNURLED PT 	14187 10-24 X 3/16 SOC SET KNURLED 	
14188 10-24 X 1/4 SOC SET KNURLED PT 	14190 10-24 X 3/8 SOC SET KNURLED PT 	14191 10-24 X 1/2 SOC SET KNURLED PT 	14212 1/4-20 X 1/4 SOC SET KNURLED 	14213 1/4-20 X 5/16 SOC SET 	14214 1/4-20 X 3/8 SOC SET KNURLED 	14216 1/4-20 X 1/2 SOC SET KNURLED 	14218 1/4-20 X 3/4 SOC SET KNURLED 	
14228 5/16-18 X 3/8 SOC SET 	14300 5/16-18 X 1/2 SOC SET 	14302 5/16-18 X 3/4 SOC SET 	14314 3/8-16 X 1/2 SOC SET KNURLED 	14315 3/8-16 X 5/8 SOC SET KNURLED 	14316 3/8-16 X 3/4 SOC SET KNURLED 	14318 3/8-16 X 1 SOC SET KNURLED PT 	14335 1/2-13 X 1/2 SOC SET KNURLED 	
14336 1/2-13 X 5/8 SOC SET KNURLED 	14337 1/2-13 X 3/4 SOC SET KNURLED 	14338 1/2-13 X 1 SOC SET KNURLED PT 						

SAE Socket Set Screws - NF National Fine

IBS No. 191R • 20 ITEMS • 615 PIECES

IBS, Inc. SPECIALTY PRODUCTS FOR MAINTENANCE & REPAIR INDUSTRIALBOLT.COM 800-678-1906		SAE Alloy Socket Set Screws Knurled Point			Assortment No. 191R
14198 10-32 X 3/16 SOC SET KNURLED 	14361 1/4-28 X 1/4 SOC SET KNURLED 	14366 1/4-28 X 3/4 SOC SET KNURLED 	14384 3/8-24 X 1/2 SOC SET KNURLED 	14398 1/2-20 X 1/2 SOC SET CUP KNURLED 	
14199 10-32 X 1/4 SOC SET KNURLED PT 	14362 1/4-28 X 5/16 SOC SET KNURLED 	14372 5/16-24 X 3/8 SOC SET KNURLED 	14385 3/8-24 X 5/8 SOC SET KNURLED 	14399 1/2-20 X 5/8 SOC SET CUP KNURLED 	
14201 10-32 X 3/8 SOC SET KNURLED 	14363 1/4-28 X 3/8 SOC SET KNURLED 	14374 5/16-24 X 1/2 SOC SET KNURLED 	14386 3/8-24 X 3/4 SOC SET KNURLED 	14400 1/2-20 X 3/4 SOC SET CUP KNURLED 	
14203 10-32 X 1/2 SOC SET KNURLED 	14365 1/4-28 X 1/2 SOC SET KNURLED 	14376 5/16-24 X 3/4 SOC SET KNURLED 	14387 3/8-24 X 1 SOC SET KNURLED PT 	14401 1/2-20 X 1 SOC SET CUP POINT 	

S O C K E T S C R E W S



IBS, INCORPORATED

Socket Products L01

Shoulder Bolts

(A.K.A. STRIPPER BOLTS)



Thread Pitch x Thread Length	10-24 x 3/8	1/4-20 x 7/16	5/16-18 x 1/2	3/8-16 x 5/8	1/2-13 x 5/8
Shoulder Length	1/4 Shoulder Diameter	5/16 Shoulder Diameter	3/8 Shoulder Diameter	1/2 Shoulder Diameter	5/8 Shoulder Diameter
3/8	14944				
1/2	14945				
3/4	14946	14969	149717	14973	
1	14947	14970	149718	14974	
1-1/4	14948	14971	149719	149741	14982
1-1/2	14949	149711	14972	14975	14983
2		149712	149723	149752	14984
2-1/2			149725	149754	14986
3					14987
Pkg Qty	10	10	10	10	10

S
O
C
K
E
T
S
C
R
E
W
S

IBS, INCORPORATED

Metric Socket Products H17



Metric Socket Head Cap Screws — Class 12.9



Length (mm)	M3	M4	M5	M6	M8	M10	M12	M14	M16	M20	M24	Length (mm)
10		815	82200	8242								10
12	810	816	822	824A	828	833						12
16	812	818	823	824B	82800	834	83600					16
20	814	820	823A	824C	829	835	83601					20
25		821	824	824D	829A	835A	836	839				25
30		82105	82400	825	830	835B	836A	83901				30
35		82106	82401	826	830A	835C	83602	840	84110			35
40		82107	82402	827	831	835D	836B	841	84111	845		40
45		82108	82403	82700	83100	83500	83603	84100	84112	846		45
50		82109	82404	827B	832	83501	837A	84101	842	847	860	50
60				82702	83201	83503	838	84103	84201	849	862	60
70				82703	83202	83504	83800	84104	84202	850	863	70
75									843			75
80						83505	83801	84105	84300	851	864	80
90						83506	83802	84106	84301	852	865	90
100						83507	83803	84107	84302	853	866	100
110									84303	854	867	110
120									84304	855	868	120
130									84305	856	869	130
140									84306	857	86900	140
150									84307	858	86901	150
Pkg Qty	100	100	50	50	25	25	10	10	10	5	5	Pkg Qty

SOCKET SCREWS

Metric 12.9 Socket Head Cap Screws (Z02)

IBS No. 266R • 24 ITEMS • 435 PIECES

Packaged in a Locking Steel Drawer for Easy Storage & Organization

IBS, Inc. <small>SPECIALTY PRODUCTS FOR MAINTENANCE & REPAIR INDUSTRIALSOLTS.COM © © © 800-678-1958</small>		Metric 12.9 Socket Head Capscrews				Assortment No. 266R
816 M4 X 12 SOCKET HD C/S ALLOY 	818 M4 X 16 SOCKET HD C/S ALLOY 	820 M4 X 20 SOCKET HD C/S ALLOY 	821 M4 X 25 SOCKET HD C/S ALLOY 	822 M5 X 12 SOCKET HD C/S ALLOY 	823 M5 X 16 SOCKET HD C/S ALLOY 	
823A M5 X 20 SOCKET HD C/S ALLOY 	824 M5 X 25 SOCKET HD C/S ALLOY 	824A M6 X 12 SOCKET HD C/S ALLOY 	824B M6 X 16 SOCKET HD C/S ALLOY 	824C M6 X 20 SOCKET HD C/S ALLOY 	824D M6 X 25 SOCKET HD C/S ALLOY 	
825 M6 X 30 SOCKET HD C/S ALLOY 	827 M6 X 40 SOCKET HD C/S ALLOY 	829 M8 X 20 SOCKET HD C/S ALLOY 	829A M8 X 25 SOCKET HD C/S ALLOY 	830 M8 X 30 SOCKET HD C/S ALLOY 	830A M8 X 35 SOCKET HD C/S ALLOY 	
831 M8 X 40 SOCKET HD C/S ALLOY 	835 M10 X 20 SOCKET HD C/S ALLOY 	835A M10 X 25 SOCKET HD C/S ALLOY 	835B M10 X 30 SOCKET HD C/S ALLOY 	835C M10 X 35 SOCKET HD C/S ALLOY 	835D M10 X 40 SOCKET HD C/S ALLOY 	



IBS, INCORPORATED

Metric Socket Products H17

Metric Flat Socket Cap Screws — Class 12.9

Metric 12.9 Flat Socket Cap Screws Assortment (Z02)

IBS No. 267R • 24 ITEMS • 475 PIECES



Length (mm.)	M4	M5	M6	M8	M10	Length (mm)
12	84345	84360	84370			12
16	84346	84361	84371			16
20	84347	84362	84372	84381	84391	20
25	84348	84363	84373	84382	84393	25
30			84374	84383	84394	30
35				84384	84395	35
40			84375	84385	84393	40
Qty	25	25	25	25	25	Qty

IBS Inc. INDUSTRIALBOLT.COM © P.O. 800-878-1506						Metric 12.9 Flat Socket Head Cap Screws
						Assortment No. 267R
84345 M4 X 12 FLAT SOCKET C/S ALLOY	84346 M4 X 16 FLAT SOCKET C/S ALLOY	84347 M4 X 20 FLAT SOCKET C/S ALLOY	84348 M4 X 25 FLAT SOCKET C/S ALLOY	84360 M5 X 12 FLAT SOCKET C/S ALLOY	84361 M5 X 16 FLAT SOCKET C/S ALLOY	
84362 M5 X 20 FLAT SOCKET C/S ALLOY	84363 M5 X 25 FLAT SOCKET C/S ALLOY	84370 M6 X 12 FLAT SOCKET C/S ALLOY	84371 M6 X 16 FLAT SOCKET C/S ALLOY	84372 M6 X 20 FLAT SOCKET C/S ALLOY	84373 M6 X 25 FLAT SOCKET C/S ALLOY	
84374 M6 X 30 FLAT SOCKET C/S ALLOY	84375 M6 X 40 FLAT SOCKET C/S ALLOY	84381 M8 X 20 FLAT SOCKET C/S ALLOY	84382 M8 X 25 FLAT SOCKET C/S ALLOY	84383 M8 X 30 FLAT SOCKET C/S 12.9	84384 M8 X 35 FLAT SOCKET C/S 12.9	
84385 M8 X 40 FLAT SOCKET C/S ALLOY	84391 M10 X 20 FLAT SOCKET C/S ALLOY	84393 M10 X 25 FLAT SOCKET C/S ALLOY	84394 M10 X 30 FLAT SOCKET C/S ALLOY	84395 M10 X 35 FLAT SOCKET C/S ALLOY	84396 M10 X 40 FLAT SOCKET C/S 12.9	

Metric Socket Set Screws Cup Point — Class 12.9

Metric Socket Set Screws Stainless Steel Assortment (Z02)

IBS No. 405R • 24 Items • 206 Pieces



Length (mm)	M6	M8	M10	M12	Length (mm)
6	785				6
8	786	792			8
10	787	793	797		10
12	788	794	798	804	12
16	789	795	799	805	16
20	790	796	800	806	20
25			802	807	25
30				807A	30
35			803	808	35
40				809	40
Qty	25	25	25	25	Qty

IBS Inc. INDUSTRIALBOLT.COM © P.O. 800-878-1506						Stainless Steel Metric Socket Set Screws
						Assortment No. 405R
96900 M4 X 6 SOC SET SCREW SS	96905 M5 X 6 SOC SET SCREW SS	96910 M6 X 8 SOC SET SCREW SS	96915 M8 X 10 SOC SET SCREW SS	96920 M10 X 12 SOC SET SCREW SS	96925 M12 X 16 SOC SET SCREW SS	
96901 M4 X 8 SOC SET SCREW SS	96906 M5 X 8 SOC SET SCREW SS	96911 M6 X 10 SOC SET SCREW SS	96916 M8 X 12 SOC SET SCREW SS	96921 M10 X 16 SOC SET SCREW SS	96926 M12 X 20 SOC SET SCREW SS	
96902 M4 X 10 SOC SET SCREW SS	96907 M5 X 10 SOC SET SCREW SS	96912 M6 X 12 SOC SET SCREW SS	96917 M8 X 16 SOC SET SCREW SS	96922 M10 X 20 SOC SET SCREW SS	96927 M12 X 25 SOC SET SCREW SS	
96903 M4 X 12 SOC SET SCREW SS	96908 M5 X 12 SOC SET SCREW SS	96913 M6 X 16 SOC SET SCREW SS	96918 M8 X 20 SOC SET SCREW SS	96923 M10 X 25 SOC SET SCREW SS	96928 M12 X 30 SOC SET SCREW SS	

SOCKET SCREWS

Metric Stainless Steel Socket Head Capscrews



Length (mm)	M4	M5	M6	M8	M10	M12	Length (mm)
10	96850	96855	96860	96870			10
16	96851	96856	96861	96871			16
20	96852	96857	96862	96872	96880	96890	20
25	96853	96858	96863	96873	96881	96891	25
30			96864	96874	96882	96892	30
35				96875	96883	96893	35
40				96876	96884	96894	40
45				96877	96885	96895	45
Pkg Qty	25	25	25	25	15	10	Pkg Qty

Metric Stainless Steel Socket Set Screws



Length (mm)	M4	M5	M6	M8	M10	M12	Length (mm)
6	96900	96905					6
8	96901	96906	96910				8
10	96902	96907	96911	96915			10
12	96903	96908	96912	96916	96920		12
16			96913	96917	96921	96925	16
20				96918	96922	96926	20
25					96923	96927	25
30						96928	30
Pkg Qty	25	25	25	25	15	10	Pkg Qty

Hex Socket Keys (L01)
Sold Individually



IBS No.	Size	IBS No.	1/4 Size	IBS No.	Size
14950	1/16	14955	9/64	14960	5/16
14951	5/64	14956	5/32	14961	3/8
14952	3/32	14957	3/16	14962	7/16
14953	7/64	14958	7/32	14963	1/2

SOCKET SCREWS



S
O
C
K
E
T

S
C
R
E
W
S



Threaded Rod

A

Assortments

Threaded Rod

Grade 8 Threaded Rod Assortment M-4

METRIC 10.9 M-3

USS B-7 M-3

USS MILD STEEL M-3

R

Round Bar

Mild Steel M-2

T

Threaded Rod

Grade 8

National Coarse

Plain M-3, M-4

National Fine

Plain M-3

Grade 10.9

National Coarse

Plain M-3

Tools

Deburring Tool (T03) M-4

Zinc Plated

Round Bar, Mild Steel M-2



IBS, INCORPORATED

Threaded Rod M01 to M07

Zinc Plated Threaded Rod

Mild Steel (M01)

National Coarse

IBS No.	Size	Length
14850	6-32	3 ft.
14851	8-32	3 ft.
14852	10-24	3 ft.
14854	1/4-20	3 ft.
14855	5/16-18	3 ft.
14856	3/8-16	3 ft.
14857	7/16-14	3 ft.
14858	1/2-13	3 ft.
14859	9/16-12	3 ft.
14860	5/8-11	3 ft.
14861	3/4-10	3 ft.
14862	7/8-9	3 ft.
14863	1" - 8	3 ft.

Mild Steel (M02)

National Fine

IBS No.	Size	Length
14864	10-32	3 ft.
14865	1/4-28	3 ft.
14866	5/16-24	3 ft.
14867	3/8-24	3 ft.
14868	7/16-20	3 ft.
14869	1/2-20	3 ft.
14870	9/16-18	3 ft.
14871	5/8-18	3 ft.
14872	3/4-16	3 ft.
14873	7/9-14	3 ft.
14874	1" - 14	3 ft.

Mild Steel Round Bar (M06)

IBS No.	Size	Length
45000	1/8	3 ft.
45002	3/16	3 ft.
45003	1/4	3 ft.
45004	5/16	3 ft.
45005	3/8	3 ft.
45006	7/16	3 ft.
45007	1/2	3 ft.
45008	9/16	3 ft.
45009	5/8	3 ft.
45010	3/4	3 ft.
45011	7/8	3 ft.
45012	1"	3 ft.



Mild Steel All Thread Rod

- Cut from Grade 2 stock.
- Non-heat treated.
- Zinc plated for corrosion resistance.

Round Bar Stock

- Made from low carbon steel.
- Cold drawn for toughness.
- Zinc plated for corrosion resistance.
- Excellent machinability.
- Meets ASTM-A-108

B-7 Threaded Rod

B-7 (M03)

National Coarse

IBS No.	Size	Length
14880	1/4-20	3 ft.
14881	5/16-18	3 ft.
14882	3/8-16	3 ft.
14883	7/16-14	3 ft.
14884	1/2-13	3 ft.
14885	9/16-12	3 ft.
14886	5/8-11	3 ft.
14887	3/4-10	3 ft.
14888	7/8-9	3 ft.
14889	1" - 8	3 ft.
14890	1-1/8" - 7	3 ft.
14891	1-1/4" - 7	3 ft.
14891A	1-1/4" - 8	3 ft.
14892	1-3/8-8	3 ft.
14893	1-1/2" - 6	3 ft.
14894	1-5/8-6	3 ft.

B-7 (M04)

National Fine

IBS No.	Size	Length
15000	1/4-28	3 ft.
15001	5/16-24	3 ft.
15002	3/8-24	3 ft.
15003	7/16-20	3 ft.
15004	1/2-20	3 ft.
15005	9/16-18	3 ft.
15006	5/8-18	3 ft.
15007	3/4-16	3 ft.
15008	7/8-14	3 ft.
15009	1" - 14	3 ft.



B-7 Threaded Rod is composed of Chromium and Molybdenum. It has a minimum tempering temperature of 1100°F.

Technical Data

Min. Tensile Strength:125,000 psi. Min. Area Reduction: B-7 60%
 Yield Strength: 105,000 psi. Min. Tempering Temp. B-7 1100°F
 Min. Elongation: B-7 16%

T
H
R
E
A
D
E
D
R
O
D



NC & NF Plain Threaded Rod

Grade 8 Threaded Rod (M07)

National Coarse, Plain

IBS No.	Size	Length
45020	1/4-20	3 ft.
45021	5/16-18	3 ft.
45022	3/8-16	3 ft.
45023	7/16-14	3 ft.
45024	1/2-13	3 ft.
45025	9/16-12	3 ft.
45026	5/8-11	3 ft.
45027	3/4-10	3 ft.
45028	7/8-9	3 ft.
45029	1-8	3 ft.
45031	1-1/8-7	3 ft.
45032	1-1/4-7	3 ft.
45033	1-1/2-6	3 ft.



Grade 8 Threaded Rod (M07)

National Fine, Plain

IBS No.	Size	Length
45034	1/4-28	3 ft.
45035	5/16-24	3 ft.
45036	3/8-24	3 ft.
45037	7/16-20	3 ft.
45038	1/2-20	3 ft.
45039	9/16-18	3 ft.
45040	5/8-18	3 ft.
45041	3/4-16	3 ft.
45042	7/8-14	3 ft.
45043	1-14	3 ft.



Grade 10.9 Threaded Rod (H22)

National Coarse, Plain

IBS No.	Size	Length
45050	M6-1.0	3 ft.
45051	M8-1.25	3 ft.
45052	M10-1.5	3 ft.
45053	M12-1.75	3 ft.
45054	M14-2.0	3 ft.
45055	M16-2.0	3 ft.
45056	M20-2.5	3 ft.
45058	M24-3.0	3 ft.
45059	M30-3.5	3 ft.



Threaded Rod Assortments (Z08)

All Threaded Rod Comes in Three (3) Ft or 1 Meter Lengths
Threaded Rod Rack Included

USS MILD STEEL

IBS No. 175R

11 Items • 31 Pcs

IBS No.	Size	Qty
14850	6-32	2
14851	8-32	2
14852	10-24	2
14854	1/4-20	5
14855	5/16-18	4
14856	3/8-16	5
14857	7/16-14	2
14858	1/2-13	4
14859	9/16-12	1
14860	5-8-11	2
14861	3/4-10	2
AJ367	RACK	1

USS B-7

IBS No. 176R

8 Items • 18 Pcs

IBS No.	Size	Qty
14880	1/4-20	3
14881	5/16-18	3
14882	3/8-16	3
14883	7/16-14	2
14884	1/2-13	3
14885	9/16-12	1
14886	5/8-11	2
14887	3/4-10	1
AJ367	RACK	1

METRIC 10.9

IBS No. 808R

6 Items • 12 Pcs

IBS No.	Size	Qty
45050	M6-1.0	2
45051	M8-1.25	2
45052	M10-1.5	2
45053	M12-1.75	2
45055	M16-2.0	2
45056	M20-2.5	2
AJ367	RACK	1



T H R E A D E D R O D



IBS, INCORPORATED

Threaded Rod M01 to M06

Grade 8 Threaded Rod Assortment (Z08)

IBS No. 108R • 6 Items • 16 Pcs.

Grade 8 Threaded Rod
National Coarse, Plain

IBS No.	Size	Qty
45020	1/4-20	3 ft.
45021	5/16-18	3 ft.
45022	3/8-16	3 ft.
45024	1/2-13	3 ft.
45026	5/8-11	3 ft.
45027	3/4-10	3 ft.

**All Threaded Rod
Comes in Three (3) Ft
or 1 Meter Lengths
Threaded Rod Rack
Included**



Deburring Tool 3Pc Set (T03)

IBS No. 476P



- Quickly repairs damaged threads from 7/64" to 2-1/3".
- Hardened HRC 60 Steel blades remove burrs and uneven ridges from threaded rods, pipes and more.
- Works on hardened and mild steels, Grade 8 fasteners, stainless steel, brass copper, aluminum, plastics, wood, etc.
- 1/4" hex shank attaches to your drill quickly.
- Most effective at low speeds — recommended speed should not exceed 500 RPM in a clockwise direction only.

IBS No.	Description	Shank	Qty
51951	Small Deburring Tool 7/64" to 7/16"	1/4"	1
51950	Medium Deburring Tool 5/16" to 7/8"	1/4"	1
51952	Large Deburring Tool 23/32" to 2-1/3"	3/8"	1
476P	3pc Set		





Steel Pipe Fittings

Pipe Fittings

45° Elbows N-2

Bell Reducers N-2

Nipples

Galvanized N-4

Welded Steel N-4

Assortments

Pipe Fittings

139R - Drawer N-5

151S - Cabinet N-5

154P - Bin N-6

A

P

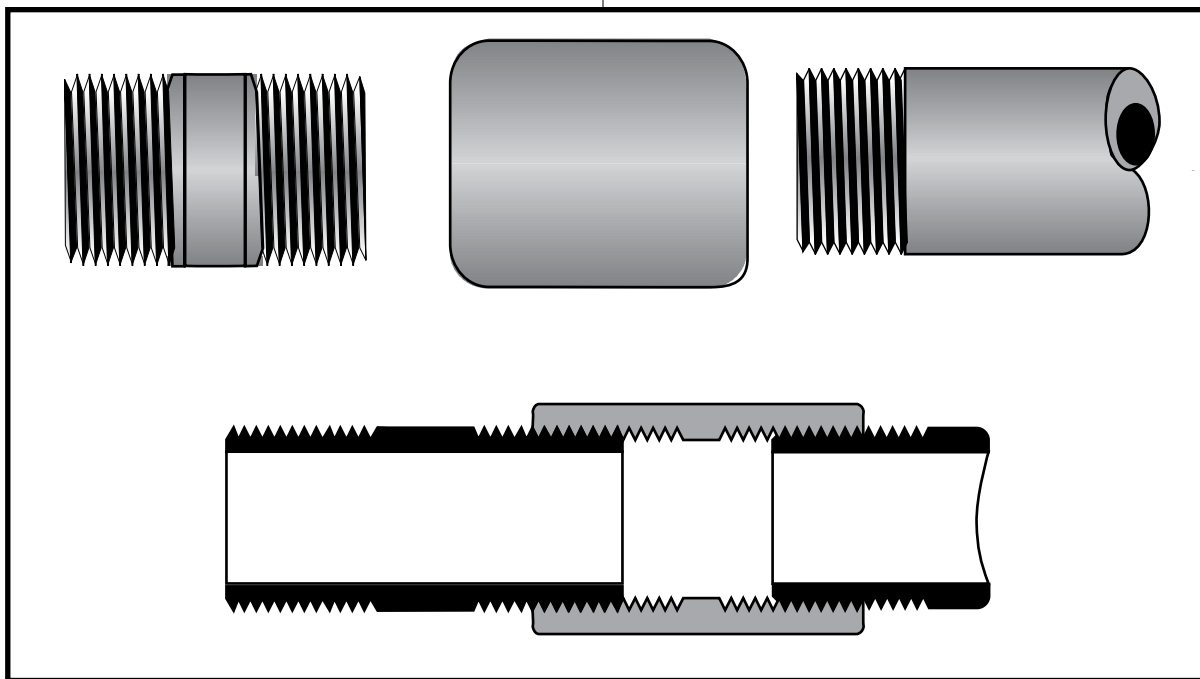

- Fittings are clean, easy to work with and start.
- Will not crack under pressure.
- Tempered durable threads that will not strip easily.
- Will work up to 150 psi steam pressure.
- Accurately threaded to the American Standard Thread Gauge to ensure perfect alignment and correct branch angles.
- Openings are slightly tapered to permit easy entrance of the pipe.

**S
T
E
E
L

P
I
P
E

F
I
T
T
I
N
G
S**



IBS, INCORPORATED

Pipe Fittings NPT N01

Pipe Fittings - Malleable Iron

STEEL PIPE FITTINGS



90° Elbows

IBS No.		Size	Pkg Qty
Black Iron	Galvanized		
15030	25010	1/8	5
15031	25011	1/4	5
15032	25012	3/8	5
15033	25013	1/2	5
15034	25014	3/4	3
15035	25015	1	1
15036	25016	1-1/4	1
15215	25017	1-1/2	1
15216	25018	2	1



45° Elbows

IBS No.		Size	Pkg Qty
Black Iron	Galvanized		
15038	25020	1/8	5
15039	25021	1/4	5
15040	25022	3/8	5
15041	25023	1/2	5
15042	25024	3/4	3
15043	25025	1	1
15044	25026	1-1/4	1
15220	25027	1-1/2	1
15221	25028	2	1



Bell Reducers

IBS No.		Size	Pkg Qty
Black Iron	Galvanized		
15090	25060	1/4 x 1/8	5
15091	25061	3/8 x 1/8	5
15092	25062	3/8 x 1/4	5
15093	25063	1/2 x 1/8	5
15094	25064	1/2 x 1/4	5
15095	25065	1/2 x 3/8	5
15096	25066	3/4 x 1/8	3
15097	25067	3/4 x 1/4	3
15098	25068	3/4 x 3/8	3
15099	25069	3/4 x 1/2	3
15100	25070	1 x 1/4	1
15101	25071	1 x 3/8	1
15102	25072	1 x 1/2	1
15103	25073	1 x 3/4	1
15241	25074	1-1/4 x 1/2	1
15242	25075	1-1/4 x 3/4	1
15243	25076	1-1/4 x 1	1
15244	25077	1-1/2 x 1/2	1
15245	25078	1-1/2 x 3/4	1
15246	25079	1-1/2 x 1	1
15247	25080	1-1/2 x 1-1/4	1
15248	25081	2 x 3/4	1
15249	25082	2 x 1	1
15250	25083	2 x 1-1/4	1
15251	25084	2 x 1-1/2	1



90° Street Elbows

IBS No.		Size	Pkg Qty
Black Iron	Galvanized		
15060	25040	1/8	5
15061	25041	1/4	5
15062	25042	3/8	5
15063	25043	1/2	5
15064	25044	3/4	3
15065	25045	1	1
15230	25046	1-1/4	1
15231	25047	1-1/2	1
15232	25048	2	1



45° Street Elbows

IBS No.		Size	Pkg Qty
Black Iron	Galvanized		
15068	25050	1/8	5
15069	25051	1/4	5
15070	25052	3/8	5
15071	25053	1/2	5
15072	25054	3/4	3
15073	25055	1	1
15235	25056	1-1/4	1
15236	25057	1-1/2	1
15237	25058	2	1



Couplings

IBS No.		Size	Pkg Qty
Black Iron	Galvanized		
15024	25000	1/8	5
15025	25001	1/4	5
15026	25002	3/8	5
15027	25003	1/2	5
15028	25004	3/4	3
15029	25005	1	1
15029A	25006	1-1/4	1
15210	25007	1-1/2	1
15029C	25008	2	1



Pipe Tee

IBS No.		Size	Pkg Qty
Black Iron	Galvanized		
15046	25030	1/8	5
15047	25031	1/4	5
15048	25032	3/8	5
15049	25033	1/2	5
15050	25034	3/4	3
15051	25035	1	1
15052	25036	1-1/4	1
15225	25037	1-1/2	1
15226	25038	2	1



Hex Bushings

IBS No.		Size	Pkg Qty
Black Iron	Galvanized		
15088	25099	1-1/4 x 1/2	1
15089	25100	1-1/4 x 3/4	1
15089A	25101	1-1/4 x 1	1
15260	25102	1-1/2 x 1/2	1
15261	25103	1-1/2 x 3/4	1
15262	25104	1-1/2 x 1	1
15263	25105	1-1/2 x 1-1/4	1
15264	25106	2 x 3/4	1
15265	25107	2 x 1	1
15266	25108	2 x 1-1/4	1
15267	25109	2 x 1-1/2	1



Pipe Fittings - Malleable Iron



Square Head Plugs

IBS No.	Size	Pkg Qty
Black Iron		
15175	1/8	5
15176	1/4	5
15177	3/8	5
15178	1/2	5
15179	3/4	3
15185	1	1
15185A	1-1/4	1
15255	1-1/2	1
15256	2	1



Pipe Caps

IBS No.		Size	Pkg Qty
Black Iron	Galvanized		
15058	25115	1	1
15059	25116	1-1/4	1
15270	25117	1-1/2	1
15271	25118	2	1



Ground Joint Unions

IBS No.	Size	Pkg Qty
151951	1/4	5
151952	3/8	5
15196	1/2	5
15197	3/4	3
151971	1	1

Pipe Fittings - Steel



Hex Bushings

IBS No.	Size	Pkg Qty
15074	1/4 x 1/8	5
15075	3/8 x 1/8	5
15076	3/8 x 1/4	5
15077	1/2 x 1/8	5
15078	1/2 x 1/4	5
15079	1/2 x 3/8	5
15080	3/4 x 1/8	3
15081	3/4 x 1/4	3
15082	3/4 x 3/8	3
15083	3/4 x 1/2	3
15084	1 x 1/4	1
15085	1 x 3/8	1
15086	1 x 1/2	1
15087	1 x 3/4	1



Hex Plugs

IBS No.	Size	Pkg Qty
Zinc Plated		
15018	1/8	5
15019	1/4	5
15020	3/8	5
15021	1/2	5
15022	3/4	3
15023	1	1



Square Head Plugs

IBS No.	Size	Pkg Qty
Zinc Plated		
15180	1/8	5
15181	1/4	5
15182	3/8	5
15183	1/2	5
15184	3/4	3
—	1	1
—	1-1/4	1
—	1-1/2	1
—	2	1



Socket Head Plugs

IBS No.	Size	Pkg Qty
Zinc Plated		
15190	1/8	5
15191	1/4	5
15192	3/8	5
15193	1/2	5
15194	3/4	3
15195	1	1



Pipe Caps

IBS No.	Size	Pkg Qty
Steel		
15053	1/8	5
15054	1/4	5
15055	3/8	5
15056	1/2	5
15057	3/4	5
15057A	1	5



Merchant Couplings

IBS No.	Size	Pkg Qty
15201	1/8	5
15202	1/4	5
15203	3/8	5
15204	1/2	5
15205	3/4	3
15206	1	1
15207	1-1/4	1
15208	1-1/2	1
15209	2	1

STEEL PIPE FITTINGS



IBS, INCORPORATED

Pipe Fittings NPT Steel - 150 lb N01

Black Welded Steel Nipples - SCH 40



Length	MPT Size				Pkg Qty	MPT Size					Pkg Qty	Length
	1/8	1/4	3/8	1/2		3/4	1	1-1/4	1-1/2	2		
Close	15105	15115	15126	15135	5	15146	15157	15200	15315	15350	1	Close
1-1/2	15106	15116	15127	15136	5	15147					1	1-1/2
2	15107	15117	15128	15137	5	15148	15158	15300	15316		1	2
2-1/2	15108	15118	15129	15138	5	15149	15159	15301	15317	15351	1	2-1/2
3	15109	15119	15130	15139	5	15150	15160	15302	15318	15352	1	3
3-1/2	15110	15120	15131	15140	5	15151	15161	15303	15319	15353	1	3-1/2
4	15111	15121	15186	15141	5	15152	15170	15304	15320	15354	1	4
4-1/2		15122	15187	15242	5	15153	15171	15305	15321	15355	1	4-1/2
5	15112	15123	15132	15143	5	15154	15172	15306	15322	15356	1	5
5-1/2	15112A	15124	15133	15144	5	15155	15173	15307	15323	15357	1	5-1/2
6	15113	15125	15134	15145	5	15156	15174	15308	15324	15358	1	6
10				15198	5							10

Galvanized Steel Nipples (N02)



Length	MPT Size				Pkg Qty	MPT Size					Pkg Qty	Length
	1/8	1/4	3/8	1/2		3/4	1	1-1/4	1-1/2	2		
Close	25130	25145	25160	25175	5	25190	25205	25220	25230	25240	1	Close
1-1/2	25131	25146	25161	25176	5	25191					1	1-1/2
2	25132	25147	25162	25177	5	25192	25206	25221	25231		1	2
2-1/2	25133	25148	25163	25178	5	25193	25207	25222	25232	25241	1	2-1/2
3	25134	25149	25164	25179	5	25194	25208	25223	25233	25242	1	3
3-1/2	25135	25150	25165	25180	5	25195	25209	25224	25234	25243	1	3-1/2
4	25136	25151	25166	25181	5	25196	25210	25225	25235	25244	1	4
4-1/2	25137	25152	25167	25182	5	25197	25211	25226	25236	25245	1	4-1/2
5	25138	25153	25168	25183	5	25198	25212	25227	25237	25246	1	5
5-1/2	25139	25154	25169	25184	5	25199	25213	25228	25238	25247	1	5-1/2
6	25140	25155	25170	25185	5	25200	25214	25229	25239	25248	1	6

Black Extra-Heavy Nipples - SCH 80 (N03)



Length	MPT Size				Pkg Qty	MPT Size					Pkg Qty	Length
	1/8	1/4	3/8	1/2		3/4	1	1-1/4	1-1/2	2		
Close	35130	35145	35160	35175	5	35190	35205	35220	35230	35240	1	Close
1-1/2	35131	35146	35161	35176	5	35191					1	1-1/2
2	35132	35147	35162	35177	5	35192	35206	35221	35231		1	2
2-1/2	35133	35148	35163	35178	5	35193	35207	35222	35232	35241	1	2-1/2
3	35134	35149	35164	35179	5	35194	35208	35223	35233	35242	1	3

STEEL PIPE FITTINGS

IBS, INCORPORATED

Assortments Z02 & Z06



Steel Pipe Fittings (Z02)

IBS No. 139R • 30 ITEMS - 64

PIECES

Arranged in a 32 compartment metal drawer



IBS, Inc.						Steel Pipe Fittings	
Assortment No. 139R							
15021 1/2 HEX PLUG NPT ZP	15071 1/2 X 4SDGR ST. ELB 150+ NPT BMT	15063 1/2 90DGR ST. ELB 150+ NPT BMT	15027 1/2 COUPLER 150+ NPT RMT	15138 1/2 X CLOSE (1- 1/8) BLACK	15136 1/2 X 1-1/2 BLACK NIPPLE	15077 3/8 X 1/8 HEX BUSHING NPT ZP	
15020 3/8 HEX PLUG NPT ZP	15070 3/8 4SDGR ST. ELB 150+ NPT BMT	15062 3/8 90DGR ST. ELB 150+ NPT BMT	15026 3/8 COUPLER 150+ NPT BMT	15126 3/8 X CLOSE (1) BLACK NIPPLE	15127 3/8 X 1-1/2 BLACK NIPPLE	15076 3/8 X 1/4 HEX BUSHING NPT ZP	
15019 1/4 HEX PLUG NPT ZP	15069 1/4 4SDGR ST. ELB 150+ NPT BMT	15061 1/4 90DGR ST. ELB 150+ NPT BMT	15025 1/4 COUPLER 150+ NPT BMT	15115 1/4 X CLOSE (7/8) BLACK NIPPLE	15116 1/4 X 1-1/2 BLACK NIPPLE	15078 3/8 X 1/4 HEX BUSHING NPT ZP	15079 1/2 X 3/8 HEX BUSHING NPT ZP
15018 1/8 HEX PLUG NPT ZP	15068 1/8 4SDGR ST. ELB 150+ NPT BMT	15060 1/8 90DGR ST. ELB 150+ NPT BMT	15021 1/8 COUPLER BLACK NPT STEEL	15108 1/8 X CLOSE (3/4) BLACK NIPPLE	15106 1/8 X 1-1/2 BLACK NIPPLE	15074 1/4 X 1/8 HEX BUSHING NPT ZP	15078 1/2 X 1/4 HEX BUSHING NPT ZP

Black Malleable Iron Pipe Fittings (Z06)

IBS No. 157P • 40 ITEMS
- 138 PIECES

Arranged in a 40 compartment metal bin



1/4 x 1/8 Hex Bushing 15074	3/8 x 1/4 Hex Bushing 15076	1/2 x 1/4 Hex Bushing 15078	1/2 x 3/8 Hex Bushing 15079	3/4 x 1/2 Hex Bushing 15083	1/4 Tee 15047	3/8 Tee 15048	1/2 Tee 15049
1/8 Elbow 15030	1/4 Elbow 15031	3/8 Elbow 15032	1/2 Elbow 15033	1/8 Street Elbow 15060	1/4 Street Elbow 15061	3/8 Street Elbow 15062	1/2 Street Elbow 15063
1/4 x 1/8 Reducer 15090	3/8 x 1/4 Reducer 15092	1/2 x 3/8 Reducer 15095	3/4 x 1/2 Reducer 15099	1/8 Coupling 15201	1/4 Coupling 15202	3/8 Coupling 15203	1/2 Coupling 15204
1/8 Plug 15018	1/4 Plug 15019	3/8 Plug 15020	1/2 Plug 15021	3/4 Plug 15022	1/8 Close Nipple 15105	1/8 x 1-1/2 Nipple 15106	1/4 Nipple 15115
1/4 x 1-1/2 Nipple 15116	1/4 x 2 Nipple 15117	3/8 Close Nipple 15126	3/8 x 1-1/2 Close Nipple 15127	3/8 x 2 Nipple 15128	1/2 Nipple 15135	1/2 x 2 Nipple 15137	1/2 x 3 Nipple 15139

Steel & Iron Pipe Fittings (Z06)

IBS No. 151S • 40 Items - 295
Pieces

Arranged in an 18 drawer cabinet



Close Nipples

1/8" through 1/2"

Long Nipples

1/8" through 1/2" x 1 1/2" long

Hex Bushings Bell Reducers

1/4" x 1/8"
3/8" x 1/8"
3/8" x 1/4"
1/2" x 1/4"
1/2" x 3/8"

1/4" x 1/8"
3/8" x 1/4"
1/2" x 3/8"

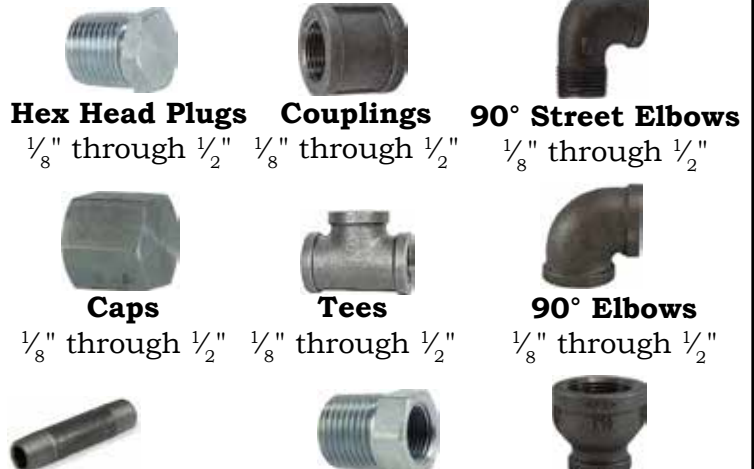

Hex Head Plugs

1/8" through 1/2"

Couplings

1/8" through 1/2"

90° Street Elbows

1/8" through 1/2"

Caps

1/8" through 1/2"

Tees

1/8" through 1/2"

90° Elbows

1/8" through 1/2"

STEEL PIPE FITTINGS



IBS, INCORPORATED

Assortments Z06

Black Malleable Iron Pipe Fittings

IBS No. 154P • 72 Items - 349 Pieces

Arranged in a (2) 40 hole metal bins



S
T
E
E
L

P
I
P
E

F
I
T
T
I
N
G
S

1/8 Hex Plug 15018	1/4 Hex Plug 15019	3/8 Hex Plug 15020	1/2 Hex Plug 15021	3/4 Hex Plug 15022	1" Hex Plug 15023	1/8 Tee 15046	1/4 Tee 15047
1/8 Coupler 15024	1/4 Coupler 15025	3/8 Coupler 15026	1/2 Coupler 15027	3/4 Coupler 15028	1" Coupler 15029	3/8 Tee 15048	1/2 Tee 15049
1/8 90° Elbow 15030	1/4 90° Elbow 15031	3/8 90° Elbow 15032	1/2 90° Elbow 15033	3/4 90° Elbow 15034	1" 90° Elbow 15035	3/4 Tee 15050	1" Tee 15051
1/8 90° Strt Elbow 15060	1/4 90° Strt Elbow 15061	3/8 90° Strt Elbow 15062	1/2 90° Strt Elbow 15063	3/4 90° Strt Elbow 15064	1" 90° Strt Elbow 15065	1/8 Cap 15053	1/4 Cap 15054
OVER STOCK	OVER STOCK	OVER STOCK	OVER STOCK	OVER STOCK	OVER STOCK	OVER STOCK	OVER STOCK
1/4 x 1/8 Hex Bush- ing 15074	3/8 x 1/8 Hex Bushing 15075	3/8 x 1/8 Hex Bushing 15076	1/2 x 1/8 Hex Bushing 15077	1/2 x 1/4 Hex Bushing 15078	1/2 x 3/8 Hex Bushing 15079	3/8 Cap 15055	1/2" Cap 15056
3/4 x 1/4 Hex Bush- ing 15081	3/4 x 3/8 Hex Bushing 15082	3/4 x 1/2 Hex Bushing 15083	1 x 3/8 Hex Bushing 15085	1 x 1/2 Hex Bushing 15086	1 x 3/4 Hex Bushing 15087	3/8 Cap 15057	1" Cap 15058
1/8 Close Nipple 15105	1/4 Close Nipple 15115	3/8 Close Nipple 15126	1/2 Close Nipple 15135	3/4 Close Nipple 15146	1/8x1-1/2 Black Nipple 15106	1/4x1-1/2 Black Nipple 15116	3/8x1-1/2 Black Nipple 15127
1/2 x 1-1/2 Nipple 15136	3/8 x 2 Nipple 15128	1/2 x 2 Nipple 15137	3/4 x 2 Nipple 15148	1 x 2 Nipple 15158	3/4 x 2-1/2 Nipple 15149	1 x 2-1/2 Nipple 15159	1/4 x 1/8 Bell Reducer 15090
3/8 x 1/4 Bell Reducer 15092	1/2 x 1/8 Bell Reducer 15093	1/2 x 1/4 Bell Reducer 15094	1/2 x 3/8 Bell Reducer 15095	3/4 x 3/8 Bell Reducer 15098	3/4 x 1/2 Bell Reducer 15099	1 x 1/2 Bell Reducer 15102	1 x 3/4 Bell Reducer 15103





Brass Fittings

A

Assortments

- Air Brake Fittings for Hose O-24
 - Air Brake Fitting Assortment for 1/2" Hose O-25
 - Air Brake Fitting Assortment for 3/8" Hose O-25
 - Gladhand Seals Assortment O-26
- Nylon Tubing
 - 192R • 1/4 & 3/8 O-22
 - 193R • 1/2" O-22
 - 217R • 5/8" O-22
- Air Trans Fittings
 - Eaton-Fuller O-29
- Brass
 - SAE 45° Brass Flared Fittings
 - 104-LGR • 1/2 & 5/8 O-19
 - 104-SML • j1/4, 5/16 & 3/8" O-19
 - 142R O-18
 - SAE 45° Flare Brass Fittings 1/2" & 5/8" O-19
 - SAE 45° Flare Brass Fittings 1/4," 5/16," 3/8" O-19
 - SAE 45° Flare Brass Fittings Assortment O-18
- Brass Pipe Fittings
 - 103R O-9
 - 103R-LGR O-9
 - 103R-SML O-9
 - 158P O-8
- Composite Body DOT Air Brake Fittings
 - 829R O-47
- Compression Fittings O-12
- Draincocks & Valves O-58, O-64
- Fittings, Poly-Push
 - Push-On Hose Fitting Assortments
 - 332R, 333R O-55
- For-Seal to Straight Thread O-Ring Fittings O-64
- Hose
 - Hydraulic Hose Shields O-83, O-86
 - Spiral Hose Shields O-84
- Hydraulic Fittings
 - 40 Hole Hydraulic Fitting
 - Bin Assortment
 - 251P O-69
 - 40 Hole Starter Hydraulic Fitting
 - Bin Assortment
 - 250P O-69
- Boss and For-Seal Plugs and Caps
 - 736R O-74
- Boss O-Ring Fittings
 - 737R O-72
- High Pressure
 - Straight Thread BOSS O-Ring O-72
- Hydraulic O-Ring O-74
- Hydraulic Quick Couplers
 - 825R O-86
- Medium Pressure
 - Field Attachable Fittings O-76
- Inverted Flare Fittings O-15
- JIC Fitting Adapters
 - 738R O-64

- Pipe Thread Protectors O-87
- Poly-Matic Nickel Plated Brass Fittings O-38
 - Poly-Matic DOT Air Brake Fittings
 - 180R O-43
 - 181R O-43
 - 334R O-44
 - 335R O-44
- Poly-Push Fractional Composite Fittings
 - 336R, 337R O-51
- Push-On Hose Fittings, L.P.
 - 111R, 112R O-32, O-34
- SAE 37° JIC Flare 90o Elbows
 - 846R O-64

B

Brass Facts O-4

- Brass Ferrules / Sleeves O-5
- Dryseal Pipe Threads O-4
- Manufacturing of Extruded Fittings O-4
- Numbering System O-4
- Pipe Fitting Sizing O-4

Brass Pipe Fittings

- 45° Street Elbow O-8
- 90° Elbow O-8
- 90° Street Elbow O-8
- 90° Union Tee O-8
- Close Nipples O-6
- Hex Head Plugs O-6
- Hex Pipe Bushings O-7
- Hex Pipe Nipples O-7
- Hex Pipe Reducing Nipples O-7
- Long Nipples O-7
- Male Branch Tee O-8
- Male Run Tee O-8
- Pipe Adapters O-7
- Pipe Caps O-6
- Pipe Coupling O-7
- Pipe Reducer Coupling O-7
- Square Head Plugs O-6

C

Composite DOT Push Connect Fittings O-45

- 45DGR Male Elbow O-46
- 90DGR Male Elbow O-46
- Bulkhead Union O-46
- Female Connector O-46
- Male Branch Tee O-46
- Male Connector O-46
- Straight Union O-45
- Union 90DGR Elbow O-45
- Union Tee O-45

Compression Fittings

- Connectors O-11
- Female Connectors O-11
- Inserts for Plastic Tubing (Not for Air Brake) O-10
- Male Elbows O-11
- Nuts O-11
- Sleeves O-10
- Unions O-11
- Union Tees O-11

FITTINGS



D

Drains & Valves

- Drain Cocks O-56
- Angle Bib Drain O-56, O-57
- External Seat O-56
- Ground Plug Drain O-57
- Internal Seat O-56, O-57
- Truck Drain (O08) O-57
- Shut-Off
 - Female Pipe Shut-Off O-57
 - Male to Female Pipe Shut-Off O-57
 - Marine Shut-Off: M to F Pipe O-57
 - Pipe to Hose Shut-Off O-56
 - Truck Shut-Off: M to F Pipe O-57
- Valves
 - Air Tank Drain Valve O-56
 - Engine Oil Drain Valves O-88
 - Full Bore Brass Ball Valves O-58
 - Internal Seat Drain Valve O-56
 - Needle Valve O-57

F

- Female Connector O-62**
- Fittings, Air Brake O-20**
 - for Copper Tubing O-27
 - 45° Male Elbow O-28
 - 90° Male Elbow O-28
 - Female Connector O-27
 - Male Connector O-27
 - Male Run Tee O-28
 - Nuts O-27
 - Sleeve O-27
 - Unions O-27
 - Union Tee O-28
- for Hose O-23
 - Adapters O-23
 - Assembly Information O-23
 - Brass Nut with Spring Guard O-24
 - Draincock O-24
 - Female Connectors O-23
 - Female Connectors with Adapter O-23
 - Gladhand Couplings O-26
 - Gladhand Coupling Seals O-26
 - Hose Mender O-24
 - Insert O-24
 - Male Connectors O-23
 - Male Connectors with Spring Guard O-23
 - Nuts O-24
 - Sleeves O-24
- Nylon Tubing
 - 45° Male Elbow O-21
 - 90° Male Elbow O-21
 - Air Brake Tees O-21
 - General Information O-20
 - Insert O-20
 - Male Connector O-21
 - Nut O-20, O-21
 - Sleeve O-20
 - Union O-20
- Fittings, Air Trans**
 - Eaton-Fuller O-29

Fittings, Poly-Matic

- Nickel Plated Brass
 - General Information O-35
- Nickel Plated Brass, DOT
 - 90° Union Elbows O-41, O-42
 - 360° Male Swivel Elbows O-41
 - Bulkhead Unions O-42
 - Male 45° Swivel Elbows O-42
 - Male Connectors O-41
 - Male Swivel Branch Tees O-42
 - Unions O-42
 - Union Tees O-42
- Nickel Plated Brass, Fractional
 - 360° Male Swivel Elbows O-37
 - Male 90° Elbows O-37
 - Male Connectors O-36
 - Male Swivel Branch Tees O-37, O-38
 - Union Elbows O-36
 - Union Reducers O-36
 - Unions O-36
- Nickel Plated Brass, Metric
 - 360° Swivel Elbows O-39
 - Male Connectors O-39
 - Straight Unions O-39
 - Union Elbows O-39
 - Union Tees O-40

Fittings, Poly-Matric

- Nickel Plated Brass, Metric
 - Union Tees O-40

Fittings, Poly-Push O-48

- Composite, Fractional
 - 90° Union Elbows O-49
 - Male Swivel Branch Tees O-50
 - Male Swivel Elbows O-49
 - Poly-Push Union Reducer O-49
 - Poly-Push Unions O-49
 - Poly-Push Union Tees O-50
 - Poly-Push Union "Y" Reducer O-50
- Composite, Metric
 - 90° Union Elbows O-53
 - Male Connectors — Nickel Plated Brass O-52
 - Male Swivel Branch Tees O-53
 - Male Swivel Elbows O-52
 - Reducing "Y" Unions O-54
 - Straight Reducing Unions O-54
 - Straight Unions O-54
 - Straight "Y" Unions O-54
 - Union Tees O-53

G

Ground Plug Shut-Offs O-57

H

Hose

- DOT Air Brake Hose O-25, O-79
- General Purpose Air Hose O-25, O-79
- High Pressure
 - SAE 100R1 Hydraulic Hose O-81
 - SAE 100R2 Hydraulic Hose O-81
 - SAE 100R16 Hydraulic Hose O-81
- Hydraulic Hose Shields O-83
- Low Pressure



SAE 30R7 Fuel Line Hose O-79
Medium Pressure
SAE 100R5 Hydraulic Hose O-82
Spiral Hose Wrap O-84
Standard Heater Hose O-80
Yellow Belly PVC Air Hose
High Visibility w/M NPT Rigid Ends O-80

H.P. Steel Pipe Fittings
90° Street Elbow O-59
Bushings O-59
Couplings O-59
Hex Head Plugs O-59
Hex Nipples O-59

Hydraulic Fittings
High Pressure
37° JIC Female 45° Bent Tube Swivel O-67
37° JIC Female 90° Bent Tube Swivel O-67
37° JIC Female Swivel O-66
37° JIC Male Pipe Rigid O-66
BOSS O-Ring Hex Head Plug O-73
Female Pipe NPTF Swivel O-68
For-Seal Caps O-73
For-Seal Male Pipe Adapter O-74
For-Seal O-Rings O-73
For-Seal Plugs O-73
ISO-A Female Pipe Couplers & Plugs O-86
JIC 37° 90° Elbow Straight Thread BOSS O-Ring Connector O-71
JIC 37° Female Pipe Swivel to Male Pipe O-70
JIC 37° Female Pipe Swivel to Male Pipe 90° O-70
JIC 37° Straight Thread BOSS O-Ring Connector O-71
Male Boss O-Ring Rigid O-68
Male Pipe NPTF Rigid O-65
Male Pipe NPTF Swivel O-65
O-Ring Face Seal Female Swivel O-68
Split Flange O-Rings O-74
Straight Thread BOSS O-Ring O-71

Medium Pressure
Field Attachable
Female SAE 45° Swivel 90° Elbow O-76
Male Inverted SAE 45° Swivel 90° Elbow O-76
MALE NPTF Pipe - Rigid Straight O-75
SAE 37° Female Swivel O-75
SAE 45° Female Swivel O-75
SAE Male Inverted Swivel O-75

I

Inverted Flare Fittings
45° Male Elbows O-14
90° Male Elbows O-14
Female Connectors O-14
Inverted Unions O-14
Male Connectors O-14
Steel Inverted Nuts O-13
Steel Inverted Plug O-14
Tube Nuts O-13

J

JIC Male to Female Swivel Adapter O-63
JIC Male to Male Boss O-Ring O-62

P

Pipe Caps O-63
Pipe Thread Protectors O-87
Push-On Hose Fittings, L.P.
Female Inverted Rigid O-31
Female Long Barbed Hose End O-33
Female Swivel O-31
General Information O-30
Hose Mender O-30
Inverted Male Swivel O-31
Long Barbed Union O-33
Male Long Barbed Hose End O-33
Male Pipe Rigid O-30
SAE 37° (JIC) Female Swivel O-31
SAE 45° Flare Female Swivel O-31
SAE 45° Flare Male Rigid O-31

S

SAE 37° (JIC) Flared Fittings
45° For-Seal to Straight Thread O-Ring Connectors O-63
45° Male Elbows O-61
90° Male Elbows O-63
900 For-Seal to Straight Thread O-Ring Connectors O-63
Boss O-Ring 37DGR JIC Swivel Adapter O-63
Caps O-60
Female Connectors O-62
Hex Union O-62
JIC 90° Male Elbows O-60
JIC 90° Union Elbow O-62
JIC to 45o Elbows O-63
Male Connectors O-61
Male For-Seal to Straight Thread O-Ring Connectors O-62
Male JIC to Female Swivel Adapter O-63
Male O-Ring Swivel Adapter O-62
Male to Male Boss O-Ring O-62
Pipe Caps O-63
Plugs O-60
Union Tees O-62

SAE 45° Flared Fittings
Caps & Plugs O-17
Female Connector O-18
Flare Nut O-17
Flare Union O-17
Information O-16
Long Nut O-17
Male 45° Elbow O-18
Male 90° Elbow O-18
Male Connector O-17
Union Tee O-17

T

Tools
Hydraulic Crimper O-85

Tubing O-77
Nylon Pneumatic
Fractional O-77
Metric O-78
Vacuum O-80



IBS, INCORPORATED

Brass Facts

Manufacturing of Extruded Fittings

Hexagon, round and shaped bars are extruded in the configuration required, drawn to size, cut to length and straightened. First a solid round billet (8 to 12 inches in diameter) is heated to the pliable state and forced by pressure of approximately 80,000 pounds per square inch through a die. The resulting continuous length of bar is cooled and then drawn through dies to the desired external size. (The drawing process also controls the temper.) After straightening, the bar is ready for machining.

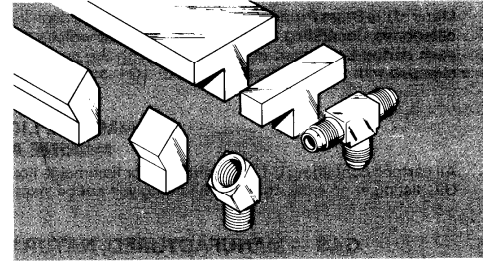

The process produces a dense, nonporous material somewhat stronger in the longitudinal direction due to an orientated flow of the grain.

Dryseal Pipe Threads

Pipe threads are made to the Dryseal USA (American)

- Standard Taper Pipe Thread* standard, known as the NPTF. Dryseal pipe threads, unlike other types of threads, seal joints pressure tight.

The Dryseal pipe thread roots are wider than the crests. When the threads are wrench-tight, the roots crush the sharper crests of the mating threads. This forms a metal-to-metal seal. Dryseal threads improve sealing characteristics but a thread sealant is recommended.

*Formerly Dryseal American (National Standard.)

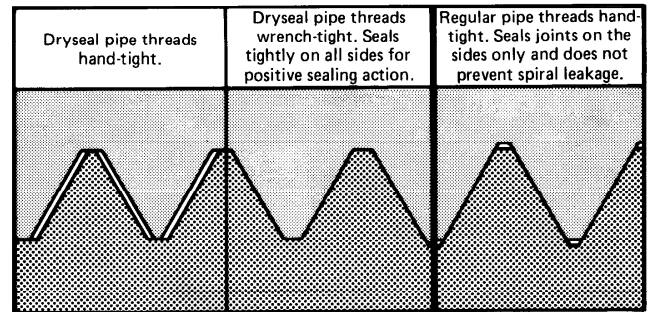

Numbering System

Fittings are identified by a series of numbers separated by the letter 'x'.

- A** The number preceding the 'x' indicates the type of fitting. See table 1 below for additional data.
- B** The second number is the tube and/or pipe size in sixteenths of an inch. When a pipe thread for a given tube size follows the SAE (Society of Automotive Engineers) standard as shown in Table 2, no other number is required. Example: 48x6 = SAE 45° Flare Male Connector - 3/8" tube, 1/4" male pipe.
- C** If the pipe size is not to the SAE Standard, another 'x' is added followed by the pipe size indicated in sixteenths of an inch. Example: 1/8" is equal to 2/16" or x2 suffix.

TABLE 1

Type	Example MALE Connector	Example FEMALE Connector
45° Flare	48	46
Compression	68	66
Air Brake (Nylon)	1468	1466
Air Brake (Copper)	1368	1366
(JIC) Flare	C5205	C5255
Inverted Flare	202	252

TABLE 2

Tube Size	PIPE THREADS	
	Brass	Steel
x2	1/8	1/8
x3	3/16	1/8
x4	1/4	1/8
x5	5/16	1/8
x6	3/8	1/4
x7	7/16	1/4
x8	1/2	3/8
x10	5/8	1/2
x12	3/4	3/4
x14	7/8	3/4
x16	1	1
x20	1-1/4	NS
x24	1-1/2	NS
x30	2	NS

48 X 6 X 2
A B C

Pipe Fitting Sizing

Nominal pipe sizes do not agree with either the I.D., O.D., or thread sizes. To determine pipe size (up to 1-1/4") measure the diameter of the threads and subtract 1/4". For example, subtract 1/4" from a 1" pipe to obtain the nominal pipe size of 3/4".

Brass Ferrules / Sleeves

Illustrated here are three Ferrules/Sleeves which are similar in appearance yet have distinctly different uses. Use extra caution when selecting one for a job to be certain that you are choosing the proper ferrule/sleeve. If a compression ferrule/sleeve is used in an air brake fitting it could result in a leak that could reduce braking ability. This poses an extreme danger not only to vehicle operators but to others using the highways as well. The danger to your company is also very great. If an accident occurs as a result of installation of an incorrect ferrule/sleeve your insurance company can disclaim any liability.

THIS MEANS THAT YOUR COMPANY MAY BE HELD LIABLE FOR ALL DAMAGES!

Note: D.O.T. regulations specify that only sleeves #1 & #2 are acceptable in air brake systems.

#1

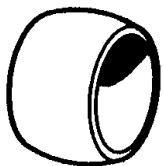

**Air Brake Sleeve
for Copper Tubing**

Has a continuously smooth contour throughout.

#2

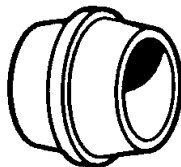

**Air Brake Sleeve
for Nylon Hose**

Has a raised, flat ribbed flange across its mid-section.

#3



**Compression
Sleeve**

Has a distinct flat band across its mid-section.

Know The Difference! It's The Law!

PROTECT YOURSELF!

1. Use a separate storage cabinet for all air brake fittings and ferrules. Use another cabinet for all regular brass fittings.
2. Keep cabinets as far away from each other as practical.
3. Teach all maintenance and parts personnel the difference between the three ferrules / sleeves. Be sure to impress upon them the dangers resulting from an error.
4. Give your IBS, Inc. Sales Representative permission to inspect your brass fitting stock on every visit to make sure it is located and labeled properly.

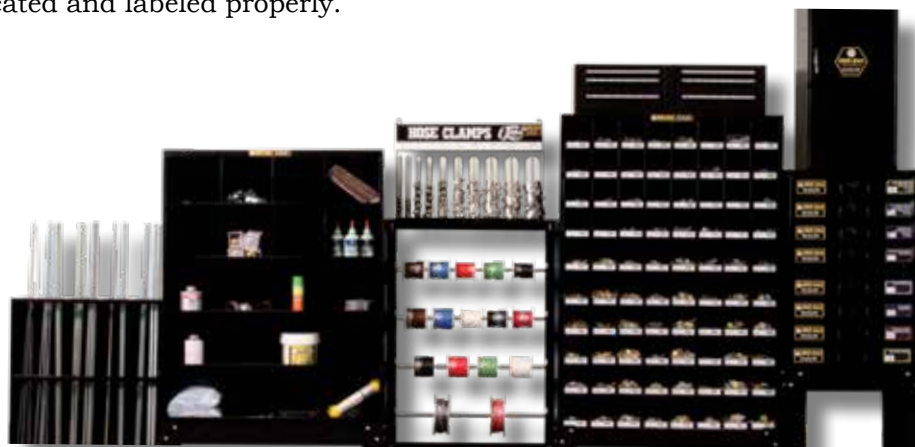



IBS, INCORPORATED

Pipe Fittings O06

Pipe Fittings

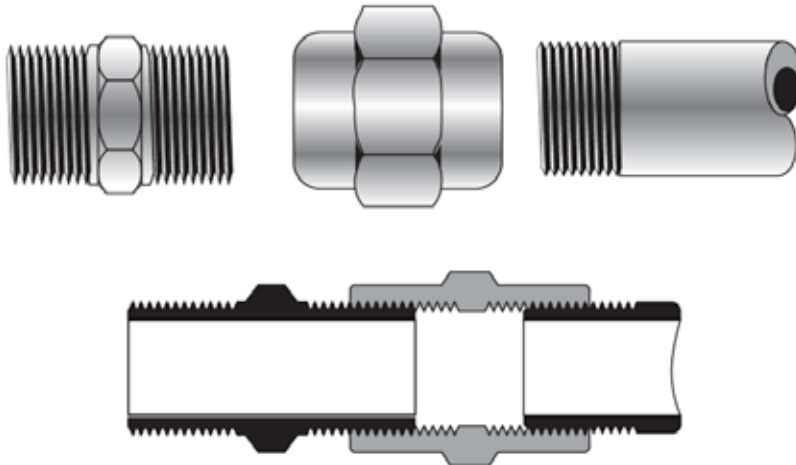

Pipe Size	1/8	1/4	3/8	1/2	3/4
Thread Size	1/8-27	1/4-18	3/8-18	1/2-14	3/4-14

- **Advantages**
 - Dryseal pipe threads.
 - Large range of sizes and configurations.
- **Use with** grease, fuels, refrigeration, instrumentation, and hydraulic systems.
- **Use with operating pressures up to 1200 psi.**
- **Offers a fair resistance to vibration.**
- Can be used in temperatures ranging from -65° F to +250°F at 1000 psi.
- **Use with brass, bronze, and iron pipe.**
- **Listed by Underwriter's Laboratories** for fuel equipment, refrigeration, and gas.
- **Meets specifications and standards of ASA, ASME and SAE**

FITTINGS

Square Head Plugs

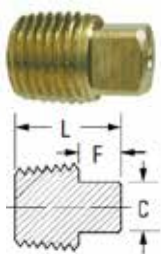

IBS No.	MPT	C	F	L	Qty
3151X2	1/8	.28	.24	.58	10
3151X4	1/4	.37	.29	.74	10
3151X6	3/8	.43	.32	.82	5
3151X8	1/2	.56	.39	.99	5
3151X12	3/4	.62	.43	1.12	5

Pipe Caps



IBS No.	FPT	Hex	Qty
3129X2	1/8	9/16	10
3129X4	1/4	11/16	10
3129X6	3/8	13/16	10
3129X8	1/2	15/16	5
3129X12	3/4	1-1/4	5

Hex Head Plugs

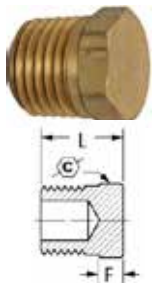

IBS No.	MPT	C	L	Qty
3152X2	1/8	7/16	.57	10
3152X4	1/4	9/16	.62	10
3152X6	3/8	11/16	.72	5
3152X8	1/2	7/8	.78	5
3152X12	3/4	1-1/16	.88	5

Close Nipples

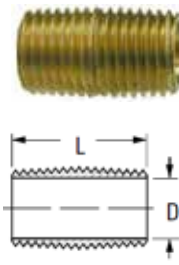

IBS No.	FPT	L	Qty
3326X2	1/8	.75	10
3326X4	1/4	.88	10
3326X6	3/8	1.00	10
3326X8	1/2	1.12	5
3326X12	3/4	1.38	5

IBS, INCORPORATED

Pipe Fittings O06



Hex Pipe Nipples

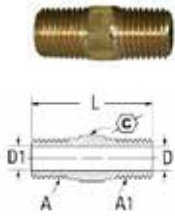

IBS No.	MPT	Hex (C)	L	D	Qty
3325X2	1/8	7/16	.97	.219	10
3325X4	1/4	9/16	1.38	.312	10
3325X6	3/8	11/16	1.41	.438	10
3325X8	1/2	7/8	1.81	.562	5
3325X12	3/4	1-1/16	1.94	.750	5

Hex Pipe Reducing Nipples

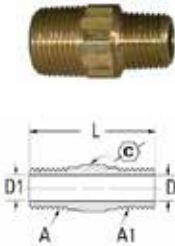

IBS No.	MPT	Hex (C)	L	Qty
3325X4X2	1/4 X 1/8	9/16	1.19	10
3325X6X2	3/8 X 1/8	11/16	1.22	10
3325X6X4	3/8 X 1/4	11/16	1.41	5
3325X8X4	1/2 X 1/4	7/8	1.62	5
3325X8X6	1/2 X 3/8	7/8	1.62	5

Long Nipples

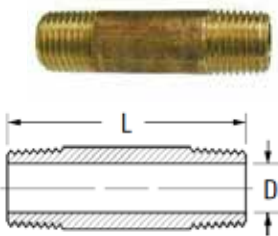

IBS No.	MPT	L	Qty
3327X2	1/8	1-1/2"	10
3328X2	1/8	2"	5
3330X2	1/8	3"	5
3327X4	1/4	1-1/2"	10
3328X4	1/4	2"	5
3329X4	1/4	2-1/2"	5
3330X4	1/4	3"	5
3328X6	3/8	2"	5
3329X6	3/8	2-1/2"	5
3330X6	3/8	3"	5
3328X8	1/2	2"	5
3329X8	1/2	2-1/2"	5
3330X8	1/2	3"	5

Pipe Coupling

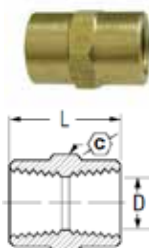

IBS No.	FPT	Hex	D	L	Qty
3300X2	1/8	9/16	.339	.75	10
3300X4	1/4	3/4	.438	1.12	10
3300X6	3/8	7/8	.578	1.12	5
3300X8	1/2	1-1/16	.703	1.50	5
3300X12	3/4	1-1/4	.906	1.53	5

Pipe Reducer Coupling

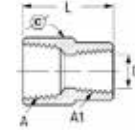

IBS No.	FPT	Hex	D	L	Qty
3300X4X2	1/4 X 1/8	3/4	.339	.96	10
3300X6X2	3/8 X 1/8	7/8	.339	.94	10
3300X6X4	3/8 X 1/4	7/8	.438	1.16	5
3300X8X4	1/2 X 1/4	1-1/16	.438	1.28	5
3300X8X6	1/2 X 3/8	1-1/16	.562	1.38	5

Pipe Adapters

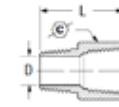

IBS No.	FPT	MPT	Hex	D	L	Qty
3200X2	1/8	1/8	9/16	.219	.88	10
3200X4X2	1/4	1/8	3/4	.219	1.06	10
3200X4	1/4	1/4	3/4	.312	1.25	10
3200X6X4	3/8	1/4	7/8	.312	1.25	5
3200X6	3/8	3/8	7/8	.438	1.25	5
3200X6X2	3/8	1/8	13/16	.219	1.00	5
3200X8	1/2	1/2	1-1/16	7.03	1.66	5
3200X8X4	1/2	1/4	1-1/16	.312	1.66	5
3200X8X6	1/2	3/8	1-1/16	.438	1.47	5
3200X12X6	3/4	3/8	1-1/4	.438	1.59	5
3200X12X8	3/4	1/2	1-3/8	.703	1.69	5

Hex Pipe Bushings

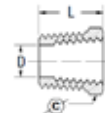

IBS No.	MPT	FPT	Hex	D	L	Qty
3220X4X2	1/4	1/8	5/8	.339	.59	10
3220X6X2	3/8	1/8	11/16	.328	.75	10
3220X6X4	3/8	1/4	11/16	.438	.69	10
3220X8X2	1/2	1/8	7/8	.530	.75	5
3220X8X4	1/2	1/4	7/8	.438	.75	5
3220X8X6	1/2	3/8	7/8	.562	.75	5
3220X12X2	3/4	1/8	1-1/16	.339	.94	5
3220X12X4	3/4	1/4	1-1/16	.438	.94	5
3220X12X6	3/4	3/8	1-1/8	.562	.94	5
3220X12X8	3/4	1/2	1-1/8	.703	.94	5

FITTINGS



IBS, INCORPORATED

Pipe Fittings O06

F I T T I N G S

45° Street Elbow



IBS No.	MPT	FPT	C	Qty
3350X2	1/8	1/8	9/16	5
3350X4	1/4	1/4	11/16	5
3350X6	3/8	3/8	13/16	5
3350X8	1/2	1/2	1	5
3350X12	3/4	3/4	1-1/4	5

90° Elbow



IBS No.	FPT	C	Qty
3500X2	1/8	9/16	10
3500X4	1/4	11/16	10
3500X6	3/8	3/4	5
3500X8	1/2	1	5
3500X12	3/4	1-1/4	5

90° Street Elbow



IBS No.	MPT	FPT	C	Qty
3400X2	1/8	1/8	9/16	5
3400X4X2	1/4	1/8	11/16	5
3400X4	1/4	1/4	11/16	5
3400X6	3/8	3/8	13/16	5
3400X8	1/2	1/2	1	5
3400X12	3/4	3/4	1-1/4	5

90° Union Tee

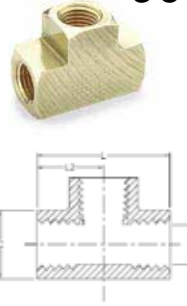

IBS No.	FPT	C	Qty
3700X2	1/8	9/16	5
3700X4	1/4	11/16	5
3700X6	3/8	13/16	5
3700X8	1/2	1	5
3700X12	3/4	1-1/4	5

Male Branch Tee



IBS No.	MPT	FPT	L	Qty
3600X2	1/8	1/8	1.10	10
3600X4	1/4	1/4	1.56	10
3600X6	3/8	3/8	1.68	5
3600X8	1/2	1/2	2.18	5
3600X12	3/4	3/4	2.32	5

Male Run Tee

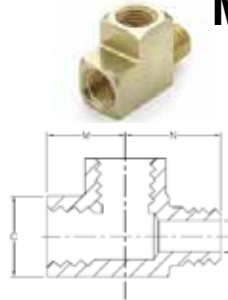

IBS No.	MPT	FPT	C	Qty
3750X2	1/8	1/8	9/16	5
3750X4	1/4	1/4	11/16	5
3750X6	3/8	3/8	13/16	5
3750X8	1/2	1/2	1	5
3750X12	3/4	3/4	1-1/4	5

1/4 x 1/8 Reducing Coupling 3300x4x2	3/8 x 1/8 Reducing Coupling 3300x6x2	3/8 x 1/4 Reducing Coupling 3300x6x4	1/2 x 3/8 Reducing Coupling 3300x8x6	1/8 Coupling 3300x2	1/4 Coupling 3300x4	3/8 Coupling 3300x6	1/2 Coupling 3300x8
1/4 x 1/8 Bushing 3220x4x2	3/8 x 1/8 Bushing 3220x6x2	3/8 x 1/4 Bushing 3220x6x4	1/2 x 1/8 Bushing 3220x8x2	1/8 Hex Hd Plug 3152x2	1/4 Hex Hd Plug 3152x4	3/8 Hex Hd Plug 3152x6	1/2 Hex Hd Plug 3152x8
1/8 Street Elbow 3400x2	1/4 Street Elbow 3400x4	3/8 Street Elbow 3400x6	1/2 Street Elbow 3400x8	1/8 45° St Elbow 3350x2	1/4 45° St Elbow 3350x4	3/8 45° St Elbow 3350x6	1/2 45° St Elbow 3350x8
1/8 Close Nipple 3326x2	1/4 Close Nipple 3326x4	3/8 Close Nipple 3326x6	1/2 Close Nipple 3326x8	1/8 x 1-1/2 Long Nipple 3327x2	1/4 x 1-1/2 Long Nipple 3327x4	3/8 x 2 Long Nipple 3328x6	1/2 x 2 Long Nipple 3328x8
1/8 Elbow 3500x2	1/4 Elbow 3500x4	3/8 Elbow 3500x6	1/8 Adapter 3200x2	1/4 Adapter 3200x4	3/8 Adapter 3200x6	1/4 x 1/8 Reducing Adapter 3200x4x2	3/8 x 1/4 Reducing Adapter 3200x6x4

Brass Pipe Fittings (Z06)

IBS No. 158P

40 ITEMS - 162 PIECES
Packaged in a 40 compartment metal bin



IBS, INCORPORATED

Assortments Z02



Brass Pipe Fittings

IBS No. 103R

32 Items • 134 Pcs

Packaged in a locking steel drawer for easy storage and organization



IBS, Inc. SPECIALTY PRODUCTS FOR MAINTENANCE & REPAIR INDUSTRIALBOLT.COM © © © 800-678-1506				Brass Pipe Fittings			
3152X8 1/2 BRASS HEX HD PLUG 	3220X8X2 1/2 X 1/8 BRASS PIPE HX 	3326X4 1/4 X CLOSE BRASS NIPPLE 	3350X4 1/4 BRASS 45DGR ST. ELBOW 	3400X4 1/4 X 1/4 BRASS ST. ELBOW 	3750X4 1/4 BRASS PIPE ST. TEE 	WHD145 1/4 BRASS EXT SEAT DRAINCK 	Assortment No. 103R 3300X8 1/2 BRASS PIPE COUPLING
3152X6 3/8 BRASS HEX HD PLUG 	3220X6X4 3/8 X 1/4 BRASS PIPE HX 	3326X2 1/8 X CLOSE BRASS NIPPLE 	3350X2 1/8 BRASS 45DGR ST. ELBOW 	3400X2 1/8 X 1/8 BRASS ST. ELBOW 	3750X2 1/8 BRASS PIPE ST. TEE 	WHD135 1/8 BRASS EXT SEAT DRAINCK 	3300X6 3/8 BRASS PIPE COUPLING
3152X4 1/4 BRASS HEX HD PLUG 	3220X6X2 3/8 X 1/8 BRASS PIPE HX 	3220X8X6 1/2 X 3/8 BRASS PIPE HX 	3326X8 1/2 X CLOSE BRASS NIPPLE 	3350X8 1/2 BRASS 45DGR ST. ELBOW 	3400X8 1/2 X 1/2 BRASS ST. ELBOW 	3750X8 1/2 BRASS PIPE ST. TEE 	3300X4 1/4 BRASS PIPE COUPLING
3152X2 1/8 BRASS HEX HD PLUG 	3220X4X2 1/4 X 1/8 BRASS PIPE HX 	3220X8X4 1/2 X 1/4 BRASS PIPE HX 	3326X6 3/8 X CLOSE BRASS NIPPLE 	3350X6 3/8 BRASS 45DGR ST. ELBOW 	3400X6 3/8 X 3/8 BRASS ST. ELBOW 	3750X6 3/8 BRASS PIPE ST TEE 	3300X2 1/8 BRASS PIPE COUPLING

Brass Pipe Fittings

3/8" & 1/2"

IBS No. 103R-LGR

17 Items • 64 Pcs

Packaged in a locking steel drawer for easy storage and organization



IBS, Inc. SPECIALTY PRODUCTS FOR MAINTENANCE & REPAIR INDUSTRIALBOLT.COM © © © 800-678-1506				Brass Pipe Fittings 3/8" & 1/2"			
3220X6X4 3/8 X 1/4 BRASS PIPE HX 	3326X8 1/2 X CLOSE BRASS NIPPLE 	3400X8 1/2 X 1/2 BRASS ST. ELBOW 	3300X8 1/2 BRASS PIPE COUPLING 				
3220X6X2 3/8 X 1/8 BRASS PIPE HX 	3326X6 3/8 X CLOSE BRASS NIPPLE 	3400X6 3/8 X 3/8 BRASS ST ELBOW 	3300X6 3/8 BRASS PIPE COUPLING 				
3152X8 1/2 BRASS HEX HD PLUG 	3220X8X6 1/2 X 3/8 BRASS PIPE HX 	3350X8 1/2 BRASS 45DGR ST. ELBOW 	3750X8 1/2 BRASS PIPE ST. TEE 				
3152X6 3/8 BRASS HEX HD PLUG 	3220X8X4 1/2 X 1/4 BRASS PIPE HX 	3350X6 3/8 BRASS 45DGR ST. ELBOW 	3750X6 3/8 BRASS PIPE ST TEE 				

Brass Pipe Fittings

1/8" & 1/4"

IBS No. 103R-SML • 15

Items • 71 Pcs

Packaged in a locking steel drawer for easy storage and organization



IBS, Inc. SPECIALTY PRODUCTS FOR MAINTENANCE & REPAIR INDUSTRIALBOLT.COM © © © 800-678-1506				Brass Pipe Fittings 1/8" & 1/4"			
	3400X4 1/4 X 1/4 BRASS ST. ELBOW 	3750X4 1/4 BRASS PIPE ST. TEE 	WHD145 1/4 BRASS EXT. SEAT DRAIN COCK 				
3220X4X2 1/4 X 1/8 BRASS PIPE HX 	3400X2 1/8 X 1/8 BRASS ST. ELBOW 	3750X2 1/8 BRASS PIPE ST. TEE 	WHD135 1/8 BRASS EXT. SEAT DRAIN COCK 				
3152X4 1/4 BRASS HEX HD PLUG 	3326X4 1/4 X CLOSE BRASS NIPPLE 	3350X4 1/4 BRASS 45DGR ST. ELBOW 	3300X4 1/4 BRASS PIPE COUPLING 				
3152X2 1/8 BRASS HEX HD PLUG 	3326X2 1/8 X CLOSE BRASS NIPPLE 	3350X2 1/8 BRASS 45DGR ST. ELBOW 	3300X2 1/8 BRASS PIPE COUPLING 				

FITTINGS



IBS, INCORPORATED

Compression Fittings O02

Compression Fittings

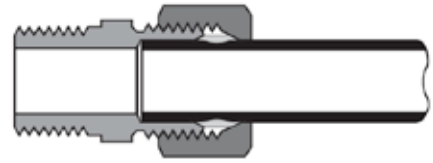
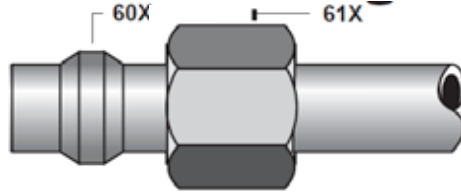
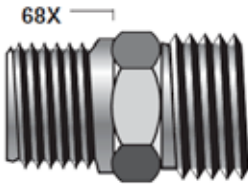

Tube O.D.	1/8	3/16	1/4	5/16	3/8	7/16	1/2	5/8	3/4	1
Thread Size	5/16-24	3/8-24	7/16-24	1/2-24	9/16-24	5/8-24	11/16-20	13/16-18	1-18	1-1/4-18

- Does not require flaring, soldering or other preparation of tubing in order to assemble.
- Listed with Underwriter's Laboratories for flammable liquid. Meets functional requirements of SAE J-512, ASA, and ASME.
- Use with copper, brass or aluminum. Not recommended for steel tubing. Manufactured for low and medium pressure tubing connection work where excessive vibration or tube movement is not involved.
- Can be used in temps. ranging from -65° to +250° F.
- Fair resistance to vibration or tube movement, depending on applications involved. Use long nut for additional resistance to vibration.

Working Pressure Ranges

Temperature and type of tubing used are important factors. However, the following table is a good guide for proper selection. Temperature 73° F.

PSI	Tube O.D. (in)	Tube Wall (in.)
400	1/8	.030
400	3/16	.030
300	1/4	.030
300	5/16	.032
200	3/8	.032
200	1/2	.032
150	5/8	.035
100	3/4	.035
75	7/8	.035

Assembly Instructions

1. Cut tubing to desired length and remove all burrs.
2. Slide nut, then sleeve onto tubing with the threaded end of the nut facing out.
3. Insert tubing into fitting body making sure the tube is bottomed on the fitting shoulder.
4. Assemble nut to body and tighten hand tight. Then tighten with a wrench the number of turns as indicated by the accompanying chart

Tube Size	Additional Turns From Hand Tight
1/8" thru 1/4"	1-1/4
5/16"	1-3/4
3/8" thru 1"	2-1/4

FITTINGS

Inserts for Plastic Tubing

(Not for Air Brake)

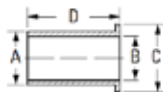

IBS No.	Tube OD	A	B	C	D	Qty
2030X4	1/4	1/8	3/32	11/64	19/32	20
2030X44	1/4	11/64	9/64	7/32	17/32	20
2030X5	5/16	3/16	5/32	15/64	5/8	20
2030X6	3/8	1/4	7/32	11/32	41/64	20
2030X8	1/2	3/8	11/32	7/16	13/16	10
2030X10	5/8	1/2	29/64	35/64	13/16	10

Compression Sleeves

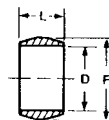

IBS No.	Tube OD	D	F	L	Qty
60X2	1/8	.13	.19	.19	20
60X3	3/16	.19	.27	.22	20
60X4	1/4	.26	.34	.25	20
60X5	5/16	.32	.41	.25	20
60X6	3/8	.38	.47	.25	20
60X8	1/2	.51	.59	.38	10
60X10	5/8	.63	.72	.38	10
60X12	3/4	.76	.88	.44	10

IBS, INCORPORATED

Compression Fittings O02



Compression Nuts

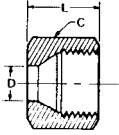

IBS No.	Tube OD	Hex	D	L	Qty
61X2	1/8	3/8	.13	.38	10
61X3	3/16	7/16	.19	.41	10
61X4	1/4	1/2	.26	.44	10
61X5	5/16	9/16	.32	.44	10
61X6	3/8	5/8	.38	.47	10
61X8	1/2	13/16	.51	.62	10
61X10	5/8	15/16	.63	.62	5
61X12	3/4	1-3/16	.76	.69	5

Compression Unions

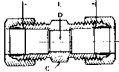

IBS No.	Tube OD	Hex	D	L	Qty
62X2	1/8	5/16	.094	.66	5
62X3	3/16	3/8	.125	.76	5
62X4	1/4	7/16	.188	.79	5
62X5	5/16	1/2	.250	.88	5
62X6	3/8	9/16	.312	.97	5
62X8	1/2	11/16	.406	1.10	5
62X10	5/8	13/16	.500	1.25	5
62X12	3/4	1	.562	1.44	5

Male Connectors

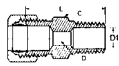

IBS No.	Tube OD	MPT	Hex	L	Qty
68X2	1/8	1/8	7/16	.78	5
68X3	3/16	1/8	7/16	.84	5
68X4	1/4	1/8	7/16	.88	5
68X4X4	1/4	1/4	9/16	1.06	5
68X5	5/16	1/8	1/2	.91	5
68X5X4	5/16	1/4	9/16	1.09	5
68X6X2	3/8	1/8	9/16	.97	5
68X6	3/8	1/4	9/16	1.17	5
68X6X6	3/8	3/8	11/16	1.16	5
68X6X8	3/8	1/2	11/16	1.16	5
68X8X4	1/2	1/4	11/16	1.22	5
68X8	1/2	3/8	11/16	1.22	5
68X8X8	1/2	1/2	7/8	1.41	5
68X10	5/8	1/2	7/8	1.50	5

Female Connectors

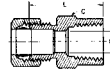

IBS No.	Tube OD	FPT	C	L	Qty
66X2	1/8	1/8	9/16	.75	5
66X3	3/16	1/8	9/16	.78	5
66X4	1/4	1/8	9/16	.78	5
66X4X4	1/4	1/4	11/16	1.03	5
66X5	5/16	1/8	9/16	.81	5
66X5X4	5/16	1/4	5/8	.91	5

Union Tees

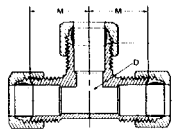

IBS No.	Tube OD	D	M	Qty
64X3	3/16	.125	.60	5
64X4	1/4	.188	.62	5
64X5	5/16	.250	.60	5
64X6	3/8	.312	.73	5
64X8	1/2	.406	.94	5

Male Elbows

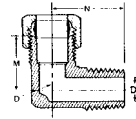

IBS No.	Tube OD	MPT	D	D1	M	N	Qty
69X2	1/8	1/8	.094	.219	.60	.67	5
69X3	3/16	1/8	.125	.219	.62	.69	5
69X4	1/4	1/8	.188	.219	.62	.75	5
69X4X4	1/4	1/4	.188	.188	.63	.84	5
69X5	5/16	1/8	.250	.234	.62	.75	5
69X5X4	5/16	1/4	.202	.344	.69	.84	5
69X6X2	3/8	1/8	.312	.234	.69	.69	5
69X6	3/8	1/4	.312	.344	.75	.93	5
69X6X6	3/8	3/8	.312	.437	.85	.94	5
69X6X8	3/8	1/2	.406	.531	.87	1.12	5
69X8X4	1/2	1/4	.406	.312	.84	.94	5
69X8	1/2	3/8	.406	.407	.94	1.12	5
69X8X8	1/2	1/2	.406	.531	.94	1.31	5
69X10	5/8	1/2	.500	.564	1.06	1.31	5

FITTINGS



IBS, INCORPORATED

Compression Fittings O02

Compression Fittings Assortment

IBS No. 177R • 24 Items 209 Pieces

Packaged in a locking steel drawer for easy storage & organization.



Compression Brass Fittings

Assortment No. 177R

60X3 3/16 OD BRASS COMP SLEEVE 	60X4 1/4 OD BRASS COMP SLEEVE 	60X5 5/16 OD BRASS COMP SLEEVE 	60X6 3/8 OD BRASS COMP SLEEVE 	61X3 3/16 OD BRASS COMP NUT 	61X4 1/4 OD BRASS COMP NUT 
61X5 5/16 OD BRASS COMP NUT 	61X6 3/8 OD BRASS COMP NUT 	62X3 3/16 OD BRASS COMP UNION 	62X4 1/4 OD BRASS COMP UNION 	62X5 5/16 OD BRASS COMP UNION 	62X6 3/8 OD BRASS COMP UNION 
68X3 3/16 X 1/8 BRASS COMP M CONN 	68X4 1/4 X 1/8 BRASS COMP M CONN 	68X4X4 1/4 X 1/4 BRASS COMP M CONN 	68X5 5/16 X 1/8 BRASS COMP M CONN 	68X5X4 5/16 X 1/4 BRASS COMP M CONN 	68X6 3/8 X 1/4 BRASS COMP M CONN 
69X3 3/16 X 1/8 90DGR BRASS COMP M 	69X4 1/4 X 1/8 90DGR BRASS COMP M 	69X4X4 1/4 X 1/4 90DGR BRASS COMP M 	69X5 5/16 X 1/8 90DGR BRASS COMP M 	69X5X4 5/16 X 1/4 90DGR BRASS COMP M 	69X6 3/8 X 1/4 90DGR BRASS COMP M 

FITTINGS

IBS, INCORPORATED

Inverted Flare Fittings O03



Inverted Flare Fittings

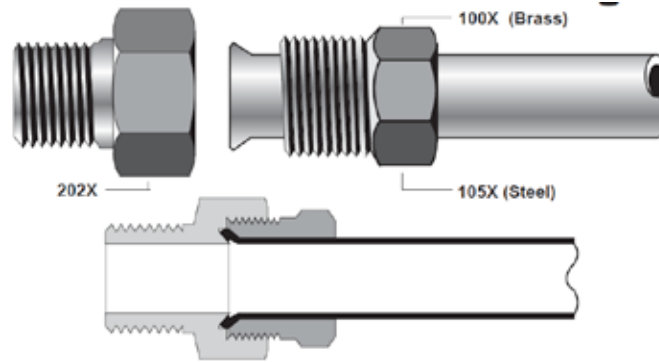

Tube O.D.	1/8	3/16	1/4	5/16	3/8	7/16	1/2	5/8	3/4	7/8	1
Thread Size	5/16-28	3/8-24	7/16-24	1/2-20	5/8-18	11/16-18	3/4-18	7/8-18	1-1/16-16	1-13/16-16	1-15/16-16

- **Economical**
 - Built to resist mechanical pullout
 - Can be assembled and disassembled repeatedly.
- **Listed with Underwriters' Laboratories** for flammable liquid and gas. Meets functional requirements of SAE J512, ASA, ASME, and MS (Military Standards).
- **Use with** copper, brass, aluminum and welded steel hydraulic tubing that can be flared.
- **Will withstand** minimal vibration movements.
- **Temperature range** form -65° to +250°F.

Working Pressure Ranges

Temperature and type of tubing used are important factors. However, the following table is a good guide for proper selection. Temperature 73 °F with copper tubing.

PSI	Tube O.D. (in)	Tube Wall (in.)
2800	1/8	.030
1900	3/16	.030
1400	1/4	.030
1200	5/16	.032
1000	3/8	.032
750	1/2	.032
650	5/8	.035
550	3/4	.035

Assembly Instructions

1. Cut tubing to desired length and remove all burrs.
2. Slide nut, then sleeve onto tubing with the threaded end of the nut facing out.
3. Flare end of tube with a 45° flaring tool. Measure flare diameter. Examine flare for excessive thin out. On thin wall copper, welded or brazed tubing use double flare to prevent pinched off or cracked flares.
4. Clamp tube flare between nut and flare seat of body by screwing nut on finger tight. Tighten with a wrench for metal-to-metal seal.

Note: The seat dimensions are predicated on practical threading limitations and use of these fittings with double flared tubing.

Tube Nuts



IBS No.	Tube OD	C	D	L	Qty
100X3	3/16	3/8	.196	.56	25
100X4	1/4	7/16	.259	.56	25
100X5	5/16	1/2	.321	.62	25
100X6	3/8	5/8	.384	.66	10
100X8	1/2	3/4	.508	.74	10

Steel Inverted Nuts



IBS No.	Tube OD	C	D	L	Qty
105X2	1/8	5/16	.132	.52	10
105X3	3/16	3/8	.196	.56	10
105X4	1/4	7/16	.259	.56	10
105X5	5/16	1/2	.321	.62	10
105X6	3/8	5/8	.384	.66	10
105X8	1/2	3/4	.508	.74	10

FITTINGS



IBS, INCORPORATED

Inverted Flare Fittings O03

FITTINGS



Steel Inverted Plug

IBS No.	Tube OD	C	D	L	Qty
131X3	3/16	3/8	.188	.53	10
131X4	1/4	7/16	.188	.54	10
131X5	5/16	1/2	.250	.59	10
131X6	3/8	5/8	.312	.66	5

Male Connectors



IBS No.	Tube OD	MPT	Hex	D	L	Qty
202X2	1/8	1/8	13/32	.078	.62	10
202X3	3/16	1/8	15/32	.125	.70	10
202X4	1/4	1/8	17/32	.188	.74	10
202X4X4	1/4	1/4	9/16	.188	.89	10
202X5	5/16	1/8	19/32	.219	.79	10
202X5X4	5/16	1/4	19/32	.220	.98	10
202X6X2	3/8	1/8	3/4	.281	.89	10
202X6	3/8	1/4	3/4	.281	1.03	10
202X6X6	3/8	3/8	3/4	.281	1.01	5
202X8X4	1/2	1/4	29/32	.406	1.08	5
202X8	1/2	3/8	29/32	.406	1.07	5
202X8X8	1/2	1/2	29/32	.406	1.26	5



Female Connectors

IBS No.	Tube OD	FPT	C	D	L	Qty
252X3	3/16	1/8	1/2	.125	.75	5
252X4	1/4	1/8	17/32	.188	.75	5
252X5	5/16	1/8	19/32	.219	.78	5
252X6	3/8	1/4	3/4	.281	1.03	5

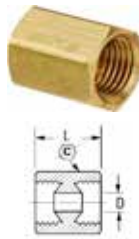

Inverted Unions

IBS No.	Tube OD	C	D	L	Qty
302X3	3/16	15/32	.125	.62	10
302X4	1/4	17/32	.188	.62	10
302X5	5/16	19/32	.219	.70	10
302X6	3/8	3/4	.281	.80	5

45° Male Elbows

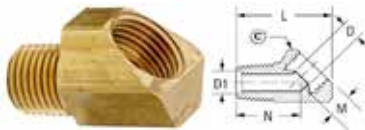

IBS No.	Tube OD	MPT	C	D	D1	L	M	N	Qty
352X3	3/16	1/8	17/32	.125	.156	.88	.88	.55	10
352X4	1/4	1/8	9/16	.188	.188	.94	.94	.58	10
352X5	5/16	1/8	5/8	.219	.203	1.00	1.00	.56	10
352X6X2	3/8	1/8	25/32	NA	NA	NA	NA	NA	5
352X6	3/8	1/4	25/32	.281	.219	1.34	1.34	.84	5
352X8	1/2	3/8	7/8	.406	.375	1.44	1.44	.91	5

90° Male Elbows



IBS No.	Tube OD	MPT	D	D1	L	L1	M	X	Qty
402X2	1/8	1/8	.078	.116	.80	.47	.27	.42	10
402X3	3/16	1/8	.125	.125	.85	.47	.27	.47	10
402X4	1/4	1/8	1.88	.177	.92	.55	.33	.53	10
402X4X4	1/4	1/4	.188	.188	1.09	.58	.28	.56	10
402X5	5/16	1/8	.219	.219	.98	.67	.47	.59	10
402X5X4	5/16	1/4	.219	.219	1.16	.75	.45	.59	10
402X6X2	3/8	1/8	.281	.219	1.14	.75	.54	.76	10
402X6	3/8	1/4	.281	.281	1.32	.82	.53	.76	10
402X6X6	3/8	3/8	.281	.312	1.32	.84	.50	.75	5
402X8	1/2	3/8	.406	.375	1.48	.94	.59	.92	5
402X8X8	1/2	1/2	.406	.406	1.67	1.09	.66	.91	5

IBS, INCORPORATED

Inverted Flare Fittings O03



Inverted Flare Fittings Assortment

IBS No. 178R • 24 Items 129 Pieces

Packaged in a locking steel drawer for easy storage & organization.



Inverted Flare Brass Fittings

Assortment No. 178R

105X3 3/16 INV TUBE NUT STEEL 	105X4 1/4 INV TUBE NUT STEEL 	105X5 5/16 INV TUBE NUT STEEL 	105X6 3/8 INV TUBE NUT STEEL 	202X3 3/16 X 1/8 INV M CONN BRASS 	202X4 1/4 X 1/8 INV M CONN BRASS 
202X4X4 1/4 X 1/4 INV M CONN BRASS 	202X5 5/16 X 1/8 INV M CONN BRASS 	202X5X4 5/16 X 1/4 INV M CONN BRASS 	202X6 3/8 X 1/4 INV M CONN BRASS 	402X3 3/16 X 1/8 INV 90DGR ELBOW M 	402X4 1/4 X 1/8 INV 90DGR ELBOW M 
402X4X4 1/4 X 1/4 INV 90DGR ELBOW M 	402X5 5/16 X 1/8 INV 90DGR ELBOW M 	402X5X4 5/16 X 1/4 INV 90DGR ELBOW M 	402X6 3/8 X 1/4 INV 90DGR ELBOW M 	352X3 3/16 X 1/8 INV 45DGR ELBOW M 	352X4 1/4 X 1/8 INV 45DGR ELBOW M 
352X5 5/16 X 1/8 INV 45DGR ELBOW M 	352X6 3/8 X 1/4 INV 45DGR ELBOW M 	302X3 3/16 INV UNION BRASS 	302X4 1/4 INV UNION BRASS 	302X5 5/16 INV UNION BRASS 	302X6 3/8 INV UNION BRASS 

FITTINGS



IBS, INCORPORATED

SAE 45° Flared Fittings O01

SAE 45° Flared Fittings

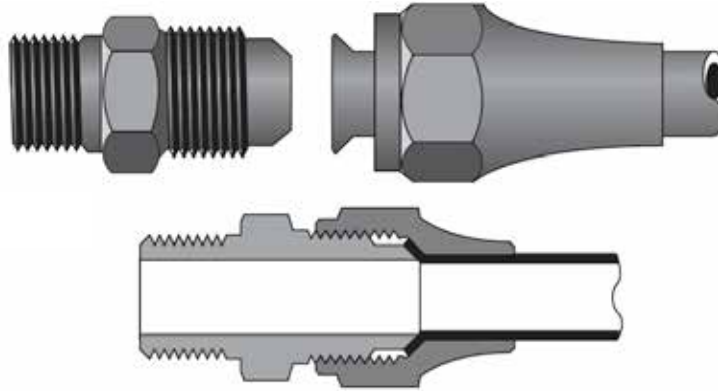

Tube O.D.	1/8	3/16	1/4	5/16	3/8	7/16	1/2	5/8	3/4
Thread Size	5/16-24	3/8-24	7/16-20	1/2-20	5/8-18	11/16-18	3/4-16	7/8-14	1-1/16-14

- Economical**

- Resists mechanical pullout.
- Can be assembled and disassembled repeatedly.

- Use with copper, brass, aluminum, and welded** steel hydraulic tubing that can be flared. Manufactured especially for hard-to-hold liquids and gases.

- Listed with Underwriter's Laboratories for flammable liquid, marine, refrigeration and gas applications.

Meets functional requirements of SAE, ASA, ASME and MS (Military Standards)

- Short nut may be used** when vibration is minimal. **The long nut offers** additional vibration capacity.

- Can be used in temperatures ranging from -65° to +250° F.**

Working Pressure Ranges

Temperatures and type of tubing used are important factors. However, the following table is a good guide for proper selection. Temperature 73° F with copper tubing:

PSI	Tube O.D.	Tube Wall
2800	1/8	.030
1900	3/16	.030
1400	1/4	.030
1200	5/16	.032
1000	3/8	.032
750	1/2	.032
650	5/8	.035
550	3/4	.035
450	7/8	.035

Assembly Instructions

Flare fittings are easy to disassemble and may be reassembled repeatedly for a leak-proof connection.

1. Cut tubing to the length desired. Make sure the ends are square and all burrs are removed.
2. Slide the nut onto the tube with the threaded end facing out toward the end of the tube.
3. Flare the tube end using a 45° flaring tool.
4. Clamp tube flare between nut and nose of fitting body by screwing nut on finger-tight. Tighten with a wrench for a metal-to-metal seal.

FITTINGS

IBS, INCORPORATED

SAE 45° Flared Fittings O01



Brass Flare Nut

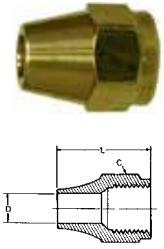

IBS No.	Tube OD	Hex	D	Qty
1110X3	3/16	7/16	.195	10
1110X4	1/4	9/16	.258	10
1110X5	5/16	5/8	.320	10
1110X6	3/8	3/4	.383	10
1110X8	1/2	7/8	.508	10
1110X10	5/8	1-1/16	.633	10

Brass Flare Long Nut

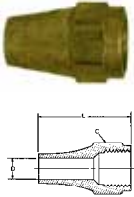

IBS No.	Tube OD	Hex	L	D	Qty
41X2	1/8	1/8	.75	.132	10
41X3	3/16	7/16	.81	.195	10
41X4	1/4	9/16	.94	.258	10
41X5	5/16	5/8	1.12	.320	10
41X6	3/8	3/4	1.31	.383	5
41X8	1/2	7/8	1.62	.508	5
41X10	5/8	1-1/16	1.88	.633	5

Brass Flare Plugs

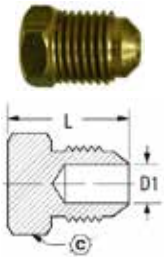

IBS No.	Tube OD	Hex	L	Qty
2229X4	1/4	7/16	.69	5
2229X5	5/16	1/2	.79	5
2229X6	3/8	5/8	.88	5
2229X8	1/2	3/4	1.06	5
2229X10	5/8	7/8	1.19	1
2229X12	3/4	1-1/16	1.31	1

Brass Flare Caps

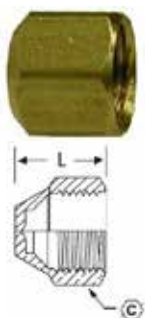

IBS No.	Tube OD	Hex	L	Qty
2129X4	1/4	7/16	.53	10
2129X5	5/16	5/8	.62	10
2129X6	3/8	3/4	.69	10
2129X8	1/2	7/8	.84	10
2129X10	5/8	1-1/16	.97	5
2129X12	3/4	1-5/16	1.09	5

Brass Flare Union

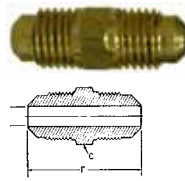

IBS No.	Tube OD	Hex	D	L	Qty
42X2	1/8	5/16	.078	.92	10
42X3	3/16	3/8	.125	1.06	10
42X4	1/4	7/16	.188	1.19	10
42X5	5/16	1/2	.219	1.34	10
42X6	3/8	5/8	.281	1.50	5
42X8	1/2	3/4	.406	1.81	5
42X10	5/8	7/8	.500	2.12	5
42X12	3/4	1-1/16	.625	2.44	5

Brass Flare Union Tee

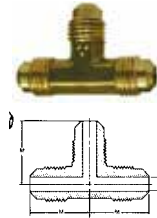

IBS No.	Tube OD	M	D	Qty
44X4	1/4	.86	.188	5
44X5	5/16	.89	.219	5
44X6	3/8	1.04	.281	5
44X8	1/2	1.20	.406	5

Brass Male Connector

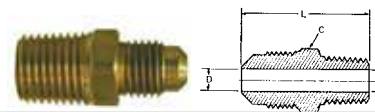

IBS No.	Tube OD	MPT	Hex	D	L	Qty
48X2	1/8	1/8	7/16	.078	.90	10
48X3	3/16	1/8	7/16	.125	1.00	10
48X4	1/4	1/8	7/16	.188	1.06	10
48X4X4	1/4	1/4	9/16	.188	1.26	10
48X5	5/16	1/8	1/2	.219	1.16	10
48X5X4	5/16	1/4	9/16	.219	1.34	10
48X6X2	3/8	1/8	5/8	.281	1.25	5
48X6	3/8	1/4	5/8	.281	1.44	5
48X6X6	3/8	3/8	11/16	.281	1.44	5
48X6X8	3/8	1/2	7/8	.281	1.69	5
48X8X4	1/2	1/4	3/4	.406	1.62	5
48X8	1/2	3/8	3/4	.406	1.62	5
48X8X8	1/2	1/2	7/8	.406	1.81	5
48X10X6	5/8	3/8	7/8	.500	1.81	5
48X10	5/8	1/2	7/8	.500	2.00	5
48X12	3/4	1/2	1-1/16	.625	2.18	5
48X12X12	3/4	3/4	1-1/16	.625	2.18	5

FITTINGS



IBS, INCORPORATED

SAE 45° Flared Fittings O01

Brass Female Connector



IBS No.	Tube OD	FPT	Hex	D	L	Qty
46X3	3/16	1/8	9/16	.125	.97	10
46X4	1/4	1/8	9/16	.188	1.03	10
46X6X2	3/8	1/8	5/8	.281	1.12	5
46X6	3/8	1/4	11/16	.281	1.31	5
46X8	1/2	3/8	13/16	.406	1.50	5

Brass Male 45° Elbow

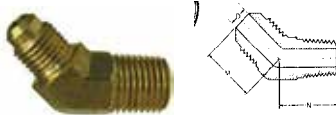

IBS No.	Tube OD	MPT	D	M	N	Qty
54X4	1/4	1/8	.188	.67	.64	10
54X4X4	1/4	1/4	.188	.73	.87	10
54X5	5/16	1/8	.219	.78	.64	10
54X6	3/8	1/4	.283	.89	.86	5
54X6X6	3/8	3/8	.281	.91	.93	5
54X8	1/2	3/8	.407	1.06	.96	5
54X8X8	1/2	1/2				5
54X10	5/8	1/2	.500	1.23	1.17	5

Brass Male 90° Elbow

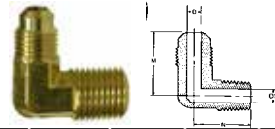

IBS No.	Tube OD	MPT	D	D1	M	N	Qty
49X2	1/8	1/8	.078	.219	.62	.69	10
49X3	3/16	1/8	.125	.219	.75	.75	10
49X4	1/4	1/8	.188	.219	.81	.76	10
49X4X4	1/4	1/4	.188	.312	.88	.99	10
49X4X6	1/4	3/8	.188	.406	.94	1.03	10
49X5	5/16	1/8	.219	.219	.91	.78	10
49X5X4	5/16	1/4	.219	.312	.95	.92	10
49X6X2	3/8	1/8	.283	.219	1.03	.91	5
49X6	3/8	1/4	.281	.312	.97	1.06	5
49X6X6	3/8	3/8	.281	.406	1.06	1.09	5
49X6X8	3/8	1/2	.281	.438	1.16	1.28	5
49X8X4	1/2	1/4	.406	.312	1.23	1.19	5
49X8	1/2	3/8	.406	.406	1.23	1.12	5
49X8X8	1/2	1/2	.406	.406	1.25	1.32	5
49X10X6	5/8	3/8	.502	.406	1.42	1.23	5
49X10	5/8	1/2	.502	.562	1.42	1.37	5
49X12	3/4	1/2	.626	.562	1.62	1.48	5
49X12X12	3/4	3/4	.625	.750	1.59	1.62	5

SAE 45° Flare Brass Fittings Assortment

IBS No. 104R • 32 Items 95 Pieces

Packaged in a locking steel drawer for easy storage & organization



IBS, Inc.
SPECIALTY PRODUCTS FOR MAINTENANCE & REPAIR
INDUSTRIALBOLTY.COM © 2010 800-678-1906

**SAE 45° Flare
Brass Fittings**

Assortment No. 104R

42X8 1/2 SAE 45DGR BRASS FLARE 	48X5 5/16 X 1/8 SAE 45DGR BRASS 	48X8 1/2 X 3/8 SAE 45DGR BRASS 	48X10X6 5/8 X 3/8 SAE 45DGR BRASS 	49X5X4 5/16 X 1/4 SAE 90DGR BRASS 	49X8X4 1/2 X 1/4 SAE 90DGR BRASS 	54X4 1/4 X 1/8 SAE 45DGR BRASS 	54X10 5/8 X 1/2 SAE 45DGR BRASS
42X6 3/8 SAE 45DGR BRASS FLARE 	48X4X4 1/4 X 1/4 SAE 45DGR BRASS 	48X6X6 3/8 X 3/8 SAE 45DGR BRASS 	48X10 5/8 X 1/2 SAE 45DGR BRASS 	49X5 5/16 X 1/8 SAE 90DGR BRASS 	49X8 1/2 X 3/8 SAE 90DGR BRASS 	49X10X6 5/8 X 3/8 SAE 90DGR BRASS 	54X8 1/2 X 3/8 SAE 45DGR BRASS
42X5 5/16 SAE 45DGR BRASS FLARE 	48X4 1/4 X 1/8 SAE 45DGR BRASS 	48X6 3/8 X 1/4 SAE 45DGR BRASS 	48X8X8 1/2 X 1/2 SAE 45DGR BRASS 	49X4X4 1/4 X 1/4 SAE 90DGR BRASS 	49X6X6 3/8 X 3/8 SAE 90DGR BRASS 	49X10 5/8 X 1/2 SAE 90DGR BRASS 	54X6 5/8 X 1/4 SAE 45DGR BRASS
42X4 1/4 SAE 45DGR BRASS FLARE 	42X10 5/8 SAE 45DGR BRASS FLARE 	48X5X4 5/16 X 1/4 SAE 45DGR BRASS 	48X8X4 1/2 X 1/4 SAE 45DGR BRASS 	49X4 1/4 X 1/8 SAE 90DGR BRASS 	49X6 3/8 X 1/4 SAE 90DGR BRASS 	49X8X8 1/2 X 1/2 SAE 90DGR BRASS 	54X5 5/16 X 1/8 SAE 45DGR BRASS

IBS, INCORPORATED

Assortments (Z02)



SAE 45° Flare Brass Fittings 1/2" & 5/8"

IBS No. 104-LGR • 14 Items 36 Pieces

Packaged in a locking steel drawer for easy storage & organization





IBS, Inc.
SPECIALTY PRODUCTS FOR MAINTENANCE & REPAIR
INDUSTRIALBOLT.COM © © © 800-678-1906

**SAE 45° Flare
Brass Fittings**

Assortment No. 104R-LGR

<p>42X8 1/2 SAE 45DGR BRASS FLARE</p> 	<p>48X8X4 1/2 X 1/4 SAE 45DGR BRASS</p> 	<p>48X8X8 1/2 X 1/2 SAE 45DGR BRASS</p> 	<p>48X10 5/8 X 1/2 SAE 45DGR BRASS</p> 
<p>42X10 5/8 SAE 45DGR BRASS FLARE</p> 	<p>48X8 1/2 X 3/8 SAE 45DGR BRASS</p> 	<p>48X10X6 5/8 X 3/8 SAE 45DGR BRASS</p> 	
<p>54X8 1/2 X 3/8 SAE 45DGR BRASS</p> 	<p>49X8X4 1/2 X 1/4 SAE 90DGR BRASS</p> 	<p>49X8X8 1/2 X 1/2 SAE 90DGR BRASS</p> 	<p>49X10 5/8 X 1/2 SAE 90DGR BRASS</p> 
<p>54X10 5/8 X 1/2 SAE 45DGR BRASS</p> 	<p>49X8 1/2 X 3/8 SAE 90DGR BRASS</p> 	<p>49X10X6 5/8 X 3/8 SAE 90DGR BRASS</p> 	

SAE 45° Flare Brass Fittings 1/4," 5/16," 3/8"

IBS No. 104-SML • 18 Items 58 Pieces

Packaged in a locking steel drawer for easy storage & organization.























IBS, Inc.
SPECIALTY PRODUCTS FOR MAINTENANCE & REPAIR
INDUSTRIALBOLT.COM © © © 800-678-1906

**SAE 45° Flare
Brass Fittings**

Assortment No. 104R-SML

<p>42X4 1/4 SAE 45DGR BRASS FLARE</p> 	<p>42X5 5/16 SAE 45DGR BRASS FLARE</p> 	<p>42X6 3/8 SAE 45DGR BRASS FLARE</p> 	<p>54X4 1/4 X 1/8 SAE 45DGR BRASS</p> 
<p>48X4 1/4 X 1/8 SAE 45DGR BRASS</p> 	<p>48X5 5/16 X 1/8 SAE 45DGR BRASS</p> 	<p>48X6 3/8 X 1/4 SAE 45DGR BRASS</p> 	<p>54X5 5/16 X 1/8 SAE 45DGR BRASS</p> 
<p>48X4X4 1/4 X 1/4 SAE 45DGR BRASS</p> 	<p>48X5X4 5/16 X 1/4 SAE 45DGR BRASS</p> 	<p>48X6X6 3/8 X 3/8 SAE 45DGR BRASS</p> 	<p>54X6 3/8 X 1/4 SAE 45DGR BRASS</p> 
<p>49X4 1/4 X 1/8 SAE 90DGR BRASS</p> 	<p>49X5 5/16 X 1/8 SAE 90DGR BRASS</p> 	<p>49X6 3/8 X 1/4 SAE 90DGR BRASS</p> 	
<p>49X4X4 1/4 X 1/4 SAE 90DGR BRASS</p> 	<p>49X5X4 5/16 X 1/4 SAE 90DGR BRASS</p> 	<p>49X6X6 3/8 X 3/8 SAE 90DGR BRASS</p> 	

FITTINGS



IBS, INCORPORATED

Nylon Air Brake Fittings O07

Air Brake Fittings for Nylon Tubing

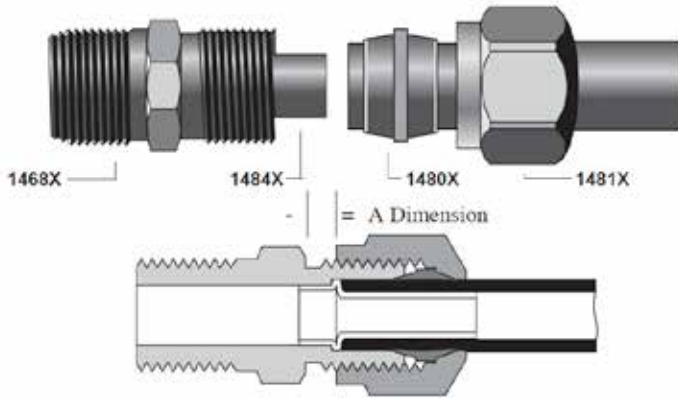

- Easy to assemble - no tube preparation or flaring required.
- May be used with copper tubing by replacing nut, sleeve and insert with long nut and spherical sleeve.
- Use on air brake systems except where temps exceed +200°F or where battery acid can drip on tubing.
- Use with NT100 Nylon tubing - SAE J844 Type A & B.
- Maximum operating pressure - 150 psi.
- Has a temperature range of 40° F to +200° F.
- Offers a fair resistance to vibration.

Tube O.D.	1/4	3/8	1/2	5/8	3/4
Thread Size	7/16-14	17/32-24	11/16-20	13/16-18	1-18

Assembly Instructions

1. Cut tubing to desired length.
2. Slide nut and then sleeve on tubing. Threaded end of nut 'A' must face toward fitting body.
3. Insert tubing into the pre-assembled fitting. Be sure tubing is bottomed in fitting.
4. Tighten nut to required torque as indicated on chart. Another check on proper assembly is dimension A also noted on chart.

Tube Size	Torque	A Dimension
1/4	7 to 9.6 ft. lbs.	.085 / .105
3/8	12 to 17 ft. lbs.	.125 / .145
1/2	25 to 33 ft. lbs.	.100 / .120
5/8	26 to 35 ft. lbs.	.115 / .135
3/4	38 to 50 ft. lbs.	.180 / 200

Disassembly - Remove nut and pull tubing out of fitting body. Insert will remain in tubing.

Reassembly - Push tubing and insert into fitting body until it bottoms. Thread nut onto fitting and torque as in step 4.

FITTINGS



AIR BRAKE NUT

IBS No.	Tube Size	Qty
1461x4	1/4	10
1461x6	3/8	10
1461x8	1/2	5
1461x10	5/8	5
1461x12	3/4	5



AIR BRAKE SLEEVE

IBS No.	Tube Size	Qty
1460x4	1/4	10
1460x6	3/8	10
1460x8	1/2	10
1460x10	5/8	10
1460x12	3/4	10



AIR BRAKE INSERT

IBS No.	Tube Size	Qty
1484x4	1/4	20
1484x6	3/8	20
1484x8	1/2	10
1484x10	5/8	10
1484x12	3/4	10



AIR BRAKE UNION

IBS No.	Tube Size	Qty
1462x4	1/4	5
1462x6	3/8	5
1462x8	1/2	3
1462x10	5/8	1
1462x12	3/4	1

IBS, INCORPORATED

Nylon Air Brake Fittings O07



AIR BRAKE MALE CONNECTORS

IBS No.	Tube Size	MPT	Qty
1468x4	1/4	1/8	5
1468x4x4	1/4	1/4	5
1468x4x6	1/4	3/8	5
1468x6x2	3/8	1/8	5
1468x6	3/8	1/4	5
1468x6x6	3/8	3/8	5
1468x6x8	3/8	1/2	5
1468x8x4	1/2	1/4	5
1468x8	1/2	3/8	5
1468x8x8	1/2	1/2	5
1468x8x12	1/2	3/4	2
1468x10x6	5/8	3/8	2
1468x10	5/8	1/2	2
1468x10x12	5/8	3/4	2
1468x12	3/4	1/2	1
1468x12x12	3/4	3/4	1



AIR BRAKE 90° MALE ELBOWS

IBS No.	Tube Size	MPT	Qty
1469x4	1/4	1/8	5
1469x4x4	1/4	1/4	5
1469x4x6	1/4	3/8	5
1469x6x2	3/8	1/8	5
1469x6	3/8	1/4	5
1469x6x6	3/8	3/8	5
1469x6x8	3/8	1/2	5
1469x8x4	1/2	1/4	3
1469x8	1/2	3/8	3
1469x8x8	1/2	1/2	3
1469x10x6	5/8	3/8	2
1469x10	5/8	1/2	2
1469x10x12	5/8	3/4	2
1469x12	3/4	1/2	1
1469x12x12	3/4	3/4	1



90° UNION

IBS No.	Tube Size	Qty
1465x4	1/4	5
1465x6	3/8	5
1465x8	1/2	3
1465x10	5/8	2



AB 45° MALE ELBOWS

IBS No.	Tube Size	MPT	Qty
1480x4	1/4	1/8	5
1480x4x4	1/4	1/4	5
1480x6	3/8	1/4	5
1480x6x6	3/8	3/8	5
1480x8x4	1/2	1/4	4
1480x8	1/2	3/8	4
1480x8x8	1/2	1/2	4
1480x10	5/8	1/2	2
1480x12x8	3/4	1/2	1



AIR BRAKE TEES

IBS No.	Tube Size	Qty
1464x4	1/4	5
1464x6	3/8	5
1464x8	1/2	3
1464x10	5/8	2

FITTINGS



IBS, INCORPORATED

Assortments Z02

FITTINGS

IBS, Inc. SPECIALTY PRODUCTS FOR MAINTENANCE & REPAIR INDUSTRIALBOLT.COM • 800-678-1906		Nylon Air Brake Fittings 1/4" & 3/8"			192R
1460X4 1/4 BRASS A/B SLEEVE	1461X4 1/4 BRASS A/B NUT	1462X4 1/4 BRASS A/B UNION	1468X4 1/4 X 1/8 BRASS A/B M CONN	1468X4X4 1/4 X 1/4 BRASS A/B M CONN	
1469X4 1/4 X 1/8 BRASS A/B 90DGR M.CONN	1469X4X4 1/4 X 1/4 BRASS A/B 90DGR M CONN	1480X4 1/4 X 1/8 BRASS A/B 45DGR M CONN	1484X4 1/4 BRASS A/B INSERT	1460X6 3/8 BRASS A/B SLEEVE	
1461X6 3/8 BRASS A/B NUT	1462X6 3/8 BRASS A/B UNION	1468X6 3/8 X 1/4 BRASS A/B M CONN	1468X6X2 3/8 X 1/8 BRASS A/B M CONN	1468X6X6 3/8 X 3/8 BRASS A/B M CONN	
1469X6 3/8 X 1/4 BRASS A/B 90DGR M CONN	1469X6X2 3/8 X 1/8 BRASS A/B 90DGR M CONN	1469X6X6 3/8 X 3/8 BRASS A/B 90DGR M CONN	1480X6 3/8 X 1/4 BRASS A/B 45DGR M CONN	1484X6 3/8 BRASS A/B INSERT	

1/4 & 3/8 Air Brake Fittings for Nylon Tubing
IBS No. 192R
20 Items • 121 Pcs
Packaged in a locking steel drawer for easy storage and organization



IBS, Inc. SPECIALTY PRODUCTS FOR MAINTENANCE & REPAIR INDUSTRIALBOLT.COM • 800-678-1906		1/2" Nylon Air Brake Fittings		Assortment No. 193R
1460X8 1/2 BRASS A/B SLEEVE	1461X8 1/2 BRASS A/B NUT	1462X8 1/2 BRASS A/B UNION	1468X8 1/2 X 3/8 BRASS A/B M. CONN	
1468X8X4 1/2 X 1/4 BRASS A/B M. CONN	1468X8X8 1/2 X 1/2 BRASS A/B M. CONN	1469X8 1/2 X 3/8 BRASS A/B 90DGR	1469X8X4 1/2 X 1/4 BRASS A/B 90DGR	
1469X8X8 1/2 X 1/2 BRASS A/B 90DR	1480X8 1/2 X 3/8 BRASS A/B 45DGR	1484X8 1/2 BRASS A/B INSERT		

1/2" Air Brake Fittings for Nylon Tubing
IBS No. 193R
11 Items • 68 Pcs
Packaged in a locking steel drawer for easy storage and organization



IBS, Inc. SPECIALTY PRODUCTS FOR MAINTENANCE & REPAIR INDUSTRIALBOLT.COM • 800-678-1906		5/8" Air Brake Fittings for Nylon		Assortment No. 217R
1460X10 5/8 BRASS A/B SLEEVE	1461X10 5/8 BRASS A/B NUT	1462X10 5/8 BRASS A/B UNION		
1468X10 5/8 X 1/2 BRASS A/B M. CONN	1468X10X6 5/8 X 3/8 BRASS A/B M CONN	1468X10X12 5/8 X 3/4 BRASS A/B M CONN		
1469X10 5/8 X 1/2 BRASS A/B 90DGR	1469X10X6 5/8 X 3/8 BRASS A/B 90DGR	1469X10X12 5/8 X 3/4 BRASS A/B 90DGR		
1480X10 5/8 X 1/2 BRASS A/B 45DR	1484X10 5/8 BRASS A/B INSERT			

5/8" Air Brake Fittings for Nylon Tubing
IBS No. 217R
11 Items • 25 Pcs
Packaged in a locking steel drawer for easy storage and organization



IBS, INCORPORATED

Air Brake Fittings for Hose O08



Air Brake Fittings For Hose

- Can be used for nearly any air brake line.
- Easy to assemble with a good selection of hose end configurations.
- Brass material offers excellent resistance against corrosion.
- Typical application : Air brake hose lines.
- Pressure : Determined by maximum working pressure for hose size,



Assembly Information

1. Slide nut and sleeve onto hose. Make sure bevel edge of sleeve faces out toward fitting.
2. Push hose into fitting until it bottoms.
3. Screw nut until contact is made with body hex.

Male Connectors

IBS No.	W'Head #	Hose I.D.	Pipe Size	Overall Length	Hose Cut-Off Factor *	Qty
W15540	33806B-Y24	3/8	1/4	2.26	11/16	5
W24887	33806B-Y26	3/8	3/8	2.35	13/16	5
W15539	33806B-Y28	3/8	1/2	2.45	15/16	5
W33883	33808B-Y26	1/2	3/8	2.24	3/4	5
W33884	33808B-Y28	1/2	1/2	2.40	15/16	5



Male Connectors with Spring Guard

IBS No.	W'Head #	Hose I.D.	Pipe Size	Overall Length	Hose Cut-Off Factor *	Qty
W15536	33806B-Y34	3/8	1/4	4.75	3/4	5
W23907	33806B-Y36	3/8	3/8	4.74	13/16	5
W15535	33806B-Y38	3/8	1/2	4.88	15/16	5
W33885	33808B-Y36	1/2	3/8	5.12	3/4	5
W33886	33808B-Y38	1/2	1/2	4.88	15/16	5



Female Connectors with Adapter

IBS No.	W'Head #	Hose I.D.	Pipe Size	Overall Length	Hose Cut-Off Factor *	Qty
W26293	33806B-Y84	3/8	1/4	3.33	1-13/16	5
W33808	33806B-Y86	3/8	3/8	3.33	1-3/4	5
W33882	33808B-Y86	1/2	3/8	3.30	1-3/4	5



Female Connectors

IBS No.	W'Head #	Hose I.D.	Thread Size	Overall Length	Hose Cut-Off Factor *	Qty
W26292	33806B-Y76	3/8	3/4-20	2.40	7/8	4



Adapters

IBS No.	W'Head #	Pipe Size	Overall Length	ABS Thread	ABS Swivel	Qty
W33807	1390X6X6	3/8	1.18	3/4-20	3/8	5
W33805	1390X8	3/8	1.18	7/8-20	1/2	5



* To determine the correct length of hose, subtract the cut-off factor for each end fitting from the overall length of the assembly.

FITTINGS



IBS, INCORPORATED

Air Brake Fittings for Hose O08

Insert



IBS No.	W'Head #	Hose I.D.	Pipe Size	Qty
W15993	1391X6	3/8	1/4	5
W33470	1391X6X6	3/8	3/8	5
W15992	1391X6X8	3/8	1/2	5
W33888	1391X8X6	1/2	3/8	5
W33889	1391X8X8	1/2	1/2	5

Sleeves



IBS No.	W'Head #	I.D.	Qty
W03610	33806-A	3/8	10
W33801	33808-A	1/2	10

Nuts



IBS No.	W'Head #	I.D.	Qty
W03624	33806-B	3/8	5
W33802	33808-B	1/2	5

Brass Nut with Spring Guard



IBS No.	W'Head #	I.D.	Qty
W03613	33806-D	3/8	5
W33803	33808-D	1/2	5

Brass Air Brake Hose Mender



IBS No.	W'Head #	Hose I.D.	Overall Length	Qty
W16678	33806B-Y06	3/8	3.25	1
W33887	33808B-Y08	1/2	3.25	1

Draincock for Air Brake Hose Systems

Valves are designed to hold air pressure of 150 psi with one 1/4" air bubble in 5 seconds permissible key leakage.



IBS No.	W'Head #	MPT	Hex	L	Qty
W15310	W15310	3/8	9/16	1.00	3

FITTINGS

Air Brake Fittings for Hose Assortment (Z02)

IBS No. 149R • 13 Items • 35 Pieces

Packaged in a locking steel drawer for easy storage & organization

IBS, Inc.
SPECIALTY PRODUCTS FOR MAINTENANCE & REPAIR
INDUSTRIALBOLT.COM ☎ 800-678-1906

Air Brake Fittings for Hose

Assortment No. 149R

<p>W15536 3/8 X 1/4 AIR BRAKE MALE CONNECTOR WITH SPRING GUARD</p>	<p>W15539 3/8 X 1/2 AIR BRAKE MALE CONNECTOR</p>	<p>W23907 3/8 X 3/8 AIR BRAKE MALE CONNECTOR WITH SPRING GUARD</p>	<p>W33886 1/2 x 1/2 AIR BRAKE MALE CONNECTOR WITH SPRING GUARD</p>
	<p>W03624 3/8 AIR BRAKE NUT</p>	<p>W16678 3/8 AIR BRAKE HOSE MENDER</p>	<p>W33802 1/2 AIR BRAKE NUT</p>
<p>W15535 3/8 X 1/2 AIR BRAKE MALE CONNECTOR WITH SPRING GUARD</p>	<p>W03613 3/8 AIR BRAKE NUT FOR SPRING GUARD</p>	<p>W15540 3/8 X 1/4 AIR BRAKE MALE CONNECTOR</p>	<p>W33801 1/2 AIR BRAKE SLEEVE</p>
	<p>W03610 3/8 AIR BRAKE SLEEVE</p>		<p>W24887 3/8 X 3/8 AIR BRAKE MALE CONNECTOR</p>

IBS, INCORPORATED













Assortments Z02



Air Brake Fitting Assortment for 3/8" Hose

IBS No. 844R • 12 Items • 30 Pieces

Packaged in locking steel drawer for easy storage & organization











		Air Brake Fittings For 3/8" Hose	
Assortment No. 844R			
<p>W15536 3/8 X 1/4 AIR BRAKE FOR HOSE MALE CONNECTOR W/ SPRING</p> 	<p>W15540 3/8 X 1/4 AIR BRAKE FOR HOSE MALE CONNECTOR</p> 	<p>W16678 3/8 AIR BRAKE FOR HOSE MENDER</p> 	<p>W33470 3/8 X 3/8 BRASS AIR HOSE CONN</p> 
<p>W23907 3/8 X 3/8 AIR BRAKE FOR HOSE MALE CONNECTOR W/ SPRING</p> 	<p>W24887 3/8 X 3/8 AIR BRAKE FOR HOSE MALE CONNECTOR</p> 	<p>W03624 3/8 AIR BRAKE FOR HOSE NUT</p> 	<p>W15992 3/8 X 1/2 AIR BRAKE FOR HOSE INSERT</p> 
<p>W15535 3/8 X 1/2 AIR BRAKE FOR HOSE MALE CONNECTOR W/ SPRING</p> 	<p>W15539 3/8 X 1/2 AIR BRAKE FOR HOSE MALE CONNECTOR</p> 	<p>W03613 3/8 AIR BRAKE FOR HOSE NUT FOR SPRING GUARD</p> 	<p>W03610 3/8 AIR BRAKE FOR HOSE SLEEVE</p> 



Air Brake Fitting Assortment for 1/2" Hose

IBS No. 845R • 9 Items • 22 Pieces

Packaged in locking steel drawer for easy storage & organization

		Air Brake Fittings For 1/2" Hose	
Assortment No. 845R			
<p>W33885 1/2 X 3/8 AIR BRAKE FOR HOSE MALE CONNECTOR W/ SPRING</p> 	<p>W33883 1/2 X 3/8 AIR BRAKE FOR HOSE MALE CONNECTOR</p> 	<p>W33887 1/2 AIR BRAKE FOR HOSE MENDER</p> 	<p>W33889 1/2 X 1/2 AIR BRAKE FOR HOSE INSERT</p> 
<p>W33886 1/2 X 1/2 AIR BRAKE FOR HOSE MALE CONNECTOR W/ SPRING</p> 	<p>W33884 1/2 X 1/2 AIR BRAKE FOR HOSE MALE CONNECTOR</p> 	<p>W33802 1/2 AIR BRAKE FOR HOSE NUT</p> 	<p>W33801 1/2 AIR BRAKE FOR HOSE SLEEVE</p> 
		<p>W33803 1/2 AIR BRAKE FOR HOSE NUT FOR SPRING GUARD</p> 	



FITTINGS



IBS, INCORPORATED

Air Brake Fittings for Hose O08

Gladhand Couplings



393 UNIV 393 SER 393 EME

IBS No.	Application	Qty
393UNIV	Universal — Connect to all 3 styles	1
393SER	Service — Connect only to service	1
393EME	Emergency — Connect only to emergency	1

Gladhand Coupling Seals



394 GL 394GLB 394GLR

IBS No.	Application	Qty
394GL	Gladhand Air Coupling Seal — Double Lip	10
394GLB	Gladhand Air Coupling Seal — Blue (Service)	10
394GLR	Gladhand Air Coupling Seal — Red (Emergency)	10

Gladhand Seals Assortment (Z02)

IBS No. 826R • 7 Items • 22 Pieces

Packaged in a locking steel drawer for easy storage & organization

FITTINGS



IBS, Inc.
SPECIALTY PRODUCTS FOR MAINTENANCE & REPAIR
INDUSTRIALDOLY.COM ☎ 800-678-1906

Gladhands

Assortment No. 826R

<p>393SER GLADHAND SERVICE</p>  	<p>393EME GLADHAND EMERGENCY</p>  	<p>393UNIV GLADHAND UNIVERSAL</p>  	<p>37535 LOCTITE DIELECTRIC GREASE 30Z TUBE</p> 
<p>394GLB GLADHAND SEAL SERVICE - BLUE</p>  	<p>394GLR GLADHAND SEAL EMERGENCY - RED</p>  	<p>394GL GLADHAND SEAL UNIVERSAL - BLACK</p>  	  

IBS, INCORPORATED

Air Brake Fittings for Copper Tubing O04



Air Brake Fittings for Copper Tubing

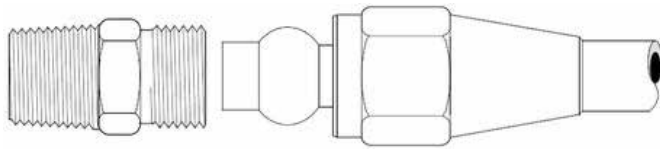

Tube O.D.	1/4	3/8	1/2	5/8	3/4
Thread Size	7/16-24	17/32-24	11/16-20	13/16-18	1-18

- Easy Assembly - no flaring necessary.
- Can be used with nylon tubing by replacing long nut and spherical sleeve with insert, rigid sleeve and nut.
- For use with copper tubing in air brake systems.
- Offers a fair resistance to vibration.
- Temperature range from -65° F to +250° F with copper tubing.
- Operating pressure up to 150 psi.
- Meets specifications and standards of SAE & DOT.

Assembly Instructions

1. Cut tubing to desired length. Make sure all burrs are removed and the ends are cut square.
2. Slide nut and then sleeve on tubing. Threaded end of nut must face toward fitting body.
3. Insert tubing into fitting. Be sure tubing is bottomed on fitting shoulder.
4. Thread nut onto fitting body until it is hand tight.
5. From that point, tighten with a wrench the number of turns indicated in the chart below.

Tube Size	Additional No. Of Turns from Hand Tight
1/4, 3/8	1-3/4
1/2, 5/8, 3/4	3-1/4



SLEEVE

IBS No.	W'Head #	Tube O.D.	Qty
W00457	1360x4	1/4	20
W00361	1360x6	3/8	20
W03754	1360x8	1/2	10
W10612	1360x10	5/8	10



NUTS

IBS No.	W'Head #	Tube O.D.	Hex	Qty
W00455	1361x4	1/4	9/16	10
W00360	1361x6	3/8	5/8	10
W03755	1361x8	1/2	13/16	5
W10613	1361x10	5/8	15/16	2



UNIONS

IBS No.	W'Head #	Tube O.D.	Hex	Qty
W05514	1362x4	1/4	7/16	5
W05134	1362x6	3/8	9/16	5
W15710	1362x8	1/2	11/16	3
W21826	1362x10	5/8	13/16	1



MALE CONNECTOR

IBS No.	W'Head #	Tube O.D.	MPT	Hex	Qty
W05127	1368x4	1/4	1/8	7/16	5
W05183	1368x4x4	1/4	1/4	9/16	5
W05509	1368x6x2	3/8	1/8	9/16	5
W05053	1368x6	3/8	1/4	9/16	5
W05824	1368x6x6	3/8	3/8	11/16	5
W22063	1368x6x8	3/8	1/2	7/8	5
W17690	1368x8x4	1/2	1/4	11/16	5
W17525	1368x8	1/2	3/8	11/16	5
W17691	1368x8x8	1/2	1/2	7/8	5
W16685	1368x10x6	5/8	3/8	13/16	2
W16684	1368x10	5/8	1/2	7/8	2



FEMALE CONNECTOR

IBS No.	W'Head #	Tube O.D.	FPT	Hex	Qty
W05418	1366x6x2	3/8	1/8	9/16	5
W05827	1366x6x6	3/8	3/8	7/8	3
W15711	1366x8	1/2	3/8	7/8	3

FITTINGS



IBS, INCORPORATED

Air Brake Fittings for Copper Tubing O04

FITTINGS



45° MALE ELBOW

IBS No.	W'Head #	Tube O.D.	MPT	Qty
W20722	1380x6	3/8	1/4	5
W20291	1380x6x6	3/8	3/8	5
W20292	1380x8	1/2	3/8	4



UNION TEE

IBS No.	W'Head #	Tube O.D.	Qty
W05106	1364x6	3/8	3
W15712	1364x8	1/2	3



90° MALE ELBOW

IBS No.	W'Head #	Tube O.D.	MPT	Qty
W05539	1369x4	1/4	1/8	5
W24318	1369x4x4	1/4	1/4	5
W05522	1369x6x2	3/8	1/8	5
W05102	1369x6	3/8	1/4	5
W05829	1369x6x6	3/8	3/8	5
W22062	1369x6x8	3/8	1/2	5
W20475	1369x8x4	1/2	1/4	3
W15709	1369x8	1/2	3/8	3
W16310	1369x8x8	1/2	1/2	3



MALE RUN TEE

IBS No.	W'Head #	Tube O.D.	MPT	Qty
W05104	1371x6	3/8	1/4	3
W17050	1371x6x6x6	3/8	3/8	3
W15701	1371x8	1/2	3/8	3

IBS, INCORPORATED

Fuller Lines O09



Eaton-Fuller Compression Fittings Used on Eaton-Fuller Transmission Shifters



SPLIT SLEEVE

IBS No.	Tube O.D.	Qty
660A	1/8	20
660B	5/32	20



NUT

IBS No.	Tube O.D.	Qty
661A	1/8	10
661B	5/32	10



UNION

IBS No.	Tube O.D.	Qty
662A	1/8	5
662B	5/32	5



MALE CONNECTOR

IBS No.	Tube O.D.	NPT	Qty
668A	1/8	1/8	5
668B	5/32	1/8	5
668AS	1/8	1/16	5
668BS	5/32	1/16	5



MALE ELBOW

IBS No.	Tube O.D.	NPT	Qty
669A	1/8	1/8	5
669B	5/32	1/8	5

Fuller Transmission Fittings Assortment (Z02)

IBS No. 179R • 20 Items • 95 Pcs

Packaged in a locking steel drawer for easy storage & organization

IBS, Inc. <small>SPECIALTY PRODUCTS FOR MAINTENANCE & REPAIR INDUSTRIALBOLT.COM © 2009 800-678-1906</small>		Fuller Transmission Fittings Compression & Push-On 1/8 & 5/32 Assortment No. 179R			
660A 1/8 SLEEVE FULLER TRANS 	669A 1/8X1/8 M ELBOW FULLER TRANS 	668AS 1/8X1/16 M CONN FULLER TRANS 	1169X2X2S 1/8X1/8 90DGR M SWIV ELB POLY 	56822 1/8 X 1/8 M CONN POLY PUSH NP 	1162X2 1/8 UNION POLY PUSH NP BRASS
660B 5/32 SLEEVE FULLER TRANS 	669B 5/32X1/8 M ELBOW FULLER TRANS 	668A 1/8X1/8 M CONN FULLER TRANS 	1169X3X2S 5/32X1/8 90DGR M SWIV ELB 	56832 5/32 X 1/8 M CONN POLY PUSH 	1162X3 5/32 UNION POLY PUSH NP BRASS
661A 1/8 NUT FULLER TRANS 	662A 1/8 UNION FULLER TRANS 	668BS 5/32 X1/16 M CONN FULLER TRANS 	1169X3X4S 5/32X1/4 90DGR M SWIV ELB 	56834 5/32 X 1/4 M CONN POLY PUSH 	
661B 5/32 NUT FULLER TRANS 	662B 5/32 UNION FULLER TRANS 	668B 5/32X1/8 M CONN FULLER TRANS 			

FITTINGS



IBS, INCORPORATED

Low Pressure Push-On Fittings O10

Low-Pressure Push-On Hose Fittings

Typical Application: Low Pressure Air, Fuel, Lube, and Oil Lines.

- No clamps required.
- Parts have been tested to max 150 PSI. Easy to assemble - Simply push the fitting onto hose (Pressure determined by tube material and hardness).

Assembly Instructions

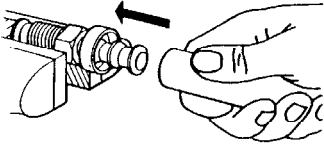

1. Lubricate insert
2. Hold hose at angle shown and push on and up over first barb.
3. Continue to push straight on until hose is seated under protective plastic cap.

(Keep hands back from hose end area so that hose can expand.)

Disassembly Instructions

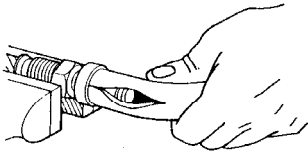

1. Split hose as shown. Do not cut completely through hose. Sealing edge of barb could be damaged.
2. Bend hose and remove with quick pull.

Note: To determine the correct length of hose, subtract the cut-off factor (H.C.O.F.) for each end fitting from the overall length of the assembly.



HOSE MENDER

IBS No.	Hose	O.A.L.	H.C.O.F.	Qty
10004B-Y04	1/4	1.87	1/2	5
10005B-Y05	5/16	1.80	7/16	5
10006B-Y06	3/8	2.00	7/16	5
10008B-Y08	1/2	2.01	1/2	5
10010B-Y10	5/8	3.03	5/8	5
10012B-Y12	3/4	3.03	5/8	5



MALE PIPE RIGID

IBS No.	Hose	MPT	O.A.L.	H.C.O.F.	Qty
10004B-102	1/4	1/8-27	1.43	11/16	5
10004B-104	1/4	1/4-18	1.66	7/8	5
10005B-102	5/16	1/8-27	1.42	11/16	5
10005B-104	5/16	1/4-18	1.66	7/8	5
10006B-102	3/8	1/8-27	1.53	11/16	5
10006B-104	3/8	1/4-18	1.69	7/8	5
10006B-106	3/8	3/8-18	1.76	7/8	5
10008B-104	1/2	1/4-18	1.76	7/8	5
10008B-106	1/2	3/8-18	1.76	15/16	5
10008B-108	1/2	1/2-14	1.97	7/8	5
10010B-108	5/8	1/2-14	2.45	1-3/16	5
10012B-112	3/4	3/4-14	2.45	1-1/4	5

** Note: To determine the correct length of hose, subtract the cut-off factor (H.C.O.F.) for each end fitting from the overall length of the assembly.*

F
I
T
T
I
N
G
S

IBS, INCORPORATED

Low Pressure Push-On Fittings O10



SAE 45° FLARE MALE RIGID

IBS No.	Hose	Tube	Thread	OAL	H.C.O.F.*	Qty
10004B-304	1/4	1/4	7/16-20	1.45	13/16	5
10004B-305	1/4	5/16	1/2-20	1.59	15/16	5
10005B-305	5/16	5/16	1/2-20	1.60	15/16	5
10006B-306	3/8	3/8	5/8-18	1.83	1	5



FEMALE INVERTED RIGID

IBS No.	Hose	Tube	Thread	OAL	H.C.O.F.*	Qty
10004B-A03	1/4	3/16	3/8-24	1.12	1/2	5
10004B-A04	1/4	1/4	7/16-24	1.14	1/2	5
10004B-A05	1/4	5/16	1/2-20	1.18	9/16	5
10005B-A05	5/16	5/16	1/2-20	1.25	9/16	5
10006B-A05	3/8	5/16	1/2-20	1.32	9/16	5
10006B-A06	3/8	3/8	5/8-18	1.35	5/8	5
10008B-A08	1/2	1/2	3/4-18	1.73	3/4	5



SAE 37° (JIC) FEMALE SWIVEL

IBS No.	Hose	Tube	Thread	OAL	H.C.O.F.*	Qty
10004B-604	1/4	1/4	7/16-20	1.38	3/4	5
10006B-606	3/8	3/8	9/16-18	1.62	7/8	5
10008B-608	1/2	1/2	3/4-16	1.90	1	5
10010B-610	5/8	5/8	7/8-14	2.54	1-1/8	5



INVERTED MALE SWIVEL

IBS No.	Hose	Tube	Thread	OAL	H.C.O.F.*	Qty
10004B-B03	1/4	3/16	3/8-24	1.73	1-1/8	5
10004B-B04	1/4	1/4	7/16-24	1.77	1-1/8	5
10004B-B05	1/4	5/16	1/2-20	1.80	1-3/16	5
10005B-B04	5/16	1/4	7/16-24	1.81	1-1/8	5
10005B-B05	5/16	5/16	1/2-20	1.83	1-1/8	5
10005B-B06	5/16	3/8	5/8-18	1.63	1-1/8	5
10006B-B05	3/8	5/16	1/2-20	1.93	1-3/16	5
10006B-B06	3/8	3/8	5/8-18	1.70	1	5
10008B-B08	1/2	1/2	3/4-18	2.24	1-1/4	5



FEMALE SWIVEL

IBS No.	Hose	Tube	Thread	OAL	H.C.O.F.*	Qty
10504B-404	1/4	1/4	7/16-24	1.47	11/16	5
10506B-404	3/8	1/4	7/16-24	1.61	11/16	5
10506B-406	3/8	3/8	5/8-18	1.75	13/16	5



SAE 45° FLARE FEMALE SWIVEL

IBS No.	Hose	Tube	Thread	OAL	H.C.O.F.*	Qty
10004B-404	1/4	1/4	7/16-20	1.3	3/4	5
10004B-405	1/4	5/16	1/2-10	1.42	13/16	5
10005B-405	5/16	5/16	1/2-20	1.58	7/8	5
10006B-405	3/8	5/16	1/2-20	1.60	7/8	5
10006B-406	3/8	3/8	5/8-18	1.62	7/8	5
10008B-408	1/2	1/2	3/4-16	1.90	1	5
10010B-410	5/8	5/8	7/8-14	2.54	1-1/8	5
10012B-412	3/4	3/4	3/4-14	2.66	1-1/4	5

FITTINGS

* Note: To determine the correct length of hose, subtract the cut-off factor (H.C.O.F.) for each end fitting from the overall length of the assembly.



IBS, INCORPORATED

Assortments Z02

Small Push-On Hose Fitting Assortment





















IBS No. 111R • 20 Items - 87 Pieces

Packaged in a locking steel drawer for easy storage & organization



Small Push-On Hose Fittings

Assortment No. 111R

<p>10004B-102 1/4 X 1/8 BRASS PUSH-ON M. PIPE</p> 	<p>10004B-104 1/4 X 1/4 BRASS PUSH-ON M. PIPE</p> 	<p>10005B-102 5/16 X 1/8 PUSH-ON M. PIPE</p> 	<p>10005B-104 5/16 X 1/4 PUSH-ON M. PIPE</p> 	<p>10004B-Y04 1/4 PUSH-ON HOSE MENDER</p> 
<p>10006B-104 3/8 X 1/4 PUSH-ON M. PIPE</p> 	<p>10006B-106 3/8 X 3/8 PUSH-ON M. PIPE</p> 	<p>10004B-404 1/4 X 1/4 PUSH-ON SAE FE.</p> 	<p>10004B-405 1/4 X 5/16 PUSH-ON SAE FE.</p> 	<p>10005B-Y05 5/16 PUSH-ON HOSE MENDER</p> 
<p>10005B-405 5/16 X 5/16 PUSH-ON SAE</p> 	<p>10006B-405 3/8 X 5/16 PUSH-ON SAE</p> 	<p>10006B-406 3/8 X 3/8 PUSH-ON SAE</p> 	<p>10004B-B04 1/4 X 1/4 PUSH-ON M. INV</p> 	<p>10006B-Y06 3/8 PUSH-ON HOSE MENDER</p> 
<p>10004B-B05 1/4 X 5/16 PUSH-ON</p> 	<p>10005B-B04 5/16 X 1/4 PUSH-ON M.</p> 	<p>10005B-B05 5/16 X 5/16 PUSH-ON M. INV</p> 	<p>10006B-B05 3/8 X 5/16 PUSH-ON M.</p> 	<p>10006B-B06 3/8 X 3/8 PUSH-ON M. INV.</p> 

Large Push-On Hose Fitting Assortment













IBS No. 112R • 13 Items - 51 Pieces

Packaged in a locking steel drawer for easy storage & organization



Large Push-On Hose Fittings

Assortment No. 112R

<p>10008B-106 1/2 X 3/8 PUSH-ON M. PIPE</p> 	<p>10008B-108 1/2 X 1/2 PUSH-ON M. PIPE</p> 	<p>10008B-Y08 1/2 PUSH-ON HOSE MENDER</p> 
<p>10010B-108 5/8 X 1/2 PUSH-ON M. PIPE</p> 	<p>10012B-112 3/4 X 3/4 PUSH-ON M. PIPE RIGID</p> 	<p>10010B-Y10 5/8 PUSH-ON HOSE MENDER</p> 
<p>10008B-408 1/2 X 1/2 PUSH-ON SAE FE. SWIV</p> 	<p>10010B-410 5/8 X 5/8 PUSH-ON SAE FE.</p> 	<p>10012B-Y12 3/4 PUSH-ON HOSE MENDER</p> 
<p>10012B-412 PUSH-ON SAE FEMALE SWIVEL</p> 	<p>10008B-B08 1/2 X 1/2 PUSH-ON M. INV</p> 	<p>10006B-606 3/8 X 3/8 PUSH-ON JIC FE.</p> 

FITTINGS

IBS, INCORPORATED

Low Pressure Push-On Fittings O10



Long Barbed Hose Ends

Specifications

- **Hose End Series:** 105 "B" Series
- **Typical Application:** Low pressure shop or service lines.
- **Pressure:** Determined by maximum working pressure for hose size.
- **Material:** CA360 Brass.
- **Advantages:** Easy to assemble — Just push the fitting onto the hose and clamp. Low cost and a good selection of sizes.

Male Pipe



IBS No.	Hose	MPT	A	Hex	Pkg Qty
10502B-102	1/8	1/8	1.00	7/16	5
10503B-102	3/16	1/8	1.16	7/16	5
10503B-104	3/16	1/4	1.43	9/16	5
10504B-102	1/4	1/8	1.54	7/16	5
10504B-104	1/4	1/4	1.61	9/16	5
10504B-106	1/4	3/8	1.72	11/16	5
10505B-102	5/16	1/8	1.60	7/16	5
10505B-104	5/16	1/4	1.77	9/16	5
10506B-102	3/8	1/8	1.53	7/16	5
10506B-104	3/8	1/4	1.70	9/16	5
10506B-106	3/8	3/8	1.72	11/16	5
10506B-108	3/8	1/2	1.95	7/8	1
10508B-104	1/2	1/4	1.71	9/16	1
10508B-106	1/2	3/8	1.72	11/16	1
10508B-108	1/2	1/2	1.94	7/8	1
10508B-112	1/2	3/4	1.95	1-1/8	1
10510B-106	5/8	3/8	1.72	3/4	1
10510B-108	5/8	1/2	1.95	7/8	1
10510B-112	5/8	3/4	1.91	1-1/8	1
10512B-108	3/4	1/2	1.86	7/8	1
10512B-112	3/4	3/4	1.92	1-1/8	1

Assembly Instructions

1. Slide clamp over hose.
 2. Insert barbed end of fitting into hose.
 3. Locate clamp in middle of insert and tighten.
- CAUTION: Hose can be damaged if over-tightened. Refer to important safety information found on the previous page of this catalog.

Female Pipe



IBS No.	Hose	FPT	A	Hex	Pkg Qty
10502B-202	1/8	1/8	.97	9/16	5
10503B-202	3/16	1/8	1.19	9/16	5
10504B-202	1/4	1/8	1.47	9/16	5
10504B-204	1/4	1/4	1.58	11/16	5
10505B-202	5/16	1/8	1.47	9/16	5
10505B-204	5/16	1/4	1.58	11/16	5
10506B-202	3/8	1/8	1.47	9/16	5
10506B-204	3/8	1/4	1.58	11/16	5
10506B-206	3/8	3/8	1.64	13/16	5
10508B-204	1/2	1/4	1.58	11/16	1
10508B-206	1/2	3/8	1.64	13/16	1
10508B-208	1/2	1/2	1.86	1	1

Union



IBS No.	Hose	Pkg Qty
10403B-103	3/16	5
10404B-104	1/4	5
10405B-105	5/16	5
10406B-106	3/8	5
10406B-104	3/8 X 1/4	5
10406B-105	3/8 X 5/16	5
10408B-108	1/2	1
10410B-110	5/8	1
10412B-112	3/4	1

FITTINGS



IBS, INCORPORATED

Assortments Z02

Push-On Hose Fitting Assortments

IBS No. 218R • 19 Items - 78 Pieces

Packaged in a locking steel drawer for easy storage & organization



Long-Barb Push-On Fittings

1/8", 3/16", 1/4", 5/16"

Assortment No. 218R

<p>10403B-103 3/16 LONG BARB UNION</p> 	<p>10404B-104 1/4 LONG BARB UNION</p> 	<p>10405B-105 5/16 LONG BARB UNION</p> 	<p>10406B-104 3/8 X 1/4 LONG BARB UNION</p> 	<p>10406B-105 3/8 X 5/16 LONG BARB UNION</p> 
<p>10502B-102 1/8 X 1/8 M. LONG BARB H. END</p> 	<p>10503B-102 3/16 X 1/8 M. LONG BARB H. END</p> 	<p>10503B-104 3/16 X 1/4 M. LONG BARB H. END</p> 	<p>10504B-102 1/4 X 1/8 M. LONG BARB H. END</p> 	<p>10504B-104 1/4 X 1/4 M LONG BARB HOSE END</p> 
<p>10504B-106 1/4 X 3/8 M. LONG BARB H. END</p> 	<p>10505B-102 5/16 X 1/8 M. LONG BARB H. END</p> 	<p>10505B-104 5/16 X 1/4 M. LONG BARB H. END</p> 	<p>10502B-202 1/8 X 1/8 F. LONG BARB H. END</p> 	<p>10503B-202 3/16 X 1/8 F. LONG BARB H. END</p> 
<p>10504B-202 1/4 X 1/8 F. LONG BARB H. END</p> 	<p>10504B-204 1/4 X 1/4 F. LONG BARB H. END</p> 	<p>10505B-202 5/16 X 1/8 F. LONG BARB H. END</p> 	<p>10505B-204 5/16 X 1/4 F. LONG BARB H. END</p> 	



Push-On Hose Fitting Assortments

IBS No. 219R • 16 Items - 56 Pieces

Packaged in a locking steel drawer for easy storage & organization



Long-Barb Push-On Fittings

3/8", 1/2, 3/4"

Assortment No. 219R

<p>10406B-106 3/8 LONG BARB UNION</p> 	<p>10408B-108 1/2 LONG BARB UNION</p> 	<p>10410B-110 5/8 LONG BARB UNION</p> 	<p>10412B-112 3/4 LONG BARB UNION</p> 
<p>10506B-104 3/8 X 1/4 M. LONG BARB H. END</p> 	<p>10506B-106 3/8 X 3/8 M. LONG BARB H. END</p> 	<p>10508B-106 1/2 X 3/8 M. LONG BARB H. END</p> 	<p>10508B-108 1/2 X 1/2 M. LONG BARB H. END</p> 
<p>10510B-108 5/8 X 1/2 M. LONG BARB H. END</p> 	<p>10512B-108 3/4 X 1/2 M LONG BARB HOSE</p> 	<p>10512B-112 3/4 X 3/4 M. LONG BARB H. END</p> 	<p>10506B-204 3/8 X 1/4 F. LONG BARB H. END</p> 
<p>10506B-206 3/8 X 3/8 F. LONG BARB H. END</p> 	<p>10508B-204 1/2 X 1/4 F. LONG BARB H. END</p> 	<p>10508B-206 1/2 X 3/8 F. LONG BARB H. END</p> 	<p>10508B-208 1/2 X 1/2 F. LONG BARB H. END</p> 



FITTINGS

IBS, INCORPORATED

Poly-Push Fittings O12



Poly-Matic® Nickel Plated Brass Fittings Push-to-Connect — The Grip That Won't Quit!



Poly-Matic Fittings are known to have the best retention capability of any Push-to-Connect Fitting on the market. The nickel plated brass bodies, high impact acetal release collars and brass spring locking teeth provide assurance for long life as well as an attractive appearance that has set a new industry standard.

FEATURES & BENEFITS

- Designed for use with **Polyethylene, Nylon or 95A Durometer Polyurethane** tubing.
- **Quick & easy connection** — wide release collar allows fast and trouble-free tubing removal.
- **Fully reusable** — can be used many times over (no replacement ferrules or inserts are needed).
- Automatically **locks and seals** to maximum working pressure.
- **Does not limit tubing flow** because no part of the fitting goes inside the tubing.
- Male pipe threads supplied with factory applied sealant.
- **Positive grip action locking teeth** are not affected by vibration (with or without pressure).
- Completely **silicone free** construction.
- **Compact design** allows fittings to be closely mounted.
- **Installation is easy — no tools are required.** To connect, simply push the tubing into the fitting until it bottoms. To disconnect, all you have to do is push the collar down, and pull the tubing out.

F
I
T
T
I
N
G
S



IBS, INCORPORATED

Poly-Push Fittings O12

Poly-Matic Nickel Plated Brass Fittings — Fractional Male Connectors

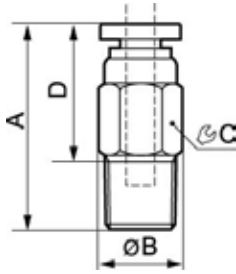

IBS No.	Tube Size	MNPT Thread	A	B	C	D	E	Qty
56822	1/8	1/8	.827	.315	7/16	.63	.394	5
56824	1/8	1/4	.827	.315	7/16	.63	.394	5
56832	5/32	1/8	.846	.315	7/16	.63	.394	5
56834	5/32	1/4	.846	.433	9/16	.63	.394	5
56842	1/4	1/8	.945	.315	1/2	.669	.504	5
56844	1/4	1/4	.925	.433	9/16	.669	.504	5
56846	1/4	3/8	.965	.472	11/16	.669	.504	5
56852	5/16	1/8	1.063	.315	9/16	.709	.543	5
56854	5/16	1/4	1.043	.433	9/16	.709	.543	5
56856	5/16	3/8	.984	.472	11/16	.709	.543	5
56862	3/8	1/8	1.146	.315	11/16	.76	.661	5
56864	3/8	1/4	1.224	.433	11/16	.76	.661	5
56866	3/8	3/8	1.087	.472	11/16	.76	.661	5
56868	3/8	1/2	1.126	.591	7/8	.76	.661	5
56884	1/2	1/4	1.299	.433	7/8	.787	.807	5
56886	1/2	3/8	1.22	.472	7/8	.787	.807	5
56888	1/2	1/2	1.161	.591	7/8	.787	.807	5

Unions

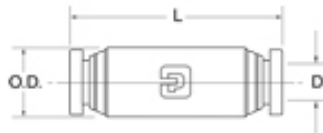

IBS No.	Tube Size (D)	OD	L	D Flow Dia.	Qty
1162X2	1/8	.250	1.15	.094	5
1162X3	5/32	.375	.141	.125	5
1162X4	1/4	.500	.143	.188	5
1162X5	5/16	.562	.165	.250	5
1162X6	3/8	.625	.166	.312	5
1162X8	1/2	.750	.182	.375	5

Union Reducers

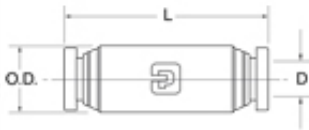

IBS No.	Tube OD LG	Tube OD SM	L	D Flow Dia.	Qty
1162X4X2	1/4	1/8	1.43	.094	5
1162X6X4	3/8	1/4	1.66	.188	5
1162X8X6	1/2	3/8	1.82	.312	5

Union Elbows

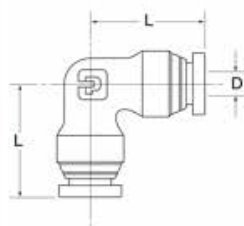

IBS No.	Tube Size	L	D Flow Dia.	Qty
1165X3	5/32	.77	.125	5
1165X4	1/4	.85	.188	5
1165X5	5/16	.97	.250	5
1165X6	3/8	1.01	.312	5
1165X8	1/2	1.15	.375	5

FITTINGS

Poly-Matic Nickel Plated Brass Fittings — Fractional Male 90° Elbows

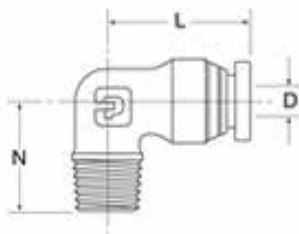

IBS No.	Tube Size	NPTF	L	N	Qty
1169X2X2	1/8	1/8	.74	.67	5
1169X3X2	5/32	1/8	.77	.67	5
1169X3X4	5/32	1/4	.77	.67	5
1169X4X2	1/4	1/8	.85	.67	5
1169X4X4	1/4	1/4	.85	.87	5
1169X6X4	3/8	1/4	1.01	.94	5
1169X6X6	3/8	3/8	1.01	1.01	5
1169X8X6	1/2	3/8	1.15	1.00	5

360° Male Swivel Elbows

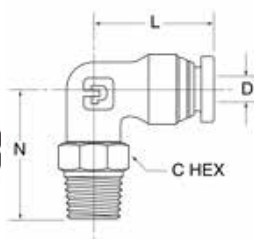

IBS No.	Tube Size	NPTF	C (Hex)	L	N	D Flow Dia.	Qty
1169X2X2S	1/8	1/8	7/16	.74	.92	.094	5
1169X3X2S	5/32	1/8	7/16	.77	.92	.125	5
1169X3X4S	5/32	1/4	9/16	.77	1.10	.125	5
1169X4X2S	1/4	1/8	7/16	.85	.92	.188	5
1169X4X4S	1/4	1/4	9/16	.85	1.10	.188	5
1169X4X6S	1/4	3/8	11/16	.85	1.19	.188	5
1169X5X2S	5/16	1/8	9/16	.97	1.02	.250	5
1169X5X4S	5/16	1/4	9/16	.97	1.24	.250	5
1169X6X2S	3/8	1/8	9/16	1.01	1.02	.312	5
1169X6X4S	3/8	1/4	9/16	1.01	1.24	.312	5
1169X6X6S	3/8	3/8	11/16	1.01	1.24	.312	5
1169X8X6S	1/2	3/8	11/16	1.15	1.31	.375	5
1169X8X8S	1/2	1/2	7/8	1.15	1.52	.375	5

Male Swivel Branch Tees

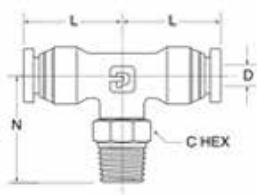

IBS No.	Tube Size	NPTF	C (Hex)	L	N	D Flow Dia.	Qty
1172X2X2	1/8	1/8	7/16	.74	.92	.094	5
1172X3X2	5/32	1/8	7/16	.77	.92	.125	5
1172X4X2	1/4	1/8	7/16	.85	.92	.188	5
1172X4X4	1/4	1/4	9/16	.85	1.10	.188	5
1172X5X4	5/16	1/4	9/16	.97	1.24	.250	5
1172X6X4	3/8	1/4	9/16	1.01	1.24	.250	5
1172X6X6	3/8	3/8	11/16	1.01	1.24	.250	5
1172X8X6	1/2	3/8	11/16	1.15	1.31	.375	5
1172X8X8	1/2	1/2	7/8	1.15	1.52	.375	5

FITTINGS



IBS, INCORPORATED

Poly-Push Fittings O12

Push-Lock Nickel Plated Brass Fittings — Fractional Union Tees

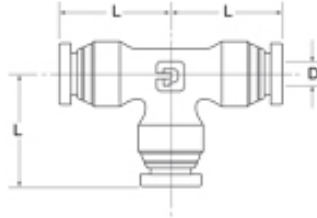

IBS No.	Tube Size	L	D Flow Dia.	Qty
1164X2	1/8	.74	.094	5
1164X3	5/32	.77	.125	5
1164X4	1/4	.85	.188	5
1164X5	5/16	.97	.250	5
1164X6	3/8	1.01	.250	5
1164X8	1/2	1.15	.375	5

FITTINGS

Push-Lock Nickel Plated Brass Fittings Assortment (Z02)

IBS No. 197R • 18 Items 42 Pieces

Packaged in a locking steel drawer for easy storage & organization.

Poly-Matic Nickel Plated Brass Fittings

Assortment No. 197R

<p>56822 1/8 X 1/8 COMPOSITE M CONN</p>	<p>56842 1/4 X 1/8 COMPOSITE M CONN</p>	<p>56844 1/4 X 1/4 COMPOSITE M CONN</p>	<p>56862 3/8 X 1/8 COMPOSITE M CONN</p>	<p>56864 3/8 X 1/4 COMPOSITE M CONN</p>
<p>56866 3/8 X 3/8 COMPOSITE M CONN</p>	<p>56886 1/2 X 3/8 COMPOSITE M CONN</p>	<p>1169X2X2S 1/8X1/8 90DGR M SWIV ELB POLY</p>	<p>1169X4X2S 1/4X1/8 90DGR M SWIV ELB POLY</p>	<p>1169X4X4S 1/4X1/4 90DGR M SWIV ELB POLY</p>
<p>1169X6X2S 3/8 X 1/8 90DGR M SWIV POLY</p>	<p>1169X6X4S 3/8X1/4 90DGR M SWIV ELB POLY</p>	<p>1169X6X6S 3/8X3/8 90DGR M SWIV ELB POLY</p>	<p>1169X8X6S 1/2X3/8 90DGR M SWIV ELB POLY</p>	
<p>1162X2 1/8 UNION POLY PUSH NP BRASS</p>	<p>1162X4 1/4 UNION POLY PUSH NP BRASS</p>	<p>1162X6 3/8 UNION POLY PUSH NP BRASS</p>	<p>1162X8 1/2 UNION POLY PUSH NP BRASS</p>	

IBS, INCORPORATED

Poly-Push Fittings O12



Push-Lock Nickel Plated Brass Fittings — Metric

Male Connectors

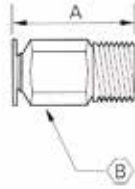

IBS No.	Tube OD	BSPT	A in	A mm	B in	Qty
201213	M6	R1/4	0.90	22.7	9/16	10
201217	M8	R1/8	1.35	34.4	9/16	10
201219	M8	R3/8	1.10	28.1	11/16	10
201224	M10	R3/8	1.43	36.4	11/16	10
201225	M10	R1/2	1.09	27.7	7/8	10

While Supplies Last

360° Swivel Elbows

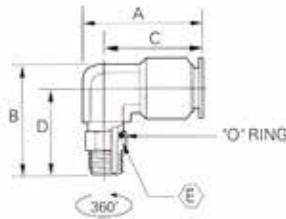

IBS No.	Tube OD	BSPT	A in	B in	C in	D in	E in	Qty
202203	M4	R1/4	1.16	1.16	0.94	0.94	9/16	10
202224	M10	R3/8	1.67	1.67	1.31	1.26	11/16	5

While Supplies Last

Union Elbows

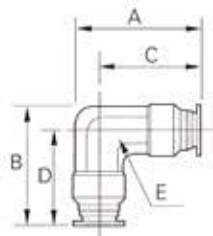

IBS No.	Tube OD mm	A in	B in	C in	D in	E in	Qty
204250	M4	1.14	1.14	0.92	0.92	23/64	10
204263	M6	1.25	1.25	0.98	0.98	23/64	10
204268	M8	1.29	1.29	1.00	1.00	1/2	5
204272	M10	1.65	1.65	1.31	1.31	1/2	5

While Supplies Last

Straight Unions

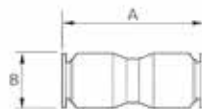

IBS No.	Tube OD mm	A in	A mm	B in	B mm	Qty
209250	M4	1.70	43.1	3/8	9.5	10
209268	M8	1.76	44.7	9/16	14.3	5

While Supplies Last

FITTINGS



IBS, INCORPORATED

Poly-Push Fittings O12

Push-Lock Nickel Plated Brass Fittings — Metric

Union Tees

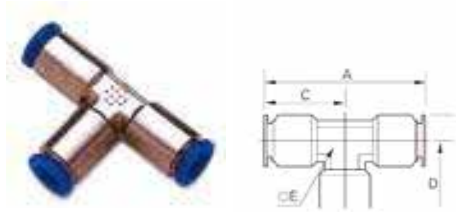

While Supplies Last

IBS No.	Tube OD mm	A in	B in	C in	D in	E in	Qty
205268	M8	2.00	1.34	1.00	1.00	1/2	5

Poly-Matic Nickel Plated Brass Fittings — Metric

Union Tees



While Supplies Last

IBS No.	Tube OD mm	BSPT	A in	B in	C in	D in	E in	Qty
207212	M6	R1/8	1.96	1.18	0.98	0.94	7/16	10
207213	M6	R1/4	1.96	1.23	0.98	0.99	9/16	5
202217	M8	R1/8	2.00	1.38	1.00	1.04	7/16	5
207218	M8	R1/4	2.00	1.48	1.00	1.14	9/16	5
207223	M10	R1/4	2.61	1.48	1.31	1.14	9/16	5
207224	M10	R3/8	2.61	1.60	1.31	1.26	11/16	5
207229	M12	R3/8	3.08	1.69	1.54	1.27	11/16	5

F
I
T
T
I
N
G
S

Push-Lock Brass Fittings — D.O.T. Male Connectors



IBS No.	Tube OD	Pipe Thread	A	Hex	Qty
86832	5/32	1/8	0.79	0.43	5
86842	1/4	1/8	0.96	0.44	5
86844	1/4	1/4	0.88	0.56	5
86846	1/4	3/8	1.20	0.68	5
86862	3/8	1/8	1.16	0.68	5
86864	3/8	1/4	1.19	0.68	5
86866	3/8	3/8	1.00	0.68	5
86868	3/8	1/2	1.10	0.87	5
86884	1/2	1/4	1.68	0.87	5
86886	1/2	3/8	1.64	0.87	5
86888	1/2	1/2	1.72	0.87	5
86890	5/8	3/8	1.87	1.06	1
86892	5/8	1/2	2.12	1.06	1

360° Male Swivel Elbows

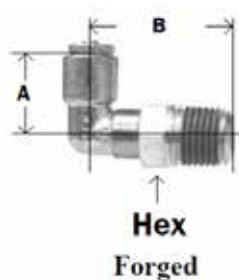

IBS No.	Tube OD	Pipe Thread	A	B	Hex	Qty
87932	5/32	1/8	0.79	0.88	0.44	5
87942	1/4	1/8	0.98	0.91	0.43	5
87944	1/4	1/4	1.02	0.88	0.56	5
87946	1/4	3/8	1.02	1.13	0.68	5
87962	3/8	1/8	1.21	1.05	0.43	5
87964	3/8	1/4	1.15	1.05	0.56	5
87966	3/8	3/8	1.10	1.23	0.59	5
87968	3/8	1/2	1.07	1.52	0.87	5
87984	1/2	1/4	1.27	1.27	0.87	5
87986	1/2	3/8	1.27	1.42	0.87	5
87988	1/2	1/2	1.27	1.62	0.87	5
87990	5/8	3/8	1.54	1.41	0.68	1
87992	5/8	1/2	1.54	1.71	0.87	1

90° Union Elbows

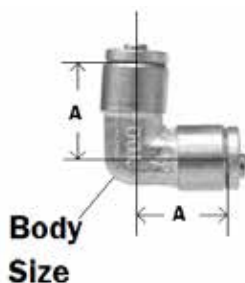

IBS No.	Tube OD	A	Qty
86544	1/4	1.05	5
86566	3/8	1.10	5
86588	1/2	1.26	5

FITTINGS



IBS, INCORPORATED

Poly-Push Fittings O12

Push-Lock Brass Fittings — D.O.T. Male 45° Swivel Elbows

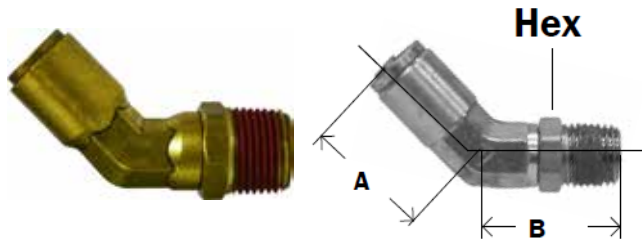

IBS No.	Tube OD	NPTF Male	A	B	Hex	Qty
88042	1/4	1/8	0.99	0.98	0.43	5
88044	1/4	1/4	0.77	0.94	0.56	5
88064	3/8	1/4	1.07	1.13	0.56	5
88066	3/8	3/8	1.08	1.23	0.68	5
88084	1/2	1/4	1.22	1.12	0.56	5
88086	1/2	3/8	1.20	1.31	0.68	5
88088	1/2	1/2	1.20	1.61	0.88	5
88108	5/8	1/2	1.39	1.68	0.87	5

FITTINGS

Male Swivel Branch Tees

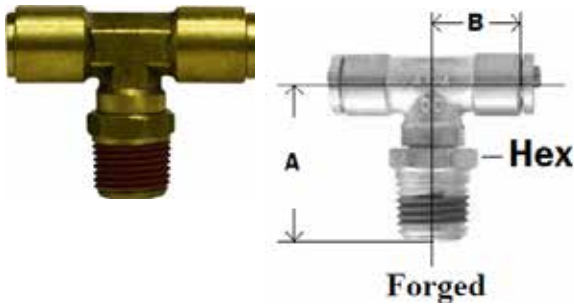

IBS No.	Tube Size	NPT	A	B	Hex	Qty
87242	1/4	1/8	0.91	0.83	0.43	5
87244	1/4	1/4	1.04	1.01	0.56	5
87264	3/8	1/4	1.10	1.10	0.56	5
87266	3/8	3/8	1.25	1.06	0.68	5
87284	1/2	1/4	1.34	1.28	0.87	5
87286	1/2	3/8	1.36	1.31	0.68	5
87288	1/2	1/2	1.26	1.61	0.87	5

Union Tees

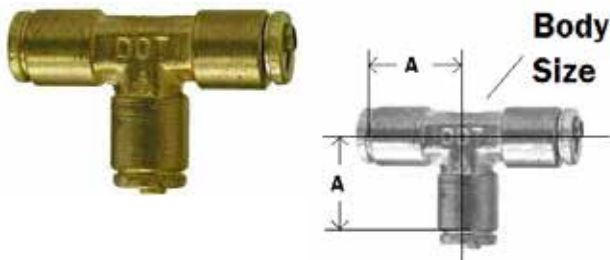

IBS No.	Tube OD	A	Body Size	Qty
86444	1/4	1.01	0.37	5
86466	3/8	1.07	0.50	5
86488	1/2	1.26	0.62	5
86490	5/8	1.32	0.69	1

Unions

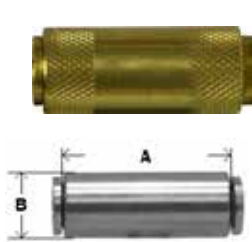

IBS No.	Tube OD	A	B	Qty
86233	5/32	1.18	0.39	5
86244	1/4	1.22	0.47	5
86266	3/8	1.77	0.67	5
86288	1/2	2.01	0.81	5
86290	5/8	2.42	1.00	1

Bulkhead Unions

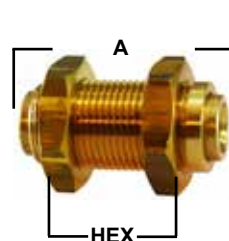

IBS No.	Tube OD	A	Hex	Qty
88244	1/4	1.90	0.68	5
88266	3/8	1.55	1.06	5
88288	1/2	1.82	1.18	5
88290	5/8	2.42	1.25	1

IBS, INCORPORATED

Assortments Z02



Push-Lock DOT Air Brake Fittings

IBS No. 180R • 12 Items 36 Pieces

Packaged in a locking steel drawer for easy storage & organization.

IBS, Inc. <small>SPECIALTY PRODUCTS FOR MAINTENANCE & REPAIR INDUSTRIALBOLT.COM © © © 800-678-1906</small>		Push Lock DOT Air Brake Fittings 1/4" & 3/8"	
Assortment No. 180R			
86842 1/4 X 1/8 POLY-MATIC DOT MALE 	87942 1/4 X 1/8 POLY-MATIC DOT M 	86244 1/4 POLY-MATIC DOT UNION 	
86844 1/4 X 1/4 POLY-MATIC DOT MALE 	87944 1/4 X 1/4 POLY-MATIC M SWIVEL 	86266 3/8 POLY-MATIC DOT UNION 	
86864 3/8 X 1/4 POLY-MATIC DOT MALE 	87964 3/8 X 1/4 POLY-MATIC DOT M 	88244 1/4 POLY-MATIC DOT BULK HEAD 	
86866 3/8 X 3/8 POLY-MATIC DOT MALE 	87966 3/8 X 3/8 POLY-MATIC DOT M 	88266 3/8 POLY-MATIC DOT BULK HEAD 	

Push-Lock DOT Air Brake Fittings

IBS No. 181R • 18 Items 45 Pieces

Packaged in a locking steel drawer for easy storage & organization.

IBS, Inc. <small>SPECIALTY PRODUCTS FOR MAINTENANCE & REPAIR INDUSTRIALBOLT.COM © © © 800-678-1906</small>		Push Lock DOT Air Brake Fittings 1/4", 3/8" and 1/2"	
Assortment No. 181R			
87944 1/4 X 1/4 POLY-MATIC M SWIVEL ELBOW 	87966 3/8 X 3/8 POLY-MATIC DOT M SWIVEL ELBOW 	87988 1/2 X 1/2 POLY-MATIC DOT M SWIVEL ELBOW 	
87942 1/4 X 1/8 POLY-MATIC DOT M SWIVEL ELBOW 	87964 3/8 X 1/4 POLY-MATIC DOT M SWIVEL ELBOW 	87986 1/2 X 3/8 POLY-MATIC DOT M SWIVEL ELBOW 	
86844 1/4 X 1/4 POLY-MATIC DOT MALE CONNECTOR 	86866 3/8 X 3/8 POLY-MATIC DOT MALE CONNECTOR 	86888 1/2 X 1/2 POLY-MATIC DOT MALE CONNECTOR 	
86842 1/4 X 1/8 POLY-MATIC DOT MALE CONNECTOR 	86864 3/8 X 1/4 POLY-MATIC DOT MALE CONNECTOR 	86886 1/2 X 3/8 POLY-MATIC DOT MALE CONNECTOR 	
88244 1/4 POLY-MATIC DOT BULK HEAD UNION 	88266 3/8 POLY-MATIC DOT BULK HEAD UNION 	88288 1/2 POLY-MATIC DOT BULK HEAD UNION 	
86244 1/4 POLY-MATIC DOT UNION 	86266 3/8 POLY-MATIC DOT UNION 	86288 1/2 POLY-MATIC DOT UNION 	

FITTINGS



IBS, INCORPORATED

Assortments Z02

Poly-Matic® DOT Air Brake Fittings

IBS No. 334R • 17 Items 33 Pieces



















Packaged in a locking steel drawer for easy storage & organization.



Push Lock DOT Fittings

5/32", 1/4" & 3/8"

Assortment No. 334R

86233 5/32 POLY-MATIC DOT UNION 	86244 1/4 POLY-MATIC DOT UNION 	86266 3/8 POLY-MATIC DOT UNION 	86444 1/4 POLY-MATIC DOT UNION TEE 	86466 3/8 POLY-MATIC DOT UNION TEE 
86842 1/4 X 1/8 POLY-MATIC DOT MALE 	86844 1/4 X 1/4 POLY-MATIC DOT MALE 	86864 3/8 X 1/4 POLY-MATIC DOT MALE 	86866 3/8 X 3/8 POLY-MATIC DOT MALE 	
87242 1/4X1/8 POLY-MATIC DOT M SWIV 	87244 1/4 X 1/4 POLY-MATIC DOT M SWIV 	87264 3/8X1/4 POLY-MATIC DOT M SWIV 	87266 3/8X3/8 POLY-MATIC DOT M SWIV 	
87942 1/4 X 1/8 POLY-MATIC DOT M 	87944 1/4 X 1/4 POLY-MATIC M SWIVEL 	87964 3/8 X 1/4 POLY-MATIC DOT M 	87966 3/8 X 3/8 POLY-MATIC DOT M 	

Poly-Matic® DOT Air Brake Fittings

IBS No. 335R • 16 Items 21 Pieces

















Packaged in a locking steel drawer for easy storage & organization.



Push Lock DOT Fittings

3/8" & 1/2"

Assortment No. 335R

86266 3/8 POLY-MATIC DOT UNION 	86288 1/2 POLY-MATIC DOT UNIONS 		86466 3/8 POLY-MATIC DOT UNION TEE 	86488 1/2 POLY-MATIC DOT UNION TEE 
86866 3/8 X 3/8 POLY-MATIC DOT MALE 	86884 1/2 X 1/4 POLY-MATIC DOT MALE 	86886 1/2 X 3/8 POLY-MATIC DOT MALE 	86888 1/2 X 1/2 POLY-MATIC DOT MALE 	
87266 3/8X3/8 POLY-MATIC DOT M SWIV 	87284 1/2X1/4 POLY-MATIC DOT M SWIV 	87286 1/2X3/8 POLY-MATIC DOT M SWIV 	87288 1/2X1/2 POLY-MATIC DOT M SWIV 	
87966 3/8 X 3/8 POLY-MATIC DOT M 	87984 1/2 X 1/4 POLY-MATIC DOT M 	87986 1/2 X 3/8 POLY-MATIC DOT M 	87988 1/2 X 1/2 POLY-MATIC DOT M 	

FITTINGS

IBS, INCORPORATED

Composite DOT Push Connect Fittings O12



Composite Body DOT Air Brake Fittings One Touch Connection for Easy Installation



- Composite DOT fittings **do not rust or corrode**.
- **One touch connection** reduces installation time and cost.
- **Rugged ultraviolet and vibration resistant** composite body for secure connections and longer lasting life.
- **Lightweight but durable construction** improves fuel efficiency and payload potential.
- **Reusable — connect and disconnect** fittings several times.
- **Designed only for use in applications where air is utilized as an operating fluid.**

SPECIFICATIONS FOR FMVSS (D.O.T) AND SAE COMPLIANT FITTINGS

Operating Fluid		AIR					
Max Operating Pressure		145psi (1.0MPa)					
Proof Pressure	Size	5/32"	1/4"	3/8"	1/2"	5/8"	3/4"
	at 75°F (24°C)	1200 psi	1200 psi	1400 psi	950 psi	900 psi	800 psi
	at 200°F (93°C)	450psi (3.1MPa)					
Recommended Fluid & Ambient Temperature		-40°F to 140°F (-40°C to 60°C)					
Leak Rate at -40°F (-40°C)		7 Ncm ³ / min. or less					
Thread	Thread Portion	ANSI / ASME B1.20.1, 1983 R1992					
	Nut	JIS B 0208 (Unified Fine Thread) ISO 263					
Thread Sealant		Fluorine / Acrylic					
Applicable Standards		D.O.T. FMVSS 49 CFR 571.106, SAE J2494-3					
Applicable Tubing		Tubing conforming to both SAE J844 and D.O.T. FMVSS 49 CFR 571.106 Material: Nylon 12					
Tube O.D.		5/32", 1/4", 3/8", 1/2", 5/8", 3/4"					

FITTINGS



STRAIGHT UNION

IBS No.	Tube OD inch	Qty
86071	5/32	1
86072	1/4	1
86073	3/8	1
86074	1/2	1
86075	5/8	1



UNION TEE

IBS No.	Tube OD inch	Qty
86081	1/4	1
86082	3/8	1
86083	1/2	1
86084	5/8	1



UNION 90° ELBOW

IBS No.	Tube OD inch	Qty
86077	1/4	1
86078	3/8	1
86079	1/2	1



IBS, INCORPORATED

Composite DOT Push Connect Fittings O12

FITTINGS



MALE CONNECTOR

IBS No.	Tube OD inch	NPT Thread	Qty
86001	5/32	1/8-27	1
86003	1/4	1/8-27	1
86004	1/4	1/4-18	1
86005	1/4	3/8-18	1
86006	3/8	1/8-27	1
86007	3/8	1/4-18	1
86008	3/8	3/8-18	1
86009	3/8	1/2-14	1
86010	1/2	1/4-18	1
86011	1/2	3/8-18	1
86012	1/2	1/2-14	1
86013	5/8	3/8-18	1
86014	5/8	1/2-14	1



FEMALE CONNECTOR

IBS No.	Tube OD inch	NPT Thread	Qty
86058	5/32	1/8-27	1
86059	5/32	1/4-18	1
86060	1/4	1/8-27	1
86061	1/4	1/4-18	1
86062	1/4	3/8-18	1
86063	3/8	1/8-27	1
86064	3/8	1/4-18	1
86065	3/8	3/8-18	1
86066	3/8	1/2-14	1
86067	1/2	1/8-27	1
86068	1/2	1/4-18	1
86069	1/2	3/8-18	1
86070	1/2	1/2-14	1



BULKHEAD UNION

IBS No.	Tube OD inch	UNF Thread	Qty
86086	1/4	9/16-18	1
86087	3/8	7/8-14	1
86088	1/2	1-12	1
86089	5/8	1-1/8-12	1



90° MALE ELBOW

IBS No.	Tube OD inch	NPT Thread	Qty
86016	5/32	1/8-27	1
86017	1/4	1/8-27	1
86018	1/4	1/4-18	1
86019	1/4	3/8-18	1
86020	3/8	1/8-27	1
86021	3/8	1/4-18	1
86022	3/8	3/8-18	1
86023	3/8	1/2-14	1
86024	1/2	1/4-18	1
86025	1/2	3/8-18	1
86026	1/2	1/2-14	1
86027	5/8	3/8-18	1
86028	5/8	1/2-14	1



45° MALE ELBOW

IBS No.	Tube OD inch	NPT Thread	Qty
86031	1/4	1/8-27	1
86032	1/4	1/4-18	1
86034	3/8	1/4-18	1
86035	3/8	3/8-18	1
86038	1/2	1/4-18	1
86039	1/2	3/8-18	1
86040	1/2	1/2-14	1
86041	5/8	3/8-18	1
86042	5/8	1/2-14	1



MALE BRANCH TEE

IBS No.	Tube OD inch	NPT Thread	Qty
86047	1/4	1/8-27	1
86048	1/4	1/4-18	1
86049	1/4	3/8-18	1
86050	3/8	1/4-18	1
86051	3/8	3/8-18	1
86053	1/2	1/4-18	1
86054	1/2	3/8-18	1
86055	1/2	1/2-14	1



















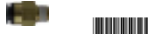

IBS, INCORPORATED

Composite DOT Push Connect Fittings O12

Composite Body DOT Air Brake Fittings

IBS No. 829R • 18 Items • 30 Pcs



 IBS, Inc. <small>SPECIALTY PRODUCTS FOR MAINTENANCE & REPAIR INDUSTRIALBOLT.COM © © © 800-678-1906</small>			Composite DOT Push Connect Fittings - 1/4", 3/8" and 1/2" <small>Assortment No. 829R</small>
86018 1/4 X 1/4 COMPOSITE DOT 90DGR MALE ELBOW PUSH CONNECT 	86022 3/8 X 3/8 COMPOSITE DOT 90DGR MALE ELBOW PUSH CONNECT 	86026 1/2 X 1/2 COMPOSITE DOT 90DGR MALE ELBOW PUSH CONNECT 	
86017 1/4 X 1/8 COMPOSITE DOT 90DGR MALE ELBOW PUSH CONNECT 	86021 3/8 X 1/4 COMPOSITE DOT 90DGR MALE ELBOW PUSH CONNECT 	86025 1/2 X 3/8 COMPOSITE DOT 90DGR MALE ELBOW PUSH CONNECT 	
86004 1/4 X 1/4 COMPOSITE DOT MALE PUSH CONNECT 	86008 3/8 X 3/8 COMPOSITE DOT MALE PUSH CONNECT 	86012 1/2 X 1/2 COMPOSITE DOT MALE PUSH CONNECT 	
86003 1/4 X 1/8 COMPOSITE DOT MALE PUSH CONNECT 	86007 3/8 X 1/4 COMPOSITE DOT MALE PUSH CONNECT 	86011 1/2 X 3/8 COMPOSITE DOT MALE PUSH CONNECT 	
86086 1/4 X 9/16-18 COMPOSITE DOT BULKHEAD UNION PUSH CONNECT 	86087 3/8 X 7/8-14 COMPOSITE DOT BULKHEAD UNION PUSH CONNECT 	86088 1/2 X 1-12 COMPOSITE DOT BULKHEAD UNION PUSH CONNECT 	
86072 1/4 COMPOSITE DOT UNION PUSH CONNECT 	86073 3/8 COMPOSITE DOT UNION PUSH CONNECT 	86074 1/2 COMPOSITE DOT UNION PUSH CONNECT 	

FITTINGS



IBS, INCORPORATED

Poly-Push Composite Fittings O12

Poly-Push Composite Fittings — Fractional



FEATURES & BENEFITS

- Made from lightweight, rugged polymer, Poly-Push Nickel Composite push-in fittings provide both high performance and easy installation.
- **Fully reusable** — can be used many times over (no replacement ferrules or inserts are needed).
- Automatically **locks and seals** to maximum working pressure.
- **Does not limit tubing flow** — no part of the fitting goes inside the tubing.
- **External and internal hex and port plugs as well as sealed threads** produce a secure, easy installation.
- **Positive grip action locking teeth** prevent loosening due to vibration for optimum safety.
- **Easy and instant connections** — simply push the tubing in to the fitting to connect.
- **Easy and instant disconnects** — apply pressure to the release collar to release the teeth from the tubing.

Male Connectors — Nickel Plated Brass

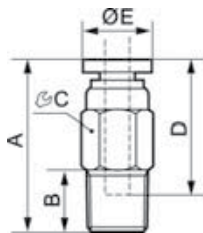

IBS No.	Tube OD inch	MNPT Thread	A	B	C	D	E	Qty
56822	1/8	1/8	.827	.315	7/16	.63	.394	5
56824	1/8	1/4	.827	.315	7/16	.63	.394	5
56832	5/32	1/8	.846	.315	7/16	.63	.394	5
56834	5/32	1/4	.846	.433	9/16	.63	.394	5
56842	1/4	1/8	.945	.315	1/2	.669	.504	5
56844	1/4	1/4	.925	.433	9/16	.669	.504	5
56846	1/4	3/8	.965	.472	11/16	.669	.504	5
56852	5/16	1/8	1.063	.315	9/16	.709	.543	5
56854	5/16	1/4	1.043	.433	9/16	.709	.543	5
56856	5/16	3/8	.984	.472	11/16	.709	.543	5
56862	3/8	1/8	1.146	.315	11/16	.76	.661	5
56864	3/8	1/4	1.224	.433	11/16	.76	.661	5
56866	3/8	3/8	1.087	.472	11/16	.76	.661	5
56868	3/8	1/2	1.126	.591	7/8	.76	.661	5
56884	1/2	1/4	1.299	.433	7/8	.787	.807	5
56886	1/2	3/8	1.22	.472	7/8	.787	.807	5
56888	1/2	1/2	1.161	.591	7/8	.787	.807	5

FITTINGS

IBS, INCORPORATED

Poly-Push Composite Fittings O12



Poly-Push Composite Fittings — Fractional Male Elbows

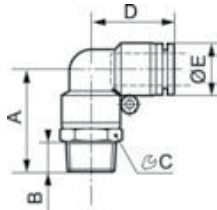

IBS No.	Tube OD	MNPT	A	B	C	D	E	Qty
57922	1/8	1/8	1.004	.315	7/16	.689	.394	5
57924	1/8	1/4	1.004	.315	7/16	.689	.394	5
57932	5/32	1/8	1.004	.315	7/16	.689	.394	5
57934	5/32	1/4	1.122	.433	9/16	.689	.394	5
57942	1/4	1/8	1.122	.315	1/2	.807	.504	5
57944	1/4	1/4	1.22	.433	9/16	.807	.504	5
57946	1/4	3/8	1.28	.472	11/16	.807	.504	5
57952	5/16	1/8	1.181	.315	9/16	.886	.543	5
57954	5/16	1/4	1.299	.433	9/16	.886	.543	5
57956	5/16	3/8	1.358	.472	11/16	.886	.543	5
57962	3/8	1/8	1.327	.315	11/16	1.035	.661	5
57964	3/8	1/4	1.445	.433	11/16	1.035	.661	5
57966	3/8	3/8	1.484	.472	11/16	1.035	.661	5
57968	3/8	1/2	1.642	.591	7/8	1.035	.661	5
57984	1/2	1/4	1.543	.433	7/8	1.118	.807	5
57986	1/2	3/8	1.583	.472	7/8	1.118	.807	5
57988	1/2	1/2	1.72	.591	7/8	1.118	.807	5

Poly-Push Unions

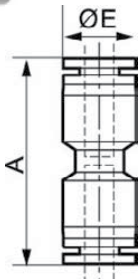

IBS No.	Tube OD	A	E	Qty
56222	1/8	1.181	.694	5
56233	5/32	1.181	.394	5
56244	1/4	1.445	.504	5
56255	5/16	1.535	.543	5
56266	3/8	1.661	.661	5
56288	1/2	1.744	.807	5

90° Union Elbows

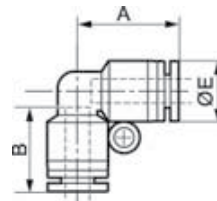

IBS No.	Tube OD	A	B	Qty
56522	1/8	.689	.61	5
56533	5/32	.689	.61	5
56544	1/4	.807	.614	5
56555	5/16	.898	.709	5
56566	3/8	1.035	.76	5
56588	1/2	1.118	.843	5

Poly-Push Union Reducer

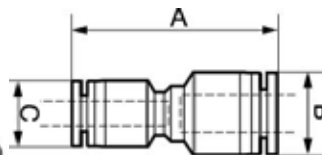

IBS No.	Tube OD	Tube OD	A	B	C	Qty
56242	1/4	1/8	1.32	.504	.709	5
56264	3/8	1/4	1.618	.661	.504	5

FITTINGS



IBS, INCORPORATED

Poly-Push Composite Fittings O12

Poly-Push Composite Fittings — Fractional Male Swivel Branch Tees

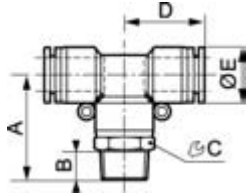

IBS No.	Tube OD	MNPT	A	B	C	D	E	Qty
57222	1/8	1/8	1.004	.315	7/16	.689	.394	5
57232	5/32	1/8	1.004	.315	7/16	.689	.394	5
57242	1/4	1/8	1.122	.315	1/2	.807	.504	5
57244	1/4	1/4	1.22	.433	9/16	.807	.504	5
57246	1/4	3/8	1.28	.472	11/16	.807	.504	5
57252	5/16	1/4	1.181	.315	9/16	.886	.543	5
57254	5/16	1/4	1.299	.433	9/16	.886	.543	5
57262	3/8	1/8	1.327	.315	11/16	1.035	.661	5
57264	3/8	1/4	1.445	.433	11/16	1.035	.661	5
57266	3/8	3/8	1.484	.472	11/16	1.035	.661	5
57284	1/2	1/4	1.543	.433	7/8	1.118	.807	5
57286	1/2	3/8	1.583	.472	7/8	1.118	.807	5
57288	1/2	1/2	1.72	.591	7/8	1.118	.807	5

Poly-Push Union Tees

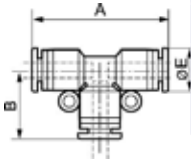

IBS No.	Tube OD	A	B	E	Qty
56422	1/8	1.378	.689	.394	5
56433	5/32	1.378	.689	.394	5
56444	1/4	1.575	.787	.504	5
56455	5/16	1.795	.898	.543	5
56466	3/8	2.016	1.008	.661	5
56488	1/2	2.236	1.118	.807	5

Poly-Push Union "Y" Reducer

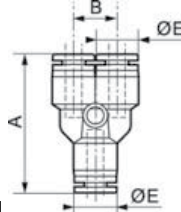

IBS No.	Tube OD	A	B	E	Qty
54122	1/8	1.339	.413	.394	5
54133	5/32	1.339	.413	.394	5
54144	1/4	1.457	.512	.504	5
54155	5/16	1.48	.571	.543	5
54166	3/8	1.992	.709	.661	5

FITTINGS

IBS, INCORPORATED

Assortments Z02



Poly-Push Fractional Composite Fittings 1/8" - 5/16"

IBS No. 336R • 22 Items - 41 Pieces

Packaged in a locking steel drawer for easy storage & organization

IBS, Inc. <small>SPECIALTY PRODUCTS FOR MAINTENANCE & REPAIR INDUSTRIALBOLT.COM • 800-578-1906</small>		Poly-Push Composite Fractional Fittings for Nylon Tubing 1/8", 5/32", 1/4" & 5/16" <small>Assortment No. 336R</small>			
56222 1/8 COMPOSITE STRAIGHT UNION 	56233 5/32 COMPOSITE STRAIGHT UNION 	56244 1/4 COMPOSITE STRAIGHT UNION 	56242 1/4 X 1/8 COMPOSITE UNION RED 	56255 5/16 COMPOSITE STRAIGHT UNION 	
56422 1/8 COMPOSITE UNION TEE POLY 	56444 1/4 COMPOSITE UNION TEE POLY 	56522 1/8 COMPOSITE UNION ELBOW 	56544 1/4 COMPOSITE UNION ELBOW 		57244 1/4 X 1/4 COMP M SWIV BR TEE
56822 1/8 X 1/8 COMPOSITE M CONN 	56824 1/8 X 1/4 COMPOSITE M CONN 	56832 5/32 X 1/8 COMPOSITE M CONN 	56842 1/4 X 1/8 COMPOSITE M CONN 	56844 1/4 X 1/4 COMPOSITE M CONN 	56854 5/16 X 1/4 COMPOSITE M CONN
57922 1/8 X 1/8 COMP M SWIV ELBOW 	57924 1/8 X 1/4 COMP M SWIV ELBOW 	57932 5/32 X 1/8 COMP M SWIV ELBOW 	57942 1/4 X 1/8 COMP M SWIV ELBOW 	57944 1/4 X 1/4 COMP M SWIV ELBOW 	57954 5/16 X 1/4 COMP M SWIV ELBOW

Poly-Push Fractional Composite Fittings 3/8" & 1/2"

IBS No. 337R • 17 Items - 24 Pieces

Packaged in a locking steel drawer for easy storage & organization

IBS, Inc. <small>SPECIALTY PRODUCTS FOR MAINTENANCE & REPAIR INDUSTRIALBOLT.COM • 800-578-1906</small>		Poly-Push Composite Fractional Fittings for Nylon Tubing 3/8" & 1/2" <small>Assortment No. 337R</small>		
56266 3/8 COMPOSITE STRAIGHT UNION 	56264 3/8 X 1/4 COMPOSITE UNION RED 	56288 1/2 COMPOSITE STRAIGHT UNION 	57264 3/8 X 1/4 COMP M SWIV BR TEE 	57286 1/2 X 3/8 COMP M SWIV BR TEE
56466 3/8 COMPOSITE UNION TEE POLY 	56488 1/2 COMPOSITE UNION TEE POLY 	56566 3/8 COMPOSITE UNION ELBOW 	56588 1/2 COMPOSITE UNION ELBOW 	
56864 3/8 X 1/4 COMPOSITE M CONN 	56866 3/8 X 3/8 COMPOSITE M CONN 	56886 1/2 X 3/8 COMPOSITE M CONN 	56888 1/2 X 1/2 COMPOSITE M CONN 	
57964 3/8 X 1/4 COMP M SWIV ELBOW 	57966 3/8 X 3/8 COMP M SWIV ELBOW 	57986 1/2 X 3/8 COMP M SWIV ELBOW 	57988 1/2 X 1/2 COMP M SWIV ELBOW 	

FITTINGS





IBS, INCORPORATED

Poly-Push Composite Fittings O12

Poly-Push Composite Fittings — Metric Male Connectors — Nickel Plated Brass

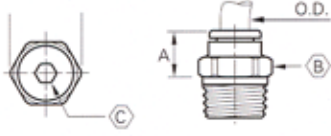

IBS No.	Tube OD mm	ZBSPT Thread	A mm	B mm	C mm	D mm	Qty
301202	M4	1/8	10	3	9.5	11	5
301203	M4	1/4	14	3	6.5	15	5
301212	M6	1/8	11	4	11.5	11	5
301213	M6	1/4	14	4	8.5	15	5
301217	M8	1/8	13	5	20	14	5
301218	M8	1/4	14	6	17	15	5
301219	M8	3/8	17	6	13	18.5	5
301223	M10	1/4	16	7	20	17.5	5
301224	M10	3/8	17	8	16.5	18.5	5
301225	M10	1/2	21	8	14	23	5
301228	M12	1/4	19	7	26.5	21	5
301229	M12	3/8	19	9	24	21	5
301230	M12	1/2	21	9	19.5	23	5
301234	M14	3/8	22	9	28.5	24	5
301235	M14	1/2	24	10	23.5	26	5

Male Swivel Elbows

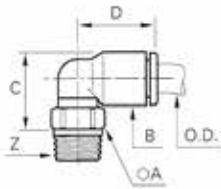

IBS No.	Tube OD mm	ZBSPT Thread	A mm	B mm	C mm	D mm	Qty
302202	M4	1/8	10	8.5	13.5	14	5
302203	M4	1/4	14	8.5	14	14	5
302212	M6	1/8	10	10.5	15.5	16	5
302213	M6	1/4	14	10.5	16	16	5
302217	M8	1/8	10	13.5	19	23	5
302218	M8	1/4	14	13.5	19	23	5
302219	M8	3/8	17	13.5	18	23	5
302223	M10	1/4	15	16	22	26.5	5
302224	M10	3/8	17	16	22	26.5	5
302225	M10	1/2	21	16	22	26.5	5
302228	M12	1/4	15	19	25	31	5
302229	M12	3/8	17	19	25	31	5
302230	M12	1/2	21	19	25	31	5
302234	M14	3/8	20	22	30.5	35.5	5
302235	M14	1/2	24	22	28.5	35.5	5

FITTINGS

IBS, INCORPORATED

Metric Poly-Push Composite Fittings O12



Poly-Push Composite Fittings - Metric

90 °Union Elbows

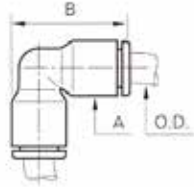

IBS No.	Tube OD 1mm	A mm	B mm	Qty
304250	M4	8.5	19	5
304263	M6	10.5	22.5	5
304268	M8	13.5	29.5	5
304272	M10	16	34.5	5
304275	M12	19	40.5	5
304277	M14	22	46.5	5

Union Tees

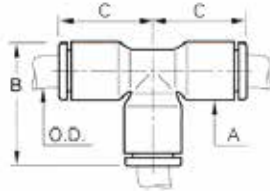

IBS No.	Tube OD 1mm	A mm	B mm	C mm	Qty
305250	M4	8.5	19	14.5	5
305263	M6	10.5	22.5	17.5	5
305268	M8	13.5	29.5	23	5
305272	M10	16	34.5	26.5	5
305275	M12	19	40.5	31	5
305277	M14	22	46	35.5	5

Male Swivel Branch Tees

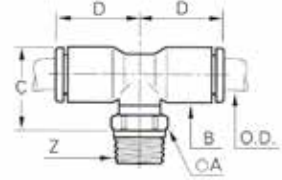

IBS No.	Tube OD 1mm	Z BSPT Thread	A mm	B mm	C mm	D mm	Qty
307202	M4	1/8	10	8.5	9	14	5
307203	M4	1/4	14	8.5	9.5	14	5
307212	M6	1/8	10	10.5	10	16	5
307213	M6	1/4	14	10.5	10.5	16	5
307217	M8	1/8	10	13.5	12	23	5
307218	M8	1/4	14	13.5	11	23	5
307219	M8	3/8	17	13.5	11	23	5
307223	M10	1/4	15	16	14	26.5	5
307224	M10	3/8	17	16	14	26.5	5
307225	M10	1/2	21	16	14	26.5	5
308228	M12	1/4	15	19	15.5	31	5
307229	M12	3/8	17	19	15.5	31	5
307230	M12	1/2	21	19	15.5	31	5
307234	M14	3/8	20	22	19.5	35.5	5
307235	M14	1/2	24	22	17.5	35.5	5

FITTINGS



IBS, INCORPORATED

Metric Poly-Push Composite Fittings O12

Poly-Push Composite Fittings - Metric

Straight Unions



IBS No.	Tube OD (mm)	A mm	B mm	Qty
309250	M4	8.5	25	5
309263	M6	10.5	28.5	5
309268	M8	13.5	38	5
309272	M10	16	42	5
309275	M12	19	50.5	5
309277	M14	22	56	5

Straight "Y" Unions

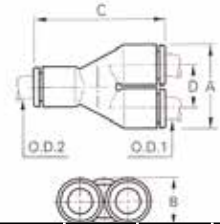

IBS No.	Tube OD 1mm	Tube OD 2mm	A mm	B mm	C mm	D mm	Qty
315250	M4	M4	17.5	8.5	28.5	9	5
315263	M6	M6	21.5	10.5	35	11	5
315268	M8	M8	28	13.5	45	14.5	5
315272	M10	M10	33	16	53	17	5

Straight Reducing Unions

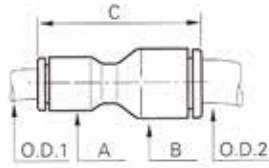

IBS No.	Tube OD 1mm	Tube OD 2mm	A mm	B mm	C mm	Qty
309252	M4	M6	8.5	11	28	5
309264	M6	M8	13.5	13.5	38	5
309269	M8	M10	16	16	42	5

Reducing "Y" Unions

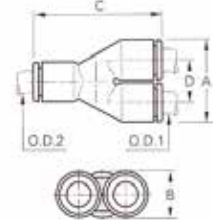

IBS No.	Tube OD 1mm	Tube OD 2mm	A mm	B mm	C mm	D mm	Qty
315252	M4	M6	17.5	10.5	33	9	5
315264	M6	M8	22.5	13.5	41	11.5	5
315269	M8	M10	28	16	47	14.5	5

FITTINGS

IBS, INCORPORATED

























Assortments Z02



Push-On Hose Fitting M4, M6 & M8 Assortment

IBS No. 332R • 24 Items - 39 Pieces



















Packaged in a locking steel drawer for easy storage & organization

 IBS, Inc. <small>SPECIALTY PRODUCTS FOR MAINTENANCE & REPAIR INDUSTRIALBOLT.COM © © © 800-678-1906</small>		Poly-Push Composite Metric Fittings for Nylon Tubing M4, M6 & M8 <small>Assortment No. 332R</small>			
301202 M4 X 1/8BSPT COMPOSITE M CONN 	301212 M6 X 1/8BSPT COMPOSITE M CONN 	301213 M6 X 1/4BSPT COMPOSITE M CONN 	301218 M8 X 1/4BSPT COMPOSITE M CONN 	301219 M8 X 3/8BSPT COMPOSITE M CONN 	309250 M4 COMPOSITE STRAIGHT UNION 
302202 M4 X 1/8BSPT COMP M SWIV 	302212 M6 X 1/8BSPT COMP M SWIV 	302213 M6 X 1/4BSPT COMP M SWIV 	302218 M8 X 1/4BSPT COMP M SWIV 	302219 M8 X 3/8BSPT COMP M SWIV 	309263 M6 COMPOSITE UNION CONN POLY 
307202 M4 X 1/8BSPT COMP M BRANCH 	307212 M6 X 1/8BSPT COMP M BRANCH 	307213 M6 X 1/4BSPT COMP M BRANCH 	307218 M8 X 1/4BSPT COMP M BRANCH 	307219 M8 X 3/8BSPT COMP M BRANCH 	309268 M8 COMPOSITE STRAIGHT UNION 
304250 M4 COMPOSITE UNION ELBOW POLY 	304263 M6 COMPOSITE UNION ELBOW POLY 	304268 M8 COMPOSITE UNION ELBOW POLY 	305250 M4 COMPOSITE UNION TEE POLY 	305263 M6 COMPOSITE UNION TEE POLY 	305268 M8 COMPOSITE UNION TEE POLY 

Push-On Hose Fittings M10 & M12 Assortment

IBS No. 333R • 17 Items - 19 Pieces

Packaged in a locking steel drawer for easy storage & organization

 IBS, Inc. <small>SPECIALTY PRODUCTS FOR MAINTENANCE & REPAIR INDUSTRIALBOLT.COM © © © 800-678-1906</small>		Poly-Push Composite Metric Fittings for Nylon Tubing M10 & M12 <small>Assortment No. 333R</small>			
301223 M10 X 1/4BSPT COMPOSITE M 	301224 M10 X 3/8BSPT COMPOSITE M 	301225 M10 X 1/2BSPT COMPOSITE M 	301229 M12 X 3/8BSPT COMPOSITE M 	301230 M12 X 1/2BSPT COMPOSITE M 	
302223 M10 X 1/4BSPT COMP M SWIV ELB 	302224 M10 X 3/8BSPT COMP M SWIV ELB 	302229 M12 X 3/8BSPT COMP M SWIV ELB 	302230 M12 X 1/2BSPT COMP M SWIV ELB 		
304272 M10 COMPOSITE UNION ELBOW 	304275 M10 COMPOSITE UNION ELBOW 	305272 M10 COMPOSITE UNION TEE POLY 	305275 M12 COMPOSITE UNION TEE POLY 		
309272 M10 COMPOSITE STRAIGHT UNION 	309275 M12 COMPOSITE STRAIGHT UNION 	307224 M10 X 3/8BSPT COMP M BRANCH 	307230 M12 X 1/2BSPT COMP M BRANCH 		

FITTINGS



IBS, INCORPORATED

Drain Cocks & Valves O05

Drain Cocks

- **Metal to Metal seat** requires only hand tightening to assure leak-proof performance.
- Use with copper, aluminum, steel, hose and plastic tubing where applicable.
- Operating temperature range from -65°F to +250°F.
- Designed for automotive or industrial use. Not intended for natural gas, LPG, nuclear or aircraft applications, except as noted.

External Seat



IBS No.	W'Head No.	MPT	Hex	Qty
WHD135	135	1/8	7/16	5
WHD145	145	1/4	9/16	5
WHD270	270	3/8	11/16	3
WHD108	108	1/2	7/8	1

Internal Seat



IBS No.	W'Head No.	MPT	Hex	Qty
WHD130	130	1/8	17/32	5
WHD140	140	1/4	5/8	5

Internal Seat Drain Valve



IBS No.	W'Head No.	MPT	Hex	Qty
WHD-1424	1424A	1/8	1/2	5
WHD-1425	1425A	1/4	9/16	5
WHD-1426	1426A	3/8	11/16	3

Angle Bib Drain



IBS No.	W'Head No.	MPT	Hose	Qty
WHD150	150	1/8	1/4	5
WHD6660	6660	1/4	3/8	5

Pipe to Hose Shut-Off



IBS No.	W'Head No.	MPT	Hose	Qty
WHD1422	1422	3/8	3/8	1
229KF	NA	3/8	1/2	1
WHD1423	1423	3/8	5/8	1

Air Tank Drain Valve



IBS No.	W'Head No.	MPT	Qty
WHD-1421 *	1421	1/4	2

* Self-sealing w/5ft remote cable.

F
I
T
T
I
N
G
S

IBS, INCORPORATED

Drain Cocks & Valves O05



Ground Plug Shut-Offs

- Use with copper, aluminum, steel, hose and plastic tubing where applicable.
- Operating pressure range 30 psi working pressure except where noted.
- Operating temperature range from -65°F to +250°F.
- Designed for automotive or industrial use. Not intended for natural gas, LPG, nuclear or aircraft applications, except as noted.

Truck Drain (O08)



IBS No.	W'Head No.	MPT	Qty
W15310	W15310	1/4	3

Valve is designed to hold air pressure of 125 psi with one 1/4" bubble in 5 seconds permissible key leakage.

Ground Plug Drain



IBS No.	W'Head No.	MPT	Hex	Qty
6891	6981	1/8	9/16	3
WHD-6892	6892	1/4	5/8	3
WHD-6893	6893	3/8	11/16	3

Male to Female Pipe Shut-Off



IBS No.	W'Head No.	MPT	FPT	Qty
WHD6824	6824	1/8	1/8	3
WHD6829	6829	1/4	1/4	3

Truck Shut-Off: M to F Pipe



IBS No.	W'Head No.	MPT	FPT	Qty
W20332	W20332	1/4	1/4	3

Valve is designed to hold air pressure of 125 psi with one 1/4" bubble in 5 seconds permissible to key leakage

Marine Shut-Off: M to F Pipe



IBS No.	W'Head No.	MPT	FPT	Qty
6828	6828	1/4	1/4	3

UL listed for marine fuel

Female Pipe Shut-Off



IBS No.	W'Head No.	FPT	Qty
6809	6809	1/4	3

Needle Valve

- Use with instrumentation hydraulic and pneumatic systems.
- Maximum pressure — 150 psi.
- Metal to metal seat with fine thread screw down enabling valve to seat positively, adjust easily, and hold to any amount of flow up to the capacity of the valve.



IBS No.	W'Head No.	MPT	Qty
6810	6810	1/8	3

F I T T I N G S























IBS, INCORPORATED

Drain Cocks & Valves O05

Draincocks & Valves Assortment (Z02)

IBS No. 121R • 20 Items • 34 Pcs

Packaged in a locking steel drawer for easy storage & organization

IBS, Inc. SPECIALTY PRODUCTS FOR MAINTENANCE & REPAIR INDUSTRIALBOLTY.COM • • • 800-678-1906				Brass Draincocks & Shut-Off Valves	
Assortment No. 121R					
WHD135 1/8 BRASS EXT. SEAT DRAIN COCK 	WHD145 1/4 BRASS EXT. SEAT DRAIN COCK 	WHD270 3/8 BRASS EXT. SEAT DRAIN COCK 	WHD130 1/8 BRASS INT. SEAT DRAIN COCK 	WHD108 1/2 BRASS EXT. SEAT DRAIN COCK 	
WHD-1424 1/8 INT. SEAT DRAIN VALVE BRASS 	WHD-1425 1/4 INT. SEAT DRAIN VALVE BRASS 	WHD-1426 3/8 INT. SEAT DRAIN VALVE BRASS 	6809 1/4 FE BRASS PIPE SHUT OFF 	WHD1423 5/8 X 3/8 PIPE TO HOSE SHUT 	
WHD6824 1/8 X 1/8 M. TO F. SHUT OFF 	6828 1/4 X 1/4 MARINE SHUT OFF 	WHD150 1/8 BRASS ANGLE BIB DRAIN COCK 	WHD6660 1/4 BRASS ANGLE BIB DRAIN COCK 	229KF SHUT OFF 	
WHD-1421 1/4 BRASS AIR TANK VALVE 	WHD6829 1/4 X 1/4 M TO F SHUT OFF 	WHD-6892 1/4 BRASS GROUND PLUG 	WHD-6893 3/8 BRASS GROUND PLUG 	WHD1422 3/8 X 3/8 PIPE TO HOSE SHUT 	

Full Bore Brass Ball Valves (O05)

- **SOLID CHROME PLATED BRASS BALL**
- Suitable for full range of liquids and gases.
- Minimal pressure drop due to large full size ports.
- Bottom loaded, pressure retaining stem.
- Pressure rated at 600 psi (42 bars) WOG (non-shock) and 150 WSP (10.34 bars) saturated steam. Virgin TFE stem packing seal, thrust washer and seats.
- Yellow vinyl insulator on heavy duty plated carbon steel handles.
- Fast 1/4 turn open or close operation.
- Low operating torque.
- Flow can go both directions.
- Adjustable stem packing gland.
- Maximum operating temperature: 248°F (120°C) at 600 PSI
- Minimum operating temperature: -20°F (-40°C)
- Each valve individually tested.
- Forged Brass — for more strength.
- Threaded ends to ANSI B1.20.1
- Hard chromium plated solid ball
- Bottom entry, blow-out proof stem.
- Deeper threads — for better connections.
- Reversible Handles.

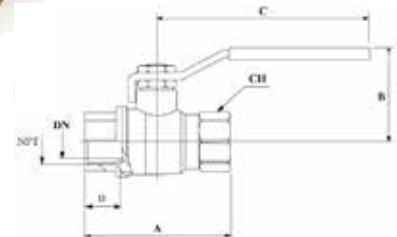

IBS No.	Size	Dimension Inches					
	NPT	DN	A	B	C	D	CH
BV400B	1/4	.39	1.96	1.57	3.43	.43	.75
BV600B	3/8	.39	1.96	1.54	3.31	.43	.86
BV800B	1/2	.57	2.09	1.64	3.35	.46	.98
BV1200B	3/4	.75	2.80	1.79	3.80	.49	1.22
BV1600B	1	.94	3.23	2.13	3.80	.59	1.50
BV2000B	1-1/4	1.24	3.70	2.32	4.72	.62	1.85
BV2400B	1-1/2	1.49	4.13	2.60	4.72	.64	2.13
BV3200B	2	1.96	5.94	3.27	6.38	.65	2.64

FITTINGS



High Pressure Steel Pipe Fittings

- **Operating pressure up to 3,000 psi** depending on pipe size.
- **Temperature range** -65°F to +400°F.
- **Precision machined from AISI 12L14 Carbon Steel.**
 - Shaped fittings (elbows, tees, etc.) are made from hi-density forgings.
 - Straight fittings are made from bar stock.
- **Zinc plated.**
- **Use with brass, bronze and iron pipe.**
- **Application — grease, instrumentation and most hydraulic systems.**
- **Features dry-seal pipe threads and compact size.**

Bushings



IBS No.	MPT	FPT	Hex	D	L	Pkg Qty
15074	1/4	1/8	5/8	.332	.85	10
15075	3/8	1/8	3/4	.332	.85	10
15076	3/8	1/4	3/4	.438	.85	10
15078	1/2	1/4	7/8	.438	1.10	5
15079	1/2	3/8	7/8	.578	1.10	5
15082	3/4	3/8	1-1/8	.578	1.17	5
15083	3/4	1/2	1-1/8	.703	1.17	5
15086	1	1/2	1-3/8	.703	1.36	5
15087	1	3/4	1-3/8	.922	1.36	5

Couplings



IBS No.	FPT	Hex	D	L	Qty
C3309X2	1/8	5/8	.343	.75	5
C3309X4	1/4	3/4	.437	1.13	5
C3309X6	3/8	7/8	.562	1.13	5
C3309X8	1/2	1-1/8	.687	1.50	5
C3309X12	3/4	1-3/8	.906	1.53	5
C3309X16	1	1-5/8	1.125	1.89	5

Assembly Instructions

1. Tighten approximately 2-1/2 turns past hand tight.
2. Welding procedure:
Use electric weld rod. Recommended procedure specifies using lower amperage than usual and puddling of molten metal to permit gasses created by lead in steel to work through molten lead deposit.

Hex Nipples

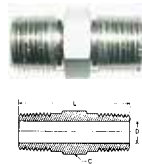

IBS No.	MPT	Hex	D	L	Qty
C3069X2	1/8	7/16	.188	.75	10
C3069X4	1/4	5/8	.281	1.13	10
C3069X6	3/8	3/4	.406	1.13	10
C3069X8	1/2	7/8	.531	1.50	5
C3069X12	3/4	1-1/8	.719	1.53	5
C3069X16	1	1-3/8	.938	1.89	5

90° Street Elbow

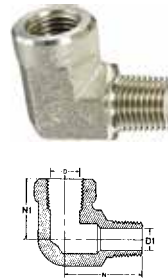

IBS No.	MPT	FPT	Hex	Qty
C3409X2	1/8	1/8	9/16	5
C3409X4	1/4	1/4	3/4	5
C3409X6	3/8	3/8	7/8	5
C3409X8	1/2	1/2	1-1/16	5
C3409X12	3/4	3/4	1-5/16	5
C3409X16	1	1	1-5/8	5

Hex Head Plugs

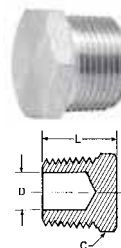

IBS No.	MPT	Hex	L	Pkg Qty
15018	1/8	7/16	.56	10
15019	1/4	9/16	.66	10
15020	3/8	11/16	.78	10
15021	1/2	7/8	.98	5
15022	3/4	1-1/8	1.06	5
15023	1	1-3/8	1.25	5

FITTINGS



IBS, INCORPORATED

Steel SAE 37° (JIC) Flared Fittings O15

SAE 37° (JIC) Steel Flared Fittings

- **Operating pressure up to 10,000 psi** depending on tube and fitting size.
- **Temperature range** -65°F to +400°F.
- **Zinc Plated.**
- **Interchangeable** with all sources.
- **Good Resistance to vibration**, but decreases with increase in tube size. Two piece design recommended when greater resistance to vibration is required.
- **Use with** copper, brass, steel aluminum and other tubing that can be flared.
- **Use in** hydraulic, instrumentation and chemical processing systems.
- **Meets specification and standards** of ASA, ASME, SAE and MS (Military Standards).

Assembly Instructions

1. Cut tubing to desired length. Make sure all burrs are removed and ends are cut square.
2. Slide nut on tube. Threaded end of nut must face toward the fitting body.
3. Flare end of tubing with 37° flaring tool.
 - A) Check flare diameter.
 - B) Examine flare for excessive thin-out.
 - C) On thin wall, welded or brazed tubing, use double flare to prevent pinch off and cracked flares.
4. Lubricate threads and assemble to fitting body. Nut should be turned hand tight.
5. Tighten assembly with wrench until solid feeling is encountered. From that point, apply one-sixth turn

JIC Plugs



IBS No.	Tube	Hex	L	Qty
C5229X4	1/4	1/2	.80	5
C5229X5	5/16	9/16	.80	5
C5229X6	3/8	5/8	.84	5
C5229X8	1/2	13/16	.94	5
C5229X10	5/8	15/16	1.10	5
C5229X12	3/4	1-1/8	1.28	5
C5229X16	1	1-3/8	1.33	1
C5229X20	1-1/4	1-11/16	1.45	1
C5229X24	1-1/2	2	1.65	1

JIC Caps



IBS No.	Tube	Hex	L	Qty
C5129X2	1/8	3/8	.50	5
C5129X3	3/16	7/16	.56	5
C5129X4	1/4	9/16	.59	5
C5129X5	5/16	5/8	.61	5
C5129X6	3/8	11/16	.62	5
C5129X8	1/2	7/8	.75	5
C5129X10	5/8	1	.84	1
C5129X12	3/4	1-1/4	.91	1
C5129X14	7/8			1
C5129X16	1	1-1/2	1.02	1
C5129X20	1-1/4	2	1.06	1
C5129X24	1-1/2	2-1/4	1.19	1

JIC 90° Male Elbows



IBS No.	Tube	MPT	Hex	Qty
C5405X2	1/8	1/8	7/16	5
C5405X3	3/16	1/8	7/16	5
C5405X4	1/4	1/8	7/16	5
C5405X4X4	1/4	1/4	9/16	5
C5405X5	5/16	1/8	1/2	5
C5405X5X4	5/16	1/4	9/16	5
C5405X6X2	3/8	1/8 1/8	9/16	5
C5405X6	3/8	1/4	9/16	5
C5405X6X6	3/8	3/8	3/4	5
C5405X6X8	3/8	1/2	7/8	5
C5405X8X4	1/2	1/4	3/4	3
C5405X8	1/2	3/8	3/4	3
C5405X8X8	1/2	1/2	7/8	3
C5405X8X12	1/2	3/4	1-1/16	3
C5405X10X6	5/8	3/8	7/8	3
C5405X10	5/8	1/2	7/8	3
C5405X10X12	5/8	3/4	1-1/16	1
C5405X12X8	3/4	1/2	1-1/16	1
C5405X12	3/4	3/4	1-1/16	1
C5405X14	7/8	3/4	1-5/16	1
C5405X16X12	1	3/4	1-5/16	1
C5405X16	1	1	1-5/16	1
C5405X20X16	1-1/16	1	1-5/8	1
C5405X20	1-1/16	1-1/16	1-5/8	1
C5405X24	1-1/2	1-1/2	1-7/8	1

FITTINGS

IBS, INCORPORATED

Steel SAE 37° (JIC) Flared Fittings O15



JIC Male Connectors



IBS No.	Tube	MPT	Hex	L	Qty
C5205X2	1/8	1/8	7/16	1.11	5
C5205X3	3/16	1/8	7/16	1.14	5
C5205X4	1/4	1/8	1/2	1.22	5
C5205X4X4	1/4	1/4	9/16	1.42	5
C5205X4X6	1/4	3/8	3/4	1.68	5
C5205X4X8	1/4	1/2	7/8	1.68	5
C5205X5	5/16	1/8	9/16	1.22	5
C5205X5X4	5/16	1/4	9/16	1.42	5
C5205X5X6	5/16	3/8	3/4	1.42	5
C5205X6X2	3/8	1/8	5/8	1.24	5
C5205X6	3/8	1/4	5/8	1.43	5
C5205X6X6	3/8	3/8	3/4	1.43	5
C5205X6X8	3/8	1/2	7/8	1.69	5
C5205X8X4	1/2	1/4	13/16	1.53	3
C5205X8	1/2	3/8	13/16	1.53	3
C5205X8X8	1/2	1/2	15/16	1.79	3
C5205X8X12	1/2	3/4	1-1/8	1.85	3
C5205X10X6	5/8	3/8	15/16	1.70	3
C5205X10	5/8	1/2	15/16	1.89	3
C5205X10X12	5/8	3/4	1-1/8	1.95	1
C5205X12	3/4	3/4	1-1/8	2.06	1
C5205X12X16	3/4	1	1-3/8	2.25	1
C5205X14	7/8	3/4	1-1/4	2.09	1
C5205X16X12	1	3/4	1-3/8	2.11	1
C5205X16	1	1	1-3/8	2.30	1
C5205X20X16	1-1/4	1	1-11/16	2.42	1
C5205X20	1-1/4	1-1/4	1-11/16	2.45	1
C5205X24X20	1-1/2	1-1/4	2	2.65	1
C5205X24	1-1/2	1-1/2	2	2.68	1

JIC 45° Male Elbows



IBS No.	Tube	MPT	Hex	Qty
C5355X2	1/8	1/8	7/16	5
C5355X3	3/16	1/8	7/16	5
C5355X4	1/4	1/8	7/16	5
C5355X4X4	1/4	1/4	9/16	5
C5355X5	5/16	1/8	1/2	5
C5355X5X4	5/16	1/4	9/16	5
C5355X6X2	3/8	1/8	9/16	5
C5355X6	3/8	1/4	9/16	5
C5355X6X6	3/8	3/8	3/4	5
C5355X6X8	3/8	1/2	7/8	5
C5355X8X4	1/2	1/4	3/4	3
C5355X8	1/2	3/8	7/8	3
C5355X8X8	1/2	1/2	7/8	3
C5355X10X6	5/8	3/8	7/8	3
C5355X10	5/8	1/2	7/8	3
C5355X12X8	3/4	1/2	1-1/16	1
C5355X12	3/4	3/4	1-1/16	1
C5355X14	7/8	3/4	1-1/16	1
C5355X16X2	1	3/4	1-5/16	1
C5355X16	1	1	1-5/16	1
C5355X20	1-1/4	1-1/4	1-5/8	1
C5355X24	1-1/2	1-1/2	1-7/8	1

JIC Swivel Nut Elbows



IBS No.	JIC TUBE	JIC TUBE	Qty
C5506X4	1/4	1/4	5
C5506X6	3/8	3/8	5
C5506X8	1/2	1/2	5
C5506X12	3/4	3/4	5
C5506X16	1	1	5
C5506X20	1-1/4	1-1/4	5

FITTINGS



IBS, INCORPORATED

Steel SAE 37° (JIC) Flared Fittings O15

FITTINGS

JIC Hex Union



IBS No.	Tube	Hex	D	L	Qty
C5305X2	1/8	7/16	.062	1.17	5
C5305X3	3/16	7/16	.125	1.23	5
C5305X4	1/4	1/2	.172	1.37	5
C5305X5	5/16	9/16	.234	1.37	5
C5305X6	3/8	5/8	.297	1.41	5
C5305X8	1/2	13/16	.391	1.62	3
C5305X10	5/8	15/16	.484	1.88	3
C5305X12	3/4	1-1/8	.609	2.16	1
C5305X14	7/8	1-1/4	.718	2.21	1
C5305X16	1	1-3/8	.844	2.25	1
C5305X20	1-1/4	1-11/16	1.078	2.43	1
C5305X24	1-1/2	2	1.312	2.75	1

JIC Union Tees



IBS No.	JIC TUBE	Qty
C5705X3	3/16	1
C5705X4	1/4	1
C5705X6	3/8	1
C5705X8	1/2	1
C5705X10	5/8	1
C5705X12	3/4	1
C5705X16	1	1

JIC 90° Union Elbow



IBS No.	JIC TUBE	Qty
C5505X4	1/4	1
C5505X6	3/8	1
C5505X8	1/2	1
C5505X10	5/8	1
C5505X12	3/4	1
C5505X16	1	1
C5505X20	1-1/4	1

JIC Female Connectors



IBS No.	JIC TUBE	FPT	Qty
C5255X4	1/4	1/4	5
C5255X6	3/8	3/8	5
C5255X8	1/2	1/2	5

JIC Male to Male Boss O-Ring



IBS No.	JIC TUBE	O-RING TUBE	Qty
C5315X4	1/4	1/4	5
C5315X4X6	1/4	3/8	5
C5315X6	3/8	3/8	5
C5315X6X4	3/8	1/4	5
C5315X6X8	3/8	1/2	5
C5315X8	1/2	1/2	5
C5315X8X6	1/2	3/8	5
C5315X8X12	1/2	3/4	5
C5315X12	3/4	3/4	5
C5315X12X8	3/4	1/2	5
C5315X16	1	1	3
C5315X16X20	1	1-1/4	3
C5315X16X24	1	1-1/2	3

Male O-Ring Swivel Adapter



IBS No.	O-RING TUBE	FEMALE NSPM	Qty
9315X4	1/4	1/4	1
9315X6	3/8	3/8	1
9315X8	1/2	1/2	1
9315X12	3/4	3/4	1
9315X16	1	1	1

Male For-Seal to Straight Thread O-Ring Connectors



IBS No.	For-Seal	O-Ring	Qty
4315X4	1/4	1/4	1
4315X6	3/8	3/8	1
4315X8	1/2	1/2	1
4315X10	5/8	5/8	1
4365X12	3/4	3/4	1

IBS, INCORPORATED

Steel SAE 37° (JIC) Flared Fittings O15



Boss O-Ring 37° JIC Swivel Adapter



IBS No.	O-RING TUBE	FEMALE NSPM	Qty
9316X4	1/4	1/4	1
9316X6	3/8	3/8	1
9316X8	1/2	1/2	1
9316X10	3/4	3/4	1
9316X12	5/16	5/16	1

90° For-Seal to Straight Thread O-Ring Connectors



IBS No.	For-Seal	O-Ring	Qty
4515X4	1/4	1/4	1
4515X6	3/8	3/8	1
4515X8	1/2	1/2	1
4515X10	5/8	5/8	1
4515X12	3/4	3/4	1
4515X16	1	1	1

Male JIC to Female Flat Face Swivel Adapter



IBS No.	JIC TUBE	FACE SEAL	Qty
4213X4	1/4	1/4	1
4213X6	3/8	3/8	1
4213X8	1/2	1/2	1
4213X10	5/8	5/8	1
4213X16	1	1	1

Steel Pipe Caps



IBS No.	Size	Pkg Qty
15053	1/8	5
15054	1/4	5
15055	3/8	5
15056	1/2	5
15057	3/4	5
15057A	1	5

JIC to O-Ring 45° Elbows



IBS No.	JIC TUBE	O-RING TUBE	Qty
C5365X4	1/4	1/4	1
C5365X6	3/8	3/8	1
C5365X8	1/2	1/2	1
C5365X10	5/8	5/8	1
C5365X12	3/4	3/4	1
C5365X16	1	1	1

45° For-Seal to Straight Thread O-Ring Connectors



IBS No.	For-Seal	O-Ring	Qty
4365X4	1/4	1/4	1
4365X6	3/8	3/8	1
4365X8	1/2	1/2	1
4365X10	5/8	5/8	1
4365X12	3/4	3/4	1
4365X16	1	1	1

Steel 90° Male Elbows



IBS No.	MPT 1	MPT 2	Qty
C3529X4	1/4	1/4	5
C3529X6	3/8	3/8	5
C3529X8	1/2	1/2	5
C3529X12	3/4	3/4	5
C3529X16	1	1	5

FITTINGS



IBS, INCORPORATED

Assortments Z02

FITTINGS

IBS, Inc.
SPECIALTY PRODUCTS FOR MAINTENANCE & REPAIR
INDUSTRIALBOLT.COM 800-678-1906

JIC Fitting Adapters

Assortment No. 738R

C5229X4 1/4 JIC PLUG 	C5129X4 1/4 JIC CAP 	C5305X4 1/4 JIC UNION 	C5205X4 1/4 X 1/8 JIC M. CONN 	C5205X8 1/2 X 3/8 JIC M. CONN
C5229X6 3/8 JIC PLUG 	C5129X6 3/8 JIC CAP 	C5305X6 3/8 JIC UNION 	C5205X4X4 1/4 X 1/4 JIC M. CONN 	C5205X8X8 1/2 X 1/2 JIC M. CONN
C5229X8 1/2 JIC PLUG 	C5129X8 1/2 JIC CAP 	C5305X8 1/2 JIC UNION 	C5205X6 3/8 X 1/4 JIC M. CONN 	
C5229X12 3/4 JIC PLUG 	C5129X12 3/4 JIC CAP 	C5305X12 3/4 JIC UNION 	C5205X6X6 3/8 X 3/8 JIC M. CONN 	

JIC Fitting Adapters Assortment

IBS No. 738R
18 Items • 66 Pcs
Packaged in a locking steel drawer for easy storage & organization



IBS, Inc.
SPECIALTY PRODUCTS FOR MAINTENANCE & REPAIR
INDUSTRIALBOLT.COM 800-678-1906

SAE 37° JIC Flare 90° Elbows

Assortment No. 846R

C5405X4 1/4 X 1/8 JIC 90DGR M ELBOW 	C5405X4X4 1/4 X 1/4 JIC 90DGR M ELBOW 	C5405X6 5/16 X 1/8 JIC 90DGR M ELBOW 	C5405X8 5/16 X 1/4 JIC 90DGR M ELBOW 	
C5405X6X2 3/8 X 1/8 JIC 90DGR M ELBOW 	C5405X6 3/8 X 1/4 JIC 90DGR M ELBOW 	C5405X6X6 3/8 X 3/8 JIC 90DGR M ELBOW 		
C5405X8X4 1/2 X 1/4 JIC 90DGR M ELBOW 	C5405X8 1/2 X 3/8 JIC 90DGR M ELBOW 	C5405X8X8 1/2 X 1/2 JIC 90DGR M ELBOW 		
C5405X10X6 5/8 X 3/8 JIC 90DGR M ELBOW 	C5405X10 5/8 X 1/2 JIC 90DGR M ELBOW 	C5405X12 3/4 X 3/4 JIC 90DGR M ELBOW 		

SAE 37° JIC Flare 90° Elbows Assortment

IBS No. 846R
13 Items • 23 Pcs
Packaged in a locking steel drawer for easy storage & organization



IBS, Inc.
SPECIALTY PRODUCTS FOR MAINTENANCE & REPAIR
INDUSTRIALBOLT.COM 800-678-1906

For-Seal to Straight-Thread O-Ring Fittings

Assortment No. 847R

4315X4 1/4 X 1/4 MALE FACE SEAL TO STRAIGHT THREAD O-RING CONNECTOR 	4315X6 3/8 X 3/8 MALE FACE SEAL TO STRAIGHT THREAD O-RING CONNECTOR 	4315X8 1/2 X 1/2 MALE FACE SEAL TO STRAIGHT THREAD O-RING CONNECTOR 	4315X10 3/4 X 3/4 MALE FACE SEAL TO STRAIGHT THREAD O-RING CONNECTOR 	4315X12 5/8 X 5/8 MALE FACE SEAL TO STRAIGHT THREAD O-RING CONNECTOR
4365X4 1/4 45DGR FOR SEAL TO STRT THREAD O-RING CONN 	4365X6 3/8 45DGR FOR SEAL TO STRT THREAD O-RING CONN 	4365X8 1/2 45DGR FOR SEAL TO STRT THREAD O-RING CONN 	4365X10 3/4 45DGR FOR SEAL TO STRT THREAD O-RING CONN 	4365X12 5/8 45DGR FOR SEAL TO STRT THREAD O-RING CONN
4515X4 1/4 X 1/4 90DGR FOR-SEAL TO STRAIGHT THREAD O-RING CONN 	4515X6 3/8 X 3/8 90DGR FOR-SEAL TO STRAIGHT THREAD O-RING CONN 	4515X8 1/2 X 1/2 90DGR FOR-SEAL TO STRAIGHT THREAD O-RING CONN 	4515X10 3/4 X 3/4 90DGR FOR-SEAL TO STRAIGHT THREAD O-RING CONN 	4515X12 5/8 X 5/8 90DGR FOR-SEAL TO STRAIGHT THREAD O-RING CONN

For-Seal to Straight Thread O-Ring Fittings Assortment

IBS No. 847R
15 Items • 22 Pcs
Packaged in a locking steel drawer for easy storage & organization



IBS, INCORPORATED

High Pressure Hyd. Hose & Fittings O15



Male Pipe NPTF Rigid



IBS No.	W'Head No.	A	B	C	D	Hose I.D. (in.)	Thread	Pkg Qty
MP0402W	04U-102	1/4	1.85	.79	9/16	1/4	1/8-27	1
MP0404W	04U-104	1/4	2.03	.97	9/16	1/4	1/4-18	1
MP0406W	04U-106	1/4	2.13	1.07	11/16	1/4	3/8-18	1
MP0408W	04U-108	1/4	2.31	1.255	7/8	1/4	1/2-14	1
MP0604W	06U-104	3/8	2.45	1.08	11/16	3/8	1/4-18	1
MP0606W	06U-106	3/8	2.22	0.99	3/4	3/8	3/8-18	1
MP0608W	06U-108	3/8	2.49	1.26	7/8	3/8	1/2-14	1
MP0806W	08U-106	1/2	2.39	1.08	7/8	1/2	3/8-18	1
MP0808W	08U-108	1/2	2.64	1.30	7/8	1/2	1/2-14	1
MP0812W	08U-112	1/2	2.71	1.37	1-1/16	1/2	3/4-14	1
MP1212W	12U-112	3/4	3.19	1.40	1-1/16	3/4	3/4-14	1
MP1616W	16U-116	1	3.73	1.62	1-3/8	1	1-11-1/2	1

Male Pipe NPTF Swivel



IBS No.	W'Head No.	A	B	C	D	E	Hose I.D. (in.)	Thread	Pkg Qty
MPX0404W	04U-J04	1/4	2.60	1.54	9/16	11/16	1/4	1/4-18	1
MPX0406W	04U-J06	1/4	2.60	1.54	9/16	3/4	1/4	3/8-18	1
MPX0604W	06U-J04	3/8	2.99	1.62	11/16	11/16	3/8	1/4-18	1
MPX0606W	06U-J06	3/8	2.99	1.62	11/16	3/4	3/8	3/8-18	1
MPX0608W	06U-J08	3/8	3.24	1.87	11/16	15/16	3/8	1/2-14	1
MPX0808W	08U-J08	1/2	3.27	1.93	7/8	7/8	1/2	1/2-14	1
MPX1212W	12U-J12	3/4	3.89	2.01	1-1/8	1-1/8	3/4	3/4-14	1
MPX1616W	16U-J16	1	4.40	2.27	1-3/8	1-1/2	1	1-11/12	1

FITTINGS



IBS, INCORPORATED

High Pressure Hyd. Hose & Fittings O15

F I T T I N G S

37° JIC Male Pipe Rigid

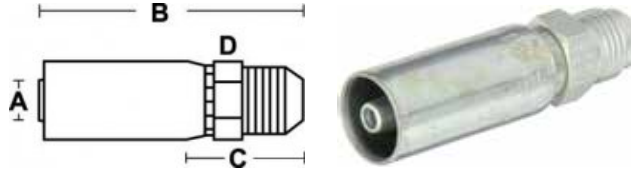

IBS No.	W'Head No.	A	B	C	D	Hose I.D. (in.)	Thread	Pkg Qty
MJ0404W	04U-504	1/4	2.02	.94	9/16	1/4	7/16-20	1
MJ0406W	04U-506	1/4	2.03	.95	9/16	1/4	9/16-18	1
MJ0606W	06U-506	3/8	2.12	.99	3/4	3/8	9/16-18	1
MJ0608W	06U-508	3/8	2.38	1.15	3/4	3/8	3/4-16	1
MJ0806W	08U-506	1/2	2.39	1.05	11/16	1/2	9/16-18	1
MJ0808W	08U-508	1/2	2.57	1.23	7/8	1/2	3/4-16	1
MJ0810W	08U-510	1/2	2.72	1.38	7/8	1/2	7/8-14	1
MJ1010W	10U-510	5/8	3.58	1.48	7/8	5/8	7/8-14	1
MJ1212W	12U-512	3/4	3.34	1.55	1-1/8	3/4	1-1/16-2	1
MJ1616W	16U-516	1	3.93	1.81	1-3/8	1	1-5/16-2	1

37° JIC Female Swivel

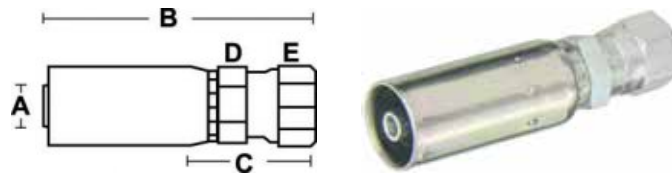

IBS No.	W'Head No.	A	B	C	D	E	Hose I.D. (in.)	Thread	Pkg Qty
FJX0404W	04U-604	1/4	2.08	1.02	9/16	9/16	1/4	7/16-20	1
FJX0405W	04U-605	1/4	2.22	1.16	9/16	5/8	1/4	1/2-20	1
FJX0406W	04U-606	1/4	2.17	1.09	9/16	11/16	1/4	9/16-18	1
FJX0604W	06U-604	3/8	2.41	1.04	11/16	9/16	3/8	7/16-20	1
FJX0606W	06U-606	3/8	2.50	0.72	3/4	3/4	3/8	9/16-18	1
FJX0608W	06U-608	3/8	2.47	1.24	3/4	7/8	3/8	3/4-16	1
FJX0806W	08U-606	1/2	2.52	1.18	11/16	11/16	1/2	9/16-18	1
FJX0808W	08U-608	1/2	2.64	1.30	7/8	7/8	1/2	3/4-16	1
FJX0810W	08U-610	1/2	2.80	1.46	7/8	1	1/2	7/8-14	1
FJX1010W	10U-610	5/8	3.38	1.52	7/8	1	5/8	7/8-14	1
FJX1212W	12U-612	3/4	3.38	1.59	1-1/16	1-1/4	3/4	1-1/16-12	1
FJX1616W	16U-616	1	3.78	1.67	1-3/8	1-1/2	1	1-5/16-12	1

IBS, INCORPORATED

High Pressure Hyd. Hose & Fittings O15



37° JIC Female 45° Bent Tube Swivel

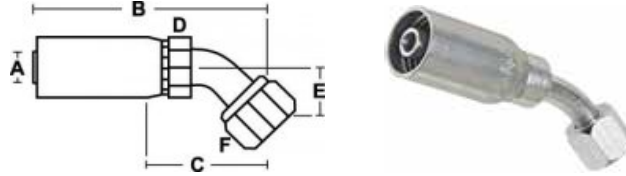

IBS No.	W'Head No.	A	B	C	D	E	F	Hose I.D. (in.)	Thread	Pkg Qty
FJX450404W	04U-684	1/4	2.86	1.80	9/16	0.39	9/16	1/4	7/16-20	1
FJX450406W		1/4	2.93	1.87	11/16	0.43	11/16	1/4	9/16-18	1
FJX450606W	06U-686	3/8	3.26	1.89	11/16	0.43	11/16	3/8	9/16-18	1
FJX450608W	06U-688	3/8	2.82	1.59	7/8	0.71	7/8	3/8	3/4-16	1
FJX450806W	08U-686	1/2	3.28	1.94	3/4	0.43	11/16	1/2	9/16-18	1
FJX450808W	08U-688	1/2	3.65	2.31	7/8	0.59	7/8	1/2	3/4-16	1
FJX450810W	08U-690	1/2	3.30	1.96	1	0.63	1	1/2	7/8-14	1
FJX451010W	10U-690	5/8	4.36	2.26	1	0.63	1	5/8	7/8-14	1
FJX451212W	12U-692	3/4	4.82	3.05	1-1/4	1.15	1-1/4	3/4	1-1/16-12	1
FJX451616W	16U-696	1	5.14	3.03	1-1/2	1.23	1-1/2	1.000	1-5/16-12	1

37° JIC Female 90° Bent Tube Swivel

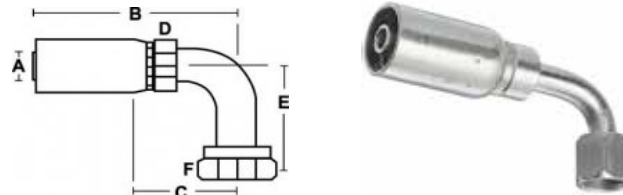

IBS No.	W'Head No.	A	B	C	D	E	F	Hose I.D. (in.)	Thread	Pkg Qty
FJX900404W	04U-664	1/4	2.70	1.64	9/16	.83	9/16	1/4	7/16-20	1
FJX900406W	04U-666	1/4	2.84	1.78	11/16	.91	11/16	1/4	9/16-18	1
FJX900604W	06U-664	3/8	3.03	1.66	9/16	.83	9/16	3/8	7/16-20	1
FJX900606W	06U-666	3/8	3.17	1.80	11/16	.91	11/16	3/8	9/16-18	1
FJX900608W	06U-668	3/8	3.42	2.04	7/8	1.12	7/8	3/8	3/4-16	1
FJX900806W	08U-666	1/2	3.19	1.85	7/8	.91	11/16	1/2	9/16-18	1
FJX900808W	08U-668	1/2	3.49	2.15	1	1.13	7/8	1/2	3/4-16	1
FJX900810W	08U-670	1/2	2.29	1.65	1-1/4	1.23	1	1/2	7/8-14	1
FJX901010W	10U-670	5/8	3.82	1.72	2	1.23	1	5/8	7/8-14	1
FJX901212W	12U-672	3/4	4.51	2.73	2-1/4	2.57	1-1/4	3/4	1-1/16-12	1
FJX901616W	16U-676	1	5.16	3.05	2-7/8	2.80	1-1/2	1	1-5/16-12	1

F I T T I N G S



IBS, INCORPORATED

High Pressure Hyd. Hose & Fittings O15

F I T T I N G S

Female Pipe NPTF Swivel

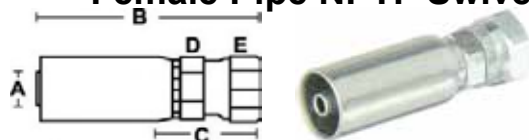

IBS No.	W'Head No.	A	B	C	D	E	Hose I.D. (in.)	Thread	Pkg Qty
FPX0404W	04U-054	1/4	1.90	1.00	9/16	3/4	1/4	1/4-18	1
FPX0606W	06U-056	3/8	2.06	1.00	11/16	7/8	3/8	3/8-18	1
FPX0808W	08U-058	1/2	2.16	1.10	7/8	1	1/2	1/2-14	1
FPX1212W	12U-062	3/4	2.34	1.11	7/8	1-1/4	3/4	3/4-14	1
FPX1616W	16U-676	1	3.42	1.61	1-3/8	1-1/2	1	1-11/12	1

Male Boss O-Ring Rigid

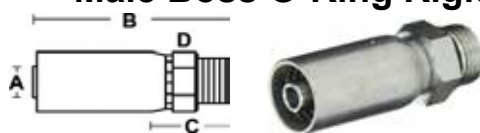

IBS No.	W'Head No.	A	B	C	D	Hose I.D. (in.)	Thread	Pkg Qty
MB0404W	04U-P04	1/4	1.83	.74	5/8	1/4	7/16-20	1
MB0406W	04U-P06	1/4	1.95	.89	11/16	1/4	9/16-18	1
MB0606W	06U-P06	3/8	2.12	.89	11/16	3/8	9/16-18	1
MB0608W	06U-P08	3/8	2.17	.94	7/8	3/8	3/4-16	1
MB0808W	08U-P08	1/2	2.35	1.01	7/8	1/2	3/4-16	1
MB0810W	08U-P10	1/2	2.48	1.14	1-1/16	1/2	7/8-14	1
MB1010W	10U-P10	5/8	3.31	1.21	1-1/16	5/8	7/8-14	1
MB1212W	12U-P12	3/4	2.05	1.26	1-1/4	3/4	1-1/16-12	1
MB1616W	16U-P16	1	3.38	1.27	1-1/2	1	1-5/16-12	1

O-Ring Face Seal Female Swivel



IBS No.	W'Head No.	A	B	C	D	E	Hose I.D. (in.)	Thread	Pkg Qty
FFX0404W	04U-S64	1/4	2.18	1.10	9/16	11/16	1/4	9/16-18	1
FFX0406W	04U-S66	1/4	2.14	1.06	11/16	13/16	1/4	11/16-16	1
FFX0606W	06U-S66	3/8	2.43	1.20	11/16	13/16	3/8	11/16-16	1
FFX0608W	06U-S68	3/8	2.61	1.24	7/8	15/16	3/8	13/16-16	1
FFX0808W	08U-S68	1/2	2.77	1.43	7/8	15/16	1/2	13/16-16	1
FFX0810W	08U-S70	1/2	2.86	1.52	15/16	1-1/8	1/2	1-14	1
FFX1010W	10U-S70	5/8	3.44	1.58	1-1/8	1-1/8	5/8	1-14	1
FFX1212W	12U-S72	3/4	3.64	1.85	1-1/8	1-3/8	3/4	1-3/16-12	1
FFX1616W	16U-S76	1	3.90	1.79	1-3/8	1-5/8	1.0	1-7/16-12	1

IBS, INCORPORATED

Assortments Z06













40 Hole Starter Hydraulic Fittings

IBS No. 250P • 11 Items • 43 Pcs. + 75' of Hose

Packaged in a Steel Storage Bin for Easy Storage & Organization

INCLUDES 25' EACH OF R2504, R2506, R2508



 SPECIALTY PRODUCTS FOR MAINTENANCE & REPAIR INDUSTRIALBOLT.COM • • • 900-678-1906					Hydraulic Fittings Starter Assortment		
Assortment No. 250P							
MP0404 1/4 X 1/4 MALE PIPE RIGID 	MP0604 3/8 X 1/4 MALE PIPE RIGID 	MP0606 3/8 X 3/8 MALE PIPE RIGID 	MP0808 1/2 X 1/2 MALE PIPE RIGID 	NP1212 3/4 X 3/4 MALE PIPE RIGID 			
FJX0404 1/4 X 1/4 37DG JIC FEMALE SWIVEL 	FJX0606 3/8 X 3/8 37DG JIC FEMALE SWIVEL 	FJX0606 3/8 X 3/8 37DG JIC FEMALE SWIVEL 					
FJX900404 1/4 X 1/4 37DG JIC FEMALE 90DG SWIVEL 	FJX900606 3/8 X 3/8 37DG JIC FEMALE 90DG SWIVEL 	FJX900808 1/2 X 1/2 37DG JIC FEMALE 90DG SWIVEL 					

40 Hole Hydraulic Fittings

IBS No. 251P • 40 Items • 101 Pcs. + 75' of Hose

Packaged in a Steel Storage Bin for Easy Storage & Organization

INCLUDES 25' EACH OF R2S04, R2S06, R2S08



 SPECIALTY PRODUCTS FOR MAINTENANCE & REPAIR INDUSTRIALBOLT.COM • • • 900-678-1906					Hydraulic Fittings		
Assortment No. 251P							
MP0402W 1/4HBBW X -2 MALE NPTF 	MP0404W 1/4HBBW X -4 MALE NPTF 	MP0606W 1/4HBBW X -6 MALE NPTF 	MP0604W 3/8HBBW X -4 MALE NPTF 	MP0606W 3/8 X MP-06-06-W 	MP0608W 3/8 X -8 MP RIGID W COUP 	MP0806W 1/2 X 3/8 MP W COUPLING 	MP0808W 1/2 X MP-08-08-W (BQ-10) 
MP0812W 1/2HBBW X -12 MALE NPTF 	MP1212W 3/4 X MP-12-12-W 	MP1616W 1 X MP-16-16-W 	MPX0404W 1/4HBBW X -4 MALE NPTF 	MPX0604W 3/8HBBW X -4 MALE NPTF X 	MPX0606W 3/8HBBW X -6 MALE NPTF 	MPX0608W 3/8HBBW X -8 MALE NPTF 	MPX0808W 1/2HBBW X -8 MALE NPTF 
MPX1212W 3/4 X MPX-12-12-W 	MJ0404W 1/4HBBW X -4 MALE JIC 	MJ0606W 1/4HBBW X -6 MALE JIC 	MJ0606W 3/8HBBW X -6 MJ COUPLING 	MJ0608W 3/8 X -8 MJIC COUP W 	MJ0808W 1/2 X -8 MJIC W COUPLING 	MJ0810W 1/2HBBW X -10 MJ COUPLING 	MJ1212W 3/4 X MJ-12-12-W 
MJ1616W 1 IN X -16 JIC W COUPLING 	FJX0404W 1/4 X FJX-04-04-K2 	FJX0606W 3/8 X FJX-06-06-W (BQ-10) 	FJX0808W 1/2 X FJX-08-08 (BQ-10) 	FJX1212W 3/4 X FJX-12-12-W 	FJX1616W 1 IN X FJX-16-16-W 	FJX900404W 1/4HBBW X 4 FEM JIC 90D 	FJX900606W 3/8 X FJX-06-06-W 
FJX900808W 1/2 X FJX90-08-08-W 	FJX901212W 3/4 X FJX90-12-12-W 	FPX0808W 1/2HBBW X -8 FEM NPSM 	MB0606W 3/8HBBW X -6 MORB THREAD 	MB0608W 3/8HBBW X -8 MORB THREAD 	MB0808W 1/2HBBW X -8 MORB RIGID 	MB0810W 1/2HBBW X -10 MALE ORB 	MB1212W 3/4HBBW MALE ORB COUPLING 

FITTINGS



IBS, INCORPORATED

High Pressure Hyd. Hose & Fittings O15

FITTINGS

High Pressure Hydraulic Fittings

Female Pipe (NPSM Female Swivel) to Male Pipe

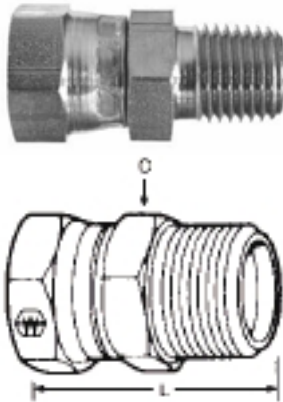

IBS No.	NPSM Swivel Nut	MPT	HEX	L	Qty
9205x2x2	1/8-27	1/8-27	9/16	.900	5
9205x2x4	1/8-27	1/4-18	11/16	1.187	5
9205x4x4	1/4-18	1/4-18	1/16	1.200	5
9205x4x6	1/4-18	3/8-18	11/16	1.200	5
9205x6x4	3/8-18	1/4-18	5/8	1.210	5
9205x6x6	3/8-18	3/8-18	3/4	1.240	5
9205x6x8	3/8-18	1/2-14	7/8	1.540	5
9205x8x6	1/2-14	3/8-18	7/8	1.330	5
9205x8x8	1/2-14	1/2-14	1	1.640	5
9205x8x12	1/2-14	3/4-14	1-1/4	1.620	2
9205x12x12	3/4-14	3/4-14	1-1/4	1.680	2
9205x16x16	1-11-1/2	1-11-1/2	1-1/2	2.010	2

Female Pipe (NPSM Female Swivel) to Male Pipe 90° Elbow

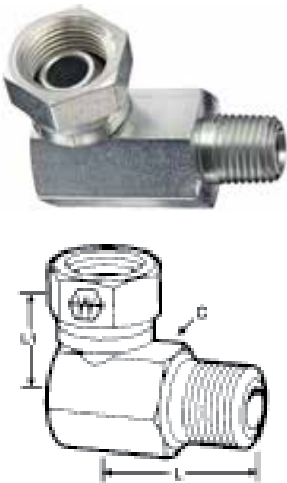

IBS No.	NPSM Swivel Nut	MPT	HEX	L	L1	Qty
9405x4x4	1/4-18	1/4-18	11/16	.980	.750	5
9405x4x6	1/4-18	3/8-18	11/16	1.090	.810	5
9405x6x4	3/8-18	1/4-18	13/16	1.090	.900	5
9405x6x6	3/8-18	3/8-18	7/8	1.090	.900	2
9405x6x8	3/8-18	1/2-14	1	1.840	1.020	2
9405x8x6	1/2-14	3/8-18	1	1.280	1.020	2
9405x8x8	1/2-14	1/2-14	1	1.350	1.020	2
9405x8x12	1/2-14	1/2-14	1-1/4	1.490	1.140	2
9405x12x12	3/4-14	3/4-14	1-1/4	1.490	1.200	2
9405x16x16	1-11-1/2	1-11-1/2	1-1/2	2.380	1.440	2

Swivel Fittings

IBS No. 739R • 15

Items • 30 Pcs

Packaged in a Locking Steel
Drawer for Easy Storage &
Organization

IBS, Inc. SPECIALTY PRODUCTS FOR MAINTENANCE & REPAIR INDUSTRIALBOLT.COM © 2008 800-678-1906					Swivel Fittings
					Assortment No. 739R
9205X2X4 1/8 X 1/4 FEMALE PIPE SWIVEL TO MALE PIPE	9205X4X4 1/4 X 1/4 FEMALE PIPE SWIVEL TO MALE PIPE	9205X4X6 1/4 X 3/8 FEMALE PIPE SWIVEL TO MALE PIPE	9205X6X4 3/8 X 1/4 FEMALE PIPE SWIVEL TO MALE PIPE	9205X6X6 3/8 X 3/8 FEMALE PIPE SWIVEL TO MALE PIPE	
9205X6X8 3/8 X 1/2 FEMALE PIPE SWIVEL TO MALE PIPE	9205X8X6 1/2 X 3/8 FEMALE PIPE SWIVEL TO MALE PIPE	9205X8X8 1/2 X 1/2 FEMALE PIPE SWIVEL TO MALE PIPE			
9405X4X4 1/4 X 1/4 FEMALE PIPE SWIVEL TO MALE PIPE 90DG	9405X4X6 1/4 X 3/8 FEMALE PIPE SWIVEL TO MALE PIPE 90DG	9405X6X4 3/8 X 1/4 FEMALE PIPE SWIVEL TO MALE PIPE 90DG	9405X6X6 3/8 X 3/8 FEMALE PIPE SWIVEL TO MALE PIPE 90DG	9405X6X8 3/8 X 1/2 FEMALE PIPE SWIVEL TO MALE PIPE 90DG	
9405X8X6 1/2 X 3/8 FEMALE PIPE SWIVEL TO MALE PIPE 90DG	9405X8X8 1/2 X 1/2 FEMALE PIPE SWIVEL TO MALE PIPE 90DG				

IBS, INCORPORATED

High Pressure Hyd. Hose & Fittings O15



High Pressure Hydraulic Fittings

JIC 37° Straight Thread BOSS O-Ring Connector

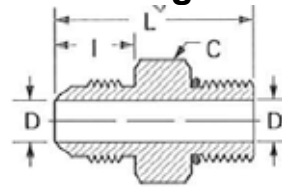

IBS No.	Tube O.D.	Port Size	HEX C	D	D1	I	L	Pkg Qty
C5315X4	1/4	1/4	9/16	.172	.172*	.55	1.23	5
C5315X4X6	1/4	3/8	11/16	.172	.297*	.55	1.29	5
C5315X6X4	3/8	1/4	11/16	.297	.172	.56	1.27	5
C5315X6	3/8	3/8	11/16	.297	.297*	.56	1.30	5
C5315X6X8	3/8	1/2	7/8	.297	.391*	.56	1.38	5
C5315X8X6	1/2	3/8	13/16	.391	.291	.66	1.44	5
C5315X8	1/2	1/2	7/8	.391	.391*	.66	1.48	5
C5315X8X12	1/2	3/4	1-1/4	.609	.609*	.66	1.76	5
C5315X12X8	3/4	1/2	1-1/4	.609	.391	.86	1.94	5
C5315X16	1	1	1-1/2	.844	.844*	.91	2.04	2

JIC 37° 90° Elbow Straight Thread BOSS O-Ring Connector

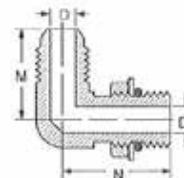

IBS No.	Tube O.D.	Port Size	D	D1	M	N	Across Flats	Pkg Qty
C5515X4	1/4	1/4	.172	.172	.89	1.03	1/2	5
C5515X6	3/8	3/8	.297	.297	1.06	1.25	5/8	5
C5515X6X8	3/8	1/2	.297	.391	1.16	1.45	13/16	5
C5515X8x6	1/2	3/8	.391	.297	1.25	1.34	13/16	5
C5515X8	1/2	1/2	.391	.391	1.25	1.45	13/16	5
C5515X12	3/4	3/4	.609	.609	1.66	1.94	1-1/8	2
C5515X16	1	1	.844	.844	1.81	2.05	1.38	2

Straight Thread BOSS O-Ring

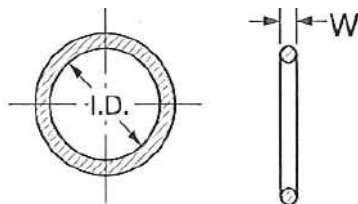

IBS No.	Tube O.D.	W	D	Qty
7629X4	1/4	.072	.351	25
7629X6	3/8	.078	.468	25
7629X8	1/2	.087	.644	25
7629X10	5/8	.097	.755	25
7629X12	3/4	.116	.924	25
7629X16	1	.116	1.171	25

FITTINGS

















IBS, INCORPORATED

High Pressure Hyd. Hose & Fittings O15

Boss O-Ring Fitting Assortment

IBS No. 737R • 15 Items • 46 Pcs.







Packaged in a locking steel drawer for easy storage & organization

IBS, Inc. SPECIALTY PRODUCTS FOR MAINTENANCE & REPAIR INDUSTRIALBOLT.COM © © © 800-678-1906					Boss O-Ring Fittings
					Assortment No. 737R
C5315X4 1/4 X 1/4 MALE JIC TO MALE O-RING BOSS 	C5315X4X6 1/4 X 3/8 MALE JIC TO MALE O-RING BOSS 	C5315X6X4 3/8 X 1/4 MALE JIC TO MALE O-RING BOSS 	C5315X6 3/8 X 3/8 MALE JIC TO MALE O-RING BOSS 	C5315X6X8 3/8 X 1/2 MALE JIC TO MALE O-RING BOSS 	
C5315X8X6 1/2 X 3/8 MALE JIC TO MALE O-RING BOSS 	C5315X8 1/2 X 1/2 MALE JIC TO MALE O-RING BOSS 	C5315X12X8 3/4 X 1/2 MALE JIC TO MALE O-RING BOSS 	C5315X12 3/4 X 3/4 MALE JIC TO MALE O-RING BOSS 		
C5515X4 1/4 MALE JIC TO MALE O-RING BOSS 90DG 	C5515X6 3/8 MALE JIC TO MALE O-RING BOSS 90DG 	C5515X6X8 3/8 X 1/2 MALE JIC TO MALE O-RING BOSS 90DG 	C5515X8X6 1/2 X 3/8 MALE JIC TO MALE O-RING BOSS 90DG 	C5515X8 1/2 MALE JIC TO MALE O-RING BOSS 90DG 	
C5515X12 3/4 MALE JIC TO MALE O-RING BOSS 90DG 					

Straight Thread BOSS O-Ring Travel Tray (Z02)

IBS No. 742R • 6 Items • 135 Pcs

Packaged in a locking plastic container for easy storage & organization

IBS, Inc. SPECIALTY PRODUCTS FOR MAINTENANCE & REPAIR INDUSTRIALBOLT.COM © © © 800-678-1906						Straight Thread O-Rings (BOSS)
						Assortment No. 742R
7629X4 1/4 O-RING BOSS 	7629X6 3/8 O-RING BOSS 	7629X8 1/2 O-RING BOSS 	7629X10 5/8 O-RING BOSS 	7629X12 3/4 O-RING BOSS 	7629X16 1" O-RING BOSS 	



FITTINGS

IBS, INCORPORATED

High Pressure Hyd. Hose & Fittings O15

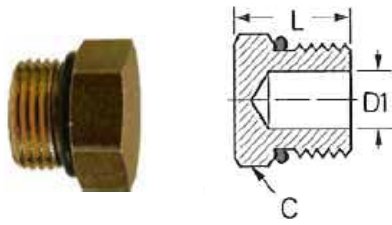

BOSS O-Ring Hex Head Plug

IBS No.	Size	W	D	D1 OPT	Pkg Qty
7237X4	1/4	9/16	.67	.203	5
7237X6	3/8	11/16	.73	.297	5
7237X8	1/2	7/8	.80	.422	5
7237X10	5/8	1	.93	.500	5
7237X12	3/4	1-1/4	1.09	.656	5
7237X16	1	1-1/2	1.12	.875	5

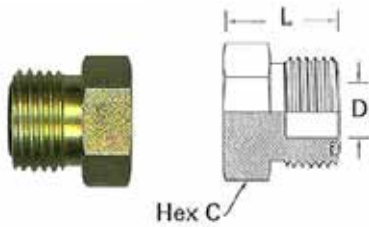

For-Seal Plugs

IBS No.	Tube O.D.	Hex C	D	L	Pkg Qty
4229X4	1/4	5/8	.172	.659	5
4229X6	3/8	3/4	.264	.751	5
4229X8	1/2	7/7	.378	.854	5
4229X10	5/8	1-1/16	.484	1.020	5
4229X12	3/4	1-1/4	.609	1.080	5
4229X16	1	1-1/2	.811	1.100	5

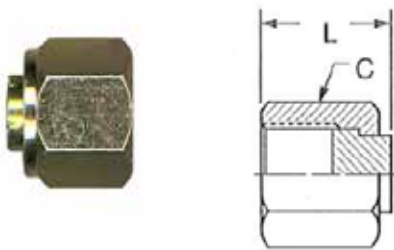

For-Seal Caps

IBS No.	Tube O.D.	Hex C	L	Pkg Qty
4129X4	1/4	11/16	.67	5
4129X6	3/8	13/16	.75	5
4129X8	1/2	15/16	.90	5
4129X10	5/8	1-1/8	1.00	5
4129X12	3/4	1-3/8	1.10	2
4129X16	1	1-5/8	1.17	2

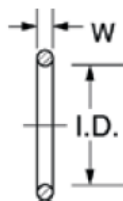

Material:
Buna N, 90 Durometer

Temperature:
-40°F to +250°F
(-40°C to 121°C)

Standard o-ring
complies with SAE
Specification SAE J515
Type CH

For-Seal O-Rings (Flat Face)

IBS No.	Tube O.D.	W	I.D.	Pkg Qty
4629X4	1/4	.070 ± .005	.301 ± .005	25
4629X6	3/8	.070 ± .005	.364 ± .005	25
4629X8	1/2	.070 ± .005	.489 ± .005	25
4629X10	5/8	.070 ± .005	.614 ± .005	25
4629X12	3/4	.070 ± .005	.739 ± .005	25
4629X16	1	.070 ± .006	.926 ± .006	25
4629X20	1-1/4			

FITTINGS



IBS, INCORPORATED

High Pressure Hyd. Hose & Fittings O15

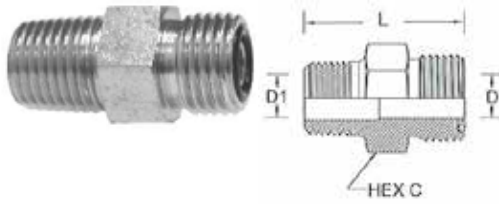

For-Seal Male Pipe Adapter

IBS No.	Tube O.D.	Size	Hex C	D	D1	L	Pkg Qty
4205X6X6	3/8	3/8	3/4	.261	.406	1.30	5
4205X8X8	1/2	1/2	7/8	.378	.484	1.64	5



For Use on Split Flange Fittings

Split Flange O-Rings

IBS No.	Tube O.D.	W	I.D.	Pkg Qty
8X252	1/2	1/8	3/4	5
12X252	3/4	1/8	1	5
16X252	1	1/8	1-5/16	5
20X252	1-1/4	1/8	1-1/2	5
24X252	1-1/2	1/8	1-7/8	5
32X252	2	1/8	2-1/4	5

FITTINGS

Boss and For-Seal Plugs and Caps

IBS No. 736R

15 Items • 48 Pcs.
Packaged in a large steel drawer for easy storage & organization

IBS, Inc. SPECIALTY PRODUCTS FOR MAINTENANCE & REPAIR INDUSTRIALBOLTY.COM © © © 800-678-1506					Boss and For-Seal O-Ring Fittings Cap and Plugs				
					Assortment No. 736R				
7237X4 1/4 O-RING BOSS PLUG	7237X6 3/8 O-RING BOSS PLUG	7237X8 1/2 O-RING BOSS PLUG	7237X10 5/8 O-RING BOSS PLUG	7237X12 3/4 O-RING BOSS PLUG					
4229X4 1/4 FOR-SEAL PLUG	4229X6 3/8 FOR-SEAL PLUG	4229X8 1/2 FOR-SEAL PLUG	4229X10 5/8 FOR-SEAL PLUG	4229X12 3/4 FOR-SEAL PLUG					
4129X4 1/4 FOR-SEAL CAP	4129X6 3/8 FOR-SEAL CAP	4129X8 1/2 FOR-SEAL CAP	4129X10 5/8 FOR-SEAL CAP	4129X12 3/4 FOR-SEAL CAP					

Hydraulic O-Ring Assortment

IBS No. 805R

19 Items • 162 Pcs.
Packaged in a large steel drawer for easy storage & organization

IBS, Inc. SPECIALTY PRODUCTS FOR MAINTENANCE & REPAIR INDUSTRIALBOLTY.COM © © © 800-678-1506					Hydraulic O-Ring Assortment				
					Assortment No. 805R				
8X252 1/2 SPLIT FLANGE O-RING	12X252 3/4 SPLIT FLANGE O-RING	16X252 1" SPLIT FLANGE O-RING	20X252 1-1/4 SPLIT FLANGE O-RING	24X252 1-1/2 SPLIT FLANGE O-RING					
32X252 2" SPLIT FLANGE O-RING	4629X4 1/4 FOR-SEAL O-RING	4629X6 3/8 FOR-SEAL O-RING	4629X8 1/2 FOR-SEAL O-RING	4629X10 5/8 FOR-SEAL O-RING					
4629X12 3/4 FOR-SEAL O-RING	4629X16 1" FOR-SEAL O-RING	4629X20 1-1/4 FOR-SEAL O-RING	7629X4 1/4 O-RING BOSS STRAIGHT THREAD	7629X6 3/8 O-RING BOSS STRAIGHT THREAD					
7629X8 1/2 O-RING BOSS STRAIGHT THREAD	7629X10 5/8 O-RING BOSS STRAIGHT THREAD	7629X12 3/4 O-RING BOSS STRAIGHT THREAD	7629X16 1IN O-RING BOSS STRAIGHT THREAD						

IBS, INCORPORATED

Medium Pressure Hyd. Hose & Fittings O15



Field Attachable Hydraulic Fittings

- Usage: Medium pressure and high temperature hose lines for a variety of applications, including truck, industrial, and small engines where temperature may be a problem.
- Use with medium pressure SAE 100R5 hose.
- Non-Mandrel assembly.

Male NPTF Pipe - Rigid Straight

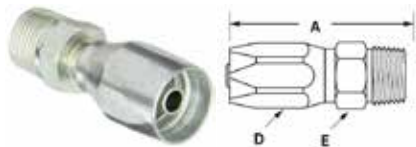

IBS No.	W'Head No.	Pipe Size	Thread	Hose ID	A	Hose Cut-Off Factor	Hole Dia.	Hex D	Hex E
20120-2-4	24704N-102	1/8	1/8-27	3/16	1.71	1	.12	5/8	7/16
20120-4-4	24704N-104	1/4	1/4-18	3/16	1.87	1.12	.12	5/8	9/16
20120-4-5	24705N-104	1/4	1/4-18	1/4	1.96	1.25	.18	11/16	9/16
20120-4-6	24706N-104	1/4	1/4-18	5/16	2.08	1.25	.25	13/16	9/16
20120-6-6	24706N-106	3/8	3/8-18	5/16	2.11	1.25	.25	13/16	11/16
20120-6-8	24708N-106	3/8	3/8-18	13/32	2.48	1.33	.36	15/16	11/16
20120-8-8	24708N-108	1/2	1/2-14	13/32	2.73	1.58	.36	15/16	7/8
20120-8-10	24710N-108	1/2	1/2-14	1/2	2.88	1.63	.45	1-1/8	7/8
20120-12-10	24710N-112	3/4	3/4-14	1/2	2.94	1.69	.45	1-1/8	1-1/8
20120-12-12	24712N-112	3/4	3/4-14	5/8	3.24	1.67	.55	1-1/4	1-1/4

SAE Male Inverted Swivel



IBS No.	W'Head No.	Pipe Size	Thread	Hose ID	A	Hose Cut-Off Factor	Hole Dia.	Hex D	Hex F
22820-4-4	24704N-B04	1/4	7/16-24	3/16	2.54	1.81	.18	5/8	7/16
22820-5-5	24705N-B05	5/16	1/2-20	1/4	2.75	2.00	.21	11/16	1/2
22820-6-6	24706N-B06	3/8	5/16-18	5/16	2.91	2.00	.31	13/16	5/8
22820-8-8	24708N-B08	1/2	3/4-18	13/32	3.63	2.00	.43	15/16	3/4

SAE 37° Female Swivel



IBS No.	W'Head No.	Pipe Size	Thread	Hose ID	Hose Cut-Off Factor	Hole Dia.	A	D	E
20620-6-6	24706N-606	3/8	9/16-18	5/16	1.50	.25	2.35	13/16	11/16
20620-8-8	24708N-608	1/2	3/4-16	13/32	1.75	.36	2.82	15/16	7/8
20620-12-12	24712N-612	3/4	1-1/16-12	5/8	1.94	.55	3.46	1-1/4	1-1/4

SAE 45° Female Swivel



IBS No.	W'Head No.	Pipe Size	Thread (in.)	Hose ID	Hose Cut-Off Factor	Hole Dia.	A	Hex D	Hex E
20820-4-4	24704N-604	1/4	7/16-20	3/16	1.31	.13	2.01	5/8	9/16
20820-5-5	24705N-605	5/16	1/2-20	1/4	1.50	.18	2.19	11/16	5/8
20820-6-6	24706N-406	3/8	5/8-18	5/16	1.46	.25	2.36	13/16	3/4
20820-8-8	24708N-608	1/2	3/4-16	13/32	1.75	.36	2.82	15/16	7/8
20820-8-10	24710N-608	1/2	3/4-16	1/2	1.75	.39	3.04	1-1/8	7/8
20820-10-10	24710N-610	5/8	7/8-14	1/2	1.75	.45	3.04	1-1/8	1
20820-12-12	24712N-412	3/4	1-1/16-14	5/8	1.92	.55	3.49	1-1/4	1-1/4

FITTINGS



IBS, INCORPORATED

Medium Pressure Hyd. Hose & Fittings O15

FITTINGS

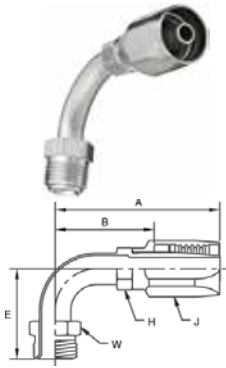

Male Inverted SAE 45° Swivel 90° Elbow

IBS No.	W'Head No.	Pipe Size	Thread (in.)	Hose ID	Hose Cut-Off Factor	Hole Dia.	A	B	Hex D	Hex F
26920-4-4	24704N-E04	1/4	7/16-24	3/16	1.62	.18	2.36	1.69	5/8	7/16
26920-5-5	24705N-E05	5/16	1/2-20	1/4	1.75	.24	2.53	1.69	11/16	1/2
26920-6-6	24706N-E06	3/8	5/8-18	5/16	1.73	.30	2.63	1.73	7/8	5/8



Female SAE 45° Swivel 90° Elbow

IBS No.	W'Head No.	Pipe Size	Thread (in.)	Hose ID	A	B	Hose Cut-Off Factor	Hole Dia.	Hex D	Hex F
27920-4-4	24704N-664	1/4	7/16-20	3/16	1.74	.68	0.99	.12	5/8	9/16
27920-5-5	24705N-665	5/16	1/2-20	1/4	1.96	.77	1.18	.18	11/16	5/8
27920-6-6	24706N-466	3/8	5/8-18	5/16	2.13	.85	1.23	.25	13/16	3/4
27920-8-8	24708N-668	1/2	3/4-16	13/32	2.76	1.09	1.61	.38	15/16	7/8
27920-10-10	24710N-670	5/8	7/8-14	1/2	2.94	1.23	1.62	.45	1-1/8	1
27920-12-12	24712N-472	3/4	1-1/16-14	5/8	3.67	1.82	2.17	.55	1-1/4	1-1/4

Field Attachable Fittings (Z02)

IBS No. 750R • 11 Items • 19 Pieces

Packaged in locking steel drawer for easy storage & organization

Field Attachable Fittings

Assortment No. 750R

<p>20620-6-6 5/16 X 3/8 JIC 37DGR F STRAIGHT SWIVEL</p>	<p>20820-8-8 13/32 X 1/2 SAE 45DGR F STRAIGHT SWIVEL</p>	<p>27920-4-4 3/16 X 1/4 SAE 45DGR FLARE F SWIVEL 90DGR ELBOW</p>
<p>20620-8-8 13/32 X 1/2 JIC 37DGR F STRAIGHT SWIVEL</p>	<p>20820-10-10 1/2 x 5/8 SAE 45DGR F STRAIGHT SWIVEL</p>	<p>27920-6-6 5/16 X 3/8 SAE 45DGR FLARE F SWIVEL 90DGR ELBOW</p>
<p>20820-4-4 3/16 X 1/4 SAE 45DGR F STRAIGHT SWIVEL</p>	<p>20120-8-8 13/32 X 1/2 MALE PIPE RIGID</p>	<p>27920-8-8 13/32 X 1/2 SAE 45DGR FLARE F SWIVEL 90DGR ELBOW</p>
<p>20820-6-6 5/16 X 3/8 SAE 45DGR F STRAIGHT SWIVEL</p>		<p>27920-10-10 1/2 X 3/8 SAE 45DGR FLARE F SWIVEL 90DGR ELBOW</p>



Nylon Pneumatic Tubing

Nylon tubing is a popular choice for low pressure pneumatic applications because of its combination of flexibility and toughness. Our pneumatic tubing uses a heat and light stabilized, very flexible high grade Nylon 12 compound that yields the finest quality tubing available. Nylon 12 raw materials feature good chemical resistance, low water absorption and superior dimensional stability. Nylon is the most recommended tubing material for all types of pneumatic circuits.

Temperature Range: -60°F to +200°F (-60°C to +93°C)



NYLON FRACTIONAL TUBING — 100 FT ROLL

O.D.	I.D.	IBS No.	Color	Thick	O.D.	I.D.	IBS No.	Color	Thick
1/8	0.093	61210	Natural	0.016	3/16	0.137	61330	Natural	0.025
		61211	Black				61331	Black	
		61212	Red				61332	Red	
		61213	Blue				61333	Blue	
		61214	Green				61334	Green	
		61215	Yellow				61335	Yellow	
		61216	Orange				61336	Orange	
		61217	Gray				61337	Gray	
5/32	0.106	61230	Natural	0.025	1/4	0.170	61440	Natural	0.040
		61231	Black				61441	Black	
		61232	Red				61442	Red	
		61233	Blue				61443	Blue	
		61234	Green				61444	Green	
		61235	Yellow				61445	Yellow	
		61236	Orange				61446	Orange	
		61237	Gray				61447	Gray	
3/8	0.275	61660	Natural	0.050	1/2	0.375	61880	Natural	0.035
		61661	Black				61881	Black	
		61662	Red				61882	Red	
		61663	Blue				61883	Blue	
		61664	Green				61884	Green	
		61665	Yellow				61885	Yellow	
		61666	Orange				61886	Orange	
		61667	Gray				61887	Gray	

FITTINGS



IBS, INCORPORATED

Poly-Push Fittings O12

Nylon Pneumatic Tubing



NYLON METRIC TUBING — 100 FT ROLL

O.D.	I.D.	IBS No.	Color	Thick	O.D.	I.D.	IBS No.	Color	Thick
4MM	2.7MM Working Pressure @75°F 275PSI	71020	Natural	.65MM	10MM	8MM Working Pressure @75°F 180PSI	71100	Natural	1.0MM
		71021	Black				71101	Black	
O.D.	I.D.	IBS No.	Color	Thick	O.D.	I.D.	IBS No.	Color	Thick
6MM	4MM Working Pressure @75°F 280PSI	71060	Natural	1MM	12MM	10MM Working Pressure @75°F 165PSI	71120	Natural	1.0MM
		71061	Black				71121	Black	
O.D.	I.D.	IBS No.	Color	Thick					
8MM	6MM Working Pressure @75°F 210PSI	71080	Natural	1MM					

NT100 "Nylon" 11 (O13)



Note: When using copper tubing air brake fittings with nylon tubing, an insert must be used to prevent the tubing from collapsing.

Developed specifically for air brake applications. Can also be used in a wide range of instrumentation and secondary air systems.

Meets all requirements of SAE J844, Type A & B and DOT FMVSS 571.106. 1/8" O. D. size does not meet DOT standards. Offers good resistance to butane, coal, gas, gasoline, kerosene, methane, oxygen, propane, turpentine.

- Type A: Available in 1/8", 1/4" and 5/16" sizes only - not reinforced.
- Type B: Available in 3/8" and larger sizes only - reinforced.
- Available in Black only.
- Temperature range: -40° F to +200° F.
- Construction: Core-nylon; Braid-POLYAMIDE (3/8" and larger sizes only); Jacket-nylon Contains Ultra-Violet Stabilizer
- Application: Air brake systems except where temperatures exceed +200° F or where battery acid can drip on tubing.

IBS No.	O.D. in	Wall in.	MAX Working Pressure PSI 75°F	MIN Burst Pressure PSI 75°F	MIN Bend Radius 70°F	Lbs. Per 100 Ft	Coil Length Feet
NT10002	1/8	.023	150	1000	.375"	.4	25
NT10004	1/4	.040	150	1200	1.0"	1.2	25
NT10006	3/8	.062	150	1400	1.5"	2.9	25
NT10008	1/2	.062	150	950	2.0"	3.8	25
NT10010	5/8	.092	150	900	2.5"	6.8	25

FITTINGS

IBS, INCORPORATED

Miscellaneous Hose & Tubing O13



SAE 30R7 Fuel Line Hose

LOW PRESSURE HOSE (Not for Electronic Fuel Injection)

Multi-purpose hose for use on fuel lines, PCV and EEC systems and for fuel return hose connections on diesel fuel injection systems. Approved for use with leaded and unleaded gasoline, diesel and gasoline blends of ethanol, methanol, and ethers (up to the legal limits allowed by the EPA).



Features:

- Reinforced construction.
- Nitrile tube.
- Hypalon* cover resists the effects of high heat and ozone found in engine compartments.
- Meets or exceeds SAE, OEM Federal and State of California standards for fuel line eec systems. Meets SAE 30R6 and SAE 30R7 requirements.
- Vacuum rating of 24 In/Hg.

WARNING: DOT NOT USE FOR pressure lines on fuel injected engines or cooling system applications. Use Multi-Port Injection (MPI) hose for fuel applications.

IBS No.	Hose ID (in.)	Hose OD (mm)	Rated WP (psi)	Pkg Qty
423-3	3/16	4.8	50	25'
423-4	1/4	6.3	50	25'
423-5	5/16	8.0	50	25'
423-6	3/8	9.5	50	25'
423-8	1/2	12.7	50	25'

General Purpose Air Hose

This is an economical and versatile general purpose hose. Excellent for air and water service, it can also be used for many agricultural chemicals including Lasso herbicide. It's EPDM tube and cover resists heat, sunlight, ozone and weather. All sizes shown exceed RMA class C medium oil resistance criteria which includes reference B requirements. This hose is suitable for applications such as oil mist lubricating air lines, but NOT recommended for the transfer of petroleum products. 4:1 safety factor.



Tube: Black EPDM

Cover: Red EPDM

Reinforcement: Multiple textile plies

Temperature Range: -40°F to +200°F

IBS No.	Hose ID (in.)	Hose OD (mm)	Ply	Rated WP (psi)	Min. Bend Radius	Weight per 100 ft.	Pkg Qty
478-8	1/2	27/32	2	250 psi	4.5	23	50'
478-10	5/8	11/16	2	250 psi	5.5	29	50'
478-12	3/4	1-5/32	2	250 psi	6.0	37	50'

DOT Air Brake Hose

Meets: SAE, J1402, DOT/FMVSS 106 Type All

Temperature Range: -40°C to +100°C (-40°F to +212°F)

Applications include tractor to trailer lines, axle chamber lines and tractor service lines.



IBS No.	Hose I.D.		Hose O.D.		Maximum Operating Pressure		Minimum Burst Pressure		Minimum Bend Radius		QTY
	mm	in	mm	in	bar	psi	bar	psi	mm	in	
71038	9.7	0.38	19.1	0.75	16.0	225	62.0	900	44.5	1.75	25
71050	12.7	0.50	22.4	0.88	16.0	225	62.0	900	50.8	2.00	25

FITTINGS



IBS, INCORPORATED

Miscellaneous Hose & Tubing O13

Yellow Belly PVC Air Hose (V03)

High Visibility Hose with Male NPT Rigid Ends

Yellow Belly Hybrid PVC Air Hose is constructed of a lightweight yet durable hybrid PVC material, and offers an superior alternative to the traditional rubber air hose.



- Half the weight of traditional rubber hose makes it easier to work with.
- Stays flexible in cold weather down to -40°F makes it ideal for colder, outdoor environments.
- Lays flat on the ground and resists kinking for safer use with less chance of tripping over or getting caught.
- Higher working pressure than traditional rubber hose — 300 psi vs 200 psi.
- Bright yellow color makes for improved shop safety.

Hose Material: Hybrid PVC resin

Working Pressure: 300 PSI

Temp Range: -40°F to +200°F

Good Abrasion Resistance

Good Chemical Resistance

IBS No.	Hose ID (in.)	Length (ft.)	Fitting	Color	Rated WP (psi)	Pkg Qty
130530	1/4	50	1/4" NPT Male	Yellow	300	1
130531	1/4	100	1/4" NPT Male	Yellow	300	1
130532	3/8	50	1/4" NPT Male	Yellow	300	1
130533	3/8	100	1/4" NPT Male	Yellow	300	1

SAE20R3 Standard Heater Hose

This lightweight hose is designed for automotive coolant heater hose service. Also ideal for low-pressure water discharge. It is resistant to Lasso herbicide. 4:1 safety factor. **SOLD BY THE FOOT. 25 FT. MINIMUM ORDER**



Tube: Black EPDM

Cover: Black EPDM

Reinforcement: Multiple Textile Plies

Temperature Range: -40°F to +200°F

IBS No.	Hose ID (in.)	Hose OD (mm)	Ply	Rated WP (psi)	Min. Bend Radius (in)	Weight per 100 Ft.
452-10	5/8	29/32	2	62 psi	3.75	21
452-12	3/4	1-1/32	2	50 psi	4.50	25
452-16	1	1-13/32	2	44 psi	7.0	45

Vacuum Tubing (EPDM Rubber)

SAE J1037 Type 2 Specifications Sold by the Foot



IBS No.	ID (in.)	OD (in)	Nipple Size	Pkg Qty
431-2	7/64	9/32	1/8	50 ft.
431-5	5/32	5/16	3/16	50 ft.
431-7	7/32	13/32	1/4	50 ft.

FITTINGS

IBS, INCORPORATED

High Pressure Hyd. Hose & Fittings O15



High Pressure Hose - Braided

SAE 100R1 Hydraulic Hose

Recommended for: Medium pressure hydraulic oil lines
 Tube: Oil resistant synthetic rubber
 Reinforcement: One high tensile steel rubber wire braid
 Cover: Abrasion, ozone and weather-resistant synthetic rubber
 Meets flame resistant MSHA designation
 Temperature Range: -40°F to +212°F (+248°F Max)



IBS No.	W'Head No.	Hose ID	Hose OD (in.)	Rated WP (psi)	Min.Burst (psi)	Min Bend (in.)	Pkg	Spool
R1S04	H10404	1/4	0.53	3265	13053	4	25'	500
R1S06	H10406	3/8	0.69	2610	10443	5	25'	500
R1S08	H10408	1/2	0.81	2320	9282	7	25'	350
R1S10	H10410	5/8	0.93	1885	7542	8	25'	650
R1S12	H10412	3/4	1.09	1525	6092	9.5	25'	500
R1S16	H10416	1	1.40	1275	5076	12	25'	280

SAE 100R2 Hydraulic Hose

Recommended for: High pressure hydraulic oil lines
 Tube: Oil resistant synthetic rubber
 Reinforcement: Two high tensile steel rubber wire braid
 Cover: Abrasion, ozone and weather-resistant synthetic rubber
 Meets flame resistant MSHA designation
 Temperature Range: -40°F to +212°F (+248°F Max)



IBS No.	W'Head No.	Hose ID	Hose OD (in.)	Rated WP (psi)	Min.Burst (psi)	Min Bend (in.)	Pkg	Spool
R2S04	H42504	1/4	0.59	5800	23200	4	25'	500
R2S06	H42506	3/8	0.475	4785	19140	5	25'	450
R2S08	H42508	1/2	0.87	3990	15960	7	25'	320
R2S10	H42510	5/8	1.00	3625	14500	8	25'	520
R2S12	H42512	3/4	1.15	3120	12480	9.5	25'	400
R2S16	H42516	1	1.50	2395	9580	12	25'	165

SAE 100R16 Hydraulic Hose

Recommended for: High pressure hydraulic oil lines
 Tube: Oil resistant synthetic rubber
 Reinforcement: Two high tensile steel rubber wire braid
 Cover: Abrasion, ozone and weather-resistant synthetic rubber
 Meets flame resistant MSHA designation
 Temperature Range: -40°F to +212°F (+248°F Max)



IBS No.	W'Head No.	Hose ID	Hose OD (in.)	Rated WP (psi)	Min.Burst (psi)	Min Bend (in.)	Pkg	Spool
R16S04	H24504	1/4	0.57	5800	23200	2	25'	500
R16S06	H24506	3/8	0.74	4780	19120	2.5	25'	450
R16S08	H24508	1/2	0.86	3980	15920	3.5	25'	320
R16S10	H24510	5/8	1.00	3620	14480	4	25'	520
R16S12	H24512	3/4	1.14	3110	12440	4.8	25'	400
R16S16	H24516	1	1.44	2390	9560	6	25'	200

FITTINGS



IBS, INCORPORATED

High Pressure Hyd. Hose & Fittings O15

Medium Pressure Hose - Braided O15

SAE 100R5 Hydraulic Hose

Recommended for: Medium pressure hydraulic oil lines and other air, water and oil service.

Meets or exceeds requirements of SAE 100R5.

Tube: Black synthetic rubber

Reinforcement: Textile inner braid and a braid of higher tensile steel wire.

Cover: Black, oil resistant textile braid

Temperature Range: -40°F to +250°F (intermittent 300°F)

Skiving Required: No

DOT approved for use in air brake systems

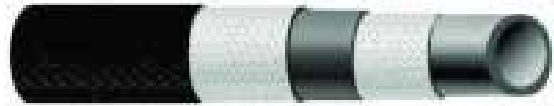

IBS No.	W'Head No.	Hose ID	Hose OD (in.)	Rated WP (psi)	Min.Burst (psi)	Min Bend (in.)	Pkg	Spool
R504	H06904	3/16	0.520	3,000	12,000	3.000	25'	250
R505	H06905	1/4	0.580	3,000	12,000	3.400	25'	250
R506	H06906	5/16	0.680	2,250	9,000	4.000	25'	250
R508	H06908	13/32	0.770	2,000	8,000	4.600	25'	250
R510	H06910	1/2	0.920	1,750	7,000	5.500	25'	250
R512	H06912	5/8	1.080	1,500	6,000	6.500	25'	250

F
I
T
T
I
N
G
S

IBS, INCORPORATED

High Pressure Hyd. Hose & Fittings O15



Hydraulic Hose Shields (O13)



Hydraulic Hose Shields are durable wear shields made of an abrasion resistant material. Easily attached to nearly any size or type of hose these hydraulic hose shields can prevent up to 90% of all failure due to wear at points of contact. With an extremely high wear factor and a wide range of operating temperatures (-40°F to 430°F), the hose shield provides protection in a wide variety of applications.

Features:

- **Extremely high** wear factor.
- Formulated to resist solvents, oils, grease, gasoline, etc.
- Grooves protect cable ties and prevent slipping.
- Operating temperature range is -40° to 430°F.
- Exceptionally cost-effective.
- Installs in minutes — no need to remove hose.
- Available in 4", 6", 8", & 10" sizes.
- Wire ties included for easy assembly.

Protects:

- Hydraulic Hoses
- Battery Cables
- Wiring Harness
- Radiator Hoses
- Fuel Lines
- Air Lines
- Oil Lines
- Brake Systems

Where to Use:

- Agricultural
- Construction
- Industrial
- Mining
- Waste Mgmt
- Transportation
- Road Maintenance
- Brake Systems
- Oil Lines
- Aviation Support
- OEM Manufacturer

IBS No.	Size	Color	Qty	IBS No.	Size	Color	Qty
18180	4"	Black	5	18191	8"	Black	5
18181	4"	Orange	5	18192	8"	Orange	5
18182	4"	Yellow	5	18193	8"	Yellow	5
18185	6"	Black	5	18197	10"	Black	5
18186	6"	Orange	5	—	—	—	—
18187	6"	Yellow	5	—	—	—	—

Hydraulic Hose Shields Assortment (Z02)

IBS No. 367R • 10 Items • 25 Pcs

Packaged in a locking steel drawer for easy storage & organization.



F
I
T
T
I
N
G
S



IBS, INCORPORATED

Miscellaneous Hose & Tubing O13

Spiral Hose Wrap

1/2"

BLACK
5/8"

RED
3/4"

YELLOW

1"

GREEN

1-1/4"

PURPLE

1-1/2"

GRAY

Spiral Hose Wraps are a durable spiral protective wrapping designed for easy installation to existing hydraulic hoses as a quick and cost effective method for minimizing production losses. These hose shields provide protection against wear and damage caused by misuse, poor maintenance, or aggressive working environments.

- **Increases the life of hydraulic hoses**, reducing repairs and down time — Saves Money!
- Protects against abrasive wear and crushing damage.
- Rounded edges facilitate installation and reduce the risk of exposed sharp edges.
- Use to protect a single hose or to bundle hoses together.
- Spiral cut for ultimate flexibility.
- High resistance to ultraviolet weathering.
- Suitable for operations across a wide temperature range -180°F to +250°F.
- Suitable for use with all hydraulic fluids and is impervious to oils, solvent, etc.

Color Coded 8" Pieces

Color Coded 10' & 5' Coils

IBS No.	Size	Color	Use on	Qty	IBS No.	Size	Color	Use on	Qty
19000	1/2" x 8 in.	Black	1/4" ID	1	19001	1/2" x 10 ft.	Black	1/4" ID	1
19002	5/8" x 8 in.	Red	1/4" & 3/8" ID	1	19003	5/8" x 10 ft.	Red	1/4" x 3/8" ID	1
19004	3/4" x 8 in.	Yellow	3/8" ID	1	19005	3/4" x 10 ft.	Yellow	3/8" ID	1
19006	1" x 8 in.	Green	1/2" & 5/8" ID	1	19007	1" x 5 ft.	Green	1/2" x 5/8" ID	1
19008	1-1/4" x 8 in.	Purple	3/4" ID	1	19009	1-1/4" x 5 ft.	Purple	3/4" ID	1
19010	1-1/2" x 8 in.	Gray	1" & 1-1/4" ID	1	19011	1-1/2" x 5 ft.	Gray	1" & 1-1/4" ID	1

Spiral Hose Shields Assortment (Z02)

IBS No. 777R

6 Items • 21 Pcs

Packaged in a locking steel drawer for easy storage & organization.



Black ONLY 8" Pieces

Black ONLY Cut to Length (5' Increments)

IBS No.	Size	Use on	Qty	IBS No.	Size	Use on	Qty
19000	1/2" x 8 in.	1/4" ID	1	19021	1/2"	1/4" ID	FT
19022	5/8" x 8 in.	1/4" & 3/8" ID	1	19023	5/8"	1/4" x 3/8" ID	FT
19024	3/4" x 8 in.	3/8" ID	1	19025	3/4"	3/8" ID	FT
19026	1" x 8 in.	1/2" & 5/8" ID	1	19027	1"	1/2" x 5/8" ID	FT
19028	1-1/4" x 8 in.	3/4" ID	1	19029	1-1/4"	3/4" ID	FT
19030	1-1/2" x 8 in.	1" & 1-1/4" ID	1	19031	1-1/2"	1" & 1-1/4" ID	FT

FITTINGS

IBS, INCORPORATED

Cabinets & Tools T03



Hydraulic Crimper



- **Heavy duty** 60+ ton capacity
- 1/8 to 1-1/4 6-wire capability
- Fully adjustable crimp settings
- 0.125 to 2.75 crimp capability
- Auto micro-switch shut-off
- Good crimp visibility
- Comes with 5 dies standard: KHC-0520, KHC-0670, KHC-0830, KHC-1100, KHC-1320
- Includes die holder
- Quick crimp cycle time
- Well accepted Dayco die configuration
- Interchangeable with Dayco dies
- Built for longevity

IBS No.	Description	Qty
KH60	Hydraulic Crimper	1

HYDRAULIC CRIMP SPECIFICATIONS

STANDARD FITTINGS ON 100R16 & 100R2 HOSE

Hose	IBS No.	SIZE	DIE POSITION	DIE	CRIMP DIM.	GAUGE SETTING
100R16	R16S04	1/4"	TO KNURL	0.52	0.615	86
100R16	R16S06	3/8"	TO KNURL	0.67	0.74	91
100R16	R16S08	1/2"	TO KNURL	0.83	0.86	97
100R16	R16S10	5/8"	TO KNURL	0.83	1	73
100R16	R16S12	3/4"	TO KNURL	1.1	1.13	98
100R16	R16S16	1"	TO KNURL	1.32	1.425	84
100R2	R2S04	1/4"	TO KNURL	0.52	0.645	80
100R2	R2S06	3/8"	TO KNURL	0.67	0.8	76
100R2	R2S08	1/2"	TO KNURL	0.83	0.91	89
100R2	R2S10	5/8"	TO KNURL	0.83	1.03	66
100R2	R2S12	3/4"	TO KNURL	1.1	1.19	87
100R2	R2S16	1"	TO KNURL	1.5	1.507	99

W FITTINGS ON 100R16 & 100R2 HOSE

Hose	IBS No.	SIZE	DIE POSITION	DIE	CRIMP DIM.	GAUGE SETTING
100R16	R16S04	1/4"	FULL	0.67	0.67	100
100R16	R16S06	3/8"	FULL	0.67	0.815	78
100R16	R16S08	1/2"	FULL	0.83	0.945	82
100R16	R16S10	5/8"	FULL	1.1	1.178	90
100R16	R16S12	3/4"	FULL	1.1	1.23	80
100R16	R16S16	1"	FULL	1.5	1.555	95
100R2	R2S04	1/4"	FULL	0.67	0.695	100
100R2	R2S06	3/8"	FULL	0.83	0.845	97
100R2	R2S08	1/2"	FULL	0.83	0.97	77
100R2	R2S10	5/8"	FULL	1.1	1.2	89
100R2	R2S12	3/4"	FULL	1.1	1.285	69
100R2	R2S16	1"	FULL	1.5	1.665	73

FITTINGS



IBS, INCORPORATED

Hydraulic Couplers O17

ISO-A Female Pipe Couplers & Plugs

FEATURES: ISO-A

- Poppet valves prevent uncoupled leakage.
- Critical parts are induction hardened for durability.
- Dependable ball-locking mechanism holds the mating halves together.
- Socket and plug are precision machined from solid barstock.
- Standard nitrile seals temp range -40°F to +250°F.



ISO-A FEMALE PIPE COUPLER

IBS No.	Body Size	NPT	Qty
137782	1/2	1/2	1
137784	3/4	3/4	1
137786	1	1	1



ISO-A FEMALE PIPE PLUG

IBS No.	Body Size	NPT	Qty
137783	1/2	1/2	1
137785	3/4	3/4	1
137787	1	1	1

ISO 7241 -1 ISO-A INTERCHANGE (CONNECTED)

Steel Coupler / Plug

Body Size	Maximum Working		Burst	
	PSI	Bar	PSI	Bar
1/2"	4,000	275	16,500	1,100
3/4"	4,000	275	14,800	1,000
1"	4,000	275	12,400	850

HYDRAULIC ISO-A FEMALE COUPLER INTERCHANGE

IBS No.	Parker	Hansen	Tomco	Dixon	Safeway	Foster	Aeroquip
137782	6601-8-10	HA15231-00	CA5604-26	56-400	S565-4	AF15-08	5601-8-10S
137784	6601-12-12	HA15241-00	CA5606-31	56-660	S565-6	AF15-12	5601-12-12S
137786	6601-16-16	HA15251-00	CA5608-36	56-800	S565-8	AF15-16	5601-16-16S

HYDRAULIC ISO-A FEMALE PIPE PLUG INTERCHANGE

IBS No.	Parker	Hansen	Tomco	Dixon	Safeway	Foster	Aeroquip
137783	6602-8-10	HA15232-00	PA5604-26	57-400	S561-4	AM15-08	5602-8-10S
137785	6602-12-12	HA15242-00	PA5606-31	57-660	S561-6	AM15-12	5602-12-12S
137787	6602-16-16	HA15252-00	PA5608-36	57-800	S561-8	AM15-16	5602-16-16S

FITTINGS

Hydraulic Quick Couplers Assortment (Z02)

IBS No. 825R • 6 Items • 12Pcs
Packaged in a locking steel drawer for easy storage & organization.

Specialty Products for Maintenance & Repair
INDUSTRIAL BOLT.COM © & © 800-878-1506

Hydraulic Quick Couplers

Assortment No. 825R

<p>137782 1/2 X 1/2 ISO-A F PIPE COUPLER HYDRAULIC QUICK DISCONNECT</p>	<p>137784 3/4 X 3/4 ISO-A F PIPE COUPLER HYDRAULIC QUICK DISCONNECT</p>	<p>137786 1 X 1 ISO-A F PIPE COUPLER HYDRAULIC QUICK DISCONNECT</p>	<p>137787 1 X 1 ISO-A F PIPE PLUG HYDRAULIC QUICK DISCONNECT</p>
<p>137783 1/2 X 1/2 ISO-A F PIPE PLUG HYDRAULIC QUICK DISCONNECT</p>	<p>137785 3/4 X 3/4 ISO-A F PIPE PLUG HYDRAULIC QUICK DISCONNECT</p>		

IBS, INCORPORATED

Miscellaneous Hose & Tubing O13



Pipe Thread Protectors NPT Male/Female

Pipe thread protectors can be used as either caps or plugs. Because they are tapered in design and made from highly pliable (or flexible) polyethylene, they cannot only be applied to fit snugly but are readily removable . . . whether used for capping or plugging.

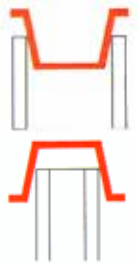

WHEN PLUGGING
"B" Dia. must be at least 1% larger than hole to be plugged. Minimum .020"

WHEN CAPPING
"C" Dia. must be at least 1% smaller than hole to be capped. Minimum .020"

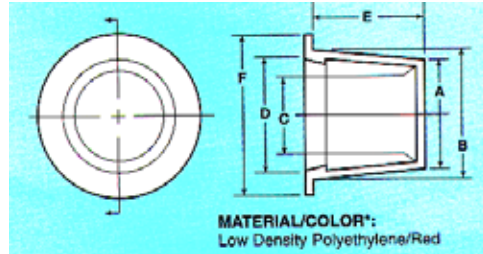

IBS No.	Description	Industry No.	A		B		C		D		E		F		Qty
			in.	mm	in.	mm	in.	mm	in.	mm	in.	mm	in.	mm	
18102	1/8 M NPT Plug	2X	.330	8.26	.396	10.06	.267	6.78	.333	8.46	.38	9.65	.53	13.48	25
18104	1/4 M NPT Plug	4	.419	10.64	.485	12.32	.356	9.04	.422	10.72	.38	9.65	.63	16.00	25
18106	3/8 M NPT Plug	6X	.550	13.97	.631	16.03	.487	12.37	.568	14.43	.47	11.94	.75	19.05	25
18108	1/2 M NPT Plug	9	.690	17.53	.788	20.02	.628	15.95	.726	18.44	.56	14.22	.94	23.88	25
18112	3/4 M NPT Plug	12X	.915	23.24	1.040	26.42	.855	21.72	.980	24.89	.69	17.53	1.16	29.47	25
18116	1 M NPT Plug	14	1.094	27.79	1.215	30.86	1.031	26.19	1.152	29.26	.75	19.05	1.41	35.82	25
18120	1-1/4 M NPT Plug	17S	1.513	38.43	1.600	40.64	1.451	36.86	1.537	39.04	.50	12.70	1.75	44.45	10
18124	1-1/2 M NPT Plug	20S	1.781	45.24	1.805	45.85	1.722	43.74	1.746	44.35	.38	9.65	2.00	50.80	10
18152	1/8 F NPT Cap	4	.419	10.64	.485	12.32	.356	9.04	.422	10.72	.38	9.65	.63	16.00	25
18154	1/4 F NPT Cap	6	.532	13.51	6.08	15.44	.468	11.89	.545	13.84	.44	11.18	.75	19.05	25
18156	3/8 F NPT Cap	8X	.675	17.15	7.55	19.18	.613	15.57	.693	17.60	.50	12.70	.88	22.35	25
18158	1/2 F NPT Cap	11	.802	20.37	.911	23.14	.740	18.80	.849	21.57	.63	16.00	1.06	26.93	25
18162	3/4 F NPT Cap	13X	.995	25.27	1.145	29.08	.933	23.70	1.083	27.51	.75	19.05	1.31	33.28	25
18166	1 F NPT Cap	15X	1.235	31.37	1.360	34.55	1.173	29.80	1.298	32.97	.81	20.57	1.50	38.10	25
18170	1-1/4 F NPT Cap	18	1.560	39.63	1.682	42.72	1.498	38.05	1.620	41.15	.75	19.05	1.88	47.75	10
18174	1-1/2 F NPT Cap	20	1.780	45.61	1.950	49.53	1.718	43.65	1.888	47.96	1.00	25.40	2.13	54.10	10

FITTINGS

Pipe Thread Protector Assortment (Z02)

IBS No. 203R • 16 Items • 340 Pieces

Packaged in locking steel drawer for easy storage & organization

Male/Female
Pipe Thread Protectors

Assortment No. 203R

<p style="font-size: x-small;">18102 1/8 MALE NPT POLY PLUG</p>	<p style="font-size: x-small;">18104 1/4 MALE NPT POLY PLUG</p>	<p style="font-size: x-small;">18106 3/8 MALE NPT POLY PLUG</p>	<p style="font-size: x-small;">18108 1/2 MALE NPT POLY PLUG</p>
<p style="font-size: x-small;">18112 3/4 MALE NPT POLY PLUG</p>	<p style="font-size: x-small;">18116 1 MALE NPT POLY PLUG</p>	<p style="font-size: x-small;">18120 1-1/4 MALE NPT POLY PLUG</p>	<p style="font-size: x-small;">18124 1-1/2 MALE NPT POLY PLUG</p>
<p style="font-size: x-small;">18152 1/8 FEMALE NPT POLY CAP</p>	<p style="font-size: x-small;">18154 1/4 FEMALE NPT POLY CAP</p>	<p style="font-size: x-small;">18156 3/8 FEMALE NPT POLY CAP</p>	<p style="font-size: x-small;">18158 1/2 FEMALE NPT POLY CAP</p>
<p style="font-size: x-small;">18162 3/4 FEMALE NPT POLY CAP</p>	<p style="font-size: x-small;">18166 1 FEMALE NPT POLY CAP</p>	<p style="font-size: x-small;">18170 1-1/4 FEMALE NPT POLY CAP</p>	<p style="font-size: x-small;">18174 1-1/2 FEMALE NPT POLY CAP</p>



IBS, INCORPORATED

Drain Cocks & Valves O05

F
I
T
T
I
N
G
S



Engine Oil Drain Valves

- **Drain engine oil without tools** and without mess.
- **Opens easily** — lift the lever of this solid brass ball valve and give it a quarter turn.
- Return the lever to its original position and it locks closed
- **Double sealed** to prevent leakage.
- Made of **corrosion resistant** forged brass and stainless steel.
- **Ball valve design** provides a straight flow for efficient drainage and a perfect seal when closed.
- **Eliminates frozen drain plug and stripped threads**, saving time and money!
- **Drawing samples for oil analysis is as easy as 1-2-3**
- **Available in sizes to fit** cars, light trucks, vans, heavy duty trucks and buses.

In the United States, the Engine Oil Drain Valve is being installed at the factory level on some of the vehicles and equipment made by Ford, Kohler, Freightliner, Caterpillar, JLG, GEHL, Ingersoll-Rand, Sullair, Toyota, Case, Magnetek, Timberjack, Lincoln Electric, Vermeer, Baldor, Terex, Deutz, Phaser Marine Generator, and more.

ENDORSEMENTS

The Engine Oil Drain Valve has been tested and granted "Genuine Parts" status by 6 major motor vehicle manufacturers in Japan, including Toyota, Nissan, Mazda, Mitsubishi, Subaru, and Isuzu.

SAE

IBS No.	Fumoto No.	Size	Qty
136301	F-101	1/2-20 NF	1
136302	T-204	3/4-16 NF	1
136303	T-203	1-18 NF	1
136304	T-205	1-1/8-12 NF	1

METRIC

IBS No.	Fumoto No.	Size	Qty
136305	F-103	M12-1.25	1
136306	F-107	M12-1/75	1
136307	F-111	M14-1.25	1
136308	F-106	M14-1.5	1
136309	F-108	M16-1.5	1
136311	F-104	M18-1.5	1
136312	T-211	M27-1.5	1

PIPE THREAD

IBS No.	Fumoto No.	Size	Qty
136313	F-110N	3/8-18	1
136314	T-202	1/2-14	1
136315	T-201	3/4-14	1



Index

Abrasives

A

Abrasive Cloth
Cloth Utility Rolls PA-66
Screen Bak Roll PA-66
Abrasives
Eraser Wheel PA-78
Flap Discs
Ceramic Flex Flaps & Mini Flaps PA-48
CURVE Ceramic Power Flaps PA-41
IBS Edge Flap Discs PA-44
IBS SilverBack Non-Loading Flap Discs PA-46
IBS Silverback Roloc Flap Discs PA-46
Zipper Ceramic/Zirconia Trimmable Flap Discs PA-43
Grinding Cones & Cylinders PA-37
Grinding Discs
CC-GRIND-SOLID Rough Grinding Discs PA-56
CC-GRIND-STRONG Rough Grinding Discs PA-57
Grinding Wheels
Flared Grinding Cupstones PA-37
Grind Flaring Cupstones PA-37
IBS Hi-Alloy Ergo-Tech Cup Grinding Wheels PA-8
Hub & Stud Cleaning Disc PA-78
Polishing
Compound Polishes
for Use With Felt Polishing Discs PA-73
Felt Polishing Discs
With Fiberglass Backing PA-73
Roloc Mini Felt Flap Discs PA-73
Roloc Disc Holders PA-68
Sanding Belts
Zirconia+
SCD Sanding Belts PA-49
Surface Conditioning Discs
Trim-Kut Depressed Center Surface Conditioning Discs PA-65
Trim-Kut Surface Conditioning Discs PA-65
Trimmable Flap Discs
Zipper Ceramic/Zirconia Trimmable Flap Discs PA-43
Assortments
2", 3", 4" Roloc Surface Cond Discs
523P Without Surface Grinder PA-

70

2" & 3" Felt Flap Disc Assortments
759R PA-74
2" & 3" Roloc Satin Discs
547P Includes Die Grinder
546P Without Die Grinder PA-70, PA-72, PA-74
2" & 3" Roloc Surface Prep
501P Includes Die Grinder
504P Without Die Grinder PA-69
3" Roloc Grinding Discs
548P Without Die Grinder PA-63
3" Roloc Total Surf Prep
527P Includes Die Grinder
529P Without Die Grinder PA-70
Abrasives
Silverback Non-Loading Roloc Discs Assortment PA-46
Ceramic Roloc Flex Flap & Mini Flap Discs PA-48
Coating Removal Discs
517P Includes Angle Grinder PA-76
519P Without Die Grinder PA-76
Flap Bands PA-51
Flap Wheels PA-53
Hand Wire Scratch Brushes
703R PA-34
Power Tube Brushes
704R PA-33
Roloc Surface Conditioning Discs
542P Without Die Grinder PA-70
Roloc Surface Conditioning Discs
3/4" - 4"
705R PA-69
Roloc Surface Conditioning Discs with Pads
707R Does not include 90° Angle Grinder PA-69
708R Includes 90° Angle Grinder PA-69
Sanding Belt Assortment PA-49
Solid Mini Roloc Ceramic+ Grinding Discs PA-61
Solid Mini Roloc Zirc+ Grinding Discs PA-61
Stem Mounted Wire Brushes
702R PA-30, PA-31
Surface Conditioning Discs with Pads
707R PA-69
Trim-Kut Discs
536P Includes Die Grinder
537P Without Die Grinder PA-64

B

Bristle Discs

4-1/2" PA-75
Standard PA-75
Tapered PA-75
Brushes, Wire
Adapters
Metric PA-28
Crimped Wire Bench Wheels PA-26
Cup
Crimped Wire Type PA-27
Knot Type PA-27
Encapsulated
Conflex PA-32
End Brushes PA-32
General Information PA-22
Hand Scratch
Curved Handle PA-34
Shoe Handle PA-34
Small Wire PA-34
Knot-Type
Beveled Twist PA-26
Standard Twist PA-26
Stringer Bead Twist PA-27
Laminated Wire Brushes & Wheels PA-29
Operating Instructions PA-23
Power Tube Brushes PA-33
Safety Information PA-21
Small Angle Grinder
Crimped Wire Type PA-28
Knot Type PA-28
Stem-Mounted
Circular Flared PA-31
Conflex PA-31
Crimped Wire Cup PA-31
Knot Type End Brush PA-31
Knot Type Wire Wheel PA-31
Solid End Brush PA-31

C

Cloth, Abrasive
Screen Bak Roll PA-66
Utility Rolls PA-66
Coating Removal Discs
for Angle Grinders PA-77
Roloc PA-76
Cup
Crimped Wire Type
Crimped Cup Wire Brush with Protective Guard PA-28
Cupstones
Flared Grinding Cupstones PA-37
Cut-Off Wheels
Chop Saw PA-20
14" Hi-Alloy Chop Saw Cut-Off Wheels PA-20
Flat

A
B
R
A
S
I
V
E
S



Diamond Bore Type PA-18
 High Speed Portable Cut-Off
 Wheel PA-19
 Premium Performance PA-17
 for Angle Grinders
 IBS DIAMOND Cut-Off
 Wheels PA-14
 IBS Hi-Alloy PA-17
 Mid-Alloy Depressed Center Cut-Off
 Wheel PA-18
 RIPPER Abrasive Cut-Off
 Wheels PA-15
 for Die Grinders
 Ceramic PA-16
 IBS DIAMOND Cut-Off
 Wheels PA-14
 IBS Hi Alloy PA-16
 for Ductile Cast Iron PA-19
 Stationary Use PA-20

D

Double Sided Abrasive Discs With Visi-
 Cool PA-58

E

Encapsulated Brushes
 General Information PA-32
 ERGO-TECH Hi-Alloy Cup Grinding
 Wheels PA-8

F

Flap Bands PA-51
 Rubber Expanding Drums PA-
 51, PA-52

Flap Discs

CLEAR-CUT Zirconium Power
 Flaps PA-40

CURVE Ceramic Flap Wheel PA-41

IBS Gorilla Flap Ceramic Discs with
 Fiberglass Backing PA-43

IBS Mini-Flaps PA-47, PA-48

IBS SilverBack Non-Loading Flap
 Discs PA-46

Power Flaps

High Density T27 & T29 PA-45

The Tornado - Maximum Den-
 sity PA-45

STRONG Zirconia Flap Discs PA-42

THE TORNADO Maximum Density
 Power Flap PA-45

Trimmable

Zipper Ceramic/Zirconia Trimmable
 Flap Discs PA-43

Flap Wheels PA-53

G

Grinding Discs

Ceramic Grain PA-62

IBS Gorilla Flap Ceramic

Discs PA-43

IBS Gorilla Grind Rough Grinding

Discs PA-55

Solid Mini Roloc Quick Change

Grinding Discs PA-60

TriFlex Grinding/Blending & Finishing

Wheels PA-12

Trim-Kut PA-64, PA-65

Zirconium

Hi-Alloy PA-62

Plus PA-62

Grinding Wheels

Application Chart PA-6

Bench

Aluminum Oxide PA-36

Premium Blue PA-36

Depressed Center

"Dish" Type 28 PA-11

ERGO-TECH Hi-Alloy Cup Grinding

Wheels PA-8

Flipout Grinder Nut PA-13

General Information PA-5

Grind Flaring Cupstones PA-37

Grinding Wheel Nuts PA-13

IBS Alum-Alloy PA-10

IBS Hi Alloy PA-8, PA-10

Nitro (Superfast) Green PA-9

Nitro XL Superfast Green
 PA-9

Safety Requirements PA-4

H

Hand Pads

Flex Cut PA-66

I

IBS Gorilla Flap Ceramic Discs PA-43

M

Mandrels

3" Grinding Wheels PA-13

Back-Up Pads for Resin Fibre

Discs PA-59

Cut-Off Wheels PA-13, PA-14

Mounted Points PA-35

P

PSA Premium Gold Abrasive Discs
 PA-54

R

Resin Fibre Discs

General Information PA-59

Roloc

Bristle Discs

4-1/2" PA-75

Standard PA-75

Tapered PA-75

Coating Removal Discs PA-76

Grinding, Blending, Finishing

TriFlex Roloc Quick Change

Discs PA-71

Grinding Discs

Ceramic Grain PA-62

Hi-Alloy Zirconium PA-62

Zirconium Plus PA-62

Surface Conditioning Discs PA-67

Unitized Wheels PA-77

S

Satin Discs

High Strength, Roloc PA-72

Satin Wheels

Mounted PA-72

SEMI-FLEX Silicon Carbide

Discs PA-54

Stem-Mounted Extensions 6" &

12" PA-35

Surface Conditioning Bands PA-52

Expanding Rubber Drum PA-52

Medium, Fine & Very Fine PA-52

Surface Conditioning Discs PA-67

Extra Tough Ceramic Grain PA-67

Trim-Kut Surface Conditioning
 Discs PA-65

T

Technical Information

Abrasive Wheels

Safety Requirements PA-4

Encapsulated Brushes

Features & Benefits PA-32

Grinding and Cut Off Wheels

Safety & Cutting Procedures PA-5

Grinding & Cut-Off Wheels

Application Chart PA-6

Grinding Wheels

A.N.S.I., DSA Approvals PA-7

Applications & Recommenda-
 tions PA-39

Safety Do's & Don'ts PA-38

Small Angle Grinder Reference

Chart PA-25

Wire Brushes

Brush Info Tables PA-24

IBS, INCORPORATED

Index



General Information PA-22
Power Brush Operating Instructions PA-23
Safety Information PA-21
Tools
1/4" Air Die Grinder PA-13
1/4" Angle Air Die Grinder PA-13
Pneumatic Belt Sander Kit PA-50

U

Unitized Wheels
Roloc PA-77

W

Wire Brushes
Adapters
Metric PA-28
Brush Info Tables PA-24
Control Brushes
for Fine Finishing PA-30
Crimped Wire Bench Wheels PA-26
Cup
Crimped Wire Type PA-27
Knot Type PA-27
Encapsulated
Conflex PA-32
End Brushes PA-32
General Information PA-22
Knot Type PA-26
Beveled Twist Wheels PA-26
Standard Twist Wheels PA-26
Stringer Bread Twiest
DUALLY Knot-Type Wire Wheel
Brush PA-27
Plastic Handle Scratch Brushes PA-33
Power Brush Operating Instructions PA-23
Power Tube Brushes PA-33
Safety Information PA-21
Small Angle Grinder
Crimped Wire Type PA-28
Knot Type PA-28
Small Angle Grinder Reference
Chart PA-25
Stem Mounted
Circular Flared PA-31
Conflex PA-31
Crimped Wire Cup PA-31
Knot Type End Brush PA-31
Knot Type Wire Wheel PA-31
Solid End Brush PA-31

A
B
R
A
S
I
V
E
S



IBS, INCORPORATED

Grinding Wheels P27

Safety Requirements for the Use, Care and Protection of Abrasive Wheels ANSI B7.1-1978/Approved Feb. 18, 1988 TYPE 1 STRAIGHT WHEELS

Flanges Not Matched

Both the fixed and loose flanges between which a wheel is mounted must be of the same diameter (minimum 1/3 diameter of wheel) and properly relieved. See Fig. 5 for an example of correct mounting. If they are not the same diameter, the wheel is under a bending stress which is likely to cause fracture (See Fig. 6).

Distorted Flanges

Uneven flange pressures, caused by distortion of the flanges due to excessive tightening, create a dangerous condition. When flanges are sprung or distorted, the effective area of contact is reduced and the pressure is moved nearer the hole (See Fig. 7)

Outer Flange Omitted

Both flanges serve a useful purpose and it is extremely dangerous to omit either. In Fig. 8 the outer flange has been omitted and the nut tightened directly against the wheel.

Substitute Flange

A washer is a dangerous substitute for a properly relieved flange. (See Fig 9). The bending stress imposed is likely to cause fracture of the wheel.

Outer Flange Reversed

The condition illustrated in Fig. 10 results in unequal pressure bearing against the wheel, and has the same effect as using flanges of unequal diameter.

Causes of Wheel Breakage

If the breakage of abrasive wheels could be prevented, there would be no need for a guard. Conversely, if all machines could be completely guarded there would be no cause for worry about wheel breakage. However, both must be considered. Everything must be done to prevent wheel breakage and proper guards must be used.

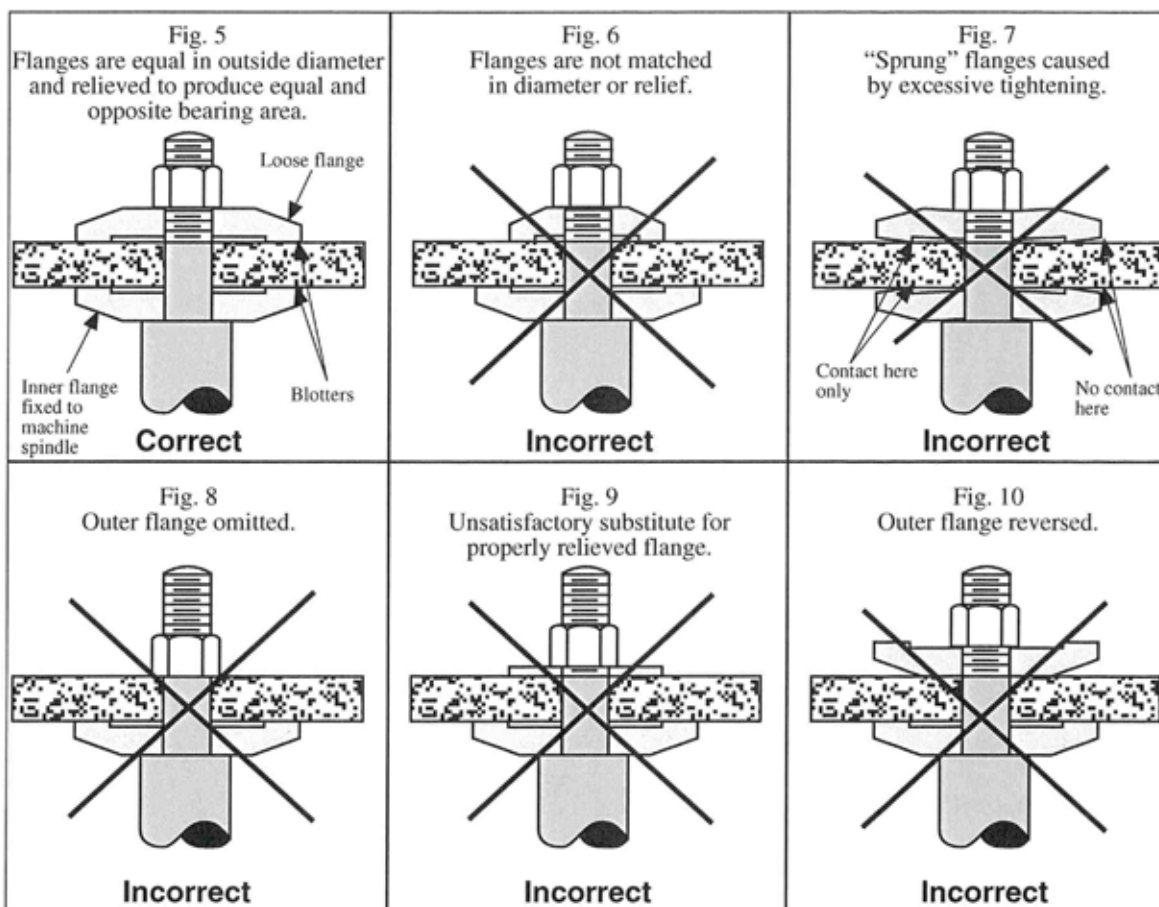



Grinding and Cut Off Wheels

- **Made with aluminum oxide for rapid metal removal**
- **IBS wheels generate less heat than standard wheels — this helps to avoid heat cracks due to overheating.**
- **Outlasts ordinary wheels by up to 300%.**

GRINDING WHEEL SAFETY

DO

1. Always handle and store wheels in a careful manner.
2. Always visually inspect all wheels before mounting for possible damage in transit.
3. Always check maximum operating speed established for wheel against machine speed.
4. Always check mounting flanges for equal and correct diameter.
5. Always use a machine guard covering at least one-half of the grinding wheel.
6. Always allow newly mounted wheels to run at operating speed, with guard in place, for at least one minute before grinding.
7. Always wear protective goggles or other protective eye-wear when grinding.

DON'T

1. Don't use a wheel that has been dropped. The impact may result in breakage.
2. Don't force a wheel onto the machine or alter the size of the arbor hole. Don't use a wheel that fits the arbor too loosely. If the wheel doesn't fit the machine, get one that does.
3. Don't exceed the maximum operating speed established for the wheel.
4. Don't use mounting flanges which are warped, nicked, sprung, or which are not clean.
5. Don't tighten the mounting nut excessively. On multiple screw mountings, 15 pounds per screw is enough.
6. Don't grind on the edge of the wheel unless the wheel is specifically designed for that purpose.
7. Don't start the machine unless the machine guard is in place.
8. Don't stand directly in front of a grinding wheel when a grinder is started.
9. Don't grind material for which the wheel is not designed.
10. Don't use relieved or recessed flanges with threaded hole cup wheels, cones or plugs.

CUT-OFF WHEEL SAFETY AND CUTTING PROCEDURES

1. Cut-off wheels should never be stored on edges. Instead, they should be laid on solid flat surfaces away from excessive heat to prevent warpage.
2. Machines must have adequate power transmission and capacity, spindle speeds and proper guarding of the wheel. It is best to have extra power to insure good cutting efficiency.
3. Check the speed of the machine spindle against the maximum speed specified for the wheel by the manufacturer. The maximum specified speed for the wheel should never be exceeded.
4. Flanges should be clean and straight and of same diameter so wheel will run true. For wheel diameters above 10" it is recommended that the flange be at least 1/3 the diameter size of the wheel.
5. The bore size of the wheel is so constructed that wheel should fit freely on the machine spindle without any slack. Never attempt to force a wheel on the spindle!
6. Always use blotters when supplied with wheels.
7. Be sure the flanges are tightened securely but not too tightly to avoid springing the flanges and changing the pressure area.
8. Be sure the work piece is securely held down, including both sides of the cut, if practical. Cut-off wheels withstand a great deal of radial stress but not any side stress. Even reinforced wheels are not completely unbreakable. Side pressure must be avoided to insure straight cuts and avoid possible wheel breakage.
9. The wheel must be brought into contact with the work without bumping or impact. The wheel should cut freely without forcing and the speed of the wheel should not be reduced by the cutting operation.
10. Abrasive cutting generates a great deal of localized heat which causes rapid expansion of the piece being cut. Wheels operated at speeds significantly below efficient speed or if fed through the cut too slowly will generate excessive heat. Result: Rapid wheel wear fraying around the edge of reinforced wheel and wheel breakage.



IBS, INCORPORATED

Grinding Wheels P27

APPLICATION CHART

| Indicates most common usages

Grinding Wheels

Cut-Off Wheels

Materials / Applications	Grinding Wheels					Cut-Off Wheels		
	NITRO	CERAMIC	HI-ALLOY	MID-ALLOY	ALUM-ALLOY	CERAMIC	HI-ALLOY	MID-ALLOY
Steel								
Unalloyed & alloyed structural steel								
Structural steels with increased strength								
Tool Steel								
High Speed Steels								
Stainless Steel Shapes								
Super alloys (Inconel-Hastalloy) etc.								
Sheet metal								
Stainless sheet								
Grinding edges								
Weld removal								
Thin walled sectional tool								
Castings								
Cast Steel								
Grey Cast Iron								
Nodular Cast Iron								
Malleable Cast Iron								
Non-Ferrous Metals								
Brass, Bronze								
Copper								
Aluminum Alloys								

NITRO: Our fastest grinding wheel ever. This is a superior blend of high-performance grain that is 50% faster cutting than aluminum oxide.

Ceramic: Our toughest and longest lasting wheel. A patented ceramic aluminum oxide blend that is 2-3 times tougher than standard aluminum oxide.

Hi-Alloy: These are our high performance, heavy-duty wheels for various applications. Unique Zirconium and Aluminum oxide blends that provide longer life and faster performance than standard zirconium and aluminum oxide wheels.

Mid-Alloy: Unique Aluminum oxide blends for exceptional value and performance.

Alum-Alloy: Special aluminum oxide formulation for optimum performance with minimum loading and glazing.

A
B
R
A
S
I
V
E
S

IBS, INCORPORATED

Grinding Wheels P27



A.N.S.I., DSA Approvals

For safety reasons grinding and cut-off wheels with high peripheral speeds can only be used in Germany if they have been tested and approved by the German Grinding Wheels Committee (DSA). These DSA Standards are equal to and sometimes exceed A.N.S.I. Safety Code B7.1 1989 standards by a wide margin.

Warning!

Improper use may cause property damage or serious injuries. Comply with A.N.S.I. Safety Code B7.1 and O.S.H.A. regulations. Use safety goggles and machine guards.

Proper Grinding Wheel Technique

Use the following grinding methods to achieve the desired aggressiveness of stock removal and quality of finish.

- For fast material removal increase the grinding angle between the wheel and the work piece.
- For blending and finishing decrease the grinding angle and apply light pressure and fluid motion.

Methods of Cutting

Abrasive wheels can cut materials such as steel, cast iron, non-ferrous metal, stone and ceramics, glass, fire bricks, plastics and exotic material such as Titanium, Inconel, Hastalloy, etc., fast, accurately and economically.

Also suited for red-hot material exceeding 1000°C e.g. rolled stock, continuous castings or forgings. Also when cooled down, this material can still be cut.

In particular materials of high tensile strength which are difficult to saw, e.g. high temperature alloys, high alloyed composite steels, but also stainless steels are the major use of abrasive cutting wheels.

A properly selected wheel and a high performance cut-off machine are necessities for economical abrasive cutting.

Cut-Off Machine Design

1. Adequate motor power and positive power transmission from drive to spindle. The power required depends on the wheel diameter and the cross-section being cut.
2. The feed speed should be adequately rated in order to permit efficient cutting of cold material up to 7.9"/sec. and red-hot material up to 13.8"/sec.
3. The work holding device should ensure rigid damping of work piece.
4. A well-functioning dust-extractor.
5. Wheel and belts must be well-guarded.

There are a number of well designed cut-off machines on the market, from manually operating swing frame cut-off machines (free-hand cutting operation) to remote controlled machines with automatic bar feed and all functional parts totally enclosed.

A
B
R
A
S
I
V
E
S



IBS, INCORPORATED

Grinding Wheels P27

IBS Hi-Alloy ERGO-TECH Cup Grinding Wheels

The saucer shaped grinding wheel features a "built-in" grinding angle which allows the operator to keep their elbow lower and their shoulder more relaxed than they would with a Type 27 or Type 28 wheel.



- The **unique design of the IBS Hi-Alloy Cup Grinding Wheel** allows **more contact between the wheel and the workpiece**, resulting in **more controlled grinding and blending without gouging with less pressure required.**
- **Patent pending ergonomic design** reduces worker fatigue, increasing productivity.
- **Ideal for both flat surfaces and rugged edge** grinding or beveling, making this a versatile wheel for multiple applications.
- **Especially effective on curved surfaces**, where the operator must reach or stretch to perform the job, improving user comfort and increasing productivity.
- The **special 20° design** versus the old Type 28 angle is **designed to fit under standard angle grinder guards**, making this a safer wheel with less chance of injury to workers for maximum workplace safety.
- **Built with 3 full layers of high tensile fiberglass reinforcement** for maximum workplace safety.
- **Designed with a combination of abrasive materials and an A30S grit** for an "all purpose" formulation, perfect for most metals.

A
B
R
A
S
I
V
E
S

QUICK GUIDE
CLEANING
GRINDING
DEBURRING
BLENDING
FINISHING
POLISHING

Use on
ANGLE GRINDERS



for GRINDING ONLY

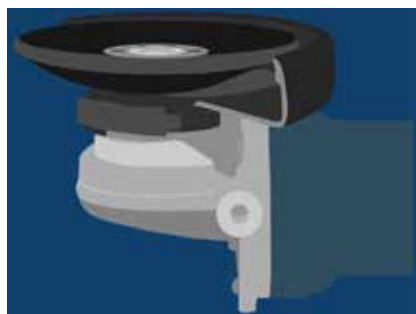

SAFETY ADVANTAGE:
IBS Hi-Alloy ERGO-TECH Cup Grinding Wheels are designed to fit under most standard angle grinder guards when mounted with Depressed Center Wheel flanges provided with the tool.



The wheel has 3 full diameters of high tensile fiberglass reinforcement for maximum safety.



STANDARD TYPE 27 POSTURE



IBS ERGO-TECH POSTURE

IBS HI-ALLOY ERGO-TECH CUP GRINDING WHEELS

IBS No.	Dimensions Dia. x Thickness x Bore	MAX RPM	Qty
60000	4-1/2 X 1/4 X 5/8-11	13,300	10
60004	4-1/2 x 1/4 x 7/8	13,300	10



IBS, INCORPORATED

Grinding Wheels P27



Nitro (Superfast) & Nitro XL Green Grinding Wheels

Our fastest grinding wheel ever! **NITRO** wheels are ideal for extremely fast stock removal on stainless steel, high nickel-based alloys, aluminum and steel. Cuts 20 percent faster than leading brands. Significantly faster grinding reduces time and labor — which means greater cost savings. The **NITRO XL (Xtra Life)** features the same specialty grain and bond combination as the original NITRO, but with the added benefit of a thicker, longer lasting wheel.

Features

- Proprietary high performance abrasive grain
- Unique bonding and wheel design



Type 27

QUICK GUIDE
CLEANING
GRINDING
DEBURRING
BLENDING
FINISHING
POLISHING

Use on
ANGLE GRINDERS



for GRINDING
ONLY

Benefits

- 50% faster cutting time than aluminum oxide
- 20% cooler cutting
- No discoloring or warping of stainless steel
- Better finish
- Reduced operator fatigue
- Smoother, quieter grinding action with more control

Typical Applications

- Tank fabrication
- Power Plant Maintenance and Repair
- Welding / Metal Fabrication Shops

Storage

"NITRO" & "NITRO XL" SUPERFAST GRINDING WHEELS should be stacked flat, not on their edges, in a dry area.

WARNING:

Improper use may cause grinding wheel breakage and serious injury. Grinding wheels should always be used in strict accordance with National Standards Institute (ANSI) Safety Code B7.1 and OSHA regulations.

NITRO XL (XTRA LIFE) GRINDING WHEELS

IBS No.	Type	Arbor	Grit	Dimensions	RPM	Qty
67030	T27	Non Hubbed	36	4-1/2 x 1/4 x 7/8	13,300	10
67035	T27	Hubbed	36	4-1/2 x 1/4 x 5/8-11	13,300	10
67031	T27	Non Hubbed	36	5 x 1/4 x 7/8	12,200	10
67036	T27	Hubbed	36	5 x 1/4 x 5/8-11	12,200	10
67040	T27	Non Hubbed	36	7 x 1/4 x 7/8	8,500	10
67045	T27	Hubbed	36	7 x 1/4 x 5/8-11	8,500	10

NITRO (SUPERFAST) GRINDING WHEELS

IBS No.	Type	Arbor	Grit	Dimensions	RPM	Qty
67005	T27	Non Hubbed	36	4 x 3/16 x 5/8	15,000	10
67010	T27	Non Hubbed	36	4-1/2 x 3/16 x 7/8	13,300	10
67015	T27	Hubbed	36	4-1/2 x 3/16 x 5/8-11	13,300	10
67020	T27	Non Hubbed	36	7 x 3/16 x 7/8	8,500	10
67025	T27	Hubbed	36	7 x 3/16 x 5/8-11	8,500	10

GRINDING WHEEL NUTS

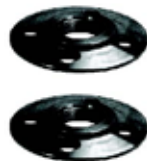

IBS No.	Thread Size	Minimum Wheel Thickness
56494	5/8-11	1/16

For use with 4-1/2" and 5" angle grinders. When mounting, grinding wheel nuts must be nested. GRINDING WHEEL NUTS are SOLD IN PAIRS ONLY.

A
B
R
A
S
I
V
E
S



IBS, INCORPORATED

Grinding Wheels P27

A
B
R
A
S
I
V
E
S



IBS Hi Alloy Grinding Wheels

IBS' super abrasive zirconia grain for rapid cutting combined with the innovative T27 and T28 design provide spectacular cut rate for maximum removal with unsurpassed wheel life.

- Outlasts standard aluminum oxide wheels.
- Allows for maximum stock removal.
- Fewer wheel changes means less downtime.
- Unique Type 28 design means less user fatigue.



TYPE 27



TYPE 28

QUICK GUIDE
CLEANING
GRINDING
DEBURRING
BLENDING
FINISHING
POLISHING
CUTTING

Use on
ANGLE GRINDERS



for **GRINDING ONLY**

IBS No.	Type	Dimensions Dia. x Thickness x Bore	MAX RPM	Pkg Qty	Box Qty
60007	T28	7 x 1/4 x 5/8-11	8,600	1	10
61002	T27	4-1/2 x 1/4 x 7/8	13,300	1	10
61001	T27	4-1/2 x 1/4 x 5/8-11	13,300	1	10
61007	T27	7 x 1/4 x 7/8	8,600	1	10
62008	T27	7 x 1/4 x 5/8-11	8,600	1	10
62009	T27	9 x 1/4 x 5/8-11	6,800	1	10



IBS Alum-Alloy Grinding Wheels

Specially formulated to resist loading when grinding aluminum or other non-ferrous materials. This grinding wheel features aggressive material removal while providing extended wheel life. The optimum wheel for grinding soft, non-ferrous materials, such as: aluminum, copper and brass

- For use on non-ferrous metals — excellent for a wide range of applications.
- Aluminum oxide formulation prevents loading or glazing.
- Internally reinforced with fiberglass layers combines safety with controlled performance.
- Soft abrasive bond to expose cutting edges — for aggressive material removal without loading.



TYPE 27

QUICK GUIDE
CLEANING
GRINDING
DEBURRING
BLENDING
FINISHING
POLISHING
CUTTING

Use on
ANGLE GRINDERS



for **GRINDING ONLY**

IBS No.	Type	Dimensions Dia. x Thickness x Bore	MAX RPM	Pkg Qty	Box Qty
63004	T27	4-1/2 x 1/4 x 5/8-11	13,300	1	10



GRINDING WHEEL NUTS

IBS No.	Thread Size	Minimum Wheel Thickness
56494	5/8-11	1/16"

For use with 4-1/2" and 5" angle grinders. When mounting, grinding wheel nuts must be nested. **GRINDING WHEEL NUTS are SOLD IN PAIRS ONLY.**

IBS, INCORPORATED

Grinding Wheels P27



IBS Mid-Alloy Depressed Center Grinding Wheels



For general purpose grinding on all ferrous metals. Excellent for use on a wide range of grinding applications. Internally reinforced with fiberglass layers for long life and maximum safety.



Use on
ANGLE GRINDERS



QUICK GUIDE
CLEANING
GRINDING
DEBURRING
BLENDING
FINISHING
POLISHING
CUTTING

IBS No.	Dimensions Dia. x Thickness x Bore	MAX RPM	Pkg Qty	Box Qty
64002	4" x 1/4" x 5/8"	15,000	1	10
61114	4-1/2" x 1/4" x 5/8-11	13,300	1	10
63001	4-1/2" x 1/4" x 7/8"	13,300	1	10
00036	5" x 1/4" x 7/8"	12,000	1	10
61004	7" x 1/4" x 7/8"	8,600	1	10
62004	7" x 1/4" x 5/8-11	8,600	1	10
62006	9" x 1/4" x 5/8-11	6,800	1	10

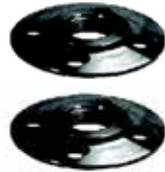

GRINDING WHEEL NUTS

IBS No.	Thread Size	Minimum Wheel Thickness
56494	5/8-11	1/16"

For use with 4-1/2" and 5" angle grinders. When mounting, grinding wheel nuts must be nested. **GRINDING WHEEL NUTS** are **SOLD IN PAIRS ONLY**.

A
B
R
A
S
I
V
E
S

IBS Mid-Alloy Depressed Center Grinding Wheels "Dish" Type 28



Special wheel for heavy duty use on steel and non-ferrous metals. Heavy surface grinding of masonry, concrete, and stone materials. Due to its shape it has 2-1/2 times greater bending strength than flat depressed center grinding wheels. A 15° angle built into the design means it can be used almost horizontally for less fatigue and less possibility of edge chipping.

- Aluminum Oxide
- Fast Stock Removal
- Long Service Life



Use on
ANGLE GRINDERS



QUICK GUIDE
CLEANING
GRINDING
DEBURRING
BLENDING
FINISHING
POLISHING
CUTTING

IBS No.	Dimensions Dia. x Thickness x Bore	MAX RPM	Pkg Qty	Box Qty
63064	9" x 1/4" x 5/8-11	6,800	1	10



IBS, INCORPORATED

Grinding Wheels P27

TriFlex Grinding, Blending & Finishing Wheels



TriFlex Grinding, Blending, & Finishing Wheels are flexible abrasive wheels designed for blending and finishing stainless steel, carbon steel, and aluminum surfaces in just one step.

FOR USE ON: Stainless steel, carbon steel and aluminum surfaces

FEATURES & BENEFITS:

- **Engineered with abrasive grain consistent throughout the wheel** for an even optimal finish for the entire life of wheel – resulting in reduced labor and inventory costs.
- **Innovative blend of materials** results in a wheel that is tough enough to grind and blend yet soft enough to finish in one step for fewer disc changes and faster processing, saving time and money.
- **Made with a blend of cotton fibers and abrasive materials** that are naturally non-loading on all metals making them ideal for use on a variety of materials for reduced inventory costs.
- **Has no backing material that could gouge work surface**, providing a better, more consistent finish throughout the life of the disc for reduced labor and inventory costs.
- **Uniquely engineered with laminates of non-woven abrasive impregnated into cotton fabric**, providing a cushion action for greater flexibility and a better surface finish.
- **The thicker design and flexibility of the wheel** result in longer life – outlasts Surface Conditioning Discs 4-5 times saving time and money.



Size	36 Grit	54 Grit	MAX RPM	Qty
4-1/2 X 7/8	40361	40363	13,300	10
4-1/2 X 5/8-11	40362	40364	13,300	10

For Use with Angle Grinder ONLY

A
B
R
A
S
I
V
E
S

IBS, INCORPORATED

Grinding Wheels P27



1/4" Air Die Grinder (T03)

- Designed for tight, tough quarter jobs that require fast metal removal.
- Very maneuverable and perfect for those hard-to-reach areas.
- 1/4" capacity collet with two collet wrenches included.



IBS No.	Description	RPM	HP
69282	1/4" Air Die Grinder	22,000	.33
69283	1/4" Air Die Grinder W/ Regulator	25,000	.40.

Grinder NOT for use with cut-off wheels over 3" in diameter.
Refer to ASTM B7.1-2001

1/4" 90° Angle Air Die Grinder (T03)

- Great for tight or angled grinding jobs that an in-line die grinder won't reach.
- Rugged ball-bearing motor provides up to 22,000 RPM.
- Efficient rear exhaust air flow system is preferred by professionals everywhere.
- Lever throttle action and 90° angle provide mobility and control.
- Speed (RPM) 22,000.



IBS No.	Description	RPM	HP
127357	1/4" 90° Angle Air Die Grinder	22,000	.30

Grinder NOT for use with cut-off wheels over 3" in diameter.
Refer to ASTM B7.1-2001

Flipout Grinder Nut (P31)

The Flipout Grinder Nut is a unique speed nut that saves time and money by making wheel and disc changes a wrench-less job.



- 5/8-11 Thread
- Quick & Easy Wheel Changes
- No need to purchase the added expense of a built-in arbor on every wheel.
- No searching for a lost wrench!

IBS No.	Thread Size	Description
56495	5/8-11	Flipout Grinder Nut

Grinding Wheel Nuts (P31)

For use with 4-1/2" and 5" angle grinders. When mounting, grinding nuts must be nested. **SOLD IN PAIRS ONLY**



GRINDING WHEEL NUTS

IBS No.	Thread Size	Minimum Wheel Thickness
56494	5/8-11	1/16"

Mandrels (P31)

Mandrels are made of high strength alloy steel, precision machined and heat treated for product safety.



IBS No.	Dimensions (Arbor x Shank)	Use With
69026	1/4" x 1/4"	Cut-Off Wheels
69027	3/8" x 1/4"	Cut-Off Wheels
69030	1/4" x 1/4"	3" Grinding Wheels

A
B
R
A
S
I
V
E
S



IBS, INCORPORATED

Cut-Off Wheels P27

IBS DIAMOND Cut-Off Wheels

IBS Diamond Cut-Off Wheels are our longest lasting cut-off wheels for **sheet metal, mild steel and composite** applications. Made with the highest quality diamond grit allowing longer life, more consistent cuts, and fewer wheel changes, this wheel will last more than 10 times longer than any abrasive cut-off wheel used to cut sheet metal and mild steel.

NOTE: Designed for cutting sheet metal, mild steel and composites. Not for cutting hardened metals or exotic alloys.



TYPE 1

3" Use on
Variable Speed
DIE GRINDERS



for CUT-OFF ONLY

QUICK GUIDE

CLEANING
GRINDING
DEBURRING
BLENDING
FINISHING
POLISHING
CUTTING

IBS No.	Description	MAX RPM
69300	3X1/16X3/8 Diamond Cut-Off Wheel	20,000

NOTE: RPM rating on the 3" wheel is 20,000 and therefore a Die Grinder with a speed regulator is recommended. A slower RPM is recommended (as much as 1/2 the MAX) to improve performance and enhance the overall life of the wheel.

- **Speed Regulated Die Grinders and Angle Grinders are recommended** as these wheels work best when run at slower speeds - typically 1/2 of the MAX RPM listed (i.e. RPM rating on the 3" wheel is 20,000 and therefore a Die Grinder with a speed regulator to run this wheel at 10,000 RPM is recommended to achieve optimum life and results). Running at slower speeds improves performance and enhance the overall life of the wheel.
- Can Also be used to cut angle iron, pipe, electrical conduit, re-bar, metal stud, structural metal make them a **versatile option to reduce wheel change outs**.
- Features **Vacuum Brazed Diamond Grit** that adheres to the wheel longer and better and generates less dust than standard abrasive cut-off wheels which makes for a cleaner, safer cut.
- Unlike regular abrasive cut-off wheels that change diameter during the cutting operation, **IBS Diamond Cut-Off Wheels maintain a maximum cutting depth throughout the life of the wheel**.
- **Bi-directional rotation** can be used on reversible tools to direct sparks and debris away from the operator.
- **Both wheels can be used in WET or DRY applications, and save time and money** on multiple job applications and wheel change-outs.

A
B
R
A
S
I
V
E
S



RIPPER Cut-Off Wheels

High Performance Cutting Technology

For Use on Stainless Steel, Sheet Metal,
Ferrous & Non-Ferrous Metals, and Copper Tubing



Use on
ANGLE GRINDER



RIPPER — CUT-OFF WHEELS

IBS No.	Dimensions Dia. x Thickness x Bore	Type	MAX RPM	Pkg Qty
62541	4-1/2" x .045" x 7/8"	27	13,300	5
69540	4-1/2" x .040" x 7/8"	1	13,300	10
62560	6" x .045 x 7/8"	27	10,185	5
69560	6" x .045 x 7/8"	1	10,185	5

RIPPER — .032 THIN CUT-OFF WHEELS

IBS No.	Dimensions Dia. x Thickness x Bore	Type	MAX RPM	Pkg Qty
62540	4-1/2" x .032" x 7/8"	27	13,300	10

Use on
ANGLE GRINDER



RIPPER — COMBINATION CUT / GRIND WHEEL

IBS No.	Dimensions Dia. x Thickness x Bore	Type	MAX RPM	Pkg Qty
62545	4-1/2" x .075" x 7/8"	27	17,900	5

- **New abrasive technology with a highly advanced bond system is engineered for durability** which means it will outlive other wheels by 3 to 10 times - resulting in fewer wheel change outs and reduced labor costs.
- **Manufactured with an extraordinarily tough abrasive blend that continuously exposes new abrasive material** for a constant aggressive cutting edge that won't load and will cut cooler – for a wheel that cuts faster and lasts longer.
- **Each wheel is protected with our unique moisture blocker** eliminating up to a 50% loss in performance that results when an abrasive absorbs moisture in the air - assuring optimal life and consistent performance for the life of the wheel.

RIPPER Extra Thin, .032 wheel:

FEATURE:

Extra thin cutting disc at only .032 thick is thinner than standard cut off wheels means:

- **Less surface to surface friction** means the wheel cuts fast and with less friction for a cool cut with minimal material loss for a longer life with fewer wheel change outs and reduced labor and inventory costs.
- **Narrow cut requires less pressure with minimal vibration** for improved safety which reduces operator fatigue and time loss.
- **Fast-cutting, exceptionally precise, clean, practically burr-free, smooth-running cut** for optimal results and less rework.

BENEFIT:

A thinner wheel will last longer, cut faster and cut burr free, which means fewer change outs for reduced labor and inventory costs, improved safety, accuracy and production, and minimize rework and operator fatigue.

RIPPER Combination Cut/Grind Wheel:

- **Designed with 3 full surface fabric layers to provide the reinforcement, strength and extremely high side-stability** to allow the wheel to perform aggressively like a grinding wheel while also remaining thin enough to cut giving the user the ability to cut, notch, debur and grind with a single product – resulting in fewer wheel changes for reduced labor and inventory costs.

A
B
R
A
S
I
V
E
S



IBS, INCORPORATED

Cut-Off Wheels P27

IBS Ceramic Cut-Off Wheels for Die Grinders

The IBS Ceramic Cut-Off Wheel is our fastest cutting, longest lasting **ABRASIVE WHEEL!** That means fewer wheel change-outs, reduced labor costs, inventory, and downtime for increased cash flow and efficiency.



TYPE 1

- **Heat-treated CERAMIC GRAIN** — Cuts up to 50% faster than zirconium and up to 6 times faster than aluminum oxide. Ceramic grain fractures cleaner and is the sharpest of any abrasive grain. This fracturing means that new, sharper cutting edges are constantly exposed. The result is optimum performance.
- **Thin** — 1/32" thickness means less friction, less heat build up, faster cutting and maximum life.
- **Designed for tough cutting applications** — Out performs zirconium in all applications.
- **Key applications** — Stainless steel, sheet metal, ferrous and non-ferrous metals and copper tubing.
- **For Optimum Performance** — Apply continuous wheel pressure so that new cutting edges are continuously being exposed.

QUICK GUIDE
CLEANING
GRINDING
DEBURRING
BLENDING
FINISHING
POLISHING
CUTTING

3" & 4" Use on
DIE GRINDERS



for CUT-OFF
ONLY

4-1/2" Use on
ANGLE GRINDER



for CUTTING
ONLY

IBS CERAMIC CUT-OFF WHEELS FOR DIE GRINDERS

IBS No.	Dimensions Dia. x Thickness x Bore	MAX RPM	Pkg Qty	Box Qty
69350	3" x 1/32" x 3/8"	25,100	10	50
69354	4" x 1/32" x 3/8"	20,140	10	50

IBS CERAMIC CUT-OFF WHEELS FOR ANGLE GRINDERS

IBS No.	Dimensions Dia. x Thickness x Bore	MAX RPM	Pkg Qty	Box Qty
69358	4-1/2" x .040" x 7/8"	17,902	5	50

IBS Hi Alloy Cut-Off Wheels for Die Grinders

IBS Hi Alloy Cut-Off Wheels are made of premium zirconium grain for rapid cutting and maximum life. Zirconium grain (synthetic diamond) is the toughest material available for cutting:



TYPE 1

- **Resharpens as it cuts** — for rapid cutting of the toughest steels including stainless. Reduces downtime.
- **Won't load** — lasts up to 5 times longer than aluminum oxide wheels. Excellent on aluminum. Saves money.
- **Runs cool** — won't burn up. Longer life means less replacement. Reduces labor costs associated with the time spent to replace parts.

QUICK GUIDE
CLEANING
GRINDING
DEBURRING
BLENDING
FINISHING
POLISHING
CUTTING

Use on
DIE GRINDERS



for CUT-OFF
ONLY USE WITH
GUARDS

Use on
ANGLE
GRINDER



for CUTTING
ONLY

IBS HI ALLOY CUT-OFF WHEELS FOR DIE GRINDERS

IBS No.	Dimensions Dia. x Thickness x Bore	Grit	MAX RPM	Pkg Qty	Box Qty
69308	3" x 1/32" x 3/8"	60	25,100	10	25/50/100
69313	3" x 1/16" x 3/8"	60	25,100	10	25/50/100
69312	3" x 1/16" x 1/4"	60	25,100	10	25/50/100
69408	4" x 1/32" x 3/8"	60	20,140	10	25/50
69414	4" x 1/16" x 3/8"	60	20,140	10	25/50

IBS HI ALLOY CUT-OFF WHEELS FOR ANGLE GRINDERS

IBS No.	Dimensions Dia. x Thickness x Bore	Grit	MAX RPM	Pkg Qty	Box Qty
69425	4-1/2" x .040" x 7/8"	60	17,902	5	25
69609	6" x .042" x 7/8"	60	14,200	5	25

A
B
R
A
S
I
V
E
S



IBS Hi-Alloy Cut-Off Wheels for Angle Grinders

Fast Cut for Stainless Steel Cut-Off Wheel



TYPE 27

- **Thin Type 27 configuration** for use on right angle grinders. Easier to use with more control.
- **Unique bonding system** allows for fast burr free cutting.
- **Maximum performance with minimum wear** means less wheel changes and downtime.
- **Externally reinforced with fiberglass layers** combining safety with controlled performance.

QUICK GUIDE
CLEANING
GRINDING
DEBURRING
BLENDING
FINISHING
POLISHING
CUTTING

Use on
ANGLE
GRINDER



for CUTTING
ONLY

IBS HI ALLOY CUT-OFF WHEEL FOR ANGLE GRINDERS

IBS No.	Dimensions Dia. x Th. x Bore	MAX RPM	Pkg Qty	Box Qty
62450	4-1/2" x .045" x 7/8"	13,300	1	10
62455	5" x .040 x 7/8	12,000	1	25

Mid Alloy Flat Cut Off Wheel Premium Performance



TYPE 1

Premium performance cut-off wheel for steel, cast iron and non-ferrous metals.

- Aluminum Oxide
- Fast Cutting Action
- Long Service Life

QUICK GUIDE
CLEANING
GRINDING
DEBURRING
BLENDING
FINISHING
POLISHING
CUTTING

Use on
ANGLE
GRINDER



for CUTTING
ONLY

MID ALLOY FLAT CUT-OFF WHEELS "Premium Performance"

IBS No.	Dimensions Dia. x Th. x Bore	MAX RPM	Pkg Qty	Box Qty
63502	4" x 3/32" x 5/8"	19,000	1	25
63503	4-1/2" x 3/32" x 7/8"	13,300	1	25
63505	5" x .040 x 7/8	12,000	1	25
63504	6" x .045" x 7/8"	10,000	1	25

A
B
R
A
S
I
V
E
S



IBS, INCORPORATED

Cut-Off Wheels P27

Mid Alloy Flat Cut-Off Wheel "Diamond Bore Type"



Designed for portable circular saws.
Features Diamond bore with reusable 5/8" bushing.

- Aluminum Oxide
- Fast Cutting Action
- Long Service Life

TYPE 1

MID ALLOY FLAT CUT OFF WHEEL "Diamond Bore Type"

IBS No.	Dimensions Dia. x Th. x Bore	MAX RPM	Pkg Qty	Box Qty
63842	7" x 3/32" x 5/8" ♦	8600	1	10

♦ Diamond Shaped Arbor

QUICK GUIDE

- CLEANING
- GRINDING
- DEBURRING
- BLENDING
- FINISHING
- POLISHING
- CUTTING

Use on
CIRCULAR SAWS



for CUTOFF ONLY

A
B
R
A
S
I
V
E
S

Mid-Alloy Depressed Center Cut-Off Wheel



General purpose cut-off wheel for steel, cast iron, difficult to cut materials and non-ferrous metals.

- Aluminum Oxide
- Fast Cutting Action
- Good Service Life

MID ALLOY DEPRESSED CENTER CUT-OFF WHEELS

IBS No.	Dimensions Dia. x Th. x Bore	MAX RPM	Pkg Qty	Box Qty
63006	4-1/2" x 3/32" x 7/8"	13,300	1	10
63007	4-1/2" x 3/32" x 5/8-11	13,300	1	10
63012	7" x 1/8" x 5/8-11	8,600	1	10

TYPE 27

QUICK GUIDE

- CLEANING
- GRINDING
- DEBURRING
- BLENDING
- FINISHING
- POLISHING
- CUTTING

Use on
ANGLE GRINDER



for CUTTING ONLY



High Speed Portable Cut-Off Wheel



Designed for cutting of steel, non-ferrous metals on portable cut-off machines. A durable, hard-working wheel for a variety of applications on the job site. Excellent for rebar, steel pipe, sheet metal and structural steel or stainless.

- Aluminum Oxide
- Fast Cutting Action
- Long Service Life

TYPE 1

QUICK GUIDE
CLEANING
GRINDING
DEBURRING
BLENDING
FINISHING
POLISHING
CUTTING

Use on
**HIGH SPEED
SAWS**



for CUTOFF ONLY

HIGH SPEED PORTABLE CUT-OFF WHEELS

IBS No.	Dimensions Dia. x Th. x Bore	MAX RPM	Pkg Qty	Box Qty
63509	9" x 3/32" x 7/8	6800	1	25
63034	12" x 1/8" x 1	6300	1	10
64602	12" x 1/8" x 20mm	6300	1	10
64603	14" x 1/8" x 1	5460	1	10
64604	14 x 1/8 x 20mm	5460	1	10

A
B
R
A
S
I
V
E
S



Heavy Duty Wheels for **DUCTILE, CAST IRON** — designed for sewer and water construction and maintenance. Cuts ductile iron, cast iron, and concrete-lined pipe.

TYPE 1

QUICK GUIDE
CLEANING
GRINDING
DEBURRING
BLENDING
FINISHING
POLISHING
CUTTING

Use on
**HIGH SPEED
SAWS**



for CUTOFF ONLY

HEAVY DUTY WHEELS FOR DUCTILE CAST IRON

IBS No.	Dimensions Dia. x Th. x Bore	MAX RPM	Pkg Qty	Box Qty
64612	12" x 1/8" x 20mm	5100	1	10
64614	14" x 1/8" x 1"	6300	1	10
64615	14 x 1/8 x 20mm	5460	1	10



IBS, INCORPORATED

Cut-Off Wheels P27

A
B
R
A
S
I
V
E
S

Cut-Off Wheel Stationary Use

General purpose cut-off wheel for cutting structural steel, bar stock, tubing and non-ferrous metals on stationary machines.

- Aluminum Oxide
- Fast Cutting Action
- Good Service Life



TYPE 1

STATIONARY MID-ALLOY CUT-OFF WHEELS

IBS No.	Dimensions Dia. x Th. x Bore	MAX RPM	Pkg Qty	Box Qty
66002	12" x 1/8" x 1"	5100	1	20
66016	14" x 1/8" x 1"	4400	1	10
66004	16" x 5/32" x 1"	3800	1	10

QUICK GUIDE
CLEANING
GRINDING
DEBURRING
BLENDING
FINISHING
POLISHING
CUTTING

Use on
STATIONARY
SAWS



for CUTOFF
ONLY

14" Hi-Alloy Chop Saw Cut-Off Wheels

- Made of premium zirconium grain for rapid cutting and maximum life.
- Re-sharpens as it cuts — for rapid cutting of the toughest steels including stainless.
- Won't load — last up to 5 times longer than aluminum oxide wheels.
- Runs cool — won't burn up. Longer life means less replacement. Reduces labor costs associated with time spent to replace parts.



TYPE 1

14"HI-ALLOY CHOP SAW CUT-OFF WHEEL

IBS No.	Dimensions Dia. x Th. x Bore	MAX RPM	Pkg Qty	Box Qty
69502	14" x 7/64" x 1"	4366	1	10

QUICK GUIDE
CLEANING
GRINDING
DEBURRING
BLENDING
FINISHING
POLISHING
CUTTING

Use on
CHOP SAWS



for CUTOFF
ONLY

Chop Saw Cut-Off Wheels

Cut-off wheels for cutting drywall studs, rebar and other small cross sections on low-powered chop saws.

- Aluminum Oxide
- Fast Cutting Action
- Long Service Life



TYPE 1

CHOP SAW MID ALLOY CUT-OFF WHEELS

IBS No.	Dimensions Dia. x Th. x Bore	MAX RPM	Pkg Qty	Box Qty
64501	12" x 1/8" x 1"	5100	1	10
64502	14" x 3/32" x 1"	4365	1	10
64503	16" x 3/32" x 1"	3800	1	10

QUICK GUIDE
CLEANING
GRINDING
DEBURRING
BLENDING
FINISHING
POLISHING
CUTTING

Use on
CHOP SAWS



for CUTOFF
ONLY



Safety Information

Warning — In normal power brushing operations the material being removed, such as burrs, scale, dirt, weld slag, or other residue will fly off the brush with considerable force along with brush filaments which break off due to fatigue.

THE POTENTIAL OF SERIOUS INJURY EXISTS for both the brush operator and others in the work area (possible 50 or more feet from the brush). To protect against this hazard, wear SAFETY GOGGLES or FULL FACESHIELDS WORN OVER SAFETY GLASSES WITH SIDE SHIELDS, ALONG WITH PROTECTIVE CLOTHING.

You must follow all operator and safety instructions, as well as all common safety practices which reduce the likelihood of physical injury, or reduce its severity.

Safety Goggles — Safety goggles or full face shields worn over safety glasses with side shields MUST BE WORN by all OPERATORS and OTHERS IN THE AREA of power brush operations. Comply with the requirements of ANSIZ87.1-1979 "Occupational Eye and Face Protection."

Guards — Keep all machine guards in place.

Speeds — Observe all speed restrictions indicated on brushes, containers, labels, or printed in pertinent literature. "MSFS" means Maximum Safe Free Speed (RPM) — spinning free with no work applied. For reasons of safety, "MSFS" should not be exceeded under any circumstances.

Safety Standard — Comply with the Safety Standards of the Industrial Division of the American Brush Manufacturer's Association and the American National Standards Institute Standard ANSI B165.1-1979 — Safety Requirements Power Brushes and ANSI B165.2. Staple Set Power Brush Safety.

Protective Equipment — Appropriate protective clothing and equipment must be used where there is a possibility of injury that can be prevented by such clothing or equipment.

WARNING! FAILURE TO OBSERVE SAFETY PRECAUTIONS MAY RESULT IN INJURY.

BRUSH USAGE RECOMMENDATIONS

Pressure — Avoid excessive pressure when using a power brush. Excessive pressure causes over-bending of the filaments and heat build-up resulting in filament breakage, rapid dulling, and reduced brush life. Instead of greater pressure on a brush, it is suggested that you try: 1) a brush with a more aggressive cutting action (increased wire size, decreased filament length, change to a different brush type, i.e., knot type instead of crimped wire type) or 2) higher speed (increased RPM, increase brush diameter).

Important Note: Never exceed the recommended Maximum Safe Free Speed RPM (MSFS) rating of the brush.

Self-Sharpening — When using wire wheel brushes periodically reverse the direction of rotation to take advantage of the self-sharpening action that will result. This may be accomplished by removing the brush from the spindle and turning side for side and remounting securely.

Brushing Problems — Do Not Allow Unsafe Conditions to Continue. Occasionally, due to worn bearings, a bent spindle, an unusual application, operator abuse or inappropriate use, a brush may fail. A brush which is not received in acceptable condition for trouble-free operation may also fail. Do not use or continue to use a failed brush or one which is functioning improperly (i.e., throwing filaments, out-of-balance, etc.) as this increases the possibility for further brush failure and hazard of injury. The cause of the failure should be evaluated and corrected.

This information is based on the collective experience of the ABMA Industrial Division members and provided solely as a public service for the guidance of users of the member's products. These recommendations are not necessarily complete with respect to any particular application and common sense safety considerations should be adhered to generally. Any applicable federal, state, local law or regulation, must be strictly adhered to, and is controlling over any recommendation contained herein.



IBS, INCORPORATED

Wire Brushes P25

General Information

Power Brush Applications

Deburring — Power brushes are widely used to remove burrs created by other machining operations. Power brushes can completely remove burrs without creating secondary burrs or leaving two sharp edges. Unlike grinding tools, brushes are selective to an edge; they will remove the burr but none of the base material.

Surface Finishing — Power brushes are excellent tools for improving surface finishes to gain a desired appearance. Brushes do not remove the base metal. They remove only the metal particles left on the surface which have been ground or abrasive polished. Power brushing also tends to relieve stress created by other machining operations. Many different surface finishes can be obtained by using power brushes.

Edge Blending — Power brushes are ideal for developing a rounded corner at the juncture of two surfaces. Power brushes perform this application without removing material on the surface adjacent to the edge or changing the part tolerance. This reduces stress concentration and part fatigue, increases part life and improves the surface finish.

Roughening — Power brushes are uniquely suited for creating better bonds on surfaces such as rubber, leather, plastics, and non-ferrous metals. Surfaces can be roughened prior to painting or bonding to achieve better adhesion.

Cleaning — Power brushes are distinctly suited for removal of surface film, dirt, rust, heat treat scale, weld slag, corrosion and paint. Power brushes also remove varnish and insulation from electrical wire, motor stators, etc. Fiber, synthetic and fine stainless steel brushes can be used for wet-cleaning operations.

Advantages of Power Brushes

Rugged Construction — the only surface cleaning and conditioning tool tough enough to stand up under prolonged heavy use.

Easy on Equipment — brushes are non-abrasive so they do not produce equipment-destroying abrasive dust.

True Selective Cutting — brushes act as an impact tool removing surface contamination with millions of tiny hammer blows without cutting away any base material as abrasives will.

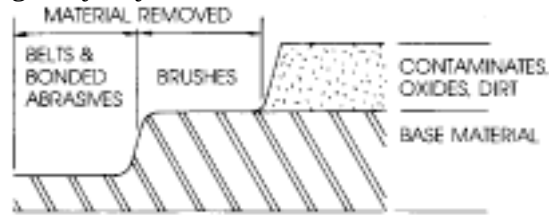

Power brushes remove surface contaminants such as oxides, rust, dirt or other residuals and leave a smooth clean surface.

Stress relieving and surface conditioning — Brushing action produces the same effect as shot peening (a method used to increase the life of highly stressed parts in aircraft and race cars) without adding extra operations. Brushing will not change part tolerances.

Brushes are non-loading — Unlike woven, bonded and coated abrasives, brushes will not load when brushing soft materials.

Brush Fill Materials Wire Types

HT — Is high tensile, heat-treated steel wire which has excellent fatigue resisting and fast cutting qualities. This wire is used in all steel filled power brushes in .008 diameter and above unless otherwise indicated.

TC — Is hard draw wire generally used in .005 and .006 diameter where aggressive cutting action is required for fine surface work.

Stainless (Type 302) — Is highly corrosion resistant and should be used where contamination or after-rust is a problem, such as in brushing aluminum or stainless steel parts. **ALL STAINLESS STEEL BRUSHES ARE MADE WITH TYPE 302 STAINLESS.**

To they layman, most stainless steel looks alike. Stainless steel brush wire is slightly magnetic because it is cold worked to make it hard. Type 302 Stainless Steel will lose its magnetic properties if a wire strand is heated red with a match. If the wire strand retains its magnetic properties after heating it is not Type 302 Stainless Steel.

A
B
R
A
S
I
V
E
S



Power Brush Operating Instructions

Brushing Speeds

1. Power brushes as cutting tools have a most efficient speed and pressure for specific operations. In most operations, the highest speed and lightest pressure will assure fastest cutting action and longest brush life.
2. Using as fine a wire as possible usually results in longer brush life. Increasing the speed of a brush increases the face hardness and cutting action; therefore, a Fine Wire brush rotating at a higher speed will often produce the same results as a Coarser Wire brush rotating at slower speed. Finer Wires operating at a higher speed is generally preferred and will normally provide a longer brush life.
3. Maximum Safe Free Speed — MSFS (RPM) specified in this catalog and on the product are the maximum speeds which the brushes may be used safely and are not necessarily the optimum speed for a given application. Operating speed should be determined by the application, but should not exceed the MSFS (RPM) for which the brush is rated.

Brushing Pressure

1. Remember . . . the tips of a wire brush do the work. Operate the brush with the lightest pressure so only the tips of the wire come in contact with the work.
2. If heavier pressures are used, the wires will be over-stressed, resulting in a wiping action; and if this is continued, the life of the brush will be shortened due to wire fatigue.
3. Apply the work to the face of the brush in such a way that as much of the brush face as possible is in full contact with the work. Applying the work to the side or edge of the brushing tool will result in wire breakage and shortened brush life.
4. Reversing the brush rotation periodically will tend to increase the life of the brush. This results in the re-sharpening of the wire tips or ends, insuring faster cutting action.



CORRECT
Tips doing the work



INCORRECT
Excessive pressure can cause wire breakage

Brushing Action

There are many variables in Power Brushing conditions. In many cases, one or more Power Brushes may accomplish the same results; however, if one brush does not accomplish the desired results, follow the suggestions below:

Brushing Results	Recommended Changes
Works Too Fast	Increase trim length Reduce wire size Reduce fill density Reduce brush dia. or RPM
Works Too Slow	Reduced trim length Increase wire size Increase fill density Increase brush dia. or RPM
Burr Rolled or Peened	Increase fill density Reduce Wire Size
Short Brushing Life	Increase trim length Reduce wire size
Non-Uniform	Increase trim length
Brushing Action	Decrease fill density Use brushing fixture

Flexibility

Long trim brushes are more flexible and are able to follow contoured surfaces. Conversely, short trim brushes are faster acting and suited for more severe brushing action.

Use Brushed Instead of:

- Abrasive Belts
- Harsh Chemicals
- Non-Woven Nylon Products (which wear rapidly)
- Hand Filing
- Sand Blasting
- Steel Wool
- Buffing Wheels
- Hand Sanding
- Tumbling or Vibratory Finishing
- Grinding Wheels

**A
B
R
A
S
I
V
E
S**



IBS, INCORPORATED

Brush Info Tables

Horse Power

The factors affecting the horse power required for power brushing are as follows:

1. Speed of the brush.
2. Brushing pressure required in application.
3. Resistance between the work and the brush.

The chart to the right provides a guide for determining the horsepower required, based on medium brushing action for 1" brush face.

Brush Dia.	Motor Size	RPM
4"	1/4 HP	3,450
6"	1/2 HP	3,450
8"	3/4 HP	3,450
10"	1 HP	1,750
12"	1 HP	1,750
15"	1-1/2 HP	1,750

TABLE OF SURFACE SPEEDS (PERIPHERAL SPEED IN FT/MIN.)

RPM	Diameter (Inches)							
	2	3	4	6	8	10	12	15
1000	525	785	1050	1575	2100	2625	3150	3925
1500	785	1175	1575	2350	3150	3925	4725	5900
1750	915	1375	1850	2750	3650	4550	5500	6800
2500	1300	1950	2625	3925	5250	6550	7850	9825
3000	1575	2350	3125	4725	6275	7850	9425	11775
3450	1800	2700	3600	5400	7200	9000	11000	13500
4000	2100	3150	4175	6275	8375	10475	—	—
6000	3125	4750	6275	9425	—	—	—	—
10,000	5250	7850	10500	—	—	—	—	—
15,000	7850	11775	15750	—	—	—	—	—
20,000	10450	15700	20950	—	—	—	—	—

RECOMMENDED SURFACE SPEEDS FOR BRUSHING APPLICATIONS

Application	Surface Ft Per Min	Application	Surface Ft Per Min
Removing Burs	5500 to 7500	Cleaning (Dry)	4000 to 5500
Removing Scale	7500 to 10000	Cleaning (Wet)	1900 to 4000
Cleaning Welds	7200 to 9400	Surface Polishing	6400 to 8000
Edge Blending	4700 to 7500	Surface Buffing	8000 to 10000

WIRE GAUGES & DECIMAL EQUIVALENTS IN INCHES AND MILLIMETERS

Wire sizes in this catalog are show in decimals of an inch. Corresponding American Steel Wire (formerly Washburn & Moen) gauges and millimeter sizes are listed below.

No. of Gauge	20	23	24	25	26	28	30	32
Diam. (inches)	.035	.026	.023	.020	.018	.016	.014	.0128
Diam. (mm)	.89	.66	.58	.51	.46	.41	.36	.33
No. of Gauge	33	34	35	36	38	43	47	
Diam. (inches)	.0118	.0104	.0095	.009	.008	.006	.005	
Diam. (mm)	.30	.26	.24	.23	.20	.15	.13	

ENGLISH METRIC EQUIVALENTS

Brush Diameter		Brush Face Width		Arbor Hole Sizes	
English	Metric	English	Metric	English	Metric
3"	76mm	1/8"	3mm	1/4"	6.4mm
4"	102mm	1/4"	6mm	3/8"	9.5mm
6"	152mm	3/8"	10mm	1/2"	12.7mm
7"	178mm	1/2"	13mm	5/8"	15.9mm
8"	203mm	5/8"	16mm	3/4"	19.0mm
10"	254mm	3/4"	19mm	7/8"	22.2mm
12"	305mm	7/8"	22mm	1"	25.4mm
14"	356mm	1"	25mm	1-1/8"	28.6mm
15"	381mm	1-1/8"	29mm	1-1/4"	31.8mm
16"	406mm	1/4"	32mm	1-1/2"	38.1mm
		1-1/2"	38mm	1-3/4"	44.5mm
		2"	51mm	2"	50.8mm

Equivalent Units

1 inch = 25.4 millimeters

1 millimeter = 0.03937 inch

A
B
R
A
S
I
V
E
S

IBS, INCORPORATED

Brush Info Tables



SMALL ANGLE GRINDER REFERENCE CHART				
Make	Model Numbers	Male Thread Size	Model Description	RPM
AEG	WS601	5/8-11 UNC	4-1/2" Angle Grinder	10,000
	WS750	5/8-11 UNC	4-1/2" Lightweight Utility Grinder	10,000
BLACK & DECKER	2750/4247/6147	5/8-11 UNC	4-1/2" Angle Grinder	10,000
	4246-09	M10 X 1.50	4-1/2" Angle Grinder	10,000
	6247	M10 X 1.50	4" Angle Grinder	10,000
	4250-10/4252	5/8-11 UNC	5" Angle Grinder	10,000
BOSCH	3255/1377	M14 X 2.0	4-1/2" Mini Grinder	11,000
	1338	M14 X 2.0	5" Mini Grinder	11,000
	7351-103	M14 X 2.0	4-1/2" Air Mini Grinder	11,000
HITACHI	G10/G10SA	M10 X 1.50	4" Angle Grinder	11,000
	PDP-115A/PDS-115A	M10 X 1.50	4-1/2" Angle Grinder	11,000
	PDM-115	5/8-11 UNC	4-1/2" Angle Grinder	9,500
	PDM-125	5/8-11 UNC	5" Angle Grinder	9,500
INGERSOLL-RAND	8245	5/8-11 UNC	HD Angle Grinder	11,000
JET	490004	M10 X 1.25	JEG400	11,000
	490045	5/8-11 UNC	JEG450	11,500
	490005	5/8-11 UNC	JEG500	9,800
MAKITA	9501BKW	M10 X 1.25	4" Sander Grinder	10,000
	9503BHKIT	5/8-11 UNC	4-1/2" Angle Grinder	10,000
	M-952	M10 X 1.25	4" Angle Grinder	10,000
	9005B/GA5000	5/8-11 UNC	5" Angle Grinder	10,000
	9505BHKIT	5/8-11 UNC	5" Angle Grinder	10,000
METABO	AG550	M14 X 2.0	4-1/2" Angle Grinder	10,000
	AG705	M14 X 2.0	5" Angle Grinder	10,000
	EW-9150	M14 X 2.0	6" Angle Grinder	8,500
MILWAUKEE ELECTRIC TOOL	6145	1/2-13 UNC	4-1/2" Sander Grinder	10,000
	6146	1/2-13 UNC	5" Sander Grinder	10,000
PORTER CABLE	7645	5/8-11 UNC	5" Grinder	10,000
RYOBI	G-1150	5/8-11 UNC	4-1/2" Super Grinder	10,000
	SG-1000	3/8-16 UNC	4" Grinder	11,000
	G-1155-C	5/8-11 UNC	4-1/2" Grinder	11,000
	G-1255-C	5/8-11 UNC	5" Grinder	10,000
	SG-1150-C	5/8-11 UNC	4-1/2" Angle Grinder	11,000
SIOUX	1240	M10 X 1.50	4-1/2" HD Disc Grinder	11,000
	1245	5/8-11 UNC	5" Angle Grinder	10,000
SKIL	9405(915)	M10 X 1.50	4-1/2" HD Disc Grinder	12,500
	9611	5/8-11 UNC	4-1/2" Sander/Grinder	12,000

A
B
R
A
S
I
V
E
S



IBS, INCORPORATED

Wire Brushes P35

A
B
R
A
S
I
V
E
S

Crimped Wire Bench Wheels



- In these wheels, traditional individual crimped wires (monofilaments) are substituted by several wires making cable crimped wire.
- Highest quality heat treated steel wire.
- Perfect balance.
- Maximum wire fill provides faster cutting action and long life.
- Ground face for aggressive cutting action.
- For heavy-duty brushing: deburring, weld smoothing, rust and paint removal.
- All Wheels come with Multi-Fitting Arbor Hole Adapter

BRASS Hub Color Coding System allows many of our brushes to be easily identified. The symbol to the left will be shown throughout the catalog. **RED** are CARBON STEEL, **BLUE** are STAINLESS STEEL, and **GREEN** are made with solid BRASS wire. This color coding system helps reduce the chances of cross contamination, a common error in the industry.

IBS No.	Dia. in.	Wire Size	Arbor Hole	Trim Length	Face Width	Maximum Safe Free Speed RPM	Qty
---------	----------	-----------	------------	-------------	------------	-----------------------------	-----

NARROW FACE WHEELS



50039	6	.008	1/2 - 2"	1-1/8"	3/4	6,500	1
50040	6	.012	1/2 - 2"	1-1/8"	3/4	6,500	1
50041	8	.012	1/2 - 2"	1-5/8"	3/4	4,500	1

Arbor Hole Features: Plastic Multi-Fitting Hole Adapter



MULTI-FITTING ARBOR HOLE ADAPTER
(fits up to 7 different sizes)

MEDIUM FACE WHEELS



50042	6	.012	1/2 - 2"	1-1/8	1	6,500	1
50043	8	.012	1/2 - 2"	1-5/8	1	4,500	1
50044	10	.012	1/2 - 2"	2-5/8	1-1/8	3,600	1

- 1/2", 5/8", 3/4", 7/8", 1", 1-3/16" & 2"
- Allows one brush to fit (7) seven different arbor sizes by knocking out the arbor hole bushings.
- Reduces inventory — no adapter needed.

Knot-Type Wire Wheel Brushes



Standard Twist

- High impact action.
- Perfect balance.
- Individually spaced holes for the knots in the internal plate prevents knots from shifting on the brush.
- Removes rust, scale, and weld splatter.
- For heavy-duty brushing, such as weld cleaning, surface conditioning and roughing.

KNOT-TYPE WIRE WHEEL BRUSHES

IBS No.	Dia. in.	Wire Size	Arbor Hole	Trim Length	Face Width	Maximum Safe Free Speed RPM	Qty
---------	----------	-----------	------------	-------------	------------	-----------------------------	-----

Standard Twist Wheels

50045	3	.015	3/8 - 1/2	5/8	3/8	20,000	1
50046	4	.015	3/8 - 1/2	3/4	1/2	20,000	1
50047	6	.015	1/2 - 5/8	1-3/8	1/2	12,500	1

Beveled Twist Wheels

50048	4	.020	5/8 - 11	7/8	NA	15,000	1
-------	---	------	----------	-----	----	--------	---



Standard Twist



Beveled Twist

IBS, INCORPORATED

Wire Brushes P25 & P35



Knot-Type Wire Wheel Brushes

STRINGER BEAD TWIST



STEEL
STAINLESS
BRASS

Technical Information:

- The twisted wire gives these models:
 - Long working life.
 - High removal capacity
 - Ability to work at high speeds

- Very narrow face** for weld cleaning.
- High tensile, heat-treated steel wire** for max. fatigue resistance, long life, and aggressive cutting action.
- Perfect balance.
- For heavy-cleaning of weld splatter and slag, and removal of rust and scale.

IBS No.		Dia. in.	Wire Size	Arbor Hole	Trim Length	Face Width	Max Safe Free Speed	Qty
Steel	Stainless							
50049	50050	4	.020	5/8-11	3/4	3/16	20,000	1
50051	50052	4-1/2	.020	5/8-11	1-1/8	3/16	15,000	1

DUALLY Knot-Type Wire Wheel Brush (P25)

STRINGER BEAD TWIST



Featuring a new patent-pending design, the DUALLY Wire Wheel is the choice for the most demanding inter-pass welding applications such as pipeline construction boiler and pressure vessel fabrication and shipbuilding.

- Features a dual-hex nut design** that simplifies periodic flipping of the wheel for maximum cleaning action, long life and safer use.
- 13/16" Trim Length is shorter** than standard Stringer Bead Twist Wheels, offering maximum strength and cleaning action.

IBS No.	Dia. in.	Wire Size	Arbor Hole	Trim Length	Face Width	Max Safe Free Speed	Qty
79801	4-1/2	.020	5/8-11	13/16	3/16	20,000	1

Wire Cup Brushes

- For heavy-duty cleaning of large areas.
- Perfect balance.
- Excellent for deburring, roughening, removal of weld, scale, paint, rust and corrosion.

Technical Information:

- The twisted wire gives these models:
 - Longer life
 - Higher removal capacity
 - Possibility to work at high speeds
- Designed for use in portable machines.
- Suitable for brushing over large areas with a higher removal capacity.



STEEL
STAINLESS
BRASS

IBS No.		Dia. in.	Wire Size	Arbor Hole	Trim Length	Max Safe Free Speed	Qty
Steel	Stainless						
Knot Type							
50053	50054	4	.020	5/8-11	1	8,500	1
50055		6	.020	5/8-11	1-3/8	6,000	1
Crimped Wire Type							
50056		4	.009	5/8-11 & M14 X 2.0	1-3/16	8,500	1
50057		6	.020	5/8-11	1-1/8	6,000	1

A
B
R
A
S
I
V
E
S



IBS, INCORPORATED

Wire Brushes P25 & P35

Small Angle Grinder Brushes

- Perfect for use with many styles of small angle grinders now on the market.
- For smaller, hard-to-reach locations that need deburring, roughening, cleaning, conditioning, etc.



IBS No.		Dia. in.	Wire Size	Arbor Hole	Trim Length	Max Safe Free Speed	Qty
Steel	Stainless						
Knot Type							
50058	50059	2-3/4	.020	5/8-11	3/4	15,000	1
50060		3-1/2	.020	5/8-11	7/8	15,000	1
Cable Crimped Wire Type							
50061		3	.009	5/8-11	7/8	13,000	1
50062	50063	3-1/2	.012	5/8-11	1-3/16	13,000	1

WIRE WHEEL ADAPTERS - METRIC (P25)

IBS No.	Fixed Thread Size	Adapted Thread Size	Qty
07771	5/8-11 UNC	M10 x 1.25	1
07772	5/8-11 UNC	M10 x 1.50	1

Crimped Cup Wire Brush with Protective Guard



- Cup brush featuring a protective guard for **PROTECTION & VISIBILITY**.
- The guard acts as a shield that prevents wire, dust and any other kind of projections from reaching the user during work.
- The guard is still flexible enough to make it suitable for work not only on open surfaces but also on difficult areas.
- The guard is made of a transparent material that allows the user to see the working area.
- The guard also provides easier handling of the brush, protecting end users against potential pricking caused by the wire.

IBS No.	Dia. (in.)	Wire Size	Arbor Hole	Trim Length	MAX Safe (Free Speed)	Qty
50024	3"	.009	5/8-11	7/8"	13,000	1



A
B
R
A
S
I
V
E
S

IBS, INCORPORATED

Wire Brushes P35



Laminated Wire Brushes & Wheels

- Laminated wire wheels and brushes have a longer life and are easy and comfortable to use.
- The coating protects the wires and prevents them from being damaged. Less wire fractures and breakage provides higher performance and longer life compared to an equivalent uncoated wire.
- Laminated wire is easier, more comfortable, and safer for handling — avoiding and pricking and injury to the user.



Crimped Cup



Knot Wire Cup



Knot Wire Wheel

IBS No.	Diam.	Wire Size	Trim Length	Arbor Hole	Wire Type	Style	RPM Max	Qty
50025	3"	.012	7/8"	5/8-11	Crimped	Cup	15,000	1
50026	2-3/4"	.020	3/4"	5/8-11	Knotted	Cup	15,000	1
50027	4-1/2"	.020	1"	5/8-11	Knotted	Wheel	15,000	1

STEEL
STAINLESS
BRASS



A
B
R
A
S
I
V
E
S

Stem Thread Cleaning Brushes Coated Steel

- **Specially designed** internal brushes for **ROTATING PARTS**.
- **Brushes come in a variety of diameters** for various thread sizes.
- **Brushes have a 1/4" stem to be easily mounted in a drill motor or die grinder** — no need to remove the piece for brushing and cleaning. This means faster clean up of rotating parts, saving users time and money.
- **APPLICATIONS:** Removal of burrs, paint, etc., ideal for maintenance work.



IBS No.	Diam.	Wire Size	Shank Diam.	Wire Type	RPM Max	Qty
50031	3/8"	.012	1/4"	Coated Steel	4,500	1
50032	1/2"					1
50033	5/8"					1
50034	3/4"					1
50095	7/8"					1

STEEL
STAINLESS
BRASS



IBS, INCORPORATED

Wire Brushes P35

Stem Thread Cleaning Brushes Assortment

(Z02)

IBS No. 839R • 5 ITEMS • 5 PCS
Packaged in a Locking Steel Drawer for
easy storage & organization



IBS, Inc. INDUSTRIAL PRODUCTS FOR MAINTENANCE & REPAIR INDUSTRIALPRODUCTS.COM • P.O. BOX 978-1088					Stem Thread Brushes	
Assortment No. 839R						
50031 3/8" .012 1/4" STEM THREAD BRUSH COATED STEEL	50032 1/2" .012 1/4" STEM THREAD BRUSH COATED STEEL	50033 5/8" .012 1/4" STEM THREAD BRUSH COATED STEEL	50034 3/4" .012 1/4" STEM THREAD BRUSH COATED STEEL	50095 7/8" .012 1/4" STEM THREAD BRUSH COATED STEEL		

A
B
R
A
S
I
V
E
S

Control Brushes for Fine Finishing

- **Control Brushes incorporate a rigid degradable material which holds the wire**, preventing its opening to provide much better control of the brushing surface and a higher level of ergonomics over the work.
- **Control Brushes avoid wire breakage**, which means outstanding safety improvement and excellent performance improvement because with less breakage there is less debris flying and the wires and brushes last longer, saving time and money.
- They also **provide for safer handling of the brush**, protecting end users against potential pricking caused by the wire.
- Applications include:

Removal of rust, paint, welding scale, edges, etc.;

Specifically designed for fine finishing

Surface processing in metal, wood, rubber, etc.



IBS No.	Wire	Brush	Diam.	Wire Size	Arbor Hole	Trim Length	RPM rec	MAX	Qty
50035	Knotted	Heavy Removal	5"	.032	5/8-11	1-3/16"	6,000	6,500	1
50036	Knotted	Heavy Removal	3-1/4"	.032	5/8-11		6,000	8,500	1
50037	Crimped	Light Removal	5"	.020	5/8-11		6,000	6,500	1
50038	Crimped	Light Removal	3-1/4"	.020	5/8-11		6,000	8,500	1

IBS, INCORPORATED

Wire Brushes P35



Stem Mounted Brushes

- Shape and dimensions for use in difficult places to access holes, corners, etc.
- Mounted on a 1/4" stem on portable or fixed drills with chuck.
- For deburring, weld cleaning, slag removal, rust and paint removal.

IBS No.		Dia. in.	Wire Size	Trim Length	Maximum Safe Free Speed RPM	Qty
Steel	Stainless					

Circular Flared



50064		1-1/2	.008	n/a	20,000	1
50065		1-1/2	.020	n/a	20,000	1
50066		3	.008	n/a	20,000	1

Conflex 1/2" Face



50067		1-1/2	.012	3/8	20,000	1
50068		3	.008	5/8	15000	1
50069	50070	3	.012	5/8	15,000	1

P25

Crimped Wire Cup



04300		1-3/4	.006	3/4	13,000	1
-------	--	-------	------	-----	--------	---

P25

Knot Type End Brush



50071		3/4	.015	7/8	20,000	1
50094		1	.015	7/8	20,000	1
50072		1-1/4	.020	7/8	20,000	1

Knot Type End Brush - Banded



11141		1-1/8	.020	3/8	18,000	1
-------	--	-------	------	-----	--------	---

P25

Knot Type Wire Wheel



50073		3-1/4"	.014	5/8	20,000	1
-------	--	--------	------	-----	--------	---

Solid End Brush



50074	50075	1/2	.006	3/4	20,000	1
50076		1/2	.015	3/4	20,000	1
50077		3/4	.020	1	20,000	1
50078		1	.020	1-3/16	20,000	1
	50079	1	.012	1-3/16	20,000	1

Stem Mounted Wire Brushes Assortment (Z02)

IBS No. 702R • 8 ITEMS • 8 PCS
Packaged in a Locking Steel Drawer for easy storage & organization



IBS, Inc. SPECIALTY PRODUCTS FOR MAINTENANCE & REPAIR INDUSTRIALDRILL.COM © P.C. 800-475-1000				Stem Mounted Wire Brushes 1/4" Shank	
				Assortment No. 702R	
50074 1/2 .006 SOLID END BRUSH 1/4 SHANK 7/8 TRIM STEEL	50078 1 .020 SOLID END BRUSH 1/4 SHANK 1-1/8 TRIM STEEL	50066 3 .008 CIRCULAR FLARED END 1 1-1/8 TRIM CRIMP STEEL	50067 1-1/2 .0118 CONFLUX WIRE WHEEL 1/4" SHANK		
50077 3/4 .020 SOLID END BRUSH 1/4 SHANK 7/8 TRIM STEEL	50065 1-1/2 FLARED END BRUSH 1/4 SHANK CIRC CRIMP STEEL	04300 1-3/4 .006 WIRE CUP BRUSH 1/4 SHANK CRIMP 3/4 TRIM STEEL	50069 3 .0118 CONFLUX WIRE WHEEL 1/4 SHANK		



IBS, INCORPORATED

Wire Brushes P25

Polyflex® Encapsulated Brushes

ENCAPSULATED WITH A SPECIALLY FORMULATED ELASTOMER

Features & Benefits of the Elastomer

The brush wires are molded into a specially formulated elastomer — providing a controlled brushing face for very aggressive cutting action. As the elastomer wears away, new tips are continually exposed and keep a perpetual short trim for a very long brush life and fewer change-overs.

Constructed for perfect balance — No vibration during use allows for lower equipment maintenance and consistent performance.

Made with "HT" heat-treated carbon steel wire — Provides greater tensile strength again allowing for fewer change-overs. Fatigue resistant to provide a longer brush life and is 100% recyclable.

COLOR CODED ELASTOMERS

BURGUNDY	ORANGE
Standard Wears away easily and is suitable for most manufacturing applications.	Heavy Duty Somewhat harder than the burgundy. It is used for more demanding applications found in heavy steel fabrications and for demanding deburring applications

APPLICATIONS

- Heavy burr removal in slots and narrow confined areas.
- Surface refinement and juncture blending.
- Rubber and plastic flash removal.
- Heavy duty cleaning.

Polyflex® Encapsulated Brushes - Conflex Brushes

MOUNTED ON 1/4" STEMS BURGUNDY ELASTOMER

ENCAPSULATED CONFLEX BRUSHES

IBS No.	Dia. in.	Wire Size	Trim Length	Face Width	Maximum Safe Free Speed RPM	Qty
35305	2	.0118	1/2	1/4	20,000	1
35315	3	.0118	1	1/4	20,000	1



End Brushes

Mounted on 1/4 stems - Hollow Center with Orange Elastomer

ENCAPSULATED END BRUSHES

IBS No.	Dia. in.	Wire Size	Trim Length	Maximum Safe Free Speed RPM	Qty
35535	1/2	.0104	7/8	18,000	1
35545	1	.0104	7/8	18,000	1



A
B
R
A
S
I
V
E
S

IBS, INCORPORATED

Wire Brushes P35



Power Tube Brushes

Also known as internal brushes, power tube brushes provide fast, efficient cleaning and finishing of hard-to-reach surfaces and other difficult-to-access areas.



IBS No.	Dia.	Wire Size	Brush Length	Stem Dia.	Overall Length	Qty
Steel						

Double Stem, Double Spiral

50080	3/8	.006	1-1/2	1/8	6	1
50081	1/2	.006	2	5/32	5	1
50082	5/8	.005	2	7/32	5	1
50083	3/4	.006	2-1/2	1/4	5-1/2	1
50084	1	.006	2-1/2	1/4	5-1/2	1
50085	1-1/4	.0104	2-1/2	1/4	5-1/2	1

Use with power tools for heavy duty cleaning and deburring

Power Tube Brushes Assortment (Z02)

IBS No. 704R • 6 ITEMS • 6 PIECES
PACKAGED IN A CLEAR PLASTIC BOX

Power Tube Brushes Assortment (Z02)

IBS No. 816R • 6 ITEMS • 6 PIECES
PACKAGED IN A LOCKING STEEL DRAWER



Plastic Handle Scratch Brushes

- A tighter, longer and narrower hand scratch brush for **LONG LIFE AND MAXIMUM REMOVAL**.
- The high wire density provides higher brushing pressure which means a stronger and stiffer hand brush for maximum removal capacity.
- This special design has a narrower face to allow easy access into slots as small as 1/4"



IBS No.	Total Length	Usable Length	Face Width	Trim Length	Fill Material	Qty
50028	10"	5"	5/8"	1-1/8"	Coated Steel (.014")	1
50029					Stainless Steel (.012")	1
50030					Brass (.012")	1

A
B
R
A
S
I
V
E
S



IBS, INCORPORATED

Maintenance Brushes P35

Hand Wire Scratch Brushes

SOLD IN QUANTITIES OF TWO (2)

- For removing rust, scale, paint, solder etc.
- Use to clean threads, files, metal parts and castings

CURVED HANDLE WIRE SCRATCH BRUSH

IBS No.	# of Rows	Block Size	Wire Size	Trim Length	Fill Material	Qty
50086	3 x 19	14 x 7/8	.012	1-3/16	Standard Wire	12
50087	3 x 19	14 x 7/8	.012	1-3/16	Stainless	12

SHOE HANDLE WIRE SCRATCH BRUSH

IBS No.	# of Rows	Block Size	Wire Size	Trim Length	Fill Material	Qty
50088	4 x 16	10 x 1-1/8	.012	1-3/16	Standard Wire	12
50089	4 x 16	10 x 1-1/8	.012	1-3/16	Stainless	12
50090	4 x 18	10 x 1-1/8	.012	1"	Brass Wire	12

SMALL WIRE SCRATCH BRUSH

IBS No.	# of Rows	Block Size	Wire Size	Trim Length	Fill Material	Qty
50091	3 x 7	7-1/2 x 1/2	.006	1/2	Stainless	12
50092	3 x 7	7-1/2 x 1/2	.006	1/2	Brass	12
50093	3 x 7	7-1/2 x 1/2	.012	1/2	Nylon	12

Hand Wire Scratch Brushes Assortment (Z02)

IBS No. 703R • 9 ITEMS • 45 PIECES

A
B
R
A
S
I
V
E
S





















IBS, Inc.

SPECIALTY PRODUCTS FOR MAINTENANCE & REPAIR
INDUSTRIALBOLT.COM © 2013 800-678-1906

Scratch Brushes

Assortment No. 703R

50088 4 X 16 SHOE HANDLE SCRATCH BRUSH 	
50089 4 X 16 SS SHOE HANDLE SCRATCH BRUSH 	
50090 4 X 18 BRASS SHOE HANDLE SCRATCH BRUSH 	
50091 3 X 7 SS SMALL SCRATCH BRUSH 	
50092 3 X 7 BRASS SMALL SCRATCH BRUSH 	
50093 3 X 7 NYLON SMALL SCRATCH BRUSH 	
44088 3/8 ACID BRUSH 	
44089 1/2 ACID BRUSH 	
44090 1/2 ACID BRUSH 	

IBS, INCORPORATED

Mounted Points P29



Mounted Points ALUMINUM OXIDE • VITRIFIED BONDED

These mounted points are versatile with a holding edge and stable form. They are ideal for use on carbon and heat-treated steel and cast steels. They are typically used in structured steel fabrications and die making foundries. All sizes feature a 1/4" shank.

IBS No.	Shape	Shape No.	Dimensions Dia. x Length	RPM	Grain Size	Qty
31001		A1	3/4 x 2-1/2	17,000	30	1
31011		A2	1 x 1-1/4	28,000	30	1
31021		A3	1 x 2-3/4	13,000	30	1
31031		A4	1-1/4 x 1-1/4	20,000	30	1
31061		A11	7/8 x 2	19,000	30	1
31071		A12	11/16 x 1-1/4	34,000	30	1
31104		A15	1/4 x 1-1/16	81,000	60	1
31111		A21	1 x 1	34,000	30	1
31144		A24	1/4 x 3/4	93,000	60	1
31161		A26	5/8 x 5/8	53,000	30	1
31201		A34	1-1/2 x 5/8	22,000	30	1
31234		A37	1-1/4 x 1/4	26,000	60	1



IBS No.	Shape No.	Dimensions	RPM	Grain Size	Qty
33710	W188	1/2 x 1-1/2	40,000	46	1
33725	W189	1/2 x 2	24,000	60	1
33812	W195	5/8 x 3/4	53,000	30	1
33968	W205	3/4 X 1	34,500	60	1
33992	W207	3/4 X 1-1/2	24,000	30	1
34187	W220	1 x 1	25,500	30	1
34217	W222	1 x 2	15,900	30	1
34352	W231	1-1/4 x 1-1/2	17,620	30	1
34457	W238	1-1/2 x 1-1/2	15,600	60	1
34517	W242	2 x 1	17,000	30	1

Stem-Mounted Extensions 6" & 12" (P29)



- **Available in 6" or 12" lengths** — for multiple applications to access hard to reach areas.
- **Quick Change Hex Shank** — allows for use in quick change chucks or in standard chucks giving a positive grip for safety and speed.
- **Double Set Screw** — holds the tool firmly in place ensuring no slippage or tool failure and provides added safety.
- **Forged of the finest quality tool steel** — for durability and long life.
- **Allen wrenches included.**

IBS No.	Description	Qty
139272	6" Stem Mounted Extension	1
139273	12" Stem Mounted Extension	1

A
B
R
A
S
I
V
E
S



IBS, INCORPORATED

Grinding Wheels P27

A
B
R
A
S
I
V
E
S

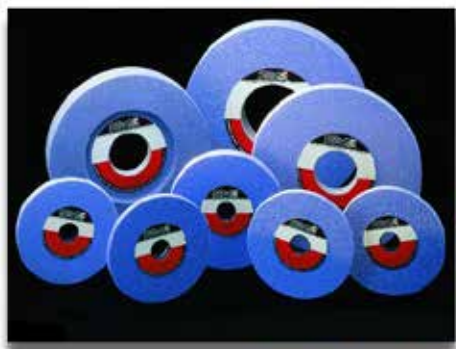

Premium Blue Aluminum Oxide Bench Grinding Wheels

HIGH SPEED STEEL APPLICATIONS

- Offers a friable grain and a cooler bond. Excellent on materials 55C and above, but can be used on general purpose tool steel.
- The bond allows free cutting action while pulling heat away from the part and into the matrix of the wheel.
- Recommended for grinding aluminum and stainless steels, as well as very hard steels.

QUICK GUIDE
CLEANING
GRINDING
DEBURRING
BLENDING
FINISHING
POLISHING

Use on
BENCH OR PEDESTAL
GRINDERS

for GRINDING &
DEBURRING

Guide to Grit Sizes

Aluminum Oxide

- 24 - 30 Rough
- 36 - 46 Gen Purpose Work
- 60 - 80 Finish Grinding

PREMIUM BLUE ALUMINUM OXIDE

Dimensions Dia. x Th. x Arb	Fine 120G	Medium 60G	Coarse 36G	MAX RPM
6 x 3/4 x 1	38116	38113	38111	4456
6 x 1 x 1	38126	38123	38121	4456
8 x 1 x 1	38206	38203	38201	3600

Bench Grinding Wheels Aluminum Oxide

GENERAL PURPOSE GRINDING AND FINISHING

- Wheels are individually precision balanced, trued and faced for smooth operation. All wheels are speed tested.
- All wheels come complete with nested bushings. Check the chart below for bushing size.
- Typical usage includes hand tool sharpening, minor deburring and touching up.



BENCH GRINDING WHEELS

Dimensions Dia. x Th. x Arb	Fine	Medium	Coarse	MAX RPM
6 x 3/4 x 1	69451	69450		4138
6 x 1 x 1	69455	69454	69453	4138
8 x 1 x 1-1/4	69463	69462	69461	3600
10 x 1 x 1-1/4	69467	69466	69465	2483

QUICK GUIDE
CLEANING
GRINDING
DEBURRING
BLENDING
FINISHING
POLISHING

Use on
BENCH OR PEDESTAL
GRINDERS

for GRINDING &
DEBURRING

BUSHING GUIDE

Wheel		Bushing				
Dia.	Hole	1/2	5/8	3/4	1	1-1/4
6"	1"	X	X	X		
7"	1"	X	X	X		
8"	1-1/4"		X	X	X	
10"	1-1/4"			X	X	
12"	1-1/2"				X	X
14"	1-1/2"				X	X



Flared Grinding Cupstones

HIGH PERFORMANCE TYPE 11



Designed with a large grinding surface, combined with a thick layer of rough abrasive, these cupstones remove more material than other wheels. Flared Grinding Cupstones are for use on right angle grinders for smoothing weld seams, cleaning castings and preparing surfaces for plating or painting.

- **Made with aluminum oxide grain** - ideal for rough grinding, snagging work and cleaning castings on metal, steel & stainless steel surfaces.
- **Larger grinding surface contact** than standard grinding wheels removes more material and last longer than standard grinding wheels.
- Applications: Weld grinding, surface grinding, edge grinding.

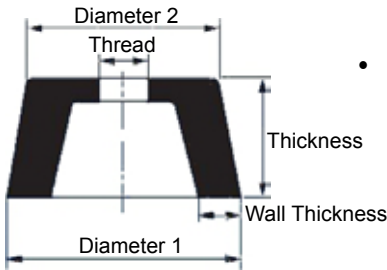

IBS No.	Diameter 1	Thickness	Diameter 2	Wall Thickness	Arbor	MAX RPM	Pkg
38130	4"	2"	3-1/2"	1"	5/8-11	9,072	1
38131	5"	2"	3-3/4"	1-1/2"	5/8-11	7,258	1
38132	6"	2"	4-3/4"	1-1/2"	5/8-11	6,084	1

QUICK GUIDE
CLEANING
GRINDING
DEBURRING
BLENDING
FINISHING
POLISHING

Use on
ANGLE GRINDERS



A
B
R
A
S
I
V
E
S



TYPE 18
Cone Cylinder



TYPE 18R
Cone Cylinder
Radius End

Grinding Cones

HIGH PERFORMANCE TYPE 18 & 18R

Used for grinding and finishing metals in hard to reach areas, these abrasive cones remove heavy amounts of material. Aluminum oxide grains in combination with a strong bond deliver long product life and a consistent cut-rate when grinding metal. They have a 5/8-11 threaded insert that attaches to the spindle on a grinder.

- **Made with aluminum oxide grain** for fast stock removal - ideal for grinding and snagging in hard to reach places.
- **Dual grit compound bonded to wheel's outer edge** maintains effective flat grinding edge.
- **Ideal shapes** for use in corners and inside castings.
- For use on straight grinders.
- Perform best at recommended peripheral speed of 6,900 - 9,800 SFPM.

Use on
ANGLE & STRAIGHT
GRINDERS



QUICK GUIDE
CLEANING
GRINDING
DEBURRING
BLENDING
FINISHING
POLISHING

Type 18	Type 18R	Diam	Length	Arbor	MAX RPM	Pkg
38133	38134	1-1/2"	2-1/2"	5/8-11	24,191	10
38135	38136	2"	3"	5/8-11	18,100	10



IBS, INCORPORATED

Grinding Wheels P27

DANGER

**Do Not Use Grinding Wheels Unless You Follow These Rules
Damaged or Improperly Used Wheels Can Cause Serious Injury**

Do Not Overspeed Wheel

DO's

1. **DO ALWAYS HANDLE AND STORE** wheels in a careful manner.
2. **DO VISUALLY INSPECT** all wheels before mounting, for possible damage in transit.
3. **DO CHECK MAXIMUM OPERATING SPEED** established for wheel against machine speed.
4. **DO CHECK MOUNTING FLANGES** for equal and correct diameter. (Should be at least 1/3 diameter of the wheel. Relieved around hole for type 1 only.
5. **DO USE MOUNTING BLOTTERS** supplied with wheels.
6. **DO BE SURE WORK REST** is properly adjusted. (Center of wheel or above: no more than 1/8" away from wheel).
7. **DO ALWAYS USE A GUARD** covering at least one half of the grinding wheel.
8. **DO ALLOW NEWLY MOUNTED WHEELS** to run at operating speed, with guard in place for at least one minute before grinding.
9. **DO ALWAYS WEAR SAFETY GLASSES** or some type of eye protection when grinding.
10. **DO TURN OFF COOLANT** before stopping wheel to avoid creating an out-of-balance condition.

DON'TS

1. **DON'T** use a wheel that **HAS BEEN DROPPED**.
2. **DON'T FORCE** a wheel on to the machine **OR ALTER** the size of the mounting hole — if the wheel won't fit the machine, get one that will.
3. **DON'T EVER EXCEED MAXIMUM OPERATING SPEED** established for the wheel.
4. **DON'T** use mounting flanges on which the bearing surfaces **ARE NOT CLEAN AND FLAT**.
5. **DON'T TIGHTEN** the mounting nut **EXCESSIVELY**.
6. **DON'T grind on the SIDE OF THE WHEEL** unless wheel is specifically designed for that purpose.
7. **DON'T start the machine UNTIL THE WHEEL GUARD IS IN PLACE**.
8. **DON'T JAM** work into the wheel.
9. **DON'T STAND DIRECTLY IN FRONT** of a grinding wheel whenever a grinder is started.
10. **DON'T grind material for which the WHEEL IS NOT DESIGNED**.

A
B
R
A
S
I
V
E
S

This page is designed as a guide for the individual user of grinding wheels whether he be in the employ of a large corporation or in the confines of his home work shop. It is based on the premise that the grinding is a safe operation when a few basic rules are followed. These rules are based on material contained in the American Standards Association Safety Code B7.1 — "Use, Care Protection of Abrasive Wheels." FOLLOW THEM



Applications

- Rough and medium grinding of welded seams in one grinding operation.
- Rust removal
- Deburring
- Working of fillet welds
- Edge grinding
- Snagging
- Surface grinding

Grit Recommendations

Grit Size	Materials
36	For aggressive grinding and weld removal.
60	For alloyed and low-alloyed steels, stainless steels of low tensile strength.
80	High-alloyed, stainless, high temperature heat-treatable steels, and high tensile non-ferrous steels.
120	Recommended for a fine finish of metal surfaces.

A coarser grit offers the advantage of a high stock removal rate and service life. A finer grit should only be used if a compromise is necessary for surface finish vs. stock removal rate.

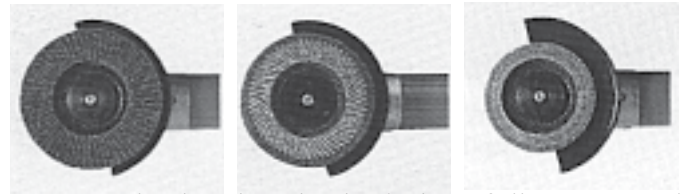

New Wheel The wheel grinds continuously as it wears A fully consumed POWER FLAP

IBS Power Flap Discs have a unique feature in that their glass fiber backing and abrasive material wear simultaneously during the grinding operations.

Therefore, the grinding efficiency is not impaired and the backing disc does not damage the surface of the work piece.

Quality and performance differences are not visible during short performance tests. The excellent performance features of the Power Flaps' extremely long service life and consistent high stock removal rate are only evident after long use and only after the flap disc has been consumed.

Optimum Results Using Flat and Conical Wheels

The choice between using a flat or conical wheel depends on the type of application:

The Flat IBS Power Flap wheel reaches its optimum efficiency at an angle of application between 0° - 15°.

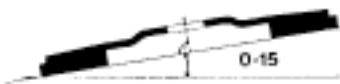

The Conical IBS Power Flap wheel offers advantages when grinding with steeper angles of 15° - 25°.

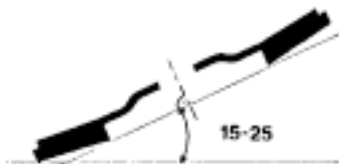

Points to note for good surface finish:

If a lower grinding angle is possible, the flat Power Flap wheel achieves better surface finish than the conical type with the same grit size.

When grinding stainless and high temperature steels these angles can be slightly exceeded if necessary.

A
B
R
A
S
I
V
E
S



IBS, INCORPORATED

Abrasives, Bench Rolls, Files P26

CLEAR-CUT Zirconium Power Flaps

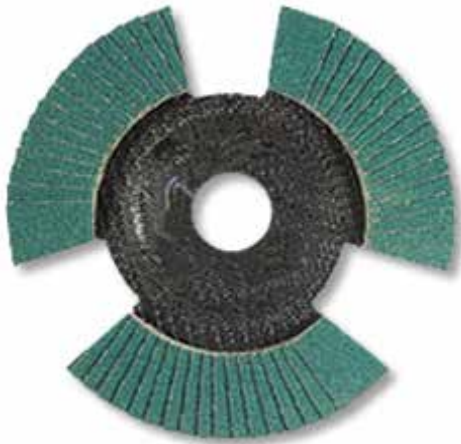

THREE UNIQUE RECESSES

Provide an unobstructed view of the workpiece and controlled material removal.



QUICK GUIDE
CLEANING
GRINDING
DEBURRING
BLENDING
FINISHING
POLISHING

Use on
ANGLE
GRINDERS



for GRINDING,
BLENDING &
FINISHING

CLEAR-CUT Zirconium Power Flaps

represent a truly unique concept in grinding technology — featuring a transparent operation. This allows the user to monitor the results without having to put the machine down. This makes stock removal and finishing easier to control — reducing costly processing errors.

- **3 Unique Cutouts/Recesses** give the user a free view of the workpiece during operation to monitor the progress and give a better finish in less time.
- **The cutouts also provide cool grinding** prevents disc loading that results in longer disc life and changeouts to reduce labor costs.
- **Cooler grinding** also prevents marring and discoloration of the work surfaces for an optimum finish.
- **Zirconium Grain** for high stock removal, faster grinding and longer life than aluminum oxide abrasives
- **Perfectly engineered and balanced flaps** for low vibration and noise means less user fatigue.

USE ON

- Rust & Acid proof steels
- High tensile sheets
- Structured steel
- Wood, varnish, filler
- GFK
- Hardox
- Tool Steel
- Non-ferrous Metals
- Plastics

APPLICATIONS

- Galvanized Parts
- Welding Seams
- Leveling
- Cleaning
- Surface grinding
- Flat Iron
- Bur removal
- Rust removal
- Edge grinding

IBS No.	Size	Grit	Qty
46660	4-1/2 x 7/8 Clear-Cut Zirc Disc	60	10
46680	4-1/2 x 7/8 Clear-Cut Zirc Disc	80	10

A
B
R
A
S
I
V
E
S



CURVE Ceramic Power Flaps



CURVE Ceramic Power Flaps are the ultimate tool for grinding fillet welds on steel and stainless steel work pieces. Because the flaps are wrapped right around the disc periphery CURVE Ceramic Power Flaps provide an unequalled quick and highly abrasive grind, saving time and money. They provide long service life, and consistent, easy-to-use performance while grinding. Experience drastic reduction in time to grind your fillet welds, and improved finish results!



- **Ceramic abrasive grit** handles demanding grind jobs and achieves fine surface finishes.
- Capable of handling all grinding tasks usually reserved for conventional flap discs, the **CURVE will grind on the edge and the top of the disc**, eliminating the need to rotate the workpiece or grind upside-down.
- **Works faster than grinding wheels** without the risk of undercutting the workpiece.
- **Ceramic grit guarantees cool grinding** on poor heat-conducting materials — without thermal damage to the workpiece.
- **Leaves a smooth finish** allowing for easy visual inspection for defects, such as porosity and inclusions.
- **Applications include:** fillet weld grinding, chamfering and deburring.
- For use on stainless steel, steel and aluminum.
- **Available in 60 grit.**

Size	RPM	60 Grit
4-1/2 x 7/8	13,300	40560
4-1/2 x 5/8-11	13,300	41560

QUICK GUIDE
CLEANING
GRINDING
DEBURRING
BLENDING
FINISHING
POLISHING

Use on
ANGLE GRINDERS



for **GRINDING, BLENDING & FINISHING**

A
B
R
A
S
I
V
E
S



IBS, INCORPORATED

Abrasives, Bench Rolls, Files P26

STRONG Zirconia Flap Discs



STRONG Zirconia Flap Discs remove more material in less time than any other abrasive for angle grinders. These discs feature an extended flap length for continued aggressive grinding up to the last grain while the patented design provides maximum metal-removal and longest tool life of any flap disc.

APPLICATIONS:

- Ideal for the most demanding applications, including: grinding weld seams, edge grinding, chamfering and deburring.
- Choose zirconia grit 36 for coarse grinding work or zirconia grit 50 for edge work like chamfering and deburring.

ZIRCONIA OXIDE ABRASIVE



FEATURES:

- Provides the fastest possible stock removal rates versus any other flap disc, including hi-density and ceramic grain.
- Extremely long tool life.
- State-of-the-art high speed abrasive grain ensures maximum aggressiveness.
- Engineered to maintain consistent, aggressive removal through the entire disc life.
- Reduces labor costs by reducing grinding times.
- Fewer tool changes required which reduces downtime and saves money.
- **Available in 36 and 50 grit.**



Size	RPM	36 Grit	50 Grit
4-1/2 x 7/8	13,300	42536	42550
4-1/2 x 5/8-11	13,300	43536	43550

QUICK GUIDE
CLEANING
GRINDING
DEBURRING
BLENDING
FINISHING
POLISHING

Use on
**ANGLE
GRINDERS**



for **GRINDING,
BLENDING &
CLEANING**

A
B
R
A
S
I
V
E
S



TYPE 29 TYPE 27

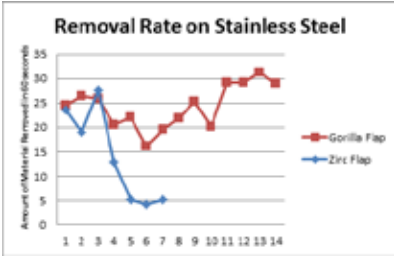

As the chart shows, Zirconium Flap Discs begin to fail on harder materials such as stainless steel after only the 3rd use while the Gorilla Flap Ceramic Disc continues to perform long after the Zirconium disc wears out.

QUICK GUIDE
CLEANING
GRINDING
DEBURRING
BLENDING
FINISHING
POLISHING

Use on
ANGLE
GRINDERS



IBS Gorilla Flap Ceramic Discs with Fiberglass Backing

- **High Performance Grinding Technology and Grain** results in **200% more stock removal** and **more than twice the life** than similar flap discs on hard materials, making this disc more effective, saving time and money.
- **Lower profile** allows this disc to fit under the safety guard for safer operation.
- The **advanced abrasive grain** makes it **50% more productive in stock removal rates** compared with reinforced grinding wheels — meaning less changeouts saving time and money for the user.
- The **combination** of extremely high **stock removal + long service life + lower profile** means **REDUCED labor, inventory and injury**.

TYPE 29 - (Conical)

Size	RPM	60 Grit	36 Grit	Qty
4-1/2 x 5/8-11	13,300	46860	46836	10
4-1/2 x 7/8	13,300	46760	46736	10
5 x 5/8-11	12,200	56860	56836	10
5 x 7/8	12,200	56760	56736	10

TYPE 27- (Flat)

Size	RPM	60 Grit	36 Grit	Qty
4-1/2 x 5/8-11	13,300	46360	46336	10
4-1/2 x 7/8	13,300	46260	46236	10
5 x 5/8-11	12,200	56360	56336	10
5 x 7/8	12,200	56260	56236	10



TYPE 27

Use on
ANGLE
GRINDERS



for GRINDING,
BLENDING &
FINISHING

QUICK GUIDE
CLEANING
GRINDING
DEBURRING
BLENDING
FINISHING
POLISHING

IBS Zipper Ceramic/Zirconia Trimmable Flap Discs

- **Constructed and manufactured in North America** with high quality, cloth abrasive material for superior quality and life.
- **Ceramic/Zirconia** alternating flap configuration provides cool cutting, high stock removal, long life and better finishes on stainless steel, titanium and all heat-treated steels.
- The **5/8-11 spin on threaded hub incorporated into the trimmable plastic backing results in a low profile design** that mounts securely under the grinder safety guard for added safety and user protection.

- **Plastic backing** is trimmable and also lighter weight than standard flap discs, making them easier to work with and better user ergonomics for more user comfort.
- **Trimmable backing** allows for more of the disc to be used for fewer disc changes and better production rates — lowering costs.

Size	RPM	120 Grit	80 Grit	60 Grit	36 Grit	Qty
4-1/2 x 7/8	13,300	36704	36703	36702	36701	10
4-1/2 x 5/8-11	13,300	36708	36707	36706	36705	10

A
B
R
A
S
I
V
E
S



IBS, INCORPORATED

Abrasives, Bench Rolls, Files P26

IBS Edge Flap Discs



Our **uniquely designed flap discs** are designed with a small backing plate, which exposes more of each flap without the need to trim the backing plate, creating a disc that is more effective on inside edges, corners, and hard-to-reach spaces and can be used to grind and blend corner weld beads and around stainless tank fittings without the backing getting in the way.

- A **smaller backing plate design** allows for **easier and more effective grinding into corners** for a more flexible and versatile flap disc for better finishes, **saving users time and money.**
- **Ceramic grain with added grinding aid** provides the fastest stock removal on harder metals like stainless steel — reduces time & saves money!

Size	RPM	80 Grit	60 Grit	40 Grit	Qty
4-1/2 x 7/8	13,300	42680	42660	42640	10
4-1/2 x 5/8-11	13,300	43680	43660	43640	10



TYPE 27

Use on
ANGLE
GRINDERS

QUICK GUIDE
CLEANING
GRINDING
DEBURRING
BLENDING
FINISHING
POLISHING



for GRINDING,
BLENDING &
FINISHING



A
B
R
A
S
I
V
E
S



THE TORNADO — Maximum Density Power Flap

Special zirconium composition abrasive for 45% more stock removal



- **Removes 45% more stock** than HD Power Flaps.
- **Superior performance to standard zirconium abrasives** for a more efficient and aggressive cut — reduces downtime.
- **Cooler running for minimal wear** means fewer wheel changeouts.
- **Maximum Density** — more abrasive material than HD Power Flaps for maximum life.
- **Most Economical** — longest life and a comparable price means fewer wheel changeouts reduced inventory and labor costs.



Use on
ANGLE
GRINDERS

QUICK GUIDE
CLEANING
GRINDING
DEBURRING
BLENDING
FINISHING
POLISHING



Size	RPM	80 Grit	60 Grit	40 Grit	Qty
4-1/2 x 7/8	13,300	46480	46460	46440	10
4-1/2 x 5/8-11	13,300	46580	46560	46540	10

IBS High Density Power Flaps

- **High density design is 60% thicker** than standard flap disc products.
- **Extended life** - fewer wheel change outs and reduced costs.
- **Hi-Alloy abrasive composition yields consistent performance** — new zirconium granules are continually exposed throughout the life of the product — eliminates rework and saves labor.
- **Faster cut & longer life than aluminum oxide abrasives** means fewer wheel change outs and reduced inventory costs.



Use on
ANGLE GRINDERS



QUICK GUIDE
CLEANING
GRINDING
DEBURRING
BLENDING
FINISHING
POLISHING



IBS POWER FLAP DISCS TYPE 27 — HIGH DENSITY

Size	RPM	120 Grit	80 Grit	60 Grit	40 Grit	Qty
4-1/2 x 7/8	13,300	—	40480	40460	40440	10
4-1/2 x 5/8-11	13,300	—	41480	41460	41440	10
7 x 5/8-11	8,600	—	41780	41760	41740	5

TYPE 29 — HIGH DENSITY

Size	RPM	120 Grit	80 Grit	60 Grit	40 Grit	Qty
4 x 5/8	13,300	—	47480		47440	10
4-1/2 x 7/8	13,300	—	42480	42460	42440	10
4-1/2 x 5/8-11	13,300	43499	43480	43460	43440	10
7 x 7/8	8,600	—	—		42740	5
7 x 5/8-11	8,600	—	—	43760	43740	5

A
B
R
A
S
I
V
E
S



IBS, INCORPORATED

Abrasives, Bench Rolls, Files P33



IBS SILVERBACK FLAP CERAMIC DISCS
with FIBERGLASS BACKING

TYPE 29 - (Conical)

Size	RPM	40G	60G	80G	120G	QTY
4-1/2 x 7/8	13,300	50008	50010	50012	50014	10
4-1/2 x 5/8-11	13,300	50009	50011	50013	50015	10



IBS SILVERBACK ROLOC FLAP DISCS

Size	RPM	40G	60G	80G	120G	QTY
2"	30,300	50016	50017	50018	50019	10
3"	19,100	50020	50021	50022	50023	10

IBS SilverBack Non-Loading Flap Discs

A Revolutionary Solution for
Grinding & Finishing
Aluminum and Soft Metals

- The open net structure of the SilverBack disc eliminates clogging and, therefore, lasts longer and cuts better than traditional flaps on softer materials such as aluminum and composites.
- The open net structure cuts cooler – minimizing the risk of overheating the sanded surface for a cleaner and smoother finish – reducing time and steps for finishing aluminum.
- Tough aluminum oxide grain bonded to the net material requires lower pressure and therefore reduces operator fatigue.
- The elimination of clogging and overheating means these discs last longer resulting in fewer discs needed to complete job – saving time and money.
- The combination of extremely high stock removal + long service life + lower profile means REDUCED labor, inventory and injury.

Silverback Non-Loading Roloc Discs Assortment (Z02)

IBS No. 821R • 10 ITEMS • 22 PIECES

PACKAGED IN A LOCKING STEEL DRAWER

<p>IBS, Inc. SPECIALTY PRODUCTS FOR MAINTENANCE & REPAIR INDUSTRIALBOLT.COM • 800-678-1906</p>		<p>SilverBack Roloc Disc</p>	
Assortment No. 821R			
<p>50016 2IN 40G ROLOC SILVERBACK FLAP DISC</p>	<p>50017 2IN 60G ROLOC SILVERBACK FLAP DISC</p>	<p>50018 2IN 80G ROLOC SILVERBACK FLAP DISC</p>	<p>50019 2IN 120G ROLOC SILVERBACK FLAP DISC</p>
<p>50020 3IN 40G ROLOC SILVERBACK FLAP DISC</p>	<p>50021 3IN 60G ROLOC SILVERBACK FLAP DISC</p>	<p>50022 3IN 80G ROLOC SILVERBACK FLAP DISC</p>	<p>50023 3IN 120G ROLOC SILVERBACK FLAP DISC</p>
<p>06525 2IN ROLOC BACKING PAD</p>	<p>06535 3IN ROLOC BACKING PAD</p>		

A
B
R
A
S
I
V
E
S



IBS Mini-Flaps



When it comes to labor-saving innovation, IBS leads the industrial marketplace once again with the IBS Mini Flap.

This premium Hi-Alloy product uniquely combines the power and versatility of Power Flap technology with the flexibility of Type 28 (conical) design in one durable disc. The IBS Mini Flap is the first of its kind and represents a significant advancement in grinding technology. These discs will grind and finish all in one operation like their Power Flap counterparts, with added flexibility for use in tough-to-grind corners and edges without gouging.

QUICK GUIDE
CLEANING
GRINDING
DEBURRING
BLENDING
FINISHING
POLISHING

2" & 3"
Use on Angle
AIR DIE GRINDERS



for GRINDING,
BLENDING &
FINISHING

Features & Benefits

- Simultaneously grind & finish in one application
- Consistent aggression throughout disc life
- Grinds cool, reducing bluing and burning of work surface.
- Overlapping flap construction virtually eliminates edge wear.
- Coarser grits provide for rapid stock removal.
- Small diameters permit access to confined & hard to reach areas.
- Interrupted flap surface reduces glazing and loading



Size	40 Grit	60 Grit	80 Grit	MAX RPM	Back Up Pad	Qty
2	65240	65260	65280	30,000	06525	10
3	65340	65360	65380	20,000	06535	10

Use IBS Back Up Pad No. 06530 3" 5/8-11 for Angle Grinders

3 x 5/8-11 for use with 4-1/2" Angle Grinder

A
B
R
A
S
I
V
E
S



IBS, INCORPORATED

Abrasives, Bench Rolls, Files P26

Ceramic Flex Flaps & Mini Flaps

- **Ceramic grain provides the fastest stock removal on harder metals like stainless steel and last longer** — making it a powerful alternative to zirconium and aluminum oxide — reduces time and saves money.
- **Flex Flap discs are ideal for blending and finishing on ferrous materials** where accessibility is a problem and the work area is curved or profiled —for better finishes saving users time and money.
- **Mini Flap Discs combine the power and versatility of a Power Flap disc in a compact design** for smaller areas for use with pneumatic die grinders — providing easier access in hard to reach areas.



CERAMIC ROLOC FLEX FLAPS

Size	80 Grit	60 Grit	40 Grit	MAX RPM	Qty
2"	67280	67260	67240	30,000	10
3"	67380	67360	67340	20,000	10

CERAMIC ROLOC MINI FLAPS

Size	80 Grit	60 Grit	40 Grit	MAX RPM	Qty
2"	64280	64260	64240	30,000	10
3"	64380	64360	64340	20,000	10

Ceramic Roloc Flex Flap & Mini Flap Discs (Z02)















IBS No. 841R • 14 ITEMS • 30 PIECES

PACKAGED IN A LOCKING STEEL DRAWER



Ceramic Roloc Flex Flap and Mini Flap Discs

Assortment No. 841R

<p style="font-size: x-small;">67340 3IN 40GRIT CERAMIC FLEX FLAP ROLOC</p> 	<p style="font-size: x-small;">67360 3IN 60GRIT CERAMIC FLEX FLAP ROLOC</p> 	<p style="font-size: x-small;">67380 3IN 80GRIT CERAMIC FLEX FLAP ROLOC</p> 	
<p style="font-size: x-small;">64340 3IN 40GRIT CERAMIC MINI FLAP ROLOC</p> 	<p style="font-size: x-small;">64360 3IN 60GRIT CERAMIC MINI FLAP ROLOC</p> 	<p style="font-size: x-small;">64380 3IN 80GRIT CERAMIC MINI FLAP ROLOC</p> 	
<p style="font-size: x-small;">67240 2IN 40GRIT CERAMIC FLEX FLAP ROLOC</p> 	<p style="font-size: x-small;">67260 2IN 60GRIT CERAMIC FLEX FLAP ROLOC</p> 	<p style="font-size: x-small;">67280 2IN 80GRIT CERAMIC FLEX FLAP ROLOC</p> 	<p style="font-size: x-small;">06535 3IN ROLOC BACKING PAD</p> 
<p style="font-size: x-small;">64240 2IN 40GRIT CERAMIC MINI FLAP ROLOC</p> 	<p style="font-size: x-small;">64260 2IN 60GRIT CERAMIC MINI FLAP ROLOC</p> 	<p style="font-size: x-small;">64280 2IN 80GRIT CERAMIC MINI FLAP ROLOC</p> 	<p style="font-size: x-small;">06525 2IN ROLOC BACKING PAD</p> 



A
B
R
A
S
I
V
E
S

Sanding Belts



A staple in many autobody and repair shops due to their effectiveness and versatility, these sanding belts are ideal for metalworking and light woodworking applications and are available in both Zirconia and Surface Conditioning materials.



ZIRCONIA+ SANDING BELTS

An ultra-tough, synthetic abrasive that provides a cool cut in high stock removal applications.

- **Micro-crystalline structure** allows for controlled breakdown and self-sharpening.
- **Tougher and sharper** than aluminum oxide.
- **Zirconia grain with added grinding aid** provides fast, cool cut and extended life in heavy duty grinding applications and harder metals like stainless steel - reduces time and saves money.
- **Ideal for fiberglass, rubber, plastics & mild steel** applications.



SURFACE CONDITIONING SANDING BELTS

Abrasive non-woven surface conditioning material used for sanding and finishing of all surfaces including wood and metal. Ideal for use in cleaning, finishing, blending and deburring applications.

- **Non-woven material** removes surface imperfections and grinding marks.
- **Use in place of coated sanding belts** — when a finer grit is needed.
- **Available in** coarse, medium and very fine

ZIRCONIA+ SANDING BELTS

Diameter	120 Grit	80 Grit	60 Grit	36 Grit	Pkg
1/2 x 18	35120	35080	35060	35036	10

SURFACE CONDITIONING SANDING BELTS

Diameter	Coarse	Medium	Very Fine	Pkg
1/2 x 18	35001	35002	35003	5

Sanding Belt Assortment (Z02)

IBS No. 848R • 7 ITEMS • 35 PIECES







PACKAGED IN A LOCKING STEEL DRAWER



IBS, Inc.
SPECIALTY PRODUCTS FOR MAINTENANCE & REPAIR
INDUSTRIALBOLT.COM • 800-678-1906

Sanding Belts
1/2 x 18

Assortment No. 848R

<p>35036 1/2 X 18 36G ZIRC+ SANDING BELT</p> 	
<p>35060 1/2 X 18 60G ZIRC+ SANDING BELT</p> 	
<p>35080 1/2 X 18 80G ZIRC+ SANDING BELT</p> 	<p>35120 1/2 X 18 120G ZIRC+ SANDING BELT</p> 
<p>35001 1/2 X 18 SURFACE CONDITIONING MATERIAL SANDING BELT COARSE</p> 	
<p>35002 1/2 X 18 SURFACE CONDITIONING MATERIAL SANDING BELT MEDIUM</p> 	
<p>35003 1/2 X 18 SURFACE CONDITIONING MATERIAL SANDING BELT VERY FINE</p> 	



A
B
R
A
S
I
V
E
S



IBS, INCORPORATED

Tools T03

3/4", 1/2", 3/8 & 1/4" Pneumatic Belt Sander Kit

IBS No. 69285

Pneumatic belt sander kit includes 5 interchangeable contact arms for ultimate versatility. Ideal for industrial and automotive deburring, sanding and finishing applications.



- **360° swing-position grip** adjusts to any required **angle for operator comfort and control.**
- **Belt guard** for added safety.
- **Easy belt and contact change** - No Tools Required.
- **Built-in air regulator** for positive speed control.
- **Compact and lightweight** design.
- **Contoured comfort grip** handle.
- **Contoured dead** handle.
- **Includes 1/4", two 3/8", 1/2" and 3/4"** interchangeable contact arms.
- **Rear exhaust with silencer for quiet operation** as well as 360° swivel air inlet for ease of use.
- Supplied with **two sanding belts** and **hex key wrench.**
- **Uses both abrasive and surface conditioning** type belts.

SPECS:

Belt Size in. (mm):	3/4 x 18, 1/2 x 18, 3/8 x 18, 1/4 x 18
Horse Power HP:	0.53
Free Speed RPM:	18,000
MAX Length in/mm:	15.38" (391mm)
Hose Size in/mm:	3/8 (9.5mm)
Air Cons cfm /cmm:	4.2 (0.12cmm)
Noise Level dB (A):	84
Weight lbs (kgs):	3 (1.36kgs)
Air Inlet (NPT):	1/4
Vibration Level m/s²	0.8

A
B
R
A
S
I
V
E
S

IBS, INCORPORATED

Abrasives P26



Flap Bands & Expanding Drums

A longer lasting, more productive alternative to flap wheels and spiral bands. Flap Bands provide aggressive stock removal in confined spaces and are excellent for grinding and finishing inside pipes and tubing.

- **Layered flaps are tightly packed** providing more productive aggressive stock removal than flap wheels.
- **Individual flaps wear back evenly, constantly exposing new sharp grains** which provides aggressive stock removal throughout the product life and reduces labor costs by removing material faster.
- **Flaps affixed to a firm fiber core** — giving greater durability than spiral bands.
- **No seams or splices to rip or tear** and surface imperfections which also protects and extends the life of the drum.

RUBBER EXPANDING DRUMS

Rubber drum remains in the tool collet for quick changeovers of bands.

To avoid slippage and for best performance, drums should be run at or near 75% of the max RPM for the Flap Bands (drill motors will not reach an adequate speed). This keeps the drums expanded to hold the Flap Bands securely and keep them from slipping on the drum.



QUICK GUIDE
CLEANING
GRINDING
DEBURRING
BLENDING
FINISHING
POLISHING

Use on
1/4" AIR DIE GRINDERS

for GRINDING,
BLENDING &
FINISHING

Diameter	80 Grit	60 Grit	40 Grit	MAX RPM	Qty	Use Drum	Drum Shank
1-1/4 x 3/4	51025	51024	51022	26,000	1	50950	1/4
1-3/4 x 1-3/16	51165	51164	51162	19,100	1	50954	1/4
2-1/2 x 1-3/16	51265	51264	51262	12,700	1	50956	1/4
3-1/2 x 1-3/16	51445	51444	51442	7,600	1	50960	5/16

Flap Band Assortments (Z08)

IBS No. 734R • 10 ITEMS • 16 PCS (INCLUDES DIE GRINDER)

IBS No. 733R • 9 ITEMS • 15 PIECES

Packaged in a locking steel drawer for easy storage & organization.

Flap Bands

Assortment No. 733R

<p style="font-size: x-small;">51022 1-1/4 X 3/4 FLAP BAND 40G</p>	<p style="font-size: x-small;">51162 1-3/4 X 1-3/16 FLAP BAND 40G</p>	<p style="font-size: x-small;">51262 2-1/2 X 1-3/16 FLAP BAND 40G</p>
<p style="font-size: x-small;">51024 1-1/4 X 3/4 FLAP BAND 60G</p>	<p style="font-size: x-small;">51164 1-3/4 X 1-3/16 FLAP BAND 60G</p>	<p style="font-size: x-small;">51264 2-1/2 X 1-3/16 FLAP BAND 60G</p>
<p style="font-size: x-small;">50950 1-1/4 X 3/4 FLAP BAND RUBBER EXPANDING DRUM</p>	<p style="font-size: x-small;">50954 1-3/4 X 1-3/16 FLAP BAND RUBBER EXPANDING DRUM</p>	<p style="font-size: x-small;">50956 2-1/2 X 1-3/16 FLAP BAND RUBBER EXPANDING DRUM</p>

ABRASIVES



IBS, INCORPORATED

Abrasives P30

Surface Conditioning Bands & Rubber Drums

Ideal for applying cosmetic grain finishes on Aluminum and Stainless Steel. Reduces surface roughness and uneven edges between adjoining surfaces. Conditions coated abrasive grind lines.

- **Versatile sizes** that can be used where belts cannot access.
- **Exhibits high finishing rate** while maintaining consistent finish which reduces finishing steps.
- **Unique shape** allows use on flat and contoured surfaces and hard-to-reach areas.
- **Constructed of resin-reinforced non-woven fiber** that resists loading and avoids under-cutting or gouging of the work piece.
- **Surface Conditioning Bands require** the use of Expanding Rubber Drums.
- **Ideal for deburring, cleaning, blending and finishing.**
- **Removes surface defects, rust, oxides, corrosion, paint and scale.**
- **Use on portable drills, die grinders, straight shaft and angle grinders.**



Expanding Rubber Drum

- Fabricated from rubber for controlled expansion and balance at high speeds.
- Band locks on non-slip drum.

Use on
1/4" AIR DIE
GRINDERS



for **CLEANING,
DEBURRING,
BLENDING &
FINISHING**

QUICK GUIDE
CLEANING
GRINDING
DEBURRING
BLENDING
FINISHING
POLISHING

Diameter	Coarse	Medium	Very Fine	MAX RPM	Qty	Use Drum
1/2 x 1/2	51029	51030	51031	30,000	1	51032
1 x 1	51034	51035	51036	18,000	1	51037
1-1/2 x 1	51039	51040	51041	10,000	1	51042

NOTE: The maximum allowable RPM for Surface Conditioning Bands is the same as the maximum RPM of the expanding rubber sanding drum used to drive the band, provided the drum and the band have the same nominal diameter. **CAUTION:** Protect yourself from product breakage and flying particles. Always wear eye and face protection, and make sure machine guards are in place. Comply with **ANSI B7.1**.

Surface Conditioning Bands Assortment (Z02)

IBS No. 774R • 12 ITEMS • 27 Pcs

Packaged in a locking steel drawer for easy storage & organization.

Surface Conditioning Bands

Assortment No. 774R

<p>51029 1/2 X 1/2 SURFACE CONDITIONING BAND COARSE</p>	<p>51034 1 X 1 SURFACE CONDITIONING BAND COARSE</p>	<p>51039 1-1/2 X 1 SURFACE CONDITIONING BAND COARSE</p>
<p>51030 1/2 X 1/2 SURFACE CONDITIONING BAND MEDIUM</p>	<p>51035 1 X 1 SURFACE CONDITIONING BAND MEDIUM</p>	<p>51040 1-1/2 X 1 SURFACE CONDITIONING BAND MEDIUM</p>
<p>51031 1/2 X 1/2 SURFACE CONDITIONING BAND VERY FINE</p>	<p>51036 1 X 1 SURFACE CONDITIONING BAND VERY FINE</p>	<p>51041 1-1/2 X 1 SURFACE CONDITIONING BAND VERY FINE</p>
<p>51032 1/2 X 1/2 SURFACE CONDITIONING BAND DRUM</p>	<p>51037 1 X 1 SURFACE CONDITIONING BAND DRUM</p>	<p>51042 1-1/2 X 1 SURFACE CONDITIONING BAND DRUM</p>

A
B
R
A
S
I
V
E
S

IBS, INCORPORATED

Abrasives P30



Flap Wheels

Industrial Grade — Aluminum Oxide Mounted

- **Non-loading.** The flexibility provided by the coated abrasive flaps prevents loading which occurs with non-flexible grinding products.
- **Hugs concave or convex surfaces** allowing access to hard to reach areas such as small diameter tubing, channels, recessed areas, small openings, etc.
- **Mandrel mounted** on fixed 1/4" solid shank.
- **Full pack grit**, resin bonded segments.
- **Removes work marks** and surface imperfections.
- **Polishes** die work, spot welds, fiberglass molds.
- **Deburr**s stainless steel; blends and polishes.



QUICK GUIDE
CLEANING
GRINDING
DEBURRING
BLENDING
FINISHING
POLISHING

Use on
1/4" AIR DIE
GRINDERS



for GRINDING,
BLENDING &
FINISHING

Diameter	Shank	240 Grit	120 Grit	80 Grit	60 Grit	40 Grit	MAX RPM	Qty
3/4 x 3/4	1/4	65057	65056	65055	65054	65053	25,000	1
1 x 1	1/4	65028	65029	65025	65021	65023	25,000	1
1-1/2 x 1	1/4		65036	65034	65030	65032	25,000	1
2 x 1	1/4	65048	65044	65042	65038	65037	25,000	1
3 x 1	1/4		65052	65050	65046	65045	25,000	1



USE WITH STEM MOUNTED EXTENSIONS

IBS No.	Description	Qty
139272	6" Stem Mounted Extension	1
139273	12" Stem Mounted Extension	1

Flap Wheels Assortment (Z08)

IBS No. 398R • 20 ITEMS • 32 Pcs PACKAGED IN A LOCKING STEEL DRAWER



Flap Wheels



Assortment No. 398R				
65056 3/4 X 3/4 120G FLAP WHEEL	65029 1 X 1 120G FLAP WHEEL	65036 1-1/2 X 1 120G FLAP WHEEL	65044 2 X 1 120G FLAP WHEEL	65052 3 X 1 120G FLAP WHEEL
65055 3/4 X 3/4 80G FLAP WHEEL	65025 1 X 1 80G FLAP WHEEL	65034 1-1/2 X 1 80G FLAP WHEEL	65042 2 X 1 80G FLAP WHEEL	65050 3 X 1 80G FLAP WHEEL
65054 3/4 X 3/4 60G FLAP WHEEL	65021 1 X 1 60G FLAP WHEEL	65030 1-1/2 X 1 60G FLAP WHEEL	65038 2 X 1 60G FLAP WHEEL	65046 3 X 1 60G FLAP WHEEL
65053 3/4 X 3/4 40G FLAP WHEEL	65023 1 X 1 40G FLAP WHEEL	65032 1-1/2 X 1 40G FLAP WHEEL	65037 2 X 1 40G FLAP WHEEL	65045 3 X 1 40G FLAP WHEEL



IBS, INCORPORATED

Abrasives P26

Pressure Sensitive Adhesive (PSA) Premium Gold Abrasive Discs

PSA Premium Gold Abrasive Discs are used on portable disc sanders, ideal for sanding paint, primer, metal, wood, fiberglass, plastic and more.

- **Adhesive backed**, for convenient attaching to a backing pad, with quick replacement and ease of use saves users time and money.
- **Semi-open and load-resistant coating** provides an aggressive cutting action with minimal loading for longer life which means less change-outs, saving time and money.
- **Premium paper backing** is more durable than standard discs — resists tearing for added durability and value, saving time and money.
- **Packaged in roll form**, 100 per roll, for convenient use and easy dispensing.



Use on
ORBITAL SANDERS



for **CLEANING
& FINISHING**

IBS No.	Size	Grit	Pkg Qty
40600	6" PSA Premium Gold Abrasive Discs	80G	100
40602		120G	100
40604		180G	100
40605		220G	100
40606		320G	100
40610		Backing Pad for PSA Premium Gold Abrasive Discs	

SEMI-FLEX (P32) Silicon Carbide Discs

These discs combine the product advantages of various abrasives in one application.

- Engineered to be flexible, these discs adjust to the work surface and have a comfortable grinding behavior for excellent performance.
- Spiral design allows the disc to run cooler.
- Silicone Carbide grain prevents loading, increases production and is aggressive on rough surfaces.
- Applications include: Non-ferrous metals • Concrete • Marble • Fiberglass • Enamels • Porcelain



Use on
ANGLE GRINDERS



for **GRINDING,
BLENDING &
FINISHING**

Silicon Carbide	36 Grit	16 Grit	RPM	Qty
4-1/2 x 7/8	46725	46724	12,000	10

QUICK GUIDE

CLEANING
GRINDING
DEBURRING
BLENDING
FINISHING
POLISHING

QUICK GUIDE

CLEANING
GRINDING
DEBURRING
BLENDING
FINISHING
POLISHING



GORILLA-GRIND Rough Grinding Discs

HIGH PERFORMANCE COATED ABRASIVES FOR STEEL & STAINLESS STEEL



The Gorilla Grind Grinding Disc is more aggressive than reinforced grinding wheels. The innovative design provides a quieter, smoother and cleaner operation meaning increased productivity. The Gorilla Grind also runs smoother and quieter than standard grinding wheels giving the operator a safer, cleaner and more comfortable grinding experience.

The Gorilla Grind outperforms similar products in speed and life. Gorilla Grind removes material up to 20% faster than other brands, and the Gorilla Grind Disc lasts up to 30% longer!

- **High Performance Grinding Technology and Grain** results in 20% more stock removal and 30% longer life than similar grinding discs making this disc more effective saving time and money.
- The innovative **shape and rigidity of the wheel** combined with the advanced abrasive grain makes it 50% more productive in stock removal rates compared with reinforced grinding wheels – meaning less change-outs – saving time and money for the user.
- The **innovative shape and rigidity** allows user to put more direct contact with the work surface resulting in 50% less noise and vibration compared to standard grinding wheels which means less user fatigue and more productivity.
- **Less bonding material and more direct abrasive grain** results in 80% less dust produced compared to reinforced grinding wheels – for a cleaner and safer working area.
- Easy handling with **large surface contact area** means a more uniform surface finish with drastically reduced risk of gouging the surface.
- The combination of **extremely high stock removal rate + long service life + high user comfort** means REDUCED labor, inventory, injury and fatigue.

A
B
R
A
S
I
V
E
S

Removal Rate on Stainless Steel

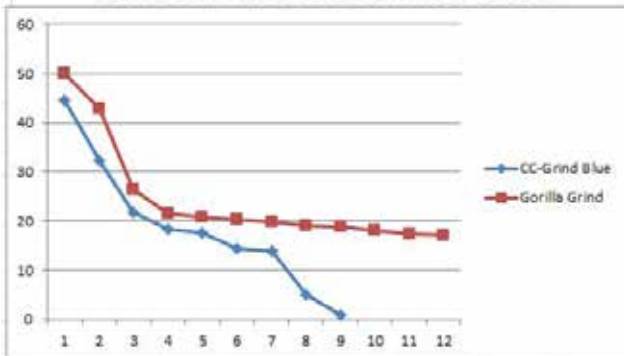

Use on
ANGLE GRINDERS



QUICK GUIDE
CLEANING
GRINDING
DEBURRING
BLENDING
FINISHING
POLISHING

IBS No.	Description	MAX RPM	Qty
41551	4-1/2 X 5/8-11 Gorilla Grind Disc	13,300	10
41552	4-1/2 X 7/8 Gorilla Grind Disc	13,300	10
41553	6 X 5/8-11 Gorilla Grind Disc	10,200	10
41554	6 x 7/8 Gorilla Grind Disc	10,200	10

APPLICATIONS

- Surface grinding
- Weld removal
- Deburring/edge grinding
- Machining cutting torch burrs



IBS, INCORPORATED

Abrasives P26

CC-GRIND-SOLID Rough Grinding Discs

HIGH PERFORMANCE COATED ABRASIVES FOR STEEL & STAINLESS STEEL

The **CC-Grind-Solid** is **100% (or 2x) more aggressive** than a grinding wheel – which reduces labor time, increases productivity, and gives the operator a quiet, safe, comfortable and cleaner grinding experience.

- **40% more productivity** due to ultimate stock removal rates compared with reinforced grinding wheels.
- **50% less noise and vibration** means less user fatigue.
- **80% less dust** produced compared to reinforced grinding wheels – for a cleaner and safer working area.
- Easy handling with **large surface contact area** means a more uniform surface finish with drastically reduced risk of gouging the surface.
- Innovative **high-strength layer structure** of the fiberglass backer with the high-performance coated abrasive means no expensive back-up pad, faster tool changes and a thicker wheel for longer life!
- The combination of **extremely high stock removal rate + long service life + high user comfort** means REDUCED labor, inventory, injury and fatigue.

CC-GRIND-SOLID is ideal for the following jobs:

- Surface grinding
- Weld removal
- Chamfering
- Deburring/edge grinding
- Machining cutting torch burrs



CC GRIND SOLID FOR STEEL provides extremely high removal rate combined with long service life and high user comfort.



CC GRIND SOLID FOR STAINLESS STEEL Ideal on stainless steel (INOX) and alloys, provides high, cool stock removal with low grinding pressure.

A
B
R
A
S
I
V
E
S

QUICK GUIDE
CLEANING
GRINDING
DEBURRING
BLENDING
FINISHING
POLISHING

Use on
ANGLE GRINDERS



for **CLEANING & GRINDING**

Dimensions (Dia. x Arbor)	Steel	Stainless	MAX RPM	Qty
4-1/2 x 7/8	40550	40555	13,300	10
4-1/2 x 5/8-11	41550	41555	13,300	10
7 x 7/8	40750	40755	8,500	5
7 x 5/8-11	41750	41755	8,500	5

Close up of the layer structure



High-strength disc design for ergonomic, safe work.

Rough grinding & weld removal



Excels on rough grinding applications.

Available with quick change hub



Quick and easy wheel change-outs.



CC-GRIND-STRONG Rough Grinding Discs

HIGH PERFORMANCE COATED ABRASIVES FOR STEEL & STAINLESS STEEL

The **CC-Grind-STRONG** is the stepping stone between the classic grinding wheel (the backing pad also grinds) and the modern alternative CC-GRIND® SOLID (fast, ergonomic grinding). It's patented design features a unique, multi-layered design with three coated discs stacked on a 1/8" resin-bonded abrasive backer, which not only serves as a supporting backing, but is also used during grinding.

- **Stacked coated discs** with a bonded abrasive support provides three times the service life compared to **CC-GRIND® - SOLID STEEL** - longer life plus reduced wheel changeouts saves time and money.
- The **highly aggressive abrasive material** results in maximum material removal for efficient productivity, saving users time and money.
- **Patented design** of the stacked discs means a wheel that is significantly more ergonomic than a conventional grinding wheel, reducing noise and vibrations by 50% and dust by 70%.
- The **layered abrasives** provide a superior surface finish compared to conventional grinding wheels because of the reduced vibration and ease of handling, saving finishing time.

CC-GRIND-STRONG is ideal for:

- Surface grinding
- Weld removal
- Chamfering
- Deburring/edge grinding
- Machining cutting torch burrs

QUICK GUIDE
CLEANING
GRINDING
DEBURRING
BLENDING
FINISHING
POLISHING

Use on
ANGLE GRINDERS



for **CLEANING & GRINDING**



IBS No.	Dimensions (Dia. x Arbor)	MAX RPM	Qty
42350	4-1/2 x 7/8	13,300	10
43350	4-1/2 x 5/8-11	13,300	10

A
B
R
A
S
I
V
E
S



IBS, INCORPORATED

Abrasives P30

Double Sided Abrasive Discs WITH VISI-COOL

These double sided discs allow the user to grind and finish without having to move a large work-piece or grind from an uncomfortable position.

- **Abrasive on both sides** allows the operator to safely grind with both surfaces without changing position or direction, saving time on disc changeouts ultimately saving time and money.
- **Lightweight design and elimination of backing** allows easy control and less operator fatigue for maximum productivity.
- **Thin design** allows access into hard to reach areas like inside channels, tracks and the underside of surfaces for a versatile disc for a variety of applications, saving inventory costs.
- **VISI-COOL openings** allow the operator to see the work surface, while dissipating heat and minimizing the risk of discoloration for maximum life and ease of use.
- Available in **3 different grits** — 40/60/80 for a wide range of applications.
- **Easy-to-use adapter** makes disc mounting simple and changeovers fast and easy — Requires no backing pad, and discs can be changed by hand, saving time and money!



IBS No.	Dimensions Dia. x Arbor	Grit	MAX RPM	Pkg Qty
47540	4-1/2 x 5/8-11	40	13,300	10
47560	4-1/2 x 5/8-11	60	13,300	10
47580	4-1/2 x 5/8-11	80	13,300	10
47590	Adapter for Double Sided Abrasive Disc			1



Stainless Steel adapter for simple tool free disc mounting and changeovers. Includes two spacers to fit common spindle lengths.



A
B
R
A
S
I
V
E
S



Resin Fibre Discs for Right Angle Grinders

One of the most popular coated abrasive products used in the industry, these resin fibre discs are constructed with a heavy vulcanized fibre back and coated with abrasive grains and bonded with a tough, heat-resistant resin.

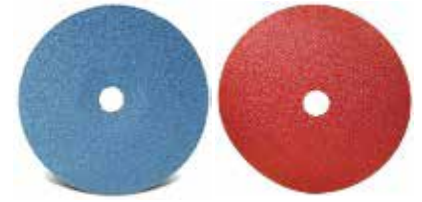

ZIRCONIUM

CERAMIC

- Each specific disc type has features and benefits unique to the particular application for which it was designed.
- Electrostatic coating process orients the sharpest cutting edge of the grain upward and allows for uniform grain coverage, providing for maximum aggression.
- Individually coated. This process assures consistent grain dispersion to the outermost edge and most important cutting area of the disc.
- Completely sealed (front and back) to maintain the moisture content of the fibre, significantly extending shelf life under extreme challenges of atmospheric conditions.
- Pre-shaped to maintain proper assembly relationship between the disc and back-up pad.

QUICK GUIDE
CLEANING
GRINDING
DEBURRING
BLENDING
FINISHING
POLISHING

Use on
ANGLE GRINDERS



for GRINDING,
BLENDING &
FINISHING

Zirconium	80 Grit	60 Grit	36 Grit	24 Grit	Qty
4-1/2 x 7/8	66480	66460	66436	66424	25
5 x 7/8	66580	66560	66536	66524	25
Ceramic Grain	80 Grit	60 Grit	36 Grit	24 Grit	Qty
4-1/2 x 7/8	67480	67460	67436	67424	25
5 x 7/8	67580	67560	67536	67524	25

Zirconium

- Excellent performance on stainless steel. Recommended for heavy weld & metal grinding.
- High performance disc with a fast cut rate.
- Tough self-sharpening grain.
- Cool grinding action reduces glazing and loading.

Ceramic Grain

- For superior grinding and finishing on all types of carbon steel.
- Twice the life, and three to four times the performance of similar aluminum oxide discs.
- This revolutionary grain, the latest generation of synthetic metal cutting minerals, was developed for the most demanding grinding and finishing applications.
- Very high rate of cut and extended life expectancy.
- Shelf-sharpening grain ensures consistent performance during the entire life of the disc.

Back-Up Pads for Resin Fibre Discs (P31)



Back-Up Pads support the disc and properly distribute the grinding pressure to the workpiece. For best disc cutting performance and durability, it is important that the appropriate back-up pad be selected. Pad nuts are included with Back-Up Pads (5/8-11" thread for all standard spindles.)

Features / Benefits

- Provides disc support; distributes proper grinding pressure to the workpiece.
- Mounting systems designed for easy, fast disc change.
- Shift clutch action assures operator safety if a pad jams during operation.
- Adjustable wrench adapts to all variations of back-up pad threaded nuts.

Size	Thread	IBS No.	RPM
4-1/2	5/8-11	64404	13,000
5	5/8-11	64405	13,000
ADJ Wrench		64411	

A
B
R
A
S
I
V
E
S



IBS, INCORPORATED

Abrasives P30

Solid Mini Roloc Quick Change Grinding Discs

Our **Solid Mini Grinding Discs** use a **Type R plastic roll on lock design** as its base.

- **Grain is fused directly to a tough polymer backing for a stronger, firmer, more versatile grinding disc** that can be used wet or with coolants. These discs can even be easily cleaned, extending the life and usability of the disc.
- **One piece design eliminates the risk of the disc detaching** from the traditional roloc knob for a safer operation.
- **Plastic backing and one piece design allows for the disc to be trimmed** as it wears, to renew the cutting surface and reduce the diameter.
- **Coated with specially processed grit engineered for toughness, sharpness and bond** in Ceramic Plus Grinding Aid and in Zirconia Plus Grinding Aid in 2" & 3" diameters.

A B R A S I V E S CERAMIC+ SOLID MINI ROLOC CERAMIC+ GRINDING DISCS

Innovative Ceramic Resin Fibre Disc **for industrial metal applications**. Provides ultimate grinding performance using new 100% SG Ceramic grain with top coat. Developed especially for use on stainless steel and other alloys for maximum performance.

- A special TOP COAT is applied, combining a grinding and a cooling aid which helps resist loading and aids in cooling, resulting in longer life and less marring and discoloration, making the disc more effective, saving time and money.
- 100% ceramic grain provides long lasting life on stainless steel, carbon steel, and high Nickel and Alloy metals.

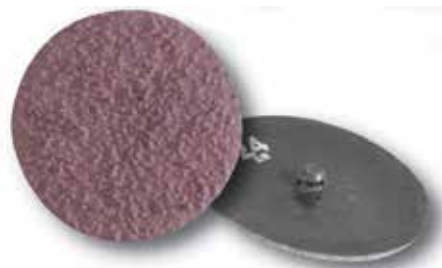

SOLID MINI ROLOC CERAMIC+ QUICK CHANGE GRINDING DISCS

Ceramic+	120 Grit	80 Grit	60 Grit	36 Grit	Qty
2"	36605	36603	36602	36600	10
3"	36612	36610	36609	36607	10

S ZIRCONIA+ SOLID MINI ROLOC ZIRC+ GRINDING DISCS

- A special TOP COAT is applied, combining a grinding and cooling aid which helps resist loading and aid in cooling, resulting in a longer life and less marring and discoloration, making the disc more effective, saving time and money.
- 100% zirconia grain provides long lasting life on hard materials and tough grinding applications with very high stock removal which saves time and money.

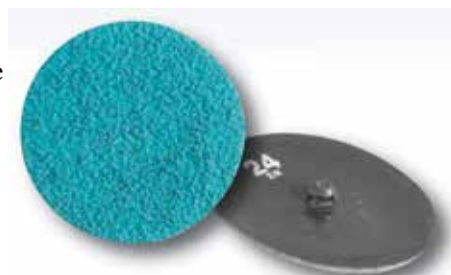

SOLID MINI ROLOC ZIRC+ QUICK CHANGE GRINDING DISCS

Zirconium+	120 Grit	80 Grit	60 Grit	36 Grit	Qty
2"	36625	36623	36622	36620	10
3"	36632	36630	36629	36627	10

IBS, INCORPORATED

Assortments Z02



Solid Mini Roloc Ceramic+ Grinding Discs

IBS No. 827R • 10 ITEMS • 42 Pcs



PACKAGED IN A LOCKING STEEL DRAWER FOR EASY STORAGE & ORGANIZATION

		Solid Roloc Ceramic+ Grinding Discs	
Assortment No. 827R			
<p>36600 2IN 36G SOLID ROLOC CERAMIC+ GRINDING DISC</p> 	<p>36602 2IN 60G SOLID ROLOC CERAMIC+ GRINDING DISC</p> 	<p>36603 2IN 80G SOLID ROLOC CERAMIC+ GRINDING DISC</p> 	<p>36605 2IN 120G SOLID ROLOC CERAMIC+ GRINDING DISC</p> 
<p>36607 3IN 36G SOLID ROLOC CERAMIC+ GRINDING DISC</p> 	<p>36609 3IN 60G SOLID ROLOC CERAMIC+ GRINDING DISC</p> 	<p>36610 3IN 80G SOLID ROLOC CERAMIC+ GRINDING DISC</p> 	<p>36612 3IN 120G SOLID ROLOC CERAMIC+ GRINDING DISC</p> 
<p>06525 2IN ROLOC BACKING PAD</p> 	<p>06535 3IN ROLOC BACKING PAD</p> 		

Solid Mini Roloc Zirc+ Grinding Discs

IBS No. 828R • 10 ITEMS • 42 Pcs

PACKAGED IN A LOCKING STEEL DRAWER FOR EASY STORAGE & ORGANIZATION

		Solid Roloc Zirconia+ Grinding Discs	
Assortment No. 828R			
<p>36620 2IN 36G SOLID ROLOC ZIRC+ GRINDING DISC</p> 	<p>36622 2IN 60G SOLID ROLOC ZIRC+ GRINDING DISC</p> 	<p>36623 2IN 80G SOLID ROLOC ZIRC+ GRINDING DISC</p> 	<p>36625 2IN 120G SOLID ROLOC ZIRC+ GRINDING DISC</p> 
<p>36627 3IN 36G SOLID ROLOC ZIRC+ GRINDING DISC</p> 	<p>36629 3IN 60G SOLID ROLOC ZIRC+ GRINDING DISC</p> 	<p>36630 3IN 80G SOLID ROLOC ZIRC+ GRINDING DISC</p> 	<p>36632 3IN 120G SOLID ROLOC ZIRC+ GRINDING DISC</p> 
<p>06525 2IN ROLOC BACKING PAD</p> 	<p>06535 3IN ROLOC BACKING PAD</p> 		

A
B
R
A
S
I
V
E
S



IBS, INCORPORATED

Abrasives P30

A
B
R
A
S
I
V
E
S

Quick Change Grinding Discs

Hi-Alloy Zirconium Grinding Discs

- Superior Grain resharpens itself during grinding.
- Fast, aggressive cutting action that resists loading.
- Suitable for hard materials and tough grinding applications.
- Uses the same disc holders as the surface conditioning discs to change from grinding to conditioning in seconds.



QUICK GUIDE
CLEANING
GRINDING
DEBURRING
BLENDING
FINISHING
POLISHING

Use on
Angle
AIR DIE GRINDERS



for GRINDING,
BLENDING &
FINISHING

Size	120G	80G	60G	36G	Qty
2	09425	09420	09415	09410	10

Use IBS Back Up Pad No. 06525 with 2"

3	09445	09440	09435	09430	10
---	-------	-------	-------	-------	----

Use IBS Back Up Pad No. 06535 with 3"
Use IBS Back Up Pad No. 06530
Use Back Up Pad 3" 5/8-11 for Angle Grinders

4	—	09480	09460	09436	5
---	---	-------	-------	-------	---

Use IBS Back Up Pad No. 06545 with 4"

Zirconium Plus Grinding Aid:

With Grinding Aid for use on High Temperature Alloys, Titanium, & Stainless Steel.

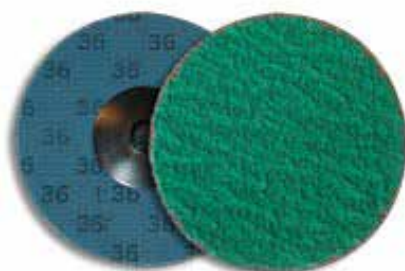

MINI ROLOC GRINDING DISCS ZIRCONIUM PLUS GRINDING AID

Size	120G	80G	60G	36G	Qty
2	36688	36687	36686	36683	10

Use IBS Back Up Pad No. 06525 with 2"

3	36700	36699	36698	36695	10
---	-------	-------	-------	-------	----

Use IBS Back Up Pad No. 06535 with 3"
Use IBS Back Up Pad No. 06530
Use Back Up Pad 3" 5/8-11 for Angle Grinders

Ceramic Grain:

Ceramic Alumina with grinding aid exposes sharp cutting points that yields a faster and cooler cutting action. Ferrous, Non-Ferrous, Carbon Steel and Exotic Alloys.



QUICK GUIDE
CLEANING
GRINDING
DEBURRING
BLENDING
FINISHING
POLISHING

Use on
Angle
AIR DIE GRINDERS

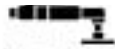

for GRINDING,
BLENDING &
FINISHING

Size	120G	80G	60G	36G	Qty
2	40334	40333	40332	40329	10

Use IBS Back Up Pad No. 06525 with 2"

3	40340	40339	40338	40335	10
---	-------	-------	-------	-------	----

Use IBS Back Up Pad No. 06535 with 3"
Use IBS Back Up Pad No. 06530
Use Back Up Pad 3" 5/8-11 for Angle Grinders

IBS, INCORPORATED

Assortments Z02























3" Roloc Grinding Discs

IBS No. 548P • 10 ITEMS • 91 PIECES WITHOUT DIE GRINDER
 PACKAGED IN A LOCKING STEEL DRAWER FOR EASY STORAGE & ORGANIZATION



3" Roloc Grinding Discs

Assortment No. 548P

<p style="font-size: x-small;">09440 3 80G ROLOC ZIRC DISC*</p>  	<p style="font-size: x-small;">36699 3 80G ROLOC ZIRC+ GRINDING*</p>  	<p style="font-size: x-small;">40339 3 80G ROLOC CERAMIC GRAIN*</p>  	
<p style="font-size: x-small;">09435 3 60G ROLOC ZIRC DISC*</p>  	<p style="font-size: x-small;">36698 3 60G ROLOC ZIRC+ GRINDING*</p>  	<p style="font-size: x-small;">40338 3 60G ROLOC CERAMIC GRAIN*</p>  	
<p style="font-size: x-small;">09430 3 36G ROLOC ZIRC DISC*</p>  	<p style="font-size: x-small;">36695 3 36G ROLOC ZIRC+ GRINDING*</p>  	<p style="font-size: x-small;">40335 3 36G ROLOC CERAMIC GRAIN*</p>  	<p style="font-size: x-small;">06535 3 ROLOC BACKING PAD*</p>  



Grinder NOT for use with cut-off wheels over 3" in diameter. Refer to ASTM B7.1-2001

A
B
R
A
S
I
V
E
S



IBS, INCORPORATED

Abrasives P30

A
B
R
A
S
I
V
E
S

Trim-Kut® Discs

A revolutionary abrasive disc designed to grind and finish a wide variety of materials faster and cooler than any other abrasive disc available today. The patented process of fusing premium abrasive grains to a durable polymer backing results in a highly versatile grinding tool that requires no backing pad.

Trim-Kut® Discs are readily trimable to either renew the cutting surface, or reduce the diameter.



QUICK GUIDE
CLEANING
GRINDING
DEBURRING
BLENDING
FINISHING
POLISHING

Use on
1/4" 90° Angle
AIR DIE GRINDERS

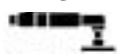

for GRINDING,
BLENDING &
FINISHING

Size	Description	Green 120G	Orange 60G	Red 36G	RPM	Qty
3" 80mm	Mid-Alloy	69399	69360	69336	28,000	25

Each package (25) contains 1 (one) Mandrel
TRIM-KUT Discs use IBS Mandrel No. 69325
Any quantity less than 25, Mandrel is sold separately



Trim-Kut® Discs Assortment (Z08)

IBS No. 537P • 4 ITEMS • 76 PIECES

PACKAGED IN A LOCKING STEEL DRAWER

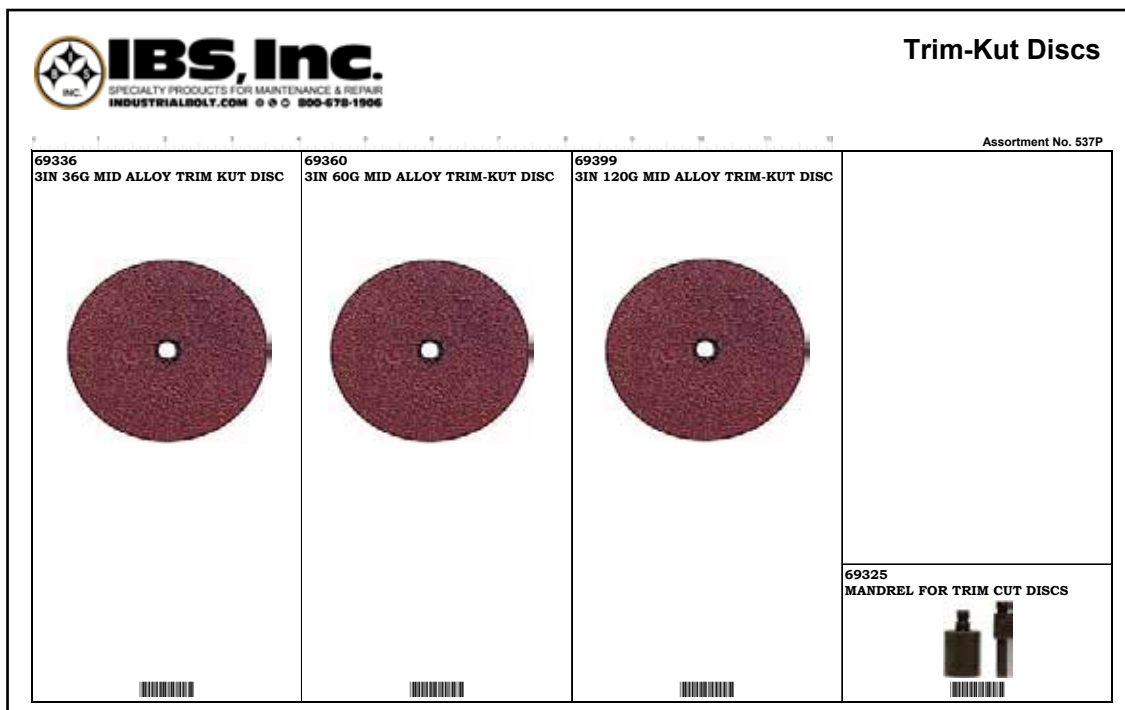



Trim-Kut® Depressed Center Surface Conditioning Discs

Trim-Kut Depressed Center Surface Conditioning Discs are non-woven material mounted on a stiff, solid backing that produces a firm, yet flexible feel providing exceptional control whether using it to aggressively remove material or to apply finishing pressure.

Ideal for general surface preparation and finishing with more durable surface conditioning material and a solid backing. Ideal for deburring, blending coarse abrasive scratches and removing rust, corrosion, oxides, paint, adhesives and gaskets.

Trim-Kut Surface Conditioning Discs provide a fast initial cut and high rate of productivity. They are tough and long lasting.

- Trim-Kut® design means the **abrasive material is bonded directly to a durable polymer backing**, resulting in a highly versatile grinding/finishing tool that requires no backing pad, reducing costs and set up time.
- Trim-Kut® also means these discs are readily **trimmable** to either renew the cutting surface edge or reduce the diameter for a longer lasting disc with more versatility.
- **Ideal for deburring, blending** coarse abrasive scratches and **removing** rust, corrosion, oxides, paint, scale, adhesives and gaskets.
- Trim-Kut **center locking nut** (IBS No. 64410) sold separately.



QUICK GUIDE
CLEANING
GRINDING
DEBURRING
BLENDING
FINISHING
POLISHING

Use on
ANGLE
GRINDERS



for GRINDING,
BLENDING &
FINISHING

IBS No.	Description	Qty
36710	4-1/2 X 7/8 EXTRA COARSE — BROWN	10
36712	4-1/2 X 7/8 MEDIUM — MAROON	10
36713	4-1/2 X 7/8 VERY FINE — BLUE	10
64410	4-1/2 TRIM-KUT 5/8-11 CENTER LOCKING NUT	1

Surface Conditioning SCM Flap Discs



Use on
ANGLE GRINDERS



for BLENDING &
FINISHING

QUICK GUIDE
CLEANING
GRINDING
DEBURRING
BLENDING
FINISHING
POLISHING

Surface Conditioning Discs non-woven materials are reinforced with a tightly knit fabric (scrim) backing that produces a firm, yet flexible heavy-duty material which is capable of withstanding aggressive treatment associated with demanding applications. The thick coating of evenly spread aluminum oxide grain is securely bonded to deliver a consistent, uniform finishing action for the entire life of the product.

- For general surface preparation and finishing with more durable surface conditioning material. Layered flaps provide 5 times more life than traditional discs.

SCM (SURFACE CONDITIONING MATERIAL) FLAP DISCS - TYPE 27

Dimensions (Dia. x Arbor)	V Fine Blue	Medium Maroon	Coarse Brown	MAX RPM	Optimum RPM	Qty
4-1/2 x 7/8	37730	37731	37732	13,300	6,000	5
4-1/2 x 5/8-11	37735	37736	37737	13,300	6,000	5

A
B
R
A
S
I
V
E
S



IBS, INCORPORATED

Abrasives, Shop Rolls, Files P26

A
B
R
A
S
I
V
E
S



Cloth Utility Rolls

Made from a high grade resin bonded cotton cloth material. This combination delivers long life and flexible cutting characteristics allowing for the optimum performance in a wide range of applications.

- Extremely popular as a general purpose deburring, sanding, cleaning and polishing tool in all machine, maintenance and welding shops.
- May be used on all types of materials.
- Excellent for working on turning parts and lathes.
- Supplied in a rugged corrugated storage container for easy dispensing of material.

QUICK GUIDE
CLEANING
GRINDING
DEBURRING
BLENDING
FINISHING
POLISHING

Size	Crocus*	320G	240G	180G	150G	120G	100G	80G
1 x 50 yds	40038			05006		05008		05010
1-1/2 x 50 yds	40039	05032	05024	05026	05047	05028	05049	05030
2 x 50 yds			05044	05046		05048		05050

NOTE: Crocus Roll is 800 to 1200 grit and may also be used for polishing applications.



Screen Bak Roll

QUICK GUIDE
CLEANING
GRINDING
DEBURRING
BLENDING
FINISHING
POLISHING

- Made of silicone carbide
- Open screen for high speed sanding.
- Can be used wet or dry.
- Non-clogging, no loading, use both sides for longer life and less labor.
- Ideal for body repairs, cleaning brass, copper, copper tubing and ends, removing glaze from new parts, smoothing rough spots, deburring and cleaning most surfaces.

Size	180G	120G	80G
1-1/2 x 25 yds	05751	05750	05749



Flex Cut Hand Pads (P30)

Made of non-woven nylon material impregnated with abrasive grit bonded with synthetic resins. The cost-saving alternative to steel wool and emery cloth.

QUICK GUIDE
CLEANING
GRINDING
DEBURRING
BLENDING
FINISHING
POLISHING

IBS No.	Description	Size	Grain	Color	Qty
50434	Ultra Fine	6 x 9	Silicon Carbide	Gray	10
Ideal for fine finishing and light cleaning of metal, plastic, fiberglass and wood surfaces.		Use for polishing dies, fine bur removal on threaded parts, fine finishing of aluminum doors and frames, fine deburring of metal and plastic surfaces, scuffing acrylics, blending paint, etc.			
50444	General Purpose	6 x 9	Aluminum Oxide	Maroon	10
Ideal for general purpose hand cleaning, blending and finishing.		Use for satin finishing of aluminum extrusions and stainless steel, cleaning printed circuit boards, rust and corrosion removal, jitterbug sanding, etc.			
50454	Heavy Duty	6 x 9	Aluminum Oxide	Tan	10
Ideal for demanding hand cleaning and finishing applications. Long lasting and aggressive.		Use for weld cleaning, deburring, removing heavy rust and oxides decorative scratch finishing of aluminum, finishing stainless steel, blending, etc.			



Surface Conditioning Discs

Surface Conditioning Discs non-woven materials are reinforced with a tightly knit fabric (scrim) backing that produces a firm, yet flexible heavy-duty material which is capable of withstanding aggressive treatment associated with demanding applications. A thick coating of evenly spread aluminum oxide grain is securely bonded to deliver a consistent, uniform finishing action for the entire life of the product.



SURFACE CONDITIONING DISCS TYPE "R" — ROLOC

Dimensions (Dia. x Arbor)	V Fine Blue	Medium Maroon	Coarse Brown	MAX RPM	Qty	Box Qty
3/4	06516	06517	06518	35,000	10	100

Use IBS No. 06520 Back Up Pad with 3/4"

2	06521	06522	06523	23,000	10	50
---	-------	-------	-------	--------	----	----

Use with IBS No. 06525 Back Up Pad with 2"

3	06531	06532	06533	20,000	10	25
---	-------	-------	-------	--------	----	----

Use IBS Back Up Pad No. 06535 with 3"
Use IBS Back Up Pad No. 06530 3" 5/8-11 for Angle Grinders

4		06542	06543	18,000	5	25
---	--	-------	-------	--------	---	----

Use with IBS No. 06545 Back Up Pad with 4"

QUICK GUIDE
CLEANING
GRINDING
DEBURRING
BLENDING
FINISHING
POLISHING

Use on Angle
AIR DIE GRINDERS

for **BLENDING & FINISHING**

Ceramic Grain Surface Conditioning Discs

Surface Conditioning Discs with added Ceramic Grain designed for heavier deburring, cleaning, and finishing applications.

- Excellent for weld grinding and spatter removal.
- Firm cutting action works well on flat surfaces.
- Coarser and more aggressive for heavy deburring, rust removal and scale removal.
- Ideal for use on ferrous metals, stainless and other exotic metals.



CERAMIC GRAIN SURFACE CONDITIONING DISCS TYPE "R"— ROLOC

IBS No.	Size	Grade	Color	MAX RPM	Qty	Box Qty
40421	2	Medium	Maroon	23,000	10	50
40420	2	Coarse	Brown	23,000	10	50

Use IBS Back Up Pad No. 06525 with 2"

40423	3	Medium	Maroon	20,000	10	25
40422	3	Coarse	Brown	20,000	10	25

Use IBS Back Up Pad No. 06535 with 3"
Use IBS Back Up Pad No. 06530 3" 5/8-11 for Angle Grinders

QUICK GUIDE
CLEANING
GRINDING
DEBURRING
BLENDING
FINISHING
POLISHING

Use on Angle
AIR DIE GRINDERS

for **BLENDING & FINISHING**

EXTRA TOUGH

With added ceramic grain, coarser and more aggressive than regular surface conditioning discs. Designed for heavier deburring, cleaning and finishing applications.

A
B
R
A
S
I
V
E
S



IBS, INCORPORATED

Abrasives P30

Roloc Disc Holders (P31)

These locking devices reduce disc changing time to seconds. They won't fly off at high speeds and no tools or adhesives are required. A clockwise turn securely anchors the disc to the pad and insures positive centering. Turning them counterclockwise removes the disc from the pad.

2", 3" And 4" Size

- These unique pads are available in 2", 3" & 4" sizes. New design and construction provides unparalleled durability, performance and service life.
- Exceptional combination of flexibility and back support optimizes disc performance.
- Vented pad surface removes heat generated during use, to maximize abrasive disc life.
- Uniform 3 pc composition contributes to a safe, balanced and vibration-free use for longer life.
- Mounting stem included.

5/8-11 Female to 1/4-20 Male Adapter (IBS No. 06540)

- Adapts standard back-up pads with 1/4-20 arbor for use on angle grinders with a 5/8-11 shaft — this makes for better control and easier grinding using an angle grinder versus a die grinder.

A
B
R
A
S
I
V
E
S

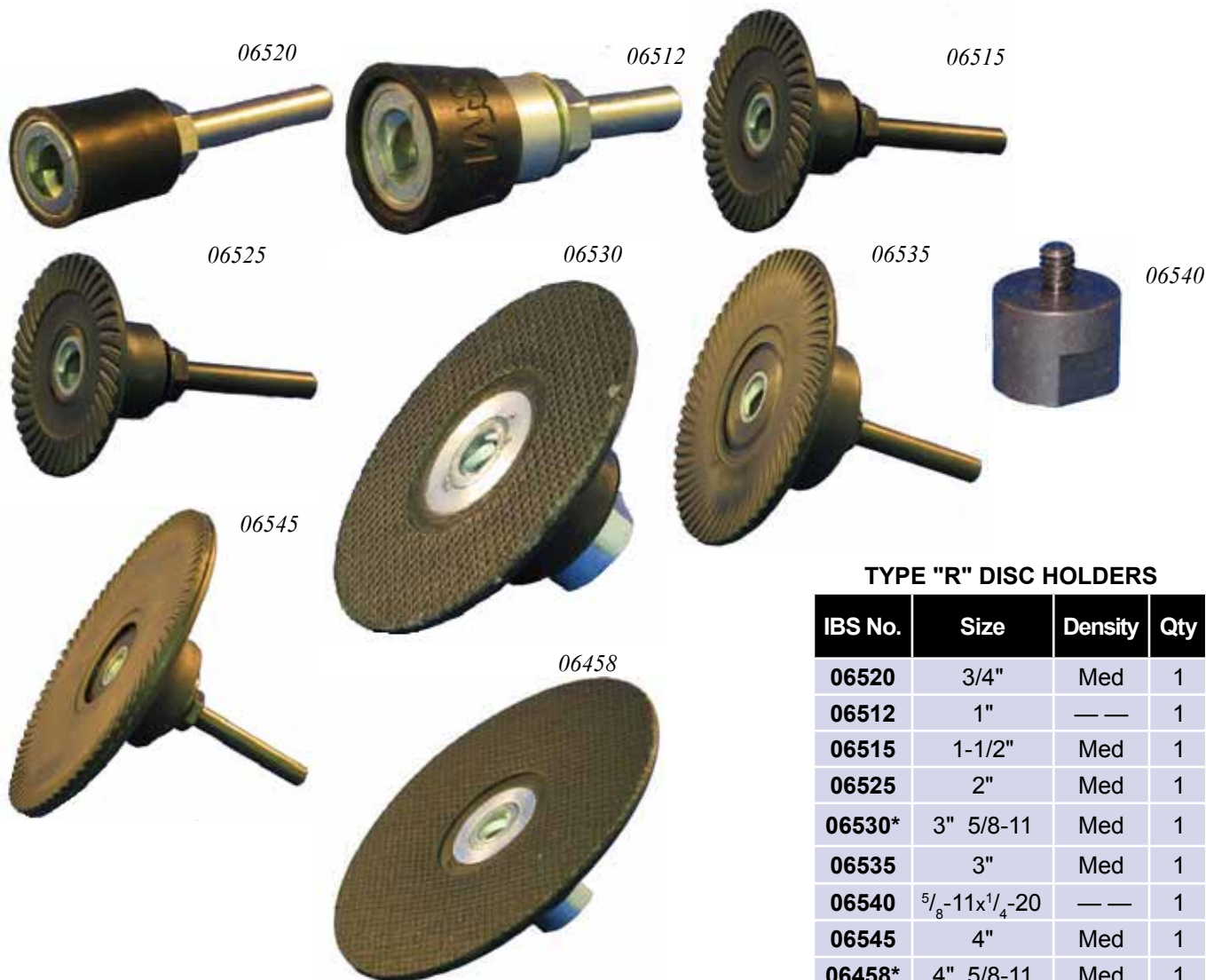

TYPE "R" DISC HOLDERS

IBS No.	Size	Density	Qty
06520	3/4"	Med	1
06512	1"	— —	1
06515	1-1/2"	Med	1
06525	2"	Med	1
06530*	3" 5/8-11	Med	1
06535	3"	Med	1
06540	5/8-11x1/4-20	— —	1
06545	4"	Med	1
06458*	4" 5/8-11	Med	1

* Converts Angle Grinders to Roloc system

IBS, INCORPORATED

Assortments Z02



Roloc™ Surface Conditioning Discs 3/4" - 4"

BACK UP PADS SOLD SEPARATELY
IBS No. 705R • 15 ITEMS • 49
PIECES

PACKAGED IN A LOCKING STEEL DRAWER

IBS, Inc. SPECIALTY PRODUCTS FOR MAINTENANCE & REPAIR INDUSTRIALBOLTY.COM © I D 800-476-1500				Roloc™ Surface Conditioning Discs 3/4" to 4"
				Assortment No. 705R
06516 3/4 FINE ROLOC SURF COND DISC	06521 2IN FINE ROLOC SURF COND DISC	06531 3IN FINE ROLOC SURF COND DISC	06542 4IN MED ROLOC SURF COND DISC	
06517 3/4 MED ROLOC SURF COND DISC	06522 2IN MED ROLOC SURF COND DISC	06532 3IN MED ROLOC SURF COND DISC	06543 4IN CRS ROLOC SURF COND DISC	
06518 3/4 CRS ROLOC SURF COND DISC	06523 2IN CRS ROLOC SURF COND DISC	06533 3IN CRS ROLOC SURF COND DISC		

Roloc™ Surface Conditioning Discs with Pads

IBS No. 707R • 16 ITEMS • 48
PIECES

PACKAGED IN A LOCKING STEEL DRAWER

IBS, Inc. SPECIALTY PRODUCTS FOR MAINTENANCE & REPAIR INDUSTRIALBOLTY.COM © I D 800-476-1500				Roloc™ Surface Conditioning Discs 3/4" to 3"
				Assortment No. 707R
06516 3/4 FINE ROLOC SURF COND DISC	06517 3/4 MED ROLOC SURF COND DISC	06518 3/4 CRS ROLOC SURF COND DISC	06520 3/4 ROLOC STYLE BACKING PAD	
06521 2" FINE ROLOC SURF COND DISC	06522 2" MED ROLOC STYLE SURF COND	06523 2" CRS ROLOC STYLE SURF COND	06525 2" ROLOC STYLE BACKING PAD	
06531 3" FINE ROLOC SURF COND DISC	06532 3" MED ROLOC STYLE SURF COND	06533 3" CRS ROLOC STYLE SURF COND	06535 3" ROLOC STYLE BACKING PAD	

2" & 3" Roloc™ Surface Prep Assortment

IBS No. 501P • 17 ITEMS • 66
PIECES

INCLUDES 1/4" 90° ANGEL AIR DIE GRINDER

IBS No. 504P • 16 ITEMS • 65
PIECES WITHOUT DIE GRINDER

PACKAGED IN A LOCKING STEEL DRAWER

IBS, Inc. SPECIALTY PRODUCTS FOR MAINTENANCE & REPAIR INDUSTRIALBOLTY.COM © I D 800-476-1500				Roloc Style Surface Prep Discs with 1/4 Angle Air Die Grinder
				Assortment No. 501P
06521 2" Fine Surface Conditioning Disc	06532 3" Medium Surface Conditioning Disc	06535 3" Roloc Back Pad	CA-14050 1/4 Angle Air Die Grinder	
06522 2" Medium Surface Conditioning Disc	06533 3" Coarse Surface Conditioning Disc	06525 2" Roloc Back Pad		
06523 2" Coarse Surface Conditioning Disc		68024 3" 80 Grit Tapered Bristle Disc	68018 2" 50 Grit Tapered Bristle Disc	
09420 2" 80 Grit Zirconium Grinding Disc	36699 3" 80 Grit Zirc Plus Grinding Disc			
09415 2" 60 Grit Zirconium Grinding Disc	36698 3" 60 Grit Zirc Plus Grinding Disc	06531 3" Fine Surface Conditioning Disc		
09410 2" 36 Grit Zirconium Grinding Disc	36695 3" 36 Grit Zirc Plus Grinding Disc			

Grinder NOT for use with cut-off wheels over 3" in diameter. Refer to ASTM B7.1-2001

ABRASIVES



IBS, INCORPORATED

Assortments Z02

A
B
R
A
S
I
V
E
S

IBS, Inc.
SPECIALTY PRODUCTS FOR MAINTENANCE & REPAIR
INDUSTRIALBOLT.COM © © © 800-670-1906

Roloc Surface Conditioning Discs

Assortment No. 523P

06521 2IN FINE ROLOC SURF COND DISC 	06531 3IN FINE ROLOC SURF COND DISC 	06545 4IN ROLOC BACKING PAD 	
06522 2IN MED ROLOC SURF COND DISC 	06532 3IN MED ROLOC SURF COND DISC 	06542 4IN MED ROLOC SURF COND DISC 	
06523 2IN CRS ROLOC SURF COND DISC 	06533 3IN CRS ROLOC SURF COND DISC 	06543 4IN CRS ROLOC SURF COND DISC 	06535 3IN ROLOC BACKING PAD 06525 2IN ROLOC BACKING PAD

**2", 3", 4" Roloc™
Surface Cond Discs**
IBS No. 523P • 11 ITEMS • 55 Pcs
WITHOUT DIE GRINDER
PACKAGED IN A LOCKING STEEL DRAWER

IBS, Inc.
SPECIALTY PRODUCTS FOR MAINTENANCE & REPAIR
INDUSTRIALBOLT.COM © © © 800-670-1906

3" Roloc™ Total Surface Prep Discs

Assortment No. 529P

40423 3IN MED ROLOC X-TOUGH CERAMIC SURF DISC 	40339 3IN 80G ROLOC CERAMIC GRAIN GRIND DISC 	38862 3IN V FINE ROLOC HI STRENGTH SATIN DISC 	06535 3IN ROLOC BACKING PAD
40422 3IN CRS ROLOC X-TOUGH CERAMIC SURF DISC 	40338 3IN 60G ROLOC CERAMIC GRAIN GRIND DISC 	38861 3IN FINE ROLOC HI STRENGTH SATIN DISC 	
06730 3IN ROLOC SUPER STRIPPER COATING REMOVAL DISC 	40335 3IN 36G ROLOC CERAMIC GRAIN GRIND DISC 	38860 3IN MED ROLOC HI STRENGTH SATIN DISC 	

**3" Roloc™ Total
Surf Prep Discs**
IBS No. 529P • 10 ITEMS • 57
PIECES • WITHOUT DIE GRINDER
PACKAGED IN A LOCKING STEEL DRAWER

IBS, Inc.
SPECIALTY PRODUCTS FOR MAINTENANCE & REPAIR
INDUSTRIALBOLT.COM © © © 800-670-1906

Roloc Surface Conditioning Discs

Assortment No. 542P

06521 2 FINE ROLOC SURF COND DISC 	06531 3 FINE ROLOC SURF COND DISC 	40420 2 CRS ROLOC X-TOUGH CERAMIC 	06535 3 ROLOC BACKING PAD
06522 2 MED ROLOC SURF COND DISC 	06532 3 MED ROLOC SURF COND DISC 	40421 2 MED ROLOC X-TOUGH CERAMIC 	
06523 2 CRS ROLOC SURF COND DISC 	06533 3 CRS ROLOC SURF COND DISC 	40422 3 CRS ROLOC X-TOUGH CERAMIC 	
06525 2 ROLOC BACKING PAD 		40423 3 MED ROLOC X-TOUGH CERAMIC 	

**Roloc Surface
Conditioning Discs**
IBS No. 542P • 12 ITEMS • 52
PIECES WITHOUT DIE GRINDER
PACKAGED IN A LOCKING STEEL DRAWER

IBS, INCORPORATED

Abrasives P30



TriFlex Grinding, Blending & Finishing Roloc Quick Change Discs

TriFlex Grinding, Blending & Finishing Roloc Quick Change Discs are IBS' latest initiative in providing premium abrasives that provide maximum performance.

FOR USE ON: Stainless steel, aluminum, mild steel, nickel alloys, kevlar and brass

FEATURES & BENEFITS:

- **Engineered with abrasive grain consistent throughout the wheel** for an even finish which allows the user to work with the entire wheel for ultimate cost and time savings.
- **Innovative blend of materials** that result in a wheel that is tough enough to grind and blend, yet soft enough to finish in one step for fewer disc changes, saving time and money.
- **Made with a blend of cotton fibers and abrasive materials** that are naturally non-loading on all metals, which make these discs ideal for use on a variety of materials, for less inventory and overall savings.
- **Has no backing material that could gouge the work surface** therefore providing a better, more consistent finish for the entire use of the wheel for maximum life resulting in cost savings.
- **Manufactured with laminates of non-woven abrasive impregnated into cotton fabric** providing a cushion action while in use, enabling the grit to push slightly back into the fiber which means more flexibility and a better surface finish versus coated abrasives.
- **The combination of cotton fiber and abrasive grain** result in a disc that will outlast other discs such as surface conditioning discs 4 to 5 times, and coated discs 8 to 10 times, saving time and money.
- **NOTE: For optimum flexibility and life, use 2" pad with 3" discs, and 1-1/2" pad with 2" discs.**



Size	Specifications					MAX RPM	Qty
	24 Grit	36 Grit	54 Grit	80 Grit	120 Grit		
2	40351	40352	40353	40354	40355	30,000	10
3	40356	40357	40358	40359	40360	20,000	10

Use IBS Back Up Pad No. 06525 with 2" or 1-1/2" 06515

Use IBS Back Up Pad No. 06535 with 3" or 2" 06525

TriFlex Roloc Quick Change Disc Assortment (Z02)

IBS No. 795R • 12 ITEMS • 34 PIECES

PACKAGED IN A LOCKING STEEL DRAWER FOR EASY STORAGE & ORGANIZATION

IBS, Inc. SPECIALTY PRODUCTS FOR MAINTENANCE & REPAIR INDUSTRIALBOLTY.COM © © © 800-678-1906		TriFlex Quick Change Discs	
Assortment No. 795R			
40351 2" 24G TRIFLEX QUICK CHANGE DISC	40352 2" 36G TRIFLEX QUICK CHANGE DISC	40353 2" 54G TRIFLEX QUICK CHANGE DISC	
40354 2" 80G TRIFLEX QUICK CHANGE DISC	40355 2" 120G TRIFLEX QUICK CHANGE DISC	06525 2" ROLOC BACKING PAD*	
40356 3" 24G TRIFLEX QUICK CHANGE DISC	40357 3" 36G TRIFLEX QUICK CHANGE DISC	40358 3" 54G TRIFLEX QUICK CHANGE DISC	
40359 3" 80G TRIFLEX QUICK CHANGE DISC	40360 3" 120G TRIFLEX QUICK CHANGE DISC	06535 3" ROLOC BACKING PAD*	



A
B
R
A
S
I
V
E
S



IBS, INCORPORATED

Abrasives P30

Mounted Satin Wheels

ALUMINUM OXIDE MEDIUM GRIT



Mounted satin wheels are most practical for removal of scale and oxidation. They will produce a uniform high luster finish without altering part geometry, and can be used for a wide variety of cleaning, finishing and polishing applications. Mounted satin wheels can be used with portable power tools, drill presses, and lathes.

QUICK GUIDE

CLEANING

GRINDING

DEBURRING

BLENDING

FINISHING

POLISHING

Use on
1/4" AIR DIE
GRINDERS



for BLENDING &
FINISHING

IBS No.	Dia.	Width	Max RPM	Shank	Qty
05762	2-3/8	2	8,000	1/4	2
05765	3	2	6,000	1/4	2

Use IBS Back Up Pad No. 06525 with 2"

Recommended RPM is 10 - 20% less than max.



High Strength Satin Discs

A flexible and durable disc with high strength fibers combined with a high grain content that delivers a tough, long lasting product for light deburring and final finishing.

QUICK GUIDE

CLEANING

GRINDING

DEBURRING

BLENDING

FINISHING

POLISHING

Use on
Angle
AIR DIE GRINDERS



for BLENDING &
FINISHING

Size	Specifications			MAX RPM	Qty
	V Fine Maroon	Fine Brown	Medium Dk Maroon		
2	38859	38858	38857	12,000	10
3	38862	38861	38860	8,000	10

Use IBS Back Up Pad No. 06525 with 2"

Use IBS Back Up Pad No. 06535 with 3"

Use IBS Back Up Pad No. 06530 3" 5/8-11 for Angle Grinders

2" & 3" Roloc Satin Discs (Z02)

IBS No. 546P • 8 ITEMS • 62 PIECES WITHOUT DIE GRINDER

PACKAGED IN A LOCKING STEEL DRAWER

2" & 3" Roloc Satin Discs

Assortment No. 546P

<p>38859 2" V FINE ROLOC HI STRENGTH</p>	<p>38861 3" FINE ROLOC HI STRENGTH</p>	<p>06535 3" ROLOC STYLE BACKING PAD</p>	
<p>38858 2" FINE ROLOC HI STRENGTH</p>	<p>38860 3" MED ROLOC HI STRENGTH</p>	<p>06525 2" ROLOC STYLE BACKING PAD</p>	
<p>38857 2" MED ROLOC HI STRENGTH</p>	<p>38862 3" V FINE ROLOC HI STRENGTH</p>		

A
B
R
A
S
I
V
E
S



Felt Polishing Discs With Fiberglass Backing

- Flap discs made of 70% wool felt affixed to a fiberglass backing plate to create a thick polishing pad.
- The individual flaps are flexible, allowing for a cool air flow.
- Felt discs are used with polishing compounds or pastes to provide up to a mirror finish
- Ideal for work on irregular or contoured surfaces.

QUICK GUIDE
CLEANING
GRINDING
DEBURRING
BLENDING
FINISHING
POLISHING



TIP: Felt Products should always be run at lower speeds than coated abrasives.



NOTE: Felt polishing products are designed to be used with polishing compounds.

FELT FLAP DISCS

IBS No.	Diameter x Arbor	OPT RPM	MAX RPM	Qty
37750	4-1/2 x 7/8	1.650	10.000	5
37752	4-1/2 x 5/8-11	1.650	10.000	5
37753	5 x 5/8-11	1.520	10.000	5

Roloc Mini Felt Flap Discs



QUICK GUIDE
CLEANING
GRINDING
DEBURRING
BLENDING
FINISHING
POLISHING

ROLOC MINI FELT FLAP DISCS

IBS No.	Diameter	OPT RPM	MAX RPM	Qty
37755	2	1.650	10.000	5
37757	3	1.650	10.000	5

Compound Polishes

For Use with Felt Polishing Discs

IBS No.	Name	Color	Description	Qty
74207	White Rouge	White	Creates a high gloss finish on non-ferrous materials like aluminum and stainless steel.	1
74206	Stainless	Gray	Provides fast cutting action and good coloring. Creates gloss finish on a wide range of materials including steel, stainless, chrome, nickel & Plastic.	1



A
B
R
A
S
I
V
E
S



IBS, INCORPORATED

Assortments Z02

2" & 3" Felt Flap Disc Assortments

IBS No. 759R • 12 ITEMS • 52 PIECES























PACKAGED IN A LOCKING STEEL DRAWER FOR EASY STORAGE & ORGANIZATION



IBS, Inc.
SPECIALTY PRODUCTS FOR MAINTENANCE & REPAIR
INDUSTRIALBOLT.COM © © © 800-678-1906

2" & 3" Roloc Satin & Felt Discs

Assortment No. 759R

<p>38857 2IN MED ROLOC HI STRENGTH SATIN DISC</p>  	<p>38860 3IN MED ROLOC HI STRENGTH SATIN DISC</p>  	<p>37755 2IN ROLOC MINI FELT FLAP DISC</p>  	  <p>74206 GRAY POLISHING COMPOUND FOR FELT DISCS</p> 
<p>38858 2IN FINE ROLOC HI STRENGTH SATIN DISC</p>  	<p>38861 3IN FINE ROLOC HI STRENGTH SATIN DISC</p>  	<p>37757 3IN ROLOC MINI FELT FLAP DISC</p>  	
<p>38859 2IN V FINE ROLOC HI STRENGTH SATIN DISC</p>  	<p>38862 3IN V FINE ROLOC HI STRENGTH SATIN DISC</p>  	<p>06525 2IN ROLOC BACKING PAD</p>   <p>06535 3IN ROLOC BACKING PAD</p>  	

A
B
R
A
S
I
V
E
S

IBS, INCORPORATED

Specialty Abrasives P32



Bristle Discs

Faster, safer, more cost-effective coatings removal, weld preparation, general maintenance cleaning and cleaning in hard-to-reach areas.

QUICK GUIDE
CLEANING
GRINDING
DEBURRING
BLENDING
FINISHING
POLISHING

Use on
Angle
AIR DIE GRINDERS



for CLEANING,
DEBURRING,
BLENDING

BRISTLE DISCS			
Standard			
Dia.	120 Grit (White)	80 Grit (Yellow)	50 Grit (Green)
1		68010	
<p>Applications: Cleaning, finishing, blending and deburring. Use for general surface conditioning applications.</p> <p>Single discs can be mounted with the Roloc™ attachment system 1" uses back-up pad 06512 Color Coded</p>			
Tapered			
Dia.	120 Grit (White)	80 Grit (Yellow)	50 Grit (Green)
2	68016	68017	68018
3	68023	68024	68025
<p>Applications: Corners, welds and other areas where extreme conformity is required.</p> <p>Single discs can be mounted with the Roloc™ attachment system 2" uses back up pad 06525 3" uses back up pad 06535 3"-5/8-11 uses back up pad 06530 Color Coded</p>			
4-1/2" Bristle Disc			
Dia.	120 Grit (White)	80 Grit (Yellow)	50 Grit (Green)
4-1/2	68452	68451	68450
<p>Applications: Ideal for removing adhesive, paint & other coatings, heavy oxides and surface contaminants.</p> <p>Threaded core spins quickly onto 5/8-11 threaded shafts on electric or pneumatic right angle grinders. Color coded.</p>			

Roloc Bristle Discs (Z08)

IBS No. 534P • 6 ITEMS • 12 PIECES WITHOUT DIE GRINDER

PACKAGED IN A LOCKING STEEL DRAWER



IBS, Inc.

SPECIALTY PRODUCTS FOR MAINTENANCE & REPAIR
INDUSTRIALBOLT.COM © © © 800-678-1906

Roloc Bristle Discs

Assortment No. 534P

<p>68018 2IN 50G TAPERED BRISTLE DISC ROLOC DISC GREEN 25000RPM</p> 	<p>68025 3IN 50G TAPERED BRISTLE DISC ROLOC DISC GREEN 15000RPM</p> 	<p>06535 3IN ROLOC BACKING PAD</p> 	
<p>68017 2IN 80G TAPERED BRISTLE DISC ROLOC DISC YELLOW 25000RPM</p> 	<p>68024 3IN 80G TAPERED BRISTLE DISC ROLOC DISC YELLOW 15000RPM</p> 	<p>06525 2IN ROLOC BACKING PAD</p> 	

A
B
R
A
S
I
V
E
S



IBS, INCORPORATED

Abrasives P30

Super Stripper Roloc™ Coating Removal Discs



Red Super Stripper discs feature a tough web of non-flexible synthetic filaments coated with extra-coarse high-performance grain in an open construction that is very aggressive and non-loading.

- Quick-Change Roloc fastening system for fast and easy changeovers.
- Versatile sizes for small work areas.
- Covers a wide range of maintenance projects, including stripping and cleaning of coatings, rust, paint, adhesives and contaminants on a wide range of materials.

QUICK GUIDE
CLEANING
GRINDING
DEBURRING
BLENDING
FINISHING
POLISHING

Use on
Angle
AIR DIE GRINDERS

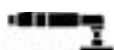

for CLEANING,
DEBURRING,
BLENDING

IBS No.	Dia.	RPM	Qty	Use with Back Up Pad	
				IBS No.	Shank
06720	2"	15,500	10	06525	2 x 1/4
06730	3"	12,000	10	06535	3 x 1/4
				06530	3 5/8-11 Thrd
06740	4"	11,000	10	06545	4 x 1/4
				06458	4 5/8-11 Thrd

Roloc™ Coating Removal Discs Assortment (Z08)

IBS No. 519P • 6 ITEMS • 15 PIECES



Super Stripper Roloc™ Coating Removal Discs

Assortment No. 519P

06525
2 ROLOC BACKING PAD"



06535
3 ROLOC BACKING PAD"



06545
4 ROLOC BACKING PAD"



06720
2 ROLOC COATING REMOVAL DISC"



06730
3 ROLOC COATING REMOVAL DISC"



06740
4 ROLOC COATING REMOVAL DISC"

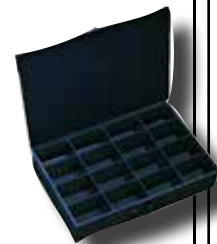

Grinder NOT for use with cut-off wheels over 3" in diameter. Refer to ASTM B7.1-2001

A
B
R
A
S
I
V
E
S



Super Stripper

4-1/2" Coating Removal Discs

Red Super Stripper discs feature a tough web of non-flexible synthetic filaments coated with extra-coarse high-performance grain in an open construction that is very aggressive and non-loading.

- Type-27 discs mounted on heavy-duty fiberglass backing plates eliminate the use of back-up pads.
- 5/8-11 hubbed disc mounts directly to right angle grinders without the use of a nut.

QUICK GUIDE
CLEANING
GRINDING
DEBURRING
BLENDING
FINISHING
POLISHING

Use on
ANGLE GRINDERS



for **CLEANING,
DEBURRING,
BLENDING**

IBS No.	Description	RPM	Qty
06745	4-1/2" x 7/8	11,000	5
06746	4-1/2 x 5/8-11	11,000	5



Roloc™ Unitized Wheels

Roloc™ unitized wheels are strong, efficient products for edge deburring and finishing. They perform well in a variety of metal working applications and on intricate machined parts where close tolerances are important.

IBS No.	Dia.	Grit	Color	RPM	Qty
06821	2"	Coarse	Tan	22,100	10
06822	2"	Medium	Tan	22,100	10
06823	2"	Fine	Gray	22,100	10

Use IBS Back Up Pad No. 06525 with 2"

06833	3"	Coarse	Coarse	15,100	10
06834	3"	Medium	Medium	15,100	10
06835	3"	Fine	Fine	15,100	10

Use IBS Back Up Pad No. 06535 with 3"

Use IBS Back Up Pad No. 06530 3" 5/8-11 for Angle Grinders

QUICK GUIDE
CLEANING
GRINDING
DEBURRING
BLENDING
FINISHING
POLISHING

Use on
**1/4" 90° Angle
AIR DIE GRINDERS**

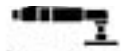

for **DEBURRING,
BLENDING &
FINISHING**



IBS, INCORPORATED

Abrasives P30

Hub & Stud Cleaning Disc



Hub and Stud Cleaning discs and holder combine an aggressive 3-D disc construction with a unique, center hole Roloc™ attachment system for improved productivity. The system removes rust and corrosion quickly, even in hard to reach places.

The attachment provides quick disc changes with the convenience of running on high-speed tools. All this adds up to saving time, increasing speed and effectiveness on the brake job.



- **Extremely tough three-dimensional web** removes rust and corrosion without excessive metal removal or gouging of the metal - Saves time and helps to maintain AOEM surface milling marks.
- **Non-metallic attachment system and disc pad holder** are made of tough polymers that will not damage the wheel stud threads - Cleans the area fast while protecting the threads.

- **Unique Roloc™ Attachment System** locks securely with 1/2 turn on and 1/2 turn off and fits over the wheel stud - Saves time, easy to use, works fast.
- Disc Holder is **designed to fit on a variety of tools** with collets or chucks makes it very versatile.
- **Ideal for use on right angle air tools.**
- **Contains no wire filaments** that eliminates the potential for injury from flying wires for safer operation.

IBS No.	Description	Qty
37150	1-1/2 x 5/8 Hub & Stud Cleaning Disc	10
37200	2 x 5/8 Hub & Stud Cleaning Disc	10
37000	Hub & Stud Cleaning Disc Holder	1



Eraser Wheel



- **Quick and easy removal** of decals, pinstripes, bumper stickers, and reflective tapes, etc. from glass, urethane, acrylic paints and OEM painted surfaces.
- **Effectively removes adhesive** tapes and glue from the back of mouldings.
- **Longer lasting and wider than a solid disc** for faster job completion.
- **Toothed wheel works cooler**, causing less smearing.
- **Includes universal arbor** for use with electric or pneumatic tools.
- **Best results at 1,500 - 3,000 RPM. MAX: 4,000 RPM.**

APPLICATION:

Clean the surface thoroughly. Apply light pressure only. Start at the top of the decal and move side to side. For faster results, use the entire width of the wheel, do not tilt on an angle.



IBS No.	Description	Qty
37700	Eraser Wheel	1

A
B
R
A
S
I
V
E
S



Drill Bits, Inserts & Reamers

A

Assortments

Threaded Rod

Grade 8 Threaded Rod Assortment PD-44

Assortments, Cutting Tool

Countersinks, Fluteless

Hex & Round Shank PD-26

Draps, IBS Hi-Alloy

5 Pc NC Hex Shank Drap Set PD-33
6 Pc Metric Hex Shank Drap Set PD-33
10 Pc NC / NF Hex Shank Drap Set PD-33

Drill Bits, Nitro-Carb

7 Pc. Nitro-Carb Mech Length Drill Bit Set - Pouch PD-13
12 Pc. Nitro-Carb Mech Length Drill Bit Set - Hard Case PD-13
16 Pc. Nitro-Carb Mech Length Drill Bit Set - Pouch PD-13

IBS Type 187 Spotweld PD-24

Left Hand Drill Bit PD-17

Letter PD-12

Number PD-12

Quick Release Drill Bit & Insert PD-13

Reduced Shank PD-14, PD-15

Stubby PD-19

Drill Bits, Nitro-X

13 Pc Nitro-X Step Tip Mechanics Length Handi-Bit Set 1/16 X 1/2 by 32nds PD-3
29 Pc Nitro-X Step Tip Mechanics Length Set 1/16 X 1/2 by 64ths PD-3
51 Pc. Nitro-X StepTip Mechanic's Length Organizer Set 1/16 to 1/2 by 64ths PD-3

Handi-Bit Dispenser

Jobber's Length, 29pc PD-10

Mechanic's Length, 29pc PD-10

Reamers

3 Pc Step Reamer Set PD-29

Reamers, Nitro-Carb

Hole Hog Reamers with Drills PD-32

Unibit

3 Pc Set PD-28

Assortments, Cutting Tools

Carbide Burs PD-44

Assortments, Tools

Extractors

25 Piece Hex Head Spline Drive Screw Extractor Set PD-45

Screw Extractors, Sets

25 Piece Hex Head Spline Drive Screw Extractor Set PD-45

C

Countersinks

6-Flute Chatterless Countersinks PD-25

Fluteless

3 Pc Set Hex Shank PD-26

5 Pc Set, Round Shank PD-26

Round & Hex Shank PD-26

D

DRAPS, Hi-Alloy

NC, NF, & Metric PD-33

DRAPS, IBS Hi-Alloy PD-33

Drill Bits

Assortments

Economy Drill Bits PD-21

IBS NITRO-X STEP TIP DRILL BIT ORGANIZER PD-3, PD-4

IBS NITRO-X STEP TIP DRILL HANDI-BIT SET PD-3

IBS Type 187 Spotweld PD-24

Jobbers Length Drill Bit Sets PD-11

Left Hand, Nitro-Carb PD-17

Letter & Number, Nitro-Carb PD-12

Mechanics Length Drill Bit Sets PD-11

Metric Nitro-Carb Drill Bit Sets PD-21

Nitro-Carb Quick-Change Hex Shank Drill Bit PD-13

Platinum Spiral Flute Step Drill Travel Trays PD-27

Reduced Shank, Nitro-Carb PD-14, PD-15

Stubby, Nitro-Carb PD-19

Nitro-Carb Left Hand

Stubby Drill Set PD-18

Ultra Point Acrylic Drill Bits PD-25

Unibit 3 Piece Set PD-28

Carbide Tipped Straight Flute Drills for Hard Steel PD-16

Extended Length PD-21

Glass & Tile PD-24

IBS Cryo-Tech HSS Nitrided

Jobber's Length PD-3, PD-4, PD-5

IBS NITRO-X S&D Step Tip Drill Bits PD-4

IBS NITRO-X Step Tip Drill Bits PD-3

IBS Type 187

Spotweld PD-24

Masonry

SDS Plus Masonry Drill Bits PD-23

SDS Plus Masonry Drill Bits

5 Pc Set PD-23

Straight Shank Masonry PD-22

Straight Shank Masonry

Drill Bits — 5 Pc Set PD-22

Nitro-Carb

Double End PD-19

Letter PD-12

Metric PD-20

Number PD-12



Quick-Change Hex Shank Drill Bits PD-13

Stubby Length PD-19

Nitro-Carb Platinum

Handi-Bit 29 Pc Mechanic's Length Drill Bit Assortm PD-10

Nitro-Carb, PLATINUM SERIES

General Info PD-8

Jobbers & Mechanic's Lengths PD-9

Mechanic's Length Reduced Shank Drills PD-14

Platinum Series Spiral Reamers PD-31

Platinum Spiral Flute Step Drills PD-27

Ultra Point Acrylic PD-25

Driver Bits

Grabit Drill-Out Broken Bolt Extractor Set PD-44

GRABIT PRO Damaged Screw Remover PD-44

E

Extractors

Bolt Extractors PD-45

Screw Extractors

Power-Outs™ Double Edged Screw Extractors PD-45

Screw Extractors, Sets

25 Piece Hex Head Spline Drive Screw Extractor Set PD-45

Grabit Drill-Out Broken Bolt Extractor Set PD-44

Power-Outs Sets PD-45

H

Handi-Bit 29 Pc Drill Bit Sets

Black PD-10

Hi-Vis PD-10

Hi-Alloy PD-24

I

IBS NITRO-X S&D Step Tip Drill Bits PD-4

N

Nitro-Carb

Stubby Length

Left Hand

Left Hand Stubby Drill Bits PD-18

Nitro-X StepTip Mechanic's Length 51 Pc Organizer Set

1/16 to 1/2 by 64ths PD-3

R

Reamers

Nitro-Carb

Hole Hog PD-32

Step Reamers PD-29

3 Pc Set PD-29

S

Screw Extractors, Sets

Grabit Drill-Out Broken Bolt Extractor Set PD-44

T

Technical Information

Drill Bits

Decimal Equivalent Chart For Drill Sizes PD-40

Fractional Drill Cutting Speeds in RPM PD-36

Letter Drill Cutting Speeds in RPM PD-37

Metric Drill Cutting Speeds in RPM PD-39

Number Drill Cutting Speeds in RPM PD-38

Re-sharpening Procedures PD-7

Speeds & Feeds Tables PD-34

Surface Cutting Speeds For Various Materials PD-35

Drills, Nitro-Carb

Features & Benefits PD-6

Metric Drill Cutting Speeds PD-39

Nitro Carb vs Cobalt PD-7

Drills, Nitro-Carb Platinum Series

Features & Benefits PD-8

iNES Internal Rethreading Tap PD-42

iNES Replacement Blades & Nylon Pads PD-43

NES Rethreading Tools PD-41

Nitro-Carb Spiral Reamers

Features & Benefits PD-30

Step Drills PD-27, PD-28

Threaded Rod

Tools

Deburring Tool (T03) PD-44

Grabit® Drill-Out Broken Bolt Extractor Set PD-44

Tools

Hand

iNES Internal Rethreading Tap PD-42

iNES Replacement Blades & Nylon Pads PD-43

NES Rethreading Tools PD-41

Power-Outs Sets PD-45

ThreadMate Set & External Tool PD-43

Threaded Rod

Deburring Tool 3Pc Set (T03) PD-44

Grabit® Drill-Out Broken Bolt Extractor Set PD-44



IBS NITRO-X Step Tip Drill Bits

Mechanic's Length • 3 Flats On Shank • MADE IN THE U.S.A



EXPAND HOLES • EXTREME APPLICATIONS • EXCEPTIONAL LIFE & VALUE

Nitro-X Step Tip Drill Bits have a unique **step point** for faster and cooler drilling. This innovative design combines the fast penetrating action of a reamer with all the superior features of our standard Nitro-Carb drill bits with **up to 50% faster drilling and 4X longer life.**

- **EXPAND Holes** — The **unique step tip design** easily enlarges existing holes without damaging the point that is typical with standard tip drill bits.
- **EXTREME Applications** — Ideal for hard steel, sheet metal, brass and even acrylics.
- **EXCEPTIONAL Life & Value** — The **step tip geometry reduces heat** that is generated on a larger tip, producing smaller chips and shavings for a cooler cut, reducing cutting tool wear for increase tool life.
- **Mechanics length** for a shorter, sturdier construction, **providing better control and reduced breakage.**
- **The unique step tip design** rapidly reams the hole larger as it penetrates for a faster, cooler cutting action — up to 50% faster than standard tip drill bits — saving time and money!
- **Eliminates the need to drill starter pilot holes** before making larger hole sizes.
- The **micro 135° split point provides accurate starting and self centering**, eliminating the need for a center punch or pilot hole.
- **Three flats on the shank reduce slippage for superior hold** even in hand-held operations - (3/16" and larger).
- **Gold surface treated** for added lubricity.
- **1/16" to 1/2" in 1/64" increments.**
- **MADE IN THE USA!**

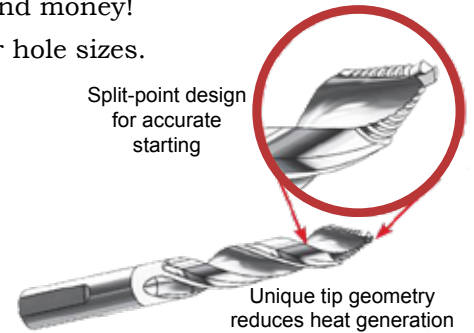

Drill Size	IBS No.	Overall Length	Flute Length	Qty	Drill Size	IBS No.	Overall Length	Flute Length	Qty	Drill Size	IBS No.	Overall Length	Flute Length	Qty
1/16	18200*	1-7/8	7/8	6	7/32	18210	3-1/4	2	6	3/8	18220	4-1/4	2-11/16	3
5/64	18201*	2	1	6	15/64	18211	3-3/8	2-1/16	6	25/64	18221	4-5/16	2-3/4	3
3/32	18202*	2-1/4	1-1/4	6	1/4	18212	3-1/2	2	6	13/32	18222	4-3/8	2-13/16	2
7/64	18203*	2-3/8	1-5/16	6	17/64	18213	3-5/8	2-1/8	3	27/64	18223	4-7/16	2-7/8	2
1/8	18204	2-1/2	1-7/16	6	9/32	18214	3-3/4	2-1/4	3	7/16	18224	4-1/2	2-15/16	2
9/64	18205	2-5/8	1-9/16	6	19/64	18215	3-7/8	2-3/8	3	29/64	18225	4-5/8	3	2
5/32	18206	2-3/4	1-11/16	6	5/16	18216	4	2-1/2	3	15/32	18226	4-3/4	3-1/8	2
11/64	18207	2-7/8	1-13/16	6	21/64	18217	4-1/16	2-9/16	3	31/64	18227	4-7/8	3-1/4	2
3/16	18208	3	1-7/8	6	11/32	18218	4-1/8	2-5/8	3	1/2	18228	5	3-3/8	2
13/64	18209	3-1/8	1-15/16	6	23/64	18219	4-3/16	2-11/16	3					

* These bits are too small to have the Nitro-X Step Tip and have a standard 135° split point

IBS NITRO-X STEP TIP DRILL HANDI-BIT SET



IBS NITRO-X STEP TIP DRILL BIT ORGANIZER

IBS No.	Description
16765	51 Pc. Nitro-X StepTip Mechanic's Length Organizer Set 1/16 to 1/2 by 64ths



IBS No.	Description
17466	13 Pc Nitro-X Step Tip Mechanic's Length Handi-Bit Set 1/8 X 1/2 by 32nds
17464	29 Pc Nitro-X Step Tip Mechanic's Length Set 1/16 X 1/2 by 64ths



IBS, INCORPORATED

Nitro-X Drill Bits P06

IBS NITRO-X Reduced Shank Step Tip Drill Bits



EXPAND HOLES • EXTREME APPLICATIONS • EXCEPTIONAL LIFE & VALUE

Nitro-X Reduced Shank Step Tip Drill Bits have a unique **step point** for faster and cooler drilling. This innovative design combines the fast penetrating action of a reamer with all the superior features of our standard Nitro-Carb drill bits with **up to 50% faster drilling and 4X longer life**.

- **EXPAND Holes** — The **unique step tip design** easily enlarges existing holes without damaging the point that is typical with standard tip drill bits.
- **EXTREME Applications** — Ideal for hard steel, sheet metal, brass and even acrylics.
- **EXCEPTIONAL Life & Value** — The **step tip geometry reduces heat** that is generated on a larger tip, producing smaller chips and shavings for a cooler cut, reducing cutting tool wear for increase tool life.
- **The unique step tip design** rapidly reams the hole larger as it penetrates for a faster, cooler cutting action — up to 50% faster than standard tip drill bits — saving time and money!
- The **micro 135° split point provides accurate starting and self centering**, eliminating the need for a center punch or pilot hole.
- **Three flats on the shank reduce slippage for superior hold** even in hand-held operations.
- **Gold surface treated** for added lubricity.
- **9/16" to 1" in 1/16" increments.**
- **MADE IN THE USA!**

IBS NITRO-X STEP TIP 1/2 SHANK DRILL BITS

IBS No.	Description
18881	9/16 NITRO-X Step Tip 1/2 Shank Drill Bit
18883	5/8 NITRO-X Step Tip 1/2 Shank Drill Bit
18885	11/16 NITRO-X Step Tip 1/2 Shank Drill Bit
18887	3/4 NITRO-X Step Tip 1/2 Shank Drill Bit
18889	13/16 NITRO-X Step Tip 1/2 Shank Drill Bit
18891	7/8 NITRO-X Step Tip 1/2 Shank Drill Bit
18893	15/16 NITRO-X Step Tip 1/2 Shank Drill Bit
18895	1" NITRO-X Step Tip 1/2 Shank Drill Bit



IBS NITRO-X STEP TIP S&D 4 Pc & 8 Pc Sets

IBS No.	Description
18897	4 Pc. Nitro-X Step Tip 1/2 Shank Drill Bit Set Sizes: 9/16", 5/8", 3/4" & 1"
18899	8 Pc. Nitro-X Step Tip 1/2 Shank Drill Bit Set Sizes: 9/16-1 X 1/16

D
R
I
L
L
B
I
T
S
E
T
C

IBS, INCORPORATED

Cryo-Tech Nitrided HSS P05



IBS Cryo-Tech™ Nitrided HSS Drill Bits

Jobber's Length • 135° Split Point • 3 Flats Shank
MADE IN THE U.S.A.



- **Cryogenic hardening** creates a denser, more uniform grain steel for a harder, longer lasting drill bit increasing drill durability and lifespan, saving time and money.
- **A harder more durable bit that has reduced friction and wear properties as well as surface roughness** creating a cooler cutting and faster cutting drill bit that is more effective, reducing the "cost-per-hole" — outperforms cobalt in work hardening stainless steel!
- Cryogenic hardening also creates **a more uniform grain structure that also relieves stress fracturing**, making for a more durable bit that lasts 50% longer than other HSS drill bits for less breakage, less wear and increased productivity.
- **Bits are nitrided — this process diffuses nitrogen into the surface to create a case hardening** for superior tool life and exceptional corrosion resistance for a longer lasting bit that saves time and money.

IBS CRYO-TECH NITRIDED HSS JOBBER'S LENGTH DRILL BITS

Drill Size	IBS No.	Overall Length	Flute Length	Qty	Drill Size	IBS No.	Overall Length	Flute Length	Qty	Drill Size	IBS No.	Overall Length	Flute Length	Qty
1/16	16600	1-7/8	7/8	6	7/32	16610	3-3/4	2-1/2	6	3/8	16620	5	3-5/8	3
5/64	16601	2	1	6	15/64	16611	3-7/8	2-5/8	6	25/64	16621	5-1/8	3-3/4	3
3/32	16602	2-1/4	1-1/4	6	1/4	16612	4	2-3/4	6	13/32	16622	5-1/4	3-7/8	2
7/64	16603	2-5/8	1-1/2	6	17/64	16613	4-1/8	2-7/8	3	27/64	16623	5-3/8	3-15/16	2
1/8	16604	2-3/4	1-5/8	6	9/32	16614	4-1/4	2-15/16	3	7/16	16624	5-1/2	4-1/16	2
9/64	16605	2-7/8	1-3/4	6	19/64	16615	4-3/8	3-1/16	3	29/64	16625	5-5/8	4-3/16	2
5/32	16606	3-1/8	2	6	5/16	16616	4-1/2	3-3/16	3	15/32	16626	5-3/4	4-5/16	2
11/64	16607	3-1/4	2-1/8	6	21/64	16617	4-5/8	3-5/16	3	31/64	16627	5-7/8	4-3/8	2
3/16	16608	3-1/2	2-5/16	6	11/32	16618	4-3/4	3-7/16	3	1/2	16628	6	4-1/2	2
13/64	16609	3-5/8	2-7/16	6	23/64	16619	4-7/8	3-1/2	3					

IBS Cryo-Tech™ Organizer

MADE IN THE U.S.A. (P15)



IBS No.	Description
16764	51 Pc. IBS Cryo-Tech 1/16 thru 1/2 x 64ths Cryo Jobber Length Handi-Bit Index

IBS Cryo-Tech™ Handi-Bit Set

MADE IN THE U.S.A.



IBS No.	Description
17437	29 Pc. IBS Cryo-Tech 1/16 thru 1/2 x 64ths Cryo Jobber Length Handi-Bit Index
17049	Cryo Red Handi Bit Index only (Empty)

D R I L L B I T S E T C



IBS, INCORPORATED

Nitro-Carb Drills P02

IBS Nitro-Carb Drill Bits

Super Premium High Performance Drills

More Holes Per Drill! Lower Cost Per Hole!

WHAT SETS THEM APART FROM THE REST

IBS Nitro-Carb Drill Bits are manufactured with a special **high Molybdenum tool steel** for a **more consistent drill bit** with a higher than average hardness and **more resistance to wear**. The **flutes** are ground to **1/2 of industry standard tolerances**, which means **more accuracy and more consistency** in grinding operations. The flutes also feature a nitro-carburized surface to provide extra wear resistance along the cutting edge of the point.



Tighter Tolerances

DISCOVER THE NITRO-CARB DIFFERENCE

IBS Nitro Carb Drill Bits feature a **split point** which provides the drill bit with **self-centering/ non-walking characteristics**, and **reduces the thrust required** to penetrate a work piece. A low temperature surface treatment relieves stress; produces a gold color and improves lubricity.

Our **Mechanic's Length Drill Bits** as well as our **1/2" Reduced Shank Drill Bits** have **3 flats on the shank**. These flats allow for a **strong positive chuck grip** of the shank and virtually **eliminate** the potential for the drill to **slip into the chuck**.

These heavy duty drill bits are recommended for use in work hardening grades of stainless steel and other tough metal drilling applications. Heavy duty construction and the nitro-carburized, hi-molybdenum tool steel means:

- **EASILY CUTS:**
Stainless Steels • Tool Steels • Exotic Steels • Standard Steels
- **Substantially longer cutting life**
The nitro-carburized flute has an increased Rockwell hardness.
- **Cuts harder materials**
The flatter point takes a smaller chip. More torque is directed to a smaller area. This allows drilling into materials with hardness of over 30 on the Rockwell "C" scale.
- **Stops drill walking**
The split point design gives accurate starting without the use of a center punch.
- **Holds tighter hole size**
The split point design is self centering. This limits the normal oversize drilling characteristics.
- **Outstanding quality appearance**
The rich amber gold color sets it apart from commodity cutting tools.
- **Runs cooler, uses less torque**
135° point takes a smaller chip resulting in less heat. Amber gold surface treatment reduces friction. The Nitro-Carb bits will substantially out-perform cobalt drill bits in work hardening stainless steel applications. This performance advantage is the result of the construction difference between the two types of bits.



Nitro-Carburized Flute



135° Split Point



NITRO-CARB VS. COBALT

Cobalt bits, manufactured to **Type J NAS 907 specs**, have a very thick web. A thick web provides the strength needed to limit breakage of the cobalt steel.

Nitro-Carb bits are made of special hi-moly tool steel, which is much tougher than cobalt steel. The resulting strength of the Nitro-Carb bit allows the bit to be manufactured with a considerably thinner web. (See photo A).

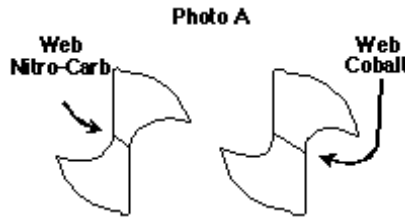

A Nitro-Carb bit with its thin web will penetrate the work hardening stainless fast enough to continually cut beneath the chip which is hardening from deformation. This means the drill bit is cutting softer steel. The cobalt bit, with its thick web, cannot be fed at a fast enough rate to cut beneath the area which is hardening. As a result the cobalt bit is continually drilling into hardened steel.

Re-sharpening Procedure

1. SET-UP FOR POINTING

- Clamp guide block on tool rest at 67.5°.
- Set tool rest below center line.
- Dress wheel for parallel edges and true face.
- Use an 80 to 100 grit semi-friable grinding wheel.

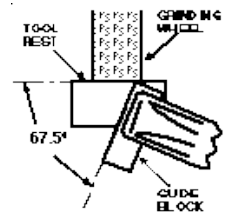
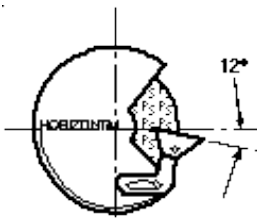

2. GRIND POINT ANGLE

Forming Primary Cutting Edge

- Pre-grind to remove all damaged edges.
- Place frill on tool rest parallel to guide block.
- Align cutting lip parallel to machine axis.
- Push into wheel.
- Repeat for second cutting edge.

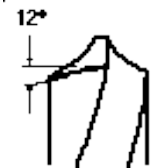
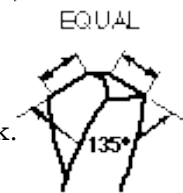
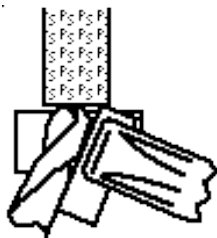

3. POINT SPLIT

Forming Secondary Cutting Edges

- Grind secondary cutting edges.
- Feed into wheel until center is reached.
- Repeat for other side.

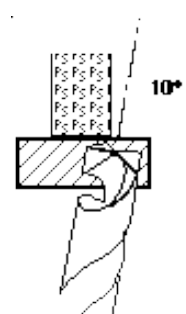
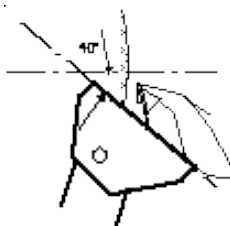
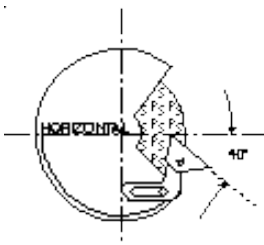

NOTE: ALL DAMAGED SECTIONS ON THE POINT AND MARGINS MUST BE GROUND AWAY PRIOR TO ANY ABOVE RESHARPENING PROCEDURE.

D R I L L B I T S E T C



IBS, INCORPORATED

Nitro-Carb Drills P02

IBS Nitro-Carb Platinum Series Mechanics & Jobber's Lengths Nitro-Carb Drill Bits



"Platinum Series — The Proof is in the Performance"

D
R
I
L
L
B
I
T
S
E
T
C

- **BUILT FOR SUBSTANTIALLY LONGER CUTTING LIFE** - The Nitro-Carburized Flute has an increased Rockwell hardness providing strength without becoming brittle.
- **DESIGNED TO CUT HARDER MATERIALS** — The flatter point takes a smaller chip. More torque is directed to a smaller area. This allows drilling into materials with hardness of over 30 on the Rockwell "C" scale.
- **BLACK TREATED MARGINS** - designed to produce a free flow of chips and protect the cutting edge from heat abrasion for reduced friction and wear resulting in maximum life when drilling tough materials like stainless steel.
- **STAYS SHARP** - Flute Surface Treatment improves chip removal and reduces friction so bits maintain sharpness for longer life.
- **RUNS COOL -135° split point** takes a smaller chip, uses less torque and minimizes heat build up for longer life.
- **ELIMINATES DRILL WALKING** - The split point design gives accurate and quick-starting without the use of a center punch - (even on round surfaces) - fewer steps saves time.
- **PRODUCES TRUE HOLES** - The split point design self-centers and holds a tighter, truer hole size. This limits oversize drilling characteristics and produces accurate holes even in handheld applications.
- **NO CHUCK SLIPPAGE** - Flats on the Mechanic's Length drill shanks (3/16" and larger) allow easy positive chuck grip for safety, and speed — great for keyless chucks!
- **UNIQUE APPEARANCE** - the bright platinum flute and black web distinguish this bit from commodity cutting tools.
- **QUALITY ASSURANCE** - Bears the IBS stamp assuring that you are using a truly unique, high quality cutting tool.
- **MADE IN THE USA!**

IBS, INCORPORATED

Nitro-Carb Drills P02



IBS Nitro-Carb Platinum Series Drill Bits

"Platinum Series — The Proof is in the Performance"



PLATINUM SERIES NITRO CARB MECHANIC'S LENGTH DRILL BITS

Drill Size	IBS No.	Overall Length	Flute Length	Qty	Drill Size	IBS No.	Overall Length	Flute Length	Qty	Drill Size	IBS No.	Overall Length	Flute Length	Qty
1/16	17400	1-7/8	7/8	6	7/32	17410	3-1/4	2	6	3/8	17420	4-1/4	2-11/16	3
5/64	17401	2	1	6	15/64	17411	3-3/8	2-1/16	6	25/64	17421	4-5/16	2-3/4	3
3/32	17402	2-1/4	1-1/4	6	1/4	17412	3-1/2	2	6	13/32	17422	4-3/8	2-13/16	2
7/64	17403	2-3/8	1-5/16	6	17/64	17413	3-5/8	2-1/8	3	27/64	17423	4-7/16	2-7/8	2
1/8	17404	2-1/2	1-7/16	6	9/32	17414	3-3/4	2-1/4	3	7/16	17424	4-1/2	2-15/16	2
9/64	17405	2-5/8	1-9/16	6	19/64	17415	3-7/8	2-3/8	3	29/64	17425	4-5/8	3	2
5/32	17406	2-3/4	1-11/16	6	5/16	17416	4	2-1/2	3	15/32	17426	4-3/4	3-1/8	2
11/64	17407	2-7/8	1-13/16	6	21/64	17417	4-1/16	2-9/16	3	31/64	17427	4-7/8	3-1/4	2
3/16	17408	3	1-7/8	6	11/32	17418	4-1/8	2-5/8	3	1/2	17428	5	3-3/8	2
13/64	17409	3-1/8	1-15/16	6	23/64	17419	4-3/16	2-11/16	3					



PLATINUM SERIES NITRO CARB JOBBER'S LENGTH DRILL BITS

Drill Size	IBS No.	Overall Length	Flute Length	Qty	Drill Size	IBS No.	Overall Length	Flute Length	Qty	Drill Size	IBS No.	Overall Length	Flute Length	Qty
1/16	16800	1-7/8	7/8	6	7/32	16810	3-3/4	2-1/2	6	3/8	16820	5	3-5/8	3
5/64	16801	2	1	6	15/64	16811	3-7/8	2-5/8	6	25/64	16821	5-1/8	3-3/4	3
3/32	16802	2-1/4	1-1/4	6	1/4	16812	4	2-3/4	6	13/32	16822	5-1/4	3-7/8	2
7/64	16803	2-5/8	1-1/2	6	17/64	16813	4-1/8	2-7/8	3	27/64	16823	5-3/8	3-15/16	2
1/8	16804	2-3/4	1-5/8	6	9/32	16814	4-1/4	2-15/16	3	7/16	16824	5-1/2	4-1/16	2
9/64	16805	2-7/8	1-3/4	6	19/64	16815	4-3/8	3-1/16	3	29/64	16825	5-5/8	4-3/16	2
5/32	16806	3-1/8	2	6	5/16	16816	4-1/2	3-3/16	3	15/32	16826	5-3/4	4-5/16	2
11/64	16807	3-1/4	2-1/8	6	21/64	16817	4-5/8	3-5/16	3	31/64	16827	5-7/8	4-3/8	2
3/16	16808	3-1/2	2-5/16	6	11/32	16818	4-3/4	3-7/16	3	1/2	16828	6	4-1/2	2
13/64	16809	3-5/8	2-7/16	6	23/64	16819	4-7/8	3-1/2	3					

D R I L L B I T S E T C



IBS, INCORPORATED

Nitro-Carb Drill Bit Sets P15

Handi-Bit 29 PcDrill Bit Sets

Available in Black and Hi-Visibility Indexes



D
R
I
L
L

B
I
T
S

E
T
C

Our 29 pc clip-on drill index is ideal for use both in the shop or at the job site. Made from high impact plastic, the Handi-Bit canister has a molded side hook that clips on to a tool caddy, utility belt, tool bucket, or ladder. Eliminate wasted time searching for the correct drill bit - 29 different sizes are in hands reach. With a screw-on plastic hex shaped cover, drill bits will remain secure and protected. Available in **Mechanics, Jobbers and Left Handed** styles.

- Contains drill bits from 1/16" to 1/2" by 64ths.
- Screw-on hex-shaped cover protects & contains drill bits.
- Water-resistant, great for outdoor job sites.
- Constructed of high-impact, break resistant plastic.
- Available in Black and Hi-Visibility Yellow Handi-Bit Indexes

BLACK DRILL INDEX			HI-VISIBILITY DRILL INDEX		
IBS No.	Description	Qty	IBS No.	Description	Qty
17435	Mechanic's Length	1	17460	Mechanic's Length	1
17438	Jobber's Length	1	17461	Jobber's Length	1
17439	Left Hand Jobbers Length	1	17462	Left Hand Jobber's Length	1

IBS, INCORPORATED

Nitro-Carb Drill Assortments P15



Nitro-Carb Drill Bit Sets Jobber's Length



JOBBER'S LENGTH DRILL BIT SETS - INDEX

IBS No.	Description
16756	13 Pc. Jobbers Length Fractional Drill Set Sizes 1/16" to 1/4" by 64ths. Complete with index.
16755	15 Pc. Jobber's Length Drill Set Sizes 1/16" to 1/2" by 32nds. Packaged in a 29 Pc. index for expansion to 64ths sizes
16759	15 Pc. Jobbers Length Drill Set Sizes 1/16" to 1/2" by 32nds. Complete with 32nds index
16757	21 Pc. Jobber's Length Drill Set Sizes 1/16" to 3/8" by 64ths Complete with index
16760	29 Pc. Jobber's Length Drill Set Sizes 1/16" to 1/2" by 64ths. Complete with index.
16763	115 Pc. Fractional, Letter & Number Drill Set Contains Platinum Series and Nitro-Carb Drill Bits Letter Drills A to Z (NC) Number Drills #1 through #60 (NC) Fractional drills 1/16" to 1/2" by 64ths (Platinum)



JOBBER'S LENGTH DRILL BIT SET - ORGANIZER

IBS No.	Description
16762	51 Pc Jobbers Length Drill Set 29 of the most popular drill bit sizes. Contains 51 Platinum drill bits Sizes 1/16" to 1/2" by 64ths. Complete with 3 drawer organizer See Chart for sizes and quantities.

Nitro-Carb Drill Bit Sets Mechanic's Length



MECHANIC'S LENGTH DRILL BIT SETS - INDEX

IBS No.	Description
17433	13 Pc. Mechanic's Length Drill Set Sizes 1/16" to 1/4" by 64ths. Complete with index
17432	15 Pc. Mechanic's Length Drill Set Sizes 1/16" to 1/2" by 32nds. Packaged in a 29 Pc. index for expansion to 64ths sizes
17434	21 Pc. Mechanic's Length Drill Set Sizes 1/16" to 3/8" by 64ths. Complete with index
17431	29 Pc. Mechanic's Length Drill Set Sizes 1/16" to 1/2" by 64ths Complete with index.



MECHANIC'S LENGTH DRILL BIT SET - ORGANIZER

IBS No.	Description
17430	51 Pc Mechanic's Length Drill Set 29 of the most popular drill bit sizes. Contains 51 Platinum drill bits Sizes 1/16" to 1/2" by 64ths. Complete with 3 drawer organizer See Chart for sizes and quantities.

16762 & 17430 BIT SIZES & QUANTITIES

Size	Qty.	Size	Qty.	Size	Qty.	Size	Qty.
1/16	3	3/16	4	5/16	1	7/16	1
5/64	3	13/64	1	21/64	1	29/64	1
3/32	3	7/32	1	11/32	1	15/32	1
7/64	3	15/64	1	23/64	1	31/64	1
1/8	5	1/4	3	3/8	1	1/2	1
9/64	3	17/64	1	25/64	1		
5/32	3	9/32	1	13/32	1		
11/64	2	19/64	1	27/64	1		

D R I L L B I T S E T C



IBS, INCORPORATED

Nitro-Carb Drills P02

Nitro-Carb Number Drills

Sizes #1 — #52 are 135° split point.
 Sizes #53 — #80 are non-split point.
 Sizes #61 — #80 are high speed steel.



NITRO CARB NUMBER DRILL BITS

Drill Size	IBS No.	Drill Size	IBS No.	Drill Size	IBS No.
#1	16080	#28	16107	#55	15927
#2	16081	#29	16108	#56	15928
#3	16082	#30	16109	#57	15929
#4	16083	#31	16110	#58	15930
#5	16084	#32	16111	#59	15931
#6	16085	#33	16112	#60	15932
#7	16086	#34	16113	#61	16715
#8	16087	#35	16114	#62	16716
#9	16088	#36	16115	#63	16717
#10	16089	#37	16116	#64	16718
#11	16090	#38	16117	#65	16719
#12	16091	#39	16118	#66	16720
#13	16092	#40	16119	#67	16721
#14	16093	#41	16120	#68	16722
#15	16094	#42	16121	#69	16723
#16	16095	#43	16122	#70	16724
#17	16096	#44	16123	#71	16725
#18	16097	#45	16124	#72	16726
#19	16098	#46	16125	#73	16727
#20	16099	#47	16126	#74	16728
#21	16100	#48	16127	#75	16729
#22	16101	#49	16128	#76	16730
#23	16102	#50	16129	#77	16731
#24	16103	#51	16130	#78	16732
#25	16104	#52	16131	#79	16733
#26	16105	#53	16132	#80	16734
#27	16106	#54	15926		

Sold in quantities of (1)

Nitro-Carb Letter Drills



NITRO CARB LETTER DRILL BITS A - Z

Drill Size	IBS No.	Drill Size	IBS No.
A	16135	N	16148
B	16136	O	16149
C	16137	P	16150
D	16138	Q	16151
E	16139	R	16152
F	16140	S	16153
G	16141	T	16154
H	16142	U	16155
I	16143	V	16156
J	16144	W	16157
K	16145	X	16158
L	16146	Y	16159
M	16147	Z	16160

Sold in quantities of (1)

Letter & Number Drill Bit Sets (P15)



LETTER & NUMBER DRILL BIT SETS - INDEX

IBS No.	Description
16703	60 Pc. Jobber's Length Number Drill Set Sizes #1 through #60. Complete with Index.
16704	26 Pc. Jobber's Length Letter Drill Set Sizes A through Z. Complete with index.
16713	60 Pc. Jobber's Length Number Drill Set Sizes #1 through #60. Complete with 5 drawer organizer.
16714	26 Pc. Jobber's Length Letter Drill Set Sizes A through Z. Complete with 3 drawer organizer.

D
R
I
L
L
B
I
T
S
E
T
C



Nitro-Carb Quick-Change Hex Shank Drill Bits (P21)



A new version of our superior Nitro-Carb Mechanics Length Drill Bits featuring the convenience of a quick change hex shank.

- One piece machined shank (bits larger than 1/4") encounter more torque to withstand. Competitor bits have cast shanks that do not stand up to the force and constant use.
- All metal, welded shank design (bits 1/4" and smaller) — competitor bits have cast shanks that do not stand up to the force and constant use.
- Special Hi-Molybdenum tool steel.
- 135° split point for fast penetration and accurate starting without center punch.
- Body and clearance are treated for maximum lubricity.
- Especially designed for hand held drills.
- Recommended for use in hardening grades of stainless steel and other hard metal drill applications.
- Quick release eases changing of cutting tools

Drill Size	IBS No.	Drill Size	IBS No.
1/16	15400	5/16	15416
3/32	15402	11/32	15418
1/8	15404	3/8	15420
5/32	15406	13/32	15422
3/16	15408	7/16	15424
7/32	15410	15/32	15426
1/4	15412	1/2	15428
9/32	15414		

Sold in quantities of (1)

Nitro-Carb Quick-Change Hex Shank Drill Bit Sets (P15)



15429, 15430



15431



15432

IBS No.	Description
15429	7 Pc. Nitro-Carb Mech Length Drill Bit Set - Pouch. Sizes 1/16 to 1/4 by 32nds
15430	7 Pc. Nitro-Carb Mech Length Drill Bit Set - Pouch. Sizes 1/8 to 1/2 by 16ths
15431	16 Pc. Nitro-Carb Mech Length Drill Bit Set - Pouch. Sizes 1/16 to 1/2 by 32nds
15432	12 Pc. Nitro-Carb Mech Length Drill Bit Set - Hard Case. Sizes 1/16 to 1/2 by 32nds

Quick Release Drill Bit & Insert Assortment
IBS No. 744R • 22 Items • 28 Pcs
Packaged in a locking steel drawer for easy storage and organization

IBS, Inc. <small>SPECIALTY PRODUCTS FOR MAINTENANCE & REPAIR</small> <small>INDUSTRIALDRILL.COM • 9 • 9 • C 800-678-1906</small>				Quick Release Drill Bit and Power Bit Assortment <small>Assortment No. 744R</small>			
15404 1/8 HEX SHANK DRILL <small>*15400 1/16 HEX SHANK DRILL</small> <small>*15402 3/32 HEX SHANK DRILL</small>		15406 5/32 MECH LGTH NITRO CARB QUICK RELEASE HEX SHANK DRILL		15408 3/16 MECH LGTH NITRO CARB QUICK RELEASE HEX SHANK DRILL		15410 7/32 MECH LGTH NITRO CARB QUICK RELEASE HEX SHANK DRILL	
15412 1/4 MECH LGTH NITRO CARB QUICK RELEASE HEX SHANK DRILL		15414 9/32 MECH LGTH NITRO CARB QUICK RELEASE HEX SHANK DRILL		15416 5/16 MECH LGTH NITRO CARB QUICK RELEASE HEX SHANK DRILL			
15418 11/32 MECH LGTH NITRO CARB QUICK RELEASE HEX SHANK DRILL		15420 3/8 MECH LGTH NITRO CARB QUICK RELEASE HEX SHANK DRILL		<small>*15422 13/32 HEX SHANK DRILL</small> <small>*15424 7/16 HEX SHANK DRILL</small> <small>*15426 15/32 HEX SHANK DRILL</small> <small>*15428 1/2 HEX SHANK DRILL</small>			
250-PB11 #1 PHIL X 1-15/16 POWER BIT	250-PB12 #2 PHIL X 1-15/16 POWER BIT	250-PB13 #3 PHIL X 1-15/16 POWER BIT	MSH1/4 1/4 NUT DRIVER	140341 COMBO QUICK CHANGE BIT HOLDER			
250-PB31 #1 PHIL X 3-1/2 POWER BIT	250-PB32 #2 PHIL X 3-1/2 POWER BIT	250-PB33 #3 PHIL X 3-1/2 POWER BIT		MSH5/16 5/16 NUT DRIVER			
250-R11 #1 SQ. DRIVE X 1-15/16 POWER BIT	250-R12 #2 SQ. DRIVE X 1-15/16 POWER BIT	250-R13 #3 SQ. DRIVE X 1-15/16 POWER BIT		MSH3/8 3/8 NUT DRIVER			



IBS, INCORPORATED

Nitro-Carb Drills P02

D
R
I
L
L
B
I
T
S
E
T
C

1/2" & 3/8" Reduced Shank Drill Bits (P03)

- Hi-Molybdenum tool steel.
- Heavy duty construction.
- 135° split point - Sizes larger than 1" have 118° split point.
- 3 flats on shank (on 1/2" Reduced Shank Only) individually tubed and insure positive chucking without slippage
- Gold surface treated body and clearance for maximum lubricity.
- 6" Overall Length.



3/8" REDUCED SHANK DRILL BITS

Drill Size	IBS No.	Qty.	Drill Size	IBS No.	Qty.
25/64	16870	1	29/64	16874	1
13/32	16871	1	15/32	16875	1
27/64	16872	1	31/64	16876	1
7/16	16873	1	1/2	16877	1



1/2" REDUCED SHANK DRILL BITS

Drill Size	IBS No.	Qty.	Drill Size	IBS No.	Qty.
33/64	16833	1	13/16	16852	1
17/32	16834	1	53/64	16853	1
35/64	16835	1	27/32	16854	1
9/16	16836	1	55/64	16855	1
37/64	16837	1	7/8	16856	1
19/32	16838	1	57/64	16857	1
39/64	16839	1	29/32	16858	1
5/8	16840	1	59/64	16859	1
41/64	16841	1	15/16	16860	1
21/32	16842	1	61/64	16861	1
43/64	16843	1	31/32	16862	1
11/16	16844	1	63/64	16863	1
45/64	16845	1	1	16864	1
23/32	16846	1	1-1/16	16865	1
47/64	16847	1	1-1/8	16866	1
3/4	16848	1	1-1/4	16867	1
49/64	16849	1	1-3/8	16868	1
25/32	16850	1	1-1/2	16869	1
51/64	16851	1			

1/2" Mechanic's Length Platinum Series Reduced Shank Drills (P03)

- Hi-Molybdenum tool steel.
- Heavy duty construction.
- 135° split point - Sizes larger than 1" have 118° split point.
- Black treated margins provides a free flow of chips and protects the cutting edge from heat abrasion so drills last longer when drilling tough materials like stainless steel.
- 3 flats on shank individually tubed and insure positive chucking without slippage.
- Designed for use in work hardening grades of stainless steel and other hard metal drilling applications.
- 5" Overall Length.



1/2" REDUCED SHANK DRILL BITS

Drill Size	IBS No.	Qty.	Drill Size	IBS No.	Qty.
9/16	16881	1	13/16	16889	1
5/8	16883	1	7/8	16891	1
11/16	16885	1	15/16	16893	1
3/4	16887	1	1	16895	1

Reduced Shank Nitro-Carb Drill Bit Sets(P15)



REDUCED SHANK DRILL BIT SETS - CASE

IBS No.	Description
16897	4 Pc. Reduced Shank Mechanics Length PLATINUM SERIES 9/16, 5/8, 3/4, 1" Complete with sturdy storage case
16898	4 Pc. Jobber's Length Nitro-Carb Reduced Shank Drill Set 9/16, 5/8, 3/4, 1" Complete with sturdy storage case



Reduced Shank Nitro-Carb Drill Sets (P15)



3/8 REDUCED SHANK DRILL BIT SETS - INDEX

IBS No.	Description
16706	29 Pc. Jobber's Length Nitro-Carb Reduced Shank Drill Set 1/16" to 1/2" by 64ths 3/8" shank on drill sizes larger than 3/8" Complete with metal index
16707	15 Pc. Jobber's Length Reduced Shank Starter Set 1/16" to 1/2" by 32nds. 3/8" shank on drill sizes larger than 3/8" Complete with 29 pc index for expansion NOTE: Contains same drills as 16705 - different index
16705	15 Pc. Jobber's Length Reduced Shank Starter Set 1/16" to 1/2" by 32nds. 3/8" shank on drill sizes larger than 3/8" Complete with 29 pc index for expansion NOTE: Contains same drills as 16707 - different index



1/2 REDUCED SHANK DRILL BIT SETS - INDEX

IBS No.	Description
16761	8 Pc. Jobber's Length Reduced Shank Drill Set 9/16, 5/8, 11/16, 3/4, 13/16, 7/8, 15/16, 1" Complete with metal index
16899	8 Pc. Mechanic's Length Reduced Shank Drill Set 9/16, 5/8, 11/16, 3/4, 13/16, 7/8, 15/16, 1" Complete with metal index



REDUCED SHANK DRILL BIT SETS - STAND

IBS No.	Description
16709	4 Pc. Jobber's Length Reduced Shank Drill Set 9/16, 5/8, 11/16, 3/4" Complete with metal stand
16710	33 Pc. Jobber's Length Reduced Shank Drill Set 1/2, 33/64, 17/32, 35/64, 9/16, 37/64, 19/32, 39/64, 5/8, 41/64, 21/32, 43/64, 11/16, 45/64, 23/32, 47/64, 3/4", 49/64, 25/32, 51/64, 13/16, 53/64, 27/32, 55/64, 7/8, 57/64, 29/32, 59/64, 15/16, 61/64, 31/32, 63/64, 1" Complete with metal stand

D
R
I
L
L
B
I
T
S
E
T
C



IBS, INCORPORATED

Nitro-Carb Drills (P02)

Carbide Tipped Straight Flute Drills for Hard Steel (P20)



When other drill bits can't cut it, turn to the bit designed for hardened steels and drilling out broken items such as studs and taps.

- Straight-flute drill bits are stronger than spiral-flute drill bits and resist breaking when drilling into hard and abrasive materials, such as hardened steels with a Rockwell hardness of 35 to 60 HRC.
- The bits provide free cutting action, generate minimal heat during drilling and leave a smooth finish on the hole without requiring a reaming pass
- Straight flutes help with chip evacuation in horizontal drilling applications.
- Carbide-tipped drill bits have carbide cutting edges that provide excellent hardness, wear resistance, and heat resistance.
- The bit's body is made from a material that absorbs more vibration and shock than carbide, so they are less rigid and less likely to break than solid carbide drill bits.

IBS No.	Diameter (in.)	Shank Diameter (in)	Overall Length (in)	Qty
16173	3/16	3/16	3	1
16175	1/4	1/4	4	1
16178	5/16	1/4	4	1
16180	3/8	3/8	6	1
16183	1/2	1/2	6	1
17463	5 Pc Carbide Tipped Straight Flute Drill Set for Hard Steel (P15)			1
834R	5 Pc Carbide Tipped Straight Flute Drill Set for Hard Steel (P15)			



5 Pc Carbide Tipped Straight Flute Drill Set

IBS No. 17463 • 5 Items • 5 Pcs

Includes sizes

3/16, 1/4, 5/16, 3/8 & 1/2

Packaged in a Folding Pouch for Easy Storage and Organization

- Pouch holds up to 7 drills (IBS No. 17035).
- Sturdy belt clip for convenience.
- **Pouch Dimensions:** Closed 3-1/2" X 6-1/2"
Open: 3-1/2" X 13"

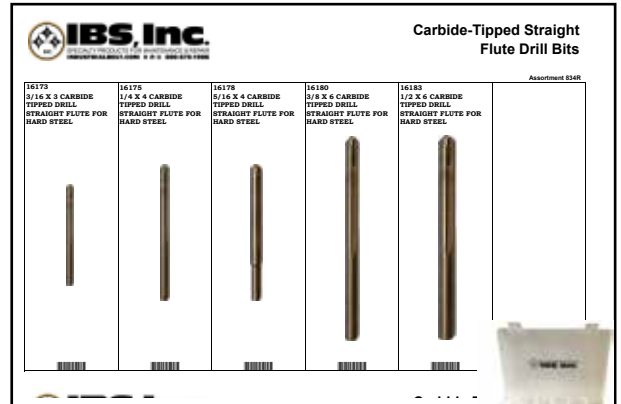

5 Pc Carbide Tipped Straight Flute Drill Set

IBS No. 834R • 5 Items • 5 Pcs

Includes sizes

3/16, 1/4, 5/16, 3/8 & 1/2"

Packaged in Plastic Travel Tray for Easy Storage & Organization

D
R
I
L
L
B
I
T
S
E
T
C



Left Hand Drill Bits (P16)

- Nitro-Carburized Hi-Molybdenum tool steel.
- Gold surface treated for maximum lubricity.
- Self centering 135° split point for fast penetration & accurate starting without a center punch.
- Precision ground point, flutes and body, clearance, and drill diameter provide the ultimate in accuracy and performance.
- Ideal for drilling broken studs.
- Need for screw and bolt extractor may be eliminated.



Drill Size	IBS No.	Qty.	Drill Size	IBS No.	Qty.	Drill Size	IBS No.	Qty.	Drill Size	IBS No.	Qty.
1/16	15940	3	3/16	15948	2	5/16	15957	1	7/16	15965	1
5/64	15941	3	13/64	15949	2	21/64	15958	1	29/64	15966	1
3/32	15942	3	7/32	15950	2	11/32	15959	1	15/32	15967	1
7/64	15943	3	15/64	15951	2	23/64	15960	1	31/64	15968	1
1/8	15944	3	1/4	15953	2	3/8	15961	1	1/2	15969	1
9/64	15945	3	17/64	15954	1	25/64	15962	1			
5/32	15946	3	9/32	15955	1	13/32	15963	1			
11/64	15947	2	19/64	15956	1	27/64	15964	1			

Left Hand Drill Bit Sets (P15)



LEFT HAND DRILL BIT SETS - INDEX

IBS No.	Description
15970	8 Pc. Left Hand Nitro Carb Drill Bit Starter Set 1/16 thru 1/2 x 1/16ths. Packaged in a 15 pc index for expansion
15971	29 Pc. Left Hand Nitro Carb Drill Bit Set 1/16 thru 1/2 x 64ths. Packaged in a 29 Pc Index
17429	8 Pc. Left Hand Nitro Carb Drill Bit Set 1/16 thru 1/2 x 16ths. Packaged in a 29 Pc Handi-Bit Index for expansion
17439	29 Pc. Left Hand Nitro Carb Drill Bit Set 1/16 thru 1/2 x 64ths. Packaged in a 29 Pc Handi-Bit Index

D R I L L B I T S E T C



IBS, INCORPORATED

Nitro-Carb Drill Bits P02

Left Hand Stubby Drill Bits

- **PERFECT FOR REMOVING BROKEN BOLTS AND STUDS** – The shorter length makes for a stronger, more stable drill and the left hand flute design assists with drilling out broken bolts and studs without tightening further - actually loosening and backing out the broken bolt or stud – saving time and money on costly repairs.
- **Nitro-Carburized** Hi-Molybdenum tool steel.
- **Gold surface treated** for maximum lubricity.
- **Self centering 135° split point** for fast penetration & accurate starting without a center punch.
- **Precision ground point, flutes and body**, clearance, and drill diameter provide the ultimate in accuracy and performance.
- **NO CHUCK SLIPPAGE** — Flats on the Stubby Length drill shanks allow easy positive chuck grip for safety and speed — great for keyless chucks!
- Ideal for removing broken studs.
- Need for screw and bolt extractor may be eliminated.
- **MADE IN THE USA!**



Nitro-Carb Left Hand Stubby Drill Set (P15)

Drill Size	IBS No.	Qty.	Drill Size	IBS No.	Qty.
1/16	18400	3	9/32	18414	1
5/64	18401	3	5/16	18416	1
3/32	18402	3	11/32	18418	1
1/8	18404	3	3/8	18420	1
5/32	18406	3	13/32	18422	1
3/16	18408	2	7/16	18424	1
7/32	18410	2	15/32	18426	1
1/4	18412	2	1/2	18428	1



IBS No.	Description
16702	15 Pc. Nitro-Carb Left Hand Stubby Drill Index Set 1/16 thru 1/2 x 64ths. Complete with metal index

Power Out Extractor & Stubby Left Hand Drill Bit Travel Tray

IBS No. 818R • 10 Items • 10 Pcs • (P15)

Packaged in an adjustable compartment small plastic travel tray for easy storage and organization

Power-Out Extractor & Stubby Left Hand Nitro Carb Drill Bit
Assortment 818R

<small>139501</small> #1 POWER-OUT DBL EDGED SCREW EXTRACTOR	<small>139502</small> #2 POWER-OUT DBL EDGED SCREW EXTRACTOR	<small>139503</small> #3 POWER-OUT DBL EDGED SCREW EXTRACTOR	<small>139504</small> #4 POWER-OUT DBL EDGED SCREW EXTRACTOR	<small>139505</small> #5 POWER-OUT DBL EDGED SCREW EXTRACTOR	
<small>18406</small> 5/32 STUBBY LEFT HAND NITRO CARB DRILL	<small>18412</small> 1/4 STUBBY LEFT HAND NITRO CARB DRILL	<small>18416</small> 5/16 STUBBY LEFT HAND NITRO CARB DRILL	<small>18424</small> 7/16 STUBBY LEFT HAND NITRO CARB DRILL	<small>18428</small> 1/2 STUBBY LEFT HAND NITRO CARB DRILL	

IBS, INCORPORATED

Nitro-Carb Drill Bits P02



Nitro-Carb Double End Drills (P20)



- Self centering 135° split point.
- Nitro-Carburized Hi-Molybdenum tool steel.
- 2 drills in one means twice the holes per drill and lower costs per hole.
- Ideal for pop rivet applications, truck and auto bodies and any thin sheet metal applications.

Drill Size	IBS No.	Qty.	Drill Size	IBS No.	Qty.
1/8	15909	6	1/4	15915	6
5/32	15910	6	#11	15917	6
3/16	15911	6	#20	15918	6
7/32	15912	6	#30	15919	6

Nitro-Carb Double End Drill Travel Tray (P15)

IBS No. 17442 • 6 Items • 12 Pcs

Packaged in an adjustable compartment small plastic travel tray for easy storage and organization



Stubby Drill Bits



- Hi-Molybdenum tool steel.
- Heavy duty construction.
- 135° split point, no center punch needed — will not walk.
- Recommended for work hardening grades of stainless steel and other hard metal drilling applications.
- Gold surface treated body and clearance for maximum lubricity.
- Short length of drill makes this an especially rigid drill for greater drilling accuracy.
- Less stress due to shorter length and less breakage.
- Drill is designed for ease of penetration and to facilitate chip removal in tough, hard materials.

Drill Size	IBS No.	Qty.	Drill Size	IBS No.	Qty.	Drill Size	IBS No.	Qty.	Drill Size	IBS No.	Qty.
1/16	17800	6	3/16	17808	6	5/16	17816	3	7/16	17824	2
5/64	17801	6	13/64	17809	6	21/64	17817	3	29/64	17825	2
3/32	17802	6	7/32	17810	6	11/32	17818	3	15/32	17826	2
7/64	17803	6	15/64	17811	6	23/64	17819	3	31/64	17827	2
1/8	17804	6	1/4	17812	3	3/8	17820	3	1/2	17828	2
9/64	17805	6	17/64	17813	3	25/64	17821	2			
5/32	17806	6	9/32	17814	3	13/32	17822	2			
11/64	17807	6	19/64	17815	3	27/64	17823	2			



Stubby Nitro-Carb Drill Set (P15)

IBS No.	Description
16708	29 Pc. Nitro-Carb Stubby Drill Bit Set 1/16 thru 1/2 x 64ths. Complete with metal index
16711	15 Pc. Nitro-Carb Stubby Drill Bit Set 1/16 thru 1/2 x 32nds. Complete with metal index

D R I L L B I T S E T C



IBS, INCORPORATED

Nitro-Carb Drill Bits P02

Metric Nitro-Carb Drill Bits (P02)

- Nitro-Carburized Hi-Molybdenum tool steel.
- Gold surface treated for maximum lubricity.
- Self centering 135° split point for fast penetration & accurate starting without a center punch.
- Precision ground point, flutes and body, clearance, and drill diameter provide the ultimate in accuracy and performance.

D
R
I
L
L
B
I
T
S
E
T
C

Drill Size	IBS No.	Qty.	Drill Size	IBS No.	Qty.	Drill Size	IBS No.	Qty.	Drill Size	IBS No.	Qty.
.7	17830	1	3.0	17864	1	6.4	17898	1	9.8	17932	1
.8	17831	1	3.1	17865	1	6.5	17899	1	9.9	17933	1
.85	17832	1	3.2	17866	1	6.6	17900	1	10.0	17934	1
.9	17833	1	3.3	17867	1	6.7	17901	1	10.1	17935	1
.95	17834	1	3.4	17868	1	6.8	17902	1	10.2	17936	1
1.0	17835	1	3.5	17869	1	6.9	17903	1	10.3	17937	1
1.05	17836	1	3.6	17870	1	7.0	17904	1	10.4	17938	1
1.1	17837	1	3.7	17871	1	7.1	17905	1	10.5	17939	1
1.15	17838	1	3.8	17872	1	7.2	17906	1	10.6	17940	1
1.2	17839	1	3.9	17873	1	7.3	17907	1	10.7	17941	1
1.25	17840	1	4.0	17874	1	7.4	17908	1	10.8	17942	1
1.3	17841	1	4.1	17875	1	7.5	17909	1	10.9	17943	1
1.35	17842	1	4.2	17876	1	7.6	17910	1	11.0	17944	1
1.4	17843	1	4.3	17877	1	7.7	17911	1	11.1	17945	1
1.45	17844	1	4.4	17878	1	7.8	17912	1	11.2	17946	1
1.5	17845	1	4.5	17879	1	7.9	17913	1	11.3	17947	1
1.55	17846	1	4.6	17880	1	8.0	17914	1	11.4	17948	1
1.6	17847	1	4.7	17881	1	8.1	17915	1	11.5	17949	1
1.65	17848	1	4.8	17882	1	8.2	17916	1	11.6	17950	1
1.7	17849	1	4.9	17883	1	8.3	17917	1	11.7	17951	1
1.75	17850	1	5.0	17884	1	8.4	17918	1	11.8	17952	1
1.8	17851	1	5.1	17885	1	8.5	17919	1	11.9	17953	1
1.9	17852	1	5.2	17886	1	8.6	17920	1	12.0	17954	1
2.0	17853	1	5.3	17887	1	8.7	17921	1	12.1	17955	1
2.05	17854	1	5.4	17888	1	8.8	17922	1	12.2	17956	1
2.1	17855	1	5.5	17889	1	8.9	17923	1	12.3	17957	1
2.2	17856	1	5.6	17890	1	9.0	17924	1	12.4	17958	1
2.3	17857	1	5.7	17891	1	9.1	17925	1	12.5	17959	1
2.4	17858	1	5.8	17892	1	9.2	17926	1	12.6	17960	1
2.5	17859	1	5.9	17893	1	9.3	17927	1	12.7	17961	1
2.6	17860	1	6.0	17894	1	9.4	17928	1	12.8	17962	1
2.7	17861	1	6.1	17895	1	9.5	17929	1	12.9	17963	1
2.8	17862	1	6.2	17896	1	9.6	17930	1	13.0	17964	1
2.9	17863	1	6.3	17897	1	9.7	17931	1			

GRAY shaded lines indicate NON-STOCK items. Allow 2-3 weeks extra order processing time.



Metric Nitro-Carb Drill Bit Sets (P15)



IBS No.	Description
17450	25 Pc Metric Nitro-Carb Drill Bit Set 25 of the most popular drill bit sizes. 1mm thru 13mm by .5mm Complete with 3 drawer organizer



METRIC NITRO-CARB DRILL BIT SET - INDEX

IBS No.	Description
17451	19 Pc. Metric Nitro-Carb Drill Bit Set 1mm thru 10mm x .5mm Complete with metal index
17452	25 Pc. Metric Nitro-Carb Drill Bit Set 1mm thru 13mm x .5mm Complete with metal index

Extended Length Drill Bits Aircraft Drill Bits (P18)

- Ideal for drilling where extra reach is needed.
- 135° split point.
- Bright finish.
- High speed steel.



IBS No.	Drill Size	Flute Length	Qty
59616	1/4 x 12	2-3/4	1
59620	5/16 x 12	3-3/16	1
59624	3/8 x 12	3-5/8	1
59628	7/16 x 12	4-1/16	1
59632	1/2 x 12	4-1/2	1

Economy Drill Bits (P2A)

- 118° point.
- General purpose drills for portable and machine drilling.
- Designed to perform well in low and medium carbon steel cast iron & wood.
- Bright finish.



Drill Size	IBS No.	Qty.	Drill Size	IBS No.	Qty.
1/16	17104	1	19/64	17119	1
5/64	17105	1	5/16	17120	1
3.32	17106	1	21/64	17121	1
7/64	17107	1	11/32	17122	1
1/8	17108	1	23/64	17123	1
9/64	17109	1	3/8	17124	1
5/32	17110	1	25/64	17125	1
11/64	17111	1	13/32	17126	1
3/16	17112	1	27/64	17127	1
13/64	17113	1	7/16	17128	1
7/32	17114	1	29/62	17129	1
15/64	17115	1	15/32	17130	1
1/4	17116	1	31/64	17131	1
17/64	17117	1	1/2	17132	1
9/32	17118	1			



ECONOMY DRILL BIT SET - INDEX

IBS No.	Description
16701	29 Pc. Economy Drill Bit Set 1/16 thru 1/2 x 64ths Complete with metal index

D R I L L B I T S E T C



IBS, INCORPORATED

Masonry Drill Bits

Straight Shank Masonry Drill Bits (P20)



- Carbide tipped, surface treated, regular helix.
- Heat-resistant up to 1800°F.
- Diamond ground tungsten carbide tip is copper brazed for long life and heat resistance.
- Manufactured with a 15° negative grind to reduced carbide chipping.
- Wide flute provides fast dust removal in softer materials.
- Straight shank bits for professional use in 3-jaw chuck drill for drilling brick, concrete, cinder block, stone, etc.
- Produced according to ANSI standards to meet application tolerances.

IBS No.	Size	Length (Overall x Flute)	Qty	IBS No.	Size	Length (Overall x Flute)	Qty
15896	1/8	3 x 1-3/8	1	15904	9/16	6 x 3-1/2	1
15897	5/32	3 x 1-1/2	1	15905	5/8	6 x 3	1
15897A	5/32	6 x 4	1	15906	3/4	6-3/4 x 3-1/2	1
15898	3/16	3-1/2 x 1-9/16	1	15907	7/8	6-1/4 x 3-1/2	1
15898A	3/16	6 x 3-1/2	1	15908	7/8	13 x 9	1
15899	7/32	6 x 4	1	159081	1	6-1/4 x 4	1
15900	1/4	4 x 2-1/8	1	159082	1	13 x 9	1
159001	1/4	6 x 4	1	15902	3/8	6 x 3-1/2	1
159002	9/32	4 x 2-1/2	1	159021	7/16	6 x 3-1/2	1
15901	5/16	4-3/4 x 2-3/4	1	15903	1/2	6 x 3-1/2	1
159011	3/8	4-1/2 x 2-3/4	1				

Straight Shank Masonry Drill Bits — 5 Pc Set (P15)

IBS No. 15998

- Sizes range from 5/32" to 1/2".
- Packaged in a clear plastic index.

Includes sizes:

IBS No.	Size	Length	IBS No.	Size	Length
15897A	5/32	6	15902	3/8	6
15898A	3/16	6	15903	1/2	6
159001	1/4	6			





SDS Plus Masonry Drill Bits

Faster drilling from a new carbide tip which features:

- Brazing and hardening are completed in a unique oven process guaranteeing a higher uniform quality.
- Self centering for precise starts.
- 160° angle means optimum elasticity and wear resistance for superior function and longevity.

Longer life from:

- Bronze alloy brazing of the carbide tip withstands heat better than silver used on many competitive products.
- High quality shot-peened steel strengthened to relieve tension and bit breakage.
- New wide fluting design flows the dust out of the hole faster, thus reducing friction and adding life to the carbide cutting.

IBS No.	Size	Total Length	Usable Length	Qty	IBS No.	Size	Total Length	Usable Length	Qty
15800	5/32	4	2	1	15825	7/16	6	4	1
15801	5/32	6	4	1	15826	7/16	12	10	1
15802	3/16	4	2	1	15827	1/2	6	4	1
15803	3/16	6	4	1	15828	1/2	8	6	1
15804	3/16	8	6	1	15829	1/2	12	10	1
15805	3/16	12	10	1	15830	1/2	18	16	1
15806	7/32	6	4	1	15831	1/2	24	22	1
15807	7/32	8	6	1	15832	9/16	6	4	1
15808	7/32	16	14	1	15833	9/16	12	10	1
15809	1/4	4	2	1	15834	9/16	18	16	1
15810	1/4	6	4	1	15835	5/8	6	4	1
15811	1/4	8	6	1	15836	5/8	8	6	1
15812	1/4	12	10	1	15837	5/8	12	10	1
15813	1/4	18	16	1	15838	5/8	18	16	1
15814	9/32	4	2	1	15839	5/8	24	22	1
15815	9/32	6	4	1	15840	11/16	8	6	1
15816	5/16	4	2	1	15841	3/4	6	4	1
15817	5/16	6-1/2	4	1	15842	3/4	8	6	1
15818	5/16	8	6	1	15843	3/4	12	10	1
15819	5/16	12	10	1	15844	3/4	18	16	1
15820	3/8	6	4	1	15845	27/32	6	4	1
15821	3/8	8	6	1	15846	7/8	12	10	1
15822	3/8	12	10	1	15847	7/8	18	16	1
15823	3/8	18	16	1	15848	1	12	10	1
15824	3/8	24	22	1	15849	1	18	16	1

GRAY shaded lines indicate NON-STOCK items. Allow 2-3 weeks extra order processing time.

SDS Plus Masonry Drill Bits 5 Pc Set (P15)

IBS No. 15851

Set Includes:

- Sizes range from 5/32" to 1/2".
- Packaged in a clear plastic index.



IBS No.	Size	Length	IBS No.	Size	Length
15801	5/32	6	15820	3/8	6
15803	3/16	6	15827	1/2	6
15810	1/4	6			

D R I L L B I T S E T C



IBS, INCORPORATED

Miscellaneous Drill Bits (P20)

IBS Type 187 Spotweld Drill Bits

- A rugged, high performance drill bit designed to effectively cut auto body panel spot welds.
- Cobalt steel permits speeds up to 30% greater than H.S.S. drills.
- Cobalt Steel is substantially more abrasion resistant, resulting in very long wearing cutting edges.



IBS No.	Diameter MM	Approx Spotweld Size, Inches	Overall Length Inches	Qty
19341	8.00	5/16	2.25	1
19342	10.00	3/8	2.25	1
19343	8.0 TE*	5/16	3.62	1
19344	10.0 TE*	3/8	3.62	1

* TE Twin End Drill Bits

These twin end drill bits will cut twice as many spot welds with the added advantage of longer reach to drill the less accessible spotwelds.



SPOTWELD DRILL BIT SET (P15)

IBS No.	Description
19340	4 Pc. Spotweld Drill Bit Set (P15) 8.0, 10.00, 8.0TE, 10.0TE Complete with metal index

Glass & Tile Drill Bits



- Industrial grade carbide to prevent cracking and ensure a long life.
- Pointed tip for accuracy of hole placement and easy centering.

Applications:

- For drilling glass, tiles, ceramics and mirrors.
- Reduced rotational speed (RPM) and use of water improves the drilling results.

Key Safety or Application Warning:

Glass and Tile Bits are only for rotary application. If you are using a Hammer Drill, you must TURN OFF THE HAMMER MODE.

IBS No.	Diameter MM	Overall Length Inches	Qty
15981	1/8	3-1/2	1
15982	5/32	3-1/2	1
15983	3/16	3-1/2	1
15984	1/4	3-1/2	1
15985	5/16	3-3/4	1
15986	3/8	4	1
15987	1/2	4	1



Ultra Point Acrylic Drill Bits



Acrylic drills are designed with ultra points for superior performance when drilling through plastics, acrylics, or laminate surfaces.

- **Special Hi-Molybdenum tool steel, gold surface treated** body, flute and point for maximum lubricity.
- **The ultra point is precision ground at a 60° angle** for gradual penetration to avoid cracking and chipping of the acrylic material.
- **Special 0° rake angle on cutting edge** eliminates grabbing when drill breaks through plastic, acrylic or laminate surfaces.
- All sizes over 1/4" have 1/4" shanks.

IBS No.	Diameter	IBS No.	Diameter	IBS No.	Diameter	IBS No.	Diameter
17280	3/32	17284	7/32	17288	11/32	17292	15/32
17281	1/8	17285	1/4	17289	3/8	17293	1/2
17282	5/32	17286	9/32	17290	13/32		
17283	3/16	17287	5/16	17291	7/16		



Sold in quantities of (1)

ULTRA POINT ACRYLIC DRILL BIT SET (P15)

IBS No.	Description
17295	7 Pc Ultra Point Drill Bit Set (P15) 1/8 thru 1/2 by 16ths

6-Flute Chatterless Countersinks



6-Flute Chatterless Countersinks are easy to use and provide the best finish. They quickly form an 82° countersink in a variety of materials allowing flat head fasteners to mount flush for a professional finish.

- **Special Hi-Molybdenum tool steel construction, gold surface treated** for maximum lubricity.
- **Unique 6-flute chatterless design has staggered cutting angles** to eliminate the harmonics that cause chatter in conventional tools – provides a more comfortable operation for users and a smoother finish in a wide variety of materials – saving user fatigue and time in finishing.
- **6-Flute design distributes the cutting load over six cutting edges** allowing edges to stay sharper longer to provide longer service life saving time and money.
- **Ideal for use on** hand tools, drill presses, milling machines and lathes.
- **Made in the USA**



IBS No.	Size	For Screw Size	Shank	IBS No.	Size	For Screw Size	Shank
19380	1/4	#4	1/4" Shank	19385	3/4	3/8	1/2" Shank
19381	5/16	#6		19386	7/8	7/16	
19382	3/8	#8, #10		19387	1	1/2	
19383	1/2	1/4"	3/8" Shank	19388	1-1/4	5/8	3/4" Shank
19384	5/8	5/16		19389	1-1/2	3/4	
19390	1/4 - 1/2 4PC Set 6-Flute Countersinks						



IBS, INCORPORATED

Miscellaneous Drill Bits (P20)

Fluteless Countersinks Deburring Tools

Our IBS high speed steel fluteless countersinks (deburring tools) offer superior quality, unique design and outstanding performance, yielding excellent workpiece finish. Designed for use in a wide variety of materials, including metal, plastic and wood. These tools can be easily sharpened by use of a small mounted grinding wheel inserted in the hole.



- Chatterless finish
- Single cutting edge for fast stock removal
- Free-cutting
- Easily sharpened
- Ideal for portable use

Fluteless Countersinks - 82° Pilotless, Round Shank

IBS No.	Screw Size	Shank Diameter	Overall Length	Body Diameter	Qty
19300	#4 & #5	1/4	1-1/2	1-7/16	1
19301	#6	1/4	1-1/2	19/64	1
19302	#8	1/4	1-5/8	11/32	1
19303	#10	1/4	1-5/8	25/64	1
19304	#12 & #14	1/4	1-7/8	9/16	1



Fluteless Countersinks - 82° Pilotless, Hex Shank for Portable Drills

IBS No.	Screw Size	Shank Diameter	Overall Length	Body Diameter	Qty
19305	#2, #3, #4	Hex	1-27/32	1/4	1
19306	#5, #6, #8	Hex	2	11/32	1
19307	#10, #12, #14	Hex	2-5/16	9/16	1



Fluteless Countersink Sets



Round Shank Fluteless 5 Pc Countersink Set 82° Pilotless, Round Shank

IBS No.	Set Contains
19310	19300, 19301, 19302, 19303, 19304



Hex Shank Fluteless 3 Pc Countersink Set 82° Pilotless, Hex Shank for Portable Drills

IBS No.	Set Contains
19315	19305, 19308, 19307



D
R
I
L
L
B
I
T
S
E
T
C

IBS, INCORPORATED

Miscellaneous Drill Bits (P20)



Platinum Spiral Flute Step Drills

Drill Twice as Fast as a Straight Flute Step Drill

IBS Platinum Spiral Flute Step Drills cut twice as fast as straight flute step drills, quickly in various sheet materials up to 1/8" thick. Each step drill bit drills a range of sizes. The further the bit advances, the larger the diameter of the hole. Because step drill bits enter the material one step at a time, the operator can drill the desired hole by counting the individual steps, or by using a washer as a simple stop.

The **self-starting tip** eliminates the need for pilot holes.

Applications include: junction boxes, switch boxes, metal studs, electrical applications, lighting fixtures, autobody work, and many other uses.

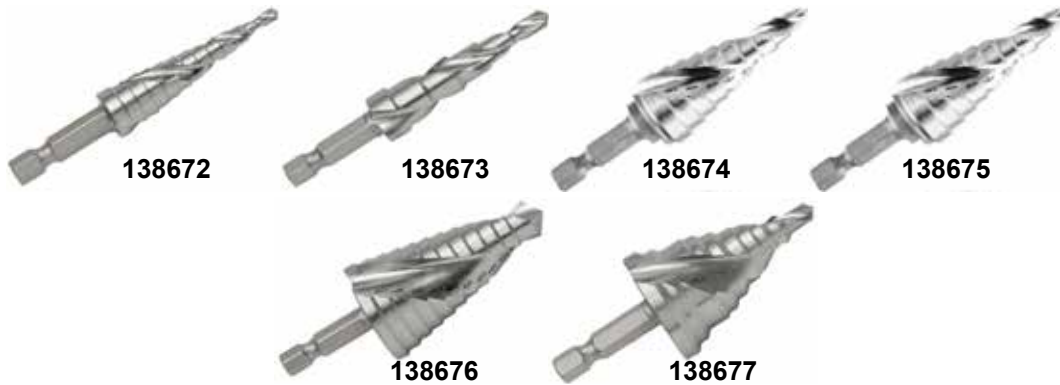

NITRO-CARB STEP DRILLS

IBS No	Description	
138672	1/8-1/2 X 1/32 Platinum Spiral Flute Step Drill	1/4 HEX SHANK 13 HOLES
138673	3/16-1/2 X 1/16 Platinum Spiral Flute Step Drill	1/4 HEX SHANK 6 HOLES
138674	3/16-3/4 X 1/16 Platinum Spiral Flute Step Drill	1/4 HEX SHANK 10 HOLES
138675	3/16-7/8 X 1/16 Platinum Spiral Flute Step Drill	1/4 HEX SHANK 12 HOLES
138676	7/16 -1-1/8 X 1/16 Platinum Spiral Flute Step Drill	1/4 HEX SHANK 12 HOLES
138677	7/8-1-1/8 X 1/4 Platinum Spiral Flute Step Drill	1/2 HEX SHANK 2 HOLES

Platinum Spiral Flute Step Drill Travel Trays

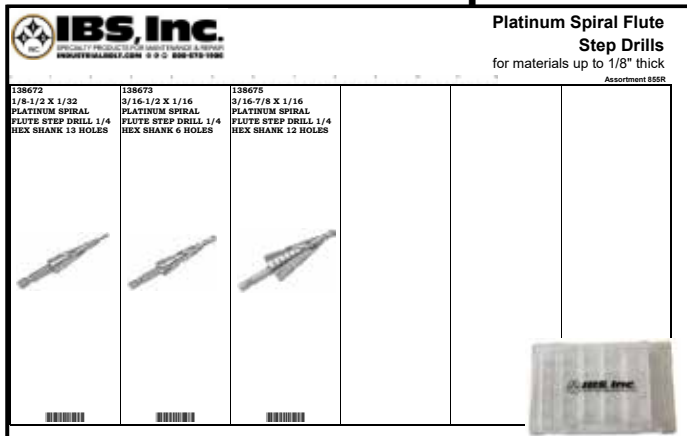

3Pc Spiral Flute Step Drills Starter Set Travel Tray

IBS No. 855R • 3 Items • 3 Pcs

Packaged in a Locking Plastic Travel Tray for Easy Storage & Organization

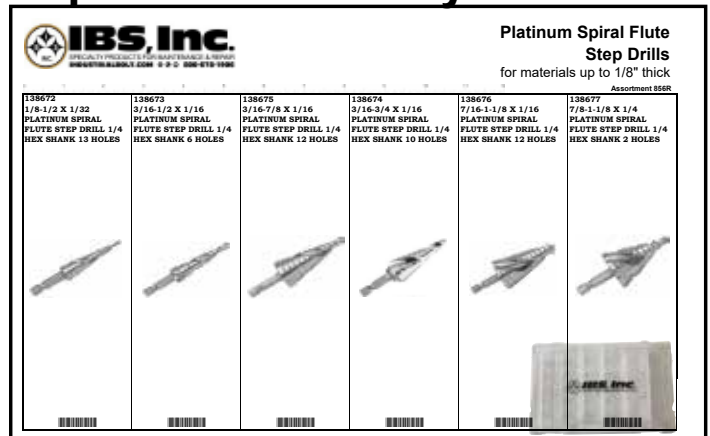

6Pc Spiral Flute Step Drills Travel Tray

IBS No. 856R • 6 Items • 6 Pcs

Packaged in a Locking Plastic Travel Tray for Easy Storage & Organization

D R I L L B I T S E T C



IBS, INCORPORATED

Miscellaneous Drill Bits (P20)

Nitro-Carb Step Drills

Nitro-Carb Step Drills are in a class unto themselves. Nitro-Carb Step Drills include as many as 13 different hole sizes in a single bit, eliminating the need for an entire tool box full of specific sized drill bits. And its built-in differences result in a tool that cuts faster and cleaner and gives a true, round hole every time.

- **Double Flute Design** — Means faster cutting action producing a hole quickly and efficiently saving time and money.
- **Multiple Stepped for Your Multiple Drilling Needs** — includes as many as 13 different hole sizes in a single bit, eliminating the need for specific sized drill bits.
- **Proper hole size** is achieved by counting the steps as they penetrate the work and stopping the pressure when the desired hole size is reached.
- **Deburring is Automatic** once the proper hole diameter is attained, the hole is automatically deburred by the cutting edge of the next larger step.
- **Hardened steel for long life** - each Nitro-Carb Step Drill is constructed of industrial grade high speed molybdenum steel, heat-treated to a Rockwell of between 61 and 63 on the "C" scale and tempered to assure maximum strength for long life.
- **Self-Centering Split Point Tip** - the split point virtually eliminates skidding and the need for center punching; the tip gives sure starts even on curved surfaces such as pipe and conduit.



128672



128673



128674



128675



128676



128677

NITRO-CARB STEP DRILLS

Unibit Size #	IBS Size #	IBS No.	No. of Holes	Hole	Increments	Shank	
#1	#1	128672	13	1/8 - 1/2	1/32	1/4 Hex	
#4	#2	128673	6	3/16 - 1/2	1/4	1/4 Hex	
#3	#3	128674	9	1/4 - 3/4	1/16	1/4 Hex	
#8	#4	128675	12	3/16 - 7/8	1/16	1/4 Hex	
#12	#5	128676	10	1/4 - 1-3/8	1/8	3/8 w/Flats	
#2	#29	128677	13	1/4 - 1	1/16	3/8 w/Flats	
—	—	128686	3 Pc Set: #1, #2, #4				
—	—	749R	6 Pc Set: #1, #2, #3, #4, #5, #29				



IBS No. 128686

3 Piece Set Contains:

- (128672) 1/8-1/2
- (128673) 3/16-1/2
- (128675) 3/16-7/8

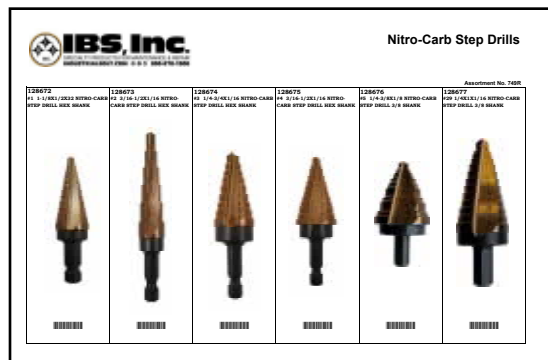

Nitro-Carb Step Drill Travel Tray

IBS No. 749R • 6 Items • 6 Pcs

Contains all 6 sizes packaged in an adjustable compartment small plastic travel tray for easy storage and organization.

RECOMMENDED DRILL SPEEDS

Hole Size	RPM
Up to 1/4	1500 — 1750
1/4 — 1/2	1000 — 1250
1/2 — 3/4	500 — 1000
3/4 — 1	300 — 500

IBS, INCORPORATED

Step Reamers (P17)



Step Reamers

**THE FASTEST AND EASIEST WAY TO ENLARGE HOLES IN MATERIALS UP TO 1/2" THICK!
INCREDIBLY FAST AND ACCURATE!**



- **GOLD OXIDE COATING** enhances lubricity, reduces friction, and increases toughness.
- **SIZES ARE ETCHED INSIDE THE FLUTES** which will last longer and allow users to read the sizes even after use.
- **MADE OF M2 HSS TOOL STEEL** for optimum performance in tough metals — means it stays sharper longer, saving time and money.
- **1/2" SHANK WITH 3 FLATS ON THE SHANK** allows easy positive chuck grip, eliminating spinning or slipping in the chuck for safety, and speed — great for keyless chucks!
- **EACH REAMER HAS 5 STEPS IN 1/16" INCREMENTS** — 3 Step Reamers can replace 15 reamers, which saves money in inventory.
- **CHAMFER ON EACH STEP** — deburs the cut for a perfectly finished hole every time, eliminating sharp edges for a safer finish, saving time and money.
- **Full 1/2" cutting depth** for use in thicker material than standard step drills for more versatility in more applications.



STEP REAMERS

IBS No.	Description	Qty.
18531	5/16 to 9/16 Step Reamer	1
18532	9/16 to 13/16 Step Reamer	1
18533	13/16 to 1-1/16 Step Reamer	1
18534	3 Pc Step Reamer Set	1



3 Pc STEP REAMER SET
(5/16 to 1-1/16)
IBS No. 18534

D R I L L B I T S E T C



IBS, INCORPORATED

Nitro-Carb Spiral Reamers (P17)

Platinum Series Spiral Reamers

STRAIGHT SHANK, LEFT HAND HELIX, RIGHT HAND CUT, COLLAR STOP HSS

"PLATINUM SERIES — THE PROOF IS IN THE PERFORMANCE"



D
R
I
L
L
B
I
T
S
E
T
C

- **M7 TOOL STEEL & NOMO COATING** equip this reamer to cut stainless steel and tough alloys. An exclusive combination of high speed steel, superior geometry, and our unique NOMO treatment (Nitride on Margin Only) make short work of enlarging holes in framework and structural steel.
- **FITS INTO SMALL HOLES** smaller diameter allows the user to enlarge much smaller holes to desired diameter, reducing the need for progressively larger tools. Ideal for harder to cut metals such as stainless steel.
- **TAPER ANGLE DESIGN** distributes cutting forces along the edges. Multiple tapered cutting edges evenly distribute the cutting load for effortless reaming, resulting in less damage and replacement costs.
- **SAFE TO USE** — Flutes of the reamer turn in a forward (down and away) direction, so chips are safely ejected away from the operator.
- **HSS SAFETY COLLAR** prevents over penetration for safety and accuracy.

Applications:

Industrial applications include steel erection, automotive, truck and trailer manufacturing.

Ideal for:

- Enlarging misaligned holes
- Fuel tank mounting
- Truck frame drilling
- Tool box & accessory mounting
- Spring hangers
- Trailer hitch, 5th wheel & tow hook mounting

IBS, INCORPORATED

Nitro Carb Spiral Reamers (P17)



Platinum Series Spiral Reamers

STRAIGHT SHANK, LEFT HAND HELIX, RIGHT HAND CUT, COLLAR STOP HSS
"PLATINUM SERIES — THE PROOF IS IN THE PERFORMANCE"

Engineered exclusively to enlarge and align existing holes; especially in tight spots. The ideal maintenance reamer.

- Three flats on the shank — allows for strong positive chuck grip and eliminates slippage in the chuck.
- Gold surface treated for additional lubricity for cooler operation and longer life.
- Effortlessly fits into small holes
- Quickly aligns structural steel
- Deburs welded & punched holes
- Cuts stainless steel and tough alloys
- Fits most power tools
- Ideal for maintenance and repair

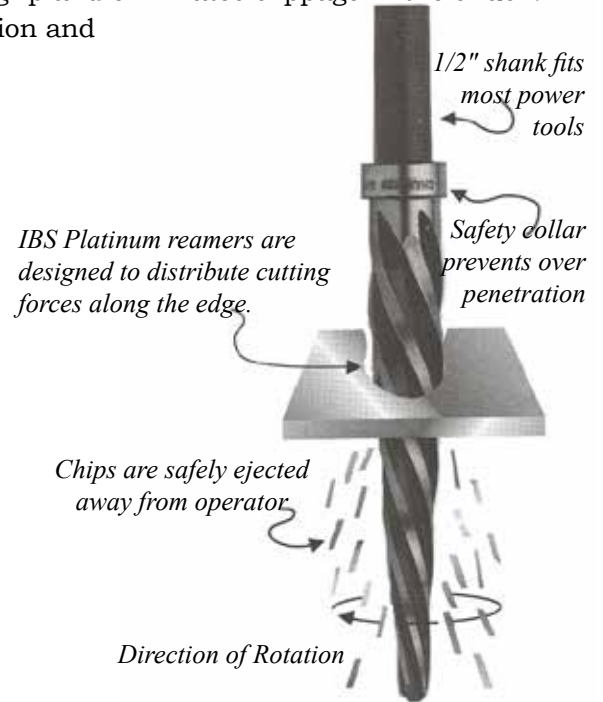

IBS No.	Dia.	Shank Dia	Decimal Equivalent	No. of Flutes	Point Dia.	Flute Length	Overall Length	Pilot Drill	Drill No.
18501	1/4	1/4	.2500	4	.195	2-5/16	4	3/16	16808
18502	5/16	5/16	.3125	4	.215	3	4-5/8	17/64	16813
18503	3/8	3/8	.3750	4	.250	3	4-5/8	5/16	16816
18504	7/16	7/16	.4375	4	.250	3-1/4	5-7/8	3/8	16820
18505	1/2	1/2	.5000	5	.281	3-15/16	5-7/8	3/8	16820
18506	9/16	1/2	.5625	5	.343	3-15/16	5-7/8	7/16	16824
18507	5/8	1/2	.6250	5	.343	4-1/2	6-3/8	7/16	16824
18510	3/4	1/2	.7500	5	.406	4-15/16	6-3/8	1/2	16828
18513	7/8	1/2	.8750	5	.500	5-3/16	6-3/8	19/32	16838
18515	1	1/2	1.0000	5	.719	5-3/16	6-3/8	7/8	16856

SETS

18517 4 Pc Platinum Spiral Reamer Set (5/16, 3/8, 7/16, & 1/2) P15

18518 4 Pc Platinum Spiral Reamer Set (3/8, 1/2, 5/8, & 3/4) P15



4 Pc Platinum Spiral Reamer Set
 (5/16, 3/8, 7/16, & 1/2)
 IBS No. 18517



4 Pc Platinum Spiral Reamer Set
 (3/8, 1/2, 5/8 & 3/4)
 IBS No. 18518

D R I L L B I T S E T C



IBS, INCORPORATED

Nitro Carb Spiral Reamers (P17)

Nitro-Carb Hole Hog Reamers Hole Enlargers Hole Hog™ Super Premium Core Drills



Made of special Hi-Molybdenum tool steel, these reamers feature a gold surface treated body and clearance for maximum lubricity, close tolerance construction, three flats on the shank and four flutes. They are designed exclusively to enlarge existing holes.

This high performance tool is designed to enlarge existing holes by as much as 160% of the existing hole's diameter. The four flute design and modified "Hole Hog" point prevent the catching and hogging-in commonly experienced when standard S&D drills break through thinner material such as truck frames. The flattened 1/2" shank makes this tool extremely useful in portable drilling.

HOLE HOG REAMERS 4-5/16" Overall Length, 1-7/8 Flute Length

IBS No.	Diameter (in.)	Pilot Drill	Qty
18524	3/8	1/4	1
18526	1/2	5/16	1
18528	5/8	25/64	1
18530	3/4	15/32	1

Hole Hog Reamer / Pilot Drill Sets (P15)

These sets contain the reamers described above and mechanics length Nitro-Carb drill bit in a metal index. The reamers have flats along the shank for ease of use with portable drilling.



HOLE HOG REAMER SETS w/Drill Bits Made from Special High Molybdenum Tool Steel

IBS No.	# of Pcs	Reamer Sizes included	Drill Sizes included
18521	8 Pc	3/8, 1/2, 5/8, 3/4	1/4, 5/16, 25/64, 15/32
18522	6 Pc	3/8, 1/2, 5/8	1/4, 5/16, 25/64
18523	6 Pc	1/2, 5/8, 3/4	5/16, 25/64, 15/32

D
R
I
L
L
B
I
T
S
E
T
C

IBS, INCORPORATED

High Speed Taps (P08)



IBS Nitro Carb "DRAPS"



- Made of **Hi-Molybdenum tool steel** for longer tool life.
- **3 Flats on the Shank** reduces slippage and provides for faster tool changes and alignment in keyless chuck.
- **Ground threads** and a **plug lead tap** design allows for smooth entry, easy tapping and excellent thread finish.
- **Black & Gold surface treatment** reduces friction, holds lubricant and provides improved chip removal resulting in cooler cutting and extended life.
- **135° Split Point** allows easier starts and higher speed drilling, eliminating the need for a center punch or pilot hole.
- **Longer drill point** allows for use in thicker materials.

DRAPS - NC

IBS No.	Thread Size	Max Material Thickness	Thread Length
17150	4-40	0.368	0.564
17151	6-32	0.468	0.376
17152	8-32	0.539	0.376
17153	10-24	0.606	0.496
17154	12-24	0.677	0.496
17155	1/4-20	0.746	0.626
17156	5/16-18	0.889	0.683
17157	3/8-16	1.031	0.746
17158	7/16-14	1.172	0.882
17159	1/2-13	1.378	0.940

DRAPS - NF

IBS No.	Thread Size	Max Material Thickness	Thread Length
17173	8-36	0.540	0.376
17160	10-32	0.608	0.496
17161	1/4-28	0.750	0.626
17162	5/16-24	0.893	0.683
17163	3/8-24	1.036	0.746
17164	7/16-20	1.178	0.880
17165	1/2-20	1.384	0.940

DRAPS - METRIC

IBS No.	Thread Size	Max Material Thickness	Thread Length
17166	M3-.5	0.403	0.624
17167	M4-.7	0.538	0.376
17168	M5-.8	0.610	0.496
17169	M6-1.0	0.746	0.626
17170	M8-1.25	0.892	0.686
17171	M10-1.5	1.037	0.746
17172	M12-1.75	1.373	0.942

6 Pc Coarse Machine Screw Nitro Carb Tap Set IBS No. 17175

Contains sizes: 6-32, 8-32, 10-24, 10-32, 12-24, 1/4-20 packaged in a locking plastic case for easy storage and organization



7 Pc Fine Thread Nitro Carb Tap Set IBS No. 17176

Contains sizes: 8-36, 10-32, 1/4-28, 5/16-24, 3/8-24, 7/16-20, 1/2-20 packaged in a folding cloth pouch for easy storage and organization.



7 Pc Coarse Thread Nitro Carb Tap Set IBS No. 17177

Contains sizes: 8-32, 10-24, 1/4-20, 5/16-18, 3/8-16, 7/16-14, 1/2-13 packaged in a folding cloth pouch for easy storage and organization.



6 Pc Machine Screw Nitro Carb Tap Travel Tray IBS No. 17178

Contains sizes: 8-32, 10-24, 12-24, 1/4-20, 5/16-18, 3/8-16 packaged in a locking plastic travel tray for easy storage and organization.



6 Pc Metric Nitro Carb Tap Travel Tray IBS No. 17179

Contains sizes: M4, M5, M6, M8, M10, M12 packaged in a locking plastic travel tray for easy storage and organization.



D R I L L B I T S E T C

Sold in quantities of (1)



IBS, INCORPORATED

Technical Information

Speeds and Feeds for Drill Bits

The speed of a drill bit is usually measured in terms of the rate at which the outside or periphery of the tool moves in relation to the work being drilled. The common term for this is Surface Feet per Minute (SFM). The relation of SFM and Revolutions per Minute (RPM) is indicated by the following formula:

$$\text{RPM} = 3.8 \quad \times \quad \left[\frac{\text{SFM}}{\text{Drill Diameter in inches}} \right]$$

The most economical speed for operating a drill bit will depend on variables, some of which are:

1. Composition and hardness of material being drilled.
2. Depth of the hole being drilled.
3. Use of cutting fluids.
4. Type and condition of drilling equipment.
5. Quality of holes desired.

Speeds shown in the accompanying table of cutting speeds include a range in feet per minute. In most drilling situations it is usually better to start with a slower speed and build up to the maximum after a trial hole may indicate the drill bit can be run faster.

The following information provides widely recommended drill bit speeds in feet per minute for a wide range of materials. These speeds give the user a good starting point but may be adjusted to slower or faster depending on the variables listed previously and the resulting performance. The optimum speed must be established through trial.

Standard drill bit feed information is provided below to help establish the proper feed rate of different diameters. This is particularly useful when a drill press, etc. is being used.

Drill Bit Feeds

DIAMETER OF DRILL BIT (INCHES)	NORMAL FEED	HEAVY FEED
from 1/16 to 1/8	.001 -.002	.002 -.004
over 1/8 to 1/4	.002 -.004	.004 -.008
over 1/4 to 1/2	.004 -.008	.008 -.016
over 1/2 to 1	.008 -.016	.016 -.024
over 1	.016 -.024	.024 -.032

The following charts convert surface feet per minute to revolutions per minute for fractional, letter and number drills. To use these charts, locate the drill bit diameter to be used on the left side of the chart and the desired surface feet per minute at the top (reference the following chart for the material to be drilled). The point where the two columns meet will give you a good guide regarding the revolutions per minute to be used as a starting point.

D
R
I
L
L
B
I
T
S
E
T
C



Surface Cutting Speeds For Various Materials

Reference the chart below to determine the proper surface speed for use in the following charts.

Material	Speed: Ft/Min	Material	Speed: Ft/Min
Aluminum & its alloys	40 to 50	Bakelite	90 to 100
Common brass and bronze	200 to 300	Allegheny metal	40 to 50
High Tensile Bronze	70 to 150	Manganese copper	20 to 30
Magnesium and its alloys	250 to 400	Chromalloy	40 to 50
Plastics	100 to 150	Magnet steel (soft)	40 to 50
Plastics containing glass fibers	70 to 90	Tool steel (RB80)	40 to 60
Formica	70 to 100	Tool steel (RB 32-34)	40 to 50
Hardwoods	300 to 400	Nitralloy 135	50 to 60
Die Castings (zinc base)	300 to 400	Waspalloy	12 to 15
Copper	70 to 100	Crucible HY-Tuf (AMS 6418)	15 to 25
Automotive steel forgings	40 to 50	Crucible UHS 260	7 to 15
Nickel steel (3/2%)	20 to 50	Timken HS 220	15 to 25
Spring Steel	30 to 40	Inco Tricent	10 to 20
Mild steel (2. - .3 carbon)	80 to 110	Vascojet X4 and 1000	7 to 15
Medium Steel (.4 - .5 carbon)	70 to 80	Thermold J	7 to 15
Alloy Steel-Manganese (7-13%)	30 to 40	Trinidur	12 to 15
Molybdenum steel	60 to 70	Discalloy AMS 5733	12 to 15
Monel	50 to 60	Vitallium	10 to 12
Titanium (RC 32 - RC 34)	20 to 50	Udimet 500	12 to 15
Tool steel (anneled 1.2 carbon)	20 to 50	Iconel 700	7 to 15
Permalloy (77% nickel)	50 to 60	Rene 41	7 to 15
Soft cast iron	100 to 150	Armco (17-4 PH and 17-7 PH)	15 to 20
Medium hard cast iron	70 to 100	Iconet AMS 5685	10 to 12
Hard Cast Iron	30 to 70	SAE 4340, 4360 & AMS 6415	7 to 15
Malleable iron	80 to 90	USS STRUX - MOD 98BV40	7 to 15
Stainless steel 200 series	50 to 70	SAE 4330 - Mod. AMS 6407	15 to 25
18-8 stainless steel & 300 series	20 to 60	H-11 AMS 6485	7 to 15
Stainless steel 400 series	20 to 60	A 286 AMS 5736	15 to 20
Zamak	200 to 300	S-816AMS 5765	12 to 15
Hard rubber	90 to 100		

D R I L L B I T S E T C



IBS, INCORPORATED

Technical Information

Fractional Drill Cutting Speeds in RPM

D
R
I
L
L
B
I
T
S
E
T
C

Drill	Feet Per Minute														
	10	12	15	20	25	30	35	40	45	50	60	70	80	90	100
1/64	2445	2934	3667	4889	6112	7334	8556	9778	11001	12223	14668	17112	19557	22001	24446
1/32	1222	1467	3667	2445	3056	3667	4278	4889	5500	6112	7334	8556	9778	11001	12223
3/64	815	978	1833	1630	2037	2445	2852	3259	3667	4074	4889	5704	6519	7334	8149
1/16	611	733	1222	1222	1528	1833	2139	2445	2750	3056	3667	4278	4889	5500	6112
5/64	489	587	917	978	1222	1467	1711	1956	2200	2445	2934	3422	3911	4400	4889
3/32	407	489	733	815	1019	1222	1426	1630	1833	2037	2445	2852	3259	3667	4074
7/64	349	419	611	698	873	1048	1222	1397	1572	1746	2095	2445	2794	3143	3492
1/8	306	367	524	611	764	917	1070	1222	1375	1528	1833	2139	2445	2750	3056
9/64	272	326	458	543	679	815	951	1086	1222	1358	1630	1901	2173	2445	2716
5/32	244	293	407	489	611	733	856	978	1100	1222	1467	1711	1956	2200	2445
11/64	222	267	367	444	556	667	778	889	1000	1111	1333	1556	1778	2000	2222
3/16	204	244	333	407	509	611	713	815	917	1019	1222	1426	1630	1833	2037
13/64	188	226	306	376	470	564	658	752	846	940	1128	1316	1504	1692	1880
7/32	175	210	282	349	437	524	611	698	786	873	1048	1222	1397	1572	1746
15/64	163	196	262	326	407	489	570	652	733	815	978	1141	1304	1467	1630
1/4	153	183	244	306	382	458	535	611	688	764	217	1070	1222	1275	1528
9/32	136	163	229	272	340	407	475	543	611	679	815	951	1086	1222	1358
5/16	122	147	204	244	306	367	428	489	550	611	733	856	978	1100	1222
11/32	111	133	183	222	278	333	389	444	500	556	667	778	889	1000	1111
7/16	87	105	167	175	218	262	306	349	393	437	524	611	698	786	873
15/32	81	98	131	163	204	244	285	326	367	407	489	570	652	733	815
1/2	76	92	122	153	191	229	267	306	344	382	458	535	611	688	764
9/16	68	81	115	136	170	204	238	272	306	340	407	475	543	611	679
5/8	61	73	102	122	153	183	214	244	275	306	367	428	489	550	611
11/16	56	67	92	111	139	167	194	222	250	278	333	389	444	500	556
3/4	51	61	83	102	127	153	178	204	229	255	306	357	407	458	509
13/16	47	56	76	94	118	141	165	188	212	235	282	329	376	423	470
7/8	44	52	71	87	109	131	153	175	1965	218	262	306	349	393	437
15/16	41	49	65	81	102	122	143	163	183	204	244	285	326	367	407
1	38	46	57	76	95	115	134	153	172	191	229	267	306	344	382



Letter Drill Cutting Speeds in RPM

Drill	Feet Per Minute														
	10	12	15	20	25	30	35	40	45	50	60	70	80	90	100
A	163	196	245	326	408	490	571	653	735	818	982	1145	1309	1472	1636
B	160	193	241	321	401	481	562	642	722	803	963	1124	1284	1445	1605
C	158	189	237	316	395	473	552	631	710	789	947	1105	1292	1420	1578
D	155	186	233	311	388	466	543	621	699	778	937	1089	1245	1400	1556
E	153	183	229	306	386	458	535	611	687	764	917	1070	1222	1375	1528
F	149	178	223	297	372	446	520	595	669	778	934	1089	1245	1400	1556
G	146	176	220	293	366	439	512	585	659	732	878	1024	1170	1317	1463
H	144	172	215	287	359	431	503	574	646	718	862	1005	1149	1292	1436
I	140	169	211	281	351	421	492	562	632	702	842	983	1123	1264	1404
J	138	165	207	276	345	414	483	552	621	690	827	965	1103	1241	1379
K	136	163	204	272	340	408	476	544	612	680	815	951	1087	1223	1359
L	132	158	198	263	329	395	461	527	593	659	790	922	1054	1185	1317
M	129	155	194	259	324	388	453	518	583	648	777	907	1036	1166	1295
N	126	152	190	253	316	379	442	506	569	633	759	886	1012	1139	1265
O	121	145	181	242	302	363	423	484	544	605	725	846	967	1088	1209
P	118	142	177	237	296	355	414	473	532	592	710	828	946	1065	1183
Q	115	138	173	230	288	345	403	460	518	575	690	805	920	1035	1150
R	113	135	169	225	282	338	394	451	507	564	676	789	902	1014	1127
S	110	132	135	220	274	329	384	439	494	549	659	769	878	988	1098
T	107	128	160	213	267	320	373	427	480	533	640	746	853	959	1066
U	104	125	156	208	259	311	363	415	467	519	623	727	830	934	1038
V	101	122	152	203	253	304	355	405	456	507	608	709	810	912	1013
W	99	119	148	198	247	297	346	396	445	495	594	693	792	891	989
X	96	115	144	192	240	289	337	385	433	481	576	672	769	865	962
Y	95	113	142	189	236	284	331	378	425	473	567	662	756	851	945
Z	92	111	139	185	231	277	324	370	416	462	555	647	740	832	925

D
R
I
L
L
B
I
T
S
E
T
C

NOTE: For speeds higher than tabulated, multiply all values by ten and for speeds lower divide by ten.



IBS, INCORPORATED

Technical Information

Number Drill Cutting Speeds in RPM

D
R
I
L
L
B
I
T
S
E
T
C

Drill	Feet Per Minute														
	10	12	15	20	25	30	35	40	45	50	60	70	80	90	100
1	168	201	251	335	419	503	586	670	754	838	1005	1173	1340	1508	1675
2	173	207	259	346	432	519	605	691	778	864	1037	1210	1382	1555	1728
3	179	215	269	359	448	538	628	717	807	897	1076	1255	1434	1614	1793
4	183	219	274	366	457	548	640	731	822	914	1097	1280	1462	1645	1828
5	186	223	279	372	465	558	651	743	836	930	1115	1301	1487	1673	1859
6	187	225	281	374	468	562	655	749	843	936	1123	1310	1498	1685	1872
7	190	228	285	380	475	570	665	760	855	950	1140	1330	1520	1710	1900
8	192	230	288	384	480	576	672	768	864	960	1151	1343	1535	1727	1919
9	195	234	292	390	487	585	682	780	877	975	1169	1364	1559	1754	1949
10	197	237	296	385	494	592	691	790	888	987	1184	1382	1579	1777	1974
11	200	240	300	400	500	600	700	800	900	1000	1200	1400	1600	1800	2000
12	202	243	303	404	505	606	707	808	909	1010	1213	1415	1617	1819	2021
13	206	248	310	413	516	619	723	826	929	1032	1239	1450	1652	1859	2065
14	210	252	315	420	525	630	735	839	944	1050	1259	1469	1679	1889	2099
15	212	255	318	424	531	637	743	849	955	1064	1276	1489	1802	1914	2127
16	216	259	324	432	540	647	755	863	971	1079	1295	1511	1726	1942	2158
17	221	265	331	442	552	662	773	883	994	1104	1325	1546	1766	1987	2208
18	225	270	338	451	563	676	789	901	1014	1130	1356	1582	1808	2034	2260
19	230	276	345	460	575	690	805	920	1035	1151	1381	1611	1841	2071	2301
20	237	285	356	474	593	712	830	949	1068	1186	1423	1660	1898	2135	2372
21	240	288	360	480	601	721	841	961	1081	1201	1441	1681	1922	2162	2402
22	243	292	365	487	608	730	852	973	1095	1217	1460	1703	1946	2190	2433
23	248	298	372	496	620	744	868	992	1116	1240	1488	1736	1984	2232	2480
24	251	302	377	503	628	754	880	1005	1131	1257	1508	1759	2010	2262	2513
25	255	307	383	511	639	766	894	1022	1150	1276	1533	1789	2044	2300	2555
26	260	312	390	520	650	780	909	1039	1169	1299	1559	1819	2078	2338	2598
27	265	318	398	531	663	796	928	1061	1194	1327	1592	1857	2122	2388	2653
28	272	326	408	544	680	816	952	1087	1223	1360	1631	1903	2175	2447	2719
29	281	337	421	562	702	843	983	1123	1264	1405	1685	1966	2247	2528	2809
30	297	357	446	585	743	892	1040	1189	1338	1487	1784	2081	2378	2676	2973
31	318	382	477	637	796	955	1114	1273	1432	1592	1910	2228	2546	2865	3183
32	329	395	494	659	823	988	1153	1317	1482	1647	1976	2305	2634	2964	3293
33	338	406	507	676	845	1014	1183	1352	1521	1690	2028	2366	2704	3042	3380
34	344	413	516	688	860	1032	1204	1376	1549	1721	2065	2409	2753	3097	3442
35	347	417	521	694	886	1042	1215	1389	1563	1736	2088	2430	2778	3125	3472
36	359	430	538	717	898	1076	1255	1435	1614	1794	2152	2511	2870	3228	3587
37	367	441	551	735	918	1102	1285	1469	1653	1837	2204	2571	2938	3006	3673
38	376	452	564	753	941	1129	1317	1505	1693	1882	2258	2634	3010	3387	3763
39	384	461	576	768	960	1152	1344	1536	1728	1920	2303	2687	3071	3455	3839
40	390	468	585	780	974	1169	1364	1559	1754	1949	2339	2729	3118	3508	3898



Metric Drill Cutting Speeds in RPM

Drill	Feet Per Minute					
	20	30	50	70	80	100
0.5	3878	5817	9695	13573	15512	19389
1.0	1939	2908	4847	6786	7756	9695
1.5	1293	1939	3232	4524	5171	6463
2.0	971	1456	2427	3397	3883	4854
2.5	776	1165	1941	2717	3105	3882
3.0	647	970	1617	2264	2587	3234
3.5	554	832	1386	1940	2218	2772
4.0	485	728	1213	1698	1940	2425
4.5	431	647	1078	1509	1724	2156
5.0	388	582	970	1359	1552	1940
6.0	323	485	809	1132	1294	1617
7.0	277	415	693	970	1109	1386
8.0	243	364	605	849	970	1213
9.0	216	323	539	755	832	1075
10.0	194	291	485	679	776	970
11.0	176	265	441	617	706	882
12.0	162	243	404	566	647	809
13.0	149	224	373	522	597	749
14.0	139	208	346	485	554	693
15.0	129	194	323	453	517	647
16.0	121	182	303	424	485	606
17.0	114	171	285	399	457	571
18.0	108	162	269	377	431	539
19.0	102	153	255	357	409	511
20.0	97	146	243	340	388	485
22.0	88	132	221	309	353	441
24.0	81	121	202	283	323	404
26.0	75	112	187	261	299	373
28.0	69	104	173	243	277	346
30.0	65	97	162	226	259	323

NOTE: For speeds higher than tabulated, multiply all values by ten and for speeds lower divide by ten.

SUGGESTIONS FOR MAXIMUM DRILL PERFORMANCE

1. **A reduced speed is recommended to start the drill.**
2. **The harder the material the slower the speed.**
3. **The larger the diameter the slower the speed.**
4. **Do not force feed. Let the drill cut at its own pace.**
5. **Once the bore is started, either keep the drill cutting or remove it. Idling of the cutting edge will harden the steel and dull the bit.**
6. **At the point of break-through, lighten the feed pressure.**
7. **Avoid side pressure on the drill bit whenever possible.**

D
R
I
L
L

B
I
T
S

E
T
C



IBS, INCORPORATED

Technical Information

Decimal Equivalent Chart For Drill Sizes

D
R
I
L
L
B
I
T
S
E
T
C

Drill Size	mm	Dec. In.	Drill Size	mm	Dec. In.	Drill Size	mm	Dec. In.	Drill Size	mm	Dec. In.
—	0.10	.0039	45	2.08	.0820	5	5.22	.2055	7/16	11.11	.4375
—	0.20	.0079	44	2.18	.0860	4	5.31	.2090	29/64	11.51	.4531
—	0.25	.0098	43	2.26	.0890	3	5.41	.2130	15/32	11.91	.4688
—	0.30	.0118	42	2.37	.0935	7/32	5.58	.2188	—	12.00	.4724
80	0.34	.0135	3/32	2.38	.0938	2	5.61	.2210	31/64	12.30	.4844
79	0.37	.0145	41	2.44	.0960	1	5.79	.2280	1/2	12.70	.5000
1/64	0.40	.0156	40	2.50	.0980	A	5.94	.2340	—	13.00	.5118
78	0.41	.0160	39	2.53	.0995	15/64	5.95	.2344	33/64	13.10	.5156
77	0.46	.0180	38	2.58	.1015	—	6.00	.2362	17/32	13.49	.5312
—	0.50	.0197	37	2.64	.1040	B	6.05	.2380	35/64	13.89	.5469
76	0.51	.0200	36	2.71	.1065	C	6.15	.2420	—	14.00	.5512
75	0.53	.0210	7/64	2.78	.1094	D	6.25	.2460	9/16	14.29	.5625
74	0.57	.0225	35	2.70	.1100	1/4	6.35	.2500	37/64	14.68	.5781
—	0.60	.0236	34	2.82	.1110	E	6.35	.2500	—	15.00	.5906
73	0.61	.0240	33	2.87	.1130	F	6.53	.2570	19/32	15.08	.5938
72	0.64	.0250	32	2.95	.1160	G	6.63	.2610	39/64	15.48	.6094
71	0.66	.0250	—	3.00	.1181	17/64	6.75	.2656	5/8	15.88	.6250
—	0.70	.0276	31	3.05	.1200	H	6.76	.2660	—	16.00	.6299
70	0.71	.0280	1/8	3.18	.1250	I	6.91	.2720	41/64	16.27	.6406
69	0.74	.0292	30	3.26	.1285	—	7.00	.2756	21/32	16.67	.6562
—	0.75	.0295	29	3.45	.1360	J	7.04	.2770	—	17.00	.6693
68	0.79	.0310	28	3.57	.1405	K	7.14	.2810	43/64	17.07	.6719
1/32	0.79	.0313	9/64	3.57	.1406	9/32	7.14	.2812	11/16	17.46	.6875
—	0.80	.0315	27	3.65	.1440	L	7.37	.2900	45/84	17.86	.7031
67	0.81	.0320	26	3.73	.1470	M	7.40	.2950	—	18.00	.7087
66	0.84	.0330	25	3.80	.1495	19/64	7.54	.2969	23/32	18.26	.7188
65	0.89	.0350	24	3.86	.1520	N	7.67	.3020	47/64	18.65	.7344
—	0.90	.0354	23	3.91	.1540	5/16	7.94	.3125	—	19.00	.7480
64	0.91	.0360	5/32	3.97	.1562	—	8.00	.3150	3/4	19.05	.7500
63	0.94	.0370	22	3.99	.1570	O	8.03	.3160	49/64	19.45	.7656
62	0.97	.0380	—	4.00	.1575	P	8.20	.3230	25/32	19.84	.7812
61	0.99	.0390	21	4.04	.1500	21/64	8.33	.3281	—	20.00	.7874
—	1.00	.0394	20	4.09	.1610	Q	8.43	.3320	51/64	20.24	.7969
60	1.02	.0400	19	4.22	.1660	R	8.61	.3390	13/16	20.64	.8125
59	1.04	.0410	18	4.31	.1695	11/32	8.73	.3438	—	21.00	.8268
58	1.07	.0420	11/64	4.37	.1719	S	8.84	.3480	53/64	21.02	.8281
57	1.09	.0430	17	4.39	.1730	—	9.00	.3543	27/32	21.43	.8438
56	1.18	.0465	16	4.50	.1770	T	9.09	.3580	55/64	21.84	.8594
3/64	1.19	.0469	15	4.57	.1800	23/64	9.13	.3594	—	22.00	.8861
55	1.32	.0520	14	4.62	.1820	U	9.35	.3680	7/8	22.23	.8750
54	1.40	.0550	13	4.70	.1850	3/8	9.53	.3750	57/64	22.62	.8906
53	1.51	.0595	3/16	4.76	.1875	V	9.55	.3770	—	23.00	.9055
1/16	1.59	.0625	12	4.80	.1890	W	9.80	.3860	29/32	23.02	.9062
52	1.61	.0635	11	4.85	.1910	25/64	9.92	.3906	59/64	23.42	.9219
51	1.70	.0670	10	4.91	.1935	—	10.00	.3937	15/16	23.81	.9375
50	1.78	.0700	9	4.98	.1960	X	10.08	.3970	—	24.00	.9449
49	1.85	.0730	—	5.00	.1968	Y	10.26	.4040	61/64	24.21	.9531
48	1.93	.0760	8	5.05	.1990	13/32	10.32	.4062	31/32	24.61	.9688
5/64	1.98	.0781	7	5.11	.2010	Z	10.40	.4130	—	25.00	.9842
47	1.99	.0785	13/64	5.16	.2031	27/64	10.72	.4219	63/64	25.00	.9844
—	2.00	.0787	6	5.18	.2040	—	11.00	.4331	1	25.40	1.000
46	2.06	.0810	—	—	—	—	—	—	—	25.50	1.039



NES External Rethreading Tools



An essential tool for anyone who deals with nuts and bolts in: maintenance, construction, garages, plumbing, agriculture and engineering.

- Adjusts automatically to thread diameter & pitch.
- No measuring of thread required.
- Can be used on left and right hand threads.
- Can be used on both inch and metric threads.
- Two hardened steel blades (58RC) guided by the existing thread, regroove the damaged area.

Turn handle (A) to raise floating blades (B).



Place the tool over the thread to be repaired.

Turn handle (A) to lower floating blades into grooves of thread and tighten by hand only.



Turn the NES External fastener repair tool in the direction of the arrow.



NES 1A EXTERNAL TOOL IBS No. 99152

NES 1A	OD	Pipe	L	W	H	R
in.	5/32 to 11/16	up to 7/16	2-3/8	29/32	2-7/16	2-11/16
mm.	4-18		61	23	62	68



NES 2 EXTERNAL TOOL IBS No. 99162

NES 2	OD	Pipe	L	W	H	R
in.	11/16 to 1-1/2	3/8 to 1-1/8	4-1/8	1-1/2	4-5/16	4-5/8
mm.	17-38		105	32	110	117

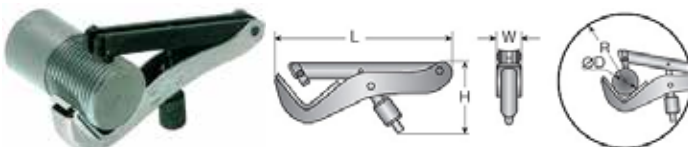

NES 3 EXTERNAL TOOL IBS No. 99163

NES 3	OD	Pipe	L	W	H	R
in.	1-1/4 to 5	1 to 4-1/2	12	1-3/4	5-1/8	9-7/8
mm.	32-128		305	44	130	250

NES Universal Thread Restorer 4 Pc Tool Kit



IBS No.	Description
122254	NES Universal Thread Restorer 4 Pc Tool Kit Contains all three NES Rethreading Tools. Replacement blades and internal thread cleaner tool included.

NES Internal Thread Cleaner / Restoring Tool



IBS No.	Description
122252	NES Internal Thread Cleaner Restoring Tool
122253	NES Internal Thread Cleaner Replacement Blades

NES Replacement Blades



IBS No.	Description
122249	NES1 Replacement Blades
122250	NES2 Replacement Blades
122251	NES3 Replacement Blades

D R I L L B I T S E T C



IBS, INCORPORATED

Tools (T03)

iNES Internal Rethreading Tap



An essential tool for anyone who deals with nuts and bolts in: maintenance, construction, garages, plumbing, agriculture and engineering.

- Adjusts automatically to thread diameter & pitch.
- No measuring of thread required.
- Can be used on left and right hand threads.
- Can be used on both inch & metric threads.
- Hardened steel blade (62RC) guided by the existing threads, regrooves the damaged area.

Turn knurled knob (K) to fully retract the blade (B) into the housing. Insert iNES tool into the threaded hole or bore to be repaired.



Turn knurled knob (K) to extend blade (B) into the thread groove on an undamaged section and tighten by hand only.



Rotate the iNES internal fastener repair tool by the cross rod, as shown, in the desired direction.

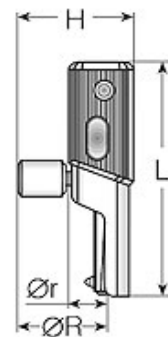
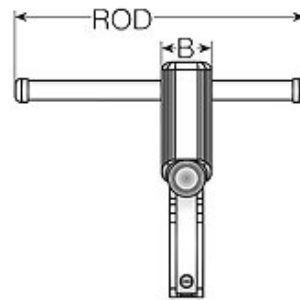

iNES #21 IBS No. 126289

iNES 22	OD	L	B	H	Rod	Or	OR
in.	5/16 to 7/16	4-5/16	11/16	1-3/4	4-9/16	11/16	1-9/16
mm.	12 to 16	109	18	45	116	17	39
pipes	1/16 - 3/16						

iNES #24 IBS No. 126296

iNES 24	OD	L	B	H	Rod	Or	OR
in.	7/8 to 1-1/4	5-3/8	1-1/16	2-1/2	6-3/8	1-1/16	2-1/8
mm.	22 to 32	136	27	64	161	27	54
pipes	1/2 to 7/8						

iNES #22 IBS No. 126294

iNES 22	OD	L	B	H	Rod	Or	OR
in.	1/2 to 5/8	4-5/16	11/16	1-3/4	4-9/16	11/16	1-9/16
mm.	12 to 16	109	18	45	116	17	39
pipes	1/4 - 3/8						

iNES #25 IBS No. 126297

iNES 25	OD	L	B	H	Rod	Or	OR
in.	1-1/4 to 2-1/8	6-7/16	1-1/2	3-3/16	7-9/16	1-3/8	2-7/16
mm.	22 to 32	163	38	81	192	35	62
pipes	7/8 to 1-3/4						

iNES #23 IBS No. 126295

iNES 23	OD	L	B	H	Rod	Or	OR
in.	11/16 to 13/16	4-3/8	13/16	2-1/16	5-1/8	13/16	1-3/4
mm.	16 to 20	111	21	53	130	20	45
pipes	3/8 - 1/2						



3 Pc iNES Internal Set

IBS No.	Description
126302	Contains #21 Small, #22 Medium & #23 Large iNES tools. Replacement blades included.



3 & 6 Pc NES Internal & External Tool Sets

IBS No.	Description
126303	Contains NES 1A Small External Tool, #21 Small & #22 Medium iNES Internal tools. Replacement blades included.
126304	Contains NES 1A Small & #2 Large External Tools, #21 Small, #22 Small, #23 Medium & #24 Large iNES Internal tools. Replacement blades included for internal tools.



iNES Replacement Blades & Nylon Pads

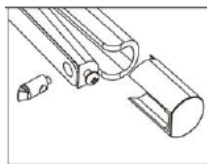

Nylon pads or for use with Internal tools to be used for repair for threads in aluminum or other soft metals.

IBS No.	Description
126305	iNES #21 Replacement Blades
126298	iNES #22 Replacement Blades
126299	iNES #23 Replacement Blades
126300	iNES #24 Replacement Blades
126301	iNES #25 Replacement Blades
126306	iNES #21 Nylon Pad
126306	iNES #22 Nylon Pad
126306	iNES #23 Nylon Pad
126306	iNES #24 Nylon Pad

ThreadMate™ Set & External Tool



- Fixes any thread in diameter between M5-M12 (#12 - 1/2") internal and M4-M13 (5/32" - 1/2") external.
- A great solution for outdoor technicians, industrial maintenance, workshops, auto garages, marine use, farmers, auto mechanics, professional and hobby users, etc.
- Small size fits any toolbox.
- External thread repair tool repairs and restores external threads.
- Easy to use set with built-in knob — just set and turn.
- Kit contains replaceable nylon pads for soft metal repair jobs.
- Clean thread in both ways - inside out, or outside in.
- Easy to operate, no special thread knowledge required — works on USS, SAE, Metric, Fine, Coarse, etc.

THREADMATE™ KIT & EXTERNAL TOOL

IBS No.	Description	Qty
126290	MINI ThreadMate™ Kit	1
126292	MINI ThreadMate™ External Tool	1
126291	Replacement Blades Ext. Tool 1 pr.	1

D R I L L B I T S E T C



IBS, INCORPORATED

Tools (T03)

D
R
I
L
L
B
I
T
S
E
T
C

External Deburring Tools 3Pc Set (T03)

IBS No. 476P

- Quickly repairs damaged threads from 7/64" to 2-1/3".
- Hardened HRC 60 Steel blades remove burrs and uneven ridges from threaded rods, pipes and more.
- Works on hardened and mild steels, Grade 8 fasteners, stainless steel, brass copper, aluminum, plastics, wood, etc.
- 1/4" hex shank attaches to your drill quickly.
- Most effective at low speeds — recommended speed should not exceed 500 RPM in a clockwise direction only.



IBS No.	Description	Shank	Qty
51951	Small Deburring Tool 7/64" to 7/16"	1/4"	1
51950	Medium Deburring Tool 5/16" to 7/8"	1/4"	1
51952	Large Deburring Tool 23/32" to 2-1/3"	3/8"	1



REMOVE BURS



REPAIR DAMAGED THREADS



WORKS ON A VARIETY OF MATERIALS

GrabIt® Drill-Out Broken Bolt Extractor Set

Removing stripped screws and bolts can be a frustrating experience, and now there's a solution! This 4 pc extractor kit removes broken bolts from as small as 1/4" to 1/2" (6mm-12mm) and can drill up to Grade 8 or 10.9 class fasteners. Each Drill-Out is a drill bit and extractor in one and is uniquely designed to drill into the rough surfaces when bolts break.

SINGLE STEP EXTRACTION FAST & EASY TO USE

A drill bit and extractor in one tool, the DRILL-OUT creates a unique interaction between drill bit and extractor, resulting in maximum impact and break out ability. Broken bolts and studs are removed quickly and easily without damaging the fastener threads.

- **Unique drill tip** allows the tool to stay on center.
- **Self-centering drill tip eliminates** walking or wandering.
- **No grinding, center punching or pilot hole** required.
- **Works** on jagged, uneven and rough breaks.
- **Tempered twice for extra hardness;** resulting in multiple extractions per tool.
- **Made from the highest quality M2 HSS Steel.**
- **MADE IN THE USA.**



DRILLING:

1. Choose the correct size DRILL-OUT.
2. Secure round end in the drill chuck and tighten.
3. Thread collet/extractor back against drill chuck.
4. Set drill in reverse and begin drilling at the suggested RPM's. (see Figure 1)

REMEMBER: Hole must be straight & on center.

DO NOT allow collet/extractor to move down toward tip while drilling.

5. Stop drilling just before the collet/extractor reaches the broken bolt. (See Figure 2)
6. Apply penetrating oil to help loosen bolt.

IBS No.	Description	Qty
133309	Grab-It Drill Out Extractor 4 Pc Set 1/4" to 1/2" (6mm to 12mm)	1

WARNING: Always wear safety glasses when operating or near power tools. Cutting tools may shatter when broken.



Power-Outs™ Double Edged Screw Extractors

These patented double-edged screw extractors are made from hardened chrome vanadium steel with a burnished finish. The cutting edges are polished, and the part number and dimensions are laser marked on the shank for easy identification.



POWER OUTS DOUBLE EDGED SCREW EXTRACTORS

IBS No.	Size	SW Diam (in)	Drill Diam (in)		Screw Size (in)	
			Min	Max	Min	Max
139501	1	1/4	1/8	3/16	3/16	1/4
139502	2	3/8	3/16	9/32	5/16	3/8
139503	3	1/2	1/4	3/8	7/16	1/2
139504	4	5/8	11/32	1/2	1/2	9/16
139505	5	3/4	7/16	5/8	5/8	3/4
139506	6	7/8	9/16	3/4	7/8	1
139507	7	1	3/4	15/16	1	1-1/8
139395	5 Pc Set (Sizes 1-5 in a plastic pouch)					

Power-Outs™ Sets



POWER OUTS & LH DRILL EXTRACTOR SET

IBS No.	Description
670P	5 pc Power Outs & 8 Pc LH Drill Extractor Set (1/16, 1/8, 3/16, 1/4, 5/16, 3/8, 7/16, 1/2)
745R	5 pc Power Outs Travel Tray w/Corresponding LH Drill Bits (5/32, 1/4 5/16, 7/16 & 1/2)
818R	5 pc Power Outs Travel Tray w/Corresponding LH Stubby Drill Bits (5/32, 1/4 5/16, 7/16 & 1/2)

Bolt Extractors

- Reverse spiral flutes are designed to bite down to provide maximum gripping power.
- High carbon steel ensures longer life and greater durability.
- Universal lobular design fits all types of fasteners.
- 3/8 square drive for use with hand ratchets, impact wrenches, and air ratchets.
- Hexagonal flats for use with flat wrench, pliers, adjustable wrench, sockets or locking pliers.



IBS No.	Description
54115	5 PC 3/8 DRIVE BOLT / STUD EXTRACTOR SET 5/16 - 3/4 Removes bolt sizes: 8mm, 10mm, 13mm, 19mm, 5/16, 11/16, & 3/4" in drive size 3/8"

Hex Head Spline Drive Screw Extractors

- Designed to remove broken studs, bolts, socket screws and fittings from #12 - 1-3/4".
- For use with sockets and flat wrenches.
- Made in the U.S.A.



25 Piece Hex Head Spline Drive Screw Extractor Set

IBS No.	Description
53227	25 Pc. Hex Head Spline Drive Screw Extractor Set. Sizes 1/8 - 7/8. Packaged in a sturdy blue plastic box for easy storage and organization

IBS No.	Size	Hex Hd Size	Bolt Dia.	Drill Bit
53201	1/8	1/2	#12	1/8
53202	5/32	1/2	1/4	5/32
53205	1/4	1/2	7/16	1/4
53206	9/32	1/2	1/2	9/32
53207	5/16	1/2	9/16	5/16
53208	11/32	1/2	5/8	11/32
53209	3/8	1/2	11/16	3/8
53210	13/32	1/2	3/4	13/32
53211	7/16	5/8	13/16	7/16
53213	1/2	5/8	15/32	1/2
53216	19/32	3/4	1-1/8	19/32
53217	5/8	3/4	1-3/16	5/8
53220	23/32	7/8	1-3/8	23/32
53225	7/8	1	1-11/16	7/8

D R I L L B I T S E T C



D
R
I
L
L
B
I
T
S
E
T
C



Taps, Burs & Blades

A

Annular Cutters

Carbide Tipped

CT150 & CT200 PT-13, PT-15

IBS High Speed Steel PT-15

Assortments

Threaded Rod

Grade 8 Threaded Rod Assortment PT-60

Assortments, Cutting Tools

Advanced Edge Power Reciprocating Saw Blades

with Tool Ease Lubricant Stick PT-44

Annular Cutters - Carbide Tipped

PT-14

Annular Cutters - High Speed Steel PT-16

Black Hole Carbide Tipped Cutters

1" Depth - 4 Pc.Set PT-22

1" Depth - 5 Pcs PT-22

3/16" Depth - 5 Pc. PT-22

762R - 5 Pc. - 3/16" Depth PT-21

763R - 4 Pc. 1" Depth PT-21

764R - 5 Pc. - 1" Depth PT-22

Carbide Burs PT-58, PT-60

Hole Saws

Bi-Metal

Advanced Bi-Metal Hole Saws 2-1/8"- 4" PT-26

Advanced Bi-Metal Hole Saws 3/4"- 4" PT-27

Advanced Bi-Metal Hole Saws 5/8"- 2" PT-28

M42 Thin Wall Hole Saws Travel Tray Assortment PT-17

Hole Saws - Bi-Metal

Advanced Edge Bi-Metal Hole Saws 2-1/8" - 4" PT-26, PT-28

Advanced Edge Bi-Metal Hole Saws 3/4" - 4" PT-27, PT-29

Advanced Edge Bi-Metal Hole Saws 5/8" - 2" PT-21, PT-22, PT-26, PT-28

Advanced Edge Bi-Metal Hole Saws 11 Pc Kit PT-29

Advanced Edge Bi-Metal Hole Saws 14 Pc Kit PT-29

Nitro-Carb Power Tap & Hex Die Sets PT-8, PT-10

Saw Blades

Advanced Edge Power Reciprocating Saw Blades

with Tool Ease Lubricant Stick PT-44

Bi-Metal Air Saw Blades PT-50

Bi-Metal Reciprocating

Saw Blades PT-48

Bore Blades and Demolition Blades PT-48

IBS Hi-Alloy & Triple-Cut Hacksaw Blades PT-43

Reciprocating Saw Handle & Blade Kit PT-47

Special Purpose Reciprocating Saw Blades PT-49, PT-63

Taps, Metric

Index

18 Metric Taps & Drill Bits w/Index PT-7

Organizer

29 pc Metric Taps, Drill Bits, Hex Dies & Tools PT-7

Taps, Standard

Drawer

4-40 thru 1/2-10 Tap, Die & Drill Set PT-9

9/16-12 thru 3/4-16 Tap, Die & Drill Set PT-9

Index

10 Pc NC/NF Power Taps w/Index PT-5, PT-8

10 Pc NC/NF Taper Taps w/Index PT-8

18 Pc NC Bottom Taps & Drill Bits w/Index PT-8

18 Pc NC Taper Taps & Drill Bits w/Index PT-8

Nitro-Carb Hand Tap PT-8

B

Blades

100 PK Shark Serrated Blades PT-53

Bandsaw, Bi-Metal

General Information PT-35

Portable Blades PT-40

Troubleshooting PT-36, PT-37, PT-38, PT-39

Bi-Metal

Air Saw Blades PT-50

Reciprocating Saw PT-45

Boar Blades PT-46

Thick Demolition PT-46

Sabre/Jig PT-51

Chop Saw-Carbide Tipped

14" Blade for Aluminum PT-33

14" Blade for Stainless Steel PT-33

14" Blade for Steel PT-33

Circular Saw

Combination Blade PT-31

Heavy Duty Deck / Nail Cutting Blade PT-31

Miter Saw Blade PT-32

Miter Saw Rip Blade PT-32

Novelty Combo Blade PT-31

Steel & Iron Cutting Blade PT-31

Circular Saw-Carbide Tipped

7-1/4" Blades for Aluminum PT-33

7-1/4" Blades for Steel PT-33

SteelMax 7-1/4" Blades for Stainless Steel PT-33

Hacksaw

IBS Hi-Alloy PT-42

Triple-Cut PT-42

Reciprocating Saw

Advanced Edge Power Reciprocating Saw Blades PT-44

Bi-Metal PT-45

Double Edge Bi-Metal Bore Blades PT-46, PT-47

Power Curve PT-46

Tungsten Carbide PT-46

Retractable Knife

HD 8 PT Snap Blade PT-52

Heavy Duty Hook Utility Blades PT-52

Single Edge Razor Blades PT-53

Burs - Carbide, Rotary

14° Taper Radius PT-57

Ball Shape PT-56



IBS, INCORPORATED

Index

T
A
P
S

B
U
R
S

B
L
A
D
E
S

- Cone Shape PT-57
- Cylinder PT-56
- Cylinder Radius End PT-56
- General Information
 - Surface Feet Conversion Chart PT-59
- Oval PT-57
- Tree Pointed End PT-57
- Tree Radius End PT-57

F

Files

Accessories

- File Card PT-62
- Skroo-Zon File Handles PT-63

Black Maxi-Sharp

- All Purpose PT-61
- Half-Round PT-61
- Mill PT-61
- Multi-Kut Flat PT-62
- Round PT-62
- Tapered Saw PT-62

Chainsaw Files PT-62

Tungsten Points File with Pocket Clip PT-62

Fiskars Utility Knives & Tools

Tools

- Fiskars PowerArc Easy Action Shears (10") PT-55
- Fiskars PowerArc Utility Snips (8") PT-55

Utility Knives

- Fiskars Pro Fixed Blade Utility Knife PT-54
- Fiskars Pro Folding Utility Knife PT-54
- Fiskars Pro Retractable Blade Utility Knife PT-54

H

Hacksaw Frame, 4-in-1 PT-41

Hex Dies

Nitro-Carb PT-12

Hole Saws

Bi-Metal

- Advanced Bi-Metal Hole Saws PT-25
- Arbors PT-25
- Hole Saw Arbor Replacement Drill PT-25

Carbide Tipped Annular Cutters

- CT150 PT-13, PT-15, PT-16
- CT150 Accessories PT-13, PT-15
- CT200 PT-13, PT-15, PT-16

Carbide Tipped, Black Hole

- 1" Depth PT-20
- 3/16" Depth
 - Accessories PT-19

M42 Thin Wall Hole Saws PT-17

Sheet Metal Slugger Cutters PT-18

- Slugger Cutter Accessories
 - 3mm Hex Key PT-18
 - Pilot Pin PT-18
- Slugger Cutter Arbor Assembly PT-18

Technical Information

Cutting Speeds PT-30

K

Knives

Cartridge Loading Snap Knife with Rubber Grip PT-52

Fiskars Utility Knives

- Fiskars Pro Fixed Utility Knife PT-54
- Fiskars Pro Retractable Blade Utility Knife PT-54

HD Retractable Blade 8 Pt. Breakaway Knife PT-52

SHARK Combination Utility Knife PT-53

L

Lubricants

Ultra Lube Super Premium

Cutting Fluid PT-24

T

Taps

Nitro-Carb

- Bottom PT-6
- General Information PT-6
- Hand Tap Assortments - Index PT-8
- HSS Taper Pipe Taps PT-6, PT-8, PT-10
- Metric Taps PT-7
- Metric Tap Sets PT-7
- NPT Pipe PT-7
- Plug PT-6
- Power PT-6
- Power Tap & Hex Die Sets PT-8, PT-10
- Taper PT-6

Threaded Rod

Tools

- Deburring Tool (T03) PT-60

Tools

Hand

- 4-in-1 Hacksaw Frame PT-41
- Cartridge Loading Snap Knife with Rubber Grip PT-52, PT-53
- HD Retractable Blade
 - 8 Pt. Breakaway Knife PT-52
- Heavy Duty Metal Scraper PT-53
- Professional Hex Die Wrench PT-11
- Professional Straight Handle Tap Wrench PT-11
- Reciprocating Saw Handle PT-47
- Revo Folding Knife PT-53
- Tapping Tool & Guide PT-11
- T-Handle Tap Wrench PT-11

Power

- 7-1/4 Circular Saw PT-33
- 14" Circular Saw PT-34
- Compact Magnetic Drill Press PT-23
- Magnetic Drill Press PT-23
- Variable Speed / Reversible
 - Magnetic Drill Press PT-23

Replacement Parts



HD 8 PT Snap Blade PT-52
Heavy Duty Hook Utility Blades PT-52
Plastic Razor Blades PT-53
Single Edge Razor Blades PT-53

Threaded Rod

Deburring Tool 3Pc Set (T03) PT-60

T
A
P
S

B
U
R
S

B
L
A
D
E
S



IBS, INCORPORATED

Nitro Carb Taps P10

"Power" Taps Changing The Way Holes Are Tapped



Before the "Power" Tap, it was said that all taps broke before they wore out. But now that has all changed. Called a "Power" Tap because of the way it "shoots" the chips out ahead of the tap. The design is radically different from that of the ordinary tap and therefore can be used well in power tools. This change is most noticeable when tapping stringy materials, where before the flutes would become loaded and cause the tap to break. The "Power" Tap design makes it possible to use shallower flutes which translates to a stronger tap. This all adds up to a tap which requires less power to drive and, for some classes of work (through holes and blind holes with sufficient clearance at the bottom, most notably), are much more economical to use than ordinary hand taps.

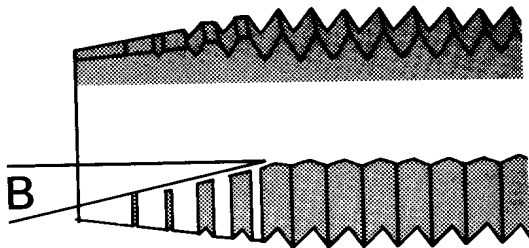
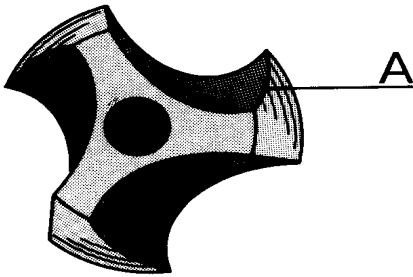

"Power" Tap Design

The cutting edges (**A**) at the point of the tap are ground at an angle (**B**) to the axis for a distance of four or five threads. This angle, in conjunction with the hook on the cutting edge of the land and the special flute form, produces the long curling chips. These chips, instead of passing out or backing in the flutes, are "shot" out ahead of the tap.

"Power" Tap



Hand Tap



Stronger

A "Power" Tap does not need the deep flutes that an ordinary tap requires for the elimination of chips. Thus fewer and shallower flutes can be used giving the tap a larger cross sectional arc and extra strength.

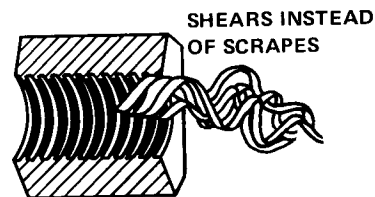

Less Power Needed

The metal is sheared by the angular cutting edge with a hook on the land instead of being torn or pulled off with a scraping action. Much less power is needed for this shearing across than is required for hand taps.

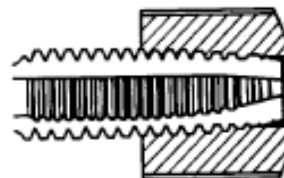

Accuracy

The first few teeth of the "Power" Tap do all the cutting. The remainder of the threaded section serves as a lead screw, steadying the tap and insuring a more accurately tapped hole.

T
A
P
S

B
U
R
S

B
L
A
D
E
S

IBS, INCORPORATED

Nitro-Carb Taps P10



Pro Power Taps

IBS Pro Power Taps are designed for difficult materials including: stainless steel, alloy steels, and high carbon steel. Special tool geometry creates less torque, better removal of chips and runs cooler. Reduced neck design enhances the flow of cutting fluid to cutting teeth and reduces surface contact between the tool and workpiece for more efficient threading.

- Constructed of Chromium, Vanadium, Molybdenum and Cobalt Alloys
- Cuts Harder Materials than standard HSS Tap - Cuts Up to 45 Rockwell "C"
- Superior Design Actually Shoots Chips Out Ahead of the Tap Providing a Faster, Cleaner and Smoother Thread and a Longer Lasting Tap.

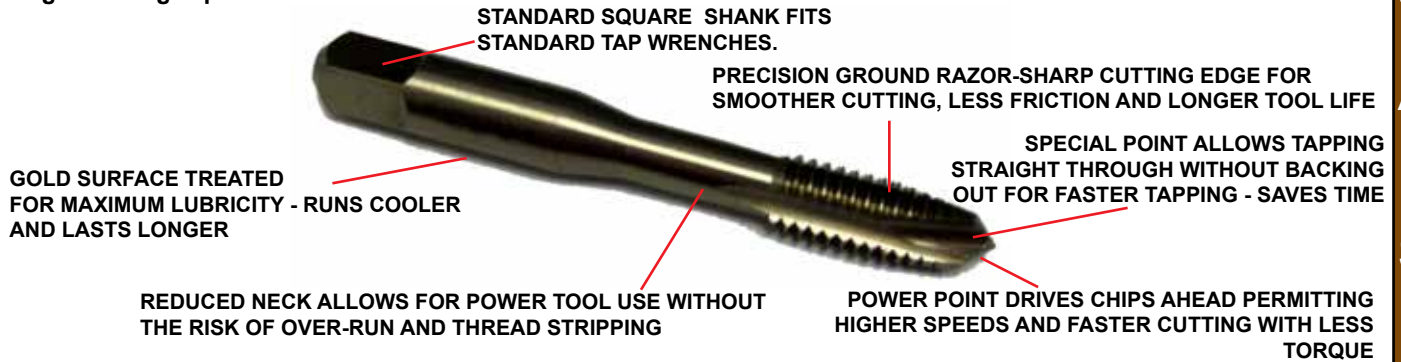

Inch

Thread Size	# of Flutes	IBS No.	Thread Size	# of Flutes	IBS No.	Thread Size	# of Flutes	IBS No.	Thread Size	# of Flutes	IBS No.
4-40	2	18000	10-32	3	18004	5/16-18	2	18008	7/16-14	3	18012
6-32	2	18001	12-24	3	18005	5/16-24	2	18009	7/16-20	3	18013
8-32	3	18002	1/4-20	3	18006	3/8-16	3	18010	1/2-13	3	18014
10-24	3	18003	1/4-28	3	18007	3/8-24	3	18011	1/2-20	3	18015

Metric

Thread Size	# of Flutes	IBS No.	Thread Size	# of Flutes	IBS No.	Thread Size	# of Flutes	IBS No.	Thread Size	# of Flutes	IBS No.
M3-.5	2	18020	M6-1.0	3	18023	M10-1.5	3	18025	M14-2.0	3	18027
M4-.7	3	18021	M8-1.25	3	18024	M12-1.75	3	18026	M16-2.0	3	18028
M5-.8	3	18022									

Pro Power Tap Assortments (P15)



IBS No.	Description
563P	10 Pc NC/NF Pro Power Taps with Index Tap Sizes: 1/4-20, 1/4-28, 5/16-18, 5/16-24, 3/8-16, 3/8-24, 7/16-14, 7/16-20, 1/2-13, 1/2-20 Packaged in a sturdy 10 pc. metal index
17456	18 Pc NC Pro Power Taps & Drill Bits with Index Tap Sizes: 6-32, 8-32, 10-24, 10-32, 1/4-20, 5/16-18, 3/8-16, 7/16-14, 1/2-13 Drill Bits: #36, #29, #25, #21, #7, "F", 5/16, "U", 27/64 Packaged in a sturdy 18 pc. metal index
17458	8 Pc Metric Pro Power Taps with Index Tap Sizes: M3-0.50, M4-0.70, M5-0.80, M6-1.00, M8-1.25, M10-1.50, M12-1.75, M16-2.00 Packaged in a sturdy 10 pc. metal index
17457	28 Pc NC/NF Pro Power Taps & Drill Bits with Organizer Tap Sizes: 6-32, 8-32, 10-24, 10-32, 1/4-20, 1/4-28, 5/16-18, 5/16-24, 3/8-16, 3/8-24, 7/16-14, 7/16-20, 1/2-13, 1/2-20 Drill Bits: #36, #29, #25, #21, #7, #3 "F", I, Q, 5/16, 3/8, 25/64, 27/64, 29/64 Packaged in a sturdy 28 pc. metal index



IBS, INCORPORATED

Nitro-Carb Taps P10

Nitro-Carb Taps

IBS Nitro-Carb Taps are professional quality cutting tools for maintenance and repair applications. They are made of the same quality alloys as our drill bits (Chromium, Vanadium, and Molybdenum), which allows for faster cutting and longer tap life.

FEATURES:

- **Nitro-Carburized finish** at 950°F to be measurably harder than high speed steel.
- **Space age Nitro-Carb steel** withstands substantially higher operating temperatures while maintaining sharpness.
- **Requires 30% less torque** to provide faster cutting.
- **30% heavier web** than regular taps — for less tap breakage.
- **Special Hi-Tungsten & High Molybdenum tool steels**, gold surface treated for maximum lubricity.
- **Precision ground threads** for the ultimate in accuracy and performance.
- **3 styles** - Taper, Power & Bottoming styles provide versatility in tough materials both blind & through holes.
- **For general use in production tapping** or hand operations.
- **Cuts materials up to 55 Rockwell** on the "C" scale.
- **Thread tolerances are to .0005.** Gives perfect threads every time.
- **Outlasts ordinary taps 3 to 1.**
- **Recommended for stainless** and other hard metals.
- **Nitro-Carb Taps will reduce your "Tapped Hole" costs** tremendously saving time, labor, & money
- **Triple Heat Treated Ground Threads** and Special Alloys all combine to give you a 200% higher breaking torque over ordinary taps.



POWER

Three to five threads chamfered. For general use when tapping into the bottom of a hole is not critical.



TAPER

Eight to ten threads chamfered for easy use thread starting in tough materials



BOTTOM

One and one half threads chamfered. Use after threads have been started for tapping to the bottom of a hole.

Thread Size	Drill Size	Power	# of Flutes	Plug	# of Flutes	Taper	# of Flutes	Bottom	# of Flutes	Thread Size	Drill Size	Power	# of Flutes	Plug	# of Flutes	Taper	# of Flutes	Bottom	# of Flutes
4-40	43	17629	2			17600	3	17655	3	7/16-20	25/64	17642	3			17613	4	17668	4
6-32	34	17630	2			17601	3	17656	3	1/2-13	27/64	17643	3			17614	4	17669	4
8-32	29	17631	2			17602	4	17657	4	3/16-20	29/64	17644	3			17617	4	17670	4
10-24	23	17632	2			17603	4	17658	4	9/16-12	31/64			17645	4	17619	4	17671	4
10-32	20	17633	2			17604	4	17659	4	9/16-18	1/2			17646	4	17620	4	17672	4
12-24	16	17634	2			17605	4	17660	4	5/8-11	17/32	17647	3			17621	4	17673	4
1/4-20	7	17635	2			17606	4	17661	4	5/8-18	9/16	17648	3			17622	4	17674	4
1/4-28	3	17636	2			17607	4	17662	4	3/4-10	21/32	17649	3			17623	4	17675	4
5/16-18	"G"	17637	2			17608	4	17663	4	3/4-16	11/16	17650	3			17624	4	17676	4
5/16-24	"I"	17638	2			17609	4	17664	4	7/8-9	49/64			17651	4	17625	4	17677	4
3/8-16	"O"	17639	3			17610	4	17665	4	7/8-14	13/16			17652	4	17626	4	17678	4
3/8-24	"R"	17640	3			17611	4	17666	4	1-8	7/8			17653	4	17627	4	17679	4
7/16-14	3/8	17641	3			17612	4	17667	4	1-14	59/64			17654	4	17628	4	17680	4

Nitro-Carb Taper Pipe Taps



Thread	Drill Size	Taper	Flutes	Thread	Drill Size	Taper	Flutes	Thread	Drill Size	Taper	Flutes
1/8-27	11/32	17682	4	1/4-18	7/16	17683	4	3/8-18	37/64	17684	4
1/2-14	23/32	17685	4	3/4-14	59/64	17686	5				

T
A
P
S

B
U
R
S

B
L
A
D
E
S

IBS, INCORPORATED

Nitro-Carb Taps P10



Nitro-Carb Metric Taps



Thread Size	Drill Size	Power	# of Flutes	Plug	# of Flutes	Taper	# of Flutes	Bottom	# of Flutes
M2.5-.45	2.05	17704	2			17687	3	17750	3
M3-.5	2.5	17705	2			17688	3	17751	3
M3.5-.60	2.9	17706	2			17691	3	17752	3
M4-.70	3.3	17707	2			17689	4	17753	4
M4.5-.75	3.75	17719	2			17695	4	17771	4
M5-.80	4.2	17708	2			17690	4	17754	4
M6-1.0	5.0	17709	2			17692	4	17755	4
M8-1.0*	7.0			17768	4	17693	4	17756	4
M8-1.25	6.7	17710	3			17694	4	17757	4
M10-1.25*	8.7			17769	4	17696	4	17758	4
M10-1.5	8.5	17711	3			17697	4	17759	4
M12-1.25*	10.8			17770	4	17698	4	17760	4
M12-1.75	10.2	17712	3			17699	4	17761	4
M14-1.5*	12.5			17720	4	17700	4	17762	4
M14-2.0	12.0	17713	3			17701	4	17763	4
M16-1.5*	14.5			17721	4	17702	4	17764	4
M16-2.0	14.0	17714	3			17703	4	17765	4
M18-2.5	15.5	17772	3			17773	4	17774	4
M20-2.5	17.5			17715	4	17717	4	17766	4
M24-3.0	21.0			17716	4	17718	4	17767	4

* indicates Fine Thread

Nitro-Carb Metric Tap Sets

IBS No.	Description
17445 (P15)	18 Metric Taps & Drill Bits w/Index Tap Sizes: M2.5-.45, M3-.5, M3.5-.60, M4-.70, M5-.80, M6-1.0, M8-1.25, M10-1.5, M12-1.75 Drill Bits: 2.05mm, 2.5mm, 2.9mm, 3.3mm, 4.2mm, 5mm, 6.7mm, 8.5mm, 10.2mm Packaged in a sturdy 18 pc. metal index
567P (Z08)	29 pc Metric Taps, Drill Bits, Hex Dies & Tools Tap Sizes: M2.5-.45, M3-.5, M3.5-.60, M4-.70, M5-.80, M6-1.0, M8-1.25, M10-1.5, M12-1.75 Includes the following tools: (1) Straight Handle Top Wrench, (1) 1" Hex Die Wrench, (1) 1-7/16" Hex Die Wrench Packaged in a sturdy 3 drawer organizer
17453	10pc Metric Power Taps Tap Sizes: M3-.5, M3.5-.6, M4-.70, M4.5-.75, M5-.80, M6-1.0, M8-1.25, M10-1.5, M12-1.75, M16-20. Packaged in a sturdy metal index
17454	10pc Metric Taper Taps Tap Sizes: M3-.5, M3.5-.6, M4-.70, M4.5-.75, M5-.80, M6-1.0, M8-1.25, M10-1.5, M12-1.75, M16-2.0. Packaged in a sturdy metal index
17455	10pc Metric Bottom Taps Tap Sizes: M3-.5, M3.5-.6, M4-.7, M4.5-.75, M5-.8, M6-1.0, M8-1.25, M10-1.5, M12-1.75, M16-2.0. Packaged in a sturdy metal index



T
A
P
S

B
U
R
S

B
L
A
D
E
S



IBS, INCORPORATED

Assortments Z08

TAPS
BURS
BLADES

Nitro-Carb Hand Tap Assortments (P15)



IBS No.	Description
551P	10 Pc NC/NF Power Taps with Index Tap Sizes: 1/4-20, 1/4-28, 5/16-18, 5/16-24, 3/8-16, 3/8-24, 7/16-14, 7/16-20, 1/2-13, 1/2-20 Packaged in a sturdy 10 pc. metal index
550P	10 Pc NC/NF Taper Taps w/Index Tap Sizes: 1/4-20, 1/4-28, 5/16-18, 5/16-24, 3/8-16, 3/8-24, 7/16-14, 7/16-20, 1/2-13, 1/2-20 Packaged in a sturdy 10 pc. metal index
552P	10 Pc NC/NF Bottom Taps w/Index Tap Sizes: 1/4-20, 1/4-28, 5/16-18, 5/16-24, 3/8-16, 3/8-24, 7/16-14, 7/16-20, 1/2-13, 1/2-20 Packaged in a sturdy 10 pc. metal index
554P	10 Pc NC Power Taps with Index Tap Sizes: 4-40, 6-32, 8-32, 10-24, 10-32, 1/4-20, 5/16-18, 3/8-16, 1/2-13, 5/8-11 Packaged in a sturdy 10 pc. metal index
553P	10 Pc NC Taper Taps with Index Tap Sizes: 4-40, 6-32, 8-32, 10-24, 10-32, 1/4-20, 5/16-18, 3/8-16, 1/2-13, 5/8-11 Packaged in a sturdy 10 pc. metal index
555P	10 Pc NC Bottom Taps with Index Tap Sizes: 4-40, 6-32, 8-32, 10-24, 10-32, 1/4-20, 5/16-18, 3/8-16, 1/2-13, 5/8-11 Packaged in a sturdy 10 pc. metal index
17448	18 Pc NC Power Taps & Drill Bits with Index Tap Sizes: 6-32, 8-32, 10-24, 10-32, 1/4-20, 5/16-18, 3/8-16, 7/16-14, 1/2-13 Drill Bits: #36, #29, #25, #21, #7, "F", 5/16" "U", 27/64" Packaged in a sturdy 18 pc. metal index
17447	18 Pc NC Taper Taps & Drill Bits with Index Tap Sizes: 6-32, 8-32, 10-24, 10-32, 1/4-20, 5/16-18, 3/8-16, 7/16-14, 1/2-13 Drill Bits: #36, #29, #25, #21, #7, "F", 5/16" "U", 27/64" Packaged in a sturdy 18 pc. metal index
17449	18 Pc NC Bottom Taps & Drill Bits with Index Tap Sizes: 6-32, 8-32, 10-24, 10-32, 1/4-20, 5/16-18, 3/8-16, 7/16-14, 1/2-13 Drill Bits: #36, #29, #25, #21, #7, "F", 5/16" "U", 27/64" Packaged in a sturdy 18 pc. metal index

Nitro-Carb Power Tap & Hex Die Sets

- **Special Hi-Tungsten and Hi-Molybde-num tool steel construction, gold surfacetreated** for maximum lubricity.
- **Recommended for use in production tapping and drilling** in work hardening grades of stainless steel and other hard metal applications.
- **Precision ground tap threads** for the ultimate in accuracy and performance.



40 Pc NITRO-CARB POWER TAP & HEX DIE SET

IBS No.	Description
17472	SET CONTAINS: <ul style="list-style-type: none"> • Nitro Power Taps & Hex Die Sizes: 4-40, 6-32, 8-32, 10-24, 10-32, 12-24, 1/4-20, 1/4-28, 5/16-18, 5/16-24, 3/8-16, 3/8-24, 7/16-14, 7/16-20, 1/2-13 & 1/2-20 • Nitro-Carb Taper Pipe Tap & Hex Die: 1/8-27 NPT • T-Handle tap wrenches: 0" - 1/4" & 3/16" - 1/2" • Straight handle tap wrench: #4 - 1/2" • Die stock, screw pitch gauge & screwdriver. • Packaged in a sturdy molded plastic case.



25 Pc NITRO-CARB POWER TAP & HEX DIE SET

IBS No.	Description
17471	SET CONTAINS: <ul style="list-style-type: none"> • Nitro Power Taps & Hex Die Sizes: 1/4-20, 1/4-28, 5/16-18, 5/16-24, 3/8-16, 3/8-24, 7/16-14, 7/16-20, 1/2-13 & 1/2-20. • Nitro-Carb Pipe Tap & Hex Die Size: 1/8-27 NPT • T-Handle tap wrench: 3/16" - 1/2" • Die stock, screw pitch gauge & screwdriver. • Packaged in a sturdy molded plastic case.

















IBS, INCORPORATED

Assortments Z08









#4 thru 1/2 Tap, Die & Drill Set
NITRO-CARB TAPS WITH TAP & DIE WRENCHES
 Packaged in a Locking Steel Drawer for Easy Storage & Organization
IBS No. 591P • 50 Items • 50 Pcs



 IBS, Inc. <small>SPECIALTY PRODUCTS FOR MAINTENANCE & REPAIR INDUSTRIALBOLT.COM • 800-678-1906</small>		Nitro-Carb Power Taps, Hex Dies and Drill Bits with Tools	
120922 Professional Tap Wrench		120925 Professional 1" Hex Die Wrench	
129913 17643 16823  1/2-13 Nitro-Carb Power Tap 27/64 Drill Bit	HSS Hex Die	129922 17644 16825  1/2-20 Nitro-Carb Power Tap 29/64 Drill bit	HSS Hex Die
129912 17641 16820  7/16-14 Nitro-Carb Power Tap 3/8 Drill Bit	HSS Hex Die	129921 17642 16821  7/16-20 Nitro-Carb Power Tap 25/64 Drill Bit	HSS Hex Die
129910 17637 16141  5/16-18 Nitro-Carb Power Tap "G" Drill Bit	HSS Hex Die	129919 17638 16143  5/16-24 Nitro-Carb Power Tap "T" Drill Bit	HSS Hex Die
129911 17639 16149  3/8-16 Nitro-Carb Power Tap "O" Drill Bit	HSS Hex Die	129920 17640 16152  3/8-24 Nitro-Carb Power Tap "R" Drill Bit	HSS Hex Die
129917 17633 16099  10-32 Nitro-Carb Power Tap #20 Drill Bit	HSS Hex Die	129908 17634 16095  12-24 Nitro-Carb Power Tap #16 Drill Bit	HSS Hex Die
129909 17635 16086  1/4-20 Nitro-Carb Power Tap #7 Drill Bit	HSS Hex Die	129918 17636 16082  1/4-28 Nitro-Carb Power Tap #3 Drill Bit	HSS Hex Die
129904 17629 16122  4-40 Nitro-Carb Taper Tap #43 Drill Bit	HSS Hex Die	129905 17630 16113  6-32 Nitro-Carb Power Tap #34 Drill Bit	HSS Hex Die
129906 17631 16108  8-32 Nitro-Carb Power Tap #29 Drill Bit	HSS Hex Die	129907 17632 16102  10-24 Nitro-Carb Power Tap #23 Drill Bit	HSS Hex Die

9/16 thru 3/4 Tap, Die & Drill Set
NITRO-CARB TAPS WITH TAP & DIE WRENCHES
 Packaged in a Locking Steel Drawer for Easy Storage & Organization
IBS No. 592P • 50 Items • 50 Pcs



 IBS, Inc. <small>SPECIALTY PRODUCTS FOR MAINTENANCE & REPAIR INDUSTRIALBOLT.COM • 800-678-1906</small>		Nitro-Carb Plug/Power Taps, Hex Dies and Drill Bits with Tools	
120923 Professional Tap Wrench		120926 Professional 1-7/16" Hex Die Wrench	
129916 17649 16842  3/4-10 Nitro-Carb Power Tap 21/32 Drill Bit	HSS Hex Die	129925 17650 16844  3/4-16 Nitro-Carb Power Tap 11/16 Drill bit	HSS Hex Die
129915 17647 16834  5/8-11 Nitro-Carb Power Tap 17/32 Drill Bit	HSS Hex Die	129924 17648 16836  5/8-18 Nitro-Carb Power Tap 9/16 Drill bit	HSS Hex Die
129914 17645 16827  9/16-12 Nitro-Carb Plug Tap 31/64 Drill Bit	HSS Hex Die	129923 17646 16828  9/16-18 Nitro-Carb Plug Tap 1/2 Drill bit	HSS Hex Die

TAPS
BURS
BLADES



IBS, INCORPORATED

Assortments Z08

Metric Nitro-Carb Power Taps, Drill Bits & Tap & Die Tools

NITRO-CARB TAPS

Packaged in a Locking Steel Drawer for Easy Storage & Organization
IBS No. 593P • 29 Items • 29 Pcs



TAPS
BURS
BLADES



Metric Nitro-Carb Power Taps, Hex Dies and Drill Bits w/ Tools

Assortment No. 593P

<p>120925 Professional 1" Hex Die Wrench</p>		<p>120926 Professional 1" Hex Die Wrench</p>	
<p>120922 Professional Tap Wrench</p>			
<p>129934 M10-1.5 Nitro-Carb Hex Die 17711 Nitro-Carb Power Tap 17919 8.5mm Nitro-Carb Drill Bit</p>			<p>129935 M12-1.75 Nitro-Carb Hex Die 17712 Nitro-Carb Power Tap 17936 10.2mm Nitro-Carb Drill Bit</p>
<p>129931 M6-1.0 Nitro-Carb Hex Die 17709 Nitro-Carb Power Tap 17884 5mm Nitro-Carb Drill Bit</p>			<p>129933 M8-1.25 Nitro-Carb Hex Die 17710 Nitro-Carb Power Tap 17901 6.7mm Nitro-Carb Drill Bit</p>
<p>129929 M4-0.7 Nitro-Carb Hex Die 17707 Nitro-Carb Power Tap 17867 3.3mm Nitro-Carb Drill Bit</p>			<p>129930 M5-0.8 Nitro-Carb Hex Die 17708 Nitro-Carb Power Tap 17876 4.2mm Nitro-Carb Drill Bit</p>
<p>M2.5-0.45 17704 Nitro-Carb Power Tap 17854 2.05mm Nitro-Carb Drill Bit</p>	<p>M3-0.5 129928 Nitro-Carb Hex Die 17705 Nitro-Carb Power Tap 17859 2.5mm Nitro-Carb Drill Bit</p>	<p>M3.5-0.6 135590 Nitro-Carb Hex Die 17706 Nitro-Carb Power Tap 17863 2.9mm Nitro-Carb Drill Bit</p>	

Nitro-Carb Power Tap & Hex Die Sets

- **Special Hi-Tungsten and Hi-Molybdenum tool steel construction, gold surface treated** for maximum lubricity.
- **Recommended for use in production tapping and drilling** in work hardening grades of stainless steel and other hard metal applications.
- **Precision ground tap threads** for the ultimate in accuracy and performance.



24Pc METRIC NITRO-CARB POWER TAP & HEX DIE SET

IBS No.	Description
17474	SET CONTAINS:
	<ul style="list-style-type: none"> • Nitro Power Taps & Hex Die Sizes: 3.0-.50, 3.5-.60, 4.0-.70, 5.0-.80, 6.0-1.00, 8.0-1.25, 10.0-1.50 & 12.0-1.75. • HSS pipe tap & hex die size: 1/8-27 NPT • T-Handle tap wrenches: 0" - 1/4" & 3/16" - 1/2" • Straight handle tap wrench: #4 - 1/2" • Die stock & screw metric pitch gauge. • Packaged in a sturdy molded plastic case.



Professional Straight Handle Tap Wrench (T03)

- Solid construction for long life and ease of use.
- Straight handle design provides greater leverage, especially when using larger diameter taps.
- Ideal for hand tapping.



IBS No.	Description
120922	For Taps #0 to 1/2" (3mm to 12mm)
120923	For Taps #1/4" to 3/4" (6mm to 18mm)
120924	For Taps #1/2 to 1-1/8" (12mm to 28mm)

Professional Hex Die Wrench (T03)

- Maintains alignment for accurate, straight threading.
- Dies easily lock in position with set screw



IBS No.	Description
120925	For 1" Hexagon Dies
120926	For 1-7/16 Hexagon Dies

T-Handle Tap Wrench

- Designed for use with taps and on many other tools to be turned by hand.
- Adjusted and tightened to size by twisting knurled nut.
- Sliding T-Wrench Handle.
- Additional holding jaws are recessed and inside hole for trapping onto small sized taps.
- T-Handle may be extended full length in either direction for more leverage.
- Sliding T-handle has spring tension stop.



IBS No.	Description
120920	For Taps #0 to 1/4" (3mm to 6mm)
120921	For Taps #3/16 to 1/2" (4mm to 12mm)

T-Handle Ratcheting Tap Wrenches

- Adjustable T-Handle may be slipped from side to side for positioning convenience and added leverage in tight spaces.
- It can be easily set for left or right handed operation, or locked for non-ratcheting use.
- Available in sizes to fit 1/16" up to 1/2" taps, and in extended lengths up to 12" for hard-to-reach areas.
- Designed for use with taps, reamers, screw extractors and other tools with a square shank.



IBS No.	Description
120930	1/16 -1/4 Ratcheting Tap Wrench
120931	1/4 -1/2 Ratcheting Tap Wrench
120932	1/16 -1/4 x 10 Ratcheting Tap Wrench
120933	1/4 -1/2 x 12 Ratcheting Tap Wrench

Tapping Tool & Guide

Perfect alignment provided for close tolerances and perpendicularity between the hardened sleeve of the tapper and the inside of the tapping guide.

Stops tap breakage.

- Carbonitrided jaws for long life.
- Center drill on stem for floating center.
- Sliding T-Wrench Handle.
- 120° Vees on Aligner Body Base to accept round parts.
- Slotted body serves as wrench for tightening when changing jaws.

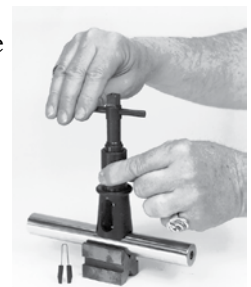

IBS No.	Description
17050	Tapping Tool & Guide

TAPS
BURS
BLADES



IBS, INCORPORATED

Nitro-Carb Hex Dies P10

Nitro-Carb Hex Dies

T
A
P
S
B
U
R
S
B
L
A
D
E
S

- Hi-Molybdenum tool steel construction for maximum life.
- Nitro-Carburized finish at 950°F to be measurably harder than high speed steel.
- Nitro-Carb dies are designed to last 5 times longer than their carbon steel equivalent.
- Polished gold flats with black surface treated threads for long life and rich appearance.
- Hex configuration allows both wrench and die stock use in threading — more universal than round dies.
- 4-40 through 1/2" have a 1" O.D.; 9/16" through 3/4" have a 1-7/16" O.D.



COARSE THREAD

IBS No.	Thread	Width Across Flats	Die Wrench
129904	4-40	1" Hex	120925
129905	6-32	1" Hex	120925
129906	8-32	1" Hex	120925
129907	10-24	1" Hex	120925
129908	12-24	1" Hex	120925
129909	1/4-20	1" Hex	120925
129910	5/16-18	1" Hex	120925
129911	3/8-16	1" Hex	120925
129912	7/16-14	1" Hex	120925
129913	1/2-13	1" Hex	120925
129914	9/16-12	1-7/16" Hex	120926
129915	5/8-11	1-7/16" Hex	120926
129916	3/4-10	1-7/16" Hex	120926

PIPE THREAD

IBS No.	Thread	Width Across Flats	Die Wrench
129926	1/8 NPT	1" Hex	120925
129927	1/4-18 NPT	1-7/16" Hex	120926



FINE THREAD

IBS No.	Thread	Width Across Flats	Die Wrench
129917	10-32	1" Hex	120925
129918	1/4-28	1" Hex	120925
129919	5/16-24	1" Hex	120925
129920	3/8-24	1" Hex	120925
129921	7/16-20	1" Hex	120925
129922	1/2-20	1" Hex	120925
129923	9/16-18	1-7/16" Hex	120926
129924	5/8-18	1-7/16" Hex	120926
129925	3/4-16	1-7/16" Hex	120926



METRIC THREAD

IBS No.	Thread	Width Across Flats	Die Wrench
129928	M3-.05	1" Hex	120925
135590	M3.5-.60	1" Hex	120925
129929	M4-.07	1" Hex	120925
129930	M5-.08	1" Hex	120925
129931	M6-1.0	1" Hex	120925
129933	M8-1.25	1" Hex	120925
129934	M10-1.5	1" Hex	120925
129935	M12-1.75	1-7/16" Hex	120926

Nitro Carb Hex Dies are sold in packages of 1

IBS, INCORPORATED

Hole Saws & Cutters P28



IBS Carbide Tipped Annular Cutters 1-3/8" & 2" Cutting Depth

IBS carbide tipped annular cutters maximize the cutting performance of any portable magnetic drill press. Their superior "Triple Edge" cutting action outperforms ordinary high speed steel annular cutters and twist drills 6 to 1.

Annular cutters offer an alternative to reaming and can be used in applications where hole saws are limited by depth.

Ideal for making large holes in thick steel.

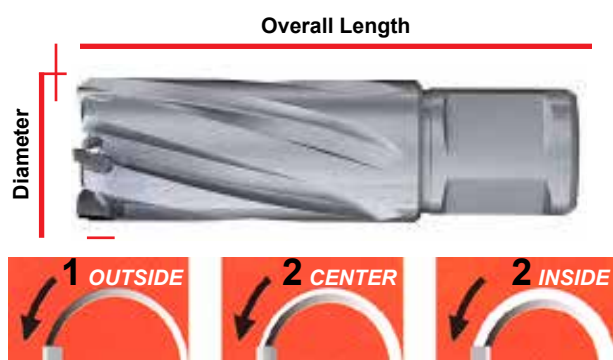

Triple Edge Cutters — Superior ultra-hard tungsten carbide tips, balanced in three different positions permit higher feed rates and increased hole making in structural steel and steel plate.

Features & Benefits:

- Ultra-hard tungsten carbide teeth permit faster cutting even in tough materials and shapes.
- Cut clean, bur-free holes; precision pilot ejects the center as a plug of steel.
- Features "Weldon-style" flats for fast loading and better rigidity.

Applications:

- For use with magnetic drill presses to cut holes in cast iron steel, and ultra-hard or exotic alloys.
- 1-3/8" Cutting Depth — for drilling holes up to 1-3/8" deep and 9/16" to 2-1/16" diameter.
- 2" Cutting Depth — for drilling holes up to 2" deep and 9/16" to 2 1/16" diameter with high precision and speed.
- Produce overlapping and interrupted holes easily.
- Ideal for crescent cuts on pipe ends.



1-3/8" Carbide Tipped 2" Carbide Tipped

IBS No.	Size	Usable Length	IBS No.	Size	Usable Length
19102	9/16	1"	19132	9/16	2"
19103	5/8	1"	19133	5/8	2"
19104	11/16	1"	19134	11/16	2"
19105	3/4	1"	19135	3/4	2"
19106	13/16	1"	19136	13/16	2"
19107	7/8	1"	19137	7/8	2"
19108	15/16	1"	19138	15/16	2"
19109	1	1"	19139	1	2"
19110	1-1/16	1"	19140	1-1/16	2"
19111	1-1/8	1"	19141	1-1/8	2"
19112	1-3/16	1"	19142	1-3/16	2"
19113	1-1/4	1"	19143	1-1/4	2"
19114	1-5/16	1"	19144	1-5/16	2"
19115	1-3/8	1"	19145	1-3/8	2"
19116	1-7/16	1"	19146	1-7/16	2"
19117	1-1/2	1"	19147	1-1/2	2"
19118	1-9/16	1"	19148	1-9/16	2"
19119	1-5/8	1"	19149	1-5/8	2"
19120	1-11/16	1"	19150	1-11/16	2"
19121	1-3/4	1"	19151	1-3/4	2"
19122	1-13/16	1"	19152	1-13/16	2"
19123	1-7/8	1"	19153	1-7/8	2"
19124	1-15/16	1"	19154	1-15/16	2"
19125	2	1"	19155	2	2"
19126	2-1/16	1"	19156	2-1/16	2"

1-3/8" Accessories

2" Accessories

19339	Pilot Pin for 7/16" & 1/2"	19453	Pilot Pin for 7/16" & 1/2"
19345	Pilot Pin for 9/16" or larger	19470	Pilot Pin for 9/16" or larger

All IBS part numbers in **bold print** are stock items
All IBS part numbers not in **bold print** require 1 week lead time

T
A
P
S
B
U
R
S
B
L
A
D
E
S



IBS, INCORPORATED

Hole Saws & Cutters P28

Carbide Tipped Annular Cutter Sets

1" & 2" Cutting Depth
6 Pc Sets

Packaged a Molded Plastic Case for Easy Storage
& Organization



1" CARBIDE TIPPED ANNULAR CUTTER SET
IBS No. 19465

IBS No.	Size	Usable Length
19104	11/16	1"
19106	13/16	1"
19108	15/16	1"
19109	1	1"
19110	1-1/16	1"
19435	Pilot Pin for 1"	



2" CARBIDE TIPPED ANNULAR CUTTER SET
IBS No. 19466

IBS No.	Size	Usable Length
19134	11/16	2"
19136	13/16	2"
19138	15/16	2"
19139	1	2"
19140	1-1/16	2"
19470	Pilot Pin for 2"	

T
A
P
S

B
U
R
S

B
L
A
D
E
S

IBS, INCORPORATED

Hole Saws & Cutters P28



IBS High Speed Steel Annular Cutters

1" & 2" Cutting Depth

IBS High Speed Steel Annular Cutters are made in the USA and are the highest quality cutters available on the market. The exclusive CNC machining and heat treating process used to manufacture IBS cutters provide extreme drilling performance, ensuring longer cutter life and efficient hole drilling, while maintaining precise bore tolerances.



- IBS HSS Annular Cutters come **WITH a pilot pin**, eliminating the need for finding and assembling for improved productivity and faster change-outs, saving time and money.
- **MADE IN THE USA of high quality M2 Steel** for optimum performance for longer life and more cuts in standard steel drilling applications, saving time and money.
- **HSS is non-sensitive to shock or impact** as compared to carbide — making them more durable in applications not requiring carbide.
- Stocked in 1" and 2" depth of cut, (also available NONSTOCK in 3" depth).

PILOT PINS

- Pilot pin included with cutter
- Allow coolant to flow to center of cutter during drilling cycle.
- Eject slug from center of cutter after the drilling cycle.
- Align cutters to desired drilling position.

1" Cutter			2" Cutter		
IBS No.	Size	Usable Length	IBS No.	Size	Usable Length
19396	7/16	1"	19426	7/16	2"
19397	1/2	1"	19427	1/2	2"
19346	9/16	1"	19471	9/16	2"
19347	5/8	1"	19472	5/8	2"
19348	11/16	1"	19473	11/16	2"
19349	3/4	1"	19474	3/4	2"
19350	13/16	1"	19475	13/16	2"
19351	7/8	1"	19476	7/8	2"
19352	15/16	1"	19477	15/16	2"
19353	1	1"	19478	1	2"
19354	1-1/16	1"	19479	1-1/16	2"
19355	1-1/8	1"	19480	1-1/8	2"
19356	1-3/16	1"	19481	1-3/16	2"
19357	1-1/4	1"	19482	1-1/4	2"
19358	1-5/16	1"	19483	1-5/16	2"
19359	1-3/8	1"	19484	1-3/8	2"
19360	1-7/16	1"	19485	1-7/16	2"
19361	1-1/2	1"	19486	1-1/2	2"
19362	1-9/16	1"	19487	1-9/16	2"
19363	1-5/8	1"	19488	1-5/8	2"
19364	1-11/16	1"	19489	1-11/16	2"
19365	1-3/4	1"	19490	1-3/4	2"
19366	1-13/16	1"	19491	1-13/16	2"
19367	1-7/8	1"	19492	1-7/8	2"
19368	1-15/16	1"	19493	1-15/16	2"
19369	2	1"	19494	2	2"
19370	2-1/16	1"	19495	2-1/16	2"

1" Accessories		2" Accessories	
19339	Pilot Pin for 7/16" & 1/2"	19453	Pilot Pin for 7/16" & 1/2"
19345	Pilot Pin for 9/16" or large	19470	Pilot Pin for 9/16" or larger

T
A
P
S
B
U
R
S
B
L
A
D
E
S



IBS, INCORPORATED

Hole Saws & Cutters P15

IBS High Speed Steel Annular Cutter 6 & 12 Pc Sets

1" & 2" Cutting Depth

Packaged in a Molded Plastic Case for Easy Storage & Organization



6 PC 1" IBS HSS ANNULAR CUTTER SET
IBS No. 19420

IBS No.	Size	Usable Length
19346	9/16	1"
19348	11/16	1"
19350	13/16	1"
19352	15/16	1"
19354	1-1/16	1"
19345	Pilot Pin for 9/16 or larger	



6 PC 2" IBS HSS ANNULAR CUTTER SET
IBS No. 19422

IBS No.	Size	Usable Length
19471	9/16	2"
19473	11/16	2"
19475	13/16	2"
19477	15/16	2"
19479	1-1/16	2"
19470	Pilot Pin for 9/16 or larger	



12 PC 1" IBS HSS ANNULAR CUTTER SET
IBS No. 19421

IBS No.	Size	Usable Length
19396	7/16	1"
19397	1/2	1"
19346	9/16	1"
19347	5/8	1"
19348	11/16	1"
19349	3/4	1"
19350	13/16	1"
19351	7/8	1"
19352	15/16	1"
19353	1	1"
19354	1-1/16	1"
19339	Pilot Pin for 7/16" & 1/2"	
19345	Pilot Pin for 9/16 or larger	



12 PC 2" IBS HSS ANNULAR CUTTER SET
IBS No. 19423

IBS No.	Size	Usable Length
19426	7/16	2"
19427	1/2	2"
19471	9/16	2"
19472	5/8	2"
19473	11/16	2"
19474	3/4	2"
19475	13/16	2"
19476	7/8	2"
19477	15/16	2"
19478	1"	2"
19479	1-1/16	2"
19453	Pilot Pin for 7/16" & 1/2"	
19470	Pilot Pin for 9/16 or larger	

T
A
P
S

B
U
R
S

B
L
A
D
E
S



M42 THIN WALL HOLE SAWS

IBS No.	Description
29290	3/4 M42 Thin Wall Hole Saw
29291	7/8 M42 Thin Wall Hole Saw
29292	1" M42 Thin Wall Hole Saw
29293	1-1/8 M42 Thin Wall Hole Saw
29294	1-1/4 M42 Thin Wall Hole Saw
29295	1-3/8 M42 Thin Wall Hole Saw
29296	1-1/2 M42 Thin Wall Hole Saw
4CREDIT	Used Trade-A-Blade Credit

- Innovative Design** — Impact rated hole cutter makes these far more aggressive at cutting sheet metal and other thin metals. Rated for impact tools and coupled with thin all, these cut many times faster than a standard hole saw or special sheet metal hole cutter like the slugger.
- 1/4" Hex Shank Quick Change Versatility** — Can be used with a wide range of air, corded or cordless tools, including impact tools. Can be used with hex shank adaptors, quick releases and extensions.
- Thin Wall** — The thin wall 3TPI design makes these hole saws cut extremely fast compared to other hole saws that have to remove more material due to the thicker wall design. They leave a burr-free cut that is faster and cleaner than standard bi-metal hole saws.
- M42 Bi-Metal with 8% Cobalt** — M42 Bi-Metal with Cobalt has increased wear resistance and added tooth strength. This combination has proven to be excellent for steel and metal cutting applications across several platforms (bandsaw, recip, etc.). M42 Bi-Metal is highly resistant to wear or breakage so it stays sharp longer and provides a fast cutting over a long life.
- Built-in pilot drill with spring** for immediate slug ejection — unlike most hole saws that require effort after the cut to remove the slug, the ejection spring makes slug removal fast and effortless, boosting productivity.
- Stop shoulder design** has built-in collar to prevent the saw from over-drilling or popping through the work — preventing damage to things like electrical wires and components when drilling through existing panels in service equipment.
- Optimized for applications in thin gauge metal** up to 1/8" thick.

NOTE: Our Trade-a-Blade™ system is simple! The Trade-a-Blade™ system rewards our users by giving them a 'Trade Credit' toward the purchase of another Trade-a-Blade™ product. This is an easy and a cost effective way for customers to save money.

Receive a \$4 credit toward the purchase of a new M42 Thin Wall Hole Saw when turning in a used one.

Limit - One \$4 credit for each new M42 Thin Wall Hole Saw purchased.

The used M42 Thin Wall Hole Saws can be turned into your salesperson for credit when placing an order for a new one. The \$4 credit will be reflected on the invoice with the new M42 Thin Wall Hole Saws.



M42 Thin Wall Hole Saws Travel Tray Assortment

PACKAGED IN A PLASTIC TRAVEL TRAY

IBS No. 820R • 7 Items • 7 Pcs

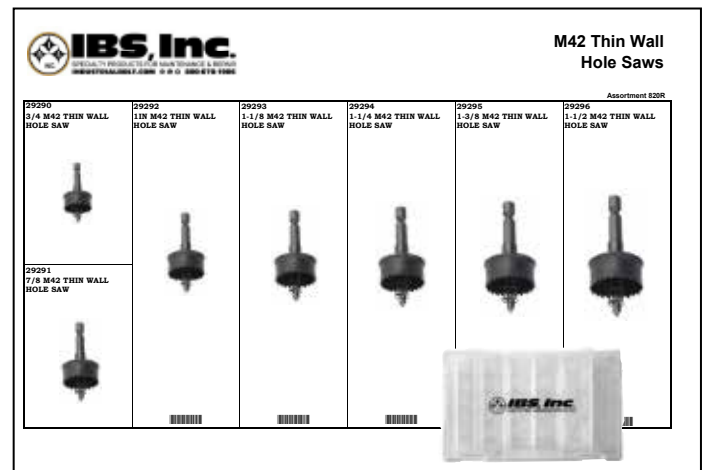

T
A
P
S
B
U
R
S
B
L
A
D
E
S



IBS, INCORPORATED

Hole Saws & Cutters P28

Sheet Metal Slugger Cutters

Thin Metal Cutters

While Supplies Last

Slugger Thin Metal Cutters accurately produce holes in sheet metal, light tubing, rubber, fiber materials and select plastics. Designed for use with hand held drilling equipment.

Slugger Thin Metal Cutters drill up to three times faster than hole saws and have superior tool life. Center-free design eliminates deflection and leaves a smooth bore in work pieces. The arbor system quickly installs to most hand drills, accepting a full range of cutters. Cutters lock securely into the arbor, replacing inaccurate older style thread-on tools.

Applications include: HVAC, PHCC, electrical and maintenance work.



T
A
P
S

B
U
R
S

B
L
A
D
E
S

COMPARE THIN METAL SLUGGER CUTTERS TO HOLE SAWS:

- Drills holes three times faster than hole saws, saving time and money.
- Cuts the outer "slug" of a hole, giving superior tool life compared to standard drills.
- Does not bore out a hole for a cleaner and more accurate hole finish.
- Precision ground teeth for sharper, cleaner cuts.
- Reduced grabbing and tearing means minimum material deformation and a hole requiring less finishing work.

SHEET METAL SLUGGER CUTTERS

IBS No.	Diameter	Decimal Equiv.	Depth Cut	Qty
29191	3/8	.3750	1/4	1
29195	5/8	.6250	1/4	1



SLUGGER CUTTER ACCESSORIES

IBS No.	Description
29075	Pilot Pin
14993	3mm Hex Key (L01)



Carbide Tipped Cutters

For Thin Steel Applications — Up to 3/16" Thick

The fastest and smoothest way to cut holes in thin steel, these carbide tipped hole saws are the perfect workmate for the professional electrician, plumber, mechanic and general contractor.



Features & Benefits:

- **Built-in ejector spring and pilot drill** — for quick smooth discharge of metal slug and optimal productivity.
- **Special Tungsten Carbide Teeth** provide increased wear resistance resulting in a saw that will **outlast and outperform** traditional bi-metal saws, step drills, and other tools by as much as **10 to 1**.
- **Carbide Teeth Cut Clean** — which means less resistance and up to three times less energy drained when using a cordless drill, for more cuts in a charge — saving time and money.
- **Safety Collar Stop** — prevents over penetration of the work piece and provides better rigidity for clean, bur-free cutting with quicker and easier removal.
- **One Piece Construction** —for stable, accurate cutting, resulting in crisp cuts without burs.

Applications:

- **Quickly cuts holes in materials up to 3/16" thick**
Thin Steel Plate Iron
Aluminum Copper
Cast Iron Stainless Steel
- **Cleanly cuts holes (9/16 up to 5" diameter) in:**
Junction Boxes Switch Boxes
Metal Studs Electrical Appliances
Lighting Fixtures Pipe
Ideal for auto, truck & body repair
- **Producing overlapping and uninterrupted holes easily.**

CARBIDE TIPPED CUTTERS CUTS 3/16" DEPTH

Includes Hole Saw, Arbor and Pilot Drill

IBS No.	Shank	Cut	IBS No.	Shank	Cut
19200	3/8"	9/16	19226	3/8"	2-3/16
19201	3/8"	5/8	19227	3/8"	2-1/4
19202	3/8"	11/16	19228	3/8"	2-5/16
19203	3/8"	3/4	19229	3/8"	2-3/8
19204	3/8"	13/16	19230	3/8"	2-7/16
19205	3/8"	7/8	19231	3/8"	2-1/2
19206	3/8"	15/16	19232	3/8"	2-9/16
19207	3/8"	1	19233	3/8"	2-5/8
19208	3/8"	1-1/16	19234	1/2"	2-11/16
19209	3/8"	1-1/8	19235	1/2"	2-3/4
19210	3/8"	1-3/16	19236	1/2"	2-13/16
19211	3/8"	1-1/4	19237	1/2"	2-7/8
19212	3/8"	1-5/16	19238	1/2"	2-5/16
19213	3/8"	1-3/8	19239	1/2"	3
19214	3/8"	1-7/16	1923902	1/2"	3-1/4
19215	3/8"	1-1/2	1923903	1/2"	3-3/8
19216	3/8"	1-9/16	1923904	1/2"	3-1/2
19217	3/8"	1-5/8	1923906	1/2"	3-3/4
19218	3/8"	1-11/16	1923908	1/2"	4
19219	3/8"	1-3/4	1923909	1/2"	4-1/8
19220	3/8"	1-13/16	1923910	1/2"	4-1/4
19221	3/8"	1-7/8	1923912	1/2"	4-1/2
19222	3/8"	1-15/16	1923913	1/2"	4-3/4
19223	3/8"	2	1923914	1/2"	5
19224	3/8"	2-1/16			
19225	3/8"	2-1/8			

CT CUTTERS™ 3/16" Depth ACCESSORIES

19240	Pilot Drill
19241	Ejector Spring - 3/16" Depth
19242	Pilot Drill - Carbide Tipped for Ductile Pipe

T
A
P
S

B
U
R
S

B
L
A
D
E
S



IBS, INCORPORATED

Hole Saws & Cutters P28

Carbide Tipped Hole Cutters For Thick Steel Applications Up to 1" Thick

The ultimate way to cut holes in thick steel, this long tip carbide hole saw is the new "Contractor's Helper." Cutting quick, accurate holes in pipe or drilling through thick steel are no longer a problem with the triple edge cutting power of our Carbide Tipped Hole Cutters.



Features & Benefits:

- **Built-in ejector spring and pilot drill** — for quick smooth discharge of metal slug and optimal productivity.
- **Special Tungsten Carbide Teeth** provide increased wear resistance resulting in a saw that will **outlast and outperform** traditional bi-metal saws, step drills, and other tools by as much as **10 to 1**.
- **Carbide Teeth Cut Clean** — which means less resistance and up to three times less energy drained when using a cordless drill, for more cuts in a charge — saving time and money.
- **Safety Collar Stop** — prevents over penetration of the work piece and provides better rigidity for clean, bur-free cutting with quicker and easier removal.
- **One Piece Construction** —for stable, accurate cutting, resulting in crisp cuts without burs.

Applications:

- **Quickly cuts holes in materials up to 1" thick**
 - Thin Steel Plate Iron
 - Aluminum Copper
 - Cast Iron Stainless Steel
- **Cleanly cuts holes (9/16 up to 3" diameter) in:**
 - Junction Boxes Switch Boxes
 - Metal Studs Electrical Appliances
 - Lighting Fixtures Pipe
 - Ideal for auto, truck & body repair
- **Producing overlapping and uninterrupted holes easily.**

CARBIDE TIPPED HOLE CUTTERS CUTS 1" DEPTH

Includes Hole Saw, Arbor and Pilot Drill

IBS No.	Shank	Cut	IBS No.	Shank	Cut
19249	3/8"	9/16	19265	3/8"	1-9/16
19250	3/8"	5/8	19266	3/8"	1-5/8
19251	3/8"	11/16	19267	3/8"	1-11/16
19252	3/8"	3/4	19268	3/8"	1-3/4
19253	3/8"	13/16	19269	3/8"	1-13/16
19254	3/8"	7/8	19270	3/8"	1-7/8
19255	3/8"	15/16	19271	3/8"	1-15/16
19256	3/8"	1	19272	3/8"	2
19257	3/8"	1-1/16	1927201	3/8"	2-1/8
19258	3/8"	1-1/8	1927202	3/8"	2-1/4
19259	3/8"	1-3/16	1927203	3/8"	2-3/8
19260	3/8"	1-1/4	1927204	3/8"	2-1/2
19261	3/8"	1-5/16	1927205	3/8"	2-5/8
19262	3/8"	1-3/8	1927206	3/8"	2-3/4
19263	3/8"	1-7/16	1927207	3/8"	2-7/8
19264	3/8"	1-1/2	1927208	1/2"	3

HOLE CUTTER™ 1" Depth ACCESSORIES

19273	Pilot Drill
19274	Ejector Spring - 1" Depth
19275	Pilot Drill - Carbide Tipped for Ductile Pipe

Cutter Extensions

- Extends the Carbide Tipped Hole Cutters by 4", giving access to hard-to-reach places.
- Made of precision machined tool steel for durability, stability and longer life.
- Only 2 extensions required to cover all sizes — less inventory means lower costs.



IBS No.	Description
192421	4" x 10mm Hole Cutter Extension
192422	4" x 13mm Hole Cutter Extension

T
A
P
S

B
U
R
S

B
L
A
D
E
S

IBS, INCORPORATED











Assortments Z02



5 Pc. Carbide Tipped Cutters 3/16" DEPTH

IBS No. 762R • 5 Items • 5 Pcs









Packaged in a Locking steel drawer for easy storage & organization

		Carbide Tipped Cutters 3/16" Depth Assortment No. 762R	
19205 7/8 CARBIDE TIPPED CUTTER - 3/16" DEPTH  	19209 1-1/8 CARBIDE TIPPED CUTTER - 3/16" DEPTH  	19213 1-3/8 CARBIDE TIPPED CUTTER - 3/16" DEPTH  	19219 1-3/4 CARBIDE TIPPED CUTTER - 3/16" DEPTH  
19223 2" CARBIDE TIPPED CUTTER - 3/16" DEPTH  			

4 Pc. Carbide Tipped Cutters 1" DEPTH

IBS No. 763R • 4 Items • 4 Pcs

Packaged in a Locking steel drawer for easy storage & organization

		Carbide Tipped Cutters 1" Depth Assortment No. 763R	
19250 5/8 CARBIDE TIPPED CUTTER - 1" DEPTH  	19252 3/4 CARBIDE TIPPED CUTTER - 1" DEPTH  	19254 7/8 CARBIDE TIPPED CUTTER - 1" DEPTH  	19256 1" CARBIDE TIPPED CUTTER - 1" DEPTH  

T
A
P
S

B
U
R
S

B
L
A
D
E
S



IBS, INCORPORATED

Assortments Z02

5 Pc. Carbide Tipped Cutters 1" DEPTH

IBS No. 764R • 5 Items • 5 Pcs

Packaged in a locking steel drawer for easy storage & organization

Carbide Tipped Cutters
1" Depth

Assortment No. 764R

<p style="font-size: x-small;">19254 7/8 CARBIDE TIPPED CUTTER - 1" DEPTH</p>	<p style="font-size: x-small;">19258 1-1/8 CARBIDE TIPPED CUTTER - 1" DEPTH</p>	<p style="font-size: x-small;">19262 1-3/8 CARBIDE TIPPED CUTTER - 1" DEPTH</p>	<p style="font-size: x-small;">19268 1-3/4 CARBIDE TIPPED CUTTER - 1" DEPTH</p>
<p style="font-size: x-small;">19272 2" CARBIDE TIPPED CUTTER - 1" DEPTH</p>			

Carbide Tipped Cutter Sets (P28)



CARBIDE TIPPED CUTTER SET
3/16" Depth 5 Pcs

IBS No.	Description
19280	7/8, 1-1/8, 1-3/8, 1-3/4, & 2"



CARBIDE TIPPED CUTTER SET
1" Depth 4 Pcs

IBS No.	Description
19281	5/8, 3/4, 7/8, & 1"



CARBIDE TIPPED CUTTER SET
1" Depth 5 Pcs

IBS No.	Description
19283	7/8, 1-1/8, 1-3/8, 1-3/4, & 2"

TAPS
BURS
BLADES



Magnetic Drill Press

- The optimal drilling speed designed for use with carbide and HSS cutters on the toughest jobs and applications.
- Effective solution for drilling harder materials
- Powerful magnet for easier placement and better holding power on thinner material.
- Cost effective drill for running with Carbide cutters for longer life, higher cutting rate and capable of cutting harder materials.
- 1-3/8" maximum diameter annular cutter.
- 2" maximum drilling depth.
- 15.75" Height, 1100W, 11.5 Amp, 450-590 RPM.



IBS No.	Description
19467	Magnetic Drill Press up to 1-3/8 - 2"
19456	Arbor Adapter
19457	Drill Chuck

Compact Magnetic Drill Press

Compact with Fixed Drill Motor for Work in Confined Spaces

- **Extremely compact** with ideal power to weight ratio for work at heights and in confined spaces.
- **Hand feed wheel mounts** on either side for use in special situations.
- **Die cast aluminum housing** for strength in the field.
- **Internal motor cable routing** prevents unintended threading or hanging up on the work-piece.
- Internal Cooling.
- **Easy** guide adjustment.
- **Stationary** drill motor.
- **Quill feed spindle** eliminates field maintenance and adjustments provides positive slug ejection.
- 1-5/8 maximum diameter annular cutter.
- 2" maximum drilling depth.



IBS No.	Description
19468	Compact Magnetic Drill Press for 1-3/8 - 2"

Variable Speed / Reversible Magnetic Drill Press

Universal with 2 Speed Gearbox

For Use with 1-9/16 to 2" Annular Cutters

Compact with high functionality for universal use on the construction site and in the workshop.

- Simple and error-proof control concept in the operator's field of view.
- **Double drill motor guides** enable use of the largest core bits.
- **Reversible.**
- **Electronic speed control.**
- **High power motor** with stable speed.
- **High magnetic holding force.**
- Convenient magnetic holding force gauge.
- **Integrated cooling tank.**
- **Hand feed wheel** can be mounted on either side.



IBS No.	Description
19469	Variable Speed / Reversible Magnetic Drill Press

Slugger Cutting Fluid for Mag Drills



- Water soluble concentrate makes up to 10 quarts of cutting fluid.
- Improves surface finish and reduces heat build up when drilling — extending the life of the cutter.
- Specially designed packaging with a sight window ensures proper mixing ratios.

IBS No.	Description
19463	Slugger Cutting Fluid for Mag Drills 1 Quart
19464	Slugger Cutting Fluid for Mag Drills 1 Gallon

T
A
P
S

B
U
R
S

B
L
A
D
E
S



IBS, INCORPORATED

Hole Saws & Cutters P28

T
A
P
S

B
U
R
S

B
L
A
D
E
S

Ultra Lube Super Premium Cutting Fluid (S04)



Ultra Lube is a multi-purpose cutting fluid specially formulated to extend tool life and reduce chip welding. **Ultra Lube** also provides precision finish with closer tolerances on finished work.

- **Super concentrated formula** will not run and even clings to vertical surfaces keeping the lubricant on the tool or at the or at the drilling/cutting point for continual lubrication resulting in cooler cutting which means longer tool life, saving time and money.
- **Contains no harsh chemicals or ozone depleting chemicals** which provides a virtual smoke free operation on even the most heat prone applications for a safer, cleaner cut making for faster clean up.
- **Available in a small, easier to handle 4 oz. bottle for hand drilling applications** that is easier to apply and get the lubricant exactly where it's needed, saving user time and money.
- **16 oz. bottle perfect for larger jobs** and coolant reservoir filling.

IBS No.	Description
96050	Ultra Lube Cutting Fluid 4 oz. bottle
96070	Ultra Lube Cutting Fluid 16 oz. bottle

Rapid Core™ Ejecting Hole Saw Arbors



Our Rapid Core Ejecting Hole Saw Arbors make cutting holes a snap. This new design eliminates the need for a screwdriver or knife to dig out the core after drilling your hole. These arbors take efficiency to a whole new level.

- **Drop out the core** with the touch of the button.
- Saves time, money and eliminates the hassle of plug removal
- Delivers immediate and effortless plug removal
- Enlarge holes that are too small
- Extend pilot drill length to cut at an angle
- Durable high-speed pilot bits

Pilot Drill Bits

Rapid Core™ Ejecting Hole Saw Arbors



- Use with Rapid Core ejecting Holes Saw Arbors
- Smooth cuts even at slow speed
- Delivers immediate and effortless plug removal.

IBS No.	Description	Qty
29050	Rapid Core Ejecting Arbor for 1-1/4" to 6" dia. Hole Saws 10mm (7/16") Hex Shank	1
29051	Rapid Core Ejecting Arbor for 9/16 to 1-3/16" dia. Hole Saws 8mm (5/16") Hex Shank	1
29052	Pilot Drill Bit for 29050 Hole Saw Arbor	1
29053	Pilot Drill Bit for 29051 Hole Saw Arbor	1

IBS, INCORPORATED

Hole Saws & Cutters P28



Advanced Bi-Metal Hole Saws



Our Bi-Metal Advanced Hole Saws feature new developments in tooth design and a new manufacturing process that outperforms the competition. All IBS mandrels are interchangeable with other name brands.

- **Patent pending tooth set is designed to remove material faster** providing smoother and faster cuts saving time and money.
- **Increased cutting depth of 1-15/16** means professional users can still cut through 2x4's in one pass and other thicker applications other hole saws require multiple cuts, saving time and money.
- **Wider cap design and thicker side wall** reduces runout, vibration and prevents collapsing.
- **Innovative angled side slots provide increased leverage** for faster and easier slug removal – saving time and money.
- **Premium M42 high speed steel cutting edge with 8% cobalt** results in twice the life of other hole saws for superior life and value.
- **Made in the USA**

Applications include: steel plate, pipe (round or square), angle iron, wood, composite materials and plastics.



ADVANCED BI-METAL HOLE SAWS

IBS No.	Dia.	Arbor	IBS No.	Dia.	Arbor
29200	9/16	29036	29226	2-5/16	29034
29201	5/8	29036	29227	2-3/8	29034
29203	3/4	29036	29228	2-1/2	29034
29204	13/16	29036	29229	2-9/16	29034
29205	7/8	29036	29230	2-5/8	29034
29206	15/16	29036	29231	2-3/4	29034
29207	1"	29036	29232	2-7/8	29034
29208	1-1/16	29036	29233	3"	29034
29209	1-1/8	29036	29234	3-1/8	29034
29210	1-3/16	29036	29235	3-1/4	29034
29211	1-1/4	29034	29236	3-3/8	29034
29212	1-5/16	29034	29237	3-1/2	29034
29213	1-3/8	29034	29238	3-5/8	29034
29214	1-7/16	29034	29239	3-3/4	29034
29215	1-1/2	29034	29240	3-7/8	29034
29216	1-9/16	29034	29241	4"	29034
29217	1-5/8	29034	29242	4-1/8	29034
29218	1-11/16	29034	29243	4-1/4	29034
29219	1-3/4	29034	29245	4-1/2	29034
29220	1-13/16	29034	29246	4-3/4	29034
29221	1-7/8	29034	29247	5"	29034
29222	2"	29034	29248	5-1/2	29034
29223	2-1/16	29034	29249	6	29034
29224	2-1/8	29034			
29225	2-1/4	29034			



29070



29036



29034



29039

HOLE SAW ARBOR ADAPTER

IBS No.	Description
29070	Allows arbors with 1/2-20 thread to use saws with 5/8-18 thread. Use with 1-9/16" through 6" hole saws.

HOLE SAW ARBORS

IBS No.	Shank	Shape	Thread
29034	7/16	Hex	5/8-18
29036	1/4	Round	1/2-20

HOLE SAW ARBOR PILOT DRILL

IBS No.	Description
29039	Hole Saw Arbor Replacement Drill

T
A
P
S

B
U
R
S

B
L
A
D
E
S



IBS, INCORPORATED

Assortments Z02

T
A
P
S

B
U
R
S

B
L
A
D
E
S















Advanced Bi-Metal Hole Saws 5/8" - 2"

With Rapid Core Ejecting Arbor

IBS No. 782R • 14 Items • 14 Pcs

Packaged in a locking steel drawer for easy storage & organization



29201 5/8 HOLE SAW ADVANCED EDGE 	29209 1-1/8 HOLE SAW ADVANCED EDGE 	29217 1-5/8 HOLE SAW ADVANCED EDGE 	29050 RAPID CORE EJECTING ARBOR FOR 1-1/4 TO 6 HOLE SAWS 
29203 3/4 HOLE SAW ADVANCED EDGE 	29211 1-1/4 HOLE SAW ADVANCED EDGE 	29219 1-3/4 HOLE SAW ADVANCED EDGE 	29051 RAPID CORE EJECTING ARBOR FOR 9/16 - 1-3/16 DIAM HOLE SAWS 
29205 7/8 HOLE SAW ADVANCED EDGE 	29213 1-3/8 HOLE SAW ADVANCED EDGE 	29222 2" HOLE SAW ADVANCED EDGE 	29052 PILOT DRILL BIT FOR 29050 
29207 1" HOLE SAW ADVANCED EDGE 	29215 1-1/2 HOLE SAW ADVANCED EDGE 		29053 PILOT DRILL BIT FOR 29051 

Advanced Bi-Metal Hole Saws 5/8" to 2"

with Rapid Core Ejecting Arbors

Assortment No. 782R









Advanced Bi-Metal Hole Saws 2-1/8" - 4"

With Rapid Core Ejecting Arbor

IBS No. 783R • 8 Items • 8 Pcs

Packaged in a locking steel drawer for easy storage & organization



29224 2-1/8 HOLE SAW ADVANCED EDGE 	29228 2-1/2 HOLE SAW ADVANCED EDGE 	29237 3-1/2 HOLE SAW ADVANCED EDGE 	29050 RAPID CORE EJECTING ARBOR FOR 1-1/4 TO 6 DIAM. HOLE SAWS 
29225 2-1/4 HOLE SAW ADVANCED EDGE 	29233 3" HOLE SAW ADVANCED EDGE 	29241 4" HOLE SAW ADVANCED EDGE 	29052 PILOT DRILL FOR 29050 

Advanced Bi-Metal Hole Saws 2-1/8" to 4"

with Rapid Core Ejecting Arbors

Assortment No. 783R

















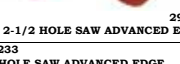

Advanced Bi-Metal Hole Saws 3/4" - 4"

With Rapid Core Ejecting Arbor

IBS No. 784R • 18 Items • 18 Pcs

Packaged in a locking steel drawer for easy storage & organization



29203 3/4 HOLE SAW ADVANCED EDGE 	29217 1-5/8 HOLE SAW ADVANCED EDGE 	29225 2-1/4 HOLE SAW ADVANCED EDGE 	29241 4" HOLE SAW ADVANCED EDGE 
29207 1" HOLE SAW ADVANCED EDGE 	29219 1-3/4 HOLE SAW ADVANCED EDGE 	29228 2-1/2 HOLE SAW ADVANCED EDGE 	29050 RAPID CORE EJECTING ARBOR 1-1/4 - 6 DIAM HOLE SAW 
29209 1-1/8 HOLE SAW ADVANCED EDGE 	29222 2" HOLE SAW ADVANCED EDGE 	29233 3" HOLE SAW ADVANCED EDGE 	29051 RAPID CORE EJECTING ARBOR FOR 9/16 - 1-3/16 DIAM HOLE SAW 
29211 1-1/4 HOLE SAW ADVANCED EDGE 	29224 2-1/8 HOLE SAW ADVANCED EDGE 	29237 3-1/2 HOLE SAW ADVANCED EDGE 	29052 PILOT DRILL FOR 29050 
29213 1-3/8 HOLE SAW ADVANCED EDGE 			29053 PILOT DRILL FOR 29051 
29215 1-1/2 HOLE SAW ADVANCED EDGE 			

Advanced Bi-Metal Hole Saws 3/4" to 4"

with Rapid Core Ejecting Arbors

Assortment No. 784R

IBS, INCORPORATED

Assortments Z02



Advanced Bi-Metal Hole Saws 5/8" - 2"

IBS No. 729R • 14 Items • 14 Pcs

Packaged in a locking steel drawer for easy storage & organization

IBS, Inc. SPECIALTY PRODUCTS FOR MAINTENANCE & REPAIR INDUSTRIALBOLT.COM © © © 800-678-1906				Advanced Bi-Metal Hole Saws 5/8" to 2"	
Assortment No. 729R					
29201 5/8 HOLE SAW ADVANCED EDGE	29209 1-1/8 HOLE SAW ADVANCED EDGE	29217 1-5/8 HOLE SAW ADVANCED EDGE	29036 LSS 4 H.S. ARBOR		
29203 3/4 HOLE SAW ADVANCED EDGE	29211 1-1/4 HOLE SAW ADVANCED EDGE	29219 1-3/4 HOLE SAW ADVANCED EDGE	29034 LSS 2 H.S. ARBOR		
29205 7/8 HOLE SAW ADVANCED EDGE	29213 1-3/8 HOLE SAW ADVANCED EDGE	29222 2" HOLE SAW ADVANCED EDGE	29039 1/4 PILOT DRILL		
29207 1" HOLE SAW ADVANCED EDGE	29215 1-1/2 HOLE SAW ADVANCED EDGE				

Advanced Bi-Metal Hole Saws 2-1/8" - 4"

IBS No. 730R • 8 Items • 8 Pcs

Packaged in a locking steel drawer for easy storage & organization

IBS, Inc. SPECIALTY PRODUCTS FOR MAINTENANCE & REPAIR INDUSTRIALBOLT.COM © © © 800-678-1906				Advanced Bi-Metal Hole Saws 2-1/8" to 4"	
Assortment No. 730R					
29224 2-1/8 HOLE SAW ADVANCED EDGE	29228 2-1/2 HOLE SAW ADVANCED EDGE	29237 3-1/2 HOLE SAW ADVANCED EDGE	29034 LSS 2 H.S. ARBOR		
29225 2-1/4 HOLE SAW ADVANCED EDGE	29233 3" HOLE SAW ADVANCED EDGE	29241 4" HOLE SAW ADVANCED EDGE	29039 1/4 PILOT DRILL		

Advanced Bi-Metal Hole Saws 3/4" - 4"

IBS No. 731R • 18 Items • 18 Pcs

Packaged in a locking steel drawer for easy storage & organization

IBS, Inc. SPECIALTY PRODUCTS FOR MAINTENANCE & REPAIR INDUSTRIALBOLT.COM © © © 800-678-1906				Advanced Bi-Metal Hole Saws 3/4" to 4"	
Assortment No. 731R					
29203 3/4 HOLE SAW ADVANCED EDGE	29217 1-5/8 HOLE SAW ADVANCED EDGE	29225 2-1/4 HOLE SAW ADVANCED EDGE	29237 3-1/2 HOLE SAW ADVANCED EDGE		
29207 1" HOLE SAW ADVANCED EDGE	29219 1-3/4 HOLE SAW ADVANCED EDGE	29228 2-1/2 HOLE SAW ADVANCED EDGE	29241 4" HOLE SAW ADVANCED EDGE		
29209 1-1/8 HOLE SAW ADVANCED EDGE	29222 2" HOLE SAW ADVANCED EDGE	29233 3" HOLE SAW ADVANCED EDGE	29036 LSS 4 H.S. ARBOR		
29211 1-1/4 HOLE SAW ADVANCED EDGE	29224 2-1/8 HOLE SAW ADVANCED EDGE		29034 LSS 2 H.S. ARBOR		
29213 1-3/8 HOLE SAW ADVANCED EDGE			29039 1/4 PILOT DRILL		
29215 1-1/2 HOLE SAW ADVANCED EDGE					

T
A
P
S

B
U
R
S

B
L
A
D
E
S



IBS, INCORPORATED

Assortments Z02

T
A
P
S

B
U
R
S

B
L
A
D
E
S

Advanced Bi-Metal Hole Saws Industrial Kit

IBS No. 29282 • 15 Items • 15 Pcs (P28)
Packaged in a molded plastic case



IBS No.	Description
29282	Advanced Hole Saw Industrial Kit - 15 pcs Sizes: 3/4, 7/8, 1", 1-1/4, 1-3/8, 1-1/2, 1-3/4, 2, 2-1/4, 2-1/2", 3" plus 2 arbors & pilot drills and 1 ejector spring

Advanced Bi-Metal Hole Saws Master Electricians Kit

IBS No. 29283 • 13 Items • 13 Pcs (P28)
Packaged in a metal case



IBS No.	Description
29283	Advanced Hole Saw Kit - Master Electrician 13 pcs Sizes: 7/8, 1-1/8, 1-3/8, 1-3/4, 2, 2-1/2, 3, 3-5/8, 4-1/8, 4-1/2" plus 3 arbors with pilot drills

IBS, INCORPORATED

Hole Saws & Cutters P28



Hole Saw Recommended RPM Cutting Speeds

Size (Inches)	Aluminum	Brass	Mild Steel	Cast Iron	Tool & Stainless Steel
9/16	900	790	580	400	300
5/8	825	730	550	365	275
11/16	750	665	500	330	250
3/4	690	600	460	300	230
13/16	635	560	425	280	210
7/8	585	520	390	260	195
15/16	555	495	370	245	185
1	525	470	350	235	175
1-1/16	480	435	325	215	160
1-1/8	450	400	300	200	150
1-3/16	425	380	285	190	145
1-1/4	410	360	275	180	140
1-5/16	390	345	260	175	135
1-3/8	375	330	250	165	125
1-7/16	360	315	240	160	120
1-1/2	345	300	230	150	115
1-9/16	330	290	220	145	110
1-5/8	315	280	210	140	105
1-11/16	305	270	205	135	100
1-3/4	295	260	195	130	95
1-13/16	285	250	190	125	95
1-7/8	270	240	180	120	90
2	255	230	170	115	85
2-1/16	245	220	165	110	80
2-1/8	240	210	160	105	80
2-1/4	225	200	150	100	75
2-5/16	225	195	145	100	75
2-3/8	220	190	140	95	70
2-1/2	205	180	135	90	65
2-9/16	200	175	130	85	65
2-5/8	195	170	130	85	65
2-3/4	185	160	125	80	60
2-7/8	180	160	120	80	60
3	170	150	115	75	55
3-1/8	165	140	110	70	55
3-1/4	155	140	105	70	50
3-3/8	150	130	100	65	50
3-1/2	145	130	95	65	45
3-5/8	140	120	95	60	45
3-3/4	135	120	90	60	45
3-7/8	135	120	90	60	45
4	130	110	85	55	40
4-1/8	120	110	80	55	40
4-1/4	120	110	80	55	40
4-3/8	120	100	80	50	40
4-1/2	105	100	75	50	35

Note: When sawing ferrous metals, always use a cutting fluid to insure smooth operations and prolong saw life. (Do not use cutting fluids with cast iron.)

T
A
P
S

B
U
R
S

B
L
A
D
E
S



IBS, INCORPORATED

Circular Saw Blades P11

T
A
P
S
B
U
R
S
B
L
A
D
E
S

Heavy Duty 7-1/4 Blade Deck & Nail Circular Saw Blade

Designed with specially formulated carbide tips to ensure a long cutting life in pressure treated lumber, recycled lumber, decking and flooring with hidden or embedded nails. This blade also features a reinforced shoulder design, heat vents, expansion slots, and fits various 7-1/4" portable saws, including worm drives. This blade is very popular with contractors due to its rugged design and fast cutting ability.

Ideal for Pressure Treated Lumber, Hardy Board® and concrete coated lumber — this blade will even cut nails!

FEATURES:

- Thin Kerf for Fast Cuts
- Professional Grade Carbide Construction
- Reinforced Shoulder
- Aggressive Hook Angle
- Heat Vents for Cooler Operation
- Precision Ground Carbide Tips



IBS No.	Description	Arbor	Grind
72518	7-1/4 X 18T Deck & Nail	5/8 ◊	ATB

Steel & Ferrous Metal Circular Saw Blade

Designed with a durable C-6 carbide grade and triple chip tooth grind to ensure a long cutting life in ferrous metals, such as: steel studs, angle iron, pipe, rebar, channel, flat stock, conduit and much more. Can also be used for cutting non-ferrous metals, such as aluminum, copper, and brass. Specially formulated micro grain carbide tips with titanium and tantalum last longer and leave a burr free cut with little to no sparks or dust commonly associated with abrasives. This blade cuts 5 to 10 times faster and lasts up to 30 times longer than abrasives, allowing fewer blade changes and increased production.

FEATURES:

- Professional Grade C-6 Carbide Construction
- Precision Ground Carbide Tips
- Tensioned & Hardened Steel Plate
- Surface Ground Steel Plate
- Laser Cut Expansion Slots



IBS No.	Description	Arbor	Carbide	Grind
72536	7-1/4 X 36T Steel & Ferrous Metals	5/8 ◊	C-6	TCG

Wood Cutting Circular Saw Blade

This wood cutting blade has been designed for quick, clean cutting with various portable saws, including worm drives. Ideal for cutting all types of hardwood, softwood, particle board and plywood. The aggressive hook angle and super thin kerf make for fast and easy cutting. Additional features include an anti-kickback tooth design for added safety, and heat vents for cooler operation, resulting in extended blade life. Long-lasting micro grain carbide tips are precision ground to ensure the best possible cut.

FEATURES:

- Super Thin Kerf for Fast Cuts
- Professional Grade C-2 Carbide
- Expansion Slots Prevent Warping
- Anti-Kickback Tooth Design
- Aggressive Hook Angle
- Heat Vents for Cooler Operation.
- Precision Ground Carbide Tips



IBS No.	Description	Arbor	Carbide	Grind
72524	7-1/4 X 24T Wood Cutting	5/8 ◊	C-3	ATB

Novelty Combo Blade

Designed for ripping and cross-cutting all types of hardwood, softwood, particle board and plywood with miter, chop, table and radial arm saws. The 4 & 1 tooth grind features for alternate top bevel teeth and 1 flat top raker with an anti-kickback tooth design. A large gullet space separates each tooth set and helps insure proper chip ejection. The special tooth configuration makes these blades great for both ripping and crosscutting applications.

FEATURES:

- Professional Grade C-4 Carbide Construction
- Precision Ground Carbide Tips
- Positive Hook Angle
- Tensioned and Hardened Steel Plate
- Anti-Kickback Raker Tooth
- Surface Ground Steel Plate



IBS No.	Description	Arbor	Carbide	Grind
10028	10" X 50T Carbide Combo Blade	5/8	C-4	2 & 1



Miter Saw Rip Blade

Designed for ripping all types of hardwood, softwood, and plywood with table and radial arm saw. Features precision ground micro grain carbide tips and copper plugged expansion slots for less noise and vibration. Also features an anti-kickback tooth design, aggressive hook angle, and large gullets, making it great for fast ripping applications.

FEATURES:

- Professional Grade C-4 Carbide Construction
- Copper Plugged Expansion Slots
- Aggressive Hook Angle
- Anti-Kickback Tooth Design
- Precision Ground Carbide Tips
- Tensioned & Hardened Steel Plate Construction
- Surface Ground Steel Plate



IBS No.	Description	Arbor	Carbide	Grind
100210	10" X 24T Carbide Ripping Blade	5/8	C-4	ATB

Miter Saw Blade

This fine-finishing blade has been designed for the cleanest crosscutting of all types of hardwood and soft wood with miter, chop, table and radial arm saws. Features precision ground micro grain carbide tips, for less noise and vibration. Great for cross-cutting applications where a very smooth cut is needed.

FEATURES:

- Professional Grade C-4 Carbide Construction
- Copper Plugged Expansion Slots
- Positive Hook Angle
- Precision Ground Carbide Tips
- Tensioned & Hardened Steel Plate Construction
- Surface Ground Steel Plate



IBS No.	Description	Arbor	Carbide	Grind
100230	10" X 80T Carbide Smooth Cut Blade	5/8	C-4	ATB

T
A
P
S

B
U
R
S

B
L
A
D
E
S



IBS, INCORPORATED

Circular Saw Blades P11

Slugger Carbide-Tipped Circular & Chop Saw Blades

For Use with Metal Cutting Circular and Chop Saws Only

Slugger™ industrial quality metal cutting saw blades are the finest blades available for the professional fabricator and metal worker.



- Tungsten Carbide Construction — provides exceptional wear resistance and maximum cutting life.
- Clean cutting — leaves a bur-free cut ready for use or welding. No additional grinding necessary.
- Cool Cutting — unique metallurgy of the carbide tips result in minimum heat transferred to the inner plate. Most of the heat remains with the chips collected in the unique chip collector.
- High Performance — Blades cut much faster than traditional methods saving time, labor and money.

Blades are available for clean and cool cutting of mild steel, stainless steel, and aluminum.

7-1/4" INDUSTRIAL METAL CUTTING CIRCULAR SAW BLADES - CARBIDE TIPPED

IBS No.	Blade Dia.	Teeth	Arbor	RPM	Applications
137756	7.25"	36T	20mm	3500	Circular Saw Blades for Steel
137757	7.25"	54T	20mm	3500	Circular Saw Blades for Aluminum
137758	7.25"	48T	20mm	3500	Circular Saw Blade for Stainless Steel

14" INDUSTRIAL METAL CUTTING CHOP SAW BLADES - CARBIDE TIPPED

IBS No.	Blade Dia.	Teeth	Arbor	RPM	Applications
137761	14.0"	66T	1.0"	1450	Chop Saw Blades for Steel
137762	14.0"	80T	1.0"	1450	Chop Saw Blades for Aluminum
137763	14.0"	90T	1.0"	1450	Chop Saw Blade for Stainless Steel

T
A
P
S

B
U
R
S

B
L
A
D
E
S

Circular Saws (T03)

- Increase Productivity — No milling or deburring with near surgical dry-cut technology.
- Cuts a variety of Metals, Plastic and Wood.
- Cool to the Touch — No waiting for your workpiece to cool down.
- Precise Cutting — with integrated laser sighting system (7-1/4" saw only).



Circular & Chop Saw Blades Sold Separately

7-1/4" CIRCULAR SAW

SPECIFICATIONS	7-1/4"
Part Number	137759
Cutting Capacity	2-1/4"
Weight	15 lbs.
Blade Diameter	7.25"
Arbor	3/4" (20mm)
RPM	3800
Beveling/Mitering	Beveling / 45°
Motor	120V / 1400W
Depth Adjustment	Yes
Chip Cover	1 Cover for Metal
Applications	Pipe, plate, channel, grating, roof decking, silos, emergency rescue.

- Powerful double-insulated motor for continuous loads
- Internally powered laser (no batteries required)
- Spring loaded lower guard
- Integrated chip collection
- Soft Start
- Electric Brake
- Smooth bevel and angle cutting adjustments
- Well balanced handle design for better control

INCLUDES: 1 tool case, 1 blade, 1 wrench, 1 guide plate, 1 safety eyewear, 1 ear protection, 1 instruction manual

DO NOT USE on materials thicker than 3/8" solid for aluminum, 5/16" for mild steel, or 1/4" for solid stainless steel.

14" CIRCULAR SAW

SPECIFICATIONS	14"
Part Number	137760
Cutting Capacity	4-3/4"
Weight	54 lbs.
Blade Diameter	14"
Arbor	1" (25.4mm)
RPM	1300
Beveling/Mitering	Mitering / 45°
Motor	120V / 1800 W
Depth Adjustment	Two Position Vise
Chip Cover	Chip Tray
Applications	Pipe, plate, channel, conduit angle iron, metal studs, rebar, tubing, etc..

- Low speed high torque motor
- High Precision durable steel construction
- Cast aluminum base
- Quick release table/base clamp cuts 0o to 45o
- Smooth bevel and angle cutting adjustments
- Eye protection plate
- Table/base clamp with quick release
- Depth stop
- Well balanced handle design for better control
- Integrated chip collection

INCLUDES: 1 tool case, 1 blade, 1 wrench, 1 guide plate, 1 safety eyewear, 1 ear protection, 1 instruction manual

DO NOT USE on materials thicker than 3/8" solid for aluminum, 5/16" for mild steel, or 1/4" for solid stainless steel.



IBS, INCORPORATED

Bandsaw Blades P11

General Information

- Bandsaw Blades are custom ordered to your specifications
- Allow up to 3 weeks for delivery
- All bandsaw blades are non-stock, & NON-RETURNABLE
- To order, specify the following:

1. Composition / Material: Bi-Metal or Carbon

Bi-Metal:

Bi-Metal blades are designed to cut just about anything that can be cut.

Bi-Metal blades have hardened High Speed Steel teeth that are electron beam welded to a high strength spring steel alloy backing material. The result is a durable, fatigue resistant blade that should last many times longer than carbon blades because it is able to withstand the heat when cutting steel and other alloys.



Bi-Metal blades have a variable tooth pitch which means that the blade simultaneously cut and clean to reduce friction and vibration for faster, smoother and straighter cutting.

Cutting Applications: Used on most metal working applications, carbon steel, stainless steel and ferrous metal, non-ferrous metal, alloy and tool steel, nickel brass alloy, wood, plastic, foam, titanium and just about anything that needs to be cut.

Carbon: (2 designs)

Carbon blades are mainly for non-ferrous metal, wood, plastic, and other materials.

1. Blades with 10 tpi and 1/2" width or larger are Carbon Hard Back.

Carbon Hard Back blades are constructed from one piece of carbon steel, with spring tempered back and tooth hardness of RC 04-07. The backing material resists snagging and scoring of the band and accepts heavier feed pressure and back tension than flex back, for faster, straighter cutting.

Cutting Applications: Used on wood, plastics, abrasive materials, carbon tool steels, solid structural steel, brass bronze, cast iron lead, zinc, cold rolled steel. Small to mid-sized machines.



2. Blades with 8 tpi and under 1/2" are Carbon Flex Back.

Carbon Flex Back blades are constructed from one piece of carbon steel with spring tempered back and tooth hardness of RC04—07, and back hardness of RC28—30. Excellent fatigue resistance, even at high band speeds.

Cutting Applications: Used on wood, plastics, fiberglass, mild steels, cast iron copper, lead, & aluminum. Use light duty saws with band speeds below 4,000 min.



2. Teeth Per Inch (TPI) refer to price pages

BI-METAL — VARIPITCH TOOTH		CARBON — STRAIGHT TOOTH	
Dia./ Wall / Thickness	TPI	Dia./ Wall / Thickness	TPI
Up to 3/16"	14/16	1/16" to 1/8"	24
3/16" to 3/8"	10/14	Up to 1/8"	18
1/4" to 1/2"	8/12	1/8" to 1/4"	14
1/2" to 1"	6/10	1/4" to 1/2"	10
1" to 1-1/2"	5/8	1/2" to 1"	8
1-1/2" to 3"	4/5	1" to 3"	5
3" to 5"	3/4	3" to 5"	4
5" to 8"	2/3	5" to 8"	3
8" or larger	1/2	8" or larger	Z — 1.25

3. Length — Refer to chart located in price pages

4. Width — Refer to chart located in price pages

T
A
P
S
B
U
R
S
B
L
A
D
E
S

Anatomy of a Bandsaw Blade

Although it looks like a flat piece of metal with teeth, a quality industrial band saw blade is actually a sophisticated cutting tool. Its ability to efficiently cut through tough metals, composite materials, plastics, and woods depends on a variety of interrelated factors such as the design, spacing and set of the teeth; the design and capacity of the gullets to make sure chips are efficiently removed; the composition of the backer strip; and the gage of the metal. These considerations must be taken into account when selecting the right blade for your application.

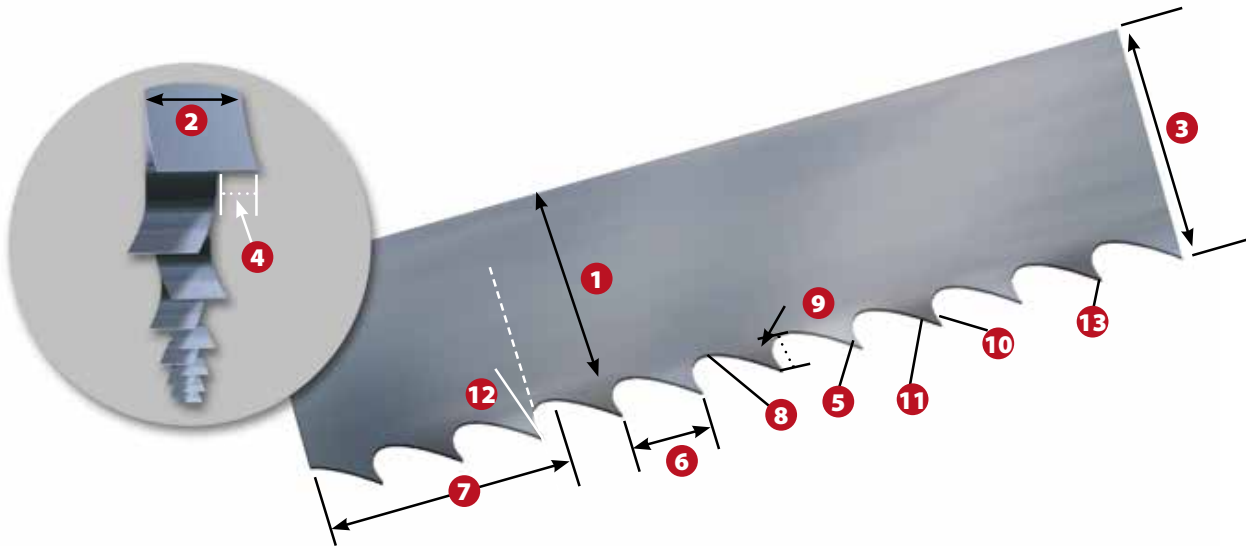

- 1 **Blade Back** The body of the blade not including tooth portion
- 2 **Gage** The thickness of the blade
- 3 **Width** The tip of tooth to back of blade
- 4 **Set** The bending of teeth right or left
- 5 **Tooth** The cutting portion of the saw blade
- 6 **Tooth Pitch** The distance from one tooth tip to the next
- 7 **T.P.I.** The number of teeth per inch measured gullet to gullet
- 8 **Gullet** The curved area between the tooth points
- 9 **Gullet Depth** The distance from the tooth tip to the bottom of the gullet
- 10 **Tooth Face** The surface of the tooth on which the chip is formed
- 11 **Tooth Flank** The angled back surface of the tooth opposite the tooth face
- 12 **Tooth Rake Angle** The angle of the tooth face measured with respect to a line perpendicular to the cutting direction of the saw
- 13 **Tooth Tip** The cutting edge of the saw tooth





IBS, INCORPORATED

Bandsaw Blades P11

Tooth Selection Guide (teeth per inch)

TAPS
BURS
BLADES

Material Size (Inches)	Teeth Per Inch	Material Size (Metric)	Wall Thickness (Inches)	Teeth Per Inch	Wall Thickness (Metric)
0		0	1/16	10/14	- 1.8
.1	14/18	2.5	1/8	8/12	- 3.2
.2	10/14	5.1	3/16	6/10	- 4.8
.3	8/12	7.6	1/4	5/8	- 6.3
.4	8/12	10.2	5/16	5/8	- 7.9
.5	6/10	12.7	3/8	5/8	- 9.5
.6	6/10	15.0	7/16	5/8	- 11.0
.7	5/8	17.8	1/2	5/8	- 12.7
.8	5/8	20.0	9/16	4/6	- 14.3
.9	5/8	22.9	5/8	4/6	- 15.8
1	5/8	25.4	11/16	4/6	- 17.5
1-1/4	4/6	31.8	3/4	3/4	- 19.0
1-1/2	4/6	38.1	13/16	3/4	- 20.6
1-3/4	4/6	44.5	7/8	3/4	- 22.0
2	4/6	50.8	15/16	3/4	- 23.8
2-1/4	3/4	57.2	1	3/4	- 25.4
2-1/2	3/4	63.5	1-1/8	3/4	- 28.6
2-3/4	3/4	69.9	1-1/4	3/4	- 32.0
3	3/4	76.2	1-3/8	2/3	- 35.0
3-1/4	3/4	82.6	1-1/2	2/3	- 38.0
3-1/2	3/4	88.9			
3-3/4	3/4	95.3			
4	3/4	101.6			
5	2/3	127.0			
6	2/3	152.4			
7	2/3	177.8			
8	2/3	203.0			
9	1.4/2.5	228.6			
10	1.4/2.5	254.0			
15	1/1.5	381.0			
30	1/1.5	762			

 **Rectangular Solids:**
(Use Width)
  **Round Solids:**
(Use Diameter)









Pipe Tubing Structurals
(Use Wall Thickness)

Cutting speed - structurals rule of thumb:

When cutting structurals use a cutting speed of
250-325 S.F.M. Wet • 200-250 S.F.M. Dry

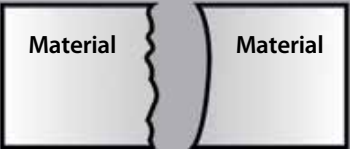
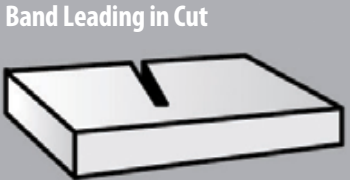

Bandsaw Blade Problem Solving

Problem	Problem Cause	Solution
 <p>Premature Blade Breakage Straight Break indicates fatigue</p>	<ul style="list-style-type: none"> • Incorrect blade - teeth too coarse • Blade tension too high • Side guides too tight • Damaged or misadjusted blade guides • Excessive feed • Incorrect cutting fluid • Wheel diameter too small for blade • Blade rubbing on wheel flanges • Teeth in contact with work before starting saw • Incorrect blade speed 	<ul style="list-style-type: none"> • Use finer tooth pitch • Reduce blade tension (see machine manual) • Check side guide clearance (see machine manual) • Check all guides for alignment/damage • Reduce feed pressure • Check coolant • Use thinner blade • Adjust wheel alignment • Allow 1/2" clearance before starting cut • Increase or decrease blade speed
 <p>Premature Dulling of Teeth</p>	<ul style="list-style-type: none"> • Teeth pointing in wrong direction / blade mounted backwards • Improper or no blade break-in • Hard spots in material • Material work hardened • Improper coolant • Improper coolant concentration • Speed too high • Feed too light • Teeth too small 	<ul style="list-style-type: none"> • Install blade correctly. If teeth are facing the wrong direction, flip blade inside out • Break in blade properly (Page 17) • Check for hardness or hard spots like scale or flame cut areas • Increase feed pressure • Check coolant type • Check coolant mixture • Check recommended blade speed (Page 24-25) • Increase feed pressure • Increase tooth size
 <p>Inaccurate Cut</p>	<ul style="list-style-type: none"> • Tooth set damage • Excessive feed pressure • Improper tooth size • Cutting fluid not applied evenly • Guides worn or loose • Insufficient blade tension 	<ul style="list-style-type: none"> • Check for worn set on one side of blade • Reduce feed pressure • Check tooth size chart (Page 23) • Check coolant nozzles • Tighten or replace guides, check for proper alignment • Adjust to recommended tension
 <p>Band Leading in Cut</p>	<ul style="list-style-type: none"> • Over-feed • Insufficient blade tension • Tooth set damage • Guide arms loose or set too far apart • Chips not being cleaned from gullets • Teeth too small 	<ul style="list-style-type: none"> • Reduce feed force • Adjust recommended tension • Check material for hard inclusions • Position arms as close to work as possible. Tighten arms. • Check chip brush • Increase tooth size
 <p>Chip Welding</p>	<ul style="list-style-type: none"> • Insufficient coolant flow • Wrong coolant concentration • Excessive speed and/or pressure • Tooth size too small • Chip brush not working 	<ul style="list-style-type: none"> • Check coolant level and flow • Check coolant ratio • Reduce speed and/or pressure • Use coarser tooth pitch • Repair or replace chip brush
 <p>Teeth Fracture Back of tooth indicates work spinning in clamps</p>	<ul style="list-style-type: none"> • Incorrect speed and/or feed • Incorrect blade pitch • Saw guides not adjusted properly • Chip brush not working • Work spinning or moving in vise 	<ul style="list-style-type: none"> • Check cutting chart (Page 24-25) • Check tooth size chart (Page 23) • Adjust or replace saw guides • Repair or replace chip brush • Check bundle configuration/adjust vise pressure
 <p>Irregular Break Indicates material movement</p>	<ul style="list-style-type: none"> • Indexing out of sequence • Material loose in vise 	<ul style="list-style-type: none"> • Check proper machine movement • Check vise or clamp

T
A
P
S
B
U
R
S
B
L
A
D
E
S





IBS, INCORPORATED

Bandsaw Blades P11

T
A
P
S
B
U
R
S
B
L
A
D
E
S

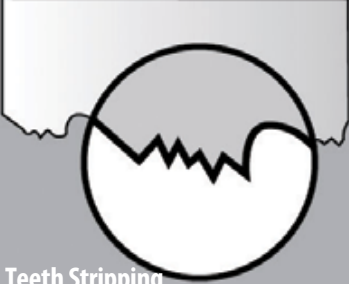
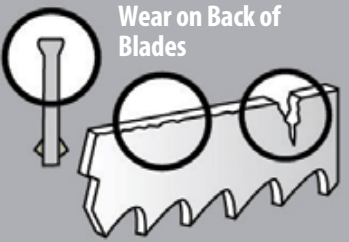
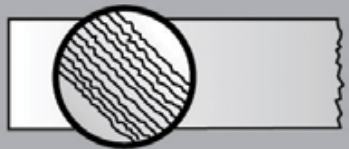
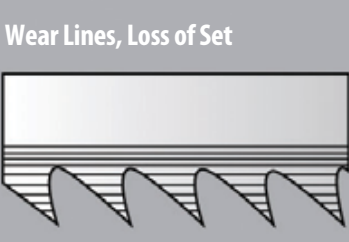
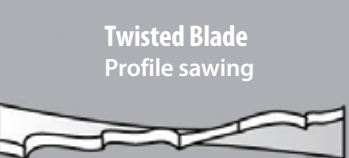
Bandsaw Blade Problem Solving

Problem	Problem Cause	Solution
 <p>Teeth Stripping</p>	<ul style="list-style-type: none"> • Feed pressure too high • Tooth stuck in cut • Improper or insufficient coolant • Incorrect tooth size • Hard spots in material • Work spinning in vise - loose nest or bundle • Blade speed too slow • Blade teeth running backwards • Chip brush not working 	<ul style="list-style-type: none"> • Reduce feed pressure • Do not enter old cut with a new blade • Check coolant flow and concentration • Check tooth size chart (Page 23) • Check material for hard inclusions • Check clamping pressure - be sure work is held firmly • Increase blade speed - see cutting chart (Page 24-25) • Reverse blade (turn inside out) • Repair or replace chip brush
 <p>Wear on Back of Blades</p>	<ul style="list-style-type: none"> • Excessive feed pressure • Insufficient blade tension • Back-up guide roll frozen, damaged, or worn • Blade rubbing on wheel flange 	<ul style="list-style-type: none"> • Decrease feed pressure • Increase blade tension and readjust guides • Repair or replace back-up roll or guide • Adjust wheel cant
 <p>Rough Cut Washboard surface Vibration and or chatter</p>	<ul style="list-style-type: none"> • Dull or damaged blade • Incorrect speed or feed • Insufficient blade support • Incorrect tooth pitch • Insufficient coolant 	<ul style="list-style-type: none"> • Replace with new blade • Increase speed or decrease feed • Move guide arms as close as possible to the work • Use finer pitch blade • Check coolant flow
 <p>Wear Lines, Loss of Set</p>	<ul style="list-style-type: none"> • Saw guide inserts or wheel flange are riding on teeth • Insufficient blade tension • Hard spots in material • Back-up guide worn 	<ul style="list-style-type: none"> • Check machine manual for correct blade width • Tension blade properly • Check material for inclusions • Replace guide
 <p>Twisted Blade Profile Profile sawing</p>	<ul style="list-style-type: none"> • Blade binding in cut • Side guides too tight • Radius too small for blade width • Work not firmly held • Erratic coolant flow • Excessive blade tension 	<ul style="list-style-type: none"> • Decrease feed pressure • Adjust side guide gap • Use narrower blade • Check clamping pressure • Check coolant nozzles • Decrease blade tension
 <p>Blade Wear Teeth blued</p>	<ul style="list-style-type: none"> • Incorrect blade • Incorrect feed or speed • Improper or insufficient coolant 	<ul style="list-style-type: none"> • Use coarser tooth pitch • Increase feed or decrease speed • Check coolant flow

IBS, INCORPORATED

Bandsaw Blades P11



Bi-Metal Portable Bandsaw Blades — Standard Pitch



BI-METAL PORTABLE BANDSAW BLADES — STANDARD PITCH

With sharp cutting edges and straight pitch teeth, these blades cut fast and last a long time with reduced breakage

IBS No.	Length		TPI	Set
	inches	mm		
447810	44-7/8 X 1/2 X .020	1140 X 12.7 X .50	10	Raker
447814	44-7/8 X 1/2 X .020	1140 X 12.7 X .50	14	Wavy
447818	44-7/8 X 1/2 X .020	1140 X 12.7 X .50	18	Wavy
447824	44-7/8 X 1/2 X .020	1140 X 12.7 X .50	24	Wavy
—	53-3/4 X 1/2 X .020	1365 X 12.7 X .50	10	Raker
—	53-3/4 X 1/2 X .020	1365 X 12.7 X .50	14	Wavy
—	53-3/4 X 1/2 X .020	1365 X 12.7 X .50	18	Wavy
—	53-3/4 X 1/2 X .020	1365 X 12.7 X .50	24	Wavy
—	53-3/4 X 1/2 X .020	1365 X 12.7 X .50	10/14	Raker

**ORDER AS NON-STOCK — NON RETURNABLE ITEM
SOLD INDIVIDUALLY**

Use on machine metals, including stainless steel, pipe, tubing and solids. Premium straight pitch blades offer high resistance to heat, wear and shock, contributing to longer blade life.

T
A
P
S

B
U
R
S

B
L
A
D
E
S



IBS, INCORPORATED

Hacksaw / Reciprocating Saw Blades P11

4-in-1 Hacksaw Frame

IBS No. 16411

The Nicholson® Pro Series 4-in-1 Hacksaw takes versatility and quality to an entirely new level. Its frame is designed to hold blades at a tension of up to 30,000 psi, for smooth and straight cuts, whether in standard, 45° angle, or low profile configurations. And while some other hacksaws have jab saw capability, the unique design of the Nicholson Pro Series accommodates a heavy duty reciprocal saw blade for maximum performance in jab saw applications.

T
A
P
S

B
U
R
S

B
L
A
D
E
S

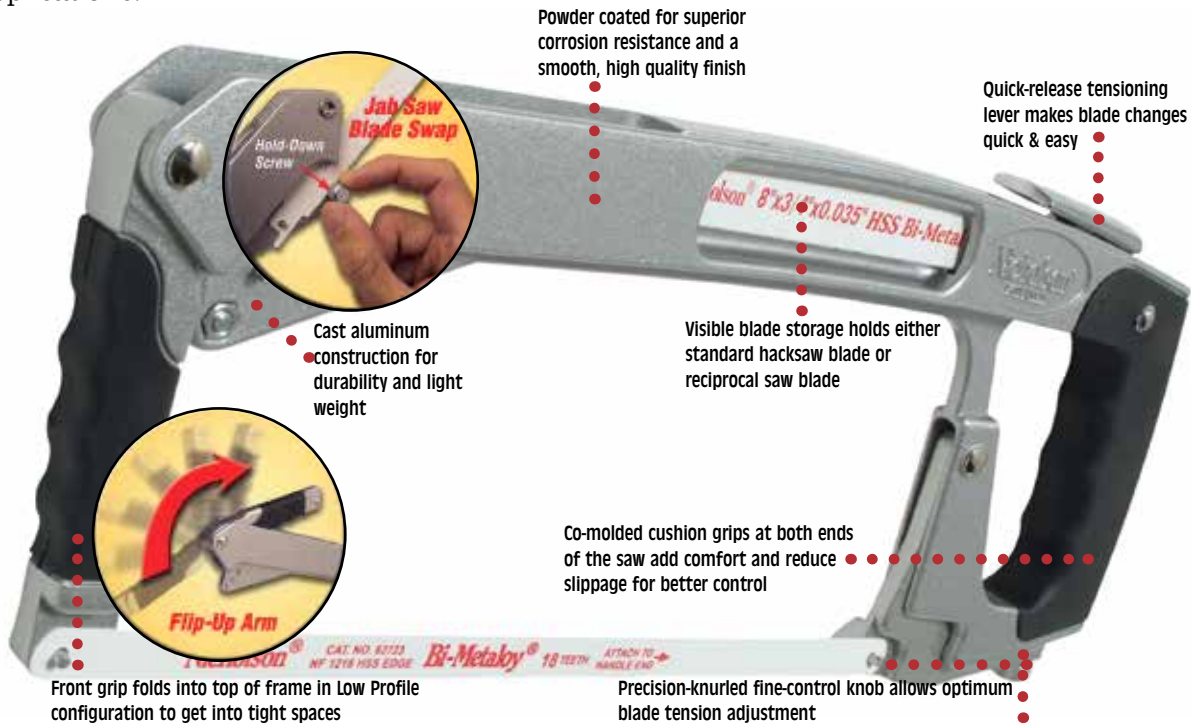

GENERAL USE

Standard 90° blade position is best for most jobs around the shop



45° ANGLE

The 45° blade position allows flush cuts and use in obstructed applications



LOW PROFILE

Low profile configuration allows quality high tension cuts in tight spaces.



JAB SAW

Heavy duty Jab Saw configuration is perfect for many close-in applications.

Four Ways to Get the Job Done!



90° Blade Position



45° Blade Position



Low Profile



Jab Saw

IBS, INCORPORATED

Hacksaw / Reciprocating Saw Blades P11



IBS Hi-Alloy Hacksaw Blades

The IBS Hi-Alloy hand hacksaw blade is the ideal combination of high, red heat hardness on the cutting edge, joined to a tough, alloy steel back with great strength and stretch resistance.

This combination, made possible by **electron beam welding**, gives performance never before attainable in any hand hacksaw blade.

The **bi-metal design** creates a shatter resistant blade with the ability to cut faster and longer because it stays sharper.

The best blade possible for cutting materials including stainless steel hardened alloys or ANYTHING that can be cut.

Manufactured in varied pitch, which means that the blade simultaneously cuts and cleans for low friction and fast cutting.



"VARI-PITCH REPEATER TEETH"

FINE COARSE FINE COARSE

IBS No.	Size	TPI	Qty
16395	12" x 1/2	18/14 tpi	10
16396	12" x 1/2	24/20 tpi	10
16398	12" x 1/2	32/26 tpi	10

Triple-Cut Hacksaw Blades

This is a hacksaw blade with **3 different pitches of teeth**.

This blade has 32 tpi at the front 1/3 of the blade, 24 tpi in the center, and 18 tpi at the back 1/3 of the blade.

This special tooth configuration allows super fast and easy starts in thin sheet metal with the 32 tpi at the front, slightly faster cutting in the middle, and really fast cutting towards the back of the blade.

- Bi-metal construction for maximum strength and resistance to bending, twisting binding, vibration and breaking.
- Super sharp Hi-Strength Alloy Teeth for easier starting, faster cutting and longer life.

Recommended Use: For use as a standard hacksaw blade, but on a wider variety of material thicknesses. Use to cut wood, plastic, or any machinable metal, including conduit, stainless steel tubing, angle iron, copper tubing, structural materials and more.

12" TRIPLE CUT 18/24/32



EXTRA-FINE FINE COARSE

IBS No.	Size	TPI	Qty
16399	12"	18/24/32 tpi	10

T
A
P
S

B
U
R
S

B
L
A
D
E
S



IBS, INCORPORATED

Assortments (Z02)

IBS Hi-Alloy & Triple-Cut Hacksaw Blades

IBS No. 785R • 4 Items • 20 Pcs

Packaged in a locking steel drawer for easy storage & organization

T
A
P
S

B
U
R
S

B
L
A
D
E
S

 IBS, Inc. <small>SPECIALTY PRODUCTS FOR MAINTENANCE & REPAIR INDUSTRIALBOLT.COM • 800-678-1906</small>		Hi-Alloy Bi-Metal Hacksaw Blades	
		Assortment No. 785R	
16395 12 18/14 HI-ALLOY HACKSAW BLADE			
16396 12 24/20 HI-ALLOY HACKSAW BLADE			
16398 12 32/26 HI-ALLOY HACKSAW BLADE			
16399 12 18/24/32 TRIPLE CUT BIMETAL HACKSAW BLADE			

IBS, INCORPORATED

Reciprocating Saw Blades (P11)



Advanced Edge Power Reciprocating Saw Blades



The Advanced Edge Power reciprocating saw blade powers through the toughest applications. This heavy duty blade is perfect for cutting any machineable metal as well as wood, wood composite, plastic or rubber.

- **1" width** for more rigidity and beam strength.
- **.042" thickness** accepts heavier feed pressure.
- **Straight tooth pitch** gives a smooth cutting action.
- **Bi-Metal construction** for long cutting life and heat and wear resistance.
- **MADE IN THE USA!**

IBS No.	Description	PKG
470610	6IN 10TPI	2
470910	9IN 10TPI	2
471210	12IN 10TPI	2
470614	6IN 14TPI	2
470914	9IN 14TPI	2
471214	12IN 14TPI	2
470618	6IN 18TPI	2
470918	9IN 18TPI	2
471218	12IN 18TPI	2



Advanced Edge Power Reciprocating Saw Blades with Tool Ease Lubricant Stick

IBS No. 840R 10 Items • 21 Pcs

Packaged in a locking steel drawer for easy storage & organization

IBS, Inc. SPECIALTY PRODUCTS FOR MAINTENANCE & REPAIR INDUSTRIALBOLT.COM © 2013 800-678-1906		Advanced Edge Power Reciprocating Saw Blades	
			Assortment No. 840R
470610 6IN X .042 10TPI ADVANDED EDGE POWER RECIP BLADE 1IN WIDTH	470910 9IN X .042 10TPI ADVANDED EDGE POWER RECIP BLADE 1IN WIDTH		
471210 12IN X .042 10TPI ADVANDED EDGE POWER RECIP BLADE 1IN WIDTH			
470614 6IN X .042 14TPI ADVANDED EDGE POWER RECIP BLADE 1IN WIDTH	470914 9IN X .042 14TPI ADVANDED EDGE POWER RECIP BLADE 1IN WIDTH		
471214 12IN X .042 14TPI ADVANDED EDGE POWER RECIP BLADE 1IN WIDTH			
470618 6IN X .042 18TPI ADVANDED EDGE POWER RECIP BLADE 1IN WIDTH	470918 9IN X .042 18TPI ADVANDED EDGE POWER RECIP BLADE 1IN WIDTH		
471218 12IN X .042 18TPI ADVANDED EDGE POWER RECIP BLADE 1IN WIDTH			74172 TOOL EASE

T
A
P
S

B
U
R
S

B
L
A
D
E
S



IBS, INCORPORATED

Hacksaw / Reciprocating Saw Blades P11

Bi-Metal Reciprocating Saw Blade

IBS Reciprocating Saw Blades are designed to fit all popular machines that take 1/2" shank. Bi-Metal blades consist of a high-speed cutting edge welded to a flexible alloy steel back. Faster cutting with sharper, harder teeth and extra-strength shank. Bi-metal blades reduce breakage and last longer than conventional carbon and all high-speed blades. Recommended for cutting steel, stainless steel, nail-embedded wood, hardwood flooring, reinforcing bar, cast iron and pipe.

T
A
P
S

B
U
R
S

B
L
A
D
E
S



Plaster with metal lathe plaster board, sheet rock, plaster walls. Tooth design cuts both forward and on backward stroke.

IBS No.	Size	TPI	Qty
44656	6" x 3/4 x .035	6 tpi	5



Wood, nail-embedded wood, compositions plastic, cast aluminum, light gauge metals.

IBS No.	Size	TPI	Qty
44610	6" x 3/4 x .035	10 tpi	5



All woods, plastic, cast aluminum, nail-embedded wood, soil pipe.

IBS No.	Size	TPI	Qty
4461014	6" x 3/4 x .050	10/14 tpi	5
4481014	8" x 3/4 x .050	10/14 tpi	5



Metal, 18 gauge and under. Trim & tubing. Galvanized pipe under 18 gauge.

IBS No.	Size	TPI	Qty
44424	4" x 3/4 x .035	24 tpi	5
44624	6" x 3/4 x .035	24 tpi	5



Wood, nail-embedded wood, compositions plastic, cast aluminum, light gauge metals.

IBS No.	Size	TPI	Qty
44606	6" x 3/4 x .050	6 tpi	5
44906	9" x 3/4 x .050	6 tpi	5
441206	12" x 3/4 x .050	6 tpi	5
44120812	12" x 3/4 x .050	8/12 tpi	5



Heavy gauge metals of 18 gauge to 1/8" thick conduit, pipe, channels and tubing.

IBS No.	Size	TPI	Qty
44418	4" x 3/4 x .035	18 tpi	5
44618	6" x 3/4 x .035	18 tpi	5
44818	8" x 3/4 x .035	18 tpi	5
44918	9" x 3/4 x .035	18 tpi	5
441018	10" x 3/4 x .035	18 tpi	5
441218	12" x 3/4 x .035	18 tpi	5
44914	9" x 3/4 x .035	14 tpi	5



Heavy gauge metals 1/8" thick and above. Barstock and angles.

IBS No.	Size	TPI	Qty
44414	4" x 3/4 x .035	14 tpi	5
44614	6" x 3/4 x .035	14 tpi	5

IBS, INCORPORATED

Hacksaw / Reciprocating Saw Blades P11



Power Curve Reciprocating Saw Blades



- Blade curvature positions teeth to cut more efficiently, resulting in a longer lasting blade
- Lasts up to twice as long as a straight blade
- Provides better performance on difficult materials, such as: nail-embedded wood, black pipe, unit-strut, and other construction materials.

IBS No.	Size	TPI	Qty
45918	9" x 3/4 x .035	18 tpi	5
45914	9" x 3/4 x .035	14 tpi	5
45904	9" x 3/4 x .035	4 tpi	5

Thick Demolition Reciprocating Saw Blades

Specially designed for the toughest demolition jobs. Cuts all woods, nail-embedded wood and metals.



THICK DEMOLITION RECIPROCATING SAW BLADES

IBS No.	Size	TPI	Qty
460906	9" x 7/8 x .062	6 tpi	2
460910	9" x 7/8 x .062	10 tpi	2
461206	12" x 7/8 x .062	6 tpi	2
461210	12" x 7/8 x .062	10 tpi	2

Bore Blades™ Double Edge Bi-Metal Reciprocating Saw Blades

- **Double-sided** — so it cuts 3 ways making it versatile to cut in multiple directions and plunge cut saving users time and money.
- **Made with 8% cobalt** for exceptional strength and durability to provide long-lasting metal and wood cutting saving money on additional blades.
- **Round plunging tip** with ease to eliminate the need to drill first — saving the user time and money.
- **Double-edged blade cuts both ways** — just change direction as needed, saving the user time & money
- **Each blade has different TPI on each side** making them two blades for the cost of one — saving time and money on blade changeouts.



IBS No.	Size	TPI	Qty
446710	6"	6 x 10 tpi	5
446711	6"	14 x 18 tpi	5
448710	8"	6 x 10 tpi	5
448711	8"	10 x 14 tpi	5
4410710	10"	8/12 x 10 tpi	5

Tungsten Carbide Grit Reciprocating Saw Blades

Cutting edges have carbide grains bonded to an alloy backer and will not snag. Their super resistance to heat and shock make them ideal for materials too hard or abrasive for standard metal blades.

Recommended Use: Cutting fiberglass, lathe, plaster, ceramics, laminates, marble and hardened steel.



IBS No.	Size	Qty
45499	4" x 3/4	2
45699	6" x 3/4	2
45899	8" x 3/4	2

T
A
P
S

B
U
R
S

B
L
A
D
E
S



IBS, INCORPORATED

Hacksaw / Reciprocating Saw Blades (P11)

T
A
P
S
B
U
R
S
B
L
A
D
E
S

Reciprocating Saw Handle

- Instantly turn any standard reciprocating saw blade into a hand saw!
- Ergonomic handle with angled setting for additional leverage.
- Quick-twist lock securely holds any standard reciprocating saw blade or any 1/4" hex shank bit.
- Converts to a multi-bit screwdriver — handle stores 6 of the most popular bits: #5 & #6 Slotted, #1 & #2 Phillips and T15 and T20 Torx.
- Use to cut metal, wood, drywall and much more.



IBS No.	RECIPROCATING SAW HANDLE	
44600	Reciprocating Saw Handle	1

Reciprocating Saw Handle & Blade Kit

IBS No. 706R • 7 Items • 11 Pcs (Z03)







Packaged in a plastic drawer for easy storage and organization



IBS, Inc.
SPECIALTY PRODUCTS FOR MAINTENANCE & REPAIR
INDUSTRIALBOLT.COM © © © 800-670-1906

**Reciprocating Saw
Handle & Blade Kit**

Assortment No. 706R

<p>44600 RECIPROCATING SAW HANDLE</p> 	<p>44606 6 6TPI BIMETAL RECIP BLADE*</p> 	<p>44610 6 10TPI BIMETAL RECIP BLADE*</p> 	<p>44618 6 18TPI BIMETAL RECIP BLADE*</p> 	<p>44624 6 24TPI BIMETAL RECIP BLADE*</p> 	<p>446710 6 7X10TPI BORE BLADE*</p>  <p>MBHL25225 1/4 X 2-1/4 MAG DRIVER BITHOLDER</p> 
---	--	---	---	--	---



IBS, INCORPORATED

Assortments (Z02)



Bore Blades and Demolition Blades

IBS No. 801R 9 Items • 18 Pcs (Z02)
 Packaged in a locking steel drawer
 for easy storage & organization

IBS, Inc. SPECIALTY PRODUCTS FOR MAINTENANCE & REPAIR INDUSTRIALBOLTS.COM © © © 800-678-1300		Bore Blades and Demolition Blades	
		Assortment No. 801R	
446710 6" 6X10TPI BORE BLADE. For metal and wood cutting.		448711 8" 10X14TPI BORE BLADE. For metal and wood cutting.	
446711 6" 14X18TPI BORE BLADE. For metal and wood cutting.		4410710 10" 8/12X10TPI BORE BLADE. For metal and wood cutting.	
448710 8" 6X10TPI BORE BLADE. For metal and wood cutting.		460906 9 X .062 6TPI DEMOLITION BIMETAL RECIP BLADE Specially designed for the toughest demolition jobs. Cuts all woods, nail-embedded wood and metals.	
460910 9 X .062 10TPI DEMOLITION BIMETAL RECIP BLADE Specially designed for the toughest demolition jobs. Cuts all woods, nail-embedded wood and metals.			
461206 12 X .062 6TPI DEMOLITION BIMETAL RECIP BLADE Specially designed for the toughest demolition jobs. Cuts all woods, nail-embedded wood and metals.			
461210 12 X .062 10TPI DEMOLITION BIMETAL RECIP BLADE Specially designed for the toughest demolition jobs. Cuts all woods, nail-embedded wood and metals.			

Bi-Metal Reciprocating Saw Blades

IBS No. 512P 12 Items • 60 Pcs (Z08)
 Packaged in a locking steel drawer
 for easy storage & organization

IBS, Inc. SPECIALTY PRODUCTS FOR MAINTENANCE & REPAIR INDUSTRIALBOLTS.COM © © © 800-678-1300		Hi-Alloy Reciprocating Saw Blades	
		Assortment No. 512P	
441206 12" 6TPI HI ALLOY RECIP BLADE Wood, nail-embedded wood, compositions plastic, cast aluminum, light gauge metals.			
4481014 8" 10-14TPI HI ALLOY RECIP BLADE All woods, plastic, cast aluminum, nail-embedded wood, soil pipe.		44624 6" 24TPI HI ALLOY RECIP BLADE Metal, 18 gauge and under. Trim & tubing. Galvanized pipe under 18 gauge.	
44614 6" 14TPI HI ALLOY RECIP BLADE Heavy gauge metals 1/8" thick and above. Barstock and angles.		44618 6" 18TPI HI ALLOY RECIP BLADE Heavy gauge metals of 18 gauge to 1/8" thick conduit, pipe, channels and tubing.	
44610 6" 10TPI HI ALLOY RECIP BLADE Wood, nail-embedded wood, compositions plastic, cast aluminum, light gauge metals.		4461014 6" 10-14TPI HI ALLOY RECIP All woods, plastic, cast aluminum, nail-embedded wood, soil pipe.	
44606 6" 6TPI HI ALLOY RECIP BLADE Wood, nail-embedded wood, compositions plastic, cast aluminum, light gauge metals.		44656 6" 6TPI HI ALLOY RECIP BLADE Plaster with metal lath plaster board, sheet rock, plaster walls. tooth design cuts both forward and on backward stroke.	
44414 6" 14TPI HI ALLOY RECIP BLADE Heavy gauge metals 1/8" thick and above. Barstock and angles.		44418 4" 18TPI HI ALLOY RECIP BLADE Heavy gauge metals of 18 gauge to 1/8" thick conduit, pipe, channels and tubing.	
44424 4" 24TPI HI ALLOY RECIP BLADE Metal, 18 gauge and under. Trim & tubing. Galvanized pipe under 18 gauge.			

Special Purpose Reciprocating Saw Blades

IBS No. 393R • 8 Items • 16 Pcs (Z08)
 Packaged in a Locking Steel Drawer
 for Easy Storage & Organization

IBS, Inc. SPECIALTY PRODUCTS FOR MAINTENANCE & REPAIR INDUSTRIALBOLTS.COM © © © 800-678-1300		Special Purpose Reciprocating Saw Blades	
		Assortment No. 393R	
44906 9 X 3/4 6TPI RECIP BIMETAL Wood, nail-embedded wood, compositions plastic, cast aluminum, light gauge metals.		45499 4 TUNGSTEN CARBIDE GRIT RECIP BLADE Cutting fiberglass, lath, plaster, ceramics, laminates, marble and hardened steel.	
45699 6 TUNGSTEN CARBIDE GRIT RECIP BLADE Cutting fiberglass, lath, plaster, ceramics, laminates, marble and hardened steel.		45899 8 TUNGSTEN CARBIDE GRIT RECIP BLADE Cutting fiberglass, lath, plaster, ceramics, laminates, marble and hardened steel.	
460906 9 X .062 6TPI DEMOLITION BIMETAL RECIP BLADE Specially designed for the toughest demolition jobs. Cuts all woods, nail-embedded wood and metals.			
461206 12 X .062 6TPI DEMOLITION BIMETAL RECIP BLADE Specially designed for the toughest demolition jobs. Cuts all woods, nail-embedded wood and metals.			
460910 9 X .062 10TPI DEMOLITION BIMETAL RECIP BLADE Specially designed for the toughest demolition jobs. Cuts all woods, nail-embedded wood and metals.			
461210 12 X .062 10TPI DEMOLITION BIMETAL RECIP BLADE Specially designed for the toughest demolition jobs. Cuts all woods, nail-embedded wood and metals.			

T
A
P
S
B
U
R
S
B
L
A
D
E
S



IBS, INCORPORATED

Hacksaw / Reciprocating Saw Blades (P11)

T
A
P
S

B
U
R
S

B
L
A
D
E
S

Bi-Metal Air Saw Blades

These blades are specifically designed for use in pneumatic saws. Blades have fine teeth for cutting metal. Very popular within autobody / muffler shops or other metal fabricating shops.



Bi-METAL AIR SAW BLADES

IBS No.	Size	TPI	Qty
441318	3" x 1/2" x .025	18 tpi	5
441324	3" x 1/2" x .025	24 tpi	5
441332	3" x 1/2" x .025	32 tpi	5
441418	4" x 1/2" x .025	18 tpi	5
441424	4" x 1/2" x .025	24 tpi	5
441432	4" x 1/2" x .025	32 tpi	5

Bi-Metal Air Saw Blades

IBS No. 513P • 6 Items • 30 Pcs (Z08)
Packaged in a locking plastic tray for easy storage & organization

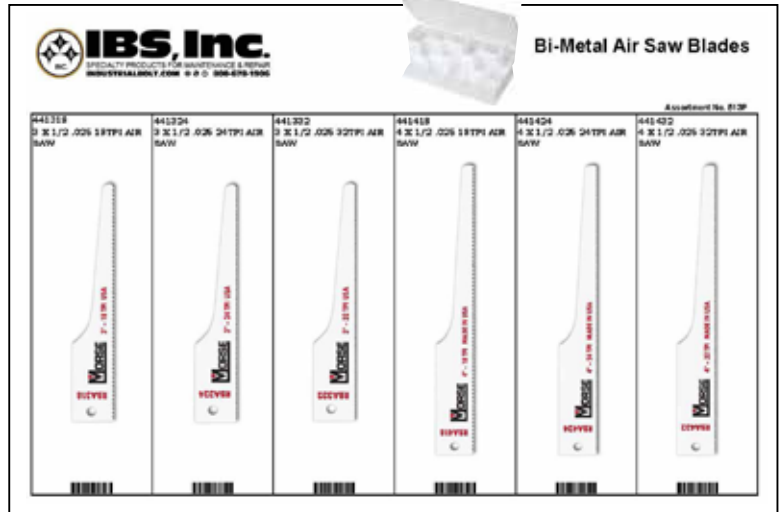

Bi-Metal Sabre/Jig Saw Blades

IBS Bi-Metal Sabre/Jig Saw Blades cut faster, cut straight, and last many times longer than high speed blades. Bi-metal construction consists of extra-sharp teeth milled in high speed steel welded to alloy back for longer life, and fewer changes. Tough sharp shatterproof bi-metal blades recommended for cutting steel, nail-embedded wood, masonite, conduit composition material, laminated countertops.

1/4" Universal Shank



Metal 18 gauge and under.

IBS No.	Size	TPI	Qty
442718	3" x 3/8" x .035	18 tpi	5

Bosch Shank



Steel and non-ferrous metal, 1/8" thick and up.

IBS No.	Size	TPI	Qty
440318	3" x 3/8" x .035	18 tpi	5

IBS, INCORPORATED

Razor Blades P11



"Rapid Razor" Utility Knife



- Autoloading design
- One-button blade change - 5 blades included
- Ergonomic rubber grip
- Heavy duty die cast body
- Holds any standard utility or hook blade
- 5 blades included

IBS No.	Description	Qty
16402	IBS "Rapid Razor" Utility Knife	1

"Rapid Razor" Dispenser 75 Blades/Pkg

- Dispenses 2-notch blades quickly and easily.
- Dispenser is wall mountable for convenient and easy access.
- Convenient see-thru body for easy visual check of supply.
- Built-in blade disposal slot for added safety.
- **MADE IN THE USA**



IBS No.	Description	Qty
16407	IBS "Rapid Razor" Dispenser	1

Heavy Duty Blades

- .025 Gauge.
- Fits most standard knives.
- Long lasting.
- All purpose blades.
- Made in the USA.



IBS No.	Description	Qty
16406	3 Notch Heavy Duty Utility Blade	5

Cartridge Loading Snap Knife with Rubber Grip



- Autoloading design
- Blade cartridge w/6 premium 8 pt blades
- Ratchet wheel for blade stability
- Ergonomic rubber grip
- Auto-locking
- For replacement blades use IBS No. 16409

IBS No.	Description	Qty
16408	Cartridge Loading Snap Knife	1

HD Retractable Blade 8 Pt. Breakaway Knife



- Sturdy metal body
- Auto-locking
- High-visibility yellow.
- Comes with premium steel blades.
- Accepts all standard 8 point blades.
- Spare blade compartment.
- Ideal for cutting cardboard, wood, leather and more.
- For replacement blades use IBS No. 16409

IBS No.	Description	Qty
16403	HD Retractable Breakaway Knife	1

Utility Knife Holster

- Sturdy metal clip.
- Universal use.
- Belt slots.
- High quality leather construction.
- Holds most utility knives & safety cutters.
- Made in the USA.



IBS No.	Description	Qty
16410	Utility Knife Holster	1

Heavy Duty Hook Blades

- Use with IBS Rapid Razor 16402.
- Ideal for cutting roofing, linoleum and carpet.
- .025 Gauge.
- Fits most standard knives.
- Long lasting.
- Made in the USA.



IBS No.	Description	Qty
16412	Heavy Duty Hook Utility Blade	5

HD 8 PT Snap Blade

- Use with IBS No. 16403 & 16408.
- Heavy Duty.
- Fits all standard snap knives.



IBS No.	Description	Qty
16409	HD 8 PT Snap Blade - 10 Pack	1

T
A
P
S

B
U
R
S

B
L
A
D
E
S



IBS, INCORPORATED

Razor Blades P11

T
A
P
S
B
U
R
S
B
L
A
D
E
S

Plastic Razor Blades

- Double Edged for longer life.
- Use with IBS No. 16400.
- Made for safer scraping and cleaning.
- Prevents damage to delicate surfaces.
- Fits most standard knives.
- Will not rust or corrode like metal blades.



IBS No.	Description	Qty
16401	Plastic Razor Blades	50

Single Edge Razor Blades

- Use with IBS No. 16400.
- Fits all standard single edge tools.
- Double honed for extra sharp edge.
- Strong steel back will not bend.
- Individually wrapped for edge protection and safety.
- Innovative packaging easily dispenses each blade thru top slot.
- Storage slot in the bottom for disposal of used blades.
- **MADE IN USA**



IBS No.	Description	Qty
16405	Single Edge Razor Blades	100

Revo Folding Knife

- Comfort-grip finger loop for added safety and control.
- Two position cutting.
- 50% more blade-edge exposed for deeper cutting.
- Quick-change blade replacement.
- Metal belt clip.
- Use with IBS No. 16407 IBS Rapid Razor 100 BLADES/PK (purchase separately).



IBS No.	Description	Qty
16416	Revo Folding Knife	1

Heavy Duty Metal Scraper

- Protective cap keeps the blade covered until it is in use. The cover then snaps on the back of the scraper to keep from losing or misplacing the cap.
- Ergonomic grip for better control.
- No push-button slide to expose the blade which often causes the blade to slide back when in use.
- Includes one standard straight razor blade for added value and allows the scraper to be used immediately.
- Perfect for scraping labels, decals, paint and adhesive from glass and other surfaces.



IBS No.	Description	Qty
16400	Heavy Duty Metal Scraper	1

SHARK Heavy Duty Combination Utility Knife

The SHARK Heavy-Duty Combination Utility Knife is two tools in one, a utility knife and a wire cutter, stripper and crimper. With a wide variety of features, this multi-function tool will get the job done faster, safer and easier.

- Rugged, professional grade construction with a comfortable, ergonomic grip.
- Has its own patented RAPID EDGE serrated blades that are built to last. The blades withstand longer use because the cutting friction is handled by five individual cutting surfaces, other blades only have one straight edge.
- Slide 'n' Lock technology allows you to adjust the amount of the blade that is exposed for precise cutting.
- Extra blades can be stored within the holder and a quick change design allows you to efficiently remove an old blade and replace it with a new one.
- When you're ready to work with wire, a spring loaded wire cutter opens easily and cuts comfortably, which locks securely into the body of the knife when you are done. The precision ground stripping holes easily remove insulation from thick 10 to 18 gauge wires.



IBS No.	Description	Qty
16414	SHARK Combination Utility Knife	1
16415	100 PK Shark Serrated Blades	1



Fiskars® Pro Fixed Blade Utility Knife

- The advantage of a "Fixed" Utility Knife is the blade is held securely and firmly in the knife for no wobble or slippage while in use for safer and more consistent cutting action.
- Folding blade guard deploys with the push of a button for convenient, easy protection.
- A reinforced metal end provides sturdy, reliable resistance against pounding and drops.
- The knife hinges open for easy blade change with no loose parts to keep track of.
- Includes one utility blade & handy 5 blade storage capacity meaning a new sharp blade is easily available to keep working, saving time and money.
- Manufacturer's Full Lifetime Warranty.



IBS No.	Description	Qty
16417	Fiskars Pro Fixed Blade Utility Knife	1

Fiskars® Pro Retractable Blade Utility Knife

- Side blade actuation on the knife helps prevent accidental blade retraction while in use.
- Knife easily hinges open with no loose parts to keep track of during blade change.
- Reinforced metal end provides sturdy, reliable resistance against pounding and drops.
- Includes one utility blade & handy 5 blade storage capacity meaning a new sharp blade is easily available to keep working, saving time and money.
- Manufacturer's Full Lifetime Warranty.



IBS No.	Description	Qty
16418	Fiskars Pro Retractable Utility Knife	1

Fiskars® Pro Folding Utility Knife



The Fiskars® Pro-Folding Utility Knife is a reliable, do-it-all addition to your tool kit and folds for compact storage and portability.

- Fiskars® Pro Folding Utility knife features a dual -locking system that prevents accidental blade release without sacrificing blade-change speed.
- Easy, one-handed, flip-open design means the knife opens with the flick of a wrist — safely reach the knife and continue working without interruption.
- Unique blade-release button makes for fast and easy blade changes — just press and sweep to release the blade and slide in a new one.
- Ergonomic design, including deep grooves and contouring allows for multiple grips.
- The reinforced metal end provides sturdy, reliable resistance against pounding and drops.
- Includes one utility blade.
- Manufacturer's Full Lifetime Warranty.

IBS No.	Description	Qty
16419	Fiskars Pro Folding Utility Knife	1

T
A
P
S
B
U
R
S
B
L
A
D
E
S



IBS, INCORPORATED

Snips, Shears & Pipe Cutters P11

T
A
P
S
B
U
R
S
B
L
A
D
E
S

Fiskars® PowerArc Utility Snips (8")



- PowerArc™ Utility Snips boast **intelligently curved blades** that alter the angle between the blades to give you over 2X more power, especially during the toughest part of the cut.
- **Offset design** with heavy-duty stainless steel blades can be used to cut materials from above or below, keeping waste material away from your hand.
- An **ergonomic, spring-assisted handle** helps reduce hand fatigue and features Softgrip® for enhanced dexterity and comfort.
- A **serrated edge, extended tang and bolted joint** improve control and durability.

IBS No.	Description	Qty
16420	Fiskars PowerArc™ Utility Snips	1

Fiskars® PowerArc Easy Action Shears (10")



- PowerArc™ Easy Action Shears™ boast **intelligently curved blades** that alter the angle between the blades to give you over 2X more power, especially during the toughest part of the cut.
- A radically **ergonomic, spring-assisted handle** features an open top loop, allowing you to rotate your hand over the handle to apply more power, especially during the toughest part of the cut.
- In addition, **Softgrip®** enhances dexterity and comfort, a bigger bottom loop fits large gloved hands and an easy-open lock protects the blades during transport.
- **Heavy-duty coined stainless steel blades** help prevent separation.
- A **serrated edge, extended tang and bolted joint** improve control and durability.

IBS No.	Description	Qty
16421	Fiskars PowerArc™ Easy Action Shears	1

Fiskars® PowerGear Plastic Pipe Cutter



- **PowerGear® technology** gives you over 35% more power to make cutting plastic pipes easier, while eliminating the need for ratcheting.
- This ingenious technology features a gear that provides more power during the toughest parts of the cut.
- **Replaceable stainless steel blades** cut from start to finish in a single, smooth stroke, while a tough stainless exoskeleton maximizes durability.
- An **ergonomic, spring-assisted handle** helps reduce hand fatigue and features Softgrip for enhanced dexterity and comfort.
- An **easy-open lock** simplifies usage while cutting a range of plastic pipes, including up to 1-1/4" O.D. PVC.

IBS No.	Description	Qty
16422	Fiskars PowerGear™ Plastic Pipe Cutter	1
16423	Replacement Blade for Fiskars PowerGear Plastic Pipe Cutter	1

IBS, INCORPORATED

Rotary Burs P29



Solid Carbide Burs

Double, Saber Cut and Fast Mill Flutes • 1/4" Shank



Double Cut

- For use on **hardened** and **tough materials**, stainless steel, cast steel and plastics.
- Produces a finer finish on material.
- Creates smaller chips and slivers.
- Provides greater tool control.



Saber Cut

- For use in **mild steel** and other semi-hard materials.
- Maximum stock removal.
- Engineered for heavy duty applications.
- Wider teeth make longer chips that break up easier and less prone to clogging.



Fast Mill Cut

- For use on **aluminum**, non-ferrous metals, soft steel, reinforced plastics, rubber, wood and other soft materials.
- Provides easy chip flow and faster stock removal without clogging.

FEATURES/BENEFITS:

- **Manufactured from C2 grade carbide** for high performance metal removal.
- **Perfect for edge and surface working**
- **Offered in various shapes available to match with the job** being done for fast, efficient and clean work.
- **1/4" shank fits all standard grinders.**



CYLINDER CARBIDE BUR

IBS No.			SCTI No.	Head Dia	Head Length	Overall Length
Double Cut	Saber Cut	Fast Mill Cut				
16901	16906	16981	SA-1	1/4	5/8	2
16903	16907	16983	SA-3	3/8	3/4	2-1/2
16905	16909	16985	SA-5	1/2	1	2-3/4



CYLINDER END CUT CARBIDE BUR

IBS No.			SCTI No.	Head Dia	Head Length	Overall Length
Double Cut	Saber Cut	Fast Mill Cut				
18901	—	—	SB-1	1/4	5/8	2
18903	—	—	SB-3	3/8	3/4	2-1/2
18905	—	—	SB-5	1/2	1	2-3/4



CYLINDER-RADIUS END CARBIDE BUR

IBS No.			SCTI No.	Head Dia	Head Length	Overall Length
Double Cut	Saber Cut	Fast Mill Cut				
16931	—	—	SC-1	1/4	5/8	2
16933	16936	16987	SC-3	3/8	3/4	2-1/2
16935	16938	16989	SC-5	1/2	1	2-3/4

T
A
P
S

B
U
R
S

B
L
A
D
E
S



IBS, INCORPORATED

Rotary Burs P29

Solid Carbide Burs

Double, Saber and Fast Mill Cut Flutes • 1/4" Shank

T
A
P
S

B
U
R
S

B
L
A
D
E
S



BALL SHAPE CARBIDE BUR

IBS No.			SCTI No.	Head Dia	Head Length	Overall Length
Double Cut	Saber Cut	Fast Mill Cut				
16971	—	—	SD-1	1/4	7/32	2
16972	—	—	SD-2	5/16	5/16	2-1/16
16973	16976	—	SD-3	3/8	5/16	2-1/16
16975	16977	—	SD-5	1/2	7/16	2-3/16



OVAL CARBIDE BUR

IBS No.			SCTI No.	Head Dia	Head Length	Overall Length
Double Cut	Saber Cut	Fast Mill Cut				
16941	—	—	SE-1	1/4	3/8	2
16943	16946	—	SE-3	3/8	5/8	2-11/32
16945	16948	—	SE-5	1/2	7/8	2-5/8



TREE RADIUS END CARBIDE BUR

IBS No.			SCTI No.	Head Dia	Head Length	Overall Length
Double Cut	Saber Cut	Fast Mill Cut				
16911	—	—	SF-1	1/4	5/8	2
16913	16916	16991	SF-3	3/8	3/4	2-1/2
16915	16918	16993	SF-5	1/2	1	2-3/4
—	—	16995	SF-6	5/8	1	2-3/4



TREE POINTED END CARBIDE BUR

IBS No.			SCTI No.	Head Dia	Head Length	Overall Length
Double Cut	Saber Cut	Fast Mill Cut				
16951	—	—	SG-1	1/4	5/8	2
16953	16956	—	SG-3	3/8	3/4	2-1/2
16955	16958	—	SG-5	1/2	1	2-3/4



14° TAPER - RADIUS CARBIDE BUR

IBS No.			SCTI No.	Head Dia	Head Length	Overall Length
Double Cut	Saber Cut	Fast Mill Cut				
16921	—	—	SL-1	1/4	5/8	2
16923	16926	—	SL-3	3/8	1-1/16	2-13/16
16924	16927	—	SL-4	1/2	1-1/8	2-7/8



CONE SHAPE CARBIDE BUR

IBS No.			SCTI No.	Angle	Head Dia	Head Length	Overall Length
Double Cut	Saber Cut	Fast Mill Cut					
16963	—	—	SM-3.	12°	1/4	1	2
16964	16966	—	SM-4	28°	3/8	3/4	2-1/2
16965	16967	—	SM-5	28°	1/2	1	2-3/4

IBS, INCORPORATED

Rotary Burs P29



Carbide Bur Assortments (P15)



DOUBLE CUT ROTARY BURS ASSORTMENT

Asst No.	IBS No. (Bur)	Type	SCTI No.	Head Dia	Head Length	Overall Length		
IBS No. 16980 w / Index & Grinder	IBS No. 16979 with Index	16901	Cylinder	SA-1	1/4	5/8	2	
		16903	Cylinder	SA-3	3/8	3/4	2-1/2	
		16905	Cylinder	SA-5	1/2	1	2-3/4	
		16921	14° Taper	SL-1	1/4	5/8	2-13/16	
		16933	Cylinder Rad	SC-3	3/8	3/4	2-1/2	
		16935	Cylinder Rad	SC-5	1/2	1	2-3/4	
		16911	Tree Radius	SF-1	1/4	5/8	2-1/2	
		16913	Tree Radius	SF-3	3/8	3/4	2-3/4	
		17016	Steel Index					
		69282	1/4 Air Die Grinder					



SABER CUT ROTARY BURS ASSORTMENT

Asst No.	IBS No. (Bur)	Type	SCTI No.	Head Dia	Head Length	Overall Length		
IBS No. 16996 w/Index & Grinder	IBS No. 16997 with Index	16907	Cylinder	SA-3	3/8	3/4	2-1/2	
		16909	Cylinder	SA-5	1/2	1	2-3/4	
		16926	14° Taper	SL-3	3/8	1-1/16	2-13/16	
		16936	Cylinder Rad	SC-3	3/8	3/4	2-1/2	
		16938	Cylinder Rad	SC-5	1/2	1	2-3/4	
		16916	Tree Radius	SF-3	1/2	1	2-1/2	
		16918	Tree Radius	SF-5	3/8	3/4	2-3/4	
		17016	Steel Index					
		69282	1/4 Air Die Grinder					



FAST MILL CUT BURS FOR ALUMINUM ASSORTMENT

Asst No.	IBS No. (Bur)	Type	SCTI No.	Head Dia	Head Length	Overall Length		
IBS No. 16998 w/Index & Grinder	IBS No. 16999 w/Index	16981	Cylinder	SA-1	1/4	5/8	2	
		16983	Cylinder	SA-3	3/8	3/4	2-1/2	
		16985	Cylinder	SA-5	1/2	1	2-3/4	
		16987	Cylinder Rad	SC-3	3/8	3/4	2-1/2	
		16989	Cylinder Rad	SC-5	1/2	1	2-3/4	
		16993	Tree Radius	SF-5	1/2	1	2-1/2	
		17016	Steel Index					
		69282	1/4 Air Die Grinder					

T
A
P
S

B
U
R
S

B
L
A
D
E
S



IBS, INCORPORATED

Hi-Alloy Rotary Burs Gen'l Info

TAPS BURS BLADES

SURFACE FEET CONVERSION CHART								
Surface Feet Per Minute (SFM) to Revolutions Per Minute (RPM)								
SFM	RPM							
	Cutter Diameter							
	1/8"	1/4"	3/8"	1/2"	5/8"	3/4"	7/8"	1"
10	305	153	102	76	61	51	44	38
15	458	229	153	115	92	76	65	57
20	611	305	204	153	122	102	87	76
25	763	382	254	191	153	127	109	95
30	916	458	305	229	183	153	131	115
25	1069	534	356	267	214	178	153	134
40	1221	611	407	206	244	204	174	153
25	1374	687	458	344	275	229	196	172
50	1527	763	509	382	305	254	218	191
60	1832	916	611	458	366	305	262	229
70	2137	1069	712	534	427	356	305	267
80	2443	1221	814	611	489	407	349	305
90	2478	1374	916	687	550	458	393	344
100	3053	1527	1018	763	611	509	436	382
150	4580	2290	1527	1145	916	763	654	573
200	6107	3053	2036	1527	1221	1018	872	763
250	7634	3817	2545	1908	1527	1272	1091	954
300	9160	4580	3053	2290	1832	1527	1309	1145
350	10687	5344	3562	2672	2137	1781	1527	1336
400	12214	6107	4071	3053	2443	2036	1745	1527
450	13740	6870	4580	3453	2748	2290	1963	1718
500	15267	7634	5089	3817	3053	2545	2181	1908
600	18321	9160	6107	4580	3664	3053	2617	2290
700	21374	10687	7125	5344	4275	3562	3053	2672
800	24427	12214	8142	6107	4885	4071	3490	3053
900	27481	13740	9160	6870	5496	4580	3926	3453
1000	30534	15267	10178	7634	6107	5089	4362	3817
1100	33588	16794	11196	8397	6718	5598	4798	4198
1200	36641	18321	12214	9160	7328	6107	5234	4580
1300	39695	19847	13232	9924	7939	6616	5671	4962
1400	42748	21374	14429	10687	8550	7125	3107	5344
1500	45802	22901	15267	11450	9160	7634	6543	5725
1600	48855	24427	16285	12214	9771	8142	6979	6107
1700	51908	25954	17303	12977	10382	8651	7415	6489
1800	54962	27481	18321	13740	10992	9160	7852	6870
1900	58015	29008	19338	14504	11603	9669	8288	7252
2000	61069	30534	20356	15267	12214	10178	8724	7634

FORMULAS: SFM = RPM X Diameter X .262 RPM = (SFM X 3.82) + Diameter

External Deburring Tools 3Pc Set (T03)

IBS No. 476P



- Quickly repairs damaged threads from 7/64" to 2-1/3".
- Hardened HRC 60 Steel blades remove burrs and uneven ridges from threaded rods, pipes and more.
- Works on hardened and mild steels, Grade 8 fasteners, stainless steel, brass copper, aluminum, plastics, wood, etc.
- 1/4" hex shank attaches to your drill quickly.
- Most effective at low speeds — recommended speed should not exceed 500 RPM in a clockwise direction only.

IBS No.	Description	Shank	Qty
51951	Small Deburring Tool 7/64" to 7/16"	1/4"	1
51950	Medium Deburring Tool 5/16" to 7/8"	1/4"	1
51952	Large Deburring Tool 23/32" to 2-1/3"	3/8"	1
476P	3 Piece Set - Deburring Tools		1



REMOVE BURRS

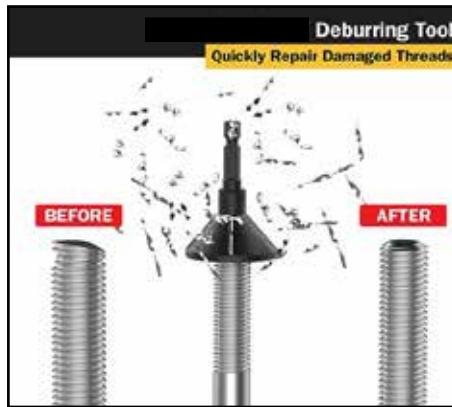

REPAIR DAMAGED THREADS



WORKS ON A VARIETY OF MATERIALS

T
A
P
S
B
U
R
S
B
L
A
D
E
S



IBS, INCORPORATED

Abrasives, Bench Rolls, Files P26

Black Maxi-Sharp Files

Our Premium line of hand files, specially treated with a black oxide coating, Black Maxi-Sharp Files last longer due to increased resistance to loading and rust.

All Purpose



The built-in handle provides maximum versatility for a wide range of applications. All Purpose Files feature a double cut on one side, a single cut on the other side, have one edge cut and one edge safe (uncut) for shoulder filing, and are parallel in width and thickness.

ALL PURPOSE

IBS No.	Description	Qty
65018-8	8" / 200 mm	1
65018-10	10" / 250 mm	1

Mill Files



Excellent for a wide range of applications such as sharpening, draw filing, lathe work and general shop use; Mill Files are single cut on the sides and edges and taper toward the point width.

MILL FILES - BASTARD CUT

IBS No.	Description	Qty
65000-6	6" / 150 mm	1
65000-8	8" / 200 mm	1
65000-10	10" / 250 mm	1
65000-12	12" / 300 mm	1
65000-14	14" / 350 mm	1

MILL FILES - SMOOTH CUT

IBS No.	Description	Qty
65017-6	6" / 150 mm	1
65017-8	8" / 200 mm	1
65017-10	10" / 250 mm	1
65017-12	12" / 300 mm	1

MILL FILES - SECOND CUT

IBS No.	Description	Qty
65010-6	6" / 150 mm	1
65010-8	8" / 200 mm	1
65010-10	10" / 250 mm	1

Flat Files



Excellent for "hogging" or rapid stock removal; Flat Files are double cut on both sides, single cut on the edges and taper toward the point in width.

FLAT FILES - BASTARD CUT

IBS No.	Description	Qty
65001-6	6" / 150 mm	1
65001-8	8" / 200 mm	1
65001-10	10" / 250 mm	1
65001-12	12" / 300 mm	1
65001-14	14" / 350 mm	1

FLAT FILES - SMOOTH CUT

IBS No.	Description	Qty
65011-6	6" / 150 mm	1
65011-8	8" / 200 mm	1
65011-10	10" / 250 mm	1
65011-12	12" / 300 mm	1

Half-Round Files



Great for rounding out holes, corners and crevices; Half Round Files are double cut on both sides and taper toward the point in width and thickness. Files feature a "twist & roll" action on the half round side produced by a spiral cut design and have the "Wavy Tooth" design on the flat side

HALF ROUND FILES - BASTARD CUT

IBS No.	Description	Qty
65003-6	6" / 150 mm	1
65003-8	8" / 200 mm	1
65003-10	10" / 250 mm	1
65003-12	12" / 300 mm	1
65003-14	14" / 350 mm	1

HALF ROUND FILES - SMOOTH CUT

IBS No.	Description	Qty
65014-6	6" / 150 mm	1
65014-8	8" / 200 mm	1
65014-10	10" / 250 mm	1

T
A
P
S

B
U
R
S

B
L
A
D
E
S



Black Maxi-Sharp Files

Our Premium line of hand files, specially treated with a black oxide coating, Black Maxi-Sharp Files last longer due to increased resistance to loading and rust.

Multi-Kut Flat Files



Obtain almost any required finish simply by changing the feed pressure; "Multi-Kut" Flat Files are single cut coarse tooth files that taper toward the point width. Design features allow for fast stock removal while leaving a smooth finish. Combines the performances of Flat and Mill Files.

MULTI-KUT FLAT FILES - SMOOTH CUT

IBS No.	Description	Qty
65019-8	8" / 200 mm	1
65019-10	10" / 250 mm	1

Round Files



Intended for enlarging and rounding out circular openings or concave surfaces; Round Files are double cut and taper toward the point in width and thickness.

ROUND FILES - BASTARD CUT

IBS No.	Description	Qty
65002-6	6" / 150 mm	1
65002-8	8" / 200 mm	1
65002-10	10" / 250 mm	1
65002-12	12" / 300 mm	1

ROUND FILES - SMOOTH CUT

IBS No.	Description	Qty
65012-6	6" / 150 mm	1
65012-8	8" / 200 mm	1

Tapered Saw Files



Designed for filing all types of saws with 60° angle teeth; Taper Saw Files are triangular in shape, have cut edges and taper toward the point in width and thickness.

IBS No.	Description	Type	Qty
65016-6	6" / 150 mm	Regular ▲	1
65004-6	6" / 150 mm	Slim ▲	1
65005-7	6" / 150 mm	Extra Slim ▲	1

3 Square Files



Excellent for cleaning out corners or for use on cutters, taps, and flat surfaces; Three Square files are double cut and taper toward the point in width and thickness

IBS No.	Description	Type	Qty
65015-6	6" / 150 mm	Bastard Cut	1
65015-8	8" / 200 mm	Bastard Cut	1

Tungsten Points File with Pocket Clip



For cleaning contact points in magnetos, switches, electric bells and distributor points and spark plugs in engines; Tungsten Point Files are single cut and have a handy pocket clip.

IBS No.	Description	Qty
65006-6	5" Tungsten Points File w / Pkt Clip	1

Chainsaw Files



Used for sharpening and maintaining proper tooth shape on chain saws; Round Chain Saw files have a fast, smooth cutting action that leaves an excellent "keen" edge cutting finish.

IBS No.	Description	Qty
65007-14	1/4" x 8"	1
65007-316	3/16" x 8"	1
65007-532	5/32" x 6"	1
65007-732	7/32" x 8"	1

File Card



Used to clean files — files last longer when properly cleaned. Excess build-up can cause clogging, resulting in slipping, scratching, or other filing inefficiencies.

IBS No.	Description	Qty
65009	File Card with Brush	1

TAPS BURST BLADES



IBS, INCORPORATED

Abrasives, Bench Rolls, Files P26

T
A
P
S
B
U
R
S
B
L
A
D
E
S

Files & Accessories

Skroo-Zon File Handles



The best name in file handles, Skroo-Zon wooden file handles have a threaded insert for "easy on, easy off." Reusable and long lasting. Be safe and reduce the risk of injury; use a Skroo-Zon File Handle.

IBS No.	Description	Qty
65008-4	T2 Handle / 4" Files	1
65008-6	T4 Handle / 6" Files	1
65008-8	T5 Handle / 8" Files	1
65008-10	T6 Handle / 10" Files	1
65008-12	T7 Handle / 12" Files	1
65008-14	T8 Handle / 14" Files	1

Black Maxi-Sharp Files Assortment (Z02)

IBS No. 699R • 10 Items • 12 Pcs

Packaged in a locking steel drawer for easy storage & organization













IBS, Inc.

SPECIALTY PRODUCTS FOR MAINTENANCE & REPAIR
INDUSTRIALBOLT.COM © © © 800-678-1906

Maxi-Sharp Files

Assortment No. 699R

<p>65018-10 10 MAXI-SHARP ALL PURPOSE</p> 	<p>65019-10 10 MAXI-SHARP FLAT MULTI-KUT</p> 
<p>65001-10 10 MAXI-SHARP FLAT FILE</p> 	<p>65003-10 10 MAXI-SHARP 1/2 RD FILE</p> 
<p>65000-10 10 MAXI-SHARP MILL FILE</p> 	
<p>65002-10 10 MAXI-SHARP ROUND FILE</p> 	
<p>65004-6 6 MAXI-SHARP TAPER FILE SLIM</p> 	<p>65008-6 6 SCRUIZ-ON FILE HANDLE</p> 
<p>65009 FILE CARD WITH BRUSH</p> 	<p>65008-10 10 SCRUIZ-ON FILE HANDLE</p> 



Electrical

A

Aerosols & Chemicals

Cleaners

Batt. Clean/Protect Q-119

Electrical

4 Way Plus Q-119

Contact and Circuit

Board Cleaner Q-120

Degreaser Q-119

Dielectric Grease Q-120

Undercoat Q-120

Assortments, Electrical

Automotive Electrical

Automotive Fuse Holders & Accessories Q-102

Deutsch DT Connectors & Terminals Q-37

with Crimping & Removal Tools Q-37

FMS (aka Slotted MCASE) Fuse Assortment Q-99, Q-100

FMX, FMX Low Profile & FMM Fuses Q-99, Q-100

Heavy Duty Truck Circuit Breakers Q-106

Metri-Pack 280 Series Assortment Q-40, Q-43

with Crimping & Removal Tools Q-40

Weather-Pack Series Assortment Q-43

Weather-Pack Series Assortment

with Crimping & Removal Tools Q-43

Batteries

Rayovac Ultra-Pro Alkaline Batteries Q-109

Battery

Tin Plated Copper Tubular Lugs Q-67

Battery Terminals

Copper Tubular Lug Q-66

EcoMax Battery Ends & Shrink Tubing Assortment Q-59

EcoMax Post Top Battery Terminals Q-59

Fusion Battery Ends Q-62

Fusion Solder-On Battery Ends & Shrink Tubing Q-59, Q-62

Post Top Terminals, HD Lugs & Splices Q-59

Special Battery Ends Q-64

Tin Plated Copper Tubular Lugs Q-67

Bulbs

12V Mini Auto Bulbs Q-87

Automotive Bulbs Q-87

12V Miniature Automotive Bulbs Assortment Q-87

Cable Ties

8" Colored Cable Tie Wraps Q-77

Black Low Profile Cable Tie Wraps Q-74

Black Nylon Ty-Raps with Metal Tabs Q-70, Q-71, Q-73

Cable Tie Rack Assortment Q-73

Cable & Tubing Mounting

Tie Wraps Q-79

Colored Cable Tie Wraps Q-77

Low Profile Cable Tie Wraps Assortment Q-74

Met-Tab Cable Tie Rack Assortment Q-70

Nylon Cable Tie Wraps Q-73

Releasable Cable Tie Wraps Q-75

Standard Cable Tie Wraps Q-73

Weather-Resistant Cable Tie Wraps Q-73

Circuit Breakers Q-106

Automotive Circuit Breakers ATM & ATC Q-106

Clamps

Nylon Clamps Q-82

Nylon & Rubber Clamp Q-82

Rubber Insulated Clamps

1/4" Mounting Hole Q-82

3/8" Mounting Hole Q-83

Vinyl Coated Q-82

Fuses

ATC Blade-Type Fuses Travel Tray Q-93

ATC LED Smart Fuse Travel Tray Q-97

ATM Blade-Type Fuses Travel Tray Q-92

ATM LED Smart Fuses Travel Tray Q-97

ATM Low Profile Fuse Assortment Q-91

ATM Mini-Blade LED Smart Fuse Q-97

ATR, ATL & ATM Low Profile Fuses Q-89

Automotive Electrical Fuses Q-95

Automotive Fuse Holders & Accessories Q-102

Blade Fuses Q-95

LED Smart Fuse Q-97

MAXI Blade LED Smart Fuses Q-97

Micro Fuses Assortment Q-89, Q-90

Micro Fuses Travel Tray Assortment Q-89, Q-90

Grommets

Q-83

Shrink Tubing

Automotive Dual Wall Heat Shrink Tubing Q-53

Automotive Shrink Tubing

Includes Torch Q-55, Q-56

Heavy Wall Heat Shrink Tubing Q-54

Solder

60/40 Rosin Core Solder &

Excalibur Torch Assts Q-116

Tapes & Sealants

Electrical Tape Assortment Q-45

Silicone Sealing Tape Q-46

Terminals

Blue 16-14 Electrical Connectors Q-13

Crimp & Seal

Long Neck Crimp & Seal Terminals Q-21

Crimp & Seal Sealed Wire Connectors Q-24

Crimp & Seal Terminals Q-22

includes Torch & Butane Refill Q-22

Deutsch DT Connectors & Terminals Q-37

DTP Deutsch Connectors & Tools Assortment Q-36

Heavy Duty Wire Ends for #8, #6 & #4 GA Wire Q-14

Long Neck Crimp & Seal Terminals Q-21

Multilink Wire Ends Q-17



Includes Torch & Butane Refill Q-17
 without Torch & Butane Refill Q-17
 with Thermal Indicator Butt Connectors Q-17
 Non-Insulated Terminals Q-7
 Nylon Insulated Terminals Q-7, Q-13
 Optiseal Heat Shrink Kits Q-27
 OptiSeal Terminals Q-27
 Red 22-18 Electrical Connectors Q-13
 Vinyl Insulated Terminals Q-8
 Wall & Lever Nut Travel Tray Q-33
 Wall Nuts & Wire Nuts
 Includes crimp tool Q-31, Q-33, Q-36
 Wire Nuts Travel Tray Q-33
 Yellow 12-10 Electrical Connectors Q-13

Wire

General Purpose Primary Wire Q-49
 Heavy Duty (Cross-Linked) Primary Wire Q-48

Automotive Electrical

Assortments

ATC Blade-Type Fuses Travel Tray Q-93
 ATC Mini-Blade LED Smart Fuse Q-97
 ATM Mini-Blade LED Smart Fuse Q-97
 Automotive Bulbs Q-87
 Automotive Circuit Breakers ATM & ATC Q-106
 Deutsch DT Connectors & Terminals Q-37
 Deutsch DT Connectors & Terminals Assortment
 with Crimping & Removal Tools Q-37
 Heavy Duty Truck Circuit Breakers Q-106
 LED Smart Fuse Q-97
 Metri-Pack 280 Series Assortment Q-40
 with Crimping & Removal Tools Q-40
 With Crimping & Removal Tools Q-40
 Weather-Pack Series Assortment Q-43
 Weather-Pack Series Assortment
 With Crimping & Removal Tools Q-43

Automotive Bulbs Q-84, Q-85, Q-86

Circuit Breakers

Blade-Type Q-103

Convuluted Tubing (Split Loom) Q-108

Deutsch Connectors & Terminals

Deutsch 2-Way Connectors Q-35
 Deutsch 3-Way Connectors Q-35
 Deutsch 4-Way Connectors Q-35, Q-36
 Deutsch 6-Way Connectors Q-35
 Deutsch 8-Way Connectors Q-35
 Deutsch 12-Way Connectors Q-35
 Deutsch Connector Tools Q-34, Q-38, Q-39, Q-40, Q-41
 , Q-42, Q-43
 Deutsch Seal Plug Q-34
 Deutsch Terminals Q-34
 DTP Deutsch Connectors
 DTP 2-Way Connectors Q-36
 DTP 4-Way Connectors Q-36
 DTP Terminals Q-36

Electronic Signal Flashers Q-107

Fabric Loom Q-108

Flashers Q-107

Fuse Holders Q-101

Fuses

ATC Blade-Type Fuses Q-93
 ATM Blade-Type Fuses Q-89, Q-91, Q-92
 FMM Fuses Q-98
 FMS Fuses Q-98
 FMX Q-98
 Glass Tube Fuses Q-88
 LED Smart Fuses Q-96
 MAXI Blade-Type Fuses Q-94

Metri-Pack 280 Series

Metri-Pack 1 Connectors Q-38
 Metri-Pack 2 Connectors Q-38
 Metri-Pack 3 Connectors Q-39
 Metri-Pack 5 Connectors Q-39
 Metri-Pack 12-14 Terminals Q-38
 Metri-Pack 16-18 Terminals Q-38
 Metri-Pack Cable Seals Q-38, Q-41, Q-42
 Metri-Pack Cavity Plug Q-39
 Metri-Pack Crimping Tool Q-39
 Metri-Pack Terminal Removal Tool Q-39

Relay, 5 Prong Q-107

Spiral Wrap Q-108

Test Clips Q-108

Weather-Pack Connectors & Terminals

Weather-Pack Cable Seals Q-41
 Weather-Pack Cavity Plug Q-41

Weather-Pack Terminals & Connectors

Weather-Pack 1 Connectors Q-41
 Weather-Pack 2 Connectors Q-41
 Weather-Pack 3 Connectors Q-42
 Weather-Pack 4 Connectors Q-42
 Weather-Pack 6 Connectors Q-42
 Weather-Pack 12 GA Terminals Q-42
 Weather-Pack 16-14 GA Terminals Q-42
 Weather-Pack 20-18 GA Terminals Q-42
 Weather-Pack Terminal Extractor Tool Q-42

Weather-Pack Terminals & Connectors

Weather-Pack 22-12GA Crimper Q-42

B

Batteries Q-109

Assortments

Procell Alkaline Batteries Q-109

Battery Terminals

Accessories

Accessory Bolts Q-63
 Battery Converters
 Side Terminal to Post Conversion Q-63
 Brushes Q-65
 Cable Slugs Q-64
 Converters Q-63
 Nuts & Bolts, Battery Q-63
 Power Cleaning Brushes, Battery End Q-65
 Terminal Protectors Q-65



Assortments

- Fusion Battery Ends Q-62
- Fusion Solder-On Battery Ends & Shrink Tubing Q-59, Q-62
- Post Top Terminals, HD Lugs & Splices Q-59
- Special Battery Ends Q-64

Automotive Series Emergency Style Q-63

Battery Bolts Q-63

- Accessory Q-63

Battery End Power Cleaning Brushes Q-65

Battery / Welding Cable Q-51

Converters Q-63

ECOMAX

- Flag Terminal Q-58
- Left Elbow Terminal Q-58
- Right Elbow Terminal Q-58

Fusion Solder-On

- Flag Terminal Q-62
- Lugs Q-62
- Right Q-58, Q-61
- Straight Q-58, Q-61

Heavy Duty Lugs Q-65

Heavy Duty Splices Q-65

Heavy Duty Universal Q-63

Lugs

- Copper Tubular Q-66, Q-67
- Fusion Solder-On Q-62
- Tin Plated Copper Q-67

Marine Wing Nut Style Q-63

Military Spec Q-63

Nuts Q-63

- Stud Top Q-60

OEM Style Q-63

Post Top / Side Mount

- Slugs Q-64
- Straight Clamp Terminal Q-60

Protectors Q-65

Stud Top / Side Mount Q-60

- Double Barrel (Splice) Q-60

Tubular Lugs Q-66, Q-67

Universal Q-63

Battery Terminals

ECOMAX Q-58

- Straight Clamp Q-58

Blade-Type Circuit Breakers Q-103

Booster Cables Q-69

Bulbs

Assortments

- Automotive Bulbs Q-87

Automotive Q-84, Q-85, Q-86

Replacement, Work Light

- 9W Fluorescent Q-113
- 12V 13W Fluorescent Q-113
- 13W Fluorescent Q-113
- 500W Halogen Work Light Bulb Q-113

Rough Service Q-109

C

Cable

Battery / Welding Q-51

Cable Clamps Q-69

Cable Ties

Adjustable Cable & Hose Mounts Q-80

Buttonhead Q-78

Cable Tie Bases Q-80

Colored & Fluorescent Q-76

Dual Clamp Cable Ties Q-79

Low Profile Cable Tie Wraps Q-74

Mounting Ties Q-78

Natural Nylon Q-72

Nylon Speedy Ties Q-75

Push Mounting Q-78

Stud Mount Cable Tie Wrap Q-78

Ty-Rap Black Nylon with Metal Tabs Q-70, Q-80

UV Black Weather-Resistant Q-72, Q-74

Circuit Breakers

Assortments

- Heavy Duty Truck Circuit Breakers Q-106

Blade Type

- ATC Style Breakers

- CB221 Q-104

- CBB Q-104

- CCB Q-104

- FCB Q-104

- MAXI Style Breakers

- CB1911 Q-103

- UCB Breakers

- UCB Q-104

Blade-Type

- Mini Breakers

- CB212 Q-103

Stud Mount

- AMG Q-105

- Heavy Duty Type 1

- CBC Q-105

- Standard Duty Type 2

- CBS Q-105

- Type II - 12 volt

- CBF Q-105

Clamps

Adjustable Q-81

Assortments

- Nylon Clamp Q-82

- Nylon & Rubber Clamp Q-82

- Rubber Insulated Clamps

- 1/4" Mounting Hole Q-82

- 3/8" Mounting Hole Q-83

- Vinyl Coated Clamps Q-82

Chassis Clips Q-81

Nylon Clamps Q-81

Rubber Insulated Clamps Q-81

Vinyl Dipped Hose Clamps Q-81



- Clips, Test Q-108
- Convolute Tubing Q-108
- Crimping Tools
 - Indent Crimper Q-69
 - Ratcheting Crimp Tool Q-118
 - Universal Crimping Tool Q-68
 - Wire Crimp Tool Q-118

E

- Extension Cords
 - Heavy Duty
 - 50' Single Tap Q-114

F

- Flashers Q-107
- Flux Q-64
- Fuse Holders Q-101
- Fuses
 - Assortments
 - ATC Mini-Blade LED Smart Fuse Q-97
 - ATM Mini-Blade LED Smart Fuse Q-97
 - Automotive Electrical Fuses Q-91, Q-92, Q-93, Q-95, Q-102
 - LED Smart Fuse Q-97

- Blade Type
 - LED Smart Fuses
 - ATM Q-96
 - ATO/ATC Q-96
 - MAXI Q-96

- Blade-Type
 - ATC Q-93
 - ATM Q-89, Q-91, Q-92
 - MAXI Q-94

- FMX Q-98
- FMX Low-Profile Q-98

- Fuse Holders Q-101
- Fusepuller Q-88
- Fusible Links Q-105

- Glass Tube
 - AGA Q-88
 - AGC Q-88
 - AGW Q-88
 - AGX Q-88
 - GBC Q-88
 - SFE Q-88

- Fusible Links Q-105

G

- Grommets Q-83
 - Assortments
 - Grommet Kit Q-83

L

- Light Bulbs
 - Accessories

- Replacement Bulbs
 - 9W Fluorescent Work Light Q-113
- Rough Service Q-109
- Lights
 - Accessories
 - Adapters
 - Single Tap Q-115
 - Triple Tap Q-115
 - Double Hooks for Tube Lights Q-113
 - Extension Cords
 - 25' Single Tap Q-114
 - 50' Single Tap Q-114
 - 100' Single Tap Q-114
 - Replacement Bulbs
 - 12V 13W Fluorescent Work Light Q-113
 - 13W Fluorescent Work Light Q-113
 - Replacement Heads
 - 18W Fluorescent Light Q-113
 - Replacement Plugs
 - Female - 3 Wire Q-113
 - Male - 3 Wire Q-113
 - Replacement Tube Assembly
 - 13W Worklights Q-113
 - Replacement Bulbs
 - 500W Halogen Worklight Q-113

- Halogen Work Lights
 - Professional Series 500W Halogen Work Light Q-111

- LED Worklights (Corded)
 - LED Work Light Q-111
 - PRO 1200 LUMEN LED WORKLIGHT WITH 25 FT CORD Q-110
 - Professional Series 60 LED on a 50" Metal Reel Q-110

- Rechargeable
 - Omni 2K Worklight Q-111
 - Omni 3K Worklight Q-111
 - Rechargeable LED Area Worklight with Magnetic Base Q-111
 - Under-Hood Worklight Q-110

- Loom
 - Fabric Q-108
 - Split Q-108

R

- Rechargeable Work Lights Q-111

S

- Shrink Tubing
 - 6 to 1 Hi-Ratio Q-52
 - Assortments
 - Automotive Shrink Tubing
 - Includes Torch Q-55, Q-56
 - Heavy Wall Heat Shrink Tubing Q-54
 - Heavy Wall Heat Shrink Tubing Assortment II Q-52
 - Color Coded Dual Wall Shrink Tubing Q-55
 - Dual Wall



Clear Q-53
Heavy Wall Q-52
High Adhesive Flow Heat Q-54
Optiseal Adhesive-Lined Q-56
Thin Wall Q-55, Q-57
Solder
60/40 Rosin Core Solder Q-116
Assortments
60/40 Rosin Core Solder &
Excalibur Torch Assts Q-116
Solder Combo Assortments Q-117
NOKORODE® Regular Paste Flux Q-116
Silvabrite 100% Solder Q-115
Silver Bearing Solder Q-115
Slugs Q-64
Split Tubing & Sleeving
Convolute Tubing Q-108
Split Braided Sleeving Q-108
Split Tubing & Sleeve Installation Tool Q-108

I

Tapes & Sealants
Assortments
Electrical Tape Q-45
Black Liquid Electrical Tape Q-45
Blue Painter's Tape Q-47
Colored Electrical Tape Q-45
Duct Tape Q-47
Electrical Tape Q-44, Q-45
Fusion Tape Q-46
Liquid Electrical Tape Q-45
Masking Tape Q-47
Scotch Brand 33+
Electrical Tape Q-44
Scotch Brand 88 Electrical Tape Q-44
Sealing Compound Q-47
Silicone Sealing Tape Q-46
Teflon Tape Q-47
Terminals
Crimp & Seal

Butt Connectors Q-20
General Info Q-19
Quick Slides Q-20
Ring Terminals Q-20
Snap Plugs Q-20
Spade Terminals Q-20
Step Butt Connectors Q-20
Long Neck Terminals Q-21
Crimp & Seal Long Neck Terminals Q-21
Heavy Duty Large Gauge
Butt Connectors
Butt Connectors (WP) Q-14
HydraLink

HydraLink Closed End Connectors Q-23
HydraLink Inline Butt Connectors Q-23
Multilink

Butt Connectors Q-16
Butt Connectors with Thermal Indicator Q-16
General Info Q-15
Quick Slides - Female Q-16
Quickslides - Male Q-16
Ring Terminals Q-16
Spade Terminals Q-16
Step-Butt Connectors Q-16
Non-Insulated
Braze Seam
Butt Connectors Q-8
Ring Terminals Q-8
Butted Seam
Butt Connectors Q-7
Quickslide Terminals Q-7
Ring Terminals Q-7
Snap Plug Connectors Q-7
Spade Terminals Q-7
Nylon Insulated
3 & 4-Way Connectors Q-10
Butt Connectors
Insulation Grip (NB) Q-10
Moisture Resistant (NBM) Q-10
Seamless (SN) Q-10
Window Q-10
Closed End Connectors Q-12
Cool Seal Terminals
Butt Connectors Q-28
Flag Terminals Q-12
Heavy Duty Q-14
Heavy Duty Large Gauge
Ring Terminals Q-14
Multi-Stacks Q-12
Pin Terminals Q-11
Quick Slides
Female Q-12
Female - Fully Insulated Q-12
Male Q-12
Male Fully Insulated Q-12
Ring Terminals Q-11
Snap Plugs
Female Q-12
Male Q-12
Spade Terminals
Standard Q-11
Optiseal
Butt Connectors Q-25, Q-26
Female Bullet Receptacle Connectors Q-26
Male Bullet Plug Connectors Q-26
Male & Female Connectors Q-26
Ring Terminals Q-25
Spade Terminals Q-26



Step Butt Connectors Q-25

Quick Connectors

3M Performance Plus Wire Connectors Q-29

Instant Auto Connectors Q-32

Lever Nut Q-30

Lever-Nuts Q-31

Self-Stripping Disconnects Q-32

Self-Stripping Pigtail Connector Q-32

Wall Nuts Q-30, Q-31

Wire Nuts Q-32

Solder & Seal

Butt Connectors Q-18

Quick Slides Q-18

Ring Terminals Q-18

Spade Terminals Q-18

Vinyl Insulated Q-9

Butt Connectors Q-9

Quickslide Terminal Q-9

Ring Terminals Q-9

Snap Plugs Q-9

Spade Terminals Q-9

Step-Butt Connectors Q-9

Terminals, Battery

Accessories

Accessory Bolts Q-63

Battery Converters Q-63

Battery End Power Cleaning Brushes Q-65

Battery Nuts & Bolts Q-63

Terminal Protectors Q-65

Assortments

Cable Slugs Q-64

Fusion Battery Ends Q-62

Fusion Solder-On Battery Ends & Shrink Tubing Q-59, Q-62

Post Top Terminals, HD Lugs & Splices Asst Q-59

Special Battery Ends Q-64

Automotive Series Emergency Style Q-63

ECOMAX

Flag Terminal Q-58

Left Elbow Terminal Q-58

Right Elbow Terminal Q-58

Straight Clamp Q-58

Fusion Solder-On

Flag Terminal Q-62

Heavy Wall Lugs Q-62

Right Clamp Q-58, Q-61

Straight Clamp Q-58, Q-61

Heavy Duty Universal Q-63

Lugs

Heavy Duty Q-65

Tubular Q-66, Q-67

Marine Wing Nut Style Q-63

Military Spec Q-63

OEM Style Q-63

Stud Top / Side Mount

Double Barrel (Splice) Q-60

Straight Clamp Q-60

Stud Top Battery Bolts Q-60

Stud Top Battery Nuts Q-60

Test Clips Q-108

Tools

Battery & Crimping

12 Volt Tester Q-69

Battery Cable Stripper Q-69

Cable Clamps Q-69

Cable Cutter Q-69

High Capacity Hydraulic Crimper Q-68

Indent Crimper Q-69

Professional Grade Heavy Duty Booster Cables Q-69

Ratcheting Crimp Tool Q-118

Ratcheting Wire Terminal Crimper Q-118

Universal Crimping Tool Q-68

Wire / Cable Cutter Q-117

Wire Crimp Tool Q-118

Wire Cutter Q-69

Dual Temp Electric Heat Gun Q-117

Hand

Cable Tie Gun Q-80

High Capacity Hydraulic Crimper Q-68

Mini Cable Tie Gun Q-80

Power

Dual Temp Electric Heat Gun Q-117

Dual Temp Electric Heat Gun Q-117

Hydraulic Crimper Q-68

Solder & Welding

Butane Refill 42 Grams Q-116

Industrial Butane Torch Q-117

Microtorch Butane Torch Q-117

Torches

Butane Refill Q-116

Industrial Butane Torch Q-117

Microtorch Butane Torch Q-117

W

Wire

Battery Cable Q-51

Jacketed Multiple Conductor Q-50

Nuts

3M Performance Plus Q-29

Wall Nuts Q-30, Q-31

Wire Nuts Q-32

Parallel Multiple Conductor Q-50

Primary

General Purpose Thermoplastic Q-49

Heavy Duty Wire (Cross-Linked) Q-48

Speaker Wire Q-50

Trailer Cable Q-50

Welding Cable Q-51

With Crimping & Removal Tools Q-40

IBS, INCORPORATED

Non-Insulated Connectors Q3A



Non-Insulated Butted Seam Terminals

The most economical terminal. Used where special performance or installation characteristics are not needed. Beveled mouth facilitates wire insertion.

RING TERMINALS

IBS No.	Wire	Stud	Qty
11-6	22-18	#6	100
11-8	22-18	#8	100
11-10	22-18	#10	100
12-6	16-14	#6	100
12-10	16-14	#10	100
12-14	16-14	1/4	100
13-8	12-10	#8	50
13-10	12-10	#10	50
13-14	12-10	1/4	50
13-56	12-10	5/16	50
13-38	12-10	3/8	50
13-500P	12-10	1/2	50



SPADE TERMINALS

IBS No.	Wire	Stud	Qty
31-10	22-18	#10	100
32-10	16-14	#10	100
33-10	12-10	#10	50



QUICKSLIDE TERMINALS

IBS No.	Wire	Type	Blade	Qty
72F-250-32	16-14	Female	1/4	100
72M-250-32	16-14	Male	1/4	100
73F-250-32	12-10	Female	1/4	50
73M-250-32	12-10	Male	1/4	50



BUTT CONNECTORS

IBS No.	Wire	Qty
61S	22-18	100
62S	16-14	100
63S	12-10	50



IBS No.	Wire	Type	Blade	Qty
82F-156-NL*	16-14	Female	.156	100
82M-156	16-14	Male	.156	100



* Nylon Insulated

Non-Insulated Terminal Assortment (Z02)

Top 24 Wire Ends

IBS No. 211R • 24 Items • 635 Pcs

Packaged in a locking steel drawer for easy storage and organization

IBS, Inc. SPECIALTY PRODUCTS FOR MAINTENANCE & REPAIR INDUSTRIALBOLT.COM © © © 800-670-1906		Non-Insulated Butted Seam Top 24 Wire Ends				Assortment No. 211R
61S 22-18 BUTT CONN NON INSUL	11-6 22-18 RING TERM. 6 STUD NO-INS	11-8 22-18 RING TERM 8 STUD NO-INS	11-10 22-18 RING TERM 10 STUD NO-INS	31-10 22-18 SPADE TERM #10 STUD	72F-250-32 16-14 FEMALE QUICK SLIDE	
62S 16-14 BUTT CONN NON INSULATED	12-6 16-14 RING TERM. 6 STUD NO-INS	12-10 16-14 RING TERM 10 STUD NO-INS	12-14 16-14 RING TERM #14 STUD NO-IN	32-10 16-14 #10 SPADE TERM	72M-250-32 16-14 MALE QIK SLIDE NO INSUL.	
63S 12-10 BUTT CONN. NON INSUL.	82F-156-NL 16-14 FEMALE SNAP PLUG VINYL	82M-156 16-14 MALE SNAP PLUG	13-8 12-10 RING TERM 8 STUD NON-INS	33-10 12-10 SPADE TERM #10 STUD	73M-250-32 12-10 MALE QIK SLIDE NO INSUL.	
13-10 12-10 RING TERM #10 STUD NO-IN	13-14 12-10 RING TERM 1/4 STUD	13-56 12-10 RING TERM 5/16 STUD	13-38 12-10 RING TERM. 3/8 STUD NO-I	13-500 12-10 RING TERM 1/2 STUD	73F-250-32 12-10 FEMALE QUICK SLIDE	

ELECTRICAL



IBS, INCORPORATED

Non-Insulated Connectors Q3A

Non-Insulated Brazed Seam

Beveled mouth facilitates wire insertion. It can be crimped anywhere on the barrel surface. Silver brazed seam will not open under crimping pressure or operating stresses. Unlike butted seam parts, stranded wire cannot escape barrel confines during or after crimping.

RING TERMINALS

IBS No.	Wire	Stud	Qty
14-10SW	#8	#10	10
14-14SW	#8	1/4	10
14-56W	#8	5/16	10
14-38W	#8	3/8	10
15-14SW	#6	1/4	10
15-56W	#6	5/16	10
15-38W	#6	3/8	10
15-500SW	#6	1/2	10
16-10W	#4	#10	10
16-14W	#4	1/4	10
16-56W	#4	5/16	10
16-38W	#4	3/8	10
16-500SW	#4	1/2	10



BUTT CONNECTORS

IBS No.	Wire	Qty
64W	#8	10
65W	#6	10
66W	#4	10



Vinyl Insulated Terminal Assortment (Z02)

Vinyl Insulated Solderless Terminals

IBS No. 201R • 24 Items • 515 Pcs

Packaged in a locking steel drawer for easy storage and organization



Vinyl Insulated Solderless Terminals

Assortment No. 201R

61-P 22-18 BUTT CONN VINYL 	11-6P 22-18 RING TERM #6 STUD VINYL 	11-8P 22-18 RING TERM #8 STUD VINYL 	11-10P 22-18 RING TERM #10 STUD VINYL 	31-10P 22-18 SPADE TERM #10 STUD 	72F-250-32P 16-14 FEMALE QIK SLIDE VINYL
62-P 16-14 BUTT CONN VINYL 	12-6P 16-14 RING TERM #6 STUD VINYL 	12-10-P 16-14 RING TERM 10 STUD VINYL 	12-14SP 16-14 RING TERM 1/4 STUD VINYL 	32-10P 16-14 SPADE TERM 10 STUD VINYL 	72M-250-32P 16-14 MALE QIK SLIDE VINYL
63-P 12-10 BUTT CONN VINYL 	82F-156-NL 16-14 FEMALE SNAP PLUG VINYL 	82M-156P 16-14 MALE SNAP PLUG VINYL 	33-10P 12-10 SPADE TERM #10 STUD 	13-8P 12-10 RING TERM #8 STUD VINYL 	73M-250-32P 12-10 MALE QIK SLIDE VINYL
13-10P 12-10 RING TERM 10 STUD VINYL 	13-14SP 12-10 RING TERM 1/4 STUD VINYL 	13-56P 12-10 RING TERM 5/16 STUD VINYL 	13-38P 12-10 RING TERM 3/8 STUD VINYL 	13-500P 12-10 RING TERM 1/2 STUD VINYL 	73F-250-32P 12-10 FEMALE QIK SLIDE VINYL

ELECTRICAL

IBS, INCORPORATED

Vinyl Insulated Terminals Q3B



Vinyl Insulated Butted Seam Terminals

Used where an insulated barrel is necessary and desirable. Terminal consists of butted part with flared, rigid, molded polyvinyl chloride sleeve securely attached and funneled for easy entry. Wire insulation positions itself against funnel portion of vinyl sleeve this eliminating strand hang-up. Crimping barrel and flared portion of vinyl sleeve provide excellent electrical contact plus mechanical stress relief at junction of insulation and barrel. Insulation has a non-skid ridge for ease of positioning crimping tool. Industry standard color coding indicates wire range. Insulators are rated at a continuous operating temperature range from -40°F to 220°F (-40°C to 105°C). U.L. Listed and CSA Certified for 600 volt building wire and 1000 volt signs and fixtures.

RING TERMINALS



IBS No.	Wire	Stud	Color	Qty
11-6P	22-18	#6	Red	100
11-8P	22-18	#8	Red	100
11-10P	22-18	#10	Red	100
12-6P	16-14	#6	Blue	100
12-8-P	16-14	#8	Blue	100
12-10-P	16-14	#10	Blue	100
12-14SP	16-14	1/4	Blue	100
13-8P	12-10	#8	Yellow	50
13-10P	12-10	#10	Yellow	50
13-14SP	12-10	1/4	Yellow	50
13-56P	12-10	5/16	Yellow	50
13-38P	12-10	3/8	Yellow	50
13-500P	12-10	1/2	Yellow	50

SPADE TERMINALS



IBS No.	Wire	Stud	Color	Qty
31-10P	22-18	#10	Red	100
32-10P	16-14	#10	Blue	100
33-10P	12-10	#10	Yellow	50

BUTT CONNECTORS



IBS No.	Wire	Color	Qty
61-P	22-18	Red	100
62-P	16-14	Blue	100
63-P	12-10	Yellow	100

STEP-BUTT CONNECTORS



IBS No.	Wire	Color	Qty
SB1210-1614	12-10 to 16-14	Yellow w/Blue	100
SB1614-2218	16-14 to 22-18	Blue w/Red	100

QUICKSLIDE TERMINALS



All 1/4" Blade Size

IBS No.	Wire	Type	Color	Qty
72F-250-32P	16-14	Female	Blue	50
72M-250-32P	16-14	Male	Blue	50
73F-250-32P	12-10	Female	Yellow	50
73M-250-32P	12-10	Male	Yellow	50

SNAP PLUGS



IBS No.	Wire	Color	Type	Qty
82F-156-NL	16-14	Blue	Female	100
82M-156P	16-14	Blue	Male	100

ELECTRICAL



IBS, INCORPORATED

Nylon Insulated With Grip Q3C

Nylon Insulated Butted Seam with Insulation Grip

These terminals are used where an insulated barrel and positive insulation grip are necessary or desirable. The terminal consists of a butted seam with a flared seamless brass sleeve securely attached and covered with a flared, molded nylon sleeve. Wire insulation positions itself against funnel portion of brass sleeve. Crimping barrel and flared portion of sleeve provide excellent electrical contact plus mechanical stress relief at junction of insulation and barrel. Positioning crimp tool is nearly mistake-proof due to a "step" in the nylon insulation. Industry standard color coding indicates wire range. Insulators are rated at a continuous operating temperature range from -40°F to 220°F (-40°C to 105°C). U.L. Listed and CSA Certified for 600 volt building wire and 1000 volt signs and fixtures.

Butt Connectors

Seamless

- Economical.
- Nylon Insulated.
- Crimp once on each end.



IBS No.	Wire	Color	Qty
60-SN	24-22	Yellow	100
61-SN	22-18	Red	100
62-SN	16-14	Blue	100
63-SN	12-10	Yellow	50

Insulation Grip

- Nylon Insulated.
- Double crimp to secure wire and insulation.
- Brass sleeve provides optimum grip on insulation to give strain relief and vibration protection.



IBS No.	Wire	Color	Qty
61-NB	22-18	Red	100
62-NB	16-14	Blue	100
63-NB	12-10	Yellow	50

Window

- Military approved according to MIL-T-7928/5.
- Nylon Insulated.
- Insulation grip provides superior strain relief.
- Military approved to withstand the most harsh environments.
- Inspection window guarantees proper wire insertion



IBS No.	MIL Spec	Wire	Color	Qty
61-WB	M7928/5-3	22-18	Red	50
62-WB	M7928/5-4	16-14	Blue	50
63-WB	M7928/5-5	12-10	Yellow	25

Moisture Resistant (NBM)

- Sealant Filled.
- Insulation grip for strain relief and vibration protection.
- Withstands high temperatures, car and truck wash solutions.
- Remains stable over a wide temperature range — accepts fine strand wire down to 0°F.
- Protects against corrosive environments — road chemicals, animal waste, salt spray and exhaust fumes.
- Withstands temperatures of -50°F to 220°F for improved brake and tail light integrity in all weather.
- Double crimp to secure wire and insulation — no heat or chemicals needed.



IBS No.	Wire	Color	Qty
61NBM	22-18	Red	50
62NBM	16-14	Blue	50
63NBM	12-10	Yellow	25

3 & 4-Way Connectors



3-WAY CONNECTORS

IBS No.	Wire	Color	Qty
322NB	22-18	Red	50
316NB	16-14	Blue	25
312NB	12-10	Yellow	25

4-WAY CONNECTORS

IBS No.	Wire	Color	Qty
416NB	16-14	Blue	25



ELECTRICAL

IBS, INCORPORATED

Nylon Insulated With Grip Q3C



Ring Terminals



IBS No.	Wire	Stud	Color	Qty
11-4SNB	22-18	#3-4	Red	100
11-6SNB	22-18	#5-6	Red	100
11-8SNB	22-18	#8	Red	100
11-10NB	22-18	#10	Red	100
11-14SNB	22-18	1/4	Red	100
11-56NB	22-18	5/16	Red	100
11-38NB	22-18	3/8	Red	100
12-4SNB	16-14	#4	Blue	100
12-6SNB	16-14	#6	Blue	100
12-8SNB	16-14	#8	Blue	100
12-10NB	16-14	#10	Blue	100
12-14SNB	16-14	1/4	Blue	100
12-56SNB	16-14	5/16	Blue	100
12-38NB	16-14	3/8	Blue	100
13-6SNB	12-10	#6	Yellow	50
13-8SNB	12-10	#8	Yellow	50
13-10NB	12-10	#10	Yellow	50
13-14SNB	12-10	1/4	Yellow	50
13-56SNB	12-10	5/16	Yellow	50
13-38SNB	12-10	3/8	Yellow	50
13-500NB	12-10	1/2	Yellow	50

Spade Terminals



IBS No.	Wire	Stud	Color	Qty
31-6NB	22-18	#6	Red	100
31-8NB	22-18	#8	Red	100
31-10NB	22-18	#10	Red	100
32-6NB	16-14	#6	Blue	100
32-8NB	16-14	#8	Blue	100
32-10NB	16-14	#10	Blue	100
33-8NB	12-10	#8	Yellow	50
33-10NB	12-10	#10	Yellow	50

Block Spade Terminals



IBS No.	Wire	Stud	Color	Qty
BS-31-6-NB	22-18	#6	Red	100
BS-31-10-NB	22-18	#10	Red	100
BS-32-6-NB	16-14	#6	Blue	100
BS-32-8-NB	16-14	#8	Blue	100
BS-32-10-NB	16-14	#10	Blue	100
BS-33-10-NB	12-10	#10	Yellow	50

Snap Spade Terminals



IBS No.	Wire	Stud	Color	Qty
SS-31-6-NB	22-18	#6	Red	100
SS-31-8-NB	22-18	#8	Red	100
SS-31-10-NB	22-18	#10	Red	100
SS-32-6-NB	16-14	#6	Blue	100
SS-32-8-NB	16-14	#8	Blue	100
SS-32-10-NB	16-14	#10	Blue	100

Hook Terminals



IBS No.	Wire	Stud	Color	Qty
41-6-NB	22-18	#6	Red	100
41-8-NB	22-18	#8	Red	100
42-8-NB	16-14	#8	Blue	100
42-10-NB	16-14	#10	Blue	100
43-10-NB	12-10	#10	Yellow	50

Pin Terminals



IBS No.	Wire	Color	Qty
81P-47-NB	22-18	Red	100
82P-47-NB	16-14	Blue	100
83P-55-NB	12-10	Yellow	25

ELECTRICAL



IBS, INCORPORATED

Nylon Insulated With Grip Q3C

ELECTRICAL

Quick Slides



MALE QUICK SLIDES - FULLY INSULATED
NYLON-INSULATED INSULATION GRIP

IBS No.	Wire	Blade	Color	Qty
71M-187-20-NBL	22-18	3/16	Red	50
71M-250-32-NBL	22-18	1/4	Red	50
72M-187-20-NBL	16-14	3/16	Blue	50
72M-250-32-NBL	16-14	1/4	Blue	50
73M-250-32-NBL	12-10	1/4	Yellow	25

FEMALE QUICK SLIDES - FULLY INSULATED
NYLON-INSULATED INSULATION GRIP

IBS No.	Wire	Blade	Color	Qty
71F-187-20-NBL	22-18	3/16	Red	50
71F-250-32-NBL	22-18	1/4	Red	50
72F-187-20-NBL	16-14	3/16	Blue	50
72F-250-32-NBL	16-14	1/4	Blue	50
73F-250-32-NBL	12-10	1/4	Yellow	25



MALE QUICK SLIDES

IBS No.	Wire	Blade	Color	Qty
71M-187-20-NB	22-18	3/16	Red	50
71M-250-32-NB	22-18	1/4	Red	50
72M-187-20-NB	16-14	3/16	Blue	50
72M-250-32-NB	16-14	1/4	Blue	50
73M-250-32-NB	12-10	1/4	Yellow	25



FEMALE QUICK SLIDES

IBS No.	Wire	Blade	Color	Qty
71F-187-20-NB	22-18	3/16	Red	50
71F-250-32-NB	22-18	1/4	Red	50
72F-187-20-NB	16-14	3/16	Blue	50
72F-250-32-NB	16-14	1/4	Blue	50
73F-250-32-NB	12-10	1/4	Yellow	25

Flag Terminals



FEMALE

IBS No.	Wire	Blade	Color	Qty
71F-250-90-NBL	22-18	1/4	Red	50
72F-250-90-NBL	16-14	1/4	Blue	50

Snap Plugs



MALE SNAP PLUGS

IBS No.	Wire	Blade	Color	Qty
81M-156-NB	22-18	5/32	Red	50
82M-156-NB	16-14	5/32	Blue	50
82M-180-NB	16-14	3/16	Blue	50



FEMALE SNAP PLUGS

IBS No.	Wire	Plug	Color	Qty
81F-156-NBL	22-18	5/32	Red	50
82F-156-NBL	16-14	5/32	Blue	50
82F-180-NBL	16-14	3/16	Blue	50

Multi-Stacks



IBS No.	Wire	Blade	Color	Qty
772-250-NB	16-14	1/4	Blue	50

Closed End Connectors



IBS No.	Wire	Color	Qty
722-N	22-14	Clear	50
718-N	18-10	Clear	100
4066A	#8	Clear	50

IBS, INCORPORATED

Nylon Insulated With Grip Q3C



Nylon Insulated Terminal Assortment (Z02)
Nylon Insulated Double Grip Solderless Terminals
IBS No. 101R • 24 Items • 270 Pcs
Packaged in a locking steel drawer for easy storage and organization



IBS Inc.
 INDUSTRIAL ELECTRIC PRODUCTS
 WWW.IBSINC.COM 800-879-1808

Nylon Insulated Double Grip Solderless Terminal

01-SN 22-18 BUTT CONNECTOR	11-68NB 22-18 X #6 RING TERMINAL	11-88NB 22-18 X #8 RING TERMINAL	11-10NB 22-18 X #10 RING TERMINAL	01-10NB 22-18 X #10 SPADE TERMINAL	72F-250-32-NBL 16-14 FEMALE QUICK SLIDE
02-SN 16-14 BUTT CONNECTOR	12-68NB 16-14 X #6 RING TERMINAL	12-10NB 16-14 X #10 RING TERMINAL	12-148NB 16-14 X 1/4" RING TERMINAL	32-10NB 16-14 X #10 SPADE TERMINAL	72M-250-32-NBL 16-14 MALE QUICK SLIDE
03-SN 12-10 BUTT CONNECTOR	82F-156-NBL 16-14 FEMALE BULLET	82M-156-NB 16-14 MALE BULLET	33-10NB 12-10 X #10 SPADE TERMINAL	13-88NB 12-10 X #8 RING TERMINAL	72M-250-32-NBL 12-10 MALE QUICK SLIDE
13-10NB 12-10 X #10 RING TERMINAL	13-148NB 12-10 X 1/4" RING TERMINAL	13-568NB 12-10 X 5/16" RING TERMINAL	13-388NB 12-10 X 3/8" RING TERMINAL	13-500NB 12-10 X 1/2" RING TERMINAL	73F-250-32-NBL 12-10 FEMALE QUICK SLIDE

ELECTRICAL

Red 22-18 Electrical Connectors
IBS No. 400R • 20 Items • 215 Pcs
Packaged in a locking steel drawer for easy storage and organization



IBS Inc.
 INDUSTRIAL ELECTRIC PRODUCTS
 WWW.IBSINC.COM 800-879-1808

Red 22-18 Electrical Connectors

01-SN 22-18 BUTT CONN NYLON	01NM 22-18 MOISTURE RESIST BUTT CON	05518 22-18 MULTILINK BUTT CONNECTOR	01-6NB 22-18 SPADE TERM 6 STUD NYLON	01-8NB 22-18 SPADE TERM 8 STUD NYLON	01-10NB 22-18 SPADE TERM 10 STUD NYLON
11-68NB 22-18 RING TERM 6 STUD NYLON	11-88NB 22-18 RING TERM 8 STUD NYLON	11-10NB 22-18 RING TERM 10 STUD NYLON	11-148NB 22-18 RING TERM 1/4 STUD NYLON	11-56NB 22-18 RING TERM. 5/16 STUD NYLON	11-38NB 22-18 RING TERM. 3/8 STUD NYLON
81M-156-NB 22-18 MALE SNAP PLUG FULL NY	81F-156-NBL 22-18 FEMALE SNAP PLUG FULL NY	71M-250-32-NBL 22-18 MALE QIK SLIDE FULL	71F-250-32-NBL 22-18 FEMALE QIK SLIDE FULL NY	71M-250-32-NB 22-18 MALE QIK SLIDE NYLON	71F-250-32-NB 22-18 FEMALE QIK SLIDE NYLON
71F-250-90-NBL 22-18 1/4 90DGR F QIK	81P-47-NB 22-18 PIN TERMINAL NYLON				

Blue 16-14 Electrical Connectors
IBS No. 401R • 20 Items • 215 Pcs
Packaged in a locking steel drawer for easy storage and organization



IBS Inc.
 INDUSTRIAL ELECTRIC PRODUCTS
 WWW.IBSINC.COM 800-879-1808

Blue 16-14 Electrical Connectors

02-SN 16-14 BUTT CONN NYLON	02NM 16-14 MOISTURE RESIST BUTT CON	05514 16-14 MULTILINK BUTT CONNECTOR	02-6NB 16-14 SPADE TERM 6 STUD NYLON	02-8NB 16-14 SPADE TERM 8 STUD NYLON	02-10NB 16-14 SPADE TERM 10 STUD NYLON
12-68NB 16-14 RING TERM 6 STUD NYLON	12-88NB 16-14 RING TERM 8 STUD NYLON	12-10NB 16-14 RING TERM 10 STUD NYLON	12-148NB 16-14 RING TERM 1/4 STUD NYLON	12-56NB 16-14 RING TERM 5/16 STUD NYLON	12-38NB 16-14 RING TERM 3/8 STUD NYLON
82M-156-NB 16-14 MALE SNAP PLUG NYLON	82F-156-NBL 16-14 FEMALE SNAP PLUG FULL NY	72M-250-32-NBL 16-14 MALE QIK SLIDE FULL	72F-250-32-NBL 16-14 FEMALE QIK SLIDE FULL NY	72M-250-32-NB 16-14 MALE QIK SLIDE NYLON	72F-250-32-NB 16-14 FEMALE QIK SLIDE NYLON
72F-250-90-NBL 16-14 90DGR 1/4 F QIK	82P-47-NB 16-14 PIN TERMINAL NYLON				

Yellow 12-10 Electrical Connectors (Z02)
IBS No. 402R • 16 Items • 175 Pcs
Packaged in a locking steel drawer for easy storage and organization



IBS Inc.
 INDUSTRIAL ELECTRIC PRODUCTS
 WWW.IBSINC.COM 800-879-1808

Yellow 12-10 Electrical Connectors

03-SN 12-10 BUTT CONN NYLON	03NM 12-10 MOISTURE RESIST BUTT CON	05510 12-10 MULTILINK BUTT CONNECTOR	03-8NB 12-10 SPADE TERM 8 STUD NYLON	03-10NB 12-10 SPADE TERM 10 STUD NYLON
13-10NB 12-10 RING TERM 10 STUD NYLON	13-148NB 12-10 RING TERM 1/4 STUD NYLON	13-568NB 12-10 RING TERM 5/16 STUD NYLON	13-38NB 12-10 RING TERM 3/8 STUD NYLON	13-500NB 12-10 RING TERM 1/2 STUD NYLON
13-88NB 12-10 RING TERM 8 STUD NYLON	73M-250-32-NBL 12-10 MALE QK SLIDE FULL NYLON	73F-250-32-NBL 12-10 FEMALE QIK SLIDE FULL NY	73M-250-32-NB 12-10 MALE QIK SLIDE NYLON	73F-250-32-NB 12-10 FEMALE QIK SLIDE NYLON
83P-55-NB 12-10 PIN TERMINAL NYLON				



IBS, INCORPORATED

Nylon Insulated Q3C/Vinyl Q3B

Heavy Duty Terminals

- 25% more metal than 12-14 GA.
- Covers three (3) wire sizes including the two most popular — 12 & 14.
- Heavier metal gives vibration-free contact where other terminals may fail.
- Resists cracking and splitting after bending or crimping.
- Provides high insulation heat range — 250° continuous, 350° intermittent.
- Ideal for starters, alternators, generators, etc.



NYLON-INSULATED INSULATION GRIP (NB)

IBS No.	Wire	Stud	Color	Qty
123-10-NB	16-12	#10	Yellow	25
123-14-NB	16-12	1/4	Yellow	25
123-56-NB	16-12	5/16	Yellow	25
123-38-NB	16-12	3/8	Yellow	25
123-500-NB	16-12	1/2	Yellow	25

Heavy Duty Large Gauge Brazed Seam

Silver Brazed to Eliminate Cracking & Splitting

Ring Terminals



IBS No.	Wire	Stud	Color	Qty
14-10S-WN	8 GA	#10	Red	10
14-14S-WN	8 GA	1/4	Red	10
14-56-WN	8 GA	5/16	Red	10
14-38-WN	8 GA	3/8	Red	10
14-500S-WN	8 GA	1/2	Red	10
15-10S-WN	6 GA	#10	Blue	10
15-14S-WN	6 GA	1/4	Blue	10
15-56-WN	6 GA	5/16	Blue	10
15-38-WN	6 GA	3/8	Blue	10
15-500S-WN	6 GA	1/2	Blue	10
16-10-WN	4 GA	#10	Yellow	10
16-14-WN	4 GA	1/4	Yellow	10
16-56-WN	4 GA	5/16	Yellow	10
16-38-WN	4 GA	3/8	Yellow	10
16-500S-WN	4 GA	1/2	Yellow	10

Butt Connectors (Q3B)

Vinyl



BUTT CONNECTORS VINYL (WP)

IBS No.	Wire	Color	Qty
64-WP	8 GA	Red	10
65-WP	6 GA	Blue	10
66-WP	4 GA	Yellow	10

Heavy Duty Wire Ends for #8, #6 & #4 GA Wire Assortment (Z02)

IBS No. 159R • 18 Items • 180 Pcs
Packaged in a locking steel drawer for easy storage and organization



Heavy Duty Wire Ends for #8, #6 & #4 GA Wire

Assortment No. 159R

64-WP #8 BUTT CONNECTOR VINYL	65-WP #6 BUTT CONNECTOR VINYL	66-WP #4 BUTT CONNECTOR VINYL		
16-10-WN #8 RING TERM. 10 STUD NYLON	16-14-WN #6 RING TERM. 1/4 STUD NYLON	16-56-WN #4 RING TERM. 5/16 STUD NYLON	16-38-WN #4 RING TERM. 3/8 STUD NYLON	16-500S-WN #4 RING TERM. 1/2 STUD NYLON
15-10S-WN #6 RING TERM. 10 STUD NYLON	15-14S-WN #6 RING TERM. 1/4 STUD NYLON	15-56-WN #6 RING TERM. 5/16 STUD NYLON	15-38-WN #6 RING TERM. 3/8 STUD NYLON	15-500S-WN #6 RING TERM. 1/2 STUD NYLON
14-10S-WN #8 RING TERM. 10 STUD NYLON	14-14S-WN #8 RING TERM. 1/4 STUD NYLON	14-56-WN #8 RING TERM. 5/16 STUD NYLON	14-38-WN #8 RING TERM. 3/8 STUD NYLON	14-500S-WN #8 RING TERM. 1/2 STUD NYLON



Multilink Connectors Sealed Electrical System

Crimped for Maximum Reliability
Soldered for Strength & Conductivity
Sealed for Superior Durability



MULTILINKS Are the Ultimate Connection WHEN FAILURE IS NOT AN OPTION



THE CRIMP CONNECTOR

- Zippered brazed seam for superior crimp performance.
- Window for visual inspection.
- Wire stop prevents over-insertion.
- Serrated inner barrel for extra crimp strength.



THE SOLDER

- Flux coating to clean metal surfaces.
- Pre-measured solder to deliver the right amount.
- Low-temp solder alloy for ease of installation.



THE HEAT SHRINK TUBING

- Adhesive-lined polyolefin to seal the connection.
- Color-coded with wire gauge imprint for easy size identification.
- Translucent tubing to allow for visual inspection

The Ultimate Connection

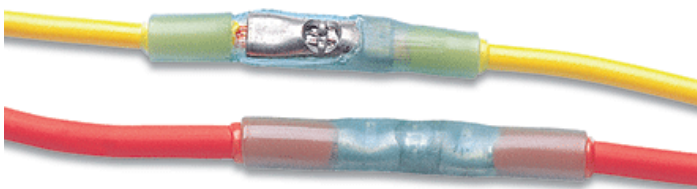

- **High quality, brazed seam crimp connector** provides a secure mechanical connection.
- **Pre-fluxed, low temperature solder** delivers superior current flow and tensile strength.
- **Translucent, adhesive-lined heat shrink tubing** allows for visual inspection and provides a seal against corrosion.
- **Crimped, soldered and sealed connection** meets or exceeds the most stringent OEM standards.

Easy-to-Install



1. Strip the wire to 3/8".
2. Select a connector (match wire gauge) & insert wire into the barrel.
3. Seat wire and crimp using an insulated crimping tool nest that matches the color or gauge of the connector. If placing a butt connector, repeat steps 1-3 for the other side.
4. Apply heat evenly around the length of tubing (including crimp area) from the center out to the ends until the tubing fully recovers and the adhesive flow & solder flows into the center opening.
5. Remove from heat and let cool for **THE ULTIMATE CONNECTION**.



IBS, INCORPORATED

Shrink Terminals Q2B

Multilink Connectors

Butt Connectors with Thermal Indicator

Take the Guesswork Out of Soldering!

- **Red thermal indicator** disappears from solder sleeve when solder has flowed
- **Lead-free solder alloy** has greater surface tension, stronger termination
- **"No-clean" flux** on solder sleeve cleans metals & provides quality solder termination

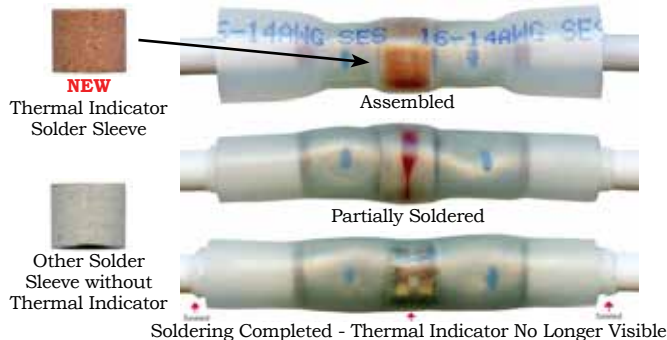

IBS No.	Wire	Color	Qty
BT5520	24-22	Clear	25
BT5518	20-18	Red	50
BT5514	16-14	Blue	50
BT5510	12-10	Yellow	25

Butt Connectors



IBS No.	Wire	Color	Qty
B5520	24-22	Clear	25
B5518	20-18	Red	50
B5514	16-14	Blue	50
B5510	12-10	Yellow	25

Spade Terminals



IBS No.	Wire	Stud	Color	Qty
140978	20-18	#6	Red	25
132147	20-18	#8	Red	25
125713	20-18	#10	Red	25
140979	16-14	#6	Blue	25
140980	16-14	#8	Blue	25
125714	16-14	#10	Blue	25
140981	12-10	#6	Yellow	25
140982	12-10	#8	Yellow	25
125715	12-10	#10	Yellow	25

Step-Butt Connectors



IBS No.	Wire	Color	Qty
B5560	24-22 to 22-18	Pink w / Red Ring	25
B5530	20-18 to 16-14	Blue w / Red Ring	25
B5540	16-14 to 12-10	Yellow w / Blue Ring	25
B5550	8 GA to 12-10	Pink w / Yellow Ring	25

Female Quickslides



IBS No.	Wire	Blade	Color	Qty
125717	20-18	.250	Red	25
125719	16-14	.250	Blue	25
125721	12-10	.250	Yellow	25

Male Quickslides



IBS No.	Wire	Blade	Color	Qty
125716	20-18	.250	Red	25
125718	16-14	.250	Blue	25
125720	12-10	.250	Yellow	25

Ring Terminals



IBS No.	Wire	Stud	Color	Qty
135159	20-18	#6	Red	25
125702	20-18	#8	Red	25
125703	20-18	#10	Red	25
125704	20-18	1/4	Red	25
138835	16-14	#6	Blue	25
125705	16-14	#8	Blue	25
125706	16-14	#10	Blue	25
125707	16-14	1/4	Blue	25
134189	16-14	5/16	Blue	25
125708	16-14	3/8	Blue	25
125709	12-10	#10	Yellow	25
125710	12-10	1/4	Yellow	25
134188	12-10	5/16	Yellow	25
125711	12-10	3/8	Yellow	25
125712	12-10	1/2	Yellow	25

ELECTRICAL



Multilink Wire Ends Assortment with Thermal Indicator Butt Connectors
IBS No. 859R • 24 Items • 175 Pcs
 Packaged in a locking steel drawer for easy storage and organization



IBS, Inc.		Multilink Wire Ends w/ Thermal Indicator Butt Connectors			
SPECIALTY PRODUCTS FOR PROFESSIONALS & SERVICE INDUSTRIES		Assortment No. 859R			
IBS518 20-18 MULTILINK BUTT CONNECTOR WITH THERMAL INDICATOR	IBS530 20-18 TO 16-14 MULTILINK STEP	IBS514 16-14 MULTILINK BUTT CONNECTOR WITH THERMAL INDICATOR	IBS540 16-14 TO 12-10 MULTILINK STEP	IBS510 12-10 MULTILINK BUTT CONNECTOR WITH THERMAL INDICATOR	IBS550 12-10 TO 8GA MULTILINK STEP
125702 20-18 MULTILINK #8 RING TERM	125713 20-18 MULTILINK #10 SPADE TERM	125705 16-14 MULTILINK #8 RING TERM	125714 16-14 MULTILINK #10 SPADE TERM	125709 12-10 MULTILINK #10 RING TERM	125715 12-10 MULTILINK #10 SPADE TERM
125703 20-18 MULTILINK #10 RING TERM	125716 20-18 MULTILINK .250 MALE	125706 16-14 MULTILINK #10 RING TERM	125718 16-14 MULTILINK .250 MALE	125710 12-10 MULTILINK 1/4 RING TERM	125720 12-10 MULTILINK .250 MALE
125704 20-18 MULTILINK 1/4 RING TERM	125717 20-18 MULTILINK .250 FEMALE	125707 16-14 MULTILINK 1/4 RING TERM	125719 16-14 MULTILINK .250 FEMALE	125711 12-10 MULTILINK 3/8 RING TERM	125721 12-10 MULTILINK .250 FEMALE

Multilink Wire Ends Assortment
IBS No. 385R • 24 Items • 175 Pcs
 Packaged in a locking steel drawer for easy storage and organization



IBS, Inc.		Multilink Wire Ends			
SPECIALTY PRODUCTS FOR PROFESSIONALS & SERVICE INDUSTRIES		Assortment No. 385R			
IBS518 20-18 MULTILINK BUTT CONNECTOR	IBS530 20-18 TO 16-14 MULTILINK STEP	IBS514 16-14 MULTILINK BUTT CONNECTOR	IBS540 16-14 TO 12-10 MULTILINK STEP	IBS510 12-10 MULTILINK BUTT CONNECTOR	IBS550 12-10 TO 8GA MULTILINK STEP
125702 20-18 MULTILINK #8 RING TERM	125713 20-18 MULTILINK #10 SPADE TERM	125705 16-14 MULTILINK #8 RING TERM	125714 16-14 MULTILINK #10 SPADE TERM	125709 12-10 MULTILINK #10 RING TERM	125715 12-10 MULTILINK #10 SPADE TERM
125703 20-18 MULTILINK #10 RING TERM	125716 20-18 MULTILINK .250 MALE	125706 16-14 MULTILINK #10 RING TERM	125718 16-14 MULTILINK .250 MALE	125710 12-10 MULTILINK 1/4 RING TERM	125720 12-10 MULTILINK .250 MALE
125704 20-18 MULTILINK 1/4 RING TERM	125717 20-18 MULTILINK .250 FEMALE	125707 16-14 MULTILINK 1/4 RING TERM	125719 16-14 MULTILINK .250 FEMALE	125711 12-10 MULTILINK 3/8 RING TERM	125721 12-10 MULTILINK .250 FEMALE

Multilink Wire Ends Assortment
Includes Torch & Butane Refill
IBS No. 324R • 21 Items • 147 Pcs
 Packaged in a locking steel drawer for easy storage and organization



IBS, Inc.		Multilink Wire Ends With Microtorch Butane Torch & Refill Included			
SPECIALTY PRODUCTS FOR PROFESSIONALS & SERVICE INDUSTRIES		Assortment No. 324R			
IBS518 20-18 MULTILINK BUTT CONNECTOR	125702 20-18 MULTILINK #8 RING TERM	125703 20-18 MULTILINK #10 RING TERM	125713 20-18 MULTILINK #10 SPADE TERM	125738 MICROTORCH BUTANE TORCH	
IBS514 16-14 MULTILINK BUTT CONNECTOR	125714 16-14 MULTILINK #10 SPADE TERM	125718 16-14 MULTILINK .250 MALE	125719 16-14 MULTILINK .250 FEMALE	125715 12-10 MULTILINK #10 SPADE TERM	
125705 16-14 MULTILINK #8 RING TERM	125706 16-14 MULTILINK #10 RING TERM	125707 16-14 MULTILINK 1/4 RING TERM	125708 16-14 MULTILINK 3/8 RING TERM	125720 12-10 MULTILINK .250 MALE	
IBS510 12-10 MULTILINK BUTT CONNECTOR	125709 12-10 MULTILINK #10 RING TERM	125710 12-10 MULTILINK 1/4 RING TERM	125711 12-10 MULTILINK 3/8 RING TERM	125721 12-10 MULTILINK .250 FEMALE	95007 40 GRAM BUTANE REFILL

Multilink Wire Ends Assortment (without Torch & Butane Refill)
IBS No. 314R • 19 Items • 145 Pcs
 Packaged in a locking steel drawer for easy storage and organization



IBS, Inc.		Multilink Wire Ends			
SPECIALTY PRODUCTS FOR PROFESSIONALS & SERVICE INDUSTRIES		Assortment No. 314R			
IBS518 20-18 MULTILINK BUTT CONNECTOR	125702 20-18 MULTILINK #8 RING TERM	125703 20-18 MULTILINK #10 RING TERM	125713 20-18 MULTILINK #10 SPADE TERM		
IBS514 16-14 MULTILINK BUTT CONNECTOR	125714 16-14 MULTILINK #10 SPADE TERM	125718 16-14 MULTILINK .250 MALE	125719 16-14 MULTILINK .250 FEMALE	125715 12-10 MULTILINK #10 SPADE TERM	
125705 16-14 MULTILINK #8 RING TERM	125706 16-14 MULTILINK #10 RING TERM	125707 16-14 MULTILINK 1/4 RING TERM	125708 16-14 MULTILINK 3/8 RING TERM	125720 12-10 MULTILINK .250 MALE	
IBS510 12-10 MULTILINK BUTT CONNECTOR	125709 12-10 MULTILINK #10 RING TERM	125710 12-10 MULTILINK 1/4 RING TERM	125711 12-10 MULTILINK 3/8 RING TERM	125721 12-10 MULTILINK .250 FEMALE	

ELECTRICAL



IBS, INCORPORATED

Shrink Terminals Q2B

Solder & Seal Terminals

While Supplies Last

Solder & Seal terminals are radically different from other connectors on the market. In a simple, one-step process, Solder & Seal terminals produce an electrically and environmentally sound connection. The soldering process insures that the resistance, voltage drop, and tensile strength of Solder & Seal terminals will exceed all current standards for wire connector performance. The tough, heat shrinkable tubing has an adhesive lining which provides a complete environmental seal to prevent corrosion and reduce vibration.



Design Features

- **Fluxed solder ring** melts and flows when heated to strengthen the connection, maximize current flow and minimize resistance.
- **Tough, multiple wall tubing** shrinks when heated and delivers above average vibration and tensile strength (700 psi vis 40 psi for a standard nylon splice) which reduces failure due to pull-out under stress.
- **Translucent, adhesive-lined** sleeve melts when heated to create an environmentally sealed connection which reduces failure due to moisture, corrosion, and vibration.
- **Industry standard color-coded sleeve** for quick identification saves time and eliminates costly errors.
- **No expensive crimp tools required** - means perfect connections anywhere.

Butt Connectors



IBS No.	Wire	Color	Qty
B5410	16-14	Blue	25

Ring Terminals



IBS No.	Wire	Stud	Color	Qty
B116-08	20-18	#8	Red	25
B116-10	20-18	#10	Red	25
B116-14	20-18	1/4	Red	25
B114-10	16-14	#10	Blue	25
B114-14	16-14	1/4	Blue	25
B114-38	16-14	3/8	Blue	25
B110-10	12-10	#10	Yellow	25
B110-14	12-10	1/4	Yellow	25
B110-38	12-10	3/8	Yellow	25
B110-12	12-10	1/2	Yellow	25

Quick Slides



MALE QUICK SLIDES - INSULATED SOLDER & SEAL

IBS No.	Wire	Color	Qty
B66-10M	12-10	Yellow	25



FEMALE QUICK SLIDES - INSULATED SOLDER & SEAL

IBS No.	Wire	Color	Qty
B66-18F	22-18	Red	25
B66-10F	12-10	Yellow	25

Spade Terminals



IBS No.	Wire	Stud	Color	Qty
B216-10	20-18	#10	Red	25
B214-10	16-14	#10	Blue	25
B210-10	12-10	#10	Yellow	25

PRODUCT CHARACTERISTICS

Temperature Rating: -65° to 275°F
 Dielectric Strength: 15kV
 Voltage Drop: Less than equal length of wire

Insulation Resistance: 1014 Megohms
Military Specifications
 Tubing: MIL-I-25053/4 Class1, AMS-3634
 Solder: QQ5571E, MIL-S-14256

ELECTRICAL



Crimp & Seal Terminals

Crimp & Seal terminals are all-weather, crimped and heat-sealed connectors suitable for every standard electrical connection. These connectors greatly upgrade the electrical systems of automobiles, boats and machinery by incorporating an adhesive-lined, heat-shrinkable tubing plus the finest metal connectors available. The result is a tough, durable and corrosion-resistant connection.

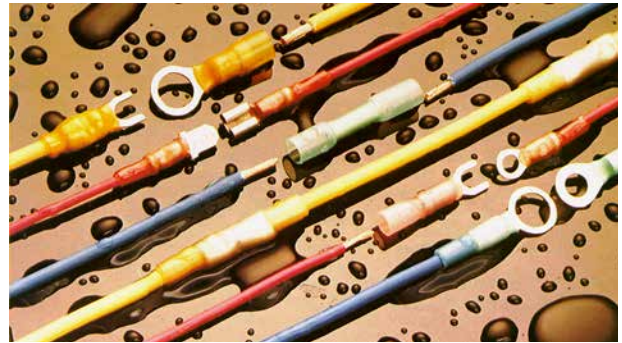

Clear Tubing
Allows Visual Inspection

Heavy Duty Tubing Provides
Additional Strain Relief

Long Copper Barrel
for Maximum Crimping & Conductivity

Inner Wall Melts to
Create an Environmental Seal When Heated

Standard Color Coding
Indicates Wire Sizes for Easy Identification



Design Features

- **Heavy duty, polyolefin tubing** provides maximum strain relief eliminating failure due to flex.
- **Meltable integral inner-wall lines the tube.** This special adhesive fills any existing voids and creates an environmental seal which repels moisture, and reduces vibration.
- **Electro-tin plated copper terminals** provide maximum conductivity insuring full power along with high corrosion resistance for long life.
- **Heat-shrinkable tubing is pre-shrunk to the terminal** eliminating a time consuming step and insuring that the wire will be sealed off from moisture.
- **Industry standard color coded sleeve** for quick identification saves time and eliminates errors.

Installation



Crimp & Seal terminals are easily crimped with a conventional tool for insulated connections. A hot air gun, or other heat source should be applied to the splice until the tubing recovers and the adhesive flows.

PRODUCT CHARACTERISTICS

Electrical Properties

Temperature Rating: 67° to 255°F
Dielectric Strength: 7.5KV
Voltage Drop: Less than equal length of wire
Insulation Resistance: 10⁶ Megohms

Insulation Properties

Initial Properties Tensile Strength: 7000 psi
Ultimate Elongation: 200%
After Heat Aging Tensile Strength: 700 psi
(168 hr: 315°F/158°C) Ultimate Elongation: 200%
Brittleness Impact No cracking (4 hr. -94°F/-70°C)
Cut-through Resistance 70 lbs.
Abrasion Resistance 700 cycles



IBS, INCORPORATED

Shrink Terminals Q2B

Crimp & Seal Terminals

Butt Connectors



IBS No.	Wire	Color	Qty
B5100	24-22	Clear	50
B5110	20-18	Red	50
B5210	16-14	Blue	50
B5310	12-10	Yellow	25
B5108	8 GA	Pink	25

Step Butt Connectors



IBS No.	Wire	Color	Qty
B5610	20-18 to 16-14	Blue w / Red Stripe	25
B5620	16-14 to 12-10	Yellow w / Blue Stripe	25
B5630	12-10 to 8 GA	Red w / Yellow Stripe	25

Spade Terminals



IBS No.	Wire	Stud	Color	Qty
B5118	20-18	#10	Red	25
B5228	16-14	#10	Blue	25
B5331	12-10	#10	Yellow	25

Snap Plugs



MALE SNAP PLUGS

IBS No.	Wire	Blade	Color	Qty
B5165	20-18	.156	Red	25
B5265	16-14	.156	Blue	25



FEMALE SNAP PLUGS

IBS No.	Wire	Plug	Color	Qty
B5175	20-18	.156	Red	25
B5275	16-14	.156	Blue	25

Ring Terminals



IBS No.	Wire	Stud	Color	Qty
B5112	20-18	#6	Red	25
B5113	20-18	#8	Red	25
B5114	20-18	#10	Red	25
B5115	20-18	1/4	Red	25
B5116	20-18	5/16	Red	25
B5117	20-18	3/8	Red	25
B5222	16-14	#6	Blue	25
B5223	16-14	#8	Blue	25
B5224	16-14	#10	Blue	25
B5225	16-14	1/4	Blue	25
B5226	16-14	5/16	Blue	25
B5227	16-14	3/8	Blue	25
B5323	12-10	#8	Yellow	25
B5324	12-10	#10	Yellow	25
B5325	12-10	1/4	Yellow	25
B5326	12-10	5/16	Yellow	25
B5327	12-10	3/8	Yellow	25
B5328	12-10	1/2	Yellow	25

Quick Slides



MALE QUICK SLIDES - INSULATED

IBS No.	Wire	Blade	Color	Qty
B5155	20-18	.250	Red	25
B5235	16-14	.187	Blue	25
B5255	16-14	.250	Blue	25
B5355	12-10	.250	Yellow	25



FEMALE QUICK SLIDES - FULLY INSULATED

IBS No.	Wire	Blade	Color	Qty
B5145	20-18	.250	Red	25
B5230	16-14	.187	Blue	25
B5245	16-14	.250	Blue	25
B5345	12-10	.250	Yellow	25

ELECTRICAL

IBS, INCORPORATED

Shrink Terminals Q2B



Crimp & Seal Long Neck Terminals

The Ideal Terminal for Heat Shrink Connectors

Standard sealed terminals often end up with a less than optimum seal because there just isn't enough room between the neck and ring to accommodate the shrink tubing and provide a perfect seal to keep out corrosion. Or, the shrink tubing impedes on the stud hole and makes mounting the ring terminal difficult.



Long Neck = Superior Contact Regular Neck = Inferior Contact



Long Neck Crimp & Seal Terminals are re-designed to solve both those issues and features the added benefit of being the ideal terminal for stacking applications.

- Longer neck provides more space for shrink tubing which means a better seal, giving a longer lasting terminal that won't corrode and fail over time.
- Longer neck also means more space for the stud hole to make mounting and attaching the ring terminals easier and giving a much better connection.
- Long neck design also makes for better terminal in stacking applications also providing a better connection and less chance of failure.

IBS No.	Wire	Stud	Color	Qty
136025	22-18	#6	Red	25
136026	22-18	#8	Red	25
136027	22-18	#10	Red	25
136028	14-16	#6	Blue	25
136029	14-16	#8	Blue	25
136030	14-16	#10	Blue	25
136031	14-16	1/4	Blue	25
136032	14-16	5/16	Blue	25
136033	14-16	3/8	Blue	25
136034	12-10	#8	Yellow	25
136035	12-10	#10	Yellow	25
136036	12-10	1/4	Yellow	25
136037	12-10	5/16	Yellow	25
136038	12-10	3/8	Yellow	25

Long Neck Crimp & Seal Terminals Assortment

IBS No. 790R • 14 Items • 140 Pcs
Packaged in a locking steel drawer for easy storage and organization



IBS, Inc.				Crimp & Seal Long Neck Terminals			
Assortment No. 790R							
136025 22-18 CRIMP & SEAL #6 LONG NECK RING	136029 16-14 CRIMP & SEAL #8 LONG NECK RING	136033 16-14 CRIMP & SEAL 3/8 LONG NECK RING	136037 12-10 CRIMP & SEAL 5/16 LONG NECK RING	136026 22-18 CRIMP & SEAL #8 LONG NECK RING	136030 16-14 CRIMP & SEAL #10 LONG NECK RING	136034 12-10 CRIMP & SEAL #8 LONG NECK RING	136038 12-10 CRIMP & SEAL 3/8 LONG NECK RING
136027 22-18 CRIMP & SEAL #10 LONG NECK RING	136031 16-14 CRIMP & SEAL 1/4 LONG NECK RING	136035 12-10 CRIMP & SEAL #10 LONG NECK RING		136028 16-14 CRIMP & SEAL #6 LONG NECK RING	136032 16-14 CRIMP & SEAL 5/16 LONG NECK RING	136036 12-10 CRIMP & SEAL 1/4 LONG NECK RING	

Crimp & Seal Terminals with Long Neck Ring Terminals

IBS No. 791R • 24 Items • 240 Pcs
Packaged in a locking steel drawer for easy storage and organization



IBS, Inc.				Crimp & Seal Wire Ends w/ Long Neck Ring Terminals			
Assortment No. 791R							
B5110 20-18 CRIMP & SEAL BUTT CONNECTOR	B5118 20-18 #10 CRIMP & SEAL SPADE TERM	136028 16-14 #6 CRIMP & SEAL LONG NECK RING	136033 16-14 3/8 CRIMP & SEAL LONG NECK RING	B5310 12-10 CRIMP & SEAL BUTT CONNECTOR	136038 12-10 3/8 CRIMP & SEAL LONG NECK RING	136025 22-18 CRIMP & SEAL #6 LONG NECK RING	B5155 20-18 CRIMP & SEAL 250 MALE CONN
136026 22-18 #6 CRIMP & SEAL LONG NECK RING	136029 16-14 #8 CRIMP & SEAL LONG NECK RING	B5228 16-14 CRIMP & SEAL #10 SPADE TERM	136034 12-10 #8 CRIMP & SEAL LONG NECK RING	B5331 12-10 CRIMP & SEAL #10 SPADE TERM		136027 22-18 #8 CRIMP & SEAL LONG NECK RING	B5145 20-18 CRIMP & SEAL 250 FEMALE CONN
136028 16-14 CRIMP & SEAL #6 LONG NECK RING	B5210 16-14 CRIMP & SEAL BUTT CONNECTOR	136030 16-14 #10 CRIMP & SEAL LONG NECK RING	B5255 16-14 CRIMP & SEAL 250 MALE CONN	136035 12-10 #10 CRIMP & SEAL LONG NECK RING	B5385 12-10 CRIMP & SEAL 250 MALE CONN	136029 16-14 #8 CRIMP & SEAL LONG NECK RING	B5245 16-14 CRIMP & SEAL 250 FEMALE CONN
136027 22-18 #10 CRIMP & SEAL LONG NECK RING	136031 16-14 1/4 CRIMP & SEAL LONG NECK RING	B5245 16-14 CRIMP & SEAL 250 FEMALE CONN	136036 12-10 1/4 CRIMP & SEAL LONG NECK RING	B5345 12-10 CRIMP & SEAL 250 FEMALE CONN		136026 22-18 #8 CRIMP & SEAL LONG NECK RING	



IBS, INCORPORATED

Assortments Z02

Crimp & Seal Terminals Assortment

Includes Torch & Butane Refill
IBS No. 109R • 21 Items • 315 Pcs
 Packaged in a locking steel drawer for easy storage and organization



IBS, Inc.					Crimp & Seal Terminals w/ Torch & Butane Refill	
INDUSTRIAL PRODUCTS OF THE EAST MANUFACTURING & SERVICE INDUSTRIES, INC. • P.O. BOX 478-1806					Assortment No. 109R	
			B5233 16-14 CRIMP & SEAL #8 RING TERM	B5234 16-14 CRIMP & SEAL #10 RING TERM	128738 - 95007 MICROTORCH BUTANE TORCH - REFILL	
B5225 16-14 CRIMP & SEAL 1/4 RING TERM	B5228 16-14 CRIMP & SEAL #10 SPADE TERM	B5245 16-14 CRIMP & SEAL .250 FEMALE CONN	B5255 16-14 CRIMP & SEAL .250 MALE CONN	B5265 16-14 CRIMP & SEAL .156 MALE BULLET		
B5275 16-14 CRIMP & SEAL .156 FEMALE BULLET	B5324 12-10 CRIMP & SEAL #10 RING TERM	B5325 12-10 CRIMP & SEAL 1/4 RING TERM	B5327 12-10 CRIMP & SEAL 3/8 RING TERM	B5345 12-10 CRIMP & SEAL .250 FEMALE CONN	B280 22-18 SOLDER&SEAL SHRINK TUBE	
B5355 12-10 CRIMP & SEAL .250 MALE CONN	B5110 20-18 CRIMP & SEAL BUTT CONNECTOR	B5210 16-14 CRIMP & SEAL BUTT CONNECTOR	B5310 12-10 CRIMP & SEAL BUTT CONNECTOR	B5100 22-24 CRIMP & SEAL BUTT CONNECTOR	B281 16-14 SOLDER&SEAL SHRINK TUBE	
					B282 12-10 SOLDER&SEAL SHRINK TUBE	

Crimp & Seal Terminals Assortment

IBS No. 316R • 19 Items • 348 Pcs
 Packaged in a locking steel drawer for easy storage and organization



IBS, Inc.					Crimp-N-Seal Terminals	
INDUSTRIAL PRODUCTS OF THE EAST MANUFACTURING & SERVICE INDUSTRIES, INC. • P.O. BOX 478-1806					Assortment No. 316R	
			B5233 16-14 CRIMP & SEAL #8 RING TERM	B5234 16-14 CRIMP & SEAL #10 RING TERM	B280 22-18 SOLDER&SEAL SHRINK TUBE	
B5225 16-14 CRIMP & SEAL 1/4 RING TERM	B5228 16-14 CRIMP & SEAL #10 SPADE TERM	B5245 16-14 CRIMP & SEAL .250 FEMALE CONN	B5255 16-14 CRIMP & SEAL .250 MALE CONN	B5265 16-14 CRIMP & SEAL .156 MALE BULLET	B281 16-14 SOLDER&SEAL SHRINK TUBE	
B5275 16-14 CRIMP & SEAL .156 FEMALE BULLET	B5324 12-10 CRIMP & SEAL #10 RING TERM	B5325 12-10 CRIMP & SEAL 1/4 RING TERM	B5327 12-10 CRIMP & SEAL 3/8 RING TERM	B5345 12-10 CRIMP & SEAL .250 FEMALE CONN	B282 12-10 SOLDER&SEAL SHRINK TUBE	
B5355 12-10 CRIMP & SEAL .250 MALE CONN	B5110 20-18 CRIMP & SEAL BUTT CONNECTOR	B5210 16-14 CRIMP & SEAL BUTT CONNECTOR	B5310 12-10 CRIMP & SEAL BUTT CONNECTOR	B5100 24-22 CRIMP & SEAL BUTT CONNECTOR		

Crimp & Seal Terminals Assortment

IBS No. 386R • 24 Items • 240 Pcs
 Packaged in a locking steel drawer for easy storage and organization



IBS, Inc.					Crimp & Seal Wire Ends	
INDUSTRIAL PRODUCTS OF THE EAST MANUFACTURING & SERVICE INDUSTRIES, INC. • P.O. BOX 478-1806					Assortment No. 386R	
B5110 20-18 CRIMP & SEAL BUTT CONNECTOR	B5115 20-18 CRIMP & SEAL 1/4 RING TERM	B5210 16-14 CRIMP & SEAL BUTT CONNECTOR	B5227 16-14 CRIMP & SEAL 3/8 RING TERM	B5310 12-10 CRIMP & SEAL BUTT CONNECTOR	B5327 12-10 CRIMP & SEAL 3/8 RING TERM	
B5112 20-18 CRIMP & SEAL #6 RING TERM	B5118 20-18 #10 CRIMP & SEAL SPADE TERM	B5223 16-14 CRIMP & SEAL #8 RING TERM	B5228 16-14 CRIMP & SEAL #10 SPADE TERM	B5323 12-10 CRIMP & SEAL #8 RING TERM	B5331 12-10 CRIMP & SEAL #10 SPADE TERM	
B5113 20-18 CRIMP & SEAL #8 RING TERM	B5155 20-18 CRIMP & SEAL .250 MALE CONN	B5224 16-14 CRIMP & SEAL #10 RING TERM	B5255 16-14 CRIMP & SEAL .250 MALE CONN	B5324 12-10 CRIMP & SEAL #10 RING TERM	B5355 12-10 CRIMP & SEAL .250 MALE CONN	
B5114 20-18 CRIMP & SEAL #10 RING TERM	B5145 20-18 CRIMP & SEAL .250 FEMALE CONN	B5225 16-14 CRIMP & SEAL 1/4 RING TERM	B5245 16-14 CRIMP & SEAL .250 FEMALE CONN	B5325 12-10 CRIMP & SEAL 1/4 RING TERM	B5345 12-10 CRIMP & SEAL .250 FEMALE CONN	

ELECTRICAL

HydraLink Connectors

Sealed Connectors for Multiple Wires

HydraLink Inline Butt Connectors

- Connects 1 wire to 2 wires.
- Provides a superior alternative to unsealed quick taps.
- Crimped for positive connectivity.
- Sealed for durability & corrosion resistance.

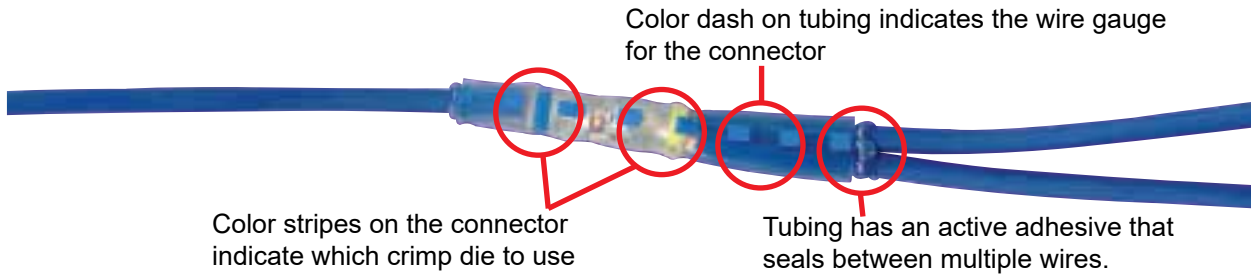

HYDRALINK INLINE BUTT CONNECTORS

	IBS No.	Wire GA	Tubing Color	Color Stripe on Connector	Wire	Crimp Die (Insulated)	Qty
	B5716	20-18 AWG	Clear / Red Dashes	Side 1: Red Side 2: Blue	One: 20-18 Two: 20-18	Red (20-18) Blue (16-14)	15
	B5714	16-14 AWG	Clear / Blue Dashes	Side 1: Blue Side 2: Yellow	One: 16-14 Two: 16-14	Blue (16-14) Yellow (12-10)	15
	B5710	12-10 AWG	Clear / Yellow Dashes	Side 1: Yellow Side 2: Red	One: 12-10 Two: 12-10	Yellow (12-10) Red (8 GA)	15

HydraLink Closed End Connectors

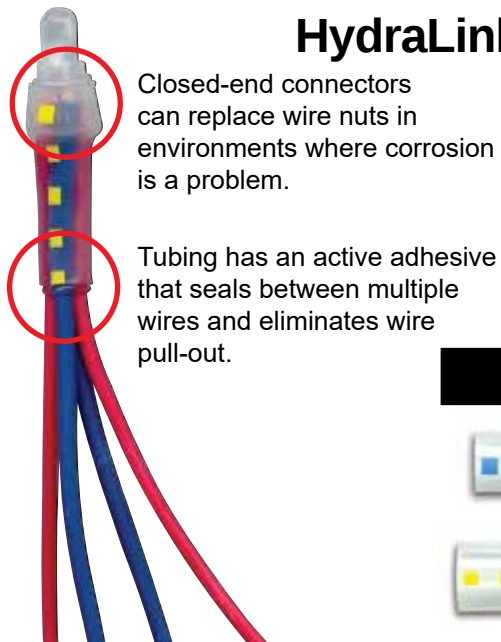

- Connects up to 4 wires.
- Provides a superior alternative to wire nuts.
- Crimped for positive connectivity.
- Adhesive tubing eliminates pull-out.
- Sealed for durability & corrosion resistance.

HYDRALINK CLOSED END CONNECTORS

	IBS No.	Wire	Tubing Color	Qty
	B5814	22-14 AWG	Clear / Blue Dashes	15
	B5810	18-10 AWG	Clear / Yellow Dashes	15



IBS, INCORPORATED





































Assortments Z02

Sealed Wire Connectors II Assortment

IBS No. 761R • 17 Items • 145 Pcs

Packaged in a locking steel drawer for easy storage and organization



 IBS, Inc. <small>SPECIALTY PRODUCTS FOR MAINTENANCE & REPAIR INDUSTRIALBOLT.COM © © © 800-678-1506</small>		Sealed Wire Connectors II			Assortment No. 761R
B5560 26-24 TO 22-18 MULTILINK STEP BUTT CONNECTOR  	B5610 20-18 X 16-14 CRIMP & SEAL STEP BUTT CON  	B5716 20-18 HYDRALINK IN LINE BUTT CONNECTOR  	B5916 22-18 OPTISEAL BUTT CONNECTOR  	61-CS 22-18 COOL-SEAL BUTT CONNECTOR NYLON  	
B5530 20-18 TO 16-14 MULTILINK STEP BUTT CONN  	B5620 16-14 12-10 CRIMP & SEAL STEP BUTT CON  	B5714 16-14 HYDRALINK IN LINE BUTT CONNECTOR  	B5914 16-14 OPTISEAL BUTT CONNECTOR  	62-CS 16-14 COOL-SEAL BUTT CONNECTOR NYLON  	
B5540 16-14 TO 12-10 MULTILINK STEP BUTT CONN  	B5630 12-10 X 8GA CRIMP & SEAL STEP BUTT CONN  	B5710 12-10 HYDRALINK IN LINE BUTT CONNECTOR  	B5910 12-10 OPTISEAL BUTT CONNECTOR  	63-CS 12-10 COOL-SEAL BUTT CONNECTOR NYLON  	
B5550 12-10 TO 8GA MULTILINK STEP BUTT CONN  	B5814 22-14 HYDRALINK CLOSED END CONNECTOR  	B5810 18-10 HYDRALINK CLOSED END CONNECTOR  			

E
L
E
C
T
R
I
C
A
L

IBS, INCORPORATED

Shrink Terminals Q2B



Optiseal Terminals

For a Clear and OPTimal View of the Connection

OptiSeal connectors are designed to provide optimal visual assurance of a sealed crimp connection and eliminate mis-crimps. Standard connectors do not allow the installer to see the wire, which can result in the following problems:



- 1) Wire stripped too short — which can result in crimping the end of the wire (poor termination).
- 2) Wire is not fully seated to the connector, which can result in a poor termination.

COLOR CODED TERMINALS

- Ring Terminals have a 45° barrel that assures the wire is seated properly and wire is being crimped to the terminal for optimal connection, saving on timely repairs and failure.
- Longer neck provides more space for shrink tubing which means a better seal, for a longer lasting terminal that won't corrode and fail over time.
- Longer neck also means more space for the stud hole to make mounting and attaching ring terminals easier which provides a much better connection — meaning an optimum electrical connection with no power loss and less chance for corrosion.
- The long neck design also makes for a better terminal in stacking applications also providing a better connection and less chance of failure.
- Color-coded stripes also indicate/guide where to position crimp nest to install properly for the correct connection reducing failure and downtime.
- Brazed seam barrel ensures superior crimp performance for optimum connection saving on timely repairs and failure.
- Serrations in the crimp barrel provide strong mechanical termination for stronger hold reducing the chance of failure or pullout.

Optiseal Ring Terminals



IBS No.	Description	Qty
136040	12-10 OptiSeal Ring #6	25
136001	12-10 Optiseal Ring #8	25
136002	12-10 Optiseal Ring #10	25
136003	12-10 Optiseal Ring 1/4	25
136004	12-10 Optiseal Ring 5/16	25
136005	12-10 Optiseal Ring 3/8	25
136041	12-10 Optiseal Ring 1/2	25
136006	16-14 Optiseal Ring #6	25
136007	16-14 Optiseal Ring #8	25
136008	16-14 Optiseal Ring #10	25
136009	16-14 Optiseal Ring 1/4	25
136010	16-14 Optiseal Ring 5/16	25
136011	16-14 Optiseal Ring 3/8	25
136012	22-18 Optiseal Ring #6	25
136013	22-18 Optiseal Ring #8	25
136014	22-18 Optiseal Ring #10	25
136042	22-18 Optiseal Ring 1/4	25
136043	22-18 Optiseal Ring 5/16	25
136044	22-18 Optiseal Ring 3/8	25

ELECTRICAL

Optiseal Step Butt Connectors



IBS No.	Wire	Code Color	Qty
136015	12-10 to 8GA	Yellow to Red	25
136016	16-14 to 12-10	Blue to Yellow	25
136017	22-18 to 16-14	Red to Blue	25
136018	22-24 to 22-18	White to Red	25

Optiseal Butt Connectors



IBS No.	Wire	Code Color	Qty
B5916	22-18	Red	25
B5914	16-14	Blue	25
B5910	12-10	Yellow	25



IBS, INCORPORATED

Shrink Terminals Q2B

ELECTRICAL

Optiseal Male & Female Connectors

STANDARD LENGTH



IBS No.	Description	Qty
136019	12-10 OptiSeal .250 Female Conn	25
136020	12-10 OptiSeal .250 Male Conn	25
136021	16-14 OptiSeal .250 Female Conn	25
136039	16-14 OptiSeal .250 Male Conn	25
136023	22-18 OptiSeal .250 Female Conn	25
136024	22-18 OptiSeal .250 Male Conn	25

Optiseal Male & Female Connectors

PARTIALLY INSULATED



IBS No.	Description	Qty
136051	12-10 .250 Female Connector Partially Insulated	25
136053	12-10 .250 Male Connector Partially Insulated	25
136054	16-14 .250 Female Connector Partially Insulated	25
136056	16-14 .250 Male Connector Partially Insulated	25
136057	22-18 .250 Female Connector Partially Insulated	25
136059	22-18 .250 Male Connector Partially Insulated	25

Optiseal Female Connector

FULLY INSULATED



IBS No.	Description	Qty
136052	12-10 .250 Female Long Neck Connector — Fully Insulated	25
136055	16-14 .250 Female Long Neck Connector — Fully Insulated	25
136058	22-18 .250 Female Long Neck Connector — Fully Insulated	25

Optiseal Spade Terminals



IBS No.	Description	Qty
136045	12-10 #8-#10 Stud Spade	25
136046	12-10 1/4 Stud Spade	25
136047	16-14 #6 Stud Spade	25
136048	16-14 #8-#10 Stud Spade	25
136049	22-18 #6 Stud Spade	25
136050	22-18 #8-#10 Stud Spade	25

Optiseal Male Bullet Plug Connectors



IBS No.	Description	Qty
136063	12-10 OptiSeal Male Bullet .180 Plug	25
136061	12-10 OptiSeal Male Bullet .157 Plug	25
136067	16-14 OptiSeal Male Bullet .180 Plug	25
136065	16-14 OptiSeal Male Bullet .157 Plug	25
136071	22-18 OptiSeal Male Bullet .180 Plug	25
136069	22-18 OptiSeal Male Bullet .157 Plug	25

Optiseal Female Bullet Receptacle Connectors



IBS No.	Description	Qty
136062	12-10 OptiSeal Female Bullet .180 Recep	25
136060	12-10 OptiSeal Female Bullet .157 Recep	25
136066	16-14 OptiSeal Female Bullet .180 Recep	25
136064	16-14 OptiSeal Female Bullet .157 Recep	25
136070	22-18 OptiSeal Female Bullet .180 Rec	25
136068	22-18 OptiSeal Female Bullet .157 Rec	25

IBS, INCORPORATED

Assortments Z02



























OptiSeal Terminals

IBS No. 793R • 24 Items • 220 Pieces

Packaged in a locking steel drawer for easy storage and organization



 Optiseal Terminals					
Assortment No. 793R					
B5916 22-18 OPTISEAL BUTT CONNECTOR 	136017 22-18 TO 16-14 OPTISEAL STEP BUTT 	B5914 16-14 OPTISEAL BUTT CONNECTOR 	136016 16-14 TO 12-10 OPTISEAL STEP BUTT 	B5910 12-10 OPTISEAL BUTT CONNECTOR 	136015 12-10 TO 8GA OPTISEAL STEP BUTT CONNECTOR 
136018 24-22 TO 22-18 OPTISEAL STEP BUTT 	136014 22-18 #10 OPTISEAL RING TERMINAL 	136007 16-14 #8 OPTISEAL RING TERMINAL 	136011 16-14 3/8 OPTISEAL RING TERMINAL 	136001 12-10 #8 OPTISEAL RING TERMINAL 	136005 12-10 3/8 OPTISEAL RING TERMINAL 
136012 22-18 #6 OPTISEAL RING TERMINAL 	136023 22-18 .250 FEMALE OPTISEAL CONNECTOR 	136008 16-14 #10 OPTISEAL RING TERMINAL 	136021 16-14 .250 FEMALE OPTISEAL CONNECTOR 	136002 12-10 #10 OPTISEAL RING TERMINAL 	136019 12-10 .250 FEMALE OPTISEAL CONNECTOR 
136013 22-18 #8 OPTISEAL RING TERMINAL 	136024 22-18 .250 MALE OPTISEAL CONNECTOR 	136009 16-14 1/4 OPTISEAL RING TERMINAL 	136039 16-14 .250 MALE OPTISEAL CONNECTOR 	136003 12-10 1/4 OPTISEAL RING TERMINAL 	136020 12-10 .250 MALE OPTISEAL CONNECTOR 

Optiseal Terminals & Heat Shrink Kits (Z08)

728R-1 OptiSeal Shrink Tube Kit with Ratcheting Crimper

728R OptiSeal Conn & Shrink Tube Kit Only

Packaged in a locking plastic travel tray for easy storage and organization



OPTISEAL KIT CONTENTS

IBS No.	Description	Qty
B5910	12-10 OPTISEAL Butt Connector	25
B5914	16-14 OPTISEAL Butt Connector	25
B5916	22-18 OPTISEAL Butt Connector	25
B5920	12-10 OPTISEAL Shrink Tube	5
B5924	16-14 OPTISEAL Shrink Tube	10
B5926	22-18 OPTISEAL Shrink Tube	10
Included with 728R-1		
B0050	Ratcheting Crimp Tool	1

ELECTRICAL



IBS, INCORPORATED

Shrink Terminals Q2B

Cool Seal Terminals (Q3C)

Cool Seal terminals are the most innovative and cost-effective sealed electrical connector to hit the market in 25 years. A heat-less, solder-less terminal, it utilizes revolutionary technology that installs in a fraction of the time of comparable heat seal connectors.



E
L
E
C
T
R
I
C
A
L

- Seals out moisture causing corrosion — assuring a better connection and longer life.
- A heat-less / solder-less connection — for ease of use and safety because no flame is required.
- Patented anaerobic technology — adhesive activated when wire is inserted for maximum strength.
- Simply strip and crimp for a fast, economical connection.
- No heat tools required, making it a faster, safer connection.
- Nylon insulation for superior protection and longer life.
- 99.9% ETP copper terminal for maximum connectivity.

BUTT CONNECTORS

IBS No.	Wire	Color	Qty
61-CS	22-18	Red	50
62-CS	16-14	Blue	50
63-CS	12-10	Yellow	25
CS-PACK	1 Pkg of All Three Colors		125

IBS, INCORPORATED

Quick Connectors Q3E



3M Performance Plus Wire Connectors

- **Unique Design:** Accommodates multiple wire combinations.
- **Rounded Wings:** Makes connectors easier to grip.
- **Flexible Skirt:** Covers overstrips for additional safety.
- **3 Connectors in Family:** Covers entire 600V range.

FASTER AND EASIER TO USE

Grips Quicker, Pulls on Faster

The unique spring design grips quickly, turns on fast and expands to accept a wide range of wire sizes. The unique spring design also bites quicker for secure connections every time.

Covers a Wider Range

The larger throat design and extended skirt allow just three connectors to cover the entire 600V range.

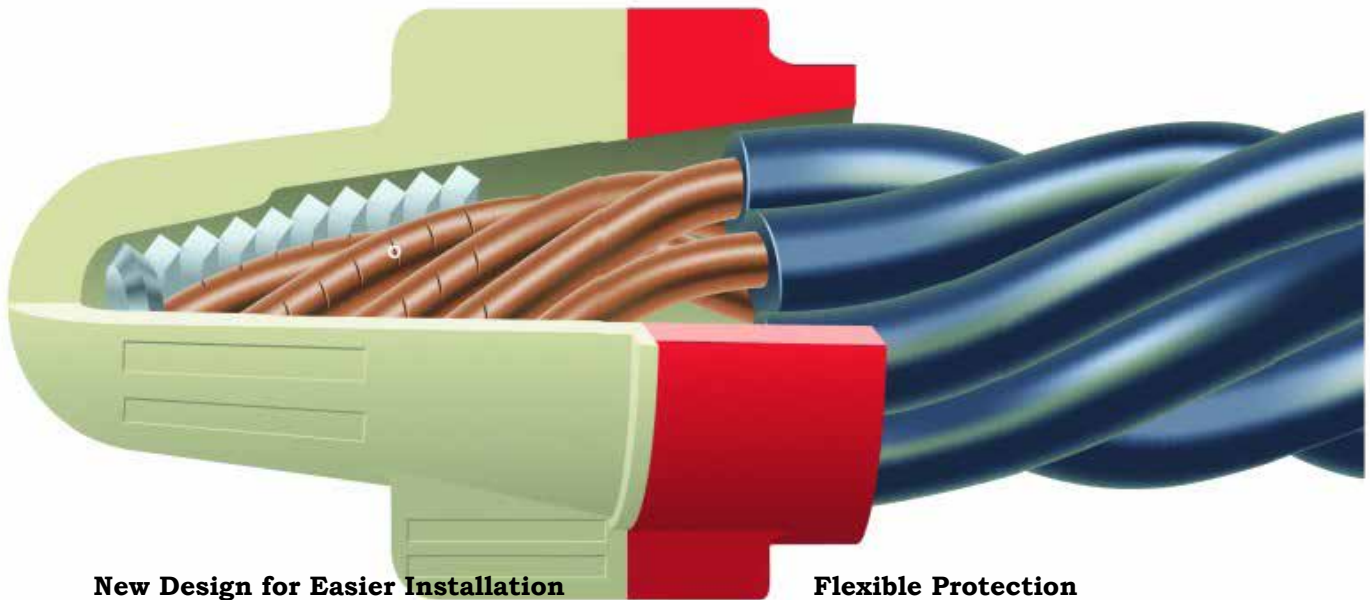

New Design for Easier Installation

A newly modified internal design makes installation smooth, fast and easy on the hands.

Flexible Protection

Long, flexible skirt covers overstrips and protects conductors, but readily bends and conforms to take up less room.

3M PERFORMANCE PLUS WIRE CONNECTORS

	IBS No.	Color	Wire Combination Range		Voltage Rating	Qty
			MIN	MAX		
	973	Orange Blue	2 # 22	2 # 12	600V UL Listed	50
	974	Red Yellow	2 # 18	2 # 8		50
	975	Blue Gray	4 # 14	2 # 6		25

E
L
E
C
T
R
I
C
A
L



IBS, INCORPORATED

Quick Connectors Q3E

Wall Nuts

Pushwire Connectors for Solid and Stranded Copper Wire

Use with Multiple Wire Gauges



See the Safety:

- Clear housing allows visual confirmation of connection.
- Test port for easy continuity testing.

Fast, Easy Installation:

- No more twisting and taping required.
- Strip the wire, insert the conductor, and you're done!

Safe:

- Each wire is held individually, eliminating loose connections.
- Touch-proof and rated to 105°C.
- UL listed/CSA certified for 600 volts (1000 volts for fixtures and signs) and current rated to the largest conductor used.

Save Time:

- Wall Nuts™ provide up to 50% time savings on installation.
- Secure connections reduce expensive troubleshooting and warranty work.

	IBS No.	Push-In Cond	Strand Copper	Solid Copper	Qty
	773-162	2	12-16 AWG stranded (<19 strands) Strip Length =0.47in	12-18 AWG	100
	773-164	4			100
	773-166	6			100
	773-168	8			50
	773-173	3	10-14 AWG Strip Length =0.47in	10-14 AWG	50

Lever Nut

Pushwire Connector for Solid and Stranded Copper Wire With Locking Lever

Use with Multiple Wire Gauges



Fast, Easy Installation:

- Spring pressure connection technology for a secure and locked connection.
- Built in test port for easy continuity testing.
- No more twisting and taping required.
- Strip the wire, insert the conductor, snap the lever down and you're done!

Safe:

- Each wire is held individually, eliminating loose connections.
- Touch-proof and rated to 105°C.
- UL listed/CSA certified for 600 volts (1000 volts for fixtures and signs).

Save Time:

- Like the Wall Nuts™, Lever Nut provides up to 50% time savings on installation.
- Secure connections reduce expensive troubleshooting and warranty work.

	IBS No.	Push-In Cond	Strand Copper	Solid Copper	Qty
	222-412	2	12-28 AWG Strip Length =0.47in	12-28 AWG Strip Length =0.47in	50
	222-413	3	12-28 AWG Strip Length =0.47in	12-28 AWG Strip Length =0.47in	50
	222-415	5	12-28 AWG Strip Length =0.47in	12-28 AWG Strip Length =0.47in	40

ELECTRICAL

IBS, INCORPORATED

Quick Connectors Q3E



Lever-Nuts

Compact Splicing Connectors for All Wire Types.

Smaller and More User Friendly



See the Safety:

- Clear housing allows visual confirmation of connection.
- Test port for easy continuity testing.

Fast, Easy Installation:





- Connects solid, stranded, and fine-stranded conductors from 24-12 AWG, Inline accepts 20-12 AWG
- Lift the lever up, insert conductor and push lever back down

Safe:

- Each wire is held individually, eliminating loose connections.
- Touch-proof and rated to 105°C.
- UL listed/CSA certified for 600 volts (1000 volts for fixtures and signs) and current rated largest conductor used.

Save Time:

- Tool free connection and disconnection with easy-to-use lever design.

IBS No.	Push-In Cond	Strand Copper	Solid Copper	Qty
 221-2401	2	18-12 AWG Strip Length =0.43in	20-12 AWG Strip Length =0.43in	50
 221-412	2	24-12 AWG Strip Length =0.43in	24-12 AWG Strip Length =0.43in	50
 221-413	3	24-12 AWG Strip Length =0.43in	24-12 AWG Strip Length =0.43in	25
 221-415	5	24-12 AWG Strip Length =0.43in	24-12 AWG Strip Length =0.43in	30

Wall Nuts & Lever Nuts Assortment (Z02)

IBS No. 199R • 13 Items • 106 Pcs

Packaged in a locking steel drawer for easy storage and organization

- Includes crimp tool •

















IBS, Inc.

SPECIALTY PRODUCTS FOR MAINTENANCE & REPAIR
INDUSTRIALBOLT.COM • 800-678-1906

Wall Nuts & Lever Nuts

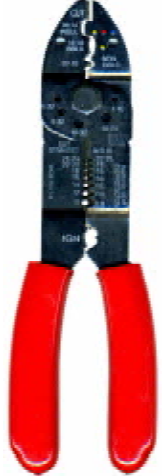
Assortment No. 199R				
<p>773-162 2 WIRE WALL NUT</p> 	<p>773-164 4 WIRE WALL NUT</p> 	<p>773-166 6 WIRE WALL NUT</p> 	<p>773-168 8 WIRE WALL NUT</p> 	<p>773-173 3 WIRE WALL NUT</p> 
<p>222-412 2 WIRE LEVER NUT</p> 	<p>222-413 3 WIRE LEVER NUT</p> 	<p>222-415 5 WIRE LEVER NUT</p> 		
<p>221-2401 INLINE SPLICE CLEAR LEVER NUT</p> 	<p>221-412 2 WIRE CLEAR LEVER NUT</p> 	<p>221-413 3 WIRE CLEAR LEVER NUT</p> 	<p>221-415 5 WIRE CLEAR LEVER NUT</p> 	
				<p>TH450 AUTO WIRE CRIMPER/STRIPPER</p> 



IBS, INCORPORATED

Quick Connectors Q3E

Wire Nuts

- Color coded and flame retardant.
- Accepts solid and stranded wire with copper to copper connections.
- Cone shaped spring helps pull the wires into the connector.
- Pre-twisting of wires not required.
- CSA certified and UL listed.

	IBS No.	Color	Wire Combination Range	Voltage Rating	PKG
	6x682	Gray	22 to 14 AWG Min 2 #22 Max 1 #16 w/1 #18	300V	100
	6x683	Blue	22 to 14 AWG Min 2 #22 Max 3 #16	300V	100
	6x684	Orange	22 to 14 AWG Min 2 #18 & 1 #20 Max 2 #14	600V	100
	6x685	Yellow	18 to 12 AWG Min 2 #18 Max 4 #14 & 1 #12	600V	100
	6x686	Red	18 to 6 AWG Min 2 #18 Max 2 #14 & 4 #18	600V	50
	6x687	Yellow Winged	18 to 12 AWG Min 2 #14 Max 4 #14 & 1 #18	600V	50
	6x688	Red Winged	18 to 6 AWG Min 2 #14 Max 4 #12	600V	50
	6x689	Gray	18 to 8 AWG Min 3 #14 w/1 #18 Max 3 #10	600V	25
	6x690	Blue	14 to 6 AWG Min 2 #10 w/1#12 Max 1#8 w/3 #10	600V	25
	6x691	Gold	22 to 8 AWG Min 3 #22 Max 4 #12	600V	50
	6x692	Green	14 to 10 AWG Min 2 #14 Max 5 #10	1000V	50

Instant Auto Connectors

- Electrically connects (tap) wire ends to through (run) wires and insulates the connection.
- No special tools needed — standard pliers easily make the connection.
- No wire stripping, twisting, or soldering necessary.



IBS No.	Color	Wire	Type	Splices	Qty
801	Blue	18-14	Gen. Purp.	tap, inline pigtail	25
902	Brown	18-14	Gen Purp		25
903	Yellow	12-10	Hvy Duty		25
905	Red	22-18	Low Volt		25

Self-Stripping Disconnects

- Easily makes midspan connections without stripping insulation.
- Disconnectable tap leg simplifies hook-up, enhances flexibility.
- Will mate with most .250" male blades.
- Self-stripping connector speeds installation, reduces possible conductor damage and eliminates time consuming mid-span tap.
- Provides a circuit test point.
- Fully insulated feature eliminates second step insulating and improves circuit isolation.
- Installs with pliers — no special tools required.

	IBS No.	Wire	Qty
	952F-250-32-NL	18-14	50
	953F-250-32-NL	12	50

Self-Stripping Pigtail Connector

- Sealant filled to protect against corrosion.
- Installs with pliers - no special tools required.
- One size covers 4 wire ranges 22-14.
- Flame retardant - safe at normal engine temperatures.
- Clear plastic case allows visual inspection.
- Use in a variety of marine and auto applications.

	IBS No.	Wire	Qty
	3M-314	Covers 4 wire ranges: 22-14	25

ELECTRICAL

IBS, INCORPORATED

Quick Connectors Q3E



Wall Nuts, Lever Nuts & Wire Nuts Assortment (Z02)

IBS No. 198R • 15 Items • 256 Pcs

Packaged in a locking steel drawer for easy storage and organization

• Includes crimp tool •





Wire Nuts

Assortment No. 198R

<p>6X682 GRAY WIRE NUTS</p> 	<p>6X683 BLUE WIRE NUT/REPLACES BLK</p> 	<p>6X684 ORANGE WIRE NUTS</p> 	<p>6X685 YELLOW WIRE NUT</p> 	<p>6X686 RED WIRE NUT</p> 	
<p>6X687 YELLOW WIRE NUT WINGED</p> 	<p>6X688 RED WIRE NUT WINGED</p> 	<p>6X689 GRAY WIRE NUT WINGED</p> 	<p>6X690 BLUE WIRE NUT WINGED</p> 	<p>6X691 TAN WIRE NUT WINGED</p> 	
<p>6X692 GREEN GROUNDING WIRE NUT WINGED</p> 					
<p>973 O/B MULTI WIRE NUT</p> 	<p>974 RED/YELLOW MULTI WIRE NUT</p> 	<p>975 BLUE / GRAY MULTI WIRE NUT</p> 			

Wire Nuts Travel Tray (Z02)



741R Wire Nuts Travel Tray

6 Items • 90 Pcs

Packaged in a clear plastic locking container

IBS No.	Description	Qty
6x683	Blue Wire Nut	20
6x684	Orange Wire Nut	20
6x685	Yellow Wire Nut	15
6x686	Red Wire Nut	15
6x687	Yellow Wire Nut - Winged	10
6x688	Red Wire Nut - Winged	10

Wall & Lever Nut Travel Tray (Z02)

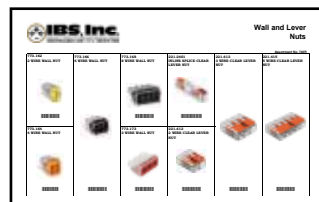

740R Wall & Lever Nut Travel Tray

9 Items • 105 Pcs

Packaged in a clear plastic locking container

IBS No.	Description	Qty
773-162	2 Wire Wall Nut	20
773-164	4 Wire Wall Nut	15
773-166	6 Wire Wall Nut	10
773-168	8 Wire Wall Nut	10
773-173	3 Wire Wall Nut	10
221-2401	Inline Splice Lever Nut	10
221-412	2 Wire Lever Nut	10
221-413	3 Wire Lever Nut	10
221-415	5 Wire Lever Nut	10

ELECTRICAL



IBS, INCORPORATED

Deutsch Connectors & Terminals Q3G

Deutsch Connectors & Terminals

Deutsch connectors and terminals are environmentally sealed electrical connectors for critical applications where moisture, salt spray, dirt or dust could potentially damage electrical connections or systems. Designed for cable to cable applications on engines, transmissions, under the hood or in the cab.

FEATURES & BENEFITS

- A single contact system terminates all connectors by utilizing common tooling and processes, creating an error-free connection.
- Copper crimp-type terminals with a stainless steel sleeve covering the fingers for protection to the fingers and increased performance and long life.
- When properly crimped, terminations provide an air-tight crimp which is highly resistant to increases of electrical resistance caused by oxidation and variations in temperature.
- Pins have no retention tangs and therefore are not subject to damage during assembly and re-work.
- Shells are made of flame-retardant, high-grade thermoplastics for maximum performance.
- No additional sealing required — connectors are sealed when snapped together making assembly time fast and easy.
- Fail-safe connector assembly designed to allow installation only after wedge locks and pins are inserted properly.
- Housings are rated -55°C to +125°C and silicone seals allow the connector to withstand extreme temperature and moisture, making them extremely versatile in a wide range of applications.
- Properly wired and mated connection will withstand immersion under three feet of water without loss of electronic qualities or leakage.
- Positive locking mechanism keeps connectors mated even in extreme vibration.

APPLICATIONS

Agriculture • Construction • Forestry
 Emergency Vehicles • Marine • Military
 Material Handling Lifts • Mining
 Off-Highway • Recreation / Racing
 Truck / Bus

Deutsch Terminals



Socket for Plug Pin for Receptacle Seal Plug

DEUTSCH TERMINALS

IBS No.	Description	Qty
125100	Deutsch 16-18 GA Socket	25
125102	Deutsch 16-18 GA Pin	25
125101	Deutsch 14-16 GA Socket	25
125103	Deutsch 14-16 GA Pin	25
125126	Deutsch Seal Plug	1

Deutsch Connector Tools



125124

125125



125127

IBS No.	Description	Qty
125124	Deutsch Removing Tool	1
125125	Deutsch Crimping Tool	1
125127	Deutsch Economy Crimping Tool	1

ELECTRICAL

IBS, INCORPORATED

Deutsch Connectors & Terminals Q3G



ELECTRICAL

Deutsch 2-Way Connectors

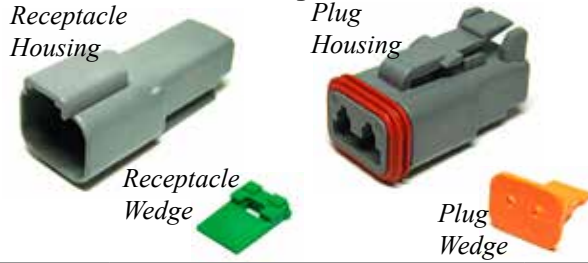

IBS No.	Description	Qty
125104	2-Way Receptacle Housing	5
125114	2-Way Receptacle Wedge	5
125105	2-Way Plug Housing	5
125115	2-Way Plug Wedge	5

Deutsch 6-Way Connectors

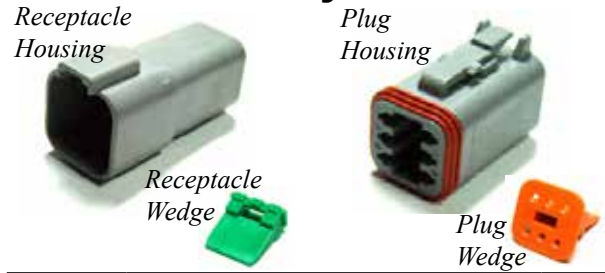

IBS No.	Description	Qty
125110	6-Way Receptacle Housing	5
125120	6-Way Receptacle Wedge	5
125111	6-Way Plug Housing	5
125121	6-Way Plug Wedge	5

Deutsch 3-Way Connectors

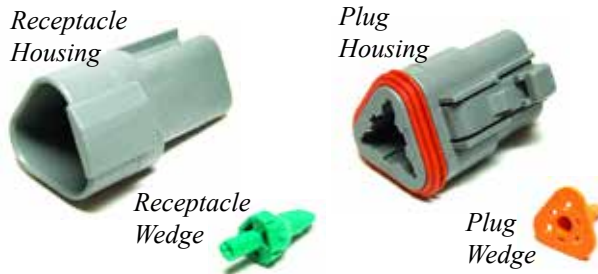

IBS No.	Description	Qty
125106	3-Way Receptacle Housing	5
125116	3-Way Receptacle Wedge	5
125107	3-Way Plug Housing	5
125117	3-Way Plug Wedge	5

Deutsch 8-Way Connectors

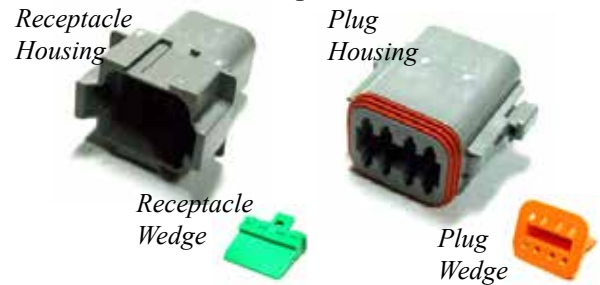

IBS No.	Description	Qty
125112	8-Way Receptacle Housing	5
125122	8-Way Receptacle Wedge	5
125113	8-Way Plug Housing	5
125123	8-Way Plug Wedge	5

Deutsch 4-Way Connectors



IBS No.	Description	Qty
125108	4-Way Receptacle Housing	5
125118	4-Way Receptacle Wedge	5
125109	4-Way Plug Housing	5
125119	4-Way Plug Wedge	5

Deutsch 12-Way Connectors

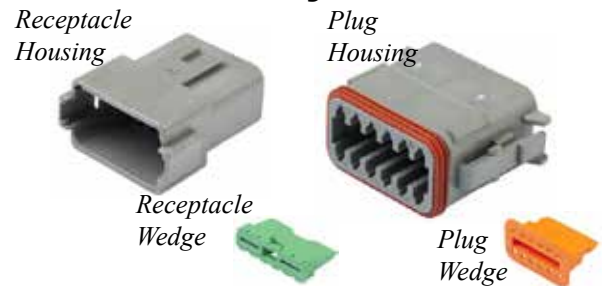

IBS No.	Description	Qty
125130	12-Way Receptacle Housing	5
125140	12-Way Receptacle Wedge	5
125131	12-Way Plug Housing	5
125141	12-Way Plug Wedge	5



IBS, INCORPORATED

DTP Deutsch Connectors

DTP Deutsch Connectors

DEUTSCH environmentally sealed electrical connectors are designed for harsh operating environments and critical applications where dirt, moisture, salt spray, and rough terrain can otherwise contaminate or damage electrical connections.

Deutsch's DTP connectors are the solution for sealed power application requirements. DTP Series connectors offer the proven reliability and quality of Deutsch's DT Series, filling the need for higher amperage. They are environmentally sealed and come in two and four pin arrangements.

The DTP Series offers designers the ability to use multiple size 12 contacts, each with a 25 amp continuous capacity, within a single shell.

FEATURES & BENEFITS

- Accepts contact size 12 (25 amps)
- 10-14 AWG
- 2 and 4 cavity arrangements
- In-line, flange, or PCB mount
- Rectangular, thermoplast housing
- Integrated latch for mating
- Wedgelocks assure contact alignment and retention

DTP 2-Way Connectors



Receptacle Housing

Receptacle Wedge

Plug Housing

Plug Wedge

IBS No.	Description	Qty
125152	2-Way Receptacle Housing DTP Series	5
125162	2way Receptacle Wedge DTP Series	5
125153	2way Plug 10-14AWG DTP Series	5
125163	2way Plug Wedge DTP Series	5

DTP 4-Way Connectors



Receptacle Housing

Receptacle Wedge

Plug Housing

Plug Wedge

IBS No.	Description	Qty
125154	4way Receptacle Housing DTP Series	5
125164	4-Way Receptacle Wedge DTP Series	5
125155	4-Way Plug Housing DTP Series	5
125165	4-Way Plug Wedge DTP Series	5

DTP TERMINALS



Socket for Plug

Pin for Receptacle

IBS No.	Description	Qty
125151	12-14GA Pin DTP Series	25
125150	12-14GA Socket DTP Series	25

DTP Deutsch Connectors & Tools Assortment

IBS No. 857R • 12 Items • 90 Pcs
Bundled with Crimping & Removal Tools
Packaged in a locking steel drawer for easy storage and organization

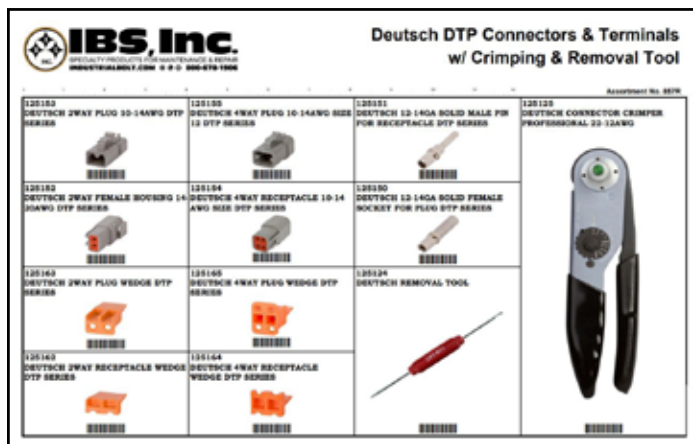

Assortment also available without tools included:

IBS No. 858R • 10 Items • 88 Pcs
Packaged in a locking steel drawer for easy storage and organization
• No tools included •

IBS, INCORPORATED

Assortments Z02



Deutsch DT Connectors & Terminals Assortment

Bundled with Crimping & Removal Tools
IBS No. 768R • 26 Items • 134 Pcs

Packaged in a locking steel drawer for easy storage & organization



IBS No. 125124
Removing Tool



IBS No. 125125
Crimping Tool

IBS Inc. DEUTSCH DT Connectors & Terminals with Crimping & Removal Tools					
Assortment No. 768R					
125104 DEUTSCH 2WAY RECEPTACLE HOUSING	125106 DEUTSCH 3WAY RECEPTACLE HOUSING	125108 DEUTSCH 4WAY RECEPTACLE HOUSING	125110 DEUTSCH 6WAY RECEPTACLE HOUSING	125112 DEUTSCH 8WAY RECEPTACLE HOUSING	125100 DEUTSCH 16-18GA SOCKET FOR PIN
125105 DEUTSCH 2WAY PLUG HOUSING	125107 DEUTSCH 3WAY PLUG HOUSING	125109 DEUTSCH 4WAY PLUG HOUSING	125111 DEUTSCH 6WAY PLUG HOUSING	125113 DEUTSCH 8WAY PLUG HOUSING	125102 DEUTSCH 16-18GA PIN FOR RECEPTACLE
125114 DEUTSCH 2WAY RECEPTACLE WEDGE	125116 DEUTSCH 3WAY RECEPTACLE WEDGE	125118 DEUTSCH 4WAY RECEPTACLE WEDGE	125120 DEUTSCH 6WAY FEMALE WEDGE	125122 DEUTSCH 8WAY FEMALE WEDGE	125101 DEUTSCH 14-16GA SOCKET FOR PLUG
125115 DEUTSCH 2WAY PLUG WEDGE	125117 DEUTSCH 3WAY PLUG WEDGE	125119 DEUTSCH 4WAY PLUG WEDGE	125121 DEUTSCH 6WAY MALE WEDGE	125123 DEUTSCH 8WAY MALE WEDGE	125103 DEUTSCH 14-16GA PIN FOR RECEPTACLE

Deutsch DT Connectors & Terminals Assortment

IBS No. 769R • 24 Items • 132 Pcs

Packaged in locking steel drawer for easy storage & organization



IBS Inc. DEUTSCH DT Connectors & Terminals					
Assortment No. 769R					
125104 DEUTSCH 2WAY RECEPTACLE HOUSING	125106 DEUTSCH 3WAY RECEPTACLE HOUSING	125108 DEUTSCH 4WAY RECEPTACLE HOUSING	125110 DEUTSCH 6WAY RECEPTACLE HOUSING	125112 DEUTSCH 8WAY RECEPTACLE HOUSING	125100 DEUTSCH 16-18GA SOCKET FOR PIN
125105 DEUTSCH 2WAY PLUG HOUSING	125107 DEUTSCH 3WAY PLUG HOUSING	125109 DEUTSCH 4WAY PLUG HOUSING	125111 DEUTSCH 6WAY PLUG HOUSING	125113 DEUTSCH 8WAY PLUG HOUSING	125102 DEUTSCH 16-18GA PIN FOR RECEPTACLE
125114 DEUTSCH 2WAY RECEPTACLE WEDGE	125116 DEUTSCH 3WAY RECEPTACLE WEDGE	125118 DEUTSCH 4WAY RECEPTACLE WEDGE	125120 DEUTSCH 6WAY FEMALE WEDGE	125122 DEUTSCH 8WAY FEMALE WEDGE	125101 DEUTSCH 14-16GA SOCKET FOR PLUG
125115 DEUTSCH 2WAY PLUG WEDGE	125117 DEUTSCH 3WAY PLUG WEDGE	125119 DEUTSCH 4WAY PLUG WEDGE	125121 DEUTSCH 6WAY MALE WEDGE	125123 DEUTSCH 8WAY MALE WEDGE	125103 DEUTSCH 14-16GA PIN FOR RECEPTACLE

Deutsch DT Connectors & Terminals Assortment II

Bundled with Crimping & Removal Tools
IBS No. 780R • 26 Items • 134 Pcs

Packaged in a locking steel drawer for easy storage & organization



IBS No. 125124
Removing Tool



IBS No. 125127
Crimping Tool

IBS Inc. DEUTSCH DT Connectors & Terminals					
Assortment No. 780R					
125104 DEUTSCH 2WAY FEMALE HOUSING	125106 DEUTSCH 3WAY FEMALE HOUSING	125108 DEUTSCH 4WAY FEMALE HOUSING	125110 DEUTSCH 6WAY FEMALE HOUSING	125112 DEUTSCH 8WAY FEMALE HOUSING	125100 DEUTSCH 16-18GA FEM TERMINAL
125105 DEUTSCH 2WAY MALE HOUSING	125107 DEUTSCH 3WAY MALE HOUSING	125109 DEUTSCH 4WAY MALE HOUSING	125111 DEUTSCH 6WAY MALE HOUSING	125113 DEUTSCH 8WAY MALE HOUSING	125102 DEUTSCH 16-18GA MALE TERMINAL
125114 DEUTSCH 2WAY FEMALE WEDGE	125116 DEUTSCH 3WAY FEMALE WEDGE	125118 DEUTSCH 4WAY FEMALE WEDGE	125120 DEUTSCH 6WAY FEMALE WEDGE	125122 DEUTSCH 8WAY FEMALE WEDGE	125101 DEUTSCH 14-16GA FEM TERMINAL
125115 DEUTSCH 2WAY MALE WEDGE	125117 DEUTSCH 3WAY MALE WEDGE	125119 DEUTSCH 4WAY MALE WEDGE	125121 DEUTSCH 6WAY MALE WEDGE	125123 DEUTSCH 8WAY MALE WEDGE	125103 DEUTSCH 14-16GA MALE TERMINAL

ELECTRICAL



IBS, INCORPORATED

Metripack Connectors & Terminals Q3G

Metripack 280 Series Connectors & Terminals

Metripack 280 Series in-line connectors feature high current and current density in a small compact design as well as excellent resistance to temperature, chemicals, and abrasion.

These may be used in under-hood automotive applications as well as most marine, appliance, agricultural and industrial control applications. Designed for 16 volts DC and 30 amps maximum. Metripack 280 Series sealed systems are ideally suited for critical, low-energy applications that require protection from environmental hazards.



Metripack Cable Seals



IBS No.	Description	Qty
125201	Metripack Green 16-20 GA Seal	50
125202	Metripack Gray 14-16 GA Seal	50
125203	Metripack Blue 12-14 GA Seal	50

Metripack 16-18 Terminals



IBS No.	Description	Qty
125212	Metripack 16-18 GA - Male	50
125215	Metripack 16-18 GA - Female	50

Metripack 12-14 Terminals



IBS No.	Description	Qty
125213	Metripack 12-14 GA - Male	50
125216	Metripack 12-14 GA - Female	50

Metripack 1 Connectors



IBS No.	Description	Qty
125204	Metripack 1 Connector - Male	5
125208	Metripack 1 Connector - Female	5
125218	Metripack 1 Contact TPA Black	10

Metripack 2 Connectors



IBS No.	Description	Qty
125205	Metripack 2 Connector - Male	5
125209	Metripack 2 Connector - Female	5
125219	Metripack 2 Contact TPA Blue	10

ELECTRICAL

IBS, INCORPORATED

Metripack Connectors & Terminals Q3G



Metripack 3 Connectors



125206



125210



125220



125221

IBS No.	Description	Qty
125206	Metripack 3 Connector - Male	5
125210	Metripack 3 Connector - Female	5
125220	Metripack 3 Contact TPA Male	5
125221	Metripack 3 Contact TPA Female	5

Metripack 5 Connectors



125207



125211



125222



125223

IBS No.	Description	Qty
125207	Metripack 5 Connector - Male	5
125211	Metripack 5 Connector - Female	5
125222	Metripack 5 Contact TPA Male	5
125223	Metripack 5 Contact TPA Female	5

Metripack Cavity Plug



125224

IBS No.	Description	Qty
125224	Metripack Cavity Plug	5

Metripack Crimping Tool



125225

IBS No.	Description	Qty
125225	Metripack Crimping Tool	1

Metripack 22-12GA Crimper



125325

IBS No.	Description	Qty
125325	Weather-Pack 22-12GA Crimper	1

Metripack Terminal Removal Tool



125226

IBS No.	Description	Qty
125226	Metripack Terminal Removal Tool	1

ELECTRICAL



IBS, INCORPORATED

Assortments Z02

Metripack 280 Series Assortment

With Crimping & Removal Tools
 IBS No. 771R • 22 Items • 432 Pieces
 Packaged in a locking steel box for easy storage & organization



IBS, Inc. SERIALITY PRODUCTS FOR MAINTENANCE & REPAIR INDUSTRIALMARKET.COM © P.O. BOX 878-1908					Metripack 280 Series Electrical Connectors & Tools	
Assortment No. 771R						
125204 METRIPACK 1 PIN MALE CONNECTOR BODY	125208 METRIPACK 1 PIN FEMALE CONNECTOR BODY	125218 METRIPACK 1 PIN T.P.A. MALE & FEMALE	125201 METRIPACK GREEN CABLE SEAL 18-16 & 20-18 GAUGE	125212 METRIPACK 16-18 GAUGE MALE TERMINAL	125225 - CRIMPING TOOL 125226 - REMOVAL TOOL	
125205 METRIPACK 2 PIN MALE CONNECTOR BODY	125209 METRIPACK 2 PIN FEMALE CONNECTOR BODY	125219 METRIPACK 2 PIN T.P.A. MALE & FEMALE	125202 METRIPACK GRAY CABLE SEAL 14-16 GAUGE	125215 METRIPACK 16-18 GAUGE FEMALE TERMINAL		
125206 METRIPACK 3 PIN MALE CONNECTOR BODY	125210 METRIPACK 3 PIN FEMALE CONNECTOR BODY	125220 & 125221 METRIPACK 3 PIN T.P.A. MALE AND FEMALE	125203 METRIPACK BLUE CABLE SEAL 12-14 GAUGE	125213 METRIPACK 12-14 GAUGE MALE TERMINAL		
125207 METRIPACK 5 PIN MALE CONNECTOR BODY	125211 METRIPACK 5 PIN FEMALE CONNECTOR BODY	125222 & 125223 METRIPACK 5 PIN T.P.A. MALE AND FEMALE	125224 METRIPACK CAVITY PLUG	125216 METRIPACK 12-14 GAUGE FEMALE TERMINAL		

Metripack 280 Series Assortment

IBS No. 770R • 20 Items • 430 Pieces
 Packaged in a locking steel box for easy storage and organization



IBS, Inc. SERIALITY PRODUCTS FOR MAINTENANCE & REPAIR INDUSTRIALMARKET.COM © P.O. BOX 878-1908					Metripack 280 Series Electrical Connectors	
Assortment No. 770R						
125204 METRIPACK 1 PIN MALE CONNECTOR BODY	125208 METRIPACK 1 PIN FEMALE CONNECTOR BODY	125218 METRIPACK 1 PIN T.P.A. MALE & FEMALE	125201 METRIPACK GREEN CABLE SEAL 18-16 & 20-18 GAUGE	125212 METRIPACK 16-18 GAUGE MALE TERMINAL		
125205 METRIPACK 2 PIN MALE CONNECTOR BODY	125209 METRIPACK 2 PIN FEMALE CONNECTOR BODY	125219 METRIPACK 2 PIN T.P.A. MALE & FEMALE	125202 METRIPACK GRAY CABLE SEAL 14-16 GAUGE	125215 METRIPACK 16-18 GAUGE FEMALE TERMINAL		
125206 METRIPACK 3 PIN MALE CONNECTOR BODY	125210 METRIPACK 3 PIN FEMALE CONNECTOR BODY	125220 & 125221 METRIPACK 3 PIN T.P.A. MALE AND FEMALE	125203 METRIPACK BLUE CABLE SEAL 12-14 GAUGE	125213 METRIPACK 12-14 GAUGE MALE TERMINAL		
125207 METRIPACK 5 PIN MALE CONNECTOR BODY	125211 METRIPACK 5 PIN FEMALE CONNECTOR BODY	125222 & 125223 METRIPACK 5 PIN T.P.A. MALE AND FEMALE	125224 METRIPACK CAVITY PLUG	125216 METRIPACK 12-14 GAUGE FEMALE TERMINAL		

Metripack 280 Series Assortment II

With Crimping & Removal Tools
 IBS No. 781R • 22 Items • 432 Pieces
 Packaged in a locking steel box for easy storage & organization



IBS, Inc. SERIALITY PRODUCTS FOR MAINTENANCE & REPAIR INDUSTRIALMARKET.COM © P.O. BOX 878-1908					Metripack 280 Series Electrical Connectors & Tools	
Assortment No. 781R						
125204 METRIPACK 1 PIN MALE CONNECTOR BODY	125208 METRIPACK 1 PIN FEMALE CONNECTOR BODY	125218 METRIPACK 1 PIN T.P.A. MALE & FEMALE	125201 METRIPACK GREEN CABLE SEAL 18-16 & 20-18 GAUGE	125212 METRIPACK 16-18 GAUGE MALE TERMINAL	125225 - CRIMPING TOOL 125226 - REMOVAL TOOL	
125205 METRIPACK 2 PIN MALE CONNECTOR BODY	125209 METRIPACK 2 PIN FEMALE CONNECTOR BODY	125219 METRIPACK 2 PIN T.P.A. MALE & FEMALE	125202 METRIPACK GRAY CABLE SEAL 14-16 GAUGE	125215 METRIPACK 16-18 GAUGE FEMALE TERMINAL		
125206 METRIPACK 3 PIN MALE CONNECTOR BODY	125210 METRIPACK 3 PIN FEMALE CONNECTOR BODY	125220 & 125221 METRIPACK 3 PIN T.P.A. MALE AND FEMALE	125203 METRIPACK BLUE CABLE SEAL 12-14 GAUGE	125213 METRIPACK 12-14 GAUGE MALE TERMINAL		
125207 METRIPACK 5 PIN MALE CONNECTOR BODY	125211 METRIPACK 5 PIN FEMALE CONNECTOR BODY	125222 & 125223 METRIPACK 5 PIN T.P.A. MALE AND FEMALE	125224 METRIPACK CAVITY PLUG	125216 METRIPACK 12-14 GAUGE FEMALE TERMINAL		

ELECTRICAL

IBS, INCORPORATED

Weatherpack Connectors & Terminals Q3G



Weatherpack Connectors & Terminals



- **An environmentally-sealed electrical connection system**, utilizing a pin-and-socket configuration – designed to withstand exposure to extreme temperatures, moisture, harsh engine compartment vapors and chemicals with outstanding reliability
- **For 12V systems – 20A maximum** - Voltage rating: 0.05 to 16.0 volts
- **Pin and sleeve configuration** to alleviate stress relaxation
- **Secondary lock and Connector Position Assurance (CPA)** for improved system design
- **Dual-locking tangs on terminals** help prevent backing out
- **Terminal plugging** requires no orientation and positive locking indexing prevents mismatching of connectors
- **Weather-Pack seals are made of a self lubricating silicone and are multi-ribbed** to prevent moisture and other contaminants from entering the connector and causing terminal corrosion.

Weatherpack Cable Seals



125201



125202



125203

IBS No.	Description	Qty
125201	Weatherpack Green 16-20 GA Seal	50
125202	Weatherpack Gray 14-16 GA Seal	50
125203	Weatherpack Blue 12-14 GA Seal	50

Weatherpack Cavity Plug



125224

IBS No.	Description	Qty
125224	Weatherpack Cavity Plug	25

Weatherpack 1 Connectors



125306



125307

IBS No.	Description	Qty
125306	Weatherpack 1 Tower Female	5
125307	Weatherpack 1 Shroud Male	5

Weatherpack 2 Connectors



125308



125309

IBS No.	Description	Qty
125308	Weatherpack 2 Tower Female	5
125309	Weatherpack 2 Shroud Male	5

ELECTRICAL



IBS, INCORPORATED

Weatherpack Connectors & Terminals Q3G

ELECTRICAL

Weatherpack 3 Connectors



IBS No.	Description	Qty
125310	Weatherpack 3 Tower Female	5
125311	Weatherpack 3 Shroud Male	5

Weatherpack 4 Connectors



IBS No.	Description	Qty
125312	Weatherpack 4 Tower Female	5
125313	Weatherpack 4 Shroud Male	5

Weatherpack 6 Connectors



IBS No.	Description	Qty
125314	Weatherpack 6 Tower Female	5
125315	Weatherpack 6 Shroud Male	5

Weatherpack 20-18 GA Terminals



IBS No.	Description	Qty
125301	Weatherpack 20-18 GA Female	50
125300	Weatherpack 20-18 GA Male	50

Weatherpack 16-14 GA Terminals



IBS No.	Description	Qty
125303	Weatherpack 16-14 GA Female	50
125302	Weatherpack 16-14 GA Male	50

Weatherpack 12 GA Terminals



IBS No.	Description	Qty
125305	Weatherpack 12 GA Female	25
125304	Weatherpack 12 GA Male	25

Weatherpack 22-12GA Crimper



IBS No.	Description	Qty
125325	Weather-Pack 22-12GA Crimper	1

Weatherpack Terminal Extractor Tool



IBS No.	Description	Qty
125326	Weather-Pack Terminal Extractor	1

IBS, INCORPORATED

Assortments Z02



Weatherpack Series Assortment

With Crimping & Removal Tools

IBS No. 773R • 22 Items • 331 Pcs

Packaged in a locking steel box for easy storage & organization





IBS, Inc.
SPECIALTY PRODUCTS FOR MAINTENANCE & REPAIR
INDUSTRIALBOLT.COM • 800-678-1906

**Weatherpack Connectors
and Terminals with Tools**

Assortment No. 773R

<p>125307 WEATHERPACK 1 CAVITY SHROUD MALE</p> 	<p>125309 WEATHERPACK 2 CAVITY SHROUD MALE</p> 	<p>125311 WEATHERPACK 3 CAVITY SHROUD MALE</p> 	<p>125313 WEATHERPACK 4 CAVITY SHROUD MALE</p> 	<p>125315 WEATHERPACK 6 CAVITY SHROUD MALE</p> 	<p>125325 WEATHERPACK 22-12GA CRIMPER</p> <p>125326 WEATHERPACK TERM EXTRACTOR TOOL</p> 
<p>125306 WEATHERPACK 1 CAVITY TOWER FEMALE</p> 	<p>125308 WEATHERPACK 2 CAVITY TOWER FEMALE</p> 	<p>125310 WEATHERPACK 3 CAVITY TOWER FEMALE</p> 	<p>125312 WEATHERPACK 4 CAVITY TOWER FEMALE</p> 	<p>125314 WEATHERPACK 6 CAVITY TOWER FEMALE</p> 	
<p>125300 WEATHERPACK 20-18GA MALE TERMINAL</p> 	<p>125302 WEATHERPACK 16-14GA MALE TERMINAL</p> 	<p>125304 WEATHERPACK 12GA MALE TERMINAL</p> 	<p>125201 METRIPACK/WEATHERPK SEALGRN 18-16/20-18GA</p> 	<p>125203 METRIPACK/WEATHERPK SEAL BLUE 14-12 GA</p> 	
<p>125301 WEATHERPACK 20-18GA FEMALE TERMINAL</p> 	<p>125303 WEATHERPACK 16-14GA FEMALE TERMINAL</p> 	<p>125305 WEATHERPACK 12GA FEMALE TERMINAL</p> 	<p>125202 METRIPACK/WEATHERPK SEAL GRAY 16-14 GAUGE</p> 	<p>125224 METRIPACK/WEATHERPK CAVITY PLUG</p> 	

Weatherpack Series Assortment

IBS No. 772R • 20 Items • 329 Pcs

Packaged in a locking steel box for easy storage & organization





IBS, Inc.
SPECIALTY PRODUCTS FOR MAINTENANCE & REPAIR
INDUSTRIALBOLT.COM • 800-678-1906

**Weatherpack Connectors
and Terminals**

Assortment No. 772R

<p>125307 WEATHERPACK 1 CAVITY SHROUD MALE</p> 	<p>125309 WEATHERPACK 2 CAVITY SHROUD MALE</p> 	<p>125311 WEATHERPACK 3 CAVITY SHROUD MALE</p> 	<p>125313 WEATHERPACK 4 CAVITY SHROUD MALE</p> 	<p>125315 WEATHERPACK 6 CAVITY SHROUD MALE</p> 	
<p>125306 WEATHERPACK 1 CAVITY TOWER FEMALE</p> 	<p>125308 WEATHERPACK 2 CAVITY TOWER FEMALE</p> 	<p>125310 WEATHERPACK 3 CAVITY TOWER FEMALE</p> 	<p>125312 WEATHERPACK 4 CAVITY TOWER FEMALE</p> 	<p>125314 WEATHERPACK 6 CAVITY TOWER FEMALE</p> 	
<p>125300 WEATHERPACK 20-18GA MALE TERMINAL</p> 	<p>125302 WEATHERPACK 16-14GA MALE TERMINAL</p> 	<p>125304 WEATHERPACK 12GA MALE TERMINAL</p> 	<p>125201 METRIPACK AND WEATHERPACK SEAL</p> 	<p>125203 METRIPACK AND WEATHERPACK SEAL</p> 	
<p>125301 WEATHERPACK 20-18GA FEMALE TERMINAL</p> 	<p>125303 WEATHERPACK 16-14GA FEMALE TERMINAL</p> 	<p>125305 WEATHERPACK 12GA FEMALE TERMINAL</p> 	<p>125202 METRIPACK WEATHERPACK SEAL</p> 	<p>125224 METRIPACK & WEATHERPACK CAVITY PLUG</p> 	



IBS, INCORPORATED

Tapes & Sealants Q1D

E
L
E
C
T
R
I
C
A
L

Scotch® Brand 88 Electrical Tape

88 Vinyl Plastic Electrical Tape
for Cold Weather Resistance

- Extra thickness provides added electrical properties, quicker installation buildup and abrasion resistance.
- Flame retardant.
- Hot and cold weather resistant.
- Resists UV rays, abrasion, moisture, alkalis acids and corrosion.
- Meets requirements of ASTMD-3005 Type I, UL510, MIL-I-24391 and CSA C22.2.
- Temperature Range: -18°C/0°F to +105°C/220°F.



IBS No.	MIL Thick	Color	Length	Qty
3M6143	8.5	Black	3/4" x 66'	1

Scotch Brand 33+ Electrical Tape

33+ Vinyl Plastic Professional Grade
Electrical Tape

- Use as a primary insulation for wire cable splices up to 600 volts and for fixture and wire splices up to 1kV.
- Flame retardant.
- Hot and cold weather resistant.
- Resists UV rays, abrasion, moisture, alkalis acids and corrosion.
- Meets requirements of ASTMD-3005 Type I, UL510, HHI-595C and CSA C22.2.
- Temperature Range: -18°C/0°F to +105°C/220°F.



IBS No.	MIL Thick	Color	Length	Qty
3M6133	7.0	Black	3/4" x 76'	1

Super Black Vinyl Electrical Tape

Vinyl Plastic Electrical Tape
for Cold Weather Resistance
3M SUPER 88 EQUIVALENT

- 8.5 mil (0.21mm) all weather, professional grade, pressure sensitive vinyl tape that provides heavier thickness for added mechanical & electrical protection.
- Flame retardant.
- Cold and weather resistant.
- Can be used for splices at not more than 600 Volts.
- Resists UV rays, abrasion, moisture, alkalis acids and corrosion.
- Meets requirements of ASTMD-3005 Type I, UL510, and MIL-I-24391.



IBS No.	MIL Thick	Color	Length	Qty
6143	8.5	Black	3/4" x 66'	1

Premium+ Black Vinyl Electrical Tape

7.0 MM Vinyl Plastic Professional Grade
Electrical Tape

3M 33+ EQUIVALENT

- Use as a primary insulation for wire cable splices up to 600 volts and for fixture and wire splices up to 1kV.
- Flame retardant.
- Hot and cold weather resistant.
- Resists UV rays, abrasion, moisture, alkalis acids and corrosion.
- Meets requirements of ASTMD-3005 Type I, UL510, HHI-595C and CSA C22.2.
- Temperature Range: -18°C/0°F to +105°C/220°F.



IBS No.	MIL Thick	Color	Length	Qty
6132	7	Black	3/4" x 66'	1

IBS, INCORPORATED

Tapes & Sealants Q1D



Colored Electrical Tape

Just like our standard electrical tape, this PVC electrical tape has excellent elongation and creep back characteristics for tighter, more permanent wraps. No adhesion transfer assures consistent sealing. Suitable for use up to 600 Volts and a maximum temperature of 176°F (80°C).

Each roll measures 3/4" x 60 ft.



IBS No.	Color	Length	Qty
N9010	Black	3/4" x 60'	10
145237	Blue	3/4" x 60'	5
145238	Green	3/4" x 60'	5
145239	White	3/4" x 60'	5
145240	Brown	3/4" x 60'	5
145241	Orange	3/4" x 60'	5
145242	Yellow	3/4" x 60'	5
145243	Gray	3/4" x 60'	5
145244	Red	3/4" x 60'	5

Black Liquid Electrical Tape

This product has thousands of uses in a variety of environments. Anytime electrical wires are exposed, this product is the perfect solution. Liquid electrical tape provides a totally sealed joint which is flexible and fire resistant. UV, water and most chemicals will not affect a joint sealed with Liquid Electrical Tape. Dries to the touch in about 10 minutes and fully cures in 24 hours.

- Forms a protective, waterproof, UV-resistant dielectric coating.
- Prevents corrosion on wires and terminals.
- Patented, UL tested, fast-drying formula.



IBS No.	Description	Qty
105124	Black Liquid Electrical Tape 4 oz.	1

Electrical Tape Assortment

IBS No. 711R • 11 Items • 20 Pcs

Packaged in a locking steel drawer for easy storage and organization



Electrical Tape

Assortment No. 711R

<p>145237 3/4 X 60FT BLUE ELECTRICAL TAPE</p>	<p>145238 3/4 X 60FT GREEN ELECTRICAL TAPE</p>	<p>145239 3/4 X 60FT WHITE ELECTRICAL TAPE</p>	<p>B9211 1' X 30' FUSION TAPE</p>
<p>145240 3/4 X 60FT BROWN ELECTRICAL TAPE</p>	<p>145241 3/4 X 60FT ORANGE ELECTRICAL TAPE</p>	<p>145242 3/4 X 60FT YELLOW ELECTRICAL TAPE</p>	<p>B9201 SILICONE TAPE - RED</p>
<p>145243 3/4 X 60FT GRAY ELECTRICAL TAPE</p>	<p>145244 3/4 X 60FT RED ELECTRICAL TAPE</p>	<p>N9010 3/4 X 60YD PVC ELECTRICAL</p>	

ELECTRICAL



IBS, INCORPORATED

Assortments (Z02)

Silicone Sealing Tape

Self-fusing tape cures without heat to form a solid rubber insulator. It has a minimum dielectric strength of 400 volts/mil. (.020" thick). It has a continuous operating temperature range from -60° to +200°C with intermittent up to +260°C. It has a minimum tensile strength of 700 psi and a tear resistance of 85 psi. It also has a 300% minimum ultimate elongation. It replaces shrink tape and can be used where shrink tubing would be impractical. Its ease of application and removability make it a versatile choice for insulating and weather-proofing.



IBS No.	Color	Width	Length	Qty
B9201	Red	1"	36 ft.	1
B9202	Black	1"	36 ft.	1
B9204	Gray	1"	36 ft.	1
B9205	Clear	1"	36 ft.	1
B9206	Red	2"	10 ft.	1
B9207	Black	2"	10 ft.	1
B9208	Gray	2"	10 ft.	1
B9209	Clear	2"	10 ft.	1

Fusion Tape

Fusion Tape is used by everyone from OEM manufacturers to contractors in most any industry; automotive, heavy duty, marine, utilities, and plant maintenance.



Seals pipes, hoses and wires as it insulates and bundles.

Fusion Tape is:

- A positive sealing cold shrink tape — requires no heat, which means no special tools are needed, and can be used to replace shrink tube.
- Temperature range is -40°F to 100°F continuous and 130°F intermittent — for all weather use.
- Has no sticky sides, and adheres only to itself — which makes it much easier to use than some shrink tubing.
- Withstands harsh cleaning chemicals and steam — for longer life.
- Has a 5 year shelf life — so you don't have to be concerned with it going bad prior to use.
- Cures to a tight, yet flexible waterproof bond — the benefit is that even where the seal is being flexed, the bond will hold.
- Begins to fuse in minutes, cures in a few hours and continues to constrict for 24 hours.
- Has a liner, a true fusing tape that won't start working until stretched.

IBS No.	Description	Qty
B9211	Fusion Tape 1" x 30'	1

Silicone Sealing Tape Assortment

IBS No. 743R • 8 Items • 8 Pcs

Packaged in a locking steel drawer for easy storage and organization

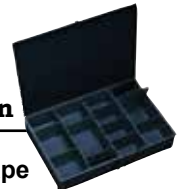

Silicone Sealing Tape

Assortment No. 743R

<p style="font-size: x-small;">B9201 TAPE SILICONE RED 1" X 36'</p>	<p style="font-size: x-small;">B9202 TAPE SILICONE BLACK 1" X 36'</p>	<p style="font-size: x-small;">B9204 TAPE SILICONE GRAY 1" X 36'</p>	<p style="font-size: x-small;">B9205 TAPE SILICONE CLEAR 1" X 36'</p>
<p style="font-size: x-small;">B9206 TAPE SILICONE RED 2" X 10'</p>	<p style="font-size: x-small;">B9207 TAPE SILICONE BLACK 2" X 10'</p>	<p style="font-size: x-small;">B9208 TAPE SILICONE GRAY 2" X 10'</p>	<p style="font-size: x-small;">B9209 TAPE SILICONE CLEAR 2" X 10'</p>

Sealing Compound

Consisting of a tough, all-weather grade elastic vinyl backing and a self-fusing, rubber-based insulating mastic, this sealing compound is designed to withstand bleach, water, steam, saltwater spray, oils, chemicals, hydraulic fluid, liquid detergent, JP-4, horse urine, and many more.

- Applies & seals quickly and easily.
- Rugged PVC backing resists abrasion, wear and tear.
- Can be applied from 0° to 100°F.
- Rated at 176°F continuous operation.
- Resists ultraviolet (sun) light.
- Is compatible with all thermoplastic and rubber wire insulation.
- Provides strain relief by taking pressure off connectors.
- Protects against vibration "shake-loose."
- Seals and insulates most connections: bolted, crimped or screw-type connectors, terminals, and self-stripping connectors.
- Seals and protects in all automotive applications including livestock carriers.



IBS No.	Description	Qty
6147	Roll 2-1/2" x 10 ft.	1
6149	Pre-Cut Patches 2-1/2 sq (25)	1

Teflon Tape

- Teflon thread sealing tape
- Chemically inert, withstands alkalis, acids, oils and solvents.
- Can be used on iron, stainless steel, copper, brass, plastic, glass or rubber pipes.



IBS No.	Description	Qty
UT-11	Teflon Tape 1/2" x 520"	1

Blue Painter's Tape

- Ideal for long term masking projects when tape must be left on for up to a week or more.
- Removes cleanly and easily for up to 14 days without leaving adhesive residue.
- Can also be used on most previously painted surfaces, including painted wallboard and even glass and metal.
- UV Resistant; can be used in direct sunlight.
- Adhesion level: medium.
- Compatible with water-based, and solvent based coatings; not compatible with lacquer coatings or surfaces.
- Can be used on interior or exterior jobs.



IBS No.	Length	Qty
145333	1" x 60 yd	1
145335	2" x 60 yd	1

Masking Tape

- An all-purpose, standard grade masking tape with excellent properties for most applications.
- Protects surfaces from unwanted paint.
- Easily peeled.
- Light bundling.



IBS No.	Description	Qty
UT77-1	Masking Tape 1" x 60 yds.	1
UT77-2	Masking Tape 2" x 60 yds.	1

Duct Tape

- Contractors Grip — 11.0mm thick.
- Multi-purpose, polyethylene coated cloth, waterproof tape.
- Seals against loss of heated and cooled air.
- Conforms to irregular surfaces.



IBS No.	Description	Qty
UT-102	Duct Tape 2" x 60 yds (2160 in.)	1



IBS, INCORPORATED

Cross-Link Wire Q06

Heavy Duty Wire (Cross-Linked) — 100 Ft Spools

This general purpose wire is used where superior resistance to the elements, abrasion, and where extremes in temperature, both high and low, are encountered. Heavy duty cross-linked wire has a flexible, bare annealed copper conductor which is insulated with a special polyethylene base. Chemically cross-linked polyethylene is a compound which is vulcanized to obtain a thermoplastic wire insulation. A thermosetting insulation doesn't melt when exposed to heat after the vulcanization process. Our chemically cross-linked polyethylene features toughness combined with outstanding heat resistance. Meets SAEJ1128.

Voltage: Rated at **60VDC/25VAC** or less. Temperature: Rated at **-40°F (-40°C)** to **257°F (125°C)**.

ELECTRICAL

	Color	22 GA	20 GA	18 GA	16 GA	14 GA	12 GA	10 GA
	BLACK	82301	82201	82183	82163	82141	82121	81103
	WHITE	82307	82207	82187	82167	82142	82122	81107
	RED	82303	82203	82181	82161	82143	82123	81101
	YELLOW	82302	82202	82182	82162	82144	82124	81102
	GREEN	82304	82204	82184	82164	82145	82125	81104
	BLUE	82305	82205	82185	82165	82146	82126	81105
	BROWN	82306	82206	82186	82166	82147	82127	81106
	ORANGE			82188	82168	82148		
	PURPLE					82149		

Wire Sold by Spools in Quantities of One

Heavy Duty (Cross-Linked) Primary Wire Assortments (Z08)

4 Bar Wire Rack Assortment

IBS No. 341R • 16 (100 ft) spools



	Color	14 GA	12 GA	10 GA
	BLACK	82141 Qty: 1	82121 Qty: 1	81103 Qty: 1
	WHITE	82142 Qty: 1	82122 Qty: 1	
	RED	82143 Qty: 1	82123 Qty: 1	81101 Qty: 1
	YELLOW	82144 Qty: 1		
	GREEN	82145 Qty: 1	82125 Qty: 1	
	BLUE	82146 Qty: 1	82126 Qty: 1	
	BROWN	82147 Qty: 1	82127 Qty: 1	
	PURPLE	82149 Qty: 1		

Arranged on a 4 bar wire rack - separates wire by ga

2 Bar Wire Rack Assortment (Z02)

IBS No. 860R • 11 (100 ft) spools



	Color	14 GA	12 GA	10 GA
	BLACK	82141 Qty: 1	82121 Qty: 1	81103 Qty: 1
	WHITE	82142 Qty: 1		
	RED	82143 Qty: 1	82123 Qty: 1	81101 Qty: 1
	YELLOW	82144 Qty: 1		
	GREEN	82145 Qty: 1		
	BLUE	82146 Qty: 1		
	BROWN	82147 Qty: 1		

Arranged on a 2 bar wire rack - separates wire by ga

IBS, INCORPORATED

Primary Wire Q05



General Purpose Thermoplastic — 100 Ft. Spools

Single conductor copper stranded primary wire with the highest quality poly-vinyl chloride insulation providing the best in flexibility, permanent color and resistance to acids, grease oil and diesel fumes. Primary wire is manufactured to meet all SAE type GPT specifications and will work safely between the operating temperatures of -20°F and +165°F.

Voltage: Rated at 60V or less. Temperature: Rated at -40°F (-40°C) to 176°F (80°C).

	Color	20 GA	18 GA	16 GA	14 GA	12 GA	10 GA	8 GA
	BLACK	81203S	81183S	81163S	81143S	81123S	81103S	81083A
	WHITE	81207S	81187S	81167S	81147S	81127S	81107S	
	RED	81201S	81181S	81161S	81141S	81121S	81101S	81081A
	YELLOW	81202S	81182S	81162S	81142S	81122S	81102S	
	GREEN	81204S	81184S	81164S	81144S	81124S	81104S	
	BLUE	81205S	81185S	81165S	81145S	81125S	81105S	
	BROWN	81206S	81186S	81166S	81146S	81126S	81106S	
	ORANGE		81188S	81168S	81148S			
	PURPLE		81189S	81169S	81149S			

Primary Wire Sold by Spools in Quantities of One

General Purpose Primary Wire Assortments (Z08)

4 Bar Wire Rack Assortment

IBS No. 134R • 16 (100 ft) spools



	Color	16 GA	14 GA	12 GA	10 GA
	BLACK	81163S Qty: 1	81143S Qty: 1	81123S Qty: 1	81103S Qty: 1
	WHITE		81147S Qty: 1	81127S Qty: 1	
	RED	81161S Qty: 1	81141S Qty: 1	81121S Qty: 1	81101S Qty: 1
	GREEN		81144S Qty: 1	81124S Qty: 1	
	BLUE		81145S Qty: 1	81125S Qty: 1	
	BROWN		81146S Qty: 1	81126S Qty: 1	

Arranged on a 4 bar wire rack - separates wire by ga

2 Bar Wire Rack Assortment (Z02)

IBS No. 302R • 11 (100 ft) spools



	Color	14 GA	12 GA	10 GA
	BLACK	81143S Qty: 1	81123S Qty: 1	81103S Qty: 1
	WHITE	81147S Qty: 1		
	RED	81141S Qty: 1	81121S Qty: 1	81101S Qty: 1
	YELLOW	81142S Qty: 1		
	GREEN	81144S Qty: 1		
	BLUE	81145S Qty: 1		
	BROWN	81146S Qty: 1		

Arranged on a 2 bar wire rack - separates wire by ga

ELECTRICAL



IBS, INCORPORATED

Conducting Wire & Cable Q07

E
L
E
C
T
R
I
C
A
L

Trailer Cable

This general purpose, thermoplastic wire has the same wire construction as the parallel multiple conductor and has an overall grey colored, tough Typhayzel® jacket for additional protection against moisture and abrasion. The conductor is made up of 2 - 14GA wires. Colors are white and black.



MULTIPLE CONDUCTOR

IBS No.	GA	Description	Qty
8150S	12/6	Black, Red, Brown, Yellow Green & Blue - 100 ft spool	1
	10/1	White	
8157S	14/7	Red, Green, Brown, White, Black, Yellow, Blue 100 ft spool	1
8152S	14/4	Black, White, Red, Brown 100 ft spool	1
8151S	14/6	Red, Green, Brown, White, Black & Yellow - 100 ft spool	1
8155S	16/6	Red, Green, Brown, White, Black & Yellow - 100 ft spool	1

Jacketed Multiple Conductor

This general purpose, thermoplastic wire has the same wire construction as the parallel multiple conductor and has an overall grey colored, tough Typhayzel® jacket for additional protection against moisture and abrasion. The conductor is made up of 2 - 14GA wires. Colors are white and black.



IBS No.	GA	Description	Qty
8131S	12/2	Black & White 100 ft spool	1
8132S	14/2	Black & White 100 ft spool	1
8133S	16/2	Black & White 100 ft spool	1
8134S	18/2	Black & White 100 ft spool	1

Parallel Multiple Conductor

This general purpose, thermoplastic wire meets the same conditions as primary wire. The conductors are bonded together to simplify circuit identification and termination. This allows for faster, more convenient installation where two or more conductors are required. It is made up of 3 - 14GA conductors. Colors are yellow, green and brown.

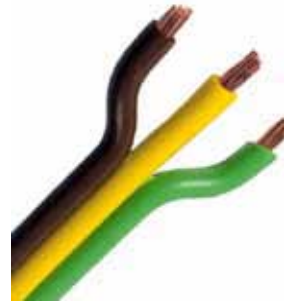

IBS No.	GA	Description	Qty
8140S	14/3	Yellow, Green & Brown - 100 ft spool	1

Clear Speaker Wire

Teledyne AWD speaker wire has a flat, parallel, flexible construction, SPT style, for easy split separation. The two copper conductors, one bar and one tinned, are protected with transparent, extruded, thermoplastic jacket which provides visible wire identification and positive polarity.



IBS No.	GA	Description	Qty
81000	18/2	100 ft spool	1

IBS Battery / Welding Cable

Type TPR (FT1) Rubber Polymer

6 AWG - 4/0 AWG • 600 Volts • -49°C to 105°C

Features

- Remains flexible even at - 49°C
- Extra flexible class K stranding
- - 49°C to 105°C, 600 Volt rating
- Jacketing compound passes UL WV1 Flame Test
- Resistant to oil, water, acid, gas, ozone, cuts, tears, and abrasion
- Made in the U.S.A.

Applications

Designed for heavy duty welding applications where extreme cold weather flexibility and resistance to cuts, tears, abrasion and welding sledge is required.



Construction

Conductor

- Bare, annealed electrolyte copper
- 30 AWG Class K rope lay stranding

Dual Insulated Jacketing Technology



An inner insulator of the same high quality compound in high contrast color is applied between the conductor and outer sheath for added safety. This provides: increased insulation, added flexibility, and allows the user to easily identify damage or wear.

Additionally, this eliminates corrosion inherent to paper separators found in cables of lesser quality, which extends the product's life and improves performance.

Outer Jacket

A proprietary rubber polymer (FT1) provides exceptional oil, water, acid, gas and ozone resistance.



- Is flame retardant.
- MSHA low smoke compliant.
- Durable, and extremely flexible at all operating temperatures.

IBS No.	Cable GA	Color	Stranding	AMP Rating	Terminal Color	Length	Qty
16498	6 GA	Black	266 x 30	80	Gray	25'	1
16499	6 GA	Red	266 x 30	80	Gray	25'	1
16500	4 GA	Black	420 x 30	120	Gray	25'	1
165001	4 GA	Red	420 x 30	120	Gray	25'	1
16501	2 GA	Black	665 x 30	240	Green	25'	1
165011	2 GA	Red	665 x 30	240	Green	25'	1
16502	1 GA	Black	833 x 30	300	Pink	25'	1
165022	1 GA	Red	833 x 30	300	Pink	25'	1
16503	1/0 GA	Black	1045 x 30	360	Black	25'	1
165033	1/0 GA	Red	1045 x 30	360	Black	25'	1
16504	2/0 GA	Black	1330 x 30	450	Orange	25'	1
165044	2/0 GA	Red	1330 x 30	450	Orange	25'	1
16506	3/0 GA	Black	1691 x 30	540	Purple	10'	1
165066	3/0 GA	Red	1691 x 30	540	Purple	10'	1
16508	4/0 GA	Black	2109 x 30	640	Yellow	10'	1
165088	4/0 GA	Red	2109 x 30	640	Yellow	10'	1



IBS, INCORPORATED

Shrink Tubing Q2A

6 to 1 Hi-Ratio Heat Shrink Tubing

- **Extremely versatile 6:1 shrink ratio** can accommodate a wide variety of connector shapes and configurations.
- **Rigid heavy wall and thermoplastic adhesive lining** provides a gas, water, and environmental seal for the toughest applications.
- **Dielectric strength** of 500 volts/mil.
- **Tough and durable** to provide exceptional insulation and abrasion protection.
- **Flame retardant material** meets MIL-I-23053/15A Specs.



IBS No.	Pre-Shrunk ID	Post-Shrunk ID	Wire Range	MAX Wall Thickness	Length	Color	Qty
B3315	3/4	.125	14 - 1 GA	.123	12"	Black	1
B3317	1-3/4	.29	2 - 750 MCM	.140	12"	Black	1
B3319	2-3/4	.46	3/0 - 1200 MCM	.190	12"	Black	1
B3320	3-1/2	.673	500 - 1300 MCM	.170	12"	Black	1

Heavy Wall Heat Shrink Tubing

- Heavy wall polyolefin material assures superior abrasion protection and strain relief.
- Mastic-lined inner wall forms a weatherproof seal when heated to prevent failure due to corrosion and vibration.
- 3 to 1 shrink ratio means fewer part numbers to cover a variety of cable sizes resulting in less inventory.

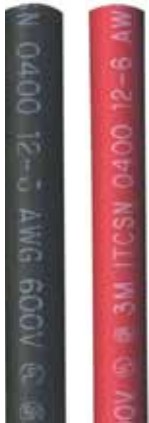

IBS No.	Pre-Shrunk ID	Post-Shrunk ID	Wire Size	Color	Length	MAX Wall	Qty
B3501	.40	.150	12-6	Black	6"	.09	5
B3502	.40	.150	12-6	Red	6"	.09	5
B3503	.80	.20	8-1/0	Black	6"	.11	5
B3404	.80	.20	8-1/0	Red	6"	.11	5
B3505	1.10	.37	2-4/0	Black	6"	.12	5
B3405	1.10	.37	2-4/0	Red	6"	.12	5
B3605	1.5	.50	4/0-400	Black	12"	.17	1
B3601	2.0	.65	500-1000 MCM	Black	12"	.17	1
B3620	.80	.20	8-1	Black	48"	.11	1
B3630	1.10	.37	2-4/0	Black	48"	.12	1

Heavy Wall Heat Shrink Tubing Assortment II (Z08)

IBS No. 295P • 12 Items • 86 Pcs

Packaged in a locking steel drawer for easy storage and organization



IBS, Inc. INDUSTRIAL QUALITY • P.O. BOX 870-1308		Heavy Wall Shrink Tubing II	
Assortment No. 295P			
B3505 2-4/0GA X 6" BLACK HVY		B3405 2-4/0GA X 6" RED HVY WALL	
B3503 8-1/0GA X 6" BLACK HEAVY SHRINK TUBE		B3404 8-1/0 GA X 6" RED HEAVY SHRINK TUBE	
B3501 12-6GA X 6" BLACK HVY SHRINK		B3502 12-6GA X 6" RED HVY SHRINK	
B3508 8-2GA X 6" CLEAR SHRINK TUBE		B282 12-10 SOLDER&SEAL SHRINK TUBE	
B3507 14-8GA X 6" CLEAR SHRINK TUBE		B281 16-14 SOLDER&SEAL SHRINK TUBE	
B3506 18-12GA X 6" CLEAR SHRINK		B280 22-18 SOLDER&SEAL SHRINK TUBE	

IBS, INCORPORATED

Shrink Tubing Q2A



Automotive Dual Wall Heat Shrink Tubing

This polyolefin tubing can be used for sealing splices and terminals. In addition to weather-proofing your connection, it also provides strain relief and vibration resistance. An excellent alternative to heavy wall tubing in light duty applications. Ideal for automotive computer wiring and applications where vibration, moisture, or friction are present and may cause failure.

- **Double Wall Construction** creates a strong, durable connection that insulates to reduce failure due to vibration.
- **Heavy Duty** polyolefin material resists wear and assures superior abrasion protection and strain relief.
- **Inner wall** is lined with mastic that breaks down when heated to form a weatherproof seal against moisture, eliminating failure due to corrosion.

DUAL WALL SHRINK TUBING — CLEAR

IBS No.	Pre-Shrunk ID	Post-Shrunk ID	Wire Size	MAX Wall	Color	Length	Qty
B3506	1/4	.08	18-10	.040	Clear	6"	10
B3507	3/8	.12	14-8	.055	Clear	6"	10
B3508	1/2	.16	8-4	.070	Clear	6"	10
B3300	1/8	.04	30-18	.040	Clear	12"	10
B3301	3/16	.062	20-14	.040	Clear	12"	10
B3302	1/4	.08	18-10	.040	Clear	12"	10

- **Clear Outer Wall** allows for visual inspection before and after installation for fewer mistakes and less rework.

DUAL WALL SHRINK TUBING — BLACK & RED

IBS No. Red	IBS No. Black	Pre-Shrunk ID	Post-Shrunk ID	Wire Size	MAX Wall	Length	Qty
16480	16485	1/8	.040	30-18	.040	6"	8
16481	16486	3/16	.062	20-14	.040	6"	8
16482	16487	1/4	.080	18-10	.040	6"	8
16483	16488	3/8	.120	14-8	.055	6"	8
16484	16489	1/2	.160	8-4	.070	6"	8
16492	16490	3/4	.250	4-2/0	.085	6"	8
16493	16491	1	.320	2-4/0	.100	6"	8

Automotive Dual Wall Heat Shrink Tubing Assortment

IBS No. 800R • 12 Items • 72 Pcs

Packaged in a locking steel drawer for easy storage and organization



Dual Wall Shrink Tubing

Assortment No. 800R

<p style="font-size: x-small;">16486 3/16 X 6IN BLACK DUAL WALL SHRINK TUBE</p>	<p style="font-size: x-small;">16481 3/16 X 6IN RED DUAL WALL SHRINK TUBE</p>
<p style="font-size: x-small;">16487 1/4 X 6IN BLACK DUAL WALL SHRINK TUBE</p>	<p style="font-size: x-small;">16482 1/4 X 6IN RED DUAL WALL SHRINK TUBE</p>
<p style="font-size: x-small;">16488 3/8 X 6IN BLACK DUAL WALL SHRINK TUBE</p>	<p style="font-size: x-small;">16483 3/8 X 6IN RED DUAL WALL SHRINK TUBE</p>
<p style="font-size: x-small;">16489 1/2 X 6IN BLACK DUAL WALL SHRINK TUBE</p>	<p style="font-size: x-small;">16484 1/2 X 6IN RED DUAL WALL SHRINK TUBE</p>
<p style="font-size: x-small;">16490 3/4 X 6IN BLACK DUAL WALL SHRINK TUBE</p>	<p style="font-size: x-small;">16492 3/4 X 6IN RED DUAL WALL SHRINK TUBE</p>
<p style="font-size: x-small;">16491 1IN X 6IN BLACK DUAL WALL SHRINK TUBE</p>	<p style="font-size: x-small;">16493 1IN X 6IN RED DUAL WALL SHRINK TUBE</p>



IBS, INCORPORATED

Shrink Tubing Q2A

High Adhesive Flow Heat Shrink Tubing

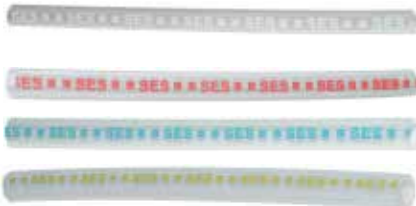

- Excellent for sealing multiple wires.
- Puncture resistant
- Provides superior strain relief.
- Clear with color coded lines

IBS No.	Pre-Shrunk ID	Post-Shrunk ID	Wire Size	MAX Wall	Color	Length	Qty
B3310	.220	.045	24-12	.057	White Dash	12"	5
B3311	.300	.060	22-10	.061	Red Dash	12"	5
B3312	.350	.080	16-8	.071	Blue Dash	12"	5
B3313	.450	.105	14-4	.096	Yellow Dash	12"	5

Heavy Wall Heat Shrink Tubing Assortment (Z02)

IBS No. 338R • 6 Items • 30 Pcs

Packaged in a locking steel drawer for easy storage and organization











IBS, Inc.
SPECIALTY PRODUCTS FOR MAINTENANCE & REPAIR
INDUSTRIALBOLT.COM © © © 800-678-1906

Automotive Shrink Tubing
12" Cut Lengths

Assortment No. 338R

<p>B3313 14-4AWG HI FLOW ADHESIVE</p>	
<p>B3312 16-8AWG HI FLOW ADHESIVE</p>	
<p>B3311 22-10AWG HI FLOW ADHESIVE</p>	
<p>B3310 24-12AWG HI FLOW ADHESIVE</p>	
<p>B3301 3/16 X 12" CLEAR DUAL WALL</p>	
<p>B3300 1/8 X 12" CLEAR DUAL WALL</p>	

ELECTRICAL

IBS, INCORPORATED

Shrink Tubing Q2A



Color Coded Dual Wall Shrink Tubing

- **Tinted for color coding and is also translucent** to view underlying material.
- **Wire gauge imprint for ease of identification** before and after installation.
- **Adhesive lining** provides a barrier against contaminants.



IBS No.	Pre-Shrunk ID	Post-Shrunk ID	Wire Size	MAX Wall	Color	Length	Qty
B279	.115	.028	24-22	.06	Clear	6"	10
B280	.245	.045	22-18	.06	Red	6"	10
B281	.245	.080	16-14	.06	Blue	6"	10
B282	.360	.100	12*10	.06	Yellow	6"	10

Automotive Shrink Tubing Assortment (Z02)

Includes Torch

IBS No. 297R • 9 Items • 55 Pcs



















Packaged in a locking steel drawer for easy storage and organization



IBS, Inc.
SPECIALTY PRODUCTS FOR MAINTENANCE & REPAIR
INDUSTRIALBOLT.COM © © © 800-678-1906



Automotive Shrink Tubing
With MicroTorch Butane Torch Included
Assortment No. 297R

<p>B281 16-14 SOLDER&SEAL SHRINK TUBE</p>  	<p>B282 12-10 SOLDER/SEAL SHRINK TUBE</p>  
<p>B280 22-18 SOLDER&SEAL SHRINK TUBE</p>  	<p>B279 24-22 SOLDER/SEAL SHRINK TUBE</p>  
<p>B3507 14-8GA X 6 CLEAR SHRINK TUBE"</p>  	<p>B3508 8-2GA X 6 CLEAR SHRINK TUBE"</p>  
<p>B3302 1/4 X 12 CLEAR DUAL WALL"</p>  	
<p>B3301 3/16 X 12 CLEAR DUAL WALL"</p>  	
<p>B3300 1/8 X 12 CLEAR DUAL WALL"</p>  	

ELECTRICAL



IBS, INCORPORATED

Shrink Tubing Q2A

Optiseal Adhesive-Lined Heat Shrink Tubing

- Provides optimal clarity for visual inspection.
- Adhesive-lined tubing ensures a waterproof seal.
- Wire gauge imprint simplifies wire size identification.

SPECIFICATIONS

Material: Cross-linked ionic polymer

Shrink Ratio: Exceeds 2.5 to 1

Shrink/Recovery Temperature: 90°C (194°F)

Continuous Operating Temp: -55°C to 125°C

Flammability: Passed (FMVSS 302 test)

Tensile Strength: 4,000 psi

Longitudinal Change: +1/-10% Max

Dielectric Strength: 750 V/Mil (30KV/MM)



IBS No.	Pre-Shrunk ID	Post-Shrunk ID	Wire Size	Color	Length	Qty
B5926	.176	.045	22-18	Clear	6"	10
B5924	.250	.080	16-14	Clear	6"	10
B5920	.365	.100	12-10	Clear	6"	10

Optiseal Butt Connectors & Shrink Tubing (Z02)

Includes Torch

IBS No. 728R • 6 Items • 100 Pcs

Packaged in a locking plastic Travel Tray for easy storage and organization



Optiseal Butt Connector & Shrink Tubing

Assortment No. 728R

<p>B5916 22-18 OPTISEAL BUTT CONNECTOR</p> 	<p>B5914 16-14 OPTISEAL BUTT CONNECTOR</p> 	<p>B5910 12-10 OPTISEAL BUTT CONNECTOR</p> 	<p>B5926 22-18 OPTISEAL HEAT SHRINK TUBING .260 X 6"</p> 	<p>B5924 16-14 OPTISEAL HEAT SHRINK TUBING .260 X 6"</p> 	<p>B5920 12-10 OPTISEAL HEAT SHRINK TUBING .375 X 6"</p> 
--	--	--	--	--	--

ELECTRICAL

Thin Wall Heat Shrink Tubing — 48" Lengths

- Flexible polyolefin single wall tubing — will not crack or split.
- Withstands open flame.
- 2 to 1 shrink ratio — one part number covers 2 or more wire sizes.



IBS No. Red	IBS No. Black	Pre-Shrunk ID	Post-Shrunk ID	Wire Size	MAX Wall	Length	Qty
16513	16524	1/8	1/16	26-22	.020	48"	4
16514	16523	3/16	3/32	22-18	.020	48"	4
16515	16525	1/4	1/8	16-14	.025	48"	4
16516	16526	3/8	3/16	12-10	.025	48"	4
16517	16527	1/2	1/4	6-4	.025	48"	4
16518	16528	3/4	3/8	2-1	.030	48"	4
16519	16529	1	1/2	1/0	.035	48"	4

Thin Wall Heat Shrink Tubing — 25' Rolls

While Supplies Last

- Flexible polyolefin single wall tubing — will not crack or split.
- Withstands open flame.
- 2 to 1 shrink ratio — one part number covers 2 or more wire sizes.

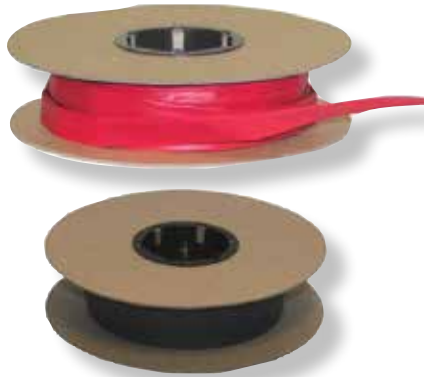

IBS No. Red	IBS No. Black	Pre-Shrunk ID	Post-Shrunk ID	Wire Size	MAX Wall	Length	Qty
16554	-	1/8	1/16	26-22	.020	25'	1
16553	-	3/16	3/32	22-18	.020	25'	1
16555	-	1/4	1/8	16-14	.025	25'	1
16556	-	3/8	3/16	12-10	.025	25'	1
16557	-	1/2	1/4	6-4	.025	25'	1
16558	-	3/4	3/8	2-1	.030	25'	1
16559	16589	1	1/2	1	.035	25'	1

ELECTRICAL



IBS, INCORPORATED

Battery Terminals Q02

ECOMAX™ Post Top Battery Terminals

ECOMAX™ Battery Terminals are the first environmentally friendly, 100% copper battery terminal. The post top design is manufactured with the highest quality C11000 ETP copper and is completely lead free and RoHS compliant — making it exempt from CA Proposition 65 requirement.

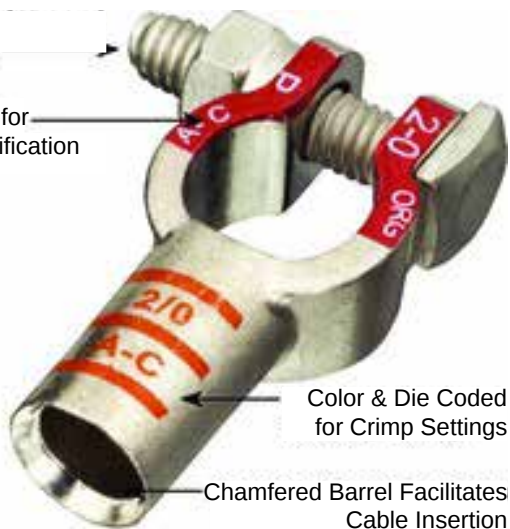

ECOMAX Battery Terminals Feature:

- Environmentally Friendly — RoHS compliant.
- Lead Free — Exempt from CA Proposition 65.
- 100% Copper Construction — C11000 ETP.
- Maximum Conductivity 101% IACS at 68°F.
- Tin plated for corrosion resistance.
- Provided with Nut and Bolt installed.
- Exceeds SAE Standard.

ECOMAX™ STRAIGHT CLAMP TERMINAL

IBS No.	Cable GA	Polarity	Color	Qty
E2102	4 GA	Univ	Gray	5
E2107	1+2 GA	Neg	Pink	5
E2108	1+2 GA	Pos	Pink	5
E2109	1/0	Neg	Black	5
E2110	1/0	Pos	Black	5
E2111	2/0	Neg	Orange	5
E2112	2/0	Pos	Orange	5
E2113	3/0	Neg	Purple	5
E2114	3/0	Pos	Purple	5
E2115	4/0	Neg	Yellow	5
E2116	4/0	Pos	Yellow	5



ECOMAX FLAG TERMINALS

IBS No.	Cable GA	Polarity	Color	Qty
E2209	1/0	Neg	Black	5
E2210	1/0	Pos	Black	5
E2211	2/0	Neg	Orange	5
E2212	2/0	Pos	Orange	5
E2213	3/0	Neg	Purple	5
E2214	3/0	Pos	Purple	5



ECOMAX™ RIGHT ELBOW TERMINALS

IBS No.	Cable GA	Polarity	Color	Qty
E2309	1/0	Neg	Black	5
E2310	1/0	Pos	Black	5
E2311	2/0	Neg	Orange	5
E2312	2/0	Pos	Orange	5



ECOMAX™ LEFT ELBOW TERMINALS

IBS No.	Cable GA	Polarity	Color	Qty
E2411	2/0	Neg	Orange	5
E2412	2/0	Pos	Orange	5

ELECTRICAL

IBS, INCORPORATED

Assortments Z02



EcoMax Terminals, HD Lugs & Splices Assortment

IBS No. 202P • 11 Items • 75 Pcs
 Packaged in a locking steel drawer for easy storage and organization



IBS, Inc. SPECIALTY PRODUCTS FOR MAINTENANCE & REPAIR INDUSTRIALMARKET.COM 800-475-1500				EcoMax Terminals Heavy Duty Lugs & Splices			
Assortment No. 202P							
BAL1038 1/0 X 3/8ST HVY DUTY TUBULAR LUG	BAL1012 BATT TERM 1/0 X 1/2 STUD LUG HEAVY DUTY TUBULAR	E2110 ECOMAX BATT TERM 1/0 GA POS	E2109 ECOMAX BATT TERM 1/0 GA NEG				
BAL2038 2/0 X 3/8ST HVY DUTY TUBULAR LUG	BAL2012 2/0 X 1/2ST HVY DUTY TUBULAR LUG			E2112 ECOMAX BATT TERM 2/0 GA POS	E2111 ECOMAX BATT TERM 2/0 GA NEG		
MS100 1/0GA HVY DUTY BUTT CONN	MS200 2/0GA HVY DUTY BUTT CONN						
B1110 5/16 X 1-1/4 BATT BOLT & NUT TIN PLATED							

EcoMax Battery Ends & Shrink Tubing Assortment

IBS No. 835R • 8 Items • 34 Pcs
 Packaged in a locking steel drawer for easy storage and organization



IBS, Inc. SPECIALTY PRODUCTS FOR MAINTENANCE & REPAIR INDUSTRIALMARKET.COM 800-475-1500				Eco-Max Battery Ends & Shrink Tubing			
Assortment No. 835R							
BAL1038 1/0 X 3/8ST HVY DUTY TUBULAR	BAL2038 2/0 X 3/8ST HVY DUTY TUBULAR	B3405 2-4/0GA X 6' RED HVY WALL	B3505 2-4/0GA X 6' BLACK HVY				
E2110 ECOMAX BATT TERM 1/0 GA POS	E2112 ECOMAX BATT TERM 2/0 GA POS						
E2109 ECOMAX BATT TERM 1/0 GA NEG	E2111 ECOMAX BATT TERM 2/0 GA NEG						

EcoMax Post Top Battery Terminals Assortment

IBS No. 129P • 17 Items • 69 Pcs
 Packaged in a locking steel drawer for easy storage and organization



IBS, Inc. SPECIALTY PRODUCTS FOR MAINTENANCE & REPAIR INDUSTRIALMARKET.COM 800-475-1500				ECOMAX Post Top Battery Terminals			
Assortment No. 129P							
E2107 ECOMAX BATT TERM 1-2 GA NEG	E2111 ECOMAX BATT. TERM 2/0 GA. NEG.	E2309 ECOMAX BATT. TERM. RT. EL. 1/0 NEG.			B1110 5/16 X 1-1/4 TIN PLTD BATT		
E2108 ECOMAX BATTERY TERM 1-2 GA POSITIVE	E2112 ECOMAX BATT. TERM. 2/0 GA. POS.	E2310 ECOMAX BATT. TERM. RT. EL. 1/0 POS.					
E2109 ECOMAX BATT TERM 1/0 GA NEG	E2113 ECOMAX BATT. TERM. 3/0 GA. NEG.	E2311 ECOMAX BATT. TERM. RT. EL. 2/0 NEG.	E2411 ECOMAX BATT. TERM. LT. EL. 2/0 NEG.	E2211 ECOMAX BATT. TERM. FLAG 2/0 NEG.			
E2110 ECOMAX BATT TERM 1/0 GA POS	E2114 ECOMAX BATT. TERM. 3/0 GA. POS.	E2312 ECOMAX BATT. TERM. RT. EL. 2/0 POS.	E2412 ECOMAX BATT. TERM. LT. EL. 2/0 POS.	E2212 ECOMAX BATT. TERM. FLAG 2/0 POS.			

ELECTRICAL



IBS, INCORPORATED

Battery Terminals Q02

Stud Top / Side Mount Terminals

- Stackable — Allows maximum use of threads and more than one terminal to share a common stud.
- Maintenance Free
- Tin Plated
- Universal Polarity



STRAIGHT CLAMP TERMINAL

IBS No.	Cable GA	Die Code		Qty
		Color	Letter	
B2607	1 GA	Pink	H-H	5
B2609	1/0	Pink	E-A	5
B2611	2/0	Orange	A-C	5
B2613	3/0	Purple	A-B	5



DOUBLE BARREL (SPLICE)

IBS No.	Cable GA	Die Code		Qty
		Color	Letter	
B2711	2/0	Orange	A-C	5



B1103



B1104



B1105

STUD TOP BATTERY NUTS

IBS No.	Color	Type	Polarity	Qty
B1103	Black	Synthetic	Negative	10
B1104	Red	Synthetic	Positive	10
B1105	Gray	Stainless	Universal	10



B1101



BATTERY SIDE TERMINAL BOLTS

IBS No.	Description	Qty
B1101	3/8-16 X 1-1/8 Side Term Bolt	10
B1101L	3/8-16 X 1-3/4 Side Term Bolt	10
B1102	3/8-16 X 1-1/2 Side Term Bolt	10

B1102

E
L
E
C
T
R
I
C
A
L



Fusion™ Solder-On Battery Terminals

Fusion™ Connectors come ready-to-use. The correctly engineered flux and solder is precisely pre-measured and loaded in a solderable tin plated connector. Fusion™ strength is twice that of typical crimp or compression connectors.

- Stronger than crimp connectors, twice as thick as industry standards. All clamps, lugs and fasteners are tin plated.
- All clamps include tin plated 5/16" battery bolts and shoulder nuts.
- Faster, less confusing and less costly than multi-component solder slug systems.

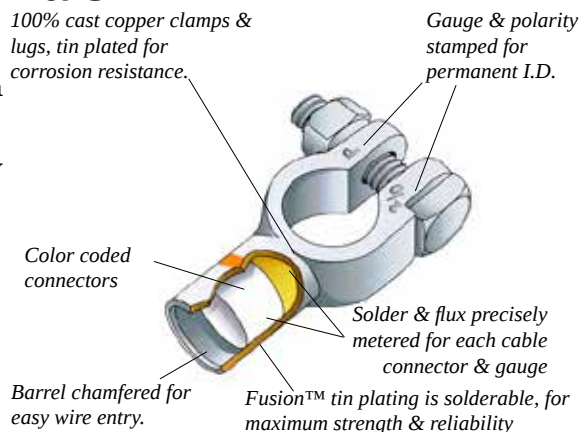

The Latest Innovation in Corrosion Protection

Quality Results with Every Application

- Long term reliability saves time and money.
- Complete, engineered system, includes copper connector, solderable tin plating, flux and solder.
- Easy for inexperienced users, saves time and money.

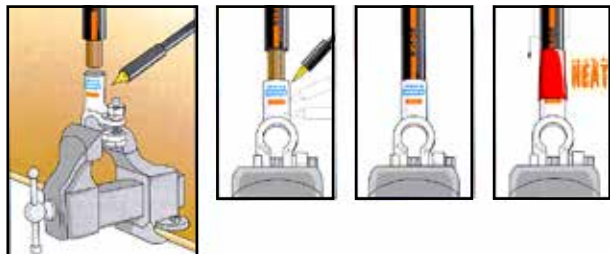

Secure connector in vise, apply heat, insert wire, allow to cool, install heat shrink tubing.

FAST, CONVENIENT, CONSISTENT QUALITY.



FUSION™ STRAIGHT CLAMP TERMINAL

IBS No.	Cable GA	Polarity	Color	Qty
B2117	4-6 GA	Neg	Grey	5
B21171	4-6 GA	Pos	Grey	5
B2118	1-2 GA	Neg	Pink	5
B2119	1-2GA	Pos	Pink	5
B2120	1/0	Neg	Black	5
B2121	1/0	Pos	Black	5
B2122	2/0	Neg	Orange	5
B2123	2/0	Pos	Orange	5
B2124	3/0	Neg	Purple	5
B2125	3/0	Pos	Purple	5
B2126	4/0	Neg	Yellow	5
B2127	4/0	Pos	Yellow	5



FUSION™ RIGHT CLAMP TERMINAL

IBS No.	Cable GA	Polarity	Color	Qty
B2128	1-2 GA	Neg	Pink	5
B2129	1-2GA	Pos	Pink	5
B2130	1/0	Neg	Black	5
B2131	1/0	Pos	Black	5
B2132	2/0	Neg	Orange	5
B2133	2/0	Pos	Orange	5
B2134	3/0	Neg	Purple	5
B2135	3/0	Pos	Purple	5
B2136	4/0	Neg	Yellow	5
B2137	4/0	Pos	Yellow	5



IBS, INCORPORATED

Battery Terminals Q02

ELECTRICAL



FUSION™ Flag

IBS No.	Cable GA	Polarity	Color	Qty
B2148	1-2 GA	Neg	Pink	5
B2149	1-2GA	Pos	Pink	5
B2150	1/0	Neg	Black	5
B2151	1/0	Pos	Black	5
B2152	2/0	Neg	Orange	5
B2153	2/0	Pos	Orange	5
B2154	3/0	Neg	Purple	5
B2155	3/0	Pos	Purple	5
B2156	4/0	Neg	Yellow	5
B2157	4/0	Pos	Yellow	5



FUSION™ HEAVY WALL LUGS (Q09)

IBS No.	Cable GA	Size	Color	Qty
B00381	4-6 GA	3/8	Grey	5
B00501	4-6 GA	1/2	Grey	5
B01381	1-2 GA	3/8	Pink	5
B01501	1-2GA	1/2	Pink	5
B11381	1/0	3/8	Black	5
B11501	1/0	1/2	Black	5
B21381	2/0	3/8	Orange	5
B21501	2/0	1/2	Orange	5
B31381	3/0	3/8	Purple	5
B31501	3/0	1/2	Purple	5
B41381	4/0	3/8	Yellow	5
B41501	4/0	1/2	Yellow	5

Fusion Solder-On Battery Ends & Shrink Tubing Assortment

IBS No. 296P • 8 Items • 34 Pcs

Packaged in a locking steel drawer for easy storage and organization



**FUSION™ Solder-On
Battery Ends & Shrink Tubing**
Assortment No. 296P

<small>B11381</small> 1/0 X 3/8 FUSION HVY WALL LUG 	<small>B21381</small> 2/0 X 3/8 FUSION HVY WALL LUG 	<small>B3405</small> 2-4/0GA X 6" RED HVY WALL 	<small>B3505</small> 2-4/0GA X 6" BLACK HVY
<small>B2121</small> 1/0 POS STRT FUSION BATTERY 	<small>B2123</small> 2/0 POS STRT FUSION BATTERY 		
<small>B2120</small> 1/0 NEG STRT FUSION BATTERY 	<small>B2122</small> 2/0 NEG STRT FUSION BATTERY 		

Fusion Battery Ends Assortment (Z02)

IBS No. 387R • 12 Items • 22 Pcs

Packaged in a locking steel drawer for easy storage and organization



Fusion Battery Ends
Assortment No. 387R

<small>B2117</small> 4-6GA NEG STRT FUSION BATTERY 	<small>B21171</small> 4-6GA POS STRT FUSION BATTERY 	<small>B2118</small> 1-2GA NEG STRT FUSION BATTERY 	<small>B2119</small> 1-2GA POS STRT FUSION BATTERY
<small>B2120</small> 1/0 NEG STRT FUSION BATTERY 	<small>B2121</small> 1/0 POS STRT FUSION BATTERY 	<small>B2122</small> 2/0 NEG STRT FUSION BATTERY 	<small>B2123</small> 2/0 POS STRT FUSION BATTERY
<small>B2124</small> 3/0 NEG STRT FUSION BATTERY 	<small>B2125</small> 3/0 POS STRT FUSION BATTERY 	<small>B2126</small> 4/0 NEG STRT FUSION BATTERY 	<small>B2127</small> 4/0 POS STRT FUSION BATTERY



Battery Terminals



HEAVY DUTY UNIVERSAL TERMINAL

IBS No.	Cable GA	Polarity	Qty
N7000	2/0-4/0	Neg or Pos	5



AUTOMOTIVE SERIES EMERGENCY STYLE BATTERY TERMINALS

IBS No.	Cable GA	Polarity	Color	Qty
133333	4GA - 1/0	Negative	Black	5
133332	4GA - 1/0	Positive	Red	5
133334	Universal	Universal	Zinc	5



MARINE WING NUT STYLE BATTERY TERMINALS

IBS No.	Cable GA	Stud	Polarity	Color	Qty
133336	4GA-1/0	5/16"	Negative	Black	5
133335	4GA-1/0	3/8"	Positive	Red	5

Military Spec Battery Terminals

These battery terminal adapters are used for mounting electrical leads to battery terminals on industrial lift trucks, tractor trucks, off road vehicles and many military applications for the U.S. Army, Navy, Marines and Coast Guard. The basic shape style is for A26 battery posts. Mil spec battery terminals feature a thick lead body and 3/8" bolt to attach to any accessory needed. Both bolts are reversible to allow for easier installation.



IBS No.	Description	Polarity	Qty
133529	Military Battery End	Negative	5
133530	Military Battery End	Positive	5

OEM Style Battery Terminals

- Ideal replacement for all light & medium duty.
- Zinc-plated copper alloy.
- Ribbed barrel for added wire gripping.



IBS No.	Cable GA	Polarity	Qty
133329	8-6 GA	Negative	5
133328	8-6 GA	Positive	5
133331	4, 2 & 1 GA	Negative	5
133330	4, 2 & 1 GA	Positive	5

Battery Converters



Side Terminal to Post Conversion (Male Thread)

- Converts side terminal to side post.
- Polarity specific.



Post Top to Side Terminal

- Converts post top to side terminal.
- Polarity specific.
- With steel insert.
- Fasteners included.

IBS No.	Description	Qty
133338	Side Terminal Post Set Positive & Negative (5 sets = 10 pcs)	5
133339	Side Terminal Adapter Set Positive & Negative (5 sets = 10 pcs)	5

Accessory Bolts

- Connect accessories directly to your battery. Ideal for radios, lights, winches, stereo systems, hydraulic pumps — any accessory that requires direct connection to the battery.
- Adapters made of solid brass.



IBS No.	Description	Qty
B6007	3/8 Side Terminal Accessory Bolt replaces regular S/T bolt and has 5/16-18 x 1/2" stud for accessory wires.	10
B6024	Adapter nut replaces regular 5/16" shoulder nut on top post clamps and has 5/16-18 x 3/4 stud for accessory wires.	10

Battery Nuts & Bolts

- Tin Plated
- Sold by the package (25 Nuts, 25 bolts)



IBS No.	Description	Qty
B1110	5/16-18 x 1-1/4 (25 Nuts, 25 Bolts)	25



IBS, INCORPORATED

Battery Terminals Q02

Cable Slugs



Cable slugs provide a fast, easy and environmentally sealed method to complete battery connections of all types. Cable slugs are available in seven sizes and are color coded for wire range from 4 GA to 4/0. Flux is packed in 2 oz. jars to provide easy application to the cable.

- No crimp tools required.
- Minimal risk of insulation puncture.
- Environmental seal of insulator to wire prevents dielectric leakage and damage to splice by corrosive environments.
- Bonded insulation provides optimum mechanical strain relief.
- Minimal training and operator skill required to achieve correct results.

IBS No.	Size	Color	Qty
B400	4 GA	Grey	10
B200	2 GA	Green	10
B100	1 GA	Pink	10
B1010	1/0 GA	Black	10
B2010	2/0 GA	Orange	10
B3010	3/0 GA	Purple	10
B4010	4/0 GA	Yellow	10
B500	2 oz	Flux	1

Special Battery Ends Assortment

IBS No. 642P • 19 Items 52 Pcs

Packaged in a locking steel drawer for easy storage and organization





















IBS, Inc.

SPECIALTY PRODUCTS FOR MAINTENANCE & REPAIR
INDUSTRIALBOLT.COM ☎ ☎ ☎ 800-678-1906

Special Battery Ends

Assortment No. 642P

<p>133328 8-6GA OEM POSITIVE BATTERY END</p> 	<p>N7000 HVY DUTY TOP MOUNT BATT TERM</p> 	<p>133338 POST TO SIDE MNT BATTERY END</p> 	<p>133335 MARINE WING NUT BATTERY END</p> 	<p>133336 MARINE WING NUT BATTERY END</p> 
<p>133329 8-6GA OEM NEGATIVE BATTERY END</p> 	<p>133332 AUTOMOTIVE EMERGENCY POS.</p> 	<p>133338 POST TO SIDE MNT BATTERY END</p> 	<p>B6007 SIDE MNT BATTERY ACC. BOLT</p> 	<p>B6024 TOP MNT BATTERY ACC. BOLT</p> 
<p>133330 4,2&1GA OEM POSITIVE BATTERY</p> 	<p>133333 AUTOMOTIVE EMERGENCY NEG.</p> 	<p>133339 SIDE MNT TO POST TOP BATT.</p> 	<p>B1101 SIDE MOUNT BATT BOLT OEM</p> 	<p>B1102 SIDE MOUNT BATT BOLT EX LONG</p> 
<p>133331 4,2&1GA OEM NEGATIVE BATTERY</p> 	<p>133334 AUTOMOTIVE SIDE MNT EMERG</p> 	<p>133339 SIDE MNT TO POST TOP BATT.</p> 	<p>B1110 5/16 X 1-1/4 BATT BOLT & NUT TIN PLATED</p> 	

ELECTRICAL



Battery End Power Cleaning Brushes (T03)

These brushes remove and polish corroded battery posts to ensure optimal conductivity. Brushes fit easily and securely in any electric, cordless or pneumatic drill.

- Cleans & polishes up to 1,000 battery posts.
- Heavy duty injected molded housing.
- Resilient steel bristles.
- Accepts 1/4" hex shank. Fits all drills or cordless screwdrivers.
- Acceptable RPM rating between 400-800

4-in-1 Tube Fitting Brush



Post Top

Marine

IBS No.	Description	Qty
133341	Post Top Power Brush	1
133343	Marine Power Brush	1
44690	4-in-1 Tube Fitting Brush	1
133457	Set of 4 Battery Power Brushes	1

Terminal Protectors (Q02)



- For Post Top Terminals
 - Prevents corrosion build-up.
 - Prolongs battery life.
 - Provides full starting power.
- Sold Each by Can
(1 can contains 100 protectors)

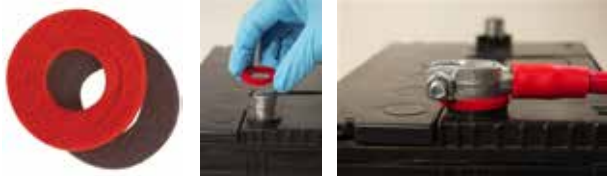

IBS No.	Description	Qty
643TP	Terminal Protectors (100 per can)	1

Heavy Duty Lugs

- Extra heavy duty thick copper for greater conductivity.
- Identification marked for cable size, color and letter code.
- Thicker tongue and raised barrel to resist vibration.
- Superior height to conventional lugs & splices.
- Longer barrel for improved crimping.
- 100% tin plating.
- Resists cracking.



IBS No.	Cable GA	Stud	Qty
BAL0138	1-2 GA	3/8	5
BAL0112	1-2 GA	1/2	5
BAL1038	1/0	3/8	5
BAL1012	1/0	1/2	5
BAL2038	2/0	3/8	5
BAL2012	2/0	1/2	5
BAL3038	3/0	3/8	5
BAL3012	3/0	1/2	5
BAL4038	4/0	3/8	5
BAL4012	4/0	1/2	5

Splices

Standard

Flared opening for easy cable insertion. Made electrolytic copper, tin plated

Heavy Duty

Superior height to conventional splices
Thicker copper for greater conductivity.
Crimping tool coding on barrel.
100% tin plated.



STANDARD SPLICES

HEAVY DUTY SPLICES

IBS No.	Cable GA	Qty
B1930	#2	10
B1940	#1	10
B1950	1/0	10
B1960	2/0	10
B1970	3/0	10

IBS No.	Cable GA	Qty
MS1	1 GA	5
MS100	1/0	5
MS200	2/0	5
MS300	3/0	5
MS400	4/0	5



IBS, INCORPORATED

Tubular Lugs Q09

Copper Tubular Lugs



- Flared and chamfered barrel facilitates cable insertion.
- Made of 100% electrolytic copper.
- Lugs can be crimped or soldered.
- Gauge is stamped on lug for easy identification.

IBS No.	Cable GA	Stud	Qty	IBS No.	Cable GA	Stud	Qty
B8101	8 GA	#10	10				
B8141	8 GA	1/4	10	B1143	1 GA	1/4	10
B8561	8 GA	5/16	10	B1561	1 GA	5/16	10
B8383	8 GA	3/8	10	B1381	1 GA	3/8	10
B8503	8 GA	1/2	10	B1501	1 GA	1/2	10
B6101	6 GA	#10	10				
B6141	6 GA	1/4	10	B10141	1/0 GA	1/4	10
B6561	6 GA	5/16	10	B10516	1/0 GA	5/16	10
B6583	6 GA	3/8	10	B10381	1/0 GA	3/8	10
B6503	6 GA	1/2	10	B10501	1/0 GA	1/2	10
B4101	4 GA	#10	10				
B4141	4 GA	1/4	10	B20141	2/0 GA	1/4	10
B4561	4 GA	5/16	10	B20516	2/0 GA	5/16	10
B4381	4 GA	3/8	10	B20381	2/0 GA	3/8	10
B4503	4 GA	1/2	10	B20501	2/0 GA	1/2	10
B2141	2 GA	1/4	10	B30381	3/0 GA	3/8	10
B2561	2 GA	5/16	10	B30501	3/0 GA	1/2	10
B2381	2 GA	3/8	10	B40381	4/0 GA	3/8	10
B2503	2 GA	1/2	10	B40501	4/0 GA	1/2	10

Copper Tubular Lugs Assortment (Z02)

IBS No. 755R • 24 Items • 120 Pcs

Packaged in a locking steel drawer for easy storage and organization



Copper Tubular Lugs

Assortment 755R

<p>B8101 BATT TERM #8AWG #10 STUD LUG</p>	<p>B6101 BATT TERM #6AWG #10 STUD LUG</p>	<p>B4141 BATT TERM #4AWG 1/4 STUD LUG</p>	<p>B2381 BATT TERM #2AWG 3/8 STUD LUG</p>	<p>B10381 BATT TERM 1/0AWG 3/8 STUD LUG</p>	<p>B30381 BATT TERM 3/0AWG 3/8 STUD LUG</p>
<p>B8141 BATT TERM #8AWG 1/4 STUD LUG</p>	<p>B6141 BATT TERM #6AWG 1/4 STUD LUG</p>	<p>B4561 BATT TERM #4AWG 5/16 STUD LUG</p>	<p>B2503 BATT TERM #2AWG 1/2 STUD LUG</p>	<p>B10501 BATT TERM 1/0AWG 1/2 STUD LUG</p>	<p>B30501 BATT TERM 3/0AWG 1/2 STUD LUG</p>
<p>B8561 BATT TERM #8AWG 5/16 STUD LUG</p>	<p>B6561 BATT TERM #6AWG 5/16 STUD LUG</p>	<p>B4381 BATT TERM #4AWG 3/8 STUD LUG</p>	<p>B1381 BATT TERM #1AWG 3/8 STUD LUG</p>	<p>B20381 BATT TERM 2/0AWG 3/8 STUD LUG</p>	<p>B40381 BATT TERM 4/0AWG 3/8 STUD LUG</p>
<p>B8383 BATT TERM #8AWG 3/8 STUD LUG</p>	<p>B6583 BATT TERM #6AWG 3/8 STUD LUG</p>	<p>B4503 BATT TERM #4AWG 1/2 STUD LUG</p>	<p>B1501 BATT TERM #1AWG 1/2 STUD LUG</p>	<p>B20501 BATT TERM 2/0AWG 1/2 STUD LUG</p>	<p>B40501 BATT TERM 4/0AWG 1/2 STUD LUG</p>

IBS, INCORPORATED

Tubular Lugs Q09



Tin Plated Copper Tubular Lugs



- Flared and chamfered barrel facilitates cable insertion.
- Tin plated copper lugs reduce corrosion caused by harsh environments.
- May be soldered or crimped and are burr-free for a finished, professional look.
- UL Listed/CSA Certified.

IBS No.	Cable GA	Stud	Qty	IBS No.	Cable GA	Stud	Qty
B8101P	8 GA	#10	10				
B8141P	8 GA	1/4	10	B1143P	1 GA	1/4	10
B8561P	8 GA	5/16	10	B1561P	1 GA	5/16	10
B8383P	8 GA	3/8	10	B1381P	1 GA	3/8	10
B8503P	8 GA	1/2	10	B1501P	1 GA	1/2	10
B6101P	6 GA	#10	10				
B6141P	6 GA	1/4	10	B10141P	1/0 GA	1/4	10
B6561P	6 GA	5/16	10	B10516P	1/0 GA	5/16	10
B6583P	6 GA	3/8	10	B10381P	1/0 GA	3/8	10
B6503P	6 GA	1/2	10	B10501P	1/0 GA	1/2	10
B4101P	4 GA	#10	10				
B4141P	4 GA	1/4	10	B20141P	2/0 GA	1/4	10
B4561P	4 GA	5/16	10	B20516P	2/0 GA	5/16	10
B4381P	4 GA	3/8	10	B20381P	2/0 GA	3/8	10
B4503P	4 GA	1/2	10	B20501P	2/0 GA	1/2	10
B2141P	2 GA	1/4	10	B30381P	3/0 GA	3/8	10
B2561P	2 GA	5/16	10	B30501P	3/0 GA	1/2	10
B2381P	2 GA	3/8	10	B40381P	4/0 GA	3/8	10
B2503P	2 GA	1/2	10	B40501P	4/0 GA	1/2	10

Tin Plated Copper Tubular Lugs Assortment (Z02)

IBS No. 760R • 24 Items • 120 Pcs

























Packaged in a locking steel drawer for easy storage and organization



Tin Plated Copper Tubular Lugs

Assortment 760R



<p>B8101P BATT TERM #8AWG #10 STUD LUG</p> 	<p>B6101P BATT TERM #6AWG #10 STUD LUG</p> 	<p>B4141P BATT TERM #4AWG 1/4 STUD LUG</p> 	<p>B2381P BATT TERM #2AWG 3/8 STUD LUG</p> 	<p>B10381P BATT TERM 1/0AWG 3/8 STUD LUG</p> 	<p>B30381P BATT TERM 3/0AWG 3/8 STUD LUG</p> 
<p>B8141P BATT TERM #8AWG 1/4 STUD LUG</p> 	<p>B6141P BATT TERM #6AWG 1/4 STUD LUG</p> 	<p>B4561P BATT TERM #4AWG 5/16 STUD LUG</p> 	<p>B2503P BATT TERM #2AWG 1/2 STUD LUG</p> 	<p>B10501P BATT TERM 1/0AWG 1/2 STUD LUG</p> 	<p>B30501P BATT TERM 3/0AWG 1/2 STUD LUG</p> 
<p>B8561P BATT TERM #8AWG 5/16 STUD LUG</p> 	<p>B6561P BATT TERM #6AWG 5/16 STUD LUG</p> 	<p>B4381P BATT TERM #4AWG 3/8 STUD LUG</p> 	<p>B1381P BATT TERM #1AWG 3/8 STUD LUG</p> 	<p>B20381P BATT TERM 2/0AWG 3/8 STUD LUG</p> 	<p>B40381P BATT TERM 4/0AWG 3/8 STUD LUG</p> 
<p>B8383P BATT TERM #8AWG 3/8 STUD LUG</p> 	<p>B6583P BATT TERM #6AWG 3/8 STUD LUG</p> 	<p>B4503P BATT TERM #4AWG 1/2 STUD LUG</p> 	<p>B1501P BATT TERM #1AWG 1/2 STUD LUG</p> 	<p>B20501P BATT TERM 2/0AWG 1/2 STUD LUG</p> 	<p>B40501P BATT TERM 4/0AWG 1/2 STUD LUG</p> 



IBS, INCORPORATED

Battery Tools T03

High Capacity Hydraulic Crimper



High Capacity Hydraulic Crimper creates strong mechanical connections with crisp and sharp corners. The powerful hydraulic action delivers 70kN (15,736 Lbf) of force for secure crimps. This crimper includes 8 hardened steel die sets, and is ideal for battery and welding cables.

- Powerful hydraulic action delivers nominal force of 10 tons for secure crimps.
- Ideal for battery and welding cables.
- Creates strong mechanical connections with crisp and sharp corners.
- Features non-slip handle and ON/OFF retractor knob.
- Includes 8 hardened-steel die sets from #6 to 4/0 AWG.

IBS No.	Description	Qty
141981	High Capacity Hydraulic Crimper	1

Universal Crimping Tool

IBS No. B0283

- **Double Compound Action** effortlessly exerts maximum force for fast, reliable crimps every time.
- **Rotating Dies** accommodate all sizes of battery terminals, lugs, and connectors, eliminating loss or need to store individual dies.
- **Diamond Shape Crimp** compresses all strands together to form a solid mass of copper. This assures a low resistance connection every time.
- **Easy to use reference chart** located on tool eliminates guess work enabling competition products to be crimped accurately.
- **Wire range:** #8 GA through 250 MCM.



BATTERY TERMINAL CRIMPING TOOL APPLICATION CHART

AWG No.	Battery Terminals Die Setting				Flared Lugs Die Setting		
	L Die	R Die	Color	# of Crimps	L Die	R Die	# of Crimps
6	NA	NA	NA	NA	M	K	1
4	J	H	Green	1	K	K	1
2	H	H	Pink	2	J	H	1
1	H	H	Pink	2	J	H	
1/0	E	A	Black	2	H	H	
2/0	A	C	Orange	2	E	A	2
3/0	A	B	Purple	2	A	C	
4/0	A	A	Yellow	2	A	B	2

E
L
E
C
T
R
I
C
A
L



Cable Cutter

IBS No. B0014

Wire Range: 8 GA to 350 mm

Length: 24 inches



Wire & Cable Cutter

IBS No. B0012

Wire Range: up to 1/0

Length: 8-1/2 inches



Battery Cable Stripper

IBS No. B0285

Wire Range: 8 GA to 4/0

Length: 3-3/4 inches



Indent Crimper

IBS No. B0840

Wire Range: 6 GA to 4/0

Length: 3-3/4 inches



12 Volt Tester

IBS No. 0690T

- Durable, high quality tester.
- Ideal for testing lighting and wiring circuits in auto, truck trailer & marine applications.
- Insulated mini-gator clip for positive contact.
- Sharp pierce point for penetrating all low voltage wiring.
- Bulb replaceable with standard automotive bulb.



Cable Clamps

IBS No. N7726

Sold in sets of Two

World's strongest booster cable clamp. Rated at 500 amps. It is the perfect replacement for worn or damaged clamps. Color coded red and black.



Professional Grade Heavy Duty Booster Cables (Q3F)

4GA x 20' 400 AMP

IBS No. 120765

- 400 AMP, Color coded clamps.
- Clamps are 100% Epoxy Coated for Safety.
- Tangle-free, twin-line cables.
- Extra Heavy Duty Insulation.
- Pure Copper Conductors.
- Stays flexible down to -30°F/-34°C
- Comes boxed for clean, safe storage.
- Includes convenient storage bag.





IBS, INCORPORATED

Nylon Tie Wraps Q04

Ty-Rap® Black Nylon Cable Tie Wraps with Metal Tabs

Heat Stabilized / Ultraviolet Resistant

A **durable, cost-effective bundling solution** designed to be used in **special applications** and in **harsh environmental conditions**. These ties combine **heat stabilizing** and **UV resistant materials** to provide a better match for special applications in both outdoor and **high-temperature** areas (-40°F/-40°C to 221°F/105°C). These ties also provide a smooth, **low-profile look** and offer **unlimited tensioning range** for a perfect fit. The convenience of a single tie for both applications keeps installation time and cost to a minimum. These ties are also **an effective alternative to expensive metallic fasteners**, which are priced higher and take longer to install.



- The **stainless steel locking device in the head** allows these ties to have a smooth body, making them infinitely adjustable within the bundle range.
- **Ideal for Industrial OEM and MRO** (includes, but not limited to industrial, lawn/garden/farming equipment, recreation vehicles, heavy equipment).
- The smooth outer body in comparison with the notched body of regular ties **reduces the stress on the tie for greater strength and improved performance**, especially in cold and dry conditions.
- **Ribbed and textured inner body prevents slippage** on the bundle from inside, keeping the tie in place during and after installation.
- **No slip tail** for easier starting and tightening.
- **Temperature range** (-40°F/-40°C to 221°F/105°C).
- **UL Recognized.**

IBS No.	Length	Strength	Width	MIL SPEC	Qty
104488	3-1/2	18 lbs	.091	MS3367-4	100
104489	5-1/2	30 lbs	.140	MS3367-5	100
104490	7	50 lbs	.187	MS3367-1	100
104491	11	50 lbs	.187	MS3367-7	100
104492	14	50 lbs	.187	MS3367-2	50
104493	13	120 lbs	.270	MS3367-3	50

Met-Tab Cable Tie Rack Assortment

IBS No. 815R • 5 Items • 400 Pcs

Packaged in a wall mountable steel cable tie rack for easy storage & organization.

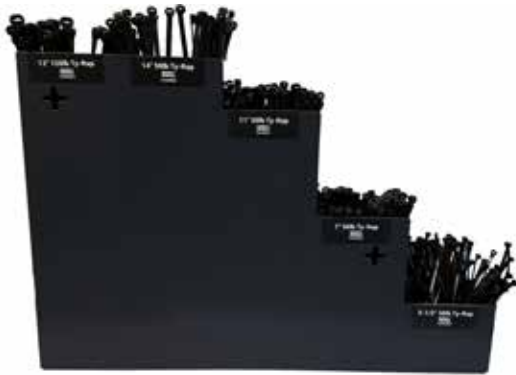

- Cable tie rack features all steel construction.
- Each compartment is supplied with a removable divider to create from 5 to 10 compartments.
- 5 different compartment heights provide storage space for cable ties in multiple lengths.
- Wall mountable.
- Overall diameter: 18-5/32"W X 3D X 12-1/4"H

ELECTRICAL

IBS, INCORPORATED

Assortments Z02

















Black Nylon Ty-Raps with Metal Tabs Assortment

IBS No. 370R • 7 Items • 251 Pcs

Packaged in a locking steel drawer for easy storage & organization.



 IBS, Inc. <small>SPECIALTY PRODUCTS FOR MAINTENANCE & REPAIR INDUSTRIALBOLT.COM © © © 800-678-1906</small>		Black Nylon Ty-Raps with Metal Tabs	
		Assortment No. 370R	
104487 MINI CABLE TIE GUN			
			
104493 13IN 120LB BLACK NYLON TYRAP METAL TAB			
			
104492 14IN 50LB BLACK NYLON TYRAP METAL TAB			
			
104491 11IN 50LB BLACK NYLON TYRAP METAL TAB			
			
104490 7IN 50LB BLACK NYLON TYRAP METAL TAB			
			
104488 3-1/2 18LB BLACK NYLON TYRAP METAL TAB		104489 5-1/2 30LB BLACK NYLON TYRAP METAL TAB	
			

ELECTRICAL



IBS, INCORPORATED

Nylon Tie Wraps Q04

Cable Tie Wraps

Cable ties are all nylon and flame retardant, fungus inert, and resistant to solvents, alkalies, and grease. They function normally in service temperatures ranging from -40°F (-40°C) to 185°F (85°C) and can be stored in temperatures down to -85°F (-65°C).

The flexible design of the cable ties allows them to be slipped easily under and around cables and harnesses. The curved tip makes it easier to grasp, position and insert into the head. The raised ribs on the tail allow for temporary holding while the work is being positioned. The tie then locks in place automatically and the excess tail can be snipped off. The cable tie will then stay locked without slipping. No metal barbs.

NATURAL NYLON CABLE TIES

IBS No.	Length	Strength	Width	Bundle	Qty
L-4-18	4"	18 lbs	.095	.75"	100
L-5-30	5.5"	40 lbs	.140	1.5"	100
L-7-50	7.5"	50 lbs	.180	2"	100
L-11-50	11"	50 lbs	.180	3"	100
L-14-50	14.5"	50 lbs	.180	4"	100
L-14-120	15"	120 lbs	.300	4"	100
L-8-175	8"	175 lbs	.340	2"	100
L-24-175	24.5"	175 lbs	.340	7"	50
L-32-175	36"	175 lbs	.340	10"	50

UV BLACK WEATHER-RESISTANT CABLE TIES

IBS No.	Length	Strength	Width	Bundle	Qty
B-4-18	4"	18 lbs	.095	.75"	100
B-8-18	8"	18 lbs	.095	2"	100
B-5-30	5.5"	40 lbs	.140	1.5"	100
B-7-50	7.5"	50 lbs	.180	2"	100
B-11-50	11"	50 lbs	.180	3"	100
B-14-50	14.5"	50 lbs	.180	4"	100
B-14-120	15"	120 lbs	.300	4"	100
B-8-175	8"	175 lbs	.340	2"	100
B-24-175	24.5"	175 lbs	.340	7"	50
B-32-175	36"	175 lbs	.340	10"	50
B-21-250	22"	250 lbs	.500	6"	100

The shelf life of a nylon Cable Tie Wrap outside of its original packaging is 1 year. The 1 year shelf life begins after the packaging has been opened.

Shelf life of cable ties is a function of the environment in which they are stored.

Perfect storage conditions for a cable tie is 70°F and 50% Relative Humidity packaged in the manufacturer's original sealed bags. Life expectancy under these conditions is well in excess of two years. Shelf life will be reduced by temperature and humidity extremes, as well as by any break in the sealed bag.

Cable ties should be stored in the manufacturer's original packaging until ready for use.

Cable ties should be used within one year of purchase.

Partial Cable tie bags should be closed or sealed if at all possible.

Cable ties should not be over tensioned when installed (Over-tensioning actually weakens the tie).

E
L
E
C
T
R
I
C
A
L

IBS, INCORPORATED

Assortments Z02



Nylon Cable Tie Wraps

Assortment

IBS No. 107R • 10 Items • 750 Pcs

Packaged in a locking steel drawer for easy storage & organization.



IBS Inc. INDUSTRIAL PRODUCTS FOR MAINTENANCE & REPAIR INDUSTRIALBOLT.COM © IBS 800-678-1908		Nylon Tie Wraps
15" 120lb. Black Nylon Tie B-14-120		
14-1/2" 50 lb. Black Nylon Tie B-14-50		
4" 18 lb. Black Nylon Tie B-4-18	11" 50 lb. Black Nylon Tie B-11-50	
7-1/2" 50 lb. Clear Nylon Tie L-7-50	8" 50 lb. Mounting Tie MH-7-50	
5-1/2" 40 lb. Clear Nylon Tie L-5-30	7-1/2" 50 lb. Black Nylon Tie B-7-50	
4" 18 lb. Clear Nylon Tie L-4-18	5-1/2" 40 lb. Black Nylon Tie B-5-30	

Standard Cable Tie Wraps Asst.

IBS No. 724R • 6 Items • 600 Pcs

Packaged in a locking steel drawer for easy storage & organization.



IBS Inc. INDUSTRIAL PRODUCTS FOR MAINTENANCE & REPAIR INDUSTRIALBOLT.COM © IBS 800-678-1908		Standard Cable Tie Wraps
L-4-18 4 18LB NATURAL NYLON TIE*	L-5-30 5-1/2 30LB NATURAL NYLON TIE*	
L-7-50 7 50LB NATURAL NYLON TIE*		
L-11-50 11 50LB NATURAL NYLON TIE*		
L-14-50 14 50LB NATURAL NYLON TIE*		
L-14-120 14 120LB NATURAL NYLON TIE*		
L-14-120 14 120LB NATURAL NYLON TIE*		

Weather-Resistant Cable Tie Wraps Assortment

IBS No. 725R • 6 Items • 600 Pcs

Packaged in a locking steel drawer for easy storage & organization.



IBS Inc. INDUSTRIAL PRODUCTS FOR MAINTENANCE & REPAIR INDUSTRIALBOLT.COM © IBS 800-678-1908		Weather Resistant Cable Tie Wraps
B-4-18 4 18LB BLACK NYLON TIE*	B-5-30 5 30LB BLACK NYLON TIE*	
B-7-50 7 50LB BLACK NYLON TIE*		
B-11-50 11 50LB BLACK NYLON TIE*		
B-14-50 14 BLACK NYLON TIE*		
B-14-120 14 120LB BLACK NYLON TIE*		
B-14-120 14 120LB BLACK NYLON TIE*		

Cable Tie Rack Assortment

IBS No. 814R • 5 Items • 500 Pcs

Packaged in a wall mountable steel cable tie rack for easy storage & organization.

- Cable tie rack features all steel construction.
- Each compartment is supplied with a removable divider to create from 5 to 10 compartments.
- 5 different compartment heights provide storage space for cable ties in multiple lengths.
- Wall mountable.
- Overall diameter: 18-5/32"W X 3D X 12-1/4"H

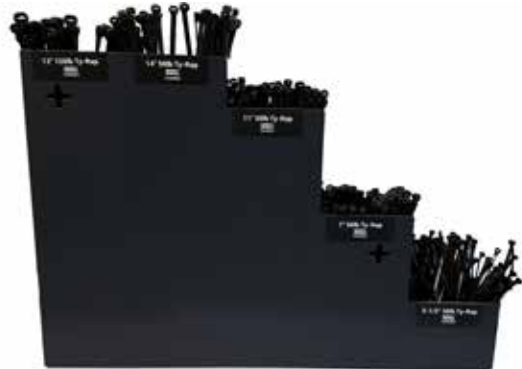

ELECTRICAL



IBS, INCORPORATED

Nylon Tie Wraps Q04

Black Low Profile Cable Tie Wraps

In some areas and applications a standard tie can be a real nuisance, snagging or catching on materials around it, or even taking up more space than needed or wanted. Standard ties can also create a safety hazard with sharp edges where the tang was cut off.

Low Profile Tie Wraps provide a solution to these problems. Made in the USA., this tie is the lowest profile nylon tie on the market and offers superior tensile strength and robust quality that stand up well in a wide range of environments. Safer than a traditional tie because of its smooth, snag proof contour with no barbs or spikes to injure and installer, technician, or end user.

FEATURES & BENEFITS

- Lowest profile nylon tie available offering exceptional functionality, strength and safety.
- Flexible head design easily flexes around tubing or bundled wiring enhancing the visual appeal of your finished product by fitting closely and snugly to the material being wrapped.
- Tamper-proof pawl located under the tie's head offers additional safety and security.
- Leftover strap conveniently slips back into the head, leaving no sharp cutoffs or exposed edges to injure the installer, technician, or end user.
- Made in the USA.
- RoHS and UL compliant.



BLACK LOW PROFILE CABLE TIE WRAPS

IBS No.	Length	Strength	Width	Bundle	Qty
BLP-7-50	7.5"	50 lbs	.17	1-3/4"	100
BLP-11-50	11"	50 lbs	.17	3"	100
BLP-14-50	14"	50 lbs	.17	4"	100
BLP-14-120	14"	120 lbs	.30	4"	100

Black Low Profile Cable Tie Wraps Assortment

IBS No. 796R • 8 Items • 700 Pcs

Packaged in a locking steel drawer for easy storage & organization.



Low Profile and Releasable Cable Tie Wraps

Assortment No. 796R

<p>BLP-14-120 14IN 120LB BLACK NYLON LOW PROFILE TIE WRAP</p>	
<p>BLP-14-50 14IN 50LB BLACK NYLON LOW PROFILE TIE WRAP</p>	
<p>RB-5-50 5 50LB BLACK RELEASABLE NYLON™ TIE WRAP</p>	<p>BLP-11-50 11IN 50LB BLACK NYLON LOW PROFILE TIE WRAP</p>
<p>RB-8-50 8 50LB BLACK RELEASABLE NYLON™ TIE WRAP</p>	<p>BLP-7-50 7IN 50LB BLACK NYLON LOW PROFILE TIE WRAP</p>
<p>RB-12-50 12 50LB BLACK RELEASABLE™ NYLON TIE WRAP</p>	
<p>RB-14-50 14 50LB BLACK RELEASABLE™ NYLON TIE WRAP</p>	



UV Black Weather-Resistant Releasable Cable Tie Wraps

Ideal for use in applications where there is a need to repeatedly open and close the tie.



IBS No.	Length	Strength	Width	Bundle	Qty
RB-5-50	5"	50 lbs	.290	1.5"	100
RB-8-50	8"	50 lbs	.290	2"	100
RB-12-50	12"	50 lbs	.290	3"	100
RB-14-50	14"	50 lbs	.180	4"	100



Nylon Speedy Ties (Q04) Reusable Tie Wrap

A fully re-usable, easily releasable lashing tie. The Speedy-Tie's unique design allows it to be released with one hand.



Features:

- Just one click to tie and untie
- Fully re-usable
- Once applied, the tail can be neatly tucked away for added safety
- Highly visible yellow color
- Versatile design allows for multiple applications

Used for and by:

- Electrical contractors
- Heating and ventilation contractors
- Residential construction
- General and heavy industry
- Packaging
- Tubing and pipe bundling
- Overhead installations
- In-plant transfer of products

IBS No.	Length in.	Length (mm)	MIN Tensile Strength lbs	MIN Tensile Strength (N)	Width in.	Width (mm)	MAX Bundle in.	MAX Bundle (mm)	Operating Temperature	Qty
141146	29.52	(750)	200 lbs	(888)	.51	(13)	8.27	(210)	-40°F to 185° F CONTINUOUS	10

Releasable Cable Tie Wraps Assortment (Z02)

IBS No. 726R • 5 Items • 310 Pcs

Packaged in a locking steel drawer for easy storage & organization.



Releasable Cable Tie Wraps

Assortment No. 726R

<p style="font-size: x-small;">RB-5-50 5" 50LB BLACK RELEASABLE NYLON TIE</p>	
<p style="font-size: x-small;">RB-8-50 8" 50LB BLACK RELEASABLE NYLON TIE</p>	
<p style="font-size: x-small;">RB-12-50 12" 50LB BLACK RELEASABLE NYLON TIE</p>	
<p style="font-size: x-small;">RB-14-50 14" 50LB BLACK RELEASABLE NYLON TIE</p>	
<p style="font-size: x-small;">141146 29.5 200# YELLOW NYLON*</p>	



IBS, INCORPORATED

Nylon Tie Wraps Q04

Colored & Fluorescent Cable Tie Wraps

Fluorescent nylon cable tie wraps feature the same design characteristics as the standard cable ties, but are available in highly visible fluorescent colors. Ideal for color coding wire bundles by usage or application.

ELECTRICAL

	IBS No.	Length	Strength	Color	Qty
	BL-4-18	4"	18 lbs.	Blue	100
	R-4-18	4"	18 lbs.	Red	100
	Y-4-18	4"	18 lbs.	Fluorescent Yellow	100
	BL-7-50	7"	50 lbs.	Blue	100
	BR-7-50	7"	50 lbs.	Brown	100
	GY-7-50	7"	50 lbs.	Gray	100
	GR-7-50	7"	50 lbs.	Green	100
	P-7-50	7"	50 lbs.	Purple	10
	R-7-50	7"	50 lbs.	Red	100
	Y-7-50	7"	50 lbs.	Yellow	100
	FB-7-50	7"	50 lbs.	Fluorescent Blue	100
	FG-7-50	7"	50 lbs.	Fluorescent Green	100
	FO-7-50	7"	50 lbs.	Fluorescent Orange	100
	FP-7-50	7"	50 lbs.	Fluorescent Pink	100
	FY-7-50	7"	50 lbs.	Fluorescent Yellow	100
	TW4	4"	18 lbs.	25 Pcs. Each of the following: White, Black, Yellow, Red & Blue	1
	TW7	7"	50 lbs.	25 Pcs. Each of the following: Blue, Brown, Gray, Green, Purple, Red, Yellow	1
	TW7FL	7"	50 lbs.	25 Pcs. Each of the following: White, Black, FL Yellow, FL Green, FL Blue, FL Orange, FL Pink	1

IBS, INCORPORATED

Assortments Z02



Colored Cable Tie Wraps Assortment

IBS No. 710R • 12 Items • 1200 Pcs

Packaged in a locking steel drawer for easy storage & organization



IBS, Inc. <small>SPECIALTY PRODUCTS FOR MAINTENANCE & REPAIR INDUSTRIALBOLT.COM © © © 800-678-1906</small>		Colored Cable Tie Wraps Assortment No. 710R
BL-4-18 4" 18LB BLUE NYLON TIE 	R-4-18 4" 18LB RED NYLON TIE 	
Y-4-18 4" 18LB FLOURESCENT YELLOW NYLON TIE 	L-4-18 4" 18LB NATURAL NYLON TIE 	
B-7-50 7" 50LB BLACK NYLON TIE 	B-4-18 4" 18LB BLACK NYLON TIE 	
FB-7-50 7" 50LB FLOURESCENT BLUE NYLON TIE 	L-7-50 7" 50LB NATURAL NYLON TIE 	
FO-7-50 7" 50LB FLOURESCENT ORANGE NYLON TIE 	FG-7-50 7" 50LB FLOURESCENT GREEN NYLON TIE 	
FY-7-50 7" 50LB FLOURESCENT YELLOW NYLON TIE 	FP-7-50 7" 50LB FLOURESCENT PINK NYLON TIE 	

8" Colored Cable Tie Wraps Assortment

IBS No. 786R • 12 Items • 1200 Pcs

Packaged in a locking steel drawer for easy storage & organization



IBS, Inc. <small>SPECIALTY PRODUCTS FOR MAINTENANCE & REPAIR INDUSTRIALBOLT.COM © © © 800-678-1906</small>		7" Colored Cable Tie Wraps Assortment No. 786R
BL-7-50 7" 50LB BLUE NYLON TIE 	GY-7-50 7" 50LB GRAY NYLON TIE 	
Y-7-50 7" 50LB YELLOW NYLON TIE 	GR-7-50 7" 50LB GREEN NYLON TIE 	
R-7-50 7" 50LB RED NYLON TIE 	P-7-50 7" 50LB PURPLE NYLON TIE 	
BR-7-50 7" 50LB BROWN NYLON TIE 	FO-7-50 7" 50LB FLOURESCENT ORANGE NYLON TIE 	
FB-7-50 7" 50LB FLOURESCENT BLUE NYLON TIE 	FP-7-50 7" 50LB FLOURESCENT PINK NYLON TIE 	
FY-7-50 7" 50LB FLOURESCENT YELLOW NYLON TIE 	FG-7-50 7" 50LB FLOURESCENT GREEN NYLON TIE 	

ELECTRICAL



IBS, INCORPORATED

Nylon Tie Wraps Q04

Push Mount Cable Ties

These cable ties snap quickly into a 1/4" hole to provide one-piece bundling and mounting. The push-mount head is ideal for mounting on panels or chassis. Centering ears and locking barbs hold securely and spring arm thickness compensators tighten in panel chassis up to 1/8" thick. Bundling can be done either before or after mounting. Injection molded for maximum strength.



UV BLACK WEATHER-RESISTANT PUSH MOUNTING CABLE TIES

IBS No.	Length	Strength	Width	Bundle	Qty
PMB-8-50	8"	50 lbs	.190	2"	100

Buttonhead Cable Ties

Buttonhead ties are of two piece construction designed to mount the tie on a panel or structural framework. The strap can be inserted into the head in either direction to speed installation. Black nylon construction.

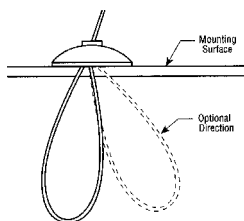

UV BLACK WEATHER-RESISTANT BUTTONHEAD CABLE TIES

IBS No.	Length	Strength	Width	Bundle	Qty
BH-10-100	9-5/8"	100 lbs	.22	2.62"	50

Screw Mount Cable Ties

Screw mount cable ties have a built-in mounting hole. Once fastened around a bundle they can simply be secured with a screw or bolt.



NATURAL SCREW MOUNT CABLE TIES

IBS No.	Length	Strength	Width	Bundle	Mounts with	Qty
MH-7-50	8"	50 lbs	.18	2"	#10 screw	100
MH-14-50	15"	50 lbs	.18	4"	#10 screw	100
MH-14-120	15"	120 lbs	.30	4"	1/4" screw	100



UV BLACK WEATHER-RESISTANT SCREW MOUNT CABLE TIES

IBS No.	Length	Strength	Width	Bundle	Mounts with	Qty
MBH-7-50	8"	50 lbs	.18	2"	#10 screw	100

Stud Mount Cable Tie Wrap

This tie is made to easily mount to the top of a stud. With the additional height gained by this design, it allows the wire bundle added clearance from the panel or wherever it is being used.

- The standoff design can be mounted onto screws or studs to mount and secure bundles in one component providing quick installation time — saving time and money.
- Serrated stand-off has "soft-push" technology, meaning the standoff slides onto the stud easily and the serrations bite onto the stud for a secure bundle that saves time and money.
- Mounts onto #10 & 5mm studs.



IBS No.	Length	Strength	Width	Bundle	Qty
SM-6-50	6"	50 lbs	.18	1.4"	25

E
L
E
C
T
R
I
C
A
L

IBS, INCORPORATED

Nylon Tie Wraps Q04



Dual Clamp Cable Ties

- Designed to provide **parallel separation** between hoses, wires, cables and tubing to protect from abrasion.
- **Optional mounting hole** for securing bundles along
- **150 lb. tensile strength** ensures enough strength for heavy duty applications.
- Straps are **releasable** for increased serviceability.
- **Heat and UV stabilized** for longer life in applications outdoors and in higher temperatures



IBS No.	Length		MIN Tensile Strength		Width		MAX Bundle		Stud Diam.		Operating Temperature	Qty
	in.	(mm)	lbs	(N)	in.	(mm)	in.	(mm)	in.	(mm)		
141140	13.0	(330.20)	150 lbs	(667)	.50	(12.7)	1.3	(33.0)	1/4	M6	-40°F to +221° F -40°C to +105° C	50
141141	19.2	(487.68)	150 lbs	(667)	.50	(12.7)	2.28	(58.0)	1/4	M6	-40°F to +221° F -40°C to +105° C	50

Cable & Tubing Mounting Tie Wraps Assortment

IBS No. 727R • 7 Items • 255 Pcs

Packaged in a locking steel drawer for easy storage & organization



















IBS, Inc.
SPECIALTY PRODUCTS FOR MAINTENANCE & REPAIR
INDUSTRIALBOLT.COM © © © 800-678-1906

Mounting Tie Wraps

Assortment No. 727R

<p>SM-6-50 6' 50LB STUD MOUNT CABLE TIE WRAP BLACK</p>		
<p>PMB-8-50 8" 50LB BLACK PUSH MOUNT CABLE TIE WRAP</p>		
<p>BH-10-100 9-5/8" 100LB BUTTON HD TIE WRAP BLACK</p>		
<p>MH-7-50 7" 50LB NATURAL MOUNTING NYLON TIE WRAP</p>		
<p>MBH-7-50 7" 50LB BLACK NYLON MOUNTING TIE</p>		
<p>MH-14-120 14" 120LB NATURAL MOUNTING NYLON TIE WRAP</p>		
<p>141140 13IN DUAL CLAMP CABLE TIE BLACK</p>		

ELECTRICAL



IBS, INCORPORATED

Nylon Tie Wraps Q04

Cable Tie Gun (Q04)

3/32" - 3/16" Capacity



- **Capacity:** 3/32-Inch (2.4mm) to 3/16-Inch (4.8mm) wide and up to 1/16-Inch (1.58mm) thick — **works on 18 lb. to 50 lb. cable ties.**
- **Generates 18-50-Pounds** of tensile strength for a firm and snug bundle.
- **Flush cuts end of cable tie** for a clean and smooth end, eliminating the hazardous, sharp edges left behind with regular tie ends.
- **Adjustable bundling pressure**, allowing it to be used on various types of materials without damaging the material.
- Body is **constructed of high impact nylon and fiberglass** for strength and durability.
- Not compatible with stainless steel ties.

IBS No.	Description	Qty
141416	Cable Tie Gun	1

Mini Cable Tie Gun (T03)



- Convenient, pocket sized cable gun.
- Secures & cuts cable ties 18-50 lbs tensile strength.
- Provides a tighter installation of nylon cable ties vs. manual installation.
- Works with ties from 2.4 mm to 4.8 mm wide (0.094" to .0188") with tensile strength from 18 to 50 lbs.
- Twist cable gun to cut and trim off excess cable tie length.
- Contoured trigger and palm rest is easy on the hands.
- Heavy, long-wearing mechanism and handle.

IBS No.	Description	Qty
104487	Mini Cable Tie Gun	1

ALWAYS WEAR SAFETY GLASSES
DO NOT OVER-TIGHTEN

Cable Tie Bases

Bases are backed with foam adhesive. For use with 18, 30, and 50 lb. ties.



IBS No.	Size	Color	Qty
3M-6292	1 x 1	Ivory	25
3M-6294	3/4 x 3/4	Ivory	25
3M-6297	1 x 1	Black	25

Adjustable Cable & Hose Mounts

These clamps are highly resistant to chemicals, heat and impact. The ladder style fastening system allows them to be easily released and refastened. They are ideal for securing wires, cables, hose or bundles of various shapes and sizes. They can be mounted using either a screw or the adhesive backing and can be used over and over again. The three sizes accommodate sizes from #14 wire to 1" hose or cable.

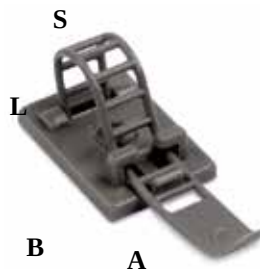

IBS No.	A	B	S	L	Use Range	Qty
L-013	.709	.984	.314	2.34	.118 - .500	25
L-018	.827	1.18	.472	3.12	.197 - .827	25
L-023	.984	1.38	.551	3.37	.275 - .984	25



Vinyl Dipped Hose Clamps

Clamps are furnished open. They are made of zinc plated steel with a 1/32" thick black vinyl plastic coating. Great for wire cable and all types of hose and tubing. Resistant to abrasion and chemicals. Temperature range -30°F to +350°F.



IBS No.	ID	Hole Size	Width	Qty
16540	1/4	1/4	1/2	25
16530	3/8	1/4	1/2	25
16531	1/2	1/4	1/2	25
16534	5/8	1/4	1/2	25
16532	3/4	1/4	1/2	25
16546	1	1/4	1/2	25
16541	5/16	3/8	3/4	25
16542	3/8	3/8	3/4	25
16543	1/2	3/8	3/4	25
16544	5/8	3/8	3/4	25
16545	3/4	3/8	3/4	25
16547	1	3/8	3/4	25
16533	1-1/4	3/8	3/4	25
16548	1-1/2	3/8	3/4	25
16550	2	3/8	3/4	25

Nylon Clamps

Durable nylon clamp. Ideal for channeling cable and wire. Operating temperature ranges from - 60°F to 275°F. Natural color



IBS No.	ID	Width	Screw Size	Qty
7118A	1/8	3/8	#10	25
7119A	3/16	3/8	#10	25
7120A	1/4	3/8	#10	25
7121A	5/16	3/8	#10	25
7122A	3/8	3/8	#10	25
7123A	7/16	3/8	#10	25
7124A	1/2	3/8	#10	25
7125A	9/16	1/2	#10	25
7126A	5/8	1/2	#10	25
7128A	3/4	1/2	#10	25
7129A	7/8	1/2	#10	25
7130A	1	1/2	#10	10

Rubber Insulated Clamps

Excellent for securing all types of wiring to the body or frame of all types of mobile equipment. Flexible neoprene cushion holds the lines firmly while protecting them from shock, abrasion and vibration.



ALUMINUM
1/4" Mounting Hole 1/2" Wide

IBS No.	ID	Stamp	Qty
7314A	1/4	4	25
7315A	3/8	6	25
7316A	1/2	8	25
7317A	5/8	10	25
7318A	3/4	12	25
7319A	7/8	14	10
7320A	1	16	10
7321A	1-1/8	18	10
7322A	1-1/4	20	10
7323A	1-3/8	22	10
7324A	1-1/2	24	10
7325A	1-5/8	26	10



CADMIUM PLATED STEEL
3/8" Mounting Hole 5/8" Wide

IBS No.	ID	Stamp	Qty
7514A	1/4	4	25
7515A	3/8	6	25
7516A	1/2	8	25
7517A	5/8	10	25
7518A	3/4	12	25
7519A	7/8	14	10
7520A	1	16	10
7522A	1-1/4	20	10
7524A	1-1/2	24	10
7525A	2	32	5
7527A	2-1/2	40	5

Chassis Clips

Spring steel, push on wire clips, finished in black enamel. Spring tension holds the clip in place while it secures the wires to panel surfaces.



IBS No.	Frame	Qty
7060A	3/16	50
7061A	1/4	50
7062A	3/8	50

ELECTRICAL



IBS, INCORPORATED

Assortments Z02

Vinyl Coated Clamps

IBS No. 802R • 10 Items • 197 Pcs
Packaged in a locking steel drawer for easy storage and organization



IBS, Inc.		Vinyl Coated Clamps	
SPECIALTY PRODUCTS FOR MAINTENANCE & SERVICE INDUSTRIALBOLT.COM • P.O. BOX 870-1906			
Assortment No. 802R			
16540 1/4ID 1/4 STUD VINYL COATED LOOM CLAMP	16531 1/2ID 1/4 STUD VINYL COATED LOOM CLAMP	16547 1ID 3/8 STUD VINYL COATED LOOM CLAMP	16548 1-1/2ID 3/8 STUD VINYL COATED LOOM CLAMP
16541 5/16ID 3/8STUD VINYL COATED LOOM CLAMP	16534 5/8ID 1/4 STUD VINYL COATED LOOM CLAMP		
16530 3/8ID 1/4 STUD VINYL COATED LOOM CLAMP	16545 3/4ID 3/8 STUD VINYL COATED LOOM CLAMP	16533 1-1/4ID 13/32 STUD VINYL COATED LOOM CLAMP	16550 2ID 3/8 STUD VINYL COATED LOOM CLAMP

Nylon Clamps

IBS No. 145R • 12 Items • 525 Pcs
Packaged in a locking steel drawer for easy storage and organization



IBS, Inc.		Nylon Clamps	
SPECIALTY PRODUCTS FOR MAINTENANCE & SERVICE INDUSTRIALBOLT.COM • P.O. BOX 870-1906			
Assortment No. 145R			
7118A 1/8 NYLON CLAMP	7119A 3/16 NYLON CLAMP	7120A 1/4 NYLON CLAMP	
7121A 5/16 NYLON CLAMP	7122A 3/8 NYLON CLAMP	7123A 7/16 NYLON CLAMP	
7124A 1/2 NYLON CLAMP	7125A 9/16 NYLON CLAMP	7126A 5/8 NYLON CLAMP	
7128A 3/4 NYLON CLAMP	7129A 7/8 NYLON CLAMP	7130A 1 NYLON CLAMP	

Nylon & Rubber Clamps

IBS No. 141R • 16 Items • 230 Pcs
Packaged in a locking steel drawer for easy storage and organization



IBS, Inc.		Rubber Insulated & Nylon Clamps	
SPECIALTY PRODUCTS FOR MAINTENANCE & SERVICE INDUSTRIALBOLT.COM • P.O. BOX 870-1906			
Assortment No. 141R			
7120A 1/4 NYLON CLAMP	7122A 3/8 NYLON CLAMP	7124A 1/2 NYLON CLAMP	7126A 5/8 NYLON CLAMP
7314A 1/4 INSULATED CLAMP 1/4 STUD STAMP #4	7315A 3/8 INSULATED CLAMP 1/4 STUD STAMP #6	7316A 1/2 INSULATED CLAMP 1/4 STUD STAMP #8	7318A 5/8 INSULATED CLAMP 1/4 STUD STAMP #12
7320A 1 INSULATED CLAMP 1/4 STUD STAMP #16	7322A 1-1/4 INSULATED CLAMP 1/4 STUD STAMP #20	7324A 1-1/2 INSULATED CLAMP 1/4 STUD STAMP #24	7314A 1/4 INSULATED CLAMP 3/8 STUD STAMP #4
7516A 1/2 INSULATED CLAMP 3/8 STUD STAMP #8	7518A 5/8 INSULATED CLAMP 3/8 STUD STAMP #12	7520A 1 INSULATED CLAMP 3/8 STUD STAMP #16	7522A 1-1/4 INSULATED CLAMP 3/8 STUD STAMP #18

Rubber Insulated Clamps 1/4" Mounting Hole

IBS No. 146R • 12 Items • 90 Pcs
Packaged in a locking steel drawer for easy storage and organization



IBS, Inc.		Rubber Insulated Clamps 1/4" Mounting Hole	
SPECIALTY PRODUCTS FOR MAINTENANCE & SERVICE INDUSTRIALBOLT.COM • P.O. BOX 870-1906			
Assortment No. 146R			
7314A 1/4 INSULATED CLAMP 1/4 STUD STAMP #4	7315A 3/8 INSULATED CLAMP 1/4 STUD STAMP #6	7316A 1/2 INSULATED CLAMP 1/4 STUD STAMP #8	
7317A 5/8 INSULATED CLAMP 1/4 STUD STAMP #10	7318A 3/4 INSULATED CLAMP 1/4 STUD STAMP #12	7319A 7/8 INSULATED CLAMP 1/4 STUD STAMP #14	
7320A 1 INSULATED CLAMP 1/4 STUD STAMP #16	7321A 1-1/8 INSULATED CLAMP 1/4 STUD STAMP #18	7322A 1-1/4 INSULATED CLAMP 1/4 STUD STAMP #20	
7323A 1-3/8 INSULATED CLAMP 1/4 STUD STAMP #22	7324A 1-1/2 INSULATED CLAMP 1/4 STUD STAMP #24	7325A 1-5/8 INSULATED CLAMP 1/4 STUD STAMP #26	

ELECTRICAL

IBS, INCORPORATED

Assortments Z02



Rubber Insulated Clamps 3/8" Mounting Hole

IBS No. 147R • 8 Items • 75 Pcs
Packaged in a locking steel drawer for easy storage and organization



IBS, Inc. QUALITY PRODUCTS FOR MAINTENANCE & REPAIR INDUSTRIALBOLT.COM • P.O. BOX 278 • 1906		Rubber Insulated Clamps 3/8" Mounting Hole	
Assortment No. 147R			
7514A 1/4 INSULATED CLAMP 3/8 STUD STAMP #4	7515A 3/8 INSULATED CLAMP 3/8 STUD STAMP #6	7516A 1/2 INSULATED CLAMP 3/8 STUD STAMP #8	
7517A 5/8 INSULATED CLAMP 3/8 STUD STAMP #10	7518A 3/4 INSULATED CLAMP 3/8 STUD STAMP #12	7519A 7/8 INSULATED CLAMP 3/8 STUD STAMP #14	
7520A 1 INSULATED CLAMP 3/8 STUD STAMP #16	7522A 1-1/4 INSULATED CLAMP 3/8 STUD STAMP #18		

Grommets (Q1C)

Grommets are made of flexible oil-resistant extra tough Styrene Butadien Copolymer Rubber. They have an operating temperature from -60°F to 180°F. Insert them into pre-drilled holes to protect wires against cutting and fraying.

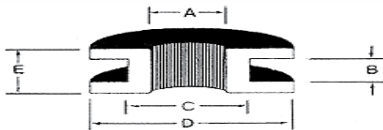

- A = O.D. of wire or wires
- B = Wall thickness
- C = I.D. of pre-drilled hole
- D = Grommet overall outside diameter
- E = Grommet thickness

IBS No.	Bore ID (A)	Groove Width (B)	Groove Diameter (C)	Outside Diameter (D)	Overall Thickness (E)	Qty
A-4410	5/32	1/16	1/4	3/8	3/16	25
A-4413	3/16	1/16	5/16	1/2	1/4	25
A-4414	3/16	3/32	9/32	3/8	5/16	25
A-16454	1/4	1/16	3/8	1/2	3/16	25
A-4419	5/16	1/16	7/16	9/16	3/16	25
A-4423	3/8	1/16	1/2	5/8	9/32	25
A-4428	1/2	3/32	3/4	31/32	9/32	25
A-16458	1/2	1/8	3/4	1	1/2	25
A-4430	1/2	1/4	13/16	1-1/16	1/2	25
A-4432	5/8	1/16	7/8	1-1/8	5/16	25
A-4433	3/4	1/16	15/16	1-1/8	1/4	25

Grommet Kit (Z02)

IBS No. 230R • 11 Items • 220 Pieces
Packaged in a locking steel drawer for easy storage and organization



IBS, Inc. QUALITY PRODUCTS FOR MAINTENANCE & REPAIR INDUSTRIALBOLT.COM • P.O. BOX 278 • 1906		Grommet Kit	
Assortment No. 230R			
A-4410 5/32ID X 1/16 GROOVE RUBBER	A-4413 3/16ID X 1/16 GROOVE RUBBER	A-4414 3/16ID X 3/32 GROOVE RUBBER	
A-16454 1/4ID X 1/16 GROOVE RUBBER	A-4419 5/16ID X 1/16 GROOVE RUBBER	A-4433 3/8ID X 1/16 GROOVE RUBBER	
A-4428 1/2ID X 3/32 GROOVE RUBBER	A-16458 1/2ID X 1/8 GROOVE RUBBER	A-4432 5/8ID X 1/16 GROOVE RUBBER	
A-4433 3/4ID X 1/16 GROOVE RUBBER	A-4430 1/2ID X 1/4 GROOVE RUBBER		

ELECTRICAL



IBS, INCORPORATED

Automotive Bulbs Q03

ELECTRICAL

	IBS No.	Volts	Function	Candle Power	Life (hrs)	Base	Pkg Qty
	B37	14	Instrument	.5 c.p.	2500	Wedge	10
	B53	14.4	Instrument	1 c.p.	1000	Min Bay	10
	B57	14	Instrument Side Marker	2 c.p.	500	Min Bay	10
	B67	13.5	Parking	4 c.p.	5000	S.C. Bayonet	10
	B73	14	Miniature Wedge	0.3 c.p.	15,000	Wedge	10
	B89	13	Courtesy Dome	6 c.p.	750	S.C. Bayonet	10
	B90	12	Parking Dome Instrument	6 c.p.	750	Mini Base	10
	B93	12	Instrument	15 c.p.	200	S.C. Bayonet	10
	B97	13.5	License Parking	4 c.p.	5000	S.C. Bayonet	10
	B168	14	Side Marker	3 c.p.	1500	Wedge	10
	B193	14	Instrument	2 c.p.	2500	Wedge	10
	B194	14	Side Marker	2 c.p.	2500	Wedge	10
	B199	13	Instrument	32 c.p.	1200	Mini Base	10
	B194NA	14	Side Marker Amber	1.5 c.p.	1500	Wedge	10
	B211-2	12	Courtesy Dome	12 c.p.	1000	Miniature Cap	10
	B561	13	Instrument	12 c.p.	1000	Rigid Loop Base	10
	B623	28	Courtesy Dome	6 c.p.	1000	S.C. Bayonet	10
	B624	28	HD Truck Instrument	6 c.p.	1000	D.C. Bayonet	10
	B904	14	Instrument	6 c.p.	1000	Wedge	10
	B906	13	Instrument	6 c.p.	1000	Wedge	10
	B912	12.8	Side Marker / Dome	12 c.p.	1000	Wedge	10
	B916	13.5	Side Marker / Dome	2 c.p.	10,000	Wedge	10
	B916NA	13	Side Marker / Amber	1.5 c.p.	10,000	Wedge	10























S.C. = SINGLE CONTACT D.C. = DOUBLE CONTACT MIN. = MINIATURE

IBS, INCORPORATED

Automotive Bulbs Q03



ELECTRICAL

	IBS No.	Volts	Function	Candle Power	Life (hrs)	Base	Pkg Qty
	B921	12.8	Side Marker / Dome	21 c.p.	500	Wedge	10
	B922	13.0	Instrument	15 c.p.	200	Wedge	10
	B1003	12.8	Side Marker / Dome	15 c.p.	200	S.C. Bayonet	10
	B1004	12.8	Dome / Courtesy	15 c.p.	200	D.C. Bayonet	10
	B1034	12.8	Stop & Turn	3.2 c.p.	200	D.C. Index	10
	B1073	12.8	Front Turn	32 c.p.	200	S.C. Bayonet	10
	B1076	12.8	Front Turn	32 c.p.	200	D.C. Bayonet	10
	B1141	12.8	Rear Turn	21 c.p.	1000	S.C. Bayonet	10
	B1142	12.8	General Purpose	21 c.p.	1000	D.C. Bayonet	10
	B1156	12.8	Front & Rear Turn	32 c.p.	1200	S.C. Bayonet HD	10
	B1157	12.8	Stop / Tail / Turn	32 c.p.	1200	D.C. Index HD	10
	B1157NA	12.8	Stop / Tail / Turn Amber	24 c.p.	1200	D.C. Index HD	10
	B1662	28	Construction Equipment	32 c.p.	400 to 1000	D.C. Bayonet	10
	B1683	28	Stop / Turn H.D. Truck	32 c.p.	500	S.C. Bayonet	10
	B1816	13.0	Instrument	3 c.p.	1000	Min. Bayonet	10
	B1891	14.0	Instrument	2 c.p.	7500	Bayonet	10
	B1893	14.0	Instrument	2 c.p.	7500	Min. Bayonet	10
	B1895	14.0	Instrument	2 c.p.	2000	Min. Bayonet	10
	B2057	12.8	Stop / Turn / Tail	32 c.p. 2 c.p.	1200 5000	D.C. Index	10
	B2057NA	12.8	Stop / Turn / Tail Amber	32 c.p. 2 c.p.	1200 5000	D.C. Index	10
	B3057	12.8	Stop / Turn / Tail	32 c.p. 2 c.p.	1200 5000	Wedge	10
	B3057NA	12.8	Stop / Turn / Tail	24c.p. 2 c.p.	1200 5000	Wedge	10
	B3156	12.0	Stop / Turn	32 c.p.	1200	Wedge	10

S.C. = SINGLE CONTACT D.C. = DOUBLE CONTACT MIN. = MINIATURE



IBS, INCORPORATED

Automotive Bulbs Q03

ELECTRICAL

	IBS No.	Volts	Function	Candle Power	Life (hrs)	Base	Pkg Qty
	B3157	12.0	Stop / Turn / Tail	32 c.p. 3 c.p.	1200 5000	Wedge	10
	B3157NA	12.0	Stop / Turn / Tail	24 c.p. 2.2 c.p.	1200 5000	Wedge	10
	B3457	14.0	Stop / Turn / Tail	40 c.p. 3 c.p.	400 5000	Plastic Wedge	10
	B3357NA	12.8	Stop / Turn / Tail	30 c.p.	400	Wedge	10
	B3457NA	14.0		2.2 c.p.	5000		
	B4157NA	12.0	Stop / Turn / Tail	32 c.p. 3 c.p.	1200 5000	Plastic Wedge	10
	B7443	12.0	Stop / Turn Tail	3.5 c.p.	500	Wedge	10
	B9004	12.8	Halogen Headlight Bulb	45 to 65 Watts	320 to 150	Halogen Capsule	2
	B9006	12.0	Halogen Headlight Bulb	55 Watts	450	Halogen Capsule	2
	B9007	12.8	Halogen Headlight Bulb	55 to 65 Watts	1100 to 150	Halogen Capsule	6
	PR-2	2.38	Flashlight	.8 c.p.	15	S.C. Min Flanged	10
	5457A	Instrument Panel Bulb Socket Holder Use with B194 & B194NA				1/2 Hole	5
	5458A	Instrument Panel Bulb Socket Holder Use with B194 & B194NA				5/8 Hole	5

S.C. = SINGLE CONTACT D.C. = DOUBLE CONTACT MIN. = MINIATURE

IBS, INCORPORATED

Assortments Z02



















Automotive Bulbs

IBS No. 327R • 16 Items • 160 Pcs

Packaged in a locking steel drawer for easy storage and organization



























IBS, Inc. SPECIALTY PRODUCTS FOR MAINTENANCE & REPAIR INDUSTRIALBOLT.COM © © © 800-678-1906		Automotive Bulbs			
Assortment No. 327R					
B194 #194 12V INSTRUMENT / SIDE 	B194NA 12V AMBER PARKING / SIDE 	B1893 12V HD AUTO INSTRUMENT LIGHT 	B1895 12V PARKING / SIDE MARKER 	B53 12V AUTO INSTRUMENT LIGHT 	
B57 12V AUTO INSTRUMENT LIGHT 	B1157 12V STOP - TURN - SIGNAL LIGHT 	B1157NA 12V STOP - TAIL - SIGNAL LIGHT 	B3157 12V STOP - TAIL - TURN LIGHT 	B3157NA 12V STOP - TAIL - TURN LIGHT 	
B2057 12V STOP - TAIL - TURN LIGHT 	B3057 12V STOP - TAIL - TURN LIGHT 	B1156 12V FRONT & REAR TURN LIGHT 	B3156 12V FRONT & REAR TURN LIGHT 		
B916 12V PARKING / SIDE MARKER 	B97 12V PARKING / LICENSE PLATE 				

12V Mini Auto Bulbs

IBS No. 722R • 24 Items • 186 Pcs

Packaged in a locking steel drawer for easy storage and organization



IBS, Inc. SPECIALTY PRODUCTS FOR MAINTENANCE & REPAIR INDUSTRIALBOLT.COM © © © 800-678-1906		12V Miniature Auto Bulb Assortment			
Assortment No. 722R					
B37 14V AUTO AIR COURTESY DOME IND AUTOMOTIVE BULB GLASS WEDGE 	B53 12V AUTO INSTRUMENT INDICATOR AUTOMOTIVE BULB MINI BASE 	B57 12V AUTO INSTRUMENT INDICATOR AUTOMOTIVE BULB MINI BASE 	B67 12V PARKING DOME INDICATOR AUTOMOTIVE BULB MINI BASE 	B89 12V PARKING DOME INSTRUMENT AUTOMOTIVE BULB MINI BASE 	B97 12V PARKING LICENSE PLATE AUTOMOTIVE BULB MINI BASE 
B194 12V INSTRUMENT SIDE MARKER AUTOMOTIVE BULB GLASS WEDGE 	B194NA 12V SIDE MARKER PARK AMBER AUTOMOTIVE BULB 	B906 12V SIDE MARKER DOME AUTOMOTIVE BULB 	B912 12V SIDE MARKER DOME AUTOMOTIVE BULB 	B916 12V PARKING SIDE MARKER AUTOMOTIVE BULB 	B921 12V SIDE MARKER DOME AUTOMOTIVE BULB 
B1156 12V FRONT REAR TURN LIGHT AUTOMOTIVE BULB 	B1157 12V STOP TURN SIGNAL LIGHT AUTOMOTIVE BULB 	B1157NA 12V STOP TAIL SIGNAL AMBER AUTOMOTIVE BULB 	B1893 14V HD INSTRUMENT MINI BASE AUTOMOTIVE BULB 	B1895 12V PARKING SIDE MARKER AUTOMOTIVE BULB 	B2057 12V STOP TAIL TURN LIGHT AUTOMOTIVE BULB 
B3057 12V STOP TAIL TURN LIGHT AUTOMOTIVE BULB PLASTIC WEDGE 	B3156 12V FRONT REAR TURN LIGHT AUTOMOTIVE BULB PLASTIC WEDGE 	B3157 12V STOP TAIL TURN LIGHT AUTOMOTIVE BULB PLASTIC WEDGE 	B3157NA 12V STOP TAIL TURN LIGHT AMBER AUTOMOTIVE BULB PLASTIC WEDGE 	S457A INSTRUMENT PANEL BULB SOCKET HOLDER 1/2 HOLE 	S458A INSTRUMENT PANEL BULB SOCKET HOLDER 5/8 HOLE 
				For Bulb B194 & B194NA	For Bulb B194 & B194NA



IBS, INCORPORATED

Automotive Electrical Q03

Glass Tube Fuses

Glass Fuses are widely used in electronic and electrical applications where proper fuse selection is critical to performance. Quality fuses provide safety and reliability by preventing short circuits and overloads that can cause fires and damage.

- For electronic/electrical applications, fuse must be rated at 125V or better.
- Voltage must match or exceed the fuse being replaced (125V household current; 12V for auto; 24V for heavy duty).
- Amperage must match that of the old fuse.



AGA
1/4 x 5/8

IBS No.	AMP	Volt	Qty
AGA1	1	125	5
AGA2	2	125	5
AGA3	3	125	5
AGA5	5	125	5
AGA10	10	32	5
AGA15	15	32	5
AGA20	20	32	5
AGA25	25	32	5
AGA30	30	32	5



AGX
1/4 x 1

IBS No.	AMP	Volt	Qty
AGX3	3	125	5
AGX15	15	32	5
AGX20	20	32	5
AGX25	25	32	5
AGX30	30	32	5



AGC
1/4 x 1-1/4

IBS No.	AMP	Volt	Qty
AGC1	1	250	5
AGC2	2	250	5
AGC2-1/2	2.5	250	5
AGC3	3	250	5
AGC4	4	250	5
AGC5	5	250	5
AGC6	6	250	5
AGC7-1/2	7.5	250	5
AGC8	8	250	5
AGC10	10	250	5
AGC15	15	32	5
AGC20	20	32	5
AGC25	25	32	5
AGC30	30	32	5
AGC35	35	32	5
AGC40	40	32	5



SFE

IBS No.	AMP	Size	Qty
SFE4	4	1/4 x 5/8	5
SFE6	6	1/4 x 3/4	5
SFE7-1/2	7.5	1/4 x 7/8	5
SFE9	9	1/4 x 1	5
SFE14	14	1/4 x 1-1/6	5
SFE20	20	1/4 x 1-1/4	5
SFE30	30	1/4 x 1-7/8	5



AGW

1/4 x 7/8 32 Volt

IBS No.	AMP	Qty
AGW1	1	5
AGW2-1/2	2.5	5
AGW4	4	5
AGW5	5	5
AGW6	6	5
AGW7-1/2	7.5	5
AGW15	15	5
AGW20	20	5
AGW30	30	5
AGW35	35	5



GBC

1/4 x 31/32 32 Volt

IBS No.	AMP	Qty
GBC2-1/2	2.5	5
GBC5	5	5
GBC8	8	5
GBC16	16	5
GBC25	25	5

FUSE PULLER



IBS No.	Description	Qty
FP-C	Dual purpose — pulls and installs both blade type and glass tube fuses. Single piece design made of durable plastic.	1

ELECTRICAL



ATR Micro Blade-Type Fuses

For single-circuit protection. A sub-miniature design that meets the need for more circuits to be protected while utilizing less space and its ability to cope with high temperatures in adverse environments makes it the recommended choice for newer vehicles.

Photo	IBS No.	AMP	Volts	Color	Qty	Photo	IBS No.	AMP	Volts	Color	Qty
	ATR5	5	32	Tan	5		ATR20	20	32	Yellow	5
	ATR7-1/2	7-1/2	32	Brown	5		ATR25	25	32	Clear	5
	ATR10	10	32	Red	5		ATR30	30	32	Green	5
	ATR15	15	32	Blue	5						

ATL Micro 3 Blade-Type Fuses

For dual-circuit protection in one fuse. It has 3 terminals and 2 fuse elements with a common center terminal. Its sub-miniature design meets the need for more circuits to be protected while utilizing less space and its ability to cope with high temperatures in adverse environments makes it a recommended choice for newer vehicles.

Photo	IBS No.	AMP	Volts	Color	Qty	Photo	IBS No.	AMP	Volts	Color	Qty
	ATL5	5	32	Tan	5		ATL10	10	32	Red	5
	ATL7-1/2	7-1/2	32	Brown	5		ATL15	15	32	Blue	5

ATR, ATL & ATM Low Profile Fuses Assortment (Z02)

IBS No. 822R • 18 Items • 160 Pcs

Packaged in a locking steel drawer for easy storage and organization

IBS, Inc. SPECIALTY PRODUCTS FOR MAINTENANCE & REPAIR INDUSTRIALBOLT.COM © 2013 800-678-1306		ATR, ATL & ATM Low-Profile Fuses			Assortment No. 822R
ATR5 5AMP MICRO2 FUSE 32V TAN FUSE 	ATR7-1/2 7-1/2AMP MICRO2 FUSE 32V BROWN FUSE 	ATR10 10AMP MICRO2 FUSE 32V RED FUSE 	ATR15 15AMP MICRO2 FUSE 32V BLUE FUSE 	ATR20 20AMP MICRO2 FUSE 32V YELLOW FUSE 	
ATR25 25AMP MICRO2 FUSE 32V CLEAR FUSE 	ATR30 30AMP MICRO2 FUSE 32V GREEN FUSE 	ATL5 5AMP MICRO3 FUSE 32V TAN FUSE 	ATL7-1/2 7-1/2AMP MICRO3 FUSE 32V BROWN FUSE 	ATL10 10AMP MICRO3 FUSE 32V RED FUSE 	
ATL15 15AMP MICRO3 FUSE 32V BLUE FUSE 	ATM5LP AUTO FUSE ATM LOW PROFILE 5AMP 	ATM7-1/2LP AUTO FUSE ATM LOW PROFILE 7-1/2AMP 	ATM10LP AUTO FUSE ATM LOW PROFILE 10AMP 	ATM15LP AUTO FUSE ATM LOW PROFILE 15AMP 	
ATM20LP AUTO FUSE ATM LOW PROFILE 20AMP 	ATM25LP AUTO FUSE ATM LOW PROFILE 25AMP 	ATM30LP AUTO FUSE ATM LOW PROFILE 30AMP 			



IBS, INCORPORATED

Automotive Electrical Q03

































Micro Fuses Assortment (Z02)

IBS No. 766R • 16 Items • 135 Pcs

Packaged in a locking steel drawer for easy storage and organization

































ELECTRICAL

IBS, Inc. SPECIALTY PRODUCTS FOR MAINTENANCE & REPAIR INDUSTRIALBOLT.COM 800-678-1906		Micro Fuses		
Assortment No. 766R				
ATR5 5AMP MICRO2 FUSE 32V TAN FUSE  	ATR7-1/2 7-1/2AMP MICRO2 FUSE 32V BROWN FUSE  	ATR10 10AMP MICRO2 FUSE 32V RED FUSE  	ATR15 15AMP MICRO2 FUSE 32V BLUE FUSE  	ATR20 20AMP MICRO2 FUSE 32V YELLOW FUSE  
ATR25 25AMP MICRO2 FUSE 32V CLEAR FUSE  	ATR30 30AMP MICRO2 FUSE 32V GREEN FUSE  	ATL5 5AMP MICRO3 FUSE 32V TAN FUSE  	ATL7-1/2 7-1/2AMP MICRO3 FUSE 32V BROWN FUSE  	ATL10 10AMP MICRO3 FUSE 32V RED FUSE  
ATL15 15AMP MICRO3 FUSE 32V BLUE FUSE  	FMM15 15AMP MCASE FUSE 32V GREY  	FMM20 20AMP MCASE FUSE 32V BLUE  	FMM25 25AMP MCASE FUSE 32V WHITE  	FMM30 30AMP MCASE FUSE 32V PINK  
FMM40 40AMP MCASE FUSE 32V GREEN  				

Micro Fuses Travel Tray Assortment (Z02)

IBS No. 803R • 11 Items • 55 Pcs

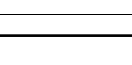
Packaged in a locking plastic travel tray for easy storage and organization

IBS, Inc. SPECIALTY PRODUCTS FOR MAINTENANCE & REPAIR INDUSTRIALBOLT.COM 800-678-1906		ATR Micro2 and ATL Micro3 Blade Fuses		
Assortment 803R				
ATR5 5AMP MICRO2 FUSE 32V TAN FUSE  	ATR10 10AMP MICRO2 FUSE 32V RED FUSE  	ATR20 20AMP MICRO2 FUSE 32V YELLOW FUSE  	ATR30 30AMP MICRO2 FUSE 32V GREEN FUSE  	ATL7-1/2 7-1/2AMP MICRO3 FUSE 32V BROWN FUSE  
ATR7-1/2 7-1/2AMP MICRO2 FUSE 32V BROWN FUSE  	ATR15 15AMP MICRO2 FUSE 32V BLUE FUSE  	ATR25 25AMP MICRO2 FUSE 32V CLEAR FUSE  	ATL5 5AMP MICRO3 FUSE 32V TAN FUSE  	ATL10 10AMP MICRO3 FUSE 32V RED FUSE  
				         



IBS, INCORPORATED

Automotive Electrical Q03



ATM Low Profile Blade-Type Fuses

Popular for late model vehicles, these compact, low-profile ATM fuses save space and feature an enclosed element for protection against shock and sparks. This is a low profile version of the ATM fuse using the same ratings and universal color-coding as ATM and ATC style fuses.

Photo	IBS No.	AMP	Volts	Color	Qty	Photo	IBS No.	AMP	Volts	Color	Qty
	ATM5LP	5	12	Tan	5		ATM20LP	20	12	Yellow	5
	ATM7-1/2LP	7-1/2	12	Brown	5		ATM25LP	25	12	Clear	5
	ATM10LP	10	12	Red	5		ATM30LP	30	12	Green	5
	ATM15LP	15	12	Light Blue	5						

ATM Low Profile Fuses Travel Tray(Z02)

IBS No. 721R • 7 Items • 35 Pcs

Packaged in a locking plastic tray for easy storage and organization



ATM Low Profile Fuses

Assortment No. 721R

 ATM5LP AUTO FUSE ATM LOW PROFILE 5AMP 	 ATM10LP AUTO FUSE ATM LOW PROFILE 10 AMP 	 ATM15LP AUTO FUSE ATM LOW PROFILE 15 AMP 	 ATM20LP AUTO FUSE ATM LOW PROFILE 20 AMP 	 ATM25LP AUTO FUSE ATM LOW PROFILE 25 AMP 	 ATM30LP AUTO FUSE ATM LOW PROFILE 30 AMP 
---	--	--	--	--	--



ELECTRICAL



IBS, INCORPORATED

Automotive Electrical Q03

ATM Blade-Type Fuses

Introduced in the early 90's, ATM fuses are quickly growing in popularity for late model OEM applications. ATM Fuses use the same universal color coding as ATC style. These fuses feature an enclosed element offering protection against shocks and sparks plus corrosion resistance for longer service life.

Photo	IBS No.	AMP	Volts	Color	Qty	Photo	IBS No.	AMP	Volts	Color	Qty
	ATM2	2	12	Gray	5		ATM10	10	12	Red	5
	ATM3	3	12	Violet	5		ATM15	15	12	Light Blue	5
	ATM4	4	12	Pink	5		ATM20	20	12	Yellow	5
	ATM5	5	12	Tan	5		ATM25	25	12	Clear	5
	ATM7-1/2	7.5	12	Brown	5		ATM30	30	12	Green	5

ATM Blade-Type Fuses Travel Tray

IBS No. 127R • 6 Items • 60 Pcs

Packaged in a locking plastic tray for easy storage and organization



ELECTRICAL



ATC Blade-Type Fuses

ATC Blade fuses were introduced in the late 1970s and are still widely used by automotive OEM's. Our ATC products use the industry's universal color coding to indicate the amperage, and feature an enclosed element — offering protection against shocks and sparks, plus corrosion resistance for a longer service life.

Photo	IBS No.	AMP	Volts	Color	Qty	Photo	IBS No.	AMP	Volts	Color	Qty
	ATC1	1	12	Black	5		ATC10	10	12	Red	5
	ATC2	2	12	Gray	5		ATC15	15	12	Light Blue	5
	ATC3	3	12	Violet	5		ATC20	20	12	Yellow	5
	ATC4	4	12	Pink	5		ATC25	25	12	Clear	5
	ATC5	5	12	Tan	5		ATC30	30	12	Green	5
	ATC7-1/2	7.5	12	Brown	5		ATC40	40	12	Orange	5

ATC Blade-Type Fuses Travel Tray (Z02)

IBS No. 792R • 8 Items • 40 Pcs

Packaged in a locking plastic tray for easy storage and organization



ELECTRICAL



IBS, INCORPORATED

Assortments Z02

MAXI Blade-Type Fuses

Maxi Fuses are used to protect circuits in the wiring harness — usually found under the hood, in a fuse panel, or supplementary panel near the battery. Primarily used in domestic cars, MAX fuses also have some applications in imported models. OEM applications currently range up to 60 amps; however, some aftermarket accessories (such as high-end stereos) require protection to 80 amps.

Photo	IBS No.	AMP	Volts	Color	Qty	Photo	IBS No.	AMP	Volts	Color	Qty
	MAX20	20	32	Yellow	1		MAX50	50	32	Red	1
	MAX25	25	32	Gray	1		MAX60	60	32	Blue	1
	MAX30	30	32	Green	1		MAX70	70	32	Tan	1
	MAX40	40	32	Orange	1		MAX80	80	32	Clear	1

MAXI Blade-Type Fuses Travel Tray (Z02)

IBS No. 128R • 7 Items • 31 Pcs

Packaged in a locking plastic tray for easy storage and organization

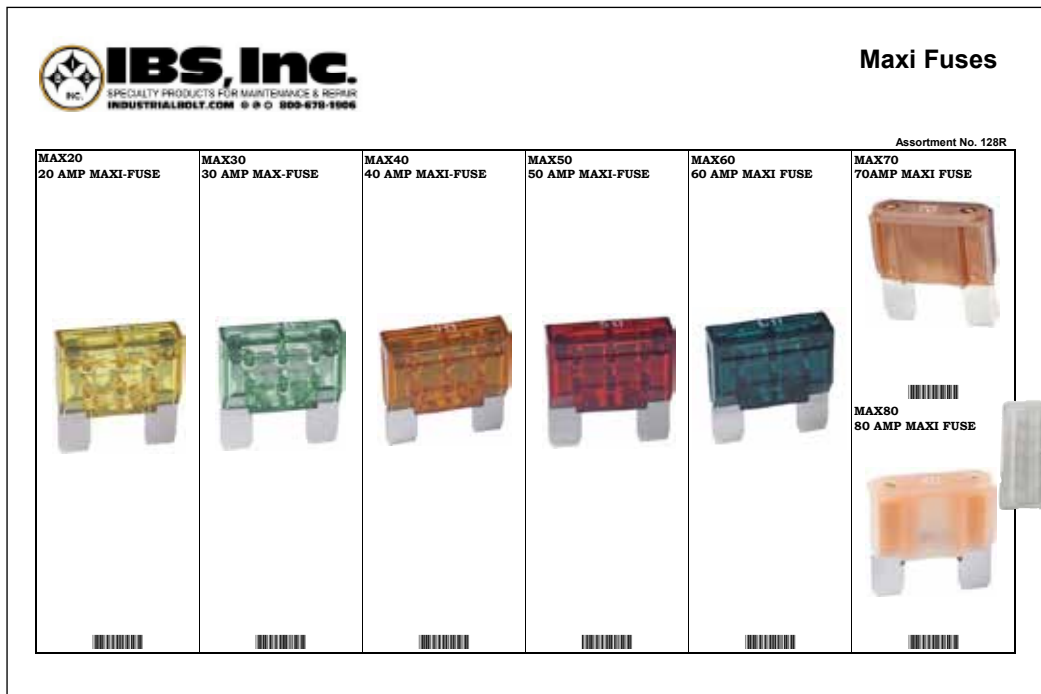

ELECTRICAL

IBS, INCORPORATED

Assortments Z08



Blade Fuses (Z02)

IBS No.720R • 29 Items • 127 Pcs

Packaged in a locking steel drawer for easy storage and organization



IBS, Inc. <small>SPECIALTY PRODUCTS FOR MAINTENANCE & REPAIR INDUSTRIALBOLT.COM • 800-678-1906</small>								Blade Fuses ATM, ATC and MAX	
								720R	
ATM2	ATM3	ATM4	ATM5	ATM7-1/2	ATM10	ATM15	ATM20		
ATM25	ATM30	ATC2	ATC3	ATC4	ATC5	ATC7-1/2	ATC10		
ATC15	ATC20	ATC25	ATC30	ATC40					
MAX20	MAX30	MAX40	MAX50	MAX60	MAX70	MAX80	FP-C FUSE PULLER		

Auto Electrical Fuses

IBS No. 290P • 37 Items • 235 Pcs

Packaged in a locking steel drawer for easy storage and organization



IBS, Inc. <small>SPECIALTY PRODUCTS FOR MAINTENANCE & REPAIR INDUSTRIALBOLT.COM • 800-678-1906</small>								Automotive Electrical Fuses	
								Assortment No. 290P	
AGA15 AUTO FUSE	AGA20 AUTO FUSE	AGA30 AUTO FUSE		SFE7-1/2 AUTO FUSE GLASS TUBE	SFE14 AUTO FUSE GLASS TUBE	SFE20 AUTO FUSE GLASS TUBE	SFE30 AUTO FUSE GLASS TUBE		
AGC1 AUTO FUSE	AGC4 AUTO FUSE	AGC7-1/2 AUTO FUSE	AGC10 AUTO FUSE	AGC15 AUTO FUSE	AGC20 AUTO FUSE	AGC25 AUTO FUSE	AGC30 AUTO FUSE		
ATC5 AUTO FUSE	ATC10 AUTO FUSE	ATC15 AUTO FUSE	ATC20 AUTO FUSE	ATC25 AUTO FUSE	ATC30 AUTO FUSE	EL-13 HVY DUTY 3 PRONG TRUCK FLASHER FLASHER			
ATM5 AUTO FUSE	ATM10 AUTO FUSE	ATM15 AUTO FUSE	ATM20 AUTO FUSE	ATM25 AUTO FUSE	ATM30 AUTO FUSE	EL-13 HVY DUTY 3 PRONG TRUCK FLASHER FLASHER			
19518 GLASS TUBE WATER-PROOF IN-LINE		19513 BLADE TYPE WATER-PROOF IN-LINE FUSE HLDR				FP-C FUSE PULLER			
0690T 12 VOLT TESTER		1588A 3/8 TEST CLIP JAW		MAX20 20 AMP MAXI FUSE YELLOW		MAX30 30 AMP MAXI FUSE GREEN		MAX40 40 AMP MAXI FUSE ORANGE	

ELECTRICAL



IBS, INCORPORATED

Automotive Electrical Q03

LED Smart Fuses

Blade Type Fuses with LED Indicator

The integrated LED on the top of the fuse glows brightly if the fuse is blown. This eliminates the guesswork and speeds the replacement of the blown fuse. The color-coded fuses instantly let you know the right amperage of the fuse to be replaced. These fuses snap into place without the use of special tools and provide easy identification of blown fuses in hard-to-reach locations.

ATM BLADE-TYPE

Photo	IBS No.	AMP	Volts	Color	Qty	Photo	IBS No.	AMP	Volts	Color	Qty
	139212	5	32	Amber	5		139216	20	32	Yellow	5
	139214	10	32	Red	5		139217	25	32	Clear	5
	139215	15	32	Blue	5		139218	30	32	Green	5

ATO/ATC BLADE-TYPE

Photo	IBS No.	AMP	Volts	Color	Qty	Photo	IBS No.	AMP	Volts	Color	Qty
	139222	5	32	Amber	5		139226	20	32	Yellow	5
	139224	10	32	Red	5		139227	25	32	Clear	5
	139225	15	32	Blue	5		139228	30	32	Green	5

MAXI BLADE-TYPE

Photo	IBS No.	AMP	Volts	Color	Qty	Photo	IBS No.	AMP	Volts	Color	Qty
	139411	20	12	Yellow	1		139414	50	12	Red	1
	139412	30	12	Green	1		139415	60	12	Blue	1
	139413	40	12	Orange	1		139416	80	12	Clear	1

ELECTRICAL

IBS, INCORPORATED

Assortments Z02



LED Smart Fuses

IBS No. 364R • 22 Items • 76 Pcs
 Packaged in a locking steel drawer for easy storage and organization



IBS Inc. INDUSTRIALBLADE.COM © D © 800-878-1808						LED Smart Fuses
Assortment No. 364R						
139212 ATM 5 Amp Mini / Amber	139214 ATM 10 Amp Mini / Red	139215 ATM 15 Amp Mini / Blue	139216 ATM 20 Amp Mini / Yellow	139217 ATM 25 Amp Mini / Clear	139447 ATM Mini In-Line Clear Cover Fuseholder	
139218 ATM 30 Amp Mini / Green		139222 ATC 5 Amp Amber	139224 ATC 10 Amp Red	139225 ATC 15 Amp Blue	139450 ATC In-Line Clear Cover Fuseholder	
139226 ATC 20 Amp Yellow	139227 ATC 25 Amp Clear	139228 ATC 30 Amp Green		139411 MAXI 20 Amp Yellow	139425 MAXI In-Line Fuseholder with Cover	
139412 MAXI 30 Amp Green	139413 MAXI 40 Amp Amber	139414 MAXI 50 Amp Red	139415 MAXI 60 Amp Blue	139416 MAXI 80 Amp Clear		

ATM LED Smart Fuses

IBS No. 360R • 6 Items • 36 Pcs
 Packaged in a clear plastic box for easy storage and organization



IBS Inc. INDUSTRIALBLADE.COM © D © 800-878-1808						ATM Mini Blade LED Smart Fuses
Assortment No. 360R						
139212 5AMP ATM STYLE LED SMART FUSE	139214 10AMP ATM STYLE LED SMART FUSE	139215 15AMP ATM STYLE LED SMART FUSE	139216 20AMP ATM STYLE LED SMART FUSE	139217 25AMP ATM STYLE LED SMART FUSE	139218 30AMP ATM STYLE SMART FUSE	

ATC LED Smart Fuses

IBS No. 361R • 6 Items • 42 Pcs
 Packaged in a clear plastic box for easy storage and organization



IBS Inc. INDUSTRIALBLADE.COM © D © 800-878-1808						ATC Standard Blade LED Smart Fuses
Assortment No. 361R						
139222 5AMP ATC STYLE LED SMART FUSE	139224 10AMP ATC STYLE LED SMART FUSE	139225 15AMP ATC STYLE LED SMART FUSE	139226 20AMP ATC STYLE LED SMART FUSE	139227 25AMP ATC STYLE LED SMART FUSE	139228 30AMP ATC STYLE LED SMART FUSE	

MAXI Blade LED Smart Fuses

IBS No. 362R • 6 Items • 18 Pcs
 Packaged in a clear plastic box for easy storage and organization



IBS Inc. INDUSTRIALBLADE.COM © D © 800-878-1808						Maxi Blade LED Smart Fuses
Assortment No. 362R						
139411 20AMP MAXI STYLE LED SMART FUSE	139412 30AMP MAXI STYLE LED SMART FUSE	139413 40AMP MAXI STYLE LED SMART FUSE	139414 50AMP MAXI STYLE LED SMART FUSE	139415 60AMP MAXI STYLE LED SMART FUSE	139416 80AMP MAXI STYLE LED SMART FUSE	

ELECTRICAL



IBS, INCORPORATED

Automotive Electrical Q03

Cartridge Fuses

Developed to meet the growing OEM demand for smaller components, these fuses offer high amp protection in compact packages. Most are available in amp ratings from 15 to 60A.

FMX FUSES

Photo	IBS No.	AMP	Color	Qty	Photo	IBS No.	AMP	Color	Qty
	FMX-20	20	Blue	2		FMX-40	40	Green	2
	FMX-25	25	White	2		FMX-50	50	Red	2
	FMX-30	30	Pink	2		FMX-60	60	Yellow	2

FMX LOW-PROFILE FUSES

Photo	IBS No.	AMP	Color	Qty	Photo	IBS No.	AMP	Color	Qty
	FMX-20LP	20	Blue	2		FMX-40LP	40	Green	2
	FMX-25LP	25	White	2		FMX-50LP	50	Red	2
	FMX-30LP	30	Pink	2		FMX-60LP	60	Yellow	2

FMM FUSES

Photo	IBS No.	AMP	Color	Qty	Photo	IBS No.	AMP	Color	Qty
	FMM15	15	Grey	1		FMM30	30	Pink	1
	FMM20	20	Blue	1		FMM40	40	Green	1
	FMM25	25	White	1					

FMS FUSES

Photo	IBS No.	AMP	Color	Qty	Photo	IBS No.	AMP	Color	Qty
	FMS-15	15	Gray	1		FMS-40	40	Green	1
	FMS-20	20	Blue	1		FMS-50	50	Red	1
	FMS-25	25	White	1		FMS-60	60	Yellow	1
	FMS-30	30	Pink	1					

ELECTRICAL

IBS, INCORPORATED

Assortments Z02



Micro Cartridge Fuses

IBS No. 823R • 24 Items • 48 Pcs

Packaged in a locking steel drawer for easy storage and organization

IBS, Inc. <small>SPECIALTY PRODUCTS FOR MAINTENANCE & REPAIR INDUSTRIALBOLT.COM © © © 800-678-1906</small>		Thread Locker, Anti-Seize & Dielectric Grease			
Assortment 832R					
74242 MEDIUM STRENGTH THREADLOCKER GEL BLUE 35ML	74262 HIGH STRENGTH THREADLOCKER GEL RED 35ML	74151 ANTI SEIZE GEL ALUMINUM 35ML	74152 ANTI SEIZE GEL COPPER 35ML	74159 PTFE PIPE SEALANT GEL 35ML	74160 DIELECTRIC GREASE PUMP 35ML



ELECTRICAL

FMX Fuse Assortment (Z02)

IBS No. 851R • 6 Items • 12 Pcs

Packaged in a locking steel drawer for easy storage and organization

IBS, Inc. <small>SPECIALTY PRODUCTS FOR MAINTENANCE & REPAIR INDUSTRIALBOLT.COM © © © 800-678-1906</small>		FMX Fuses			
Assortment 851R					
FMX-20 20AMP BLUE MAXI FUSE J-CASE	FMX-25 25AMP WHITE MAXI FUSE J-CASE	FMX-30 30AMP PINK MAXI FUSE J-CASE	FMX-40 40AMP GREEN MAXI FUSE J-CASE	FMX-60 60AMP RED MAXI FUSE J-CASE	FMX-60 60AMP YELLOW MAXI FUSE J-CASE



FMX Low Profile Fuse Assortment (Z02)

IBS No. 852R • 6 Items • 12 Pcs

Packaged in a locking steel drawer for easy storage and organization

IBS, Inc. <small>SPECIALTY PRODUCTS FOR MAINTENANCE & REPAIR INDUSTRIALBOLT.COM © © © 800-678-1906</small>		FMX Low Profile Fuses			
Assortment 852R					
FMX-20LP 20AMP BLUE LP MAXI FUSE J-CASE LP - LOW	FMX-25LP 25AMP WHITE LP MAXI FUSE J-CASE LP - LOW	FMX-30LP 30AMP PINK LP MAXI FUSE J-CASE LP - LOW	FMX-40LP 40AMP GREEN LP MAXI FUSE J-CASE LP - LOW	FMX-60LP 60AMP RED LP MAXI FUSE J-CASE LP - LOW	FMX-60LP 60AMP YELLOW LP MAXI FUSE J-CASE LP - LOW





IBS, INCORPORATED

Automotive Electrical Q03

FMM Fuse Assortment (Z02)

IBS No. 853R • 5 Items • 30 Pcs

Packaged in a locking steel drawer for easy storage and organization

FMS Fuse Assortment (Z02)

IBS No. 854R • 7 Items • 35 Pcs

Packaged in a locking steel drawer for easy storage and organization

ELECTRICAL

IBS, Inc.
DESIGNER OF PRODUCTS FOR THE MARINE, TRUCKING & AVIATION INDUSTRIES

FMM Fuses

Assortment 853R

FMM15 15AMP MCASE FUSE 32V GRAY	FMM20 20AMP MCASE FUSE 32V BLUE	FMM25 25AMP MCASE FUSE 32V WHITE	FMM30 30AMP MCASE FUSE 32V PINK	FMM40 40AMP MCASE FUSE 32V GREEN



IBS, Inc.
DESIGNER OF PRODUCTS FOR THE MARINE, TRUCKING & AVIATION INDUSTRIES

FMS Fuses

Assortment 854R

FMS15 15 AMP MCASE FUSE 32V GRAY SLOTTED	FMS20 20 AMP MCASE FUSE 32V BLUE SLOTTED	FMS25 25 AMP MCASE FUSE 32V WHITE SLOTTED	FMS30 30 AMP MCASE FUSE 32V PINK SLOTTED	FMS40 40 AMP MCASE FUSE 32V GREEN SLOTTED	FMS50 50 AMP MCASE FUSE 32V RED SLOTTED

FMS60
60 AMP MCASE FUSE
32V YELLOW SLOTTED



IBS, INCORPORATED

Automotive Electrical Q03



FUSE HOLDERS

Photo	IBS No.	Description	GA	Fuse Size	Mount	Electrical Connection	Qty
	139433	ATR Micro 2 Add-A-Line Fuse Holder	16	20 amp	—	—	1
	139434	ATR Micro 2 Add-A-Line Fuse Holder	16	15 amp	—	—	1
	139430	ATM Low Profile Add-A-Line Fuse Holder Adds an additional circuit to an existing circuit	16	Prim Max 25A Sec Max 15A	—	—	1
	139421	ATM Fuse Holder & Cover for ATM Mini Blade	12	30 amp	In-line	4" Lead Wires	1
	139431	ATM Fuse Holder & Cover for ATM Mini Blade	16	20 amp	In-line	4" Lead Wires	1
	139420	ATM Add-A-Line Fuse Holder Adds an additional circuit to an existing circuit	16	Prim Max 25A Sec Max 15A	—	—	1
	139428	ATM Fuse Blade Tap 3/16 Push-On Blade	—	—	—	—	25
	139447	ATM Fuse Holder Clear Covered For use with LED Smart Fuses	14	30 amp	In-line	Lead Wires	1
	139422	ATC Fuse Holder & Cover Black Inline	12	30 amp	In-line	Lead Wires	1
	139423	ATC Fuse Holder for ATC Blade	12	30 amp	In-line	4" Lead Wires	1
	139432	ATC Fuse Holder for ATC Blade	16	20 amp	In-line	4" Lead Wires	1
	139424	ATC Fuse Holder Clear Cover Cover Only for ATC Fuse Holder	—	—	Cover for 139423	—	1
	139427	ATC / ATO Add-A-Line Fuse Holder Adds an additional circuit to an existing circuit	16	Prim Max 25A Sec Max 15A	—	—	1
	139429	ATC / ATO Fuse Blade Tap 1/4 Push-On Blade	—	—	—	—	25
	19513	ATC Waterproof Fuse Holder Complete assembly with body & cap	12	30 amps	In-Line	Lead Wires	1
	972	ATC Self-Strip Fuse Holder	NA	0-20 amps	In-Line	Quick Connect 18-14 GA	25
	139450	Clear Covered ATC Fuse Holder For use with LED Smart Fuses	12	30 amp	In-Line	4" Lead Wires	1
	139425	MAXI Fuse Holder & Cover For MAXI Blade	6	60 amp	In-Line	Lead Wires	1
	0905A	Glass Tube Fuse Holder	16	0-15 amps	In-Line	Lead Wires	15
	0906A	Glass Tube Fuse Holder	12	0-30 amps	In-Line	Lead Wires	15
	HFA	Waterproof Fuse Holder	14		In-Line	Lead Wires	1
	19518	Waterproof Glass Tube Fuse Holder	12	1/4 x 1-1/4	In-Line	Lead Wires	1
	HKP	Panel Mount Glass Tube Fuse Holder 250/20A Rating	NA	1/4 x 1-1/4	Panel	Solder Term	1
	139435	J Case Fuse Holder	8	0-60AMPS	In-Line	Red GXL Wire 4" Leads	1

ELECTRICAL



IBS, INCORPORATED

Automotive Fuse Holders & Accessories















IBS No. 723R • 15 Items • 75 Pcs

Packaged in a locking steel drawer for easy storage & organization



Automotive Fuse Holders & Accessories

Assortment No. 723R

<p>139433 ATR MICRO2 ADD A LINE FUSE HOLDER 20AMP 16GA</p> 	<p>139431 ATM 16GA IN LINE FUSE HOLDER 32V 20AMP</p> 	<p>139422 12GA ATC FUSE HOLDER & COVER BLACK IN LINE</p> 	<p>19513 BLADE TYPE WATER-PROOF IN-LINE FUSE HLDR</p> 
<p>139434 ATR MICRO2 INLINE FUSE HOLDER 15AMP 16GA 5IN LEADS</p> 	<p>139420 ATM ADD A LINE FUSE HOLDER 32V 2 FUSE 30A</p> 	<p>139427 ATC ADD A LINE FUSE HOLDER TAP 2 ATO/ATC MAX 30A</p> 	<p>139425 MAXI IN-LINE FUSE HOLDER WITH COVER 32V 60A</p> 
<p>139430 ATM LOW PROFILE ADD-A-LINE FUSE HOLDER</p> 	<p>139447 14GA ATM FUSE HOLDER & COVER CLEAR MINI</p> 	<p>139450 12GA ATC FUSE HOLDER & COVER CLEAR</p> 	<p>139435 FMX INLINE FUSE HOLDER 60AMP 8GA 4IN LEADS 58V</p> 
<p>139421 12GA ATM IN-LINE FUSE HOLDER W/ COVER 32V 30A</p> 	<p>139428 ATM FUSE BLADE TAP .187 TAB</p> 	<p>139429 ATC FUSE BLADE TAP .250 TAB</p> 	



ELECTRICAL

IBS, INCORPORATED

Automotive Electrical Q03



Blade-Type Circuit Breakers

Blade style circuit breakers offer interchangeability with commonly used blade-style fuses, such as ATC, ATM and MAXI. Available in several reset modes that correspond to SAE categories: SAE Type 1 (automatic reset), SAE Type II (modified reset) and SAE Type III (manual reset). Blade-style circuit breakers utilize carefully designed and manufactured snap-acting thermal elements with precious metal electrical units.

MINI BREAKERS

MINI BREAKERS match the blade footprint of ATM fuses. Ultra-thin, to fit in tight spaces, they're the smallest automotive circuit breakers on the market.

Photo	IBS No.	Description	AMP	Volts	Color	Qty
	CB212-10 CB212-15 CB212-20 CB212-25 CB212-30	<ul style="list-style-type: none"> Smallest circuit breaker available Type II, non-cycling, modified reset - remains open as long as power is available or until load is removed. Designed to match ATM fuse footprint. For 12V electrical systems 	10 15 20 25 30	12	Silver	1
	CB233-05 CB233-7-1/2 CB233-10 CB233-15 CB233-20 CB233-25 CB233-30	<ul style="list-style-type: none"> Type III manual reset Remains in the OFF position until button or lever is manually reset. For 12V electrical systems Matches ATM fuse footprint 	5 10 15 20 25 30	12	Tan Brown Red Blue Yellow White Green	1

MAXI-STYLE BREAKERS

MAXI BREAKERS are identical in size to MAXI-style fuses. The only breakers on the market to match the MAXI's footprint and body dimensions. CB1911 can be used to replace MAXI fuses in any application.

Photo	IBS No.	Description	AMP	Volts	Color	Qty
	CB1911-10 CB1911-20 CB1911-30	Brass colored Type 1 breaker with MAXI fuse footprint. 12 Volt.	10 20 30	12	Brass	1
	<p>Type 1 — Automatic Reset Circuit breaker automatically resets after opening. If the fault still exists, the breaker will continue to cycle between ON and OFF positions until the overload is corrected. These devices are sometimes called "cycling breakers."</p> <p>Type II — Modified Reset The circuit breaker will remain "tripped" (in the OFF position) as long as there's power to the circuit, or by turning off the ignition switch. These devices are sometimes called "non-cycling breakers."</p>					

ELECTRICAL



IBS, INCORPORATED

Automotive Electrical Q03

ELECTRICAL

Blade-Type Circuit Breakers

ATC-STYLE BREAKERS

ATC STYLE BREAKERS are designed to fit ATC style fuse panels. These ATC breakers are the thinnest available in the aftermarket and comply with SAE standard J553.

Photo	IBS No.	Description	AMP	Volts	Color	Qty
	CB221-10	• Type I automatic reset	10	12	Brass	1
	CB221-15	• Auto reset until load is corrected	15			
	CB221-20	• 12V electrical systems	20			
	CB221-30	• Matches ATO / ATC fuses	30			
	CCB-25	Replaces OE Part 4527053. Available in 25 AMP Type I	25	12	Silver	1
	CB222-10	<ul style="list-style-type: none"> • Type II non-cycling modified reset, remains open as long as power is available, or until load is removed. • For 12V electrical systems • Matches ATO / ATC fuses 	10	12	Silver	1
	CB222-15		15			
	CB222-20		20			
	CB222-30		30			
	CB223-10	<ul style="list-style-type: none"> • Type III ATC Circuit Breakers • 24V electrical systems • Complies with SAE J553. • Matches ATO / ATC fuses 	10	24	Silver	1
	CB223-15		15			
	CB223-20		20			
	CB223-25		25			
	CB223-30		30			
	CB227-10	<ul style="list-style-type: none"> • Type III ATC Low Profile Circuit Breakers • Complies with SAE J553 and SAE J1171 for ignition protection. 	10	12	Red Blue Yellow White Green	1
	CB227-15		15			
	CB227-20		20			
	CB227-25		25			
	CB227-30		30			
	CBB-30	Type II circuit breakers can be used to replace ATC fuses 12 volt. Available in 30 AMP.	30	12	Silver	1
	FCB-20	Replaces OE part D9AB-14526-BA. Available in 20 AMP Type II.	20	12	Silver	1

UCB BREAKERS

UCB BREAKERS feature "snap off" universal blades which can easily be sized to fit applications where fuseblock spacing is tight, or the fuse terminal is recessed.

Photo	IBS No.	Description	AMP	Volts	Color	Qty
	UCB-10	Universal Type 1 Circuit Breaker 12 Volt	10	12	Red	1
	UCB-15	Universal Type 1 Circuit Breaker 12 Volt	15	12	Blue	1
	UCB-20	Universal Type 1 Circuit Breaker 12 Volt	20	12	Gold	1
	UCB-25	Universal Type 1 Circuit Breaker 12 Volt	25	12	Silver	1
	UCB-30	Universal Type 1 Circuit Breaker 12 Volt	30	12	Green	1



Stud Mount Circuit Breakers

Photo	IBS No.	Description	AMP	Volts	Color	Qty
	CBC-15B	Heavy Duty Type 1 - 12 Volt breaker. Two 10-32 threaded studs and brass plated battery terminal.	15	12	Brass	1
	CBC-20B		20			
	CBC-30B		30			
	CBC-40B		40			
	CBC-50B		50			
Type 1 — Automatic Reset Circuit breaker automatically resets after opening. If the fault still exists, the breaker will continue to cycle between ON and OFF positions until the overload is corrected. These devices are sometimes called "cycling breakers."						
	CBF-20	Type II - 12 volt breaker. CBF circuit breakers can be used to replace glass fuses in 1/4 x 1-1/4 fuse blocks.	20	12	Black	1
	CBF-30		30			
	CBS-10	Standard duty Type II - 12 Volt breaker. Two 10-32 threaded studs.	10	12	Silver	1
	CBS-15		15			
	CBS-20		20			
	CBS-25		25			
	CBS-30		30			
Type II — Modified Reset The circuit breaker will remain "tripped" (in the OFF position) as long as there's power to the circuit, or by turning off the ignition switch. These devices are sometimes called "non-cycling breakers."						

Stud-Mount Fuses

AMG fuses are for high current applications on select late model vehicles and available in ratings from 80 to 500 A. Use with the HMEG fuse block.



IBS No.	AMP	Qty	IBS No.	AMP	Qty
AMG60	60	1	AMG200	200	1
AMG80	80	1	AMG250	250	1
AMG100	100	1	AMG300	300	1
AMG125	125	1	AMG400	400	1
AMG150	150	1	HMEG	FUSE BLOCK	



Fusible Links

Used primarily in Japanese designed car models to provide wiring harness protection. Available in the following styles:



FEMALE FUSIBLE LINKS

IBS No.	AMP	Qty
FLF-20	20	1
FLF-30	30	1
FLF-40	40	1
FLF-50	50	1
FLF-60	60	1



MALE FUSIBLE LINKS

IBS No.	AMP	Qty
FLM-30	30	1
FLM-60	60	1
FLM-80	80	1



IBS, INCORPORATED

Assortments Z02

Automotive Circuit Breakers ATM & ATC Assortment

IBS No. 824R • 31 Items — 46 Pieces

Packaged in a locking steel drawer for easy storage & organization

IBS, Inc. SPECIALTY PRODUCTS FOR MAINTENANCE & REPAIR INDUSTRIALBOLT.COM 800-678-1906		Automotive Circuit Breakers ATM & ATC						Assortment No. 824R
CB212-10 10AMP ATM MINI CIRC BREAKER II	CB212-15 15AMP ATM MINI CIRCUIT BREAKER II	CB212-20 20AMP ATM MINI CIRC BREAKER II	CB212-25 25AMP ATM MINI CIRC BREAKER II	CB212-30 30AMP ATM MINI CIRC BREAKER II	CB233-05 5AMP ATM MINI RESET CB TYPE III	CB233-10 10AMP ATM MINI RESET CB TYPE III	CB233-15 15AMP ATM MINI RESET CB TYPE III	
CB233-20 20AMP ATM MINI RESET CB TYPE III	CB233-25 25AMP ATM MINI RESET CB TYPE III	CB233-30 30AMP ATM MINI RESET CB TYPE III	CB221-10 10AMP ATC CIRCUIT BREAKER TYPE 1	CB221-15 15AMP ATC CIRCUIT BREAKER TYPE 1	CB221-20 20AMP ATC CIRC BREAKER TYPE 1	CB221-25 25AMP ATC CIRCUIT BREAKER TYPE 1	CB221-30 30AMP ATC CIRCUIT BREAKER TYPE 1	
CB223-10 10AMP ATC 24V RESET CB TYPE III	CB223-15 15AMP ATC 24V RESET CB TYPE III	CB223-20 20AMP ATC 24V RESET CB TYPE III	CB223-25 25AMP ATC 24V RESET CB TYPE III	CB223-30 30AMP ATC 24V RESET CB TYPE III	CB227-10 10AMP ATC RESET CB TYPE III RED	CB227-15 15AMP ATC RESET CB TYPE III BLUE	CB227-20 20AMP ATC RESET CB TYPE III YELLOW	
CB227-25 25AMP ATC RESET CB TYPE III WHITE	CB227-30 30AMP ATC RESET CB TYPE III GREEN	UCB-10 10AMP ATM CB SNAP OFF BLADES	UCB-15 15AMP ATM CB SNAP OFF BLADES	UCB-20 20AMP ATM CB SNAP OFF BLADES	UCB-25 25AMP ATM CB SNAP OFF BLADES	UCB-30 30AMP ATM CB SNAP OFF BLADES		

Heavy Duty Truck Circuit Breakers Assortment

IBS No. 340R • 26 Items — 26 Pieces

Packaged in a locking steel drawer for easy storage & organization



IBS, Inc. SPECIALTY PRODUCTS FOR MAINTENANCE & REPAIR INDUSTRIALBOLT.COM 800-678-1906		Heavy Duty Truck Circuit Breakers						Assortment No. 340R
CB1911-10 10AMP MAXI BREAKER	CB1911-20 20AMP MAXI BREAKER	CB1911-30 30AMP MAXI BREAKER	CB212-10 10AMP ATM MINI CIRCUIT BREAKER	CB212-15 15AMP ATM MINI CIRCUIT BREAKER	CB212-20 20AMP ATM MINI CIRCUIT BREAKER	CB212-25 25AMP ATM MINI CIRCUIT BREAKER		
CBC-15B 15AMP STUD MOUNTED	CBC-20B 20AMP STUD MOUNTED	CBC-30B 30AMP STUD MOUNTED	CBC-40B 40AMP STUD MOUNTED	CBC-50B 50AMP STUD MOUNTED	CCB-25 25AMP CIRCUIT BREAKER OE#	FCB-20 20AMP CIRCUIT BREAKER OE#		
UCB-10 10AMP UNIVERSAL CIRCUIT	UCB-15 15AMP UNIVERSAL CIRCUIT	UCB-20 20AMP UNIVERSAL CIRCUIT	UCB-25 25AMP UNIVERSAL CIRCUIT	UCB-30 30AMP UNIVERSAL CIRCUIT	CBF-20 20AMP CIRCUIT BREAKER-GLASS	CBF-30 30AMP CIRCUIT BREAKER-GLASS		
CB221-10 10AMP ATC BLADE BREAKER TYPE 1	CB221-15 15AMP ATC BLADE BREAKER TYPE 1	CB221-20 20AMP ATC BLADE BREAKER TYPE 1	CB221-30 30AMP ATC BLADE BREAKER TYPE 1	CBB-30 30AMP ATC STYLE CIRCUIT				

ELECTRICAL

IBS, INCORPORATED

Automotive Electrical Q03



Electronic Signal Flashers — Extended Life

Tridon's Extended Life Super Duty Electronic Signal Flashers last up to 9 times longer than conventional thermal flashers. Designed for use with trucks, buses, RVs, taxis and passenger cars, they are built tough with heavy duty components throughout.



- Thick Palladium Contact provides longer life under heavy loads.
- Faster Start Time — Only .75 seconds to first flash as compared to 1.5 seconds with ordinary flashers.
- Dependability — Has few moving parts and a thermoplastic cover to help protect the flashers from temperature extremes (-25°F to 145°F).
- Highly audible — Clear distinctive audible signal can be heard in any traffic situation.
- Highly durable — Average life is 800 hours at 10 lamps. Exceeds DOT and SAE specifications J590 and J945 by a factor of 2:1.
- Highly Efficient — Incorporates a positive electromechanical relay in contrast to thermal flashers to achieve the most constant regulated timing of any flasher.

IBS No.	Description	Load	Max. Watts	FPM	Durability (Cycling)	Qty
EL-12	12V - 2 Pin	1 - 10	250	70-100	200 hrs	1
EL-13	12V - 3 Pin	1 - 10	250	70-100	200 hrs	1
EL-13A	12V - 3 Pin Alt*	1 - 6	150	85	150 hrs	1

• EL-13A is an alternating flasher that alternates from side to side.

Heavy Duty Flashers



FLASHERS

DOT Approved • Variable Load

IBS No.	Volts	No. of Terminals	No. of Bulbs	MAX Amps	Qty
EL550	20	3	1 - 6	12.8	1
EL552	30	2	2 - 6	12.8	1

5 Prong Relay



- The best solution for full voltage applicable to head lamps, fog horns, motors for fans, window lifters, air conditioners, heated rear windows, etc.
- Engineered to deliver superior performance over a long life.
- Permissible ambient temperature - 40°C to 85°C.
- Mechanical life — no load = 1,000,000 cycles at +85°C.
- 12 volt; 30/50 amp.

IBS No.	Description	Qty
73984	12V 30/50 AMP 5 Prong Relay	1

ELECTRICAL



IBS, INCORPORATED

Automotive Electrical Q03

ELECTRICAL

Test Clips

- Cadmium plated steel.
- Full meshing teeth.

IBS No.	Jaw Opening	AMP Rating	Qty
1587A	3/16	—	25
1588A	3/8	—	25
0836A	3/4	25	5
0837A	1-1/16	50	5



Spiral Wrap



Expandable spiral cut polyethylene wrap. Wires can enter and break out at any point. Retains strength under repeated flexing. Operating temperature -105°F to 215°F.

IBS No.	Color	I.D.	Length	Qty
5119A	Natural	3/16	100 ft.	1
5120A	Natural	1/4	100 ft.	1
5121A	Natural	3/8	100 ft.	1
5122A	Natural	1/2	100 ft.	1
5123A	Natural	3/4	100 ft.	1
5124A	Natural	1	100 ft.	1
6219A	Black	3/16	100 ft.	1
6220A	Black	1/4	100 ft.	1
6221A	Black	3/8	100 ft.	1
6222A	Black	1/2	100 ft.	1

Fabric Loom



IBS No.	Size	Length	Qty
8212S	3/16	50 ft.	1
8213S	1/4	50 ft.	1
8214S	3/8	50 ft.	1
8215S	1/2	50 ft.	1
8216S	5/8	50 ft.	1
8218S	1	50 ft.	1

Tough, flexible loom. Smooth inside for easy wire insertion. Saturated with an asphalt compound for moisture proofing. Non-metallic material protects against short circuits and undesirable noise.

Convuluted Tubing (Split Loom)



IBS No.	Size	Length	Qty
5140A	1/4	50 ft.	1
5141A	3/8	50 ft.	1
5142A	1/2	50 ft.	1
5143A	3/4	50 ft.	1

Flexible black polyethylene tubing for holding wires in position and protecting them from abrasion. Tubing is split for easy wire insertion. Operating temperature -30°F to +200°F.

Split Braided Sleeving



IBS No.	Size	Length	Qty
19040	1/4	75 ft.	1
19041	3/8	75 ft.	1
19042	1/2	50 ft.	1
19043	3/4	50 ft.	1
19044	1	25 ft.	1

Made from semi-rigid 10 mil Polyethylene braid; its lightweight, quiet & flexible. A lateral split accommodates a wide variety of bundling needs. 25% edge overlap allows for coverage around inline plugs, connectors & splices. Add and remove wires without disassembly. Retains shape & rigidity from -94°F to 257°F.

Split Tubing & Sleeve Installation Tool

- Insert your wire bundle into the shank.
- Slide the tool along the split in the sleeving.
- Watch as the tool desposits the wires and closes the split.



IBS No.	Size	Qty
19045	1/4 - 3/8	1
19046	1/2	1
19047	3/4	1
19048	1	1

IBS, INCORPORATED

Miscellaneous Items Q3F



ELECTRICAL

Procell Alkaline Batteries

- Provides 1.5 volts, 6 volts and 9 volts.
- Good low temperature characteristics.
- Recommended for heavy drain items which get frequent use i.e. flashlights, calculators, lanterns, etc.
- Good long-lasting power source.



IBS No.	Cell	Pkg Qty	Case Qty
EN95	D	12	72
EN93	C	12	72
EN96	AAAA	2	12
EN92	AAA	12	144
EN91	AA	12	144
EN22	9V	6	72
EN29	6V lantern	1	12
LR41	1.5V	1	—
LR44	LED Safety Glasses	1	6
CR2032	3V	1	6
CR123A	3V	1	12

Rough Service Light Bulbs

Supreme Special Filament



- Designed exclusively for the automotive industry.
- Bulbs have 9 filament supports plus a thicker, shorter stem for the supports. This provides twice the resistance to the type of shock that destroys filaments in common bulbs.
- Guaranteed long-life bulbs.
- Brass based eliminates "freezing" or corroding in the socket — allowing easier removal.
- Made in the USA.

ROUGH SERVICE BULBS

TOUGH COAT BULBS

IBS No.	Watts	Pkg Qty	IBS No.	Watts	Pkg Qty
75A/RS	75	4	75A/STC	75	4
100A/RS	100	4	100A/STC	100	4

Procell Alkaline Batteries Assortment (Z02)

IBS No. 395R • 5 Items • 46 Pcs

Packaged in a locking steel drawer for easy storage & organization

Procell Alkaline Batteries Assortment (Z02)

IBS No. 746R • 5 Items • 30 Pcs

Packaged in a locking plastic tray for easy storage & organization

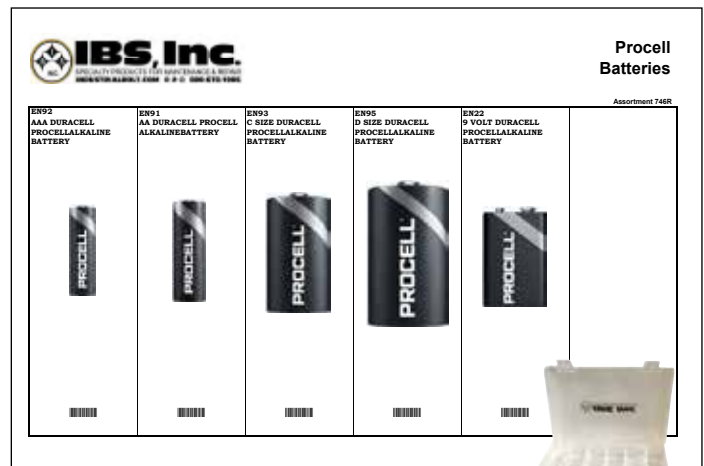
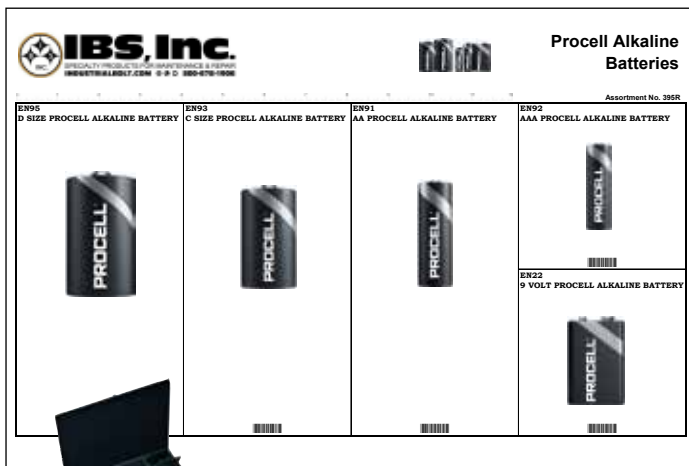



IBS, INCORPORATED

Miscellaneous Items Q3F

ELECTRICAL

Professional 50' Quad Tap Retractable Reel 15 AMP



IBS No.	Case Qty	Case Wt.	Cord Length	Cord GA	Cord Jacket
136111	1	17 lbs	50 ft	12/3	SJTW

- 40% larger cord reel with smooth glide rewind.
- Polarized plug with four 15 AMP grounded receptacles.
- Resettable 15 AMP circuit breaker.
- LED power status light.
- Mounting brackets included.
- Heavy Duty 12/3 Cord.

Pro 1200 Lumen LED Worklight On 50' Retractable Metal Reel



IBS No.	Case Qty	Case Wt.	Cord Length	Cord GA	Cord Jacket
136641	1	8 lbs	50 ft	18/2	SVTW
136642	Replacement Head (136641 & 137681)				



- All LED construction and 18/2 SVTW cord make this a lightweight and virtually indestructible work light ideal for most work environments.
- Worklight has two brightness settings of 1,200 and 600 Lumens make this light perfect for lighting up a large area.
- Two built-in magnets with a detachable magnetic hook, one at the balance point in the middle of the handle, and the other at the tip of the light offer hands free options for convenience and added value.
- Octagonal shaped handle keeps the floodlight aimed in the correct direction when set on its side for extra convenience and safety.
- Includes a mounting bracket allowing the reel to be attached to the wall or ceiling for safety and convenience.
- 1 year limited warranty.

Pro 1200 Lumen LED Worklight With 25' Cord



IBS No.	Case Qty	Case Wt.	Cord Length	Cord GA	Cord Jacket
137681	1	1 lbs	25 ft	18/2	SJTW

- All LED construction and 18/2 SVTW cord make this a lightweight and virtually indestructible work light ideal for most work environments.
- Worklight has two brightness settings of 1,200 and 600 Lumens make this light perfect for lighting up a large area.
- Two built-in magnets with a detachable magnetic hook, one at the balance point in the middle of the handle, and the other at the tip of the light offer hands free options for convenience and added value.
- Octagonal shaped handle keeps the floodlight aimed in the correct direction when set on its side for extra convenience and safety.
- 25' cord is the perfect length for easy storage and yet reaches places where needed.
- 1 year limited warranty.

Under-Hood Worklight



IBS No.	Pkg Qty	Description
138516	1	Under-Hood Worklight

- Adjustable carrier system extends to 77 inches to fit across most automotive hoods.
- Can be used with or without the carrier.
- Magnetic ends for easy, multi-positioning housing.
- Hanger hooks add mounting versatility.
- Housing is chemical, moisture and impact-resistant to stand up to the toughest situations and applications.
- Dual power mode runs up to 4-1/2 hours on full power, or 8-1/2 hours on half power.
- 120 premium LEDs deliver up to 35,000 hour life.
- Includes internal battery pack with AC and car chargers.
- 51" L x 4" W x 7" H.
- Lumens: 1200 at full-power, 650 at half-power



Omni 3K Worklight

3000 Lumens



The OMNI 3K is the ultimate omni-directional work light and once you've used it, you will wonder how you ever lived without it! It is powerful, yet compact measuring just 7" x 5-3/8".

- **3000 lumens** of light with a dual COB output.
- **Fully Rotatable** — the dual panels rotate 360°, directing light to any angle.
- **Handle** — **single handle that swivels**, making it easier to adjust and direct.
- **Mounting** — **Strong magnetic handle** attaches to any metal surface or **universal 1/4-20 female thread** allows for mounting to standard tri-pods.
- **Water Resistant** — IPX4 Water Resistant means it can resist a sustained, low-pressure water jet spray.
- **Rechargeable** — Fast USB-C charging.
- **Red Light Mode** — Helps eyes to quickly adjust and adapt for night vision.
- **Back-Up Battery** — use to charge USB devices with a 4,000mAh power bank.

IBS No.	Description
136647	Omni 3K Worklight

LED Work Light

- Single light fixture producing 2,200 lumens of light from a single 20W LED.
- Multi-angle tilt and swivel fixture design.
- Multi-fin heat-sink keeps light cool to the touch .
- LED is rated at 50,000 hours of life.
- Comfort grip padded handle.
- Single sealed push button switch.
- Tempered glass lens.
- 6 ft SVT, 18/3 cord with grounded plug.
- Powder coated for long wear.
- Impact, chemical and water resistant design.



IBS No.	Description
201711	LED Work Light

Omni 2K Worklight

2000 Lumens

The OMNI 2K is an omni-directional work light that boasts a powerful 2,000 lumen, Dual C•O•B output with a red hazard feature. The OMNI features magnetic handles to provide convenient carry, magnetic attachment or a sturdy base for hands-free light. Each C•O•B panel and magnetic handle rotate to give light everywhere that you need it, and the dimmer controls give you the right amount of light. Completely rechargeable, the OMNI 2K also features a power bank to charge your USB powered devices.

- **USB-C rechargeable.**
- **4,000mAh** power bank
- **Rotating magnetic handles**
- **Rotating C•O•B panels**
- **Water and impact resistant**
- **Non-slip rubber coating**
- **Battery charging indicator**
- **Rear-positioned ON/OFF button** and 2 buttons for adjustable brightness
- **USB-C charging cable** included
- **Powered by internal rechargeable battery** (Recharge time: 2 - 8 hours).
- **Folded size:** (H) 4.8" x (W) 6.25" x (D) 1.875", 0.5 lbs.



IBS No.	Description
202013	Omni 2K Worklight

Rechargeable LED Area Worklight WITH MAGNETIC BASE

- High/Low brightness modes.
- 1000 lumens on high.
- 500 lumens on low.
- Constructed from lightweight 6061-T6 aluminum.
- Multi-angle tilt and swivel fixture design.
- Powerful magnetic base for hands-free operation.
- Multi-fin heat sink keeps light cool to the touch.
- LED is rated at 50,000 hours of life.
- Adjustable comfort-grip handle.
- Single sealed push button switch.
- Tempered glass lens.
- Powder coated for long wear.
- IP-X7 rated waterproof
- Impact and chemical resistant design
- Meets requirements of NFPA-1971-8.6 (2013)
- Rechargeable Li-ion
- Includes AC & DC power supplies
- 1 Year limited warranty.



IBS No.	Description
136645	Rechargeable LED Area Worklight with Magnetic Base

ELECTRICAL



IBS, INCORPORATED

Miscellaneous Items Q3F

ELECTRICAL

Dual Function Flood / Flashlight with Magnet & Stand

- 150 lumens flashlight
- 120 lumens floodlight
- 270 lumens dual-light
- 4 AA batteries included
- Multifunction — Flashlight / Floodlight / Dual-Light.
- Oval shape and non-slip textured body for easier and safer handling.



IBS No.	Pkg Qty	Description
138515	1	Dual Function Flood/Flashlight with Magnet & Stand

BAT Flashlight

- 1,000 Lumen High-Power LED
- 4 AA batteries included
- Aircraft grade anodized aluminum; water and impact resistant
- Rubberized protective sleeve
- Ergonomic textured handle



IBS No.	Pkg Qty	Description
138523	1	The BAT Flashlight

Joey Flashlight XL

- 300 lumens worklight
- 520 lumens flashlight
- AA batteries included
- Multifunction Flashlight , Worklight & Signal Light.
- Magnetic Base
- 3 Lighting Modes
 - High Intensity Flashlight
 - Magnetic Worklight
 - Red Signal Light Magnetic Base
- Magnetic Base



IBS No.	Pkg Qty	Description
138528	1	IBS Joey Flashlight XL

LED Dual-Light Headlamp

- 55 lumens spotlight
- 40 lumens floodlight
- 80 lumens dual-light
- 3 AAA batteries included
- Adjustable elastic headband with rubberized strips keep the headlamp in place
- Headlamp tilts for optimum light positioning
- IP-X7 rated waterproof



IBS No.	Pkg Qty	Description
138524	1	LED Dual-Light Headlamp

Cordless Rechargeable Multi-Purpose LED Work / Flood Light

With AC & DC Chargers & Magnet Hooks



IBS No.	Pkg Qty	Description
138511	1	Cordless Rechargeable Multipurpose LED Work Flood Light
138511LENS	1	Replacement Lens

- Dual-brightness Floodlight – 600/225 Lumens for optimum battery control and life.
- Three heavy-duty integrated magnets, one at the tip of the light, one at the mid-point of the body and one built into the base for multiple hands-free uses.
- Magnetic hook can be attached to either the body or tip magnets and can be rotated 360 degrees for even more hands-free versatility.
- Octagonal body design keeps the light in place when laid on its side for extra convenience and safety.
- Flat bottom design allows the light to stand up and directed to where the light is needed for added value.
- User-replaceable lens saves money on replacing the entire light when the lens is damaged.
- Water resistant makes this light perfect for indoor and outdoor use.
- Impact & chemical resistant means the light is durable enough to use in most work environments.
- Powered by integrated Lithium-ion battery for optimum life with no “battery memory” for easy charging.
- Includes both AC & DC power supply/charger means this light can be used in the shop or on the road.
- 1 Year Limited Warranty

Intrinsically Safe LED Flood/Flashlight

- 55 lumens spotlight
- 40 lumens floodlight
- 80 lumens dual-light
- 3 AAA batteries included
- Adjustable elastic headband with rubberized strips keep the headlamp in place
- Headlamp tilts for optimum light positioning
- IP-X7 rated waterproof



IBS No.	Pkg Qty	Description
138520	1	Intrinsically Safe LED Dual Function Flood/Flashlight



Fluorescent Work Light Replacement Bulbs



26W FLUORESCENT WORKLIGHT REPLACEMENT BULB

IBS No.	Case Qty	Case Wt.	Watts	Used With
121017	12	1.6 lbs	26W	IBS No. 136022 IBS No. 136155



13W FLUORESCENT WORKLIGHT REPLACEMENT BULB

IBS No.	Case Qty	Case Wt.	Watts	Used With
121016	12	1.5 lbs	13W	IBS No. 121012 IBS No. 137689



12V 13W FLUORESCENT WORKLIGHT REPLACEMENT BULB

IBS No.	Case Qty	Case Wt.	Watts	Used With
123151	12	1.5 lbs	13W	IBS No. 123149 IBS No. 137686

Halogen Work Light Replacement Bulb



500W HALOGEN WORKLIGHT BULB REPLACEMENTS

IBS No.	Case Qty.	Case Wt. (lbs)	Used With	Package
136104	12	1.5	IBS No. 136106	Clamshell

Accessories



MALE REPLACEMENT PLUG - 3 WIRE

IBS No.	Case Qty.	Case Wt. (lbs)	Description
137687	6	3	Male Plug



FEMALE REPLACEMENT PLUG - 3 WIRE

IBS No.	Case Qty.	Case Wt. (lbs)	Description
137688	6	3	Female Plug

Replacement Parts



REPLACEMENT PARTS 26W FLUORESCENT LI



IBS No.	Description	Pkg	Use with
137916	Replacement Head	Box	136155
138000	Replacement Lens	Box	136155



REPLACEMENT TUBE ASSEMBLY FOR 13W WORKLIGHTS



IBS No.	Size	Pkg	Use with
137998	13W	Bag	121012, 123149, 137686



REPLACEMENT DOUBLE HOOKS FOR TUBE LIGHTS

IBS No.	Description	Pkg	Use with
138001	Double Hooks	Box	13W Lights

ELECTRICAL



IBS, INCORPORATED

Miscellaneous Items Q3F

IBS DualGlow Extension Cords



LIGHTED ENDS
INDICATE
WHEN POWER
IS PRESENT



IBS DUALGLOW EXTENSION CORDS 25', 50' & 100 FT SINGLE TAP

IBS No.	Cord Length	Cord GA	Cord Jacket
141478	25 ft	12/3	SJTW 15A Rated
139641	50 ft	12/3	SJTW 15A Rated
139642	100 ft	12/3	SJTW 15A Rated

- Contractor Grade / Professional Quality
- Features CGM (Continuous Current and Ground Monitoring, which means each female plug has a green neon light that indicates there is ground continuity — an OSHA Safety Requirement.
- Molded stress collar prevents the cord from pulling out providing additional strength and longevity.
- Male plugs feature an amber neon light indicating the presence of power in the cords and outlet.
- Patented 2-way, non-slip finger grips makes connecting and disconnecting easier and faster saving time and preventing faulty connections.
- Superior cold weather jacket provides flexibility in freezing temperatures as low as -40°F, making unraveling and storing cords easier and faster.
- High visibility improves safety and productivity, helps prevent on the job injuries — saving time and money.
- 12/3 ga wire provides maximum connectivity that can handle large, industrial tools without overheating or tripping breakers.

IBS Pro-Lock Extension Cords



PRO-LOCK DUALGLOW MOLDED EXTENSION CORDS 50' & 100 FT SINGLE TAP

IBS No.	Cord Length	Cord GA	Cord Jacket / Color
139646	50 ft	10/3	SJTW / Blue 15A Rated
139647	100 ft	10/3	SJTW / Blue 15A Rated
139643	50 ft	12/3	SJTW / Orange 15A Rated
139644	100 ft	12/3	SJTW / Green 15A Rated
139645		10/3 to 12/3	Extension Cord End Only

- Contractor Grade / Professional Quality
- Features the exclusive Pro-Lock Connector - Click to Lock up to 80lbs tensile strength means ends won't pull apart.
- Safely locks your cords together, keeps equipment connected without dangerous cord tying, which provides for a safer and more productive work environment, saving time and money.
- With the quick release collar, cords with Standard 3 prong 15A-125V ends won't pull apart and are easy to connect and disconnect when needed for a safe and continuous connection.
- Both male and female plugs feature power check lighted ends indicating the presence of power in the cords and outlet for safer operation.
- Superior cold weather jacket provides flexibility in freezing temperatures as low as -40°F, making unraveling and storing cords easier and faster.
- High visibility improves safety and productivity, helps prevent on the job injuries — saving time and money.
- 10/3 and 12/3 ga wire provides maximum connectivity that can handle large, industrial tools without overheating or tripping breakers.
- **UL, cUL listed.**

E
L
E
C
T
R
I
C
A
L

IBS, INCORPORATED

Miscellaneous Items Q3F



GFCI INLINE TRIPLE TAP CORD

IBS No.	Type	Cord Length	Cord GA	Cord Jacket
141438	GFCI	12/3	SJTW 15A Rated	SJTW 15A Rated

- Contractor Grade / Professional Quality
- Fast acting circuit breaker designed to shut-off electrical power in the event of a ground fault in as little as 1/4 of one second.
- Oil-resistant jacket remains flexible even at sub-zero temperatures.
- Ideal for use during maintenance, remodeling, or repair of buildings, structures or equipment.
- High visibility yellow for added safety.
- Lighted receptacle for added safety.
- Grounded receptacle.
- Meets OSHA Regulation 1910.304.

Lighted Adapters



LIGHTED PLUG ADAPTER SINGLE TAP

IBS No.	Pkg Qty	Pkg	Description
141436	5	Bag	3 to 2 Lighted Adapter

- Converts a single 15 AMP 125 Volt grounded outlet.
- Lighted end indicates power is on.
- 1875 Watt.
- UL approved.



LIGHTED PLUG ADAPTER TRIPLE TAP

IBS No.	Pkg Qty	Pkg	Description
141437	2	Bag	Lighted Adapter Triple Outlet

- Converts a single 15 AMP 125 Volt grounded outlet to three 15A, 125V U-ground outlets.
- Lighted end indicates power is on.
- 1875 Watt.
- UL approved.

Silver Bearing Solder (S05)

Low Temperature

The highest strength, lowest melting point silver solder alloy for stainless steel, dissimilar metals and chrome plating.

- 500% stronger than common solders.
- Superior corrosion resistance with bright, shiny deposits.



IBS No.	Description	Qty
46001	1 oz. syringe	1
46000	9 ft. x 1/16 coil, acid core 96.5% tin - 3.5% silver	1

Silvabrite 100® Solder (S05)

Lead Free

Silvabrite 100® was developed to meet market demands for a safe and easy-to-use solder for drinking water systems and other applications. Silvabrite 100® is a lead-free and antimony free, non-toxic solder which contains the same metals used in dental fillings.

Features/Benefits:

- Lead-free composition — safe for use in drinking water systems.
- Low melting point — excellent penetration, flow and wetting out action means fast application and less waste.
- Wide melting range — 440°F to 500°F for maximum control.
- Excellent "capping off" ability.
- Tin, copper and silver composition — provides higher shear, creep and tensile strength than 50/50 for strong corrosion resistant leak-tight joints.



IBS No.	Description	Qty
460013	1/8 X 1# spool	1

ELECTRICAL



60/40 Rosin Core Solder Most Popular Solder for Electrical Applications

- Rosin flux is completely non-corrosive and non-conductive.
- Quick acting rosin flux dissolves surface oxides for good wetting and strong connections.
- Meets Fed. Spec. QQ-S-571
- 60% Tin / 40% Lead.
- Made in the USA



IBS No.	Description	Qty
46044	.031 x 1# Spool	1
46045	.062 x 1# Spool	1
46046	.093 x 1# Spool	1

NOKORODE® Regular Paste Flux

Will not freeze or decompose. No odor. Lead free. Recommended for use on all solder alloys including 95/5 and all lead-free solders. Meets specification O-F-506, Type 1A and A-A-51145, MIL-F04995-2.



IBS No.	Description	Qty
460014	1.7 oz. jar	1

60/40 Rosin Core Solder & Excalibur Torch Assts (Z08)

Each size of 60/40 Rosin Core Solder combined with an Excalibur Torch.

Excalibur Torch

A self-igniting and cordless soldering iron, hot air blower, and butane torch complete in 1 great tool! The Piezo electric ignition system provides a quick start-up in any mode.

Includes 5 interchangeable tips: 1 Reflector, 1 Hot Air Blower, 1 Hot Knife, 1 3.5mm Chisel Tip, and 1 3mm Diagonal Tip. One tube of solder is also included.

Includes a handy, impact-resistant travelling case for complete mobility, moves easily from the workshop to the field.



IBS No.	Description
690P	.031 x 1# Spool with Excalibur Torch
691P	.062 x 1# Spool with Excalibur Torch
692P	.093 x 1# Spool with Excalibur Torch
141060	Excalibur Torch Set

Butane Refill



- Universal tip fuels most leading butane lighters.
- Low in non-volatile contaminants which can cause burner valve to clog, affecting flame height and function.

WARNING: USE THIS PRODUCT ONLY AS DIRECTED ON THE PACKAGE. INTENTIONAL MISUSE BY DELIBERATELY CONCENTRATING & INHALING THE CONTENTS MAY BE HARMFUL OR FATAL. KEEP OUT OF REACH OF CHILDREN.

IBS No.	Description	Qty
95007	Butane Refill	1



Solder Combo Assortments (Z08)

One of our bestselling assortments just got better! Solder combos available in any combination — 2 of our Low Temperature Silver Bearing Solder in coil, paste, or one of each and includes the new **MICROTORCH BUTANE TORCH!**

MICROTORCH BUTANE TORCH

IBS No. 125738 (T03)

Retail Value \$39.95

At only 5-1/4" high with a 2500°F flame, the **MICROTORCH** is ideal for all types of professional use. Refillable with premium grade Butane Refill. (IBS No. 95007 - T03).

Low temperature silver bearing soft solder — the highest strength, lowest melting point silver solder alloy for stainless steel, dissimilar metals and chrome plating, available in coil, or syringe paste.

- 500% stronger than common solders.
- Superior corrosion resistance with bright, shiny deposits



IBS No.	Description	Qty
418P	1 Solder Paste Syringe 1 Torch	1 Coil 1 Butane Refill
425P	2 Solder Paste Syringes 1 Torch	1 Butane Refill
426P	2 Solder Coils 1 Torch	1 Butane Refill

Microtorch Butane Torch



At only 5-1/4" high with a 2500° flame, the **Microtorch** is ideal for all types of professional use. Refillable with premium grade butane (IBS No. 95007). A versatile and handy addition to any professional workshop.

IBS No.	Description	Qty
125738	Microtorch Butane Torch	1

Industrial Butane Torch

Powerful, portable, refillable and anti-flare with a flame temperature of over 2500°F, the Industrial Butane Torch is ideal for automotive, plumbing, and professional repair shop use.



Functions & Uses:

- Lead Gutters
- Toughen Metal
- Stripping Paint
- Automotive Repair
- Sweat Ftgs & Joints
- Lay or Remove Tiles
- Loose Bolts
- Plumbing
- Dry Cements

IBS No.	Description	Qty
125739	Industrial Butane Torch	1

Dual Temp Electric Heat Gun

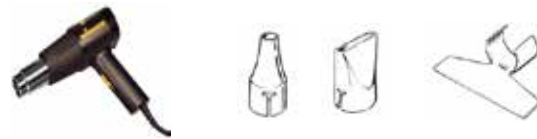

A general purpose heat gun that is ideal for most heating applications, including applying heat shrink tubing, stripping paint, thawing pipes and loosening floor tile.

- 2 temperature settings (750°F & 1000°F) for versatility & various applications.
- 4100 BTU output for removing multiple layers of paint.
- 1200 Watts make this a powerful heat gun.
- Measures 16.5 x 9.8 x 17 inches

IBS No.	Description
141096	Dual Temp Electric Heat Gun
141305	Concentrator Nozzle
141306	Flare Nozzle
141307	Glass Protector Nozzle

Wire / Cable Cutter



- Stainless steel blades cut electrical cable safely.
- Ergonomic handle for comfort.
- Spring keeps handles open when in use.
- Locking device keeps blades closed when not in use.

WARNING:

DO NOT USE ON ELECTRICAL CIRCUITS!

IBS No.	Description	Qty
99169	James Morton Wire Cable Cutter	1

ELECTRICAL



IBS, INCORPORATED

Tools T03

Wire Crimp Tool (T03)



A versatile, heavy-duty tool, made of .140" high-strength, heat-treated carbon steel. It is lightweight without sacrificing strength. It handles a variety of terminal and connector styles, including FLAGS, closed-end connectors, crimp sleeves and standard parts, insulated and non-insulated, over a broad range of 26-6 AWG.

- Anvil Type wire cutter.
- Crimp dies for #26-10 AWG insulated terminals, connectors, and closed-end connectors.
- Cuts & re-threads 4-40, 6-32, 8-32, 10-24, and 10-32 machine screws.
- Crimp die for #12-6 AWG non-insulated terminals, connectors, FLAGS, quick-slides, crimp sleeves and high temperature terminals.
- Crimp die for insulated terminals and butt connectors, wire sizes #8-6 AWG.
- Crimp die for #26-14 AWG non-insulated terminals, connectors, FLAGS, quick-slides and crimp sleeves.
- Wire-stripping stations.
- Strip length guide.
- Textured, cushioned grips.

IBS No.	Description	Qty
TH450	Wire Crimp Tool	1

Ratcheting Wire Terminal Crimper



- Ratcheting mechanism with adjustable clamping force allows for precise, repeatable crimps.
- Compound action design puts more crimping power into each squeeze.
- Double crimping die creates a secure crimp that resists pull-out.
- Ratcheting function allows you to secure a wire connector in the die before inserting the stripped wire into the barrel.
- Quick release lever frees the crimper jaws in any position and when double crimp is complete, acts as a built-in safety measure that can open the handles whenever tool is jammed or stuck.
- Steel jaw contains color-coded wire size markings for red (22-18 AWG), blue (16-14 AWG), and yellow (12-10 AWG) terminals.
- Ergonomic biomaterial handles offer a comfortable, secure grip.

IBS No.	Description	Qty
11477	Ratcheting Wire Terminal Crimper	1

Ratcheting Crimp Tool Sets (T03)

Available with 4 Additional Dies for Crimping A Variety of Terminals with One Tool!



- 4 Crimp Nests: 8 AWG Red; 12-10 AWG Yellow; 16-14 AWG Blue; 22-18 AWG Red
- Mating mechanism prevents jaws from slipping or misalignment.
- Long handles make it easier to crimp - Less force required.
- Easy-to-use and understand release mechanism.
- Ergonomic design to initiate the crimp process.



Dies Available:

- For open barrel terminals: 20GA thru 10GA
- For Insulated Closed End Connectors
- For Double Crimp Insulated Terminals: 24GA thru 10GA
- For Insulated Flag Terminals

IBS No.	Description	Qty
B0050	Ratcheting Crimp Tool	1
B0051	Ratcheting Crimp Tool & Dies Kit	1
B0052	Ratcheting Crimp Tool Case & Dies — No Tools	1
B0053	Ratcheting Crimp Tool Die for 22-10GA Insulated Closed End Term	1
B0054	Ratcheting Crimp Tool Die with Locator for 20-10 GA Open Barrel Connectors	1
B0055	Ratcheting Crimp Tool Die for 22--14 GA Insulated Flag Terminals	1
B0056	Ratcheting Crimp Tool Die for 26-10 GA Double Grip Insulated Terminals	1

ELECTRICAL

Battery Terminal Cleaner IBS No. 74103



Battery Terminal Cleaner removes corrosion from all battery parts and quickly identifies leaks. Color indicator turns red in the presence of acid. When neutralizing, color indicator shows yellow. Regular use increases battery performance and life expectancy.

- **Improves conductivity** — Seals out air to prevent corrosion that robs battery power and life.
- **Attacks and destroys corrosion** — Quick acting cleaner removes stubborn corrosion.
- **Extends battery life** — Seals air and dirt out to protect battery against corrosion build-up and battery voltage leakage.
- **No mess application**
- **Fast-acting formula** makes clean up quick.

Battery Terminal Protector IBS No. 74109



A unique film designed to protect battery terminals from corrosion. Industrial battery terminal sealer and protector.

Extends battery life, allows for maximum flow.

- **Extends battery life** by preventing corrosion.
- **Improves electrical output** keeping connections clean and in direct contact with terminals.
- **Remains flexible** so it won't crack when installing, removing or tightening connections.
- Dielectric strength: 30,000 volts.
- **USE ON:** Battery posts, terminals, in automobiles, trucks, power equipment, boats, handling equipment.

Safety Solvent IV Degreaser IBS No. 74156



- **Penetrates and removes** dirt, grease, oil, grime and varnish deposits.
- Safe on all metals, electrical, equipment wiring, and painted surfaces.
- Non Corrosive and non-staining.
- Removes tar, adhesive marks, crayon, lipstick, chewing gum, ink, fresh paint & spots from upholstery, rugs and clothing.

4 Way Plus IBS No. 74107



- **Dries wet electrical systems and ignitions** to end system delays due to moisture.
- Penetrates and loosens frozen nuts & bolts for faster and easier removal.
- Excellent all-purpose lubricant.
- Valve sprays either stream or mist for all your varied needs.
- Provides moisture barrier — Excellent for use on electrical equipment.
- Stops squeaks and provides permanent protection against metal-to-metal wear.



IBS, INCORPORATED

Chemicals S04

E
L
E
C
T
R
I
C
A
L



Contact and Circuit Board Cleaner

IBS No. 74128

- **Cleans oil**, grease, dirt, moisture and condensation from circuit boards, precision instruments, oxygen equipment, controls, switches, motors and film.
- **Removes carbon** and other harmful deposits on all electrical contacts.
- **Restores** full current flow.



Undercoat

IBS No. 74127

- **Protects and seals** body undersides on trucks, buses, and automobiles.
- **Protects drums, tanks** and other outside storage vessels.
- **Seals out moisture.**
- **Absorbs shock and noise**, eliminating rattles and squeaks.



Dielectric Grease (S08)

IBS No. 37535 - 3 oz. tube

Provides a moisture-proof barrier that lubricates and protects electrical equipment from salt, dirt and corrosion. High dielectric strength. Good thermal, oxidation, and chemical stability.



Hose Clamps

A

Assortments

- Band-It Clamp R-8
- Hose Clamp
 - Aero-Seal, Large R-3
 - Aero-Seal, Small R-3
 - Economy R-12
 - Liner, Large R-4
 - Liner, Small R-4
 - Two Ear Hose Clamp R-10

H

Hose Clamps

- BREEZE Constant Torque Liner
 - Assembly Instructions R-5
- BREEZE High Torque Liner R-6
- Center Punch Galvanized Band-It Clamps R-8
- Economy R-12
- Liner R-3, R-4
- Make-A-Clamp@Kits & Supplies R-7
- T-Bolt Clamps R-7
- Two Ear Hose Clamps R-10
- Worm-Drive
 - Aero-Seal R-3
 - Economy Clamps R-12
 - Liner R-4

T

Tools

- Band-It Center Punch Clamps
 - Heavy Duty Hand Tool R-9
 - Light Duty Hand Tool R-9
- Hose Clamp
 - Ear Clamp Side Jaw Pincers R-11
 - Ear Clamp Standard Jaw Pincers R-11



IBS, INCORPORATED

General Information

H
O
S
E
C
L
A
M
P
S

BREEZE Worm-Drive Clamp Systems

ADVANTAGES OVER OTHER CLAMP SYSTEMS



1. Special Shoulder - The shoulder behind the hex head keeps tools like sockets or nut drivers from jamming into the slots or band-end, making the clamp appear to be tight when it isn't.



2. $\frac{5}{16}$ " Hex Head - The $\frac{5}{16}$ " hex head found on all our clamps provides clearance for open-end wrenches, whereas larger hexes ($\frac{3}{8}$ ", etc.) do not, making wrench tightening difficult if not impossible.



3. Through Slotted - The open slot allows for the use of any size screwdriver. With larger screwdrivers it is easier to tighten the clamp. Slots that are closed at the sides require the use of a small screwdriver.



4. Corrosion Resistant - All clamps are 100% stainless steel. The band, saddle and housing are made from 300 series stainless steel and the screws are made from 410 stainless steel.

5. Finished edge on all bands, this prevents the clamp from damaging the hose.

6. Concave band compared to flat means the clamp seals from the center to the outside which produces uniformed sealing.

7. Arcial Cut Band compared to square cut. For smoother gear action and greater torquing for a stronger band which means less failure and labor savings.

8. Quadru-lock Housing - a housing with no welds to break, higher torque to band providing less cold water leaks and band failures due to stripped or broken clamps.

9. Exceeds by 50% the Quality Control Standards of an AMO MS Mil Spec for worm-drive clamps. These clamps have been used on space shuttles.

IBS, INCORPORATED

Liner Hose Clamps S.S. R01 & R02



Aero-Seal (R01)

Industrial/Aircraft Clamps The Original BREEZE Stainless Steel Worm-Drive Clamp

- Heavy-duty four-piece Quadra-lock construction enables more tightening torque to be delivered to the band perforations.
- Ideal for heavy duty industrial applications.
- All stainless steel
- 120P, 122P, 220P & 222P Assortments Available
- Screw Sizes: #3604-#3608 = 1/4 WAF
QS06-QS72 = 5/16 WAF



IBS No.	Band	Effective Diameter Range				Qty
		Minimum		Maximum		
		inch	mm	inch	mm	
QS3604	5/16	7/32	5.6	5/8	16	10
QS3606	5/16	7/16	11	25/32	20	10
QS3608	5/16	1/2	13	29/32	23	10
QS06	9/16	7/16	11	25/32	20	10
QS08	9/16	1/2	13	29/32	23	10
QS10	9/16	9/16	14	1-1/16	27	10
QS12	9/16	11/16	17	1-1/4	32	10
QS16	9/16	13/16	21	1-1/2	38	10
QS20	9/16	13/16	21	1-3/4	44	10
QS24	9/16	1-1/16	27	2	51	10
QS28	9/16	1-5/16	33	2-1/4	57	10
QS32	9/16	1-9/16	40	2-1/2	64	10
QS36	9/16	1-13/16	46	2-3/4	70	10
QS40	9/16	2-1/16	52	3	76	10
QS44	9/16	2-5/16	59	3-1/4	83	10
QS48	9/16	2-9/16	65	3-1/2	89	10
QS52	9/16	2-13/16	71	3-3/4	95	10
QS56	9/16	3-1/16	78	4	102	10
QS60	9/16	3-5/16	84	4-1/4	108	10
QS64	9/16	3-9/16	91	4-1/2	114	10
QS72	9/16	4-1/8	105	5	127	10

Assortments (Z08)

Aero-Seal Clamps

IBS No. 120P
10 Sizes • 100 Pieces
Storage Rack Included

IBS No. 125P
10 Sizes • 50 Pieces
Storage Rack Included



AERO-SEAL CLAMPS ASSORTMENT

IBS No.	Size Range
QS3604	7/32" to 5/8"
QS3608	1/2" to 29/32"
QS06	7/16" to 25/32"
QS10	9/16" to 1-1/16
QS12	11/16" to 1-1/4"
QS16	13/16" to 1-1/2"
QS20	13/16" to 1-3/4"
QS28	1-5/16" to 2-1/4"
QS32	1-9/16" to 2-1/2"
QS36	1-13/16" to 2-3/4"

Aero-Seal Clamps

IBS No. 220P
5 Sizes • 50 Pieces

IBS No. 225P
5 Sizes • 25 Pieces

LARGE AERO-SEAL CLAMPS ASSORTMENT

IBS No.	Size Range
QS40	2-1/16" to 3"
QS48	2-9/16" to 3-1/2"
QS52	2-13/16" to 3-3/4"
QS56	3-1/16" to 4"
QS72	1-7/8" to 5"

H
O
S
E
C
L
A
M
P
S



IBS, INCORPORATED

Liner Hose Clamps S.S. R01 & R02

H
O
S
E
C
L
A
M
P
S

BREEZE Liner Clamps for Soft/Silicone Hose (R02)

- Liner band is an integral extension of the band.
- Liner is not riveted or welded.
- Protects silicone and other soft surface hose from damage caused by extrusion or shearing through the band slots.
- Liner clamps are designed to give a true concentric seal.
- All stainless steel.
- 120LP & 220LP Assortments Available.
- Screw Size: 5/16 WAF



IBS No.	Band	Effective Diameter Range				Qty
		Minimum		Maximum		
		inch	mm	inch	mm	
L9406	9/16	7/16	11	25/32	20	10
L9408	9/16	1/2	13	29/32	23	10
L9410	9/16	9/16	14	1-1/16	27	10
L9412	9/16	11/16	17	1-1/4	32	10
L9416	9/16	13/16	21	1-1/2	38	10
L9420	9/16	13/16	21	1-3/4	44	10
L9424	9/16	1-1/16	27	2	51	10
L9428	9/16	1-5/16	33	2-1/4	57	10
L9432	9/16	1-9/16	40	2-1/2	64	10
L9436	9/16	1-13/16	46	2-3/4	70	10
L9440	9/16	2-1/16	52	3	76	10
L9444	9/16	2-5/16	59	3-1/4	83	10
L9448	9/16	2-9/16	65	3-1/2	89	10

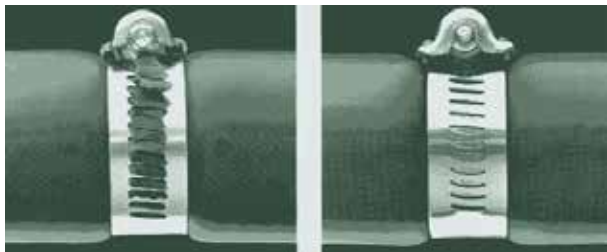

Without Liner

With Liner

Large Size Hose Clamp Assortments (Z08)

Liner Clamps

IBS No. 120LP
10 Sizes • 100 Pieces
Storage Rack Included



LINER CLAMPS ASSORTMENT

IBS No.	Size Range
L9406	7/16" to 25/32"
L9408	1/2" to 29/32"
L9410	9/16" to 1-1/16"
L9412	11/16" to 1-1/4"
L9416	13/16" to 1-1/2"
L9420	13/16" to 1-3/4"
L9424	1-1/16" to 2"
L9428	1-5/16" to 2-1/4"
L9432	1-9/16" to 2-1/2"
L9436	1-13/16" to 2-3/4"

Liner Clamps

IBS No. 220LP
5 Sizes • 35 Pieces

LARGE LINER CLAMPS ASSORTMENT

IBS No.	Size Range
L9440	2-1/16" to 3"
L9448	2-9/16" to 3-1/2"
HTM-350L	2-3/4" to 3-5/8"
HTM-400L	3-1/4" to 4-1/8"
HTM-500L	4-1/4" to 5-1/8"

IBS, INCORPORATED

Constant Torque Liner Clamps R04



BREEZE Constant Torque Liner Clamps

ACTIVE PRESSURE-COMPENSATING CLAMPS

Housing orbitally riveted to saddle at 4 points provides extra strength.

Liner protects soft or silicone hose from damage, extrusion, or shear.

Full $\frac{3}{8}$ " band width provides greater sealing surface.

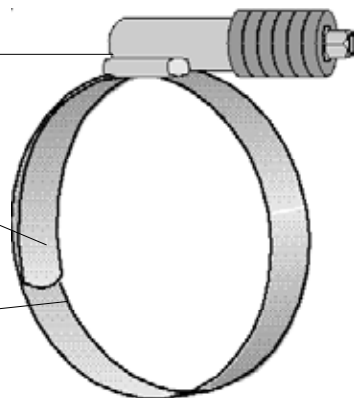

Energy stored in compressed Belleville springs controls automatic clamp adjustment.

Eight screw threads (instead of 3 or 4 found in other clamps) are engaged at all times for high torquing drive and vibration resistance.

This revolutionary clamp reacts to contracting and expanding hose systems by decreasing or increasing its own diameter in response to system changes.

Virtually all rubber hose compresses ("cold flow") after a clamping device is installed. This results in an 80% or greater torque loss almost immediately following installation. Also, virtually all metal connections will expand as the system heats up and then contract as the system cools back down. Most other clamping systems (conventional worm gear, "T" bolt, etc.) are passive systems, which means that expansion and contraction of system components can not be adjusted for without retightening or loosening the clamps. The constant torque clamping system is an "active" clamping system, which means that it monitors the system and then makes compensations for the changes by changing its diameter through a unique worm gear Belleville spring assembly.

Constant Torque Liner Clamps are ideal for:

- sealed systems which cannot be retightened
- systems where clamps are difficult to reach
- applications which require high torque
- large diameter applications
- systems that experience extremes of heat or cold
- systems which expand or contract.

Constant Torque Liner Clamps are designed for torque compensation at installation torques from 50 to 150 in-lbs and all parts are made of stainless steel.

Assembly Instructions

To properly install a Constant Torque Liner Clamp a torque wrench should be used.



MAXIMUM EXPANSION

Clamps should be installed at 50 in-lbs of torque. Screw tip should slightly protrude from housing.

EQUAL EXPANSION OR CONTRACTION

Clamps should be installed at 90 in-lbs. of torque. Screw tip protrudes from housing and Belleville springs are compressed.

MAXIMUM CONTRACTION

Clamps should be installed at 125 in-lbs of torque. Screw tip extends well beyond housing and Belleville springs are compressed to about 90% of flat.

IBS No.	Effective Diameter Range				Qty
	Minimum inch	Minimum mm	Maximum inch	Maximum mm	
CT175L	1	25	1-3/4	44	5
CT250L	1-3/4	45	2-5/8	67	5
CT300L	2-1/4	57	3-1/8	79	5
CT350L	2-3/4	70	3-5/8	92	5
CT400L	3-1/4	83	4-1/8	105	5
CT450L	3-3/4	95	4-5/8	118	5

Screw Size: 3/8 WAF

H
O
S
E
C
L
A
M
P
S



IBS, INCORPORATED

High Torque & T-Bolt Clamps R05 & R09

Breeze High Torque Liner Clamps (R05)

Guaranteed to Withstand more than 3X the SAE Standard Torque Requirements for Worm Drive Clamps

An industrial strength worm-drive stainless steel clamp which is bigger, heavier, and stronger than the "Aero-Seal" clamp.



- All components made of stainless steel.
- Heavy gauge housing orbitally riveted to saddle.
- Designed so that 8 screw threads are simultaneously engaged in the band for increased torquing drive, sealing pressure and vibration resistance.
- Liner band extends underneath drive slots to protect silicone and other soft hose from damage or extrusion.
- Eliminates double clamping and "T" bolts.
- 150 in-lbs. of torque on the screw.
- 220LP Assortment available.
- Screw Size: 5/16 WAF

IBS No.	Effective Diameter Range				Qty
	Minimum		Maximum		
	inch	mm	inch	mm	
HTM-175L	1	25	1-3/4	45	5
HTM-200L	1-1/4	32	2-1/8	54	5
HTM-250L	1-3/4	45	2-5/8	67	5
HTM-300L	2-1/4	57	3-1/8	79	5
HTM-350L	2-3/4	70	3-5/8	92	5
HTM-400L	3-1/4	83	4-1/8	105	5
HTM-450L	3-3/4	95	4-5/8	118	5
HTM-500L	4-1/4	108	5-1/8	130	5
HTM-600L	5-1/4	133	6-1/8	156	5
HTM-650L	5-3/4	146	6-5/8	168	5
HTM-700L	6-1/4	159	7-1/8	181	5
HTM-800L	7-1/4	184	8-1/8	206	5
HTM-900L	8-1/4	210	9-1/8	232	5

T-Bolt Clamps (R09)

SAE Standard J1508 Type "TB"

- 300 Series stainless steel band; plated steel T-Bolt and locknut.
- Superior welded construction.
- Meets SAE Specification J1508.
- For industrial, automotive and fleet applications.
- Recommended torque: 75 in./lbs.
- 3/4" (19 mm) band for superior coverage.
- Floating bridge for equalized clamp load.
- Hex Size: 7/16 WAF



IBS No.	SAE Size	Effective Diameter Range				Qty
		Minimum		Maximum		
		inch	mm	inch	mm	
60175	28	1.75	44.5	2.00	50.8	5
60200	36	2.00	50.8	2.31	58.7	5
60225	44	2.25	57.2	2.56	65.1	5
60250	52	2.50	63.5	2.8	71.4	5
60275	60	2.75	69.9	3.06	77.8	5
60300	68	3.00	76.2	3.31	84.1	5
60325	76	3.25	82.6	3.56	90.5	5
60350	84	3.50	88.9	3.81	96.8	5
60375	92	3.75	95.3	4.06	103.2	5
60400	100	4.00	101.6	4.31	109.5	5
60425	108	4.25	108.0	4.56	115.9	5
60450	116	4.50	114.3	4.81	122.2	5
60475	124	4.75	120.7	5.06	128.6	5
60500	132	5.00	127.0	5.31	134.9	3
60525	140	5.25	133.4	5.56	141.3	3
60550	148	5.50	139.7	5.81	147.6	3
60575	156	5.75	146.1	6.06	154.0	3
60600	164	6.00	152.4	6.31	160.3	3
60625	172	6.25	158.8	6.56	166.7	3
60650	180	6.50	165.1	6.81	173.0	3
60675	188	6.75	171.5	7.6	179.4	3
60700	196	7.00	177.8	7.31	185.7	1
60725	204	7.25	184.2	7.56	192.1	1
60750	212	7.50	190.5	7.81	198.4	1
60775	220	7.75	196.9	8.06	204.8	1

H O S E C L A M P S

IBS, INCORPORATED

Band-It Center Punch Clamps R07



HOSE CLAMPS

Center Punch Galvanized Band-It Clamps

Band style clamps are an effective way of retaining hose couplings in industrial hose (often used for hose repair and assembly). While there are a number of preferred clamping systems available, the Center Punch Clamp is the most economical and popular for its ease of use.

- Locks with impact from a hammer using a conical punch.
- Double wrapped using galvanized carbon steel.
- Not recommended for use with fittings that may crack as a result of impact.
- Install Center Punch clamping systems with Center Punch Band-It Clamp Light Duty Hand Tool (IBS No. 60150)



IBS No.	Width		Inside Diam.		Qty
	inch	mm	inch	mm	
60151	3/8	9.6	13/16	20	10
60152	3/8	9.6	1-3/8	35	10
60153	5/8	15.9	1	25	10
60154	5/8	15.9	1-1/4	32	10
60155	5/8	15.9	1-1/2	38	10
60156	5/8	15.9	1-3/4	44	10
60157	5/8	15.9	2	51	10
60158	5/8	15.9	2-1/4	57	10
60159	5/8	15.9	2-1/2	64	10
60160	5/8	15.9	2-3/4	70	10
60161	5/8	15.9	3	76	10
60162	5/8	15.9	3-1/2	89	10
60163	5/8	15.9	4	102	5
60164	5/8	15.9	4-1/2	114	5
60165	5/8	15.9	5	127	5
60166	5/8	15.9	6	152	5

Band-It Clamps

IBS No. 122P
10 Sizes • 50 Pieces
Storage Rack Included



IBS No.	Width		Inside Diam.	
	inch	mm	inch	mm
60151	3/8	9.6	13/16	20
60152	3/8	9.6	1-3/8	35
60153	5/8	15.9	1	25
60154	5/8	15.9	1-1/4	32
60155	5/8	15.9	1-1/2	38
60156	5/8	15.9	1-3/4	44
60157	5/8	15.9	2	51
60158	5/8	15.9	2-1/4	57
60159	5/8	15.9	2-1/2	64
60160	5/8	15.9	2-3/4	70

Band-It Clamps

IBS No. 222P
5 Sizes • 25 Pieces
Storage Rack Included



IBS No.	Width		Inside Diam.	
	inch	mm	inch	mm
60161	5/8	15.9	3	76
60162	5/8	15.9	3-1/2	89
60163	5/8	15.9	4	102
60164	5/8	15.9	4-1/2	114
60165	5/8	15.9	5	127



IBS, INCORPORATED

Tools T03



**CENTER PUNCH BAND-IT CLAMP
LIGHT DUTY HAND TOOL**

IBS No.	Description	Qty
60150	Center Punch Band-It Clamp Light Duty Hand Tool	1



**CENTER PUNCH BAND-IT CLAMP
HEAVY DUTY HAND TOOL**

IBS No.	Description	Qty
60149	Center Punch Band-It Clamp T300 Heavy Duty Hand Tool	1

H
O
S
E
C
L
A
M
P
S

BAND-IT Center Punch Clamps Light Duty Hand Tool Instructions



1. Tool is designed specifically for 3/8" and 5/8" center punch clamps only. Insert clamp in tool and then insert wrench assembly. If you prefer, install wrench assembly before clamp is inserted. Slot must be aligned with clamp tail.

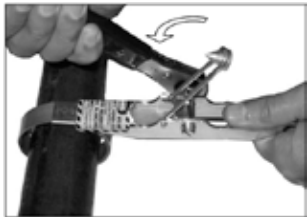

2. Start "pumping ratchet wrench forward until proper tension has been applied.

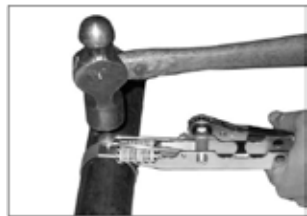

3. Place punch on clamp and while holding tension with ratchet wrench, lock clamp by striking punch once or more with hammer, depending on object being clamped.

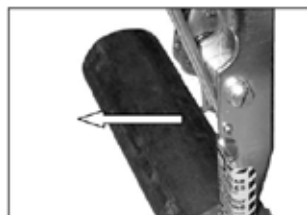

4. While holding tension with wrench, pivot tool up against buckle, then backward several times to break off clamp tail.

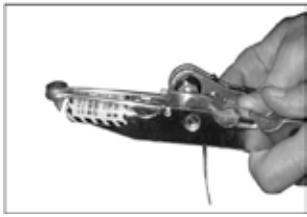

5. To loosen clamp tail, wind ratchet wrench until tail is free. Remove ratchet wrench assembly and clamp tail.

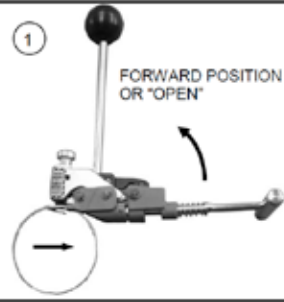

1. Push tension handle all the way forward. Insert BAND-IT Center punch clamp tail and push all the way into tool.

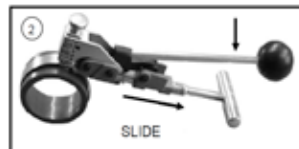

2. Tighten the clamp with short downward strokes. Tension handle should be in down position at completion of tightening clamp.

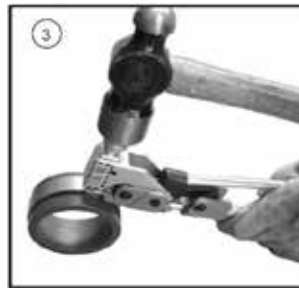

3. Holding tension down, lock clamp by hitting punch at least twice with a 2 lb. mallet.



4. Hold work-piece and pivot the tool back and forth to break off clamp tail. Remove tail from tool by operating tension handle. When tail has moved through holding dog, raise tension handle and pull tail free.

IBS, INCORPORATED

Two-Ear Hose Clamps R08



Two Ear Hose Clamps

Two-Ear Hose Clamps (aka Oetiker Clamps) are widely used in maintenance as well as OEM applications.

- One-piece design offers a positive, tamper-proof seal without damaging the hose.
- Assures adequate closure and compensates for tolerance variations in hose sizes.
- Ideal for industrial use and heavily vibrating equipment.
- Suitable for low and medium pressure hydraulic air, fluid, gas and stem lines.
- Easy to apply — slide on and crimp.
- Zinc plated steel.

IBS No.	Size	Ref No.	Effective Diameter Range				Qty
			mm		inches		
			Closed	Open	Closed	Open	
60041	5/32	41	3.1	4.1	.122	.161	5
60305	3/16	50	3.4	5.0	.134	.197	5
60507	1/4	70	5.0	7.0	.197	.276	5
60709	5/16	90	7.0	9.0	.276	.354	5
60811	3/8	110	8.1	11.0	.319	.433	5
61113	1/2	130	10.8	13.0	.425	.512	5
61315	9/16	150	12.5	15.0	.492	.591	5
61518	5/8	180	15.0	18.0	.591	.709	5
61720	3/4	200	16.2	20.0	.638	.787	5
62023	7/8	230	19.0	23.0	.748	.906	5
62327	1	270	22.5	27.0	.886	1.063	5
62831	1-1/8	310	27.0	31.0	1.063	1.220	5
63134	1-5/16	340	29.3	34.0	1.154	1.339	5
63437	1-7/16	370	32.0	37.0	1.260	1.457	5
63740	1-1/2	400	35.0	40.0	1.378	1.575	5



Ear Clamp Jaw Pincers (T03)

Ear Clamp Jaw Pincers are applied to the ears and closed with sufficient force to draw the lower radii together to a position where component compression is evident and the clamp ear assumes a symmetrical "omega" shaped formation.

- Sturdy construction.
- Cushion grips for better handling.
- Versatile tool — can install and remove pinch clamps.
- Easy to handle.

IBS No.	Description	Qty
61098	Ear Clamp Standard Jaw Pincers	1
61099	Ear Clamp Side Jaw Pincers	1

Two Ear Hose Clamp Assortment (Z02)

IBS No. 756R • 16 Items • 76 Tools

Two-Ear Hose Clamps

Assortment No. 756R

<p>60041 5/32 TWO-EAR CLAMP .122-.161</p>	<p>60305 3/16 TWO-EAR CLAMP .134-.197</p>	<p>60507 1/4 TWO-EAR CLAMP .197-.276</p>	<p>60709 5/16 TWO-EAR CLAMP .276-.354</p>	<p>60811 3/8 TWO-EAR CLAMP .319-.433</p>	<p>61098 EAR CLAMP STANDARD JAW PINCERS CRIMPER</p>
<p>61113 1/2 TWO-EAR CLAMP .425-.512</p>	<p>61315 9/16 TWO-EAR CLAMP .492-.591</p>	<p>61518 5/8 TWO-EAR CLAMP .591-.709</p>	<p>61720 3/4 TWO-EAR CLAMP .638-.787</p>	<p>62023 7/8 TWO-EAR CLAMP .748-.906</p>	
<p>62327 1" TWO-EAR CLAMP.886-1.063</p>	<p>62831 1-1/8 TWO-EAR CLAMP</p>	<p>63134 1-5/16 TWO-EAR CLAMP</p>	<p>63437 1-7/16 TWO-EAR CLAMP</p>	<p>63740 1-1/2 TWO-EAR CLAMP</p>	

H O S E C L A M P S



IBS, INCORPORATED

Economy Hose Clamps R06

Economy Clamps

Ideal 67-1 Series

- 1/2" band clamps are suitable for most common home and automotive applications.
- Screw: 5/16" hex head (Mini #67004 & #67008 1/4" hex head), 410 stainless steel. Band & housing: 1/2" design, 201/301 stainless steel



H
O
S
E
C
L
A
M
P
S

IBS No.	Clamp No.	Effective Diameter Range				Qty
		Minimum		Maximum		
		inch	mm	inch	mm	

MINI AUTOMOTIVE HOSE CLAMPS (5/16" Band)

67004	#04	1/4	6	5/8	16	10
67008	#06	5/16	8	7/8	22	10

REGULAR AUTOMOTIVE HOSE CLAMPS

6706	#06	3/8	10	7/8	22	10
6710	#10	1/2	13	1-1/16	27	10
6712	#12	1/2	13	1-1/4	32	10
6716	#16	11/16	18	1-1/2	38	10
6720	#20	3/4	19	1-3/4	44	10
6724	#24	1	25	2	51	10
6728	#28	1-1/4	32	2-1/4	57	10
6732	#32	1-1/2	38	2-1/2	63	10
6736	#36	1-3/4	44	2-3/4	70	10

Economy Clamp Assortment (Z08)

IBS No. 262R • 10 SIZES • 100 PIECES

- STORAGE RACK INCLUDED



IBS No.	Clamp No.	Qty	IBS No.	Clamp No.	Qty
67004	#04	10	6716	#16	10
67008	#06	10	6720	#20	10
6706	#06	10	6728	#28	10
6710	#10	10	6732	#32	10
6712	#12	10	6736	#36	10



Adhesives & Sealants

A

Adhesives

- DriveGrip Anti Cam-Out Fluid SA-17
- Loctite
 - 401 Prism Instant Adhesive SA-3
 - Depend 330 Instant Adhesive SA-3
 - Quicktite SA-3
- Multi-Purpose Adhesive SA-20
- Spray Adhesive SA-33

Aerosols

- Rapid Gasket SA-38
- Spray Adhesive SA-33

Anti-Seize

- Anti-Seize Gel Aluminum Formula SA-11
- Anti-Seize Gel Copper Formula SA-11

Anti-Seize & Lubricants

- AS022 Anti-Seize SA-18
- C5A Copper Based Anti-Seize SA-5
- C5A Copper Based Anti-Seize"Quick Stix" SA-5
- Dielectric Grease SA-5
- Marine Grade Anti-Seize SA-5
- White Food Grade Anti-Seize SA-5

Assortments

- Adhesives
 - Drive Grip & Insert bits SA-17
 - DriveGrip & Nutserts SA-17
- Epoxy Products
 - 2-Part EZ-Epoxy Sticks SA-32
- Loctite
 - Loctite 10ml Threadlocker SA-14
 - Loctite 10 ml Travel Tray SA-13, SA-14
 - Loctite Glues & Epoxies SA-4
 - Loctite Quick-Stix Assortment SA-10, SA-13, SA-14, SA-15
 - Loctite RTV Tubes SA-7
 - Loctite Threadlocker Assortment SA-7, SA-14
- Thread Locker, Anti-Seize & Dielectric Grease Assortment & Travel Tray SA-11
- Threadlockers
 - NO MESS Threadlocker Travel Tray SA-10

E

Epoxy Products

- Assortments
 - 2-Part EZ-Epoxy Sticks Assortment SA-32
- EZ-Poxy Aluminum SA-29
- EZ-Poxy Aqua SA-26
- EZ-Poxy Concrete SA-31
- EZ-Poxy Plastic SA-30
- EZ-Poxy Steel SA-27
- EZ-Poxy Wood SA-28
- Fixmaster® 4 Minute Epoxy SA-3
- Fixmaster® Fast Set Steel Epoxy SA-3

L

Loctite Products

- Adhesives & Epoxies
 - 401 Prism Instant Adhesive SA-3
 - Depend 330 Instant Adhesive SA-3
 - Fixmaster® 4 Minute Epoxy SA-3
 - Fixmaster® Fast Set Steel Epoxy SA-3
 - Quicktite SA-3
 - Anti-Seize & Lubricants
 - C5A Copper Based Anti-Seize SA-5
 - C5A Copper Based Anti-Seize"Quick Stix" SA-5
 - Dielectric Grease SA-5
 - Marine Grade Anti-Seize SA-5
 - White Food Grade Anti-Seize SA-5
 - Assortments
 - Loctite Quick-Stix Assortment SA-10, SA-13, SA-14, SA-15
 - Loctite Threadlocker Assortment SA-7, SA-14
 - Gasketing & Sealing
 - Loctite 515 Purple Gasket Eliminator SA-6
 - Loctite 518 Red Gasket Eliminator SA-6
 - Loctite 548 Gasket Eliminator Flange Sealant "Quick Stix™" SA-6
 - Loctite 5699 Grey High Performance RTV Silicone Gasket Maker SA-7
 - Properties Chart SA-6, SA-7
 - Superflex Red High Temp RTV SA-7
 - Superflex RTV Black SA-6
 - Superflex RTV Blue SA-6
 - Superflex RTV Clear SA-6
 - Superflex RTV White SA-6
- #### Primers
- 7649™ Primer N™ SA-13
- #### Retaining
- 609 Retaining Compound SA-8
 - 620 Retaining Compound SA-8
 - 660 Quick Metal Retaining Compound SA-8
 - 668 Retaining Compound High Temperature SA-8
- #### Threadlocking
- 242 Threadlocker SA-9
 - 243 Threadlocker SA-9
 - 248 Threadlocker "Quick Stix" SA-9
 - 249 QuickTape Threadlocker SA-9
 - 262 Threadlocker SA-12
 - 263 Red High Strength Oil-Resistant Threadlocker SA-12
 - 268 Threadlocker SA-12
 - 272 Threadlocker SA-12
 - 290 Threadlocker SA-12
 - 2760 Threadlocker SA-13
 - 7649 Primer N™ SA-13
- #### Thread Sealing
- 545 Hydraulic/Pneumatic Thread Sealant SA-15
 - 561 PST Thread Sealant "Quick Stix" SA-15
 - 565 PST Thread Sealant SA-15, SA-16



567 PST Thread Sealant SA-16
 No More Leaks™ SA-16
 Thread Sealant with PTFE SA-16
 Tight Anaerobic Gel SA-16

Lubricants

Anti-Seize
 Anti-Seize Gel Aluminum Formula SA-11
 Dielectric Grease Pump SA-11

M

Metalink

Accelerator SA-20
 Anti-Seize (AS022) SA-18
 Blu-Goo SA-19
 Brushable Ceramic SA-21, SA-22
 Debonder SA-20
 Dillo Hyde™ Wear Systems
 Ceramic Hexagonal Wear Plates SA-24
 Seal-Skin SA-25

Miscellaneous

Shur-Shot Dispensing Gun SA-4
 Static Mixers SA-4

R

R.T.V. Gasket Maker & Sealers

Black SA-34
 Clear SA-34
 Comparison Test SA-35
 Hi-Temp Red SA-36
 Low Volatite Blue SA-37
 SuperFlex RTV Silicone SA-6

S

Sealants

EZ-Poxy Aluminum SA-29
 EZ-Poxy Aqua SA-26
 EZ-Poxy Plastic SA-30
 EZ-Poxy Steel SA-27
 EZ-Poxy Wood SA-28
 Loctite
 545 Hydraulic/Pneumatic Thread Sealant SA-15
 561 PST Thread Sealant "Quick Stix" SA-15
 565 PST Thread Sealant SA-15
 567 PST Thread Sealant SA-16
 No More Leaks™ SA-16
 Thread Sealant with PTFE SA-16
 Tight Anaerobic Gel SA-16

Metalink

Anti-Seize (AS022) SA-18
 Blu-Goo SA-19
 Pipe Thread Sealant Gel with PTFE SA-11

Pressurized Tube
 R.T.V. Gasket Maker & Sealer SA-34
 R.T.V. Hi-Temp Red SA-36
 R.T.V. L. V. Blue SA-37

T

Technical Information

Metalink
 Brushable Ceramic SA-21, SA-22

Threadlockers

Pipe Thread Sealant Gel with PTFE SA-11
 Threadlocker Gel
 High Strength Red SA-10
 Medium Strength Blue SA-10

Tools & Parts

Replacement Parts
 Plunger for Shur-Shot Dispensing Gun SA-4
 "Shur-Shot" Dispensing Gun SA-4
 Static Mixers SA-4

Adhesives & Epoxies

Depend 330 Adhesive No Mix Kit

IBS No. 20251 - 25 ml. syringe kit



Adhesive sets in just minutes to a tough acrylic adhesive with high peel and impact strength. Bonds almost all combinations of materials, including glass. No-mix kit includes activator and adhesive.

Loctite 401 Prism Instant Adhesive

IBS No. 40140 - 20g



Designed for the assembly of difficult-to-bond materials which require uniform stress distribution and strong tension and/or shear strength. This surface insensitive product provides rapid bonding of a wide range of materials, including metals, plastics and elastomers. Also suited for bonding porous materials such as wood paper, leather and fabric.

Fixmaster® Fast Cure Epoxy Cups

IBS No. 21426 - (10) 1oz. cups

IBS No. 21425 - (10) .12 oz. cups



Premeasured epoxy mixer cups. Bonds in 5-15 minutes. Excellent chemical resistance. Fills porosities and can be used to build up worn parts. Ideal for bonding glass, hard plastics, rubber, and metal.

Fixmaster® Fast Set Steel Epoxy

IBS No. 96604 - 50 ml. cartridge



Steel filled. Reaches functional cure in 10 minutes. Temperature resistant up to 200°F. Recommended for repairing pipes and other equipment that must be back in service in minutes. Cartridge requires manual dispensing gun.

Fixmaster® (Clear) 4 Minute Epoxy

IBS No. 97434 - 50 ml. cartridge



Translucent, gel-like adhesive. Sets up in 4-6 minutes. Temperature resistant up to 160°F. Ideal for emergency repairs or where reduced fixturing time is desirable. Cartridge requires manual dispenser gun.

Fixmaster® (Clear) Poxy Pak

IBS No. 81120 - 1 oz syringe



This faster cure, general purpose epoxy bonds virtually any material. It will also fill or seal cracks and rebuild worn surfaces. Comes in a 1 oz. syringe with a built-in plunger for easy dispensing without equipment. Sets in 5 minutes.

Quicktite

IBS No. 39202 - 0.14 oz. bottle



A general purpose instant adhesive featuring an innovative precision flow control applicator. This new, patented, "squeeze grip" applicator allows for pinpoint control of the exact amount and placement of the adhesive. It is also designed to be clog-free, so the adhesive is always ready to use.



IBS, INCORPORATED

Loctite Products S08

Adhesives & Epoxies



“Shur-Shot” Dispensing Gun

IBS No. EQ016

Also works with LOCTITE 2-Part CLEAR (97434) and FAST SET STEEL (96604)

Static Mixers

IBS No. EQ115

Also works with LOCTITE 2-Part CLEAR (97434) and FAST SET STEEL (96604)



Replacement Parts:
Plunger for Shur-Shot Dispensing Gun
IBS No. 128405

Assortments (Z02)

Loctite Glues & Epoxies Assortment

IBS No. 674R • 8 Items • 22 Pieces

Packaged in a Locking Steel Drawer for Easy Storage & Organization

 IBS, Inc. <small>SPECIALTY PRODUCTS FOR MAINTENANCE & REPAIR INDUSTRIALBOLT.COM © 2013 800-678-1906</small>		Loctite Glues & Epoxies <small>Assortment No. 674R</small>	
39202 LOCTITE QUICKTITE INSTANT 	74510 MULTI-PURPOSE ADHESIVE 3.7 OZ E6000 	97434 FIXMASTER 2 PART 4 MINUTE 	EQ115 STATIC MIXER 
20251 LOCTITE 330 DEPEND ADHESIVE 	21425 LOCTITE .12 OZ FAST CURE 	96604 LOCTITE FIXMASTER FAST SET 	EQ016 DISPENSING GUN 



A
D
H
E
S
I
V
E
S

Anti-Seize & Lubricants



C5A Copper Based Anti-Seize

IBS No. 51007 - 1 lb. brush top can

Exclusive formula suspends copper and graphite in a high quality grease. Protects metal parts from rust corrosion, galling and seizing at temperatures to 1800°F (982°C). Tested to MIL-PRF-907-E. CFIA Approved.



C5A Copper Based Anti-Seize "Quick Stix"

IBS No. 37229 - 19 grams

The same trusted performance characteristics as the Loctite C5-A Copper Based Anti-Seize paste in a convenient semi-solid stick form. Stick package offers more portability and less mess. Qualified to performance requirements of MIL-PRF-907E and CFIA approved.



White Food Grade Anti-Seize

Metal Free

IBS No. 51168 - 8 oz. brush top can

Prevents seizure, galling and friction in stainless steel and other metal parts up to 750°F (400°C). NSF H1 approved for incidental food contact.



Dielectric Grease

IBS No. 37535 - 3 oz. tube

Provides a moisture-proof barrier that lubricates and protects electrical equipment from salt, dirt and corrosion. High dielectric strength. Good thermal, oxidation, and chemical stability.

*Additional sizes available
as non-stock items*



Marine Grade Anti-Seize

IBS No. 34026 - 16 oz. brush top can

Formulated to protect assemblies exposed directly or indirectly to fresh and salt water, this anti-seize works especially well in high humidity conditions. It has excellent lubricity, superior water resistance, and prevents galvanic corrosion. ABS Approved.

FOR INDUSTRIAL / PROFESSIONAL USE ONLY

KEEP OUT OF REACH OF CHILDREN

ALWAYS READ LABEL FOR COMPLETE DIRECTIONS AND PRECAUTIONS



IBS, INCORPORATED

Loctite Products S08

Gasketing & Sealing

ADHESIVES



Loctite 515™ Purple Gasket Eliminator

IBS No. 51531 - 50 ml tube

Recommended for use on rigid iron, steel and aluminum flanges (aluminum gearbox and engine castings, etc.) Easy disassembly and cleaning. Gasketing product for machined metal flanges. Medium strength. 30 minute fixture time.

- Ideal for machined metal components.
- Forms a perfect seal between components.
- For gaps up to 0.25 mm.



Loctite 518™ Red Gasket Eliminator

IBS No. 51831 - 50 ml tube

Medium-strength, general purpose gasketing product - excellent contamination tolerance. Ideal for use on cast iron, steel and aluminum flanges. Cures when confined in the absence of air between close-fitting metal surfaces. Designed for use on rigid iron, aluminum, and steel flanged mating surfaces. Fills gaps up to 0.25mm and forms a flexible, chemical-resistant seal that will not tear or decay. Parts disassemble easily, even after extended service. Typical applications include sealing close-fitting joints between rigid metal faces and flanges. It is also used as a formed-in-place gasket on rigid flanged connections, e.g. transmissions and motor housings.

Benefits vs. Cut Gaskets:

- Reduces inventory costs — no need for large inventory of cut gaskets.
- Resists high pressure when fully cured.
- No compression set or misaligned gaskets.



Loctite 548™ Gasket Eliminator Flange Sealant "Quick Stix™"

IBS No. 39152 - 18 gm stick

Patented semi-solid formula is ideal for on the spot repairs, or when a conventional gasket is out-of-stock. Can be applied neatly and quickly on a variety of metal surfaces, including aluminum, to form a flexible, solvent resistant seal. Seals to 300°F (149°C) and fills gaps to 0.010".

Superflex™ RTV Silicone Adhesive Sealants

CLEAR	IBS No. 59530 - 80 ml tube	59575 - 300 ml cartridge
BLACK	IBS No. 59330 - 80 ml tube	59375 - 300 ml cartridge
BLUE	IBS No. 30560 - 80 ml tube	30533 - 300 ml cartridge
WHITE	IBS No. 59430 - 80 ml tube	59475 - 300 ml cartridge



- This silicone product has excellent adhesion to most substrates.
- Key features are resistances to extreme thermal and UV cycling without hardening, shrinking or cracking.
- -65°F to 500°F
- Tack Free — 30 Min. / Full Strength: 24 hrs.

FOR INDUSTRIAL / PROFESSIONAL USE ONLY

KEEP OUT OF REACH OF CHILDREN

ALWAYS READ LABEL FOR COMPLETE DIRECTIONS AND PRECAUTIONS



Gasketing & Sealing

Loctite® 5699™ Grey High Performance RTV Silicone Gasket Maker

IBS No. 18718 - 70 ml tube IBS No. 40505 - 190 ml cartridge
 IBS No. 18581 - 300 ml cartridge



- Increased oil resistance for rigid flange assemblies.
- Excellent fluid resistance.
- Easy to dispense.
- Noncorrosive, low odor, low volatility.
- -75°F to 625°F (-59°C to 329°C)
- Tack-Free — 30 Min./ Full Strength — 24 Hrs.
- CFIA Listed.

Loctite® Superflex® Red High Temp RTV Silicone Adhesive Sealant

IBS No. 59630 - 80 ml tube 59675 - 300 ml cartridge



- Makes gaskets that resist temperatures to 600°F (316°C) intermittent.
- Resists aging, weather and thermal cycling without shrinking, cracking or hardening.
- Fills gaps to 0.25 inches.
- -75°F to 600°F
- Tack-Free — 30 Min. / Full Strength — 24 hrs.
- CFIA Listed.

Loctite RTV Tube Assortment

IBS No. 776R • 6 Items • 6 Pieces

Packaged in a Locking Steel Drawer for Easy Storage & Organization

IBS, Inc. SPECIALTY PRODUCTS FOR MAINTENANCE & REPAIR INDUSTRIALBOLT.COM • 800-678-1506		Loctite RTV Tube Assortment			
Assortment 776R					
59530 LOCTITE SUPERFLEX 80ML TUBE RTV CLEAR	59430 LOCTITE SUPERFLEX 80ML TUBE RTV WHITE	59330 LOCTITE SUPERFLEX 80ML TUBE RTV BLACK	30560 LOCTITE SUPERFLEX 80ML TUBE RTV BLUE	59630 LOCTITE HI TEMP 80ML TUBE RTV RED	18718 LOCTITE GASKET MAKER 70ML TUBE RTV GRAY

ADHESIVES





IBS, INCORPORATED

Loctite Products S08

A
D
H
E
S
I
V
E
S

Retaining



*Additional sizes available
as non-stock items*

Loctite 609™ Retaining Compound

Press Fit / General Purpose

IBS No. 60931 — 50 ml IBS No. 60921 — 10 ml

A low viscosity, fast curing adhesive used for bonding rigid metal assemblies. Ideal for gap distances up to 0.005" (0.13mm). Loctite 609™ fixtures in just 10 minutes and provides shear strength of 3,000 psi after 24 hours. It easily joins dissimilar metals and withstands temperatures up to 300°F (149°C).



*Additional sizes available
as non-stock items*

Loctite 620™ Retaining Compound

Slip Fit / High Temperature

IBS No. 62040 — 50 ml IBS No. 62015 — 10 ml

A high temperature adhesive that has the capability to operate at 450°F (232°C) for long periods. Fixtures in 30 minutes at room temperature, but requires a secondary heat cure to generate the high temperature resistance. Used to bond cylindrical parts with gaps up to 0.015" (0.35mm). Loctite 620™ provides a shear strength of 3,800 psi on steel after 24 hours. Ideal for use on retaining bushes, bearings, seals, fans and liners.



*Additional sizes available
as non-stock items*

Loctite 660™ Quick Metal Retaining Compound

Press Fit Repair

IBS No. 66010 — 6 ml tube

A creamy, non-running gel that is applied onto cylindrical parts to fill surface imperfections and repair worn areas. It contains no metal, but once assembled hardens to a strength that often doubles that of a press fit. Use to salvage worn metallic parts, or to keep machinery running until new parts arrive. Use to 300°F (149°C)



Loctite 668™ Retaining Compound High Temperature "Quick Stix"

General Purpose

IBS No. 39148 — 19 gm stick

A high temperature retaining compound in a revolutionary semi-solid formula. Patented, no-mess package offers added convenience and portability. Ideal for gaps up to 0.005" on the diameter. Withstands temperatures to 400°F (204°C).

FOR INDUSTRIAL / PROFESSIONAL USE ONLY

KEEP OUT OF REACH OF CHILDREN

ALWAYS READ LABEL FOR COMPLETE DIRECTIONS AND PRECAUTIONS

Thread Locking



242™ Threadlocker

Medium Strength / Removable / Blue

IBS No. 24231 — 50 ml IBS No. 24221 — 10 ml

A removable strength, general-purpose thread locking adhesive especially well-suited for fasteners between 1/4" and 3/4" diameter (6 to 20mm). Applied to threaded components before assembly, Blue 242 has controlled lubricity for accurate clamp loads. Parts can be separated using hand tools.

Additional sizes available as non-stock items



243™ Threadlocker

Medium Strength / Oil Resistant
Removable / Blue

IBS No. 24078 — 50 ml IBS No. 24310 — 10 ml

A general purpose, medium strength threadlocker with improved oil tolerance. Suitable for 1/4" to 3/4" diameter (6mm to 20mm) fasteners. Cure speed: Fixture - 5 minutes, Full — 24 hrs. Temperature Range: -65°F to 300°F (-54°C to 150°C)

Additional sizes available as non-stock items



248™ Threadlocker "Quick Stix"

Medium Strength / Removable / Blue

IBS No. 37087 — 19 grams

New, patented semi-solid stick formula offers added convenience and portability. Like Loctite® 242®, this threadlocker stick is well suited for 1/4" to 3/4" (6 to 20mm) fasteners and is removable with hand tools. The semi-solid formula also means it won't spill or leak.



249™ QuickTape Threadlocker

Medium Strength / Blue

IBS No. 1372603

Designed for the locking and sealing of threaded fasteners which require normal disassembly with standard hand tools. The product cures when confined in the absence of air between close fitting metal surfaces and prevents loosening and leakage from shock and vibration. Supplied in a low tack film to provide a convenient and easy to use package, especially where a liquid product may be too fluid to stay on a part or be difficult to apply.



IBS, INCORPORATED

Threadlockers S08

Threadlocker Gel (S04)

IBS No. 74242 — Blue 35 ml bottle Qty 6/cs
IBS No. 74262 — Red 35 ml bottle Qty 6/cs



Threadlocker Gel is a better, faster and cleaner way to apply threadlocker to bolts, studs, or anywhere it is needed. The gel goes on without globs or messy drips and waste. Like other threadlockers, **Threadlocker Gel** is a single component, anaerobic gel that cures when confined in the absence of air between close fitting metal surfaces. This product cures rapidly on plated, oily metal surfaces or inactive surfaces. Locks and seals while preventing parts loosening due to vibration. Protects threads from corrosion with good solvent resistance against water and non-polar solvents. Removable with hand tools for easy disassembly.

- Gel Formula provides "liquid-reliability" without drips, globs, mess or waste Gel formula is **thicker than standard threadlockers** and is easier to use on vertical or hard-to-reach applications.
- **Pump dispenser** makes this product easy to dispense with no mess and exceptional control for reduced waste, saving time and money.
- Replaces lock washers and plastic inserts. Locks machine tool access bolts, studs and hydraulic system bolts. Used on gear box bolts / drive shaft, bearing cover capscrews, counter sunk screws, conveyor rolls and construction equipment.
- **Eliminates vibration loosening** for maximum safety keeping equipment and those around it safe from failure.
- **Seals against leakage**, protects against rust and corrosion.
- **Cures without cracking or shrinking** for a stronger hold and more protective seal.
- Color Blue (Medium Strength) and Red (High Strength).
- Gap Fill: 0.0015"
- Max Operating Temp: -65°F to +300°F.
- Full Cure Time: 24 hours @ 68°F

BLUE Cured Performance

Typical Breakaway Strength: 3/8 Phos-oil 100 - 130 lb-ins.
 Typical Prevailing Strength: 3/8 Phos-oil 40 - 60 lb-ins.

RED Cured Performance

Typical Breakaway Strength: 3/8 Phos-oil 150 - 300 lb-ins.
 Typical Prevailing Strength: 3/8 Phos-oil 100 - 350 lb-ins.

NO MESS Threadlocker Travel Tray (Z02)

IBS No. 817R • 4 Items • 4 Pieces

Packaged in a clear plastic locking storage container



ADHESIVES



Pipe Thread Sealant Gel with PTFE (S04)

IBS No. 74159 — 35 ml IBS No. 24221 — 10 ml



A better, faster and cleaner way to apply pipe thread sealant to pipe or anywhere it is needed

- An anaerobic pipe sealant that sets fast to give an instant low-pressure seal of 100 psi and a high-pressure seal of 1000 psi and a high-pressure seal when fully cured - up to 10,000 psi.
- This high strength formula contains no solvents, providing a sealing capability of 100% and does not shrink after curing, unlike more traditional solvent-based pipe dopes.
- Contains PTFE which lubricates parts during assembly which allows for faster and easier assembly.
- The curing time allows for realignment of parts up to 24 hours from application.
- Can be used on most hydraulic, pneumatic, oil, water and gas connections.
- **NOT FOR PLASTICS.**

Thread Locker, Anti-Seize & Dielectric Grease Assortment

IBS No. 833R • 6 Items • 12 Pcs

Packaged in a Locking Steel Drawer for Easy Storage & Organization



ADHESIVES

Thread Locker, Anti-Seize & Dielectric Grease Travel Tray

IBS No. 832R • 6 Items • 6 Pcs

Packaged in a Plastic Travel Tray for Easy Storage & Organization





IBS, INCORPORATED

Threadlockers S08

Thread Locking

262™ Threadlocker

High Strength / Red

IBS No. 26231 — 50 ml bottle **IBS No. 26221 — 10 ml**

Red 262™ is a high-strength product that is designed for the permanent locking and sealing of threaded fasteners up to 3/4" (20 mm in size before assembly). Localized heating and hand tools are required to separate parts. Solvents will not weaken adhesive bond. Approved for use in or around food processing areas.



263™ Red High Strength Oil-Resistant Threadlocker

High Strength Oil-Resistant / Red

IBS No. 26331 — 50 ml bottle **IBS No. 26321 — 10 ml**

Red 263™ is a high strength product designed for the permanent locking and sealing of threaded fasteners with the added advantage of performing despite the presence of surface contaminants. It not only works on active metals (brass, copper) but also on passive substrates such as stainless steel and plated surface. The product offers high performance and oil tolerance. It tolerates minor surface contaminations from various oils, such as cutting, lubrication anti-corrosion and protection fluids.

Suggested applications: Studs into motor housings, nuts onto studs in pump housings and other fasteners where high strength is required.

- Ideal application: 1/4 - 3/4 bolts with light oil contamination
- Temperature Range: -65°F to 360°F
- Cure Speed: - 5 Min., Full - 24 hrs.



268™ Threadlocker

High Strength / Red

IBS No. 37686 — 19 grams

Revolutionary semi-solid stick formula is high strength and best suited for fasteners up to 1" (20mm). Semi-solid formula offers added convenience and portability. Localized heat and hand tools are required to separate parts. Ideal for heavy duty applications.



272™ Threadlocker

High Strength / Red / High Temperature

IBS No. 27240 — 50 ml bottle

Withstands temperatures to 450°F. Provides a fast cure on most surfaces, including "as received" fasteners. Recommended for bolts up to 1-1/2" (36mm) in diameter. Heat and hand tools are required for disassembly.

Additional sizes available as non-stock items



290™ Threadlocker

Wicking / Green / High Strength

IBS No. 29031 — 50 ml **IBS No. 29021 — 10 ml**

A low viscosity, thread locking liquid, that wicks along the threads of pre-assembled fasteners to secure them in place. Seals porosities in welds and metal parts. Ideal for fasteners ranging from #2 to 1/2" (2.2 to 12mm) in size. Localized heat and hand tools are needed for disassembly. Approved for use in or around food processing areas.



A
D
H
E
S
I
V
E
S



Thread Locking

2760™ Threadlocker

Primerless / High Strength / Red

IBS No. 32525 — 50 ml IBS No. 32526 — 10 ml



This threadlocker is particularly fast-curing, thereby reducing or eliminating the need for primers. For use on all metal fasteners where regular removal maintenance is not required. Recommended for permanently locking studs on engine blocks and pump housings.

7649™ Primer N™

IBS No. 21348 — 4.5 oz. net wt. aerosol can



Decreases the set-up time of Loctite® brand threadlockers and increases breakaway torque on most fastener surfaces. Allows cold weather application. Contains no ozone-depleting compounds.

NSF spec. 5% Copper

USE LOCTITE 7649 PRIMER N to:

1. Activate inactive surfaces.
2. Speed cure times for faster return to service.
3. Speed curing through larger gaps and threads.
4. Substantially speed cure times on cold parts.
5. Act as a cleaning agent.

Primer is optional with:

Active surfaces: Brass, copper, bronze, iron, soft steel, nickel.

Primer is required with:

Inactive surfaces: Aluminum, stainless steel, magnesium, zinc, black oxide, cadmium, titanium and others.

Loctite 10 ml Travel Tray (Z02)

IBS No. 747R • 6 Items • 6 Pieces

Packaged in a plastic locking storage container for easy storage & organization

IBS, Inc. SPECIALTY PRODUCTS FOR MAINTENANCE & REPAIR INDUSTRIALBOLT.COM © 2008 800-878-1906		Loctite 10 ml Travel Tray				Assortment No. 747R
24221 LOCTITE 242 BLUE REMOVABLE THREADLOCKER 10 ml	24310 LOCTITE 243 BLUE MEDIUM OIL RESISTANT THREADLOCKER 10 ml	26221 LOCTITE 262 RED HIGH STRENGTH OIL RESISTANT THREADLOCKER 10 ml	26321 LOCTITE 263 RED HIGH STRENGTH OIL RESISTANT THREADLOCKER 10 ml	29021 LOCTITE GREEN MEDIUM THREADLOCKER 10 ml	LOCTITE 545 PURPLE HYDRAULIC / PNEUMATIC SEALANT 10 ml	



ADHESIVES



IBS, INCORPORATED

Assortments (Z02)

Thread locking

Loctite Threadlocker Assortment

IBS No. 671R • 8 Items • 8 Pieces

Packaged in a locking steel drawer for easy storage and organization

















 IBS, Inc. <small>SPECIALTY PRODUCTS FOR MAINTENANCE & REPAIR INDUSTRIALBOLT.COM © © © 800-678-1906</small>		Loctite Thread Lockers	
Assortment No. 671R			
37087 LOCTITE 19GM BLUE  	37686 LOCTITE 19GM RED THREADLOCKER  	51604 LOCTITE TIGHT ANAEROBIC GEL  	21348 LOCTITE PRIMER-N AEROSOL 4.5OZ  
24231 LOCTITE REMOVABLE  	26231 LOCTITE HIGH STRENGTH  	29031 LOCTITE 50ML GREEN MEDIUM  	27240 LOCTITE 50ML HT TEMP HI  



Loctite 10ml Threadlocker Assortment

IBS No. 676R • 8 Items • 8 Pieces

Packaged in a plastic locking storage container for easy storage & organization

 IBS, Inc. <small>SPECIALTY PRODUCTS FOR MAINTENANCE & REPAIR INDUSTRIALBOLT.COM © © © 800-678-1906</small>		Loctite 10ml Threadlockers	
Assortment No. 676R			
37087 LOCTITE 19GM BLUE THREADLOCKER STICK  	37686 LOCTITE 19GM RED THREADLOCKER STICK  	51604 LOCTITE TIGHT ANAEROBIC GEL 50ML  	21348 LOCTITE PRIMER-N AEROSOL 4.5OZ  
24221 BLUE REMOVEABLE THREADLOCKER 10ml  	26221 262 RED HIGH STRENGTH THREADLOCKER 10ml  	29021 290 GREEN MEDIUM THREADLOCKER 10ml  	32526 2760 RED HIGH THREADLOCKER 10ml  



ADHESIVES



Thread Sealing

545 Hydraulic/Pneumatic Thread Sealant

IBS No. 54531 — 50 ml IBS No. 32429 — 10 ml

Designed for both hydraulic and pneumatic systems, 545 contains no fillers or particles which could contaminate system fluids, foul valves, or clog fine filters and screens. Suitable for fittings up to 2" (50 mm) in diameter, 545 has excellent solvent resistance.

Additional sizes available as non-stock items



561 PST Thread Sealant "Quick Stix"

IBS No. 37127 - 19 grams

New, patented semi-solid stick formula offers added convenience and portability. Like Loctite® 565™ PST® this product has immediate low pressure sealing, eases disassembly, and will not contaminate or clog lines. The semi-solid formula also means it won't spill or leak, making it great for overhead applications or carrying in a pocket or toolbox.



565 PST Thread Sealant

IBS No. 56531 — 50 ml tube 56541 — 250 ml tube

Formulated specifically for metal, tapered pipe thread fittings, 565 cures rapidly to provide immediate low pressure sealing. Its controlled lubricity prevents galling and it prevents mated thread areas from rust and corrosion. 565 can be used on fittings up to 2" (50mm) in diameter.

NSF Food Grade with primer

Refer to approvals on tech page (SA-22)



Loctite Quick-Stix Assortment

IBS No. 673R • 6 Items • 6 Pieces

Packaged in a clear plastic locking storage container for easy storage & organization

IBS, Inc. SPECIALTY PRODUCTS FOR MAINTENANCE & REPAIR INDUSTRIALBOLTY.COM ☎ ☎ ☎ 800-678-1996		Loctite Quick-Stix Travel Tray			
Assortment 673R					
37087 LOCTITE 19GM BLUE THREADLOCKER STICK	37686 LOCTITE 19GM RED THREADLOCKER STICK	37127 LOCTITE 561 PST THD SEALING STICK 19GM	37229 LOCTITE COPPER ANTISIEZE 19GM STICK	39148 LOCTITE 668 MED STR RETAINING STICK 19GM	39152 LOCTITE ORANGE GASKET ELIM 18GM STICK



ADHESIVES



IBS, INCORPORATED

Loctite Products S08

Thread Sealing

567 PST Thread Sealant

Pipe Sealant Formulated for Stainless Steel and all Metals

IBS No. 56747 - 50 ml tube

A general-purpose instant thread sealant for taper/taper threads. Excellent solvent resistance and eliminates galling on stainless steel. Ideal for stainless steel, iron, aluminum, galvanized steel and other metals. Controlled strength for easy disassembly with hand tools. Service temperature up to 480°F (250°C).

- Prevents leaks; does not shrink, crack, creep or shred.
- Resists vibration and shock loads.
- Seals to burst strength of most piping systems.
- Prevents galling and corrosion; eliminates seized assemblies.



Additional sizes available as non-stock items

No More Leaks™

Plastic Pipe Sealant

IBS No. 1537780 — 16. oz. brush can

Seals plastic pipes and allows easy disassembly. Specially formulated without the added lubricity of PTFE to avoid cracked fittings caused by overtightened joints.



Additional sizes available as non-stock items

Thread Sealant with PTFE

IBS No. 1527514 — 16 oz. brush can - Non Hardening

A general purpose sealant with the added lubricity of PTFE for metal pipes. Won't shred like PTFE tape and allows easy disassembly. Resists common shop fluids.



Additional sizes available as non-stock items

Tight Anaerobic Gel

IBS No. 51604 — 50 ml tube

Tight® is a multi-purpose anaerobic gel that seals, locks and retains. It seals against most liquids and gases and works well on coarse threads, large gaps, and all overhead applications. Use on nuts, bolts, studs, screws, threads.



Additional sizes available as non-stock items

A
D
H
E
S
I
V
E
S

IBS, INCORPORATED

Sealants & Adhesives S02



DriveGrip Anti Cam-Out Fluid

IBS No. 52010 0.5 FL oz. Tube

Drive Grip makes removing and tightening screws and other fasteners a breeze. A single drop creates a positive grip between the metal surfaces of the fastener head and drive tool. Works great in applications where fastener heads or drives are worn or damaged.

Drive Grip increases the grip strength between the fastener head and tool by as much as **700%** and virtually eliminates tool wear, rounding and deforming of fasteners

APPLICATIONS:

- Aids in the removal of rusted or “frozen-in-place” screws and bolts that won’t budge.
- Use Drive Grip in conjunction with all types of screwdrivers, hex keys, pliers, channel locks, vise grips, sockets, as well as open-end and box-end wrenches

BENEFITS:

- **Economical:** Spares the time and expense involved with drilling out screws, using “easy outs” or possibly having to re-tap holes.
- **Simplifies Operation:** Works with standard screwdrivers, reducing the need for specially designed screwdrivers, reamers, or drilling out damaged screws.
- **Averts injury:** Helps reduce fatigue and extreme effort that leads to injury.
- **Protects Surrounding Surfaces:** Prevents driver slippage.



Works with all types of screws:
Phillips™, Slotted, Hex, Square, Torx®



No need to drill out or use pliers on stubborn screws.



Prevents screwdriver from slipping and causing damage.

ADHESIVES

DriveGrip & Insert Bits (Z02)

IBS No. 787R 10 Items • 19 Pcs

Packaged in a locking plastic box for easy storage & organization

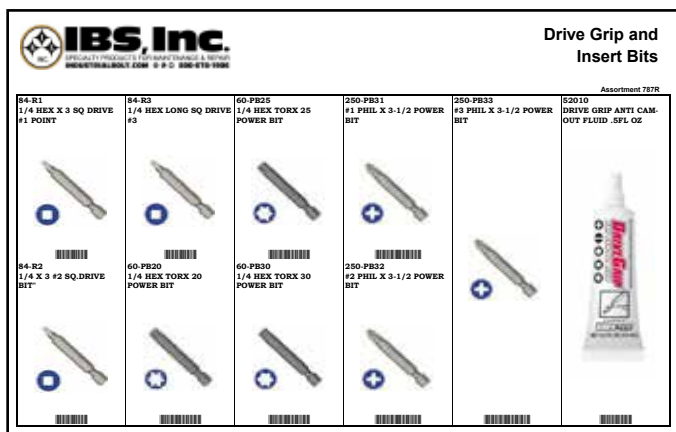

DriveGrip & Nutserts (Z02)

IBS No. 788R 6 Items • 9 Pcs

Packaged in a locking plastic box for easy storage & organization





IBS, INCORPORATED

Sealants & Adhesives S02

Thread Sealing

Anti-Seize Lubricant & Sealant

IBS No. AS022 — 16 oz. can

IBS No. EQ001 (Brush Top Dispenser)



A special blend of extra fine graphite and aluminum particles in synthetic oils. It's unique qualities prevent corrosion, seizure, and galling where two metals (including stainless steels) must come together to provide a tight make up. **It is effective to 2200°F** and also functions as a high temperature lubricant and sealant as well (we even package it in grease cartridges).

AS022 is absolutely non-melting, will not drip or run, and is superior to copper or lead based lubricants because it eliminates electrolysis, withstands higher temperatures and pressures and gives cleaner breakouts from high torques.

Unique brush pump dispenser for 16oz cans allows use of all the product in the can, cleaner application of the product (no messy hands), and keeps product from becoming contaminated.



Technical Data:

Temperature Range.....-20° to 2200°F
Flash Point.....C.O.C. 310°F
Color.....Silver
NLGI Grade.....No. 1
Water Resistance.....Insoluble
Protective equipment.....None
Poison Classification.....Non-toxic
Particle size.....Less than 1 micron

Typical Applications:

- Rollers and conveyors
- Gears, Chains, and Drives
- All Threaded Fittings
- Gaskets, Flanges, and O-rings
- Valve Stems and Cages
- Cylinder Head Assemblies
- Furnaces and Burner Assemblies
- Key ways, and Shaft Coupling Bolts
- Fuel injectors and Spark Plugs
- Low RPM Bearings

Note: Corrosive inhibitors: Conventional Imaduzoline Derivate,
EP Additive: diester Type - contains no Phosphorous, sulfur, or metal salt.
Raw materials used for manufacturing AS022 contains 0 ppm chlorides and 0 ppm heavy metals.
AS022 in grease cartridge fortified with molybdenum disulfide.

A
D
H
E
S
I
V
E
S

Adhesives

Blu-Goo

Super Sealant & Lubricant Fortified with Metalon™

IBS No. ML013-16 - 16 oz. Can with Brush Top

ACCESSORIES: EQ001 Pump Brush Dispenser for 16 oz can



Blu-Goo™ is a special blend of inert materials that offer a variety of industrial uses where reduction of metal to metal contact is desired. As a thread sealing compound, **Blu-Goo™** forms an interface between male and female threads that provides anti-galling/seizing protection of the joint, which can withstand pressures up to 20,000 psi, even in worn, corroded or badly machined thread surfaces.

Blu-Goo™ is also an excellent gear box additive. It forms a film over the internal parts, resulting in a noticeable reduction in play, gear noise, and leakage. It also reduces torque stress, allowing a reduction in drive power requirements. When applied to gasketed surfaces or used as a packing supplement, it prevents fluid leakage from around the seal.

Good for any application up to 600°F, **Blu-Goo™** will work on Stainless Steel, Aluminum, Iron, Brass, Fiberglass and Plastic. Not affected by acids, caustics or common solvents.

Typical Applications:

- Thread Sealant
- Gearbox Additive
- Gasket Dressing
- Packing Supplement
- Pump Lubricant
- Low Temperature Anti-Seize
- O-Ring Lubricant

APPLICATION INSTRUCTIONS:

Thread Sealing: Apply Blu-Goo to both male and female threads. Spread evenly with brush or other applicator. As connection is being made-up, Blu-Goo will "plate out" evenly over threads.

As Gearbox Additive: Mix Blu-Goo to gear oil in the following amounts: 1 quart, 1 oz. of Blu-Goo; 2 quarts, 2 oz.; 4 quarts, 3 oz.; 8 quarts, 5 oz.; 12 quarts, 6 oz.; 16 quarts, 7 oz.

As a Gasket Dressing: Coat one side of metal flange face. Press gasket into Blu-Goo on surface. Then coat exposed face of gasket. To help prevent leakage, also coat the inside edge of the gasket before making up flange.

As Packing Supplement: Coat each ring of packing. Put in place, seating each ring individually. Replace follower gland and hand tighten lightly. For other applications, apply similarly as products previously used.



IBS, INCORPORATED

Sealants & Adhesives S02

Adhesives

A
D
H
E
S
I
V
E
S

Multi-Purpose Adhesive

IBS No. 74510 — 3.70 oz. tube IBS No. 74511 — 10.2 oz. cartridge

MULTI-PURPOSE ADHESIVE is a highly versatile compound that exhibits exceptional adhesive and sealant characteristics. It will adhere to a larger variety of surfaces than most other adhesives with greater strength. It adheres to highly porous materials such as cinder blocks, or to non-porous surfaces such as glass, metal, or rubber.

MULTI-PURPOSE ADHESIVE is exceptionally flexible, highly abrasion resistant, non-corrosive, paintable, self-leveling, and maintains its properties under water. It has an elongation of 900% and a 400 volt per mil dielectric strength, so it is ideal for repairing cable and sealing electrical connections.

Note: Other size containers and colors available with special quote.



Technical Data

Color.....	Clear
Service Temperature Range.....	-40°F to 150°F
Hardness.....	80 Shore A
Tensile Strength.....	3500 lb/in2 (ASTM D-412)
Elongation.....	900%
Paint Over Time.....	24 Hours
Cure Times.....	Tack Time: 10 minutes
	Full Cure: 24 hours (Thin Film)
	Full cure: 48-72 hours (Thick Film)

Metalink Adhesives

Debonder™

IBS No. ML525 — 2 oz bottle

DEBONDER™ -The "Super-Glue Remover". Removes cured cyanoacrylate as well as most other adhesives, paint, oils, mold release, printer ink, and permanent markers. Great for softening thread locking compounds, removing signs, etc.



Accelerator™

IBS No. ML530 — 2 oz bottle

ACCELERATOR™ promotes instant cure of all cyanoacrylate adhesives. It increases gap fill and allows fillet forming. Great for tacking wires to circuit boards and hanging signs. It even enhances bond strength in some applications. Convenient pump spray delivery. Contains no CFC's.





Brushable Ceramic

IBS No. ML406 - 8# Kit (Includes 8 - 1# Containers, 4 Red, 4 Blue)
IBS No. ML406-2 - 2# Kit (Includes 2 - 1# Containers, 1 Red, 1 Blue)

ML406 Brushable Ceramic is a two component, brushable, 100% solids(solvent free) high technology polymer formula, combined with diamond-hard ceramic fillers that provide an exceptionally tough surface for wear and corrosion areas. It offers a high gloss surface to eliminate sticking and turbulence. In addition to withstanding fine particle abrasive attack, it also protects against moderate corrosion, and withstands temperatures up to 400°F / 95°C. Each ML406 kit contains two colors, (red and blue), so that by alternating layers, you can more easily gauge wear.

TYPICAL APPLICATIONS:

- Tube Sheets
- Water Boxes
- Pump Housings
- Impellers
- Tank Linings
- Cyclones
- Cort Nozzles
- Chutes, Pipes, & Elbows
- Hydroturbine Housings
- Discharge Nozzles
- Mixing Blades

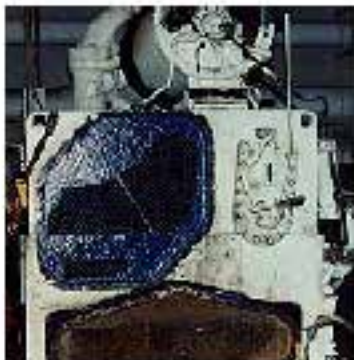

Tube Sheet Repair



Pump Repair

TECHNICAL DATA:

Compressive Strength (ASTM-D-695-54).....	21,000 psi
Tensile Strength (ASTM - D-638).....	4,800 psi
Operating Temperature (constant).....	250°F
Intermittent Temperature Fluctuations.....	up to 400°F
Dielectric Strength.....	500 volts/1 mil thickness (25 microns)
Hardness (Shore D).....	96 D
Working Time (Pot Life) @ 77°F.....	30 minutes
Cure Time @ 77°F.....	6 hours
Coverage.....	3 sq. ft. per pound @ 30 mils thick
Mix Ratio-By Volume.....	6 parts B to 1 Part A
By Weight.....	14 parts B to 1 Part A

APPLICATION INSTRUCTIONS:

1. Grind, sand, brush or grit-blast surface for best adhesion. Clean with (74156) MM Safety Solvent IV Degreaser and wipe dry. In humid climates it is advisable to flame brush the surface to prevent flash rusting and to help the polymer to "wet out". Apply MM Silicone Spray (74108) as a release agent to any area you do not want the compound to adhere to.
2. Mix all Resin and all of Hardener thoroughly until uniform in color (no streaks). Apply fully mixed material to desired surface with the enclosed brush.
3. Working time is 25 minutes at room temperature. Material is hard in 6 hours and fully cures in 12 hours. The curing time may be shortened considerably by heating the surface to 150 degrees F. Second coats may be applied as soon as the first coat is firm (usually about 45 minutes).



IBS, INCORPORATED

Sealants & Adhesives S02

Brushable Ceramic

CHEMICAL RESISTANCE AT AMBIENT TEMPERATURE

Tap Water.....	E
Sea Water.....	E
15% Hydrochloric Acid.....	E
20% Sulfuric Acid.....	E
10% Ammonia.....	E
30% Caustic Soda.....	E
Gasoline.....	E
Xylene.....	E
Toluene.....	G
Benzene.....	P
MEK.....	G
50% Ethanol.....	G
Methylene Chloride.....	P

E- Recommended for continuous immersion
 G- Recommended for intermittent contact
 P- Not recommended

WARNING:

This product is a potential skin sensitizer. May cause injury to eyes and skin following prolonged or repeated contact. Inhalation of vapor may cause respiratory tract irritation. Use adequate ventilation when applying to avoid inhalation of vapor. Prevent contact with eyes and skin. Read and understand M.S.D.S. sheet.

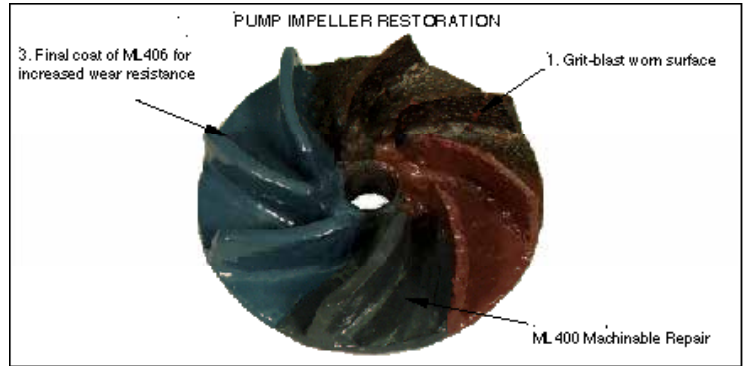

BRUSHABLE CERAMIC APPLICATIONS



ML406 BRUSHABLE CERAMIC - Centrifugal Pump Coating - Temple Inland, Buna, TX



ML406 BRUSHABLE CERAMIC - River Discharge Pump - Inland Container, Orange, TX



BRUSHABLE CERAMIC APPLICATIONS & TESTIMONIALS



October 20, 1995

Mr. Rodney Robinson
 P.O. Box 491
 Honey, Texas 77888

Dear Mr. Robinson,

We recently removed several secondary coolers from our 20,000-gallon unit that had been coated with your Metabond products these years ago. The coolers were used in fresh water service.

Heavy corrosion was present on uncoated areas. The parts of the coolers that were coated with Metabond performed extremely well with little or no signs of corrosion. We are in the process of re-coating parts of the old equipment that were unprotected.

We expect similar outstanding results in the future. Thanks for your help in keeping our maintenance costs down.

Sincerely,

 Roger A. Baker
 DuPont Eng. Services

September 12, 1996

To Whom It May Concern:

I have been a user of Metabond Polymer and Adhesive products for over seven years. As a Contractor assigned to the DuPont Ciba-Geigy Sabine Works plant, I have applied a variety of Metabond epoxy compounds in various and numerous applications. In all applications I have found the products to perform extremely well, and exactly what they are purported to be. They have performed so well that Metabond Products have become the epoxy contractor of choice by DuPont engineers. I also have found the staff of Applied Maintenance Specialties, Inc. to be very knowledgeable in application particulars and problem solving.

Sincerely,

 Walter A. Clark
 Service Environmental Company
 Beaumont, TX
 409-886-9654

City of Tacoma
 Public Works Department
 1000 1st Avenue
 Tacoma, WA 98401-7111
 (360) 525-2338

October 18, 1996

City of Tacoma
 Public Works Department
 Senior Utility Director
 2301 The Strand Ave.
 Tacoma, WA 98401-7111
 (360) 525-2338

The City of Tacoma utilizes the storm drainage sewer from the local geographical area for the effluent of the major water treatment facility. This system includes a large number of silt or sludge settling tanks and numerous other water treatment units, including a biological treatment system.

We have used a product as protect these critical components supplied by Ibsco. This product allows a ceramic coating on the base material which allows the ceramic material to wear rather than the base material itself.

IBS has introduced a ceramic coating to us in June 1996 which helped to provide the same protection. This product, called economic ceramic repair was tested against our previous product. The test consisted of a simulation of 120 psi water used on a very concentrated area on both the Ibsco and Metabond products. We found the Ibsco product failed after one month. The Metabond product was still intact after three months.

Thanks to the test results dramatically favored the Metabond ceramic product, our proof of performance is in the installed equipment. The IBS Metabond Ceramic Repair was applied to pump discharge pipe protrusions which were then installed in their original locations.

In the past, the Ibsco product would have required an application of the Ibsco product every two to ten years. The Metabond product was checked after one year. No wear whatsoever was discovered.

The Metabond product has been protecting our critical components for over four months with the initial coating. In our opinion, this product represents a significant labor and equipment savings to the city of Tacoma.

Dan Skene
 WWTP Maintenance Supervisor



October 18, 1996

City of Tacoma
 Public Works Department
 Senior Utility Director
 2301 The Strand Ave.
 Tacoma, WA 98401-7111
 (360) 525-2338

The City of Tacoma utilizes the storm drainage sewer from the local geographical area for the effluent of the major water treatment facility. This system includes a large number of silt or sludge settling tanks and numerous other water treatment units, including a biological treatment system.

We have used a product as protect these critical components supplied by Ibsco. This product allows a ceramic coating on the base material which allows the ceramic material to wear rather than the base material itself.

IBS has introduced a ceramic coating to us in June 1996 which helped to provide the same protection. This product, called economic ceramic repair was tested against our previous product. The test consisted of a simulation of 120 psi water used on a very concentrated area on both the Ibsco and Metabond products. We found the Ibsco product failed after one month. The Metabond product was still intact after three months.

Thanks to the test results dramatically favored the Metabond ceramic product, our proof of performance is in the installed equipment. The IBS Metabond Ceramic Repair was applied to pump discharge pipe protrusions which were then installed in their original locations.

In the past, the Ibsco product would have required an application of the Ibsco product every two to ten years. The Metabond product was checked after one year. No wear whatsoever was discovered.

The Metabond product has been protecting our critical components for over four months with the initial coating. In our opinion, this product represents a significant labor and equipment savings to the city of Tacoma.

Dan Skene
 WWTP Maintenance Supervisor

A
D
H
E
S
I
V
E
S



BRUSHABLE CERAMIC APPLICATIONS

Cooling Tower Distribution Pipe Repair



Repair and Coating of Main Cooling Tower Water Distribution Pipe (36" x 92ft Long) at Bayer Rubber Plant, Orange, TX

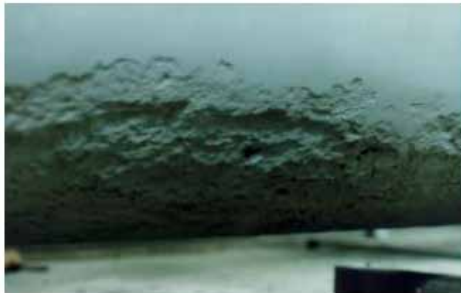

Upon inspection of the pipe during a scheduled plant turn-around, it was discovered that continuous leaks had caused massive erosion on the bottom of the pipe. Replacement of pipe was not an option due to fire restrictions and time constraints.



Pipe was repaired in place with approximately \$66,000 of Machinable Repair and Paint On Ceramic Coating. Estimated saving for replacement of pipe: \$325,000.

BRUSHABLE CERAMIC APPLICATIONS

HEAT EXCHANGER TUBE SHEET REPAIR



Step 1. Freshly sand blasted tube sheet holes are filled with cork and all gasket surfaces are taped up.



Step 2. Surface dust is cleaned off with Maintenance Magic Safety Solvent IV Degreaser and ML406 Brushable Ceramic is applied.



Step 3. Cork and tape removed. ML406 provides a corrosion and cavitation resistant surface that will provide many more years of service.

Tube sheet repair performed for Carrier Corporation.

BRUSHABLE CERAMIC APPLICATIONS

FLAT BACK ELBOWS ON CHIP BLOW LINES



FLAT BACK ELBOWS receive a great degree of wear as they divert the flow of chips or wood particles in a blow line. ML406 Brushable Ceramic Coating is used for increased wear resistance and also to decrease friction that leads to clogging.



For best protection, two coats of ML406 are applied to the interior of the elbow (one end and one blue). When the unit is disassembled for inspection it is easy to determine wear patterns in the coating.



The "Flat Back" portion of the elbow is coated thicker than the rest, as it receives the majority of the wear. ML406 Brushable Ceramic may also be used to coat the inside of the Chipper Housing and any Chip Fan Housings and Impellers.

Flat Back Elbow Repair at Inland Paperboard, Orange TX

ADHESIVES



IBS, INCORPORATED

Sealants & Adhesives S02

Dillo Hyde™ Wear Systems Ceramic Hexagonal Wear Plate

IBS Numbers:

- ML200-125 1/8" x 6" x 6" (48 sheets per box)
- ML200-125H 1/8" 1/2"-Tile for edge finishing
- ML200-250 1/4" x 6" x 6" (36 sheets per box)
- ML200-250H 1/4" 1/2"- Tile for edge finishing
- ML200-125KT Dillo Hyde Kit with 12ea 1/8" x 6" x 6" tiles & 1 lb M406
Brushable Ceramic
- ML200-250KT Dillo Hyde Kit with 12ea 1/4" x 6" x 6" tiles & 1 lb M406
Brushable Ceramic

NOTE: ORDERED AS NON-STOCK ITEMS

"Dillo Hyde" ceramic hexagonal wear plates represent the absolute ultimate in wear technology today. Each .80 inch tile is made of Sapphire-hard 87% Alumina Ceramic and is pre-mounted on 6" square mats to facilitate application. At a "9+" on the Mohs Hardness Scale, "Dillo Hyde™" is second only to a diamond in hardness and provides the ultimate abrasion resistant coating for a variety of material handling environments. When combined with our ML406 Brushable Ceramic Coating as an adhesive, the two form a tough, wear-resistant coating that will outlast epoxies, hard-plating, metalizing powders, or hard-surfacing electrode deposits many times over.



'DILLO HYDE™ used to repair contoured discharge area of exhaust fan housing.

Characteristics:

Easy Application:

The flexible 6" square mats will bend to fit a variety of curved sections such as pipe, pump casings, elbows, etc. Installation methods include epoxy, refractory cement, and tile adhesive.

Temperature resistant:

Maintains wear-resistant qualities at elevated temperatures (-50° to +2000°F).

Corrosion Resistant:

Resistant to attack by hydrocarbons, most alkalies or mineral acids (except hydrofluoric).

Inert:

Alumina Ceramic is non-toxic, non-allergenic, non-contaminating, and non-hazardous to persons or the environment. It will not rust, oxidize, discolor, or decompose.

Super Hard:

9+ on the Mohs Hardness Scale; second only to diamonds in hardness among natural materials.

DILLO HYDE™ WEAR SYSTEMS Hardness Comparison (MOHS)

Diamond	10
Sapphire	9
Dillo Hyde	9
Topaz	8
Quartz	7
Tool Steel	6.5
Glass	5.5
Carbon Steel	5.5
Limestone	4



Pipe Repair

Seal-Skin™

IBS No. ML450, 2 " X 5' roll

IBS No. ML450-4, 4" x 15' roll

Resin-coated, fiberglass cloth designed for rapid repair of ruptured piping and other patch jobs. It is moisture activated (reacting with or without water immersion), making it excellent for water or steam line repairs. Sets up in approximately 30 minutes. It works on PVC, metal, rubber, fiberglass, plastic and other type materials. Has high adhesive qualities. Odorless, non-combustible. Can be sanded or painted.

TECHNICAL DATA:

Compressive Strength.....	26,600 psi
Tensile Strength.....	24,900 psi
Flexural Strength.....	16,100 psi
Bond Strength.....	98 psi
Barcol Hardness.....	53
Heat Resistance.....	1,100°F
Dielectric Strength.....	16,060 Volts
Cure Time @ 75°F.....	30 minutes



A
D
H
E
S
I
V
E
S



IBS, INCORPORATED

Aerosols & Chemicals S04

Epoxy Repair Products

EZ-Poxy Aqua

**PERMANENTLY REPAIRS WET AREAS
AND UNDERWATER SURFACES**
IBS No. 74505

EZ-Poxy Aqua bonds tenaciously to fiberglass, metal, wood, concrete, ceramic, glass and other surfaces in either fresh or salt water.



Easy To Use!

- 1) Cut or break off equal portions of light and dark material.
- 2) Roll and knead putty in hands until streaks disappear and color is uniform.
- 3) Apply at once to surface, remove excess before hardening starts.

Features:

- Easy to Use
- Cures under water in just 60 minutes.
- Contains fading blue dye that turns pure white after mixing.

PERFORMANCE DATA*:

Working Life (minutes)	20 - 30
Shelf Stability (months @ 75°F, min.)	24
Hardness, Shore D (full cure, 24 hrs.)	65 - 75
Lap Shear Tensile Strength	
On Steel (1" x 1" x 1/16") lbs	800-1000
On Fiberglass (1" x 1" x 1/16") lbs	500
Compressive Strength (psi)	10-14,000
Density (gm/cm ³ , lb/gal)	1.9, 15.8
Shrinkage (%)	<1
Non-Volatile Content (%)	100
Electrical Resistance (megohms)	30,000
Dielectric Strength (volts/mil)	300
Upper Temperature Limit	
Continuous (°F)	250 (121°C)
Intermittent (°F)	300 (149°C)

CHEMICAL RESISTANCE:

Resistance to hydrocarbons, ketones, alcohols, esters, halocarbons, aqueous salt solutions and dilute acids and bases.

* Typical properties; for information only; not for specification purposes.

READ MSDS SHEET BEFORE USING

APPLICABLE STANDARDS

USDA Meets the USDA requirements for use in federally inspected meat and poultry plants.
ABS Certified by the American Bureau of Shipping for use on marine vessels.



1. Cut

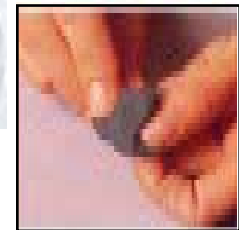

2. Mix



3. Apply

USE ON . . .

- Scratches
- Patching cuts & holes
- Fiberglass
- Metal
- Wood
- Pipes
- Fittings
- Electrical connections
- Leaking gaskets
- Fuel Tanks
- Water Tanks
- Tubs
- Sinks
- Pools
- Battery cables

A
D
H
E
S
I
V
E
S



Epoxy Repair Products E-Z Poxy Steel

FOR STEEL HARD REPAIRS IN A STICK

IBS No. 74502

E-Z Poxy Steel combines steel reinforced epoxy resin and hardener side by side in a 6" x 3/4" stick, conveniently packed in an easy to carry plastic tube. After just one hour, **E-Z Poxy Steel** can be drilled, tapped, sanded, machined or painted.



Easy To Use!

- 1) Cut or break off equal portions of light and dark material.
- 2) Roll and knead putty in hands until streaks disappear and color is uniform.
- 3) Apply at once to surface, remove excess before hardening starts.

PERFORMANCE DATA:

Working Life (minutes)	3 - 5
Shelf Stability (months @ 75°F, min.)	24
Hardness, Shore D (full cure, 24 hrs.)	75 - 8

Lap Shear Tensile Strength	
On steel (1" x 1" x 1/16") lbs	800 - 1,000
Compressive Strength (psi)	10 - 14,000
Shrinkage (%)	<1
Non-Volatile Content (%)	100
Electrical Resistance (megohms)	30,000
Dielectric Strength	300
Upper Temperature Limit	
Continuous (°F)	250°F (121°C)
Intermittent (°F)	300°F (149°C)

CHEMICAL RESISTANCE:

Resistance to hydrocarbons, ketones, alcohols, esters, halocarbons, aqueous salt solutions and dilute acids and bases.

Not to be used for specification purposes.

** Typical properties; for information only; not for specification purposes.*

READ MSDS SHEET BEFORE USING

APPLICABLE STANDARDS

- USDA** Meets the USDA requirements for use in federally inspected meat and poultry plants.
- ABS** Certified by the American Bureau of Shipping for use on marine vessels.
- NSF** Certified by the National Sanitation Foundation for use in contact with drinking water.



1. Cut

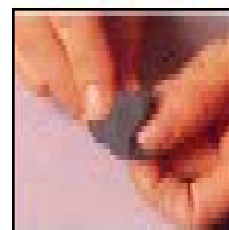

2. Mix



3. Apply

FEATURES

- Mixes like putty.
- Hardens like steel.
- Even cures underwater.

USE ON . . .

- Tanks
- Radiators
- Bathroom Fixtures
- Tile
- Cars
- Boats
- Furniture
- Metal & Wood
- Down spouts
- Gutters
- Garbage Cans
- Valves, Etc.



IBS, INCORPORATED

Aerosols & Chemicals S04

Epoxy Repair Products

EZ-Poxy Wood

WOOD REPAIR EPOXY PUTTY STICK

IBS No. 74506



EZ-Poxy Wood Epoxy Putty Stick is a fast-setting polymer compound that enables permanent repairs to wood. It also bonds to metals, glass, masonry, and many plastics. Each handy stick contains pre-measured portions of activator and base throughout — no measuring or mixing tools are necessary. As the epoxy is mixed, the two contrasting colors blend into one color to indicate complete mixing. The consistency (like modeling clay) eliminates drips and runs, facilitates adhesion to the substrate, and allows the material to be shaped, formed and sculpted as needed before the curing begins. Cured EZ-Poxy Wood has a hardness and density similar to that of wood. Once cured, it can be tapped, drilled, sawed, filed, carved sanded, painted or stained.* Suitable for interior or exterior use, it is resistant to water, chemicals, and temperature extremes. Contains no solvents or VOC's. It's non-flammable and releases no noxious fumes. It won't shrink, rot or pull away. The unmixed portion stays fresh for future use when saved in the original package.

* *Staining: EZ-Poxy Wood may accept stain differently from the surrounding wood. Some types of oil-based stains may be added during the mixing step.*

PERFORMANCE DATA*:

Working Life (minutes)	15 - 25
Shelf Stability (months @ 75°F, min.)	24
Hardness, Shore D (full cure, 24 hrs.)	70 - 80
Lap Shear Tensile Strength	
On Steel (1" x 1" x 1/16") lbs	800-1000
On Oak (1" x 1" x 1/16") lbs	500
Compressive Strength (psi)	10-14,000
Density (gm/cm ³ , lb/gal)	9, 7.5
Shrinkage (%)	<1
Non-Volatile Content (%)	100
Electrical Resistance (megohms)	30,000
Dielectric Strength (volts/mil)	300
Upper Temperature Limit	
Continuous (°F)	250 (121°C)
Intermittent (°F)	300 (149°C)

CHEMICAL RESISTANCE:

Resistance to hydrocarbons, ketones, alcohols, esters, halocarbons, aqueous salt solutions and dilute acids and bases.

* *Typical properties; for information only; not for specification purposes.*

READ MSDS SHEET BEFORE USING

REBUILD...

- stripped screw holes
- scratches
- gouges & cracks
- dry rot
- knot holes
- carpenter bee damage

RESHAPE...

- handles and knobs
- level chair legs
- carvings

RESTORE...

- furniture
- molding and trim
- picture frames
- antiques



1. Cut

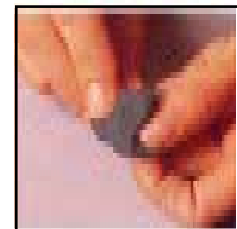

2. Mix

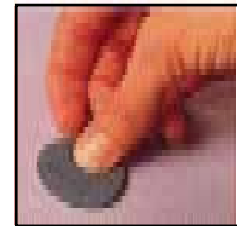

3. Apply

APPLICABLE STANDARDS

USDA Meets the USDA requirements for use in federally inspected meat and poultry plants.

ABS Certified by the American Bureau of Shipping for use on marine vessels.

ADHESIVES



Epoxy Repair Products

EZ-Poxy Aluminum

ALUMINUM REINFORCED EPOXY PUTTY STICK

IBS No. 74508



EZ-Poxy Aluminum Epoxy Putty Stick is a fast-setting polymer compound that enables permanent repairs to anything made of aluminum. It also bonds to metals, glass, masonry, and many plastics. Each handy stick contains pre-measured portions of activator and base throughout — no measuring or mixing tools are necessary. As the epoxy is mixed, the two contrasting colors blend into one color to indicate complete mixing. The consistency (like modeling clay) eliminates drips and runs, facilitates adhesion to the substrate, and allows the material to be shaped, formed and sculpted as needed before the curing begins. Cured EZ-Poxy Aluminum cures to a light gray metallic color. Once cured, it can be tapped, drilled, screwed, sawed, filed or painted. Suitable for interior or exterior use, it is resistant to water, chemicals, and temperature extremes. Contains no solvents or VOC's. It's non-flammable and releases no noxious fumes. It won't shrink or pull away. The unmixed portion stays fresh for future use when saved in the original package.



REPAIR...

- gutters
- storm doors
- windows
- aluminum siding
- boats
- RV's

MEND...

- machine parts
- air conditioners
- wheels
- tanks
- pipes
- castings
- radiators

FILL...

- cracks
- holes



1. Cut

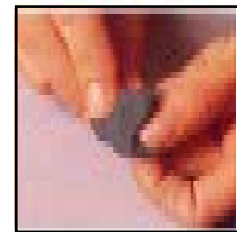

2. Mix



3. Apply

Performance Data*

Shelf Life (months @ 75°F, min)	24
Hardness, Shore D (full cure, 1 hr).....	80
Lap Shear Tensile Strength (psi)	
On Aluminum	500
On Steel600
Compressive Strength (psi)	12,000
Density (gm/cm ² , lb/gal)	1.6, 13.4
Shrinkage (%).....	<1
Non-Volatile Content (%).....	100
Electrical Resistance (megohms)	30,000
Dielectric Strength (volts/mil)	300
Upper Temperature Limit	
Continuous (°F)	250
Intermittent (°F)	300
Chemical Resistance	
Resistant to hydrocarbons, ketones,	
esters, halocarbons, aqueous salt	
solutions and dilute acids and bases.	

* Typical properties; for information only; not for specification purposes.

APPLICABLE STANDARDS
USDA Meets the USDA requirements for use in federally inspected meat & poultry plants



IBS, INCORPORATED

Aerosols & Chemicals S04

Epoxy Repair Products

EZ-Poxy Plastic

PLASTIC REPAIR EPOXY PUTTY STICK

IBS No. 74507



EZ-Poxy Plastic Epoxy Putty Stick is a fast-setting polymer compound that enables permanent repairs to all major plastic types except polyolefins (polyethylene / polypropylene). It also bonds to metal, wood, glass, and masonry. Each handy stick contains pre-measured portions of activator and base throughout — no measuring or mixing tools are necessary. As the epoxy is mixed, the two contrasting colors blend into one color to indicate complete mixing. EZ-Poxy Plastic contains a fading blue dye and becomes white after mixing. The consistency (like modeling clay) eliminates drips and runs, facilitates adhesion to the substrate, and allows the material to be shaped, formed and sculpted as needed before the curing begins. Once cured, it can be drilled, screwed, carved, sawed or painted. Suitable for interior or exterior use, it is resistant to water, chemicals, and temperature extremes. Contains no solvents or VOC's. It's non-flammable and releases no noxious fumes. It won't shrink or pull away. The unmixed portion stays fresh for future use when saved in the original package.

A
D
H
E
S
I
V
E
S

Performance Data*

Shelf Life (months @ 75°F, min)24
Hardness, Shore D (full cure, 24 hrs)65
Lap Shear Tensile Strength (psi)	
On PVC350
Compressive Strength (psi)10,000
Density (gm/cm ² , lb/gal)1.6, 13.4
Shrinkage (%)<1
Non-Volatile Content (%)100
Electrical Resistance (megohms)30,000
Dielectric Strength (volts/mil)300
Upper Temperature Limit	
Continuous (°F)250
Intermittent (°F)300

Chemical Resistance

Resistant to hydrocarbons, ketones, esters, halocarbons, aqueous salt solutions and dilute acids and bases.

** Typical properties; for information only; not for specification purposes.*

REBUILD...

- rigid plastics
- semi-flexible plastics

REPAIR...

- automotive trim
- appliance parts
- PVC furniture
- vinyl siding
- plastic downspouts & gutters

SEAL...

- leaks in PVC and ABS plastic plumbing pipes



1. Cut



2. Mix



3. Apply

APPLICABLE STANDARDS

USDA Meets the USDA requirements for use in federally inspected meat and poultry plants.

NSF Certified by the National Sanitation Foundation for use in contact with drinking water.



Epoxy Repair Products

EZ-Poxy Concrete

CONCRETE REPAIR EPOXY PUTTY STICK

IBS No. 74509



ADHESIVES

EZ-Poxy Concrete Repair Epoxy Putty Stick is a hand-mixable, fast-setting epoxy putty that quickly repairs concrete and masonry. It also bonds to metals, wood, glass, and many plastics. After mixing, it forms a concrete repair polymer that cures to a concrete-like color and texture. Each handy stick contains a pre-measured portions of activator and base throughout — no measuring or mixing tools are necessary. The consistency (like modeling clay) eliminates drips and runs, facilitates adhesion to the substrate, and allows the material to be shaped and formed as needed before curing begins. Once functional cure is reached (within minutes after application) it can be drilled, sawed, tapped, filed, sanded and painted. Suitable for interior or exterior use, it is resistant to water, chemicals, and temperature extremes. EZ-Poxy Concrete contains no solvents or VOC's. It's non-flammable and releases no noxious fumes. It won't shrink or pull away. The unused portion stays fresh for future use when saved in its original package.

Performance Data*

Shelf Life (months @ 75°F, min)24
Hardness, Shore D (full cure, 24 hrs)65
Lap Shear Tensile Strength (psi)	
On PVC350
Compressive Strength (psi)10,000
Density (gm/cm ² , lb/gal)1.6, 13.4
Shrinkage (%)<1
Non-Volatile Content (%)100
Electrical Resistance (megohms)30,000
Dielectric Strength (volts/mil)300
Upper Temperature Limit	
Continuous (°F)250
Intermittent (°F)300
Chemical Resistance	
Resistant to hydrocarbons, ketones, esters, halocarbons, aqueous salt solutions and dilute acids and bases.	

* Typical properties; for information only; not for specification purposes.

PATCH...

- floors, curbs, steps
- mortar, concrete

REPAIR...

- tile, statues
- lawn ornaments
- birdbaths
- cemetery headstones
- cracks and seams

ANCHOR...

- bolts, screws
- nails
- railings
- legs

SEAL...

- basement leaks
- tie rod holes

APPLICABLE STANDARDS
USDA Meets the USDA requirements for use in federally inspected meat and poultry plants.



1. Cut



2. Mix



3. Apply



IBS, INCORPORATED

Assortments Z08

Epoxy Repair Products

2-Part EZ-Poxy Sticks Assortment

IBS No. 640P • 6 Items • 12 Pieces

Packaged in a labeled, locking steel drawer for easy storage & organization

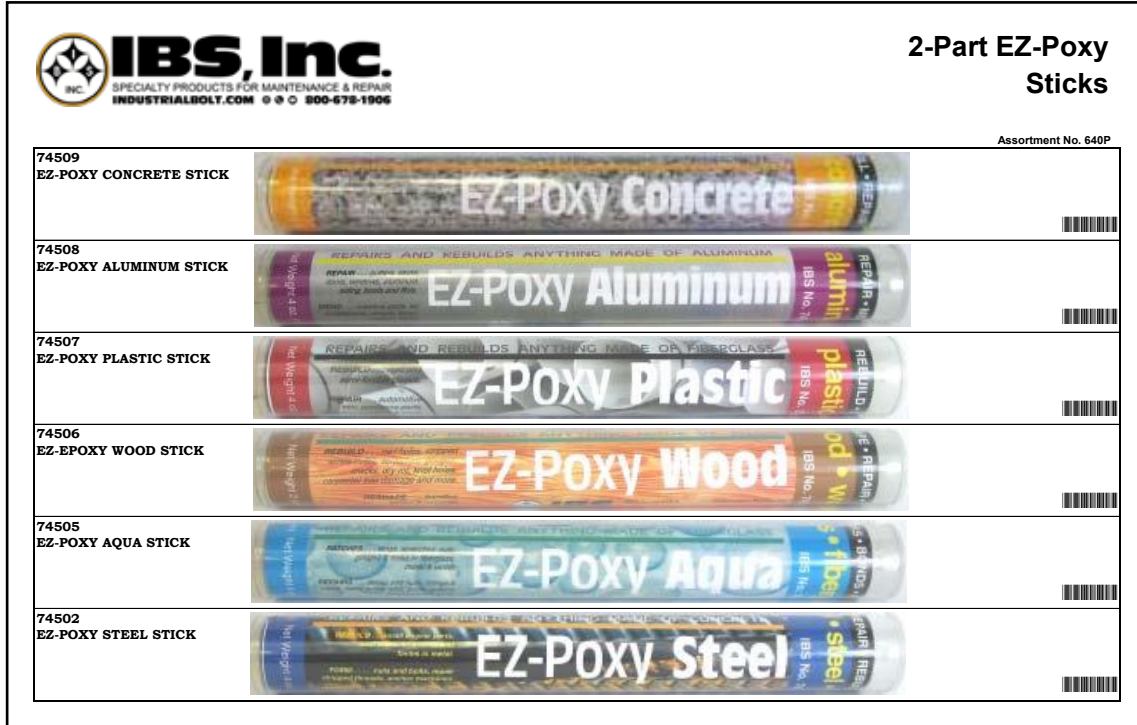

ADHESIVES

IBS No.	Name	Description	Applicable Standards	Cured Color
74509	EZ-Poxy Concrete Epoxy Stick Concrete repair epoxy putty	Repairs and rebuilds anything made of concrete	USDA	Grey
74508	EZ-Poxy Aluminum Epoxy Stick Aluminum reinforced epoxy putty	Repairs and rebuilds anything made of aluminum	USDA	Grey Metallic
74507	EZ-Poxy Plastic Epoxy Stick Plastic repair epoxy putty	Repairs & rebuilds anything made of ABS, CPVC, & PVC plastic	NSF	White
74506	EZ-Poxy Wood Epoxy Stick Wood repair epoxy putty	Repairs and rebuilds anything made of wood	USDA ABS	Light Wood
74505	EZ-Poxy Aqua Epoxy Stick Underwater repair epoxy putty	Repairs and rebuilds anything made of fiberglass	USDA ABS	White
74502	EZ-Poxy Steel Epoxy Stick Steel reinforced epoxy putty	Repairs and rebuilds anything made of steel	USDA ABS; NSF	Dark Metallic

APPLICABLE STANDARDS:

USDA - Meets the USDA requirements for use in federally inspected meat and poultry plants.

NSF - Certified by The National Sanitation Foundation for use in contact with drinking water.

ABS - Certified by The American Bureau of Shipping for use on marine vessels.

Aerosols



Spray Adhesive

IBS No. 74130

Spray Adhesive is recommended for decorative laminate to particleboard and MDF (medium density fiberboard) substrates, metals and plywood. This product has an adjustable tip offering the user a webbing type spray that is water white and does not contain Methylene Chloride. The unique formula prevents soak-in of the adhesive on porous surfaces. It offers the user very high coverage with a fast track time for general purpose bonding of a wide variety of substrates. Provides both temporary and permanent bonds.

Heat Resistant

for high temperature applications up to 140°F (60°C).

Superior Strength

handles heavy duty applications.

Permanent Bond

assures durability.

Fast Assembly

minimizes downtime.

Multi-Purpose

provides versatility.

Applications

Ideal for laminates, trim, signs, kick plates, woodworking, maintenance and asbestos removal. Adheres to most surfaces including wood, metal, glass and plastic.

CASE QTY = 12 CANS

- **Non Chlorinated**
- **Non-Ozone Depleting**
- **Wide Web Spray**
- **High Solids**

FOR INDUSTRIAL / PROFESSIONAL USE ONLY

KEEP OUT OF REACH OF CHILDREN

ALWAYS READ LABEL FOR COMPLETE DIRECTIONS AND PRECAUTIONS



IBS, INCORPORATED

Aerosols & Chemicals S04

Aerosols

R.T.V. Gasket Maker & Sealer With Spray Can Application

IBS No. 74131 - Black

IBS No. 74133 - Clear

R.T.V. Gasket Maker & Sealer is a single component room temperature vulcanizing silicone rubber. When applied as a formed-in-place gasket, it reacts with moisture in the air and cures to a rubber like product. RTV will adhere to clean metal, glass, most types of wood, silicone resin, vulcanized silicone rubber, ceramic, natural and synthetic fiber as well as painted and many plastic surfaces. R.T.V. Gasket Maker & Sealer has the convenience of a spray which means no more messy tubes and much less waste. With R.T.V. Gasket Maker & Sealer you can lay down a precise bead every time and claim 98% of R.T.V. from every can. Seals, bonds, and caulks. Makes any shape and size gasket on the spot.

A
D
H
E
S
I
V
E
S



Tough Silicone Adhesive - Adheres to and bonds natural and synthetic fibers, glass, metal, wood, other silicone rubber, hard-to-stick-to plastics, masonry products, etc.

Numerous Maintenance Applications - Seals against water, air, chemicals, oils and grease. Fills crevices and irregularities in joints. Waterproofs porous materials and perfect for weather-stripping. Insulates against shock and vibration and is a great electrical insulator. A perfect gasket maker for just about anything.

Typical Uses - Gasketing pumps, oil pans, valve covers, gear boxes and compressors.

General Uses - Seals windows, pipe joints, parts. Bonds gaskets, appliance parts, sign letters. Caulks joints duct work, equipment housings.

Resists Against - Fungus, ozone, weathering, aging, chemicals, aliphatic and aromatic compounds and shrinking.

Typical Property Characteristics - Tack-free in just 5 minutes and cure time at 1/8" thickness is just 24 hours. Tensile strength 350 psi. Can be used for extended periods at temps. up to 450°F and for shorter periods at 500°F.

**CASE QUANTITY - 6 CANS
SOLD EACH**

FOR INDUSTRIAL / PROFESSIONAL USE ONLY

KEEP OUT OF REACH OF CHILDREN

ALWAYS READ LABEL FOR COMPLETE DIRECTIONS AND PRECAUTIONS



Aerosols

R.T.V. Gasket Maker & Sealer With Spray Can Application

Comparison Test Against 3 oz. and 12 oz. tubes

12 oz. SqueezeTube

1. Fill Wt	12 ounce
2. Dispensed Wt	9-½ ounce
3. Total Feet Dispensed	42 feet of material (504 inches)
4. Feet Dispensed/per ounce	4.4 feet
5. Product Retention in Tube	2-¼ ounce or 21%

3 oz. Squeeze Tube

1. Fill Wt	3 ounce
2. Dispensed Wt	2.4 ounce
3. Total Feet Dispensed	9 feet of material (108 inches)
4. Feet Dispensed/per ounce	5 feet
5. Product Retention in Tube	.6 ounce or 20%

Maintenance Magic 8 oz. Automatic Tube

1. Fill Wt	8 ounce
2. Dispensed Wt	7-½ ounce
3. Total Feet Dispensed	60 ft of ⅛ in. bead (720 in.*)
4. Feet Dispensed/per ounce	7.7 feet
5. Product Retention in Tube	½ ounce or 6%

*This figure increases to 1056 inches when the product is used with the threaded taper nozzle attachment (IBS No. RL16065).

ALL MEASUREMENTS ARE BASED ON AVERAGE RESULTS

Based on actual material in place. Maintenance Magic's pressurized can is far more economical in shop use. No more broken squeeze tubes because Maintenance Magic's can dispenser protects product and allows 98% of product to be used.



IBS, INCORPORATED

Aerosols & Chemicals S04

Aerosols

R.T.V. Hi-Temp Red Gasket Maker & Sealer

WITH SPRAY CAN APPLICATION

IBS No. 74153

R.T.V. Gasket Maker & Sealer is a single component room temperature vulcanizing silicone rubber. When applied as a formed-in-place gasket, it reacts with moisture in the air and cures to a rubber like product. RTV will adhere to clean metal, glass, most types of wood, silicone resin, vulcanized silicone rubber, ceramic, natural and synthetic fiber as well as painted and many plastic surfaces. **R.T.V. Gasket Maker & Sealer** has the convenience of a spray which means no more messy tubes and much less waste. With R.T.V. Gasket Maker & Sealer you can lay down a precise bead every time and claim 98% of R.T.V. from every can. Seals, bonds, and caulks. Makes any shape and size gasket on the spot.

Long Life Expectancy - in excess of 10 years. Excellent Resistance To Weathering, vibration, moisture, ozone, and extreme temperatures. Can be used for extended periods at temperatures up to 600° F and for shorter periods at 650° F. Tests have shown that even after 2 months at 600° F or one week at 650° F, the sealant remains rubbery.

Physical Properties - Tack-free in 15 minutes, complete cure in 24 hours (1/8" thickness). Uses moisture in the air to cure.

Tensile Strength - 350 psi.

Elongation - 500%

Applications & Uses - Bonds glass, wood, plaster. Seals windows, doors, and seams in RV's and campers. Caulks around sinks and toilets. Seals cracks in tiles. Great for waterproofing. Seals water pipes and drain pipes. Insulates electrical connections.



**CASE QUANTITY - 6 CANS
SOLD EACH**

FOR INDUSTRIAL / PROFESSIONAL USE ONLY

KEEP OUT OF REACH OF CHILDREN

ALWAYS READ LABEL FOR COMPLETE DIRECTIONS AND PRECAUTIONS

A
D
H
E
S
I
V
E
S

Aerosols

R.T.V. Low Volatile Blue

WITH SPRAY CAN APPLICATION

IBS No. 74631

R.T.V. Gasket Maker & Sealer is a single component room temperature vulcanizing silicone rubber. When applied as a formed-in-place gasket, it reacts with moisture in the air and cures to a rubber like product. RTV will adhere to clean metal, glass, most types of wood, silicone resin, vulcanized silicone rubber, ceramic, natural and synthetic fiber as well as painted and many plastic surfaces. **R.T.V. Gasket Maker & Sealer** has the convenience of a spray which means no more messy tubes and much less waste. With R.T.V. Gasket Maker & Sealer you can lay down a precise bead every time and claim 98% of R.T.V. from every can. Seals, bonds, and caulks. Makes any shape and size gasket on the spot.



TEMPERATURES

Silicone rubber offers both extreme low and high temperature resistance properties. It remains flexible to -60 deg C (-76 deg F) and although modulus increases, does not become brittle. These products will also withstand high temperatures up to +177 deg C (+350 deg F) during continuous operation, and up to +204 deg C (+400 deg F) for short periods. For extreme high temperatures, RED HI TEMP is recommended. This has a temperature range of +232 deg C (+450 deg F) for continuous operation, and +260 deg C (+500 deg F) for short periods

WEATHERABILITY

Because this material is 100% solids and contains no extenders or plasticizers, shrinkage due to weathering is negligible. Because of the chemical makeup, resistance to ultraviolet light and ozone is excellent

CHEMICAL RESISTANCE

This product offers good resistance to most solvents and oils, organic and inorganic chemicals; however, it is not recommended for continuous use with gasoline or fuel oil. Swelling or degradation may occur with these and certain other hydrocarbon materials. Chemical compatibility should be tested for each application considered

TYPICAL USES:

- Adhering auto and appliance trim, including metal, fabric and fabric-backed plastics.
- Bonding gaskets in heating and refrigeration units.
- Sealing of marine cabins and windows.
- Filleting and caulking joints in sheet metal stacks, duct work, and equipment housings.
- Formed-in-place gaskets for engines, transmissions, differentials, gear boxes, compressors, pumps and all types of equipment and machinery.
- Sealing windows in oven doors and flues on gas appliances, flanged pipe joints and access doors.
- Anywhere a tight leakproof seal is required.

CASE QUANTITY - 6 CANS
SOLD EACH

FOR INDUSTRIAL / PROFESSIONAL USE ONLY

KEEP OUT OF REACH OF CHILDREN

ALWAYS READ LABEL FOR COMPLETE DIRECTIONS AND PRECAUTIONS



IBS, INCORPORATED

Aerosols & Chemicals S04

Aerosols

Rapid Gasket

HEAVY BODIED BLACK RTV GASKET MAKER

IBS No. 74135

One can of Rapid Gasket can eliminate the need to stock thousands of different gaskets for the various applications out there: Newer vehicles, older vehicles, metal to metal applications, plastic to metal applications, aluminum to steel, metal to alloy, stamped to cast, etc.

The main difference between this product and standard RTV products is that it is thicker and faster, allowing the user to make leak-proof gaskets and return equipment to service immediately. Formulated to meet or exceed performance standards for long-term seal-ability, durability and handling, this material is used on OEM production lines and specified in their service parts programs. Standard RTV recommends letting it set for 2 hours before torquing down on the assembly and then allowing to cure overnight, while **Rapid Gasket** can be torqued immediately.

ADHESIVES

- **Make leak-proof gaskets in just 1 minute** allowing equipment to be returned to service immediately – no need to wait for cut gaskets to be delivered or standard RTV to set up.
- **Special applicator and tip** makes applications easier putting less hand strain and giving a better bead.
- **No cutting or measuring** eliminates the chance of error – **Rapid Gasket** is simply applied and assembled – no measuring, no cutting, and no chance of error – saves time and money.
- **Is applied directly to the surface** which creates a perfect fit for Increased reliability.
- **Adheres to both surfaces** protecting against leaks and seepage caused by vibration and thermal expansion for increased dependability.
- **Longer lasting** and more reliable because Rapid Seal is an elastomeric formed-in-place rubber gasket maker that is custom fit to any shape or size for different applications making it faster, easier and at a fraction of the cost of cut gaskets.
- **Easily applied** and therefore perfect for flanges, pans and gaskets that are repeatedly removed and replaced making disassembly easier, faster and without replacing an expensive cut gasket everytime.
- **Versatile** – Can be used anywhere paper, cork, plastic or rubber cut gaskets are used.
- One can **eliminates the need to stock thousands of different gaskets** for various applications reducing inventory and carrying costs.
- **Exceptional resistance** to oil, ATF, coolant, gear oils and other fluids (Not recommended for use in contact with gasoline or head gaskets).
- **Temperature range** -40°F to 600°F continuous, 650°F intermittent.
- **Sensor-safe.**
- **Conforms to the Specifications of:**
 - GM 998-5675 998-5990
 - FORD WSE-M4 6323-A6
 - CHRYSLER GF-44A





Cleaning Products

A

Aerosols

Cleaners

- Batt. Clean/Protect S-CL6
- Brake & Parts Cleaner S-CL7
- Choke & Carb S-CL6
- CitruBlast S-CL10
- CitruSolve S-CL10, S-CL11, SCL-16
- CitruSolve II S-CL11
- Coil & Filter Cleaner S-CL8
- Contact & Circuit Board Cleaner II SCL-16, SCL-17
- FabriClean SCL-16
- Glass Cleaner SCL-13
- Insta-Clean SCL-15
- PowerSolve S-CL9
- Quicker Clean SCL-14
- Spit Shine Clear Coating Formula SCL-16
- SS-IV Degreaser S-CL9

Disinfectant

- Zenatize Disinfectant SCL-17

C

Cleaners

- Aluma-Brite Acid Replacement Aluminum Cleaner S-CL8
- Pro-Wash Industrial Vehicle Wash SCL-14
- Sprays
 - Organic Stain & Odor Eliminator Enzyme Cleaner SCL-12
- Wiping Products
 - Maintenance Magic Industrial Wipes S-CL2

E

- Eco-Gel Green Degreaser SCL-12
- Eco-Gel Orange Glass & Surface Cleaner SCL-13
- Eco-Scrub Industrial Hand Cleanser S-CL4, S-CL5

G

- Gold-N-Clean Concentrate S-CL11

H

Hand Soap

- Cherry-Scrub Hand Cleaner S-CL5
- Eco-Scrub Industrial Hand Cleanser S-CL4, S-CL5
- H2-NO Waterless Hand Cleaner S-CL5

I

- Insta-Brite Rubber & Vinyl Dressing SCL-15

S

Sprays

- Eco-Gel Green Degreaser SCL-12
- Eco-Gel Orange Glass & Surface Cleaner SCL-13
- Gold-N-Clean S-CL11
- Insta-Brite Rubber & Vinyl Dressing SCL-15
- Organic Stain & Odor Eliminator Enzyme Cleaner SCL-12
- Pro-Wash Industrial Vehicle & Truck Wash SCL-14

W

Wiping Products

Dispensers

- Wall Mount & Floor Stands S-CL3
- Microfiber Towels 16"x16" S-CL2
- Mighty Wipes S-CL3
- Super Tough Wipes S-CL3
- XtrAbsorbent Wipes S-CL3



IBS, INCORPORATED

Industrial Wipes S01

C
L
E
A
N
I
N
G
P
R
O
D
U
C
T
S

Maintenance Magic Industrial Wipes

DUAL TEXTURED MULTI-PURPOSE WIPES



Maintenance Magic Industrial Wipes are heavy duty, pre-moistened cleaning towels. They have specially formulated dissolving agents for grease and grime, plus the towels are uniquely designed with dual textures. One side is smooth — the other side has added "muscle beads" to provide a slightly rough texture when more cleaning help is needed.

- **Removes Tough Soils and Stains** — Grease, tar and asphalt, nail polish, paint, varnishes, scuff marks, coffee stains, most graffiti, crayon, tree pitch, permanent marker, urethane sealants, tape residue, counter and carpet stains, plastic pipe cement and more!
- **Safe & Effective on Hands** — Designed to absorb soil and not transfer back on hands. Conditions hands with aloe, vitamin E and emollients. Removes odors from hands such as diesel, fish and onion smells.
- **Multipurpose** — Effectively cleans tools, equipment, sports shoes, vinyl, stainless steel, recreational items, hands and more! Eliminates the need for other cleansers.
- **Heavy Duty Design** — Will not shred!
- **No Sticky Residue** — Leaves hands and surfaces clean and non-sticky.
- **Pre-Moistened** — Eliminates the need for water - easy to use anywhere!
- **Fast, Versatile & Easy to Use** — Cleans most surfaces quickly and easily.
- **Non-Flammable.**

HMIS Ratings	
Health	1
Flammability	1
Reactivity	0
Personal Protection	-

IBS No.	Description	Qty
74218	Maintenance Magic Industrial Wipes Net Contents: 80 Wipes, 9" x 12"	6

Microfiber Towels 16"x16"

Thicker, Stronger & More Absorbent



Microfiber Towels are perfect for all industries, including industrial, janitorial, sanitation, automotive, hospitals, nursing homes, equipment maintenance and more.

- **Outlasts and outperforms** cotton towels.
- **Machine washable and reusable**, reduces waste and saves money.
- **Durable and long lasting**, for additional money and labor savings.
- **More absorbent** than cotton or paper towels means faster clean up.
- **Great for applications** where paper towels are not absorbent or durable enough.
- **Saves time, money and the environment.**

IBS No.	Description	Qty
74225	Microfiber Towels (Yellow)	12



Super Tough Wipes

Pop-Up Box & Perforated Roll



- **Fast-absorbing material** is engineered to feel like cloth yet work harder for a disposable wiper making it a cleaner and easier to use alternative to cloth.
- **Reusable because the wipes are strong enough they can be rinsed and reused on many cleaning tasks** making them a cost efficient replacement for laundry service towels or t-shirt rags.
- **Virtually lint free** leaving a cleaner surface that won't attract more dust or dirt.
- **Binder free and made with chemical resistant materials** and therefore won't breakdown when used with chemicals means a tough wiper on tough jobs requiring solvents and harsher cleaners.

IBS No.	Wipes Size	Wipes Per Pkg	Package Type	Pkg Qty	Case Qty
97401	9" x 16-3/4"	100	Pop-Up Box	1	10
97551	12.5" x 13"	475	Perforated Roll	1	1

XtrAbsorbent Wipes

Pop-Up Box



- **Absorbs grease, oil and water** for a perfect all-purpose wipe reducing inventory carrying costs.
- **Cloth-like feel is comfortable to use on hands and skin** making this wipe versatile for tough shop jobs as well as personal use.
- **Soft enough that it can be used for polishing applications** yet still durable enough for tougher jobs which saves time and money when having to switch wipers.
- **With characteristics of softness, wipe-dry and absorbency, it is used in a multitude of applications:** general wiping, patient washcloths, grease and oil, staining, etc. make these wipes super versatile.

IBS No.	Wipes Size	Wipes Per Pkg	Package Type	Pkg Qty	Case Qty
97501	9" x 16-1/2"	100	Pop-Up Box	1	9

Wiper Dispensers

Wall Mount & Floor Stands Fits Super Tough Wipes Roll



- Holds 1 Jumbo Roll
- Blue, Metal Construction
- Available in floor stand or wall mount

IBS No.	Description	Qty
91721	Floor Stand Dispenser	1
91722	Wall Mount Dispenser	1



IBS, INCORPORATED

Aerosols & Chemicals S04

Eco-Scrub

Industrial Hand Cleanser

Eco-Scrub is an all natural industrial hand cleanser made with all natural walnut shell scrubbers! Ideal for every shop — mild enough for constant use and strong enough to take on the toughest dirt and grime. The dispenser is made of rigid, commercial plastic for exceptional life and strength, and is easily refillable with our IBS brand Eco-Scrub Hand Cleanser.

- **Antibacterial "PCMX"** — Kills germs that can lead to infection.
- **Biodegradable** — Won't harm the environment.
- **Concentrated formula** — Reduces hand soap use by up to 75%.
- **Made with natural walnut shell scrubbers** cleans tough dirt without abrasive pumice.
- **Fortified with Skin Conditioners and Emollients** — to revitalize skin.
- **Non-Solvent Formula** — Prevents drying and cracking.
- **Washes away completely** — Leaves NO greasy residue.
- **Contains no Dyes or Perfumes** — Friendlier to sensitive skin.

DIRECTIONS FOR USE:

Pull out blue breather plug on top of container before dispensing, and tear pull tab off of the container valve.

A) Apply **ECO-SCRUB** to hands, spread over knuckles, palms and fingers, then add a small amount of water and lather. Rinse thoroughly with water.

OR

B) Wet hands, then apply **ECO-SCRUB** spreading over knuckles, palms and fingers, then lather. Rinse thoroughly with water.

CAUTION:

- Keep out of reach of children. May be harmful if swallowed.
- Contains mild abrasives. If splashed into eyes, wash immediately with water for at least 15 minutes. If irritation persists, call a physician. If swallowed, do not induce vomiting.
- Contact physician immediately.

CONTAINS WALNUT SHELLS



IBS No. 75007
13.5 oz

IBS No. 75006
120 oz



IBS No. 75006D
Dispenser

IBS No.	Description	Qty
75006	Eco-Scrub 120 oz. Hand Cleanser	2
75006D	Eco-Scrub Dispenser	1
75007	Eco-Scrub 13.5 oz. Hand Cleanser	12

Peanut Allergen Information

The law defines 8 food allergens: milk, eggs, peanuts, tree nuts, fish, shell fish, soy and wheat. The natural scrubbers in Eco-Scrub Hand Cleaner are **ground up walnut shells**. Walnuts are categorized as tree nuts and peanuts are categorized as legumes and those are completely different from each other.

Because of these differences the walnuts do not fall into the peanut allergen category and therefore we can safely state that Eco-Scrub Hand Cleaner contains no peanut allergens.

C
L
E
A
N
I
N
G
P
R
O
D
U
C
T
S



Cherry-Scrub Hand Cleaner Heavy Duty Pumice Based Solvent Hand Cleanser NOT FOR SALE IN CALIFORNIA



Cherry-Scrub Hand Cleaner is a concentrated, low-solvent formula that cleans the dirtiest hands.

- **Contains solvents and pumice** — to remove the toughest soils, oils, varnish, paints and much more.
- **Enhanced with superior emollients** — to protect skin from over-drying and cracking.
- **Super thick concentrate** — stays on hands during washing to reduce waste.
- **Bright red color** with a clean cherry scent.

DIRECTIONS FOR USE:

Pull out blue breather plug on top of container before dispensing, and tear pull tab off of the container valve.

A) Apply **CHERRY-SCRUB** to hands, spread over knuckles, palms and fingers, then add a small amount of water and lather. Rinse thoroughly with water.

OR

B) Wet hands, then apply **CHERRY-SCRUB** spreading over knuckles, palms and fingers, then lather. Rinse thoroughly with water.

CAUTION:

- Keep out of reach of children. May be harmful if swallowed.
- Contains mild abrasives. If splashed into eyes, wash immediately with water for at least 15 minutes. If irritation persists, call a physician. If swallowed, do not induce vomiting.
- Contact physician immediately.

CONTAINS SOLVENTS & PUMICE

IBS No.	Description	Qty
75009	Cherry-Scrub 120 oz. Hand Cleanser	1
75006D	Cherry Scrub Dispenser	1

H2-NO Waterless Hand Cleaner Citrus Creme Scent



H2-NO is a free rinsing, non-abrasive hand cleaner designed to be used with or without water. Designed to be used at the sink or in the field when no water is available to remove the most stubborn soil without abrasives.

- **Industrial strength cleaner can be used with or without water** to cut grease, oil and grime – perfect for maintenance shops or even in-the-field use when water isn't available – keeps workers in the field saving time and money.
- **Free-rinsing formula wipes or rinses away** cleanly leaving hands feeling cleaned and conditioned without feeling oily – makes returning to work easier without the need for excessive wiping or cleaning to remove oily residues.
- **Thick viscosity clings to hands** to penetrate and emulsify soils – requiring less product per use to save money.
- **Fortified with emollients** that revitalize skin to reduce drying and cracking – ideal for repeated use without harming the skin.
- **Biodegradable** – won't harm the environment
- **Pleasant Citrus Creme Fragrance.**

IBS No.	Description	Qty
75008	H2-NO Waterless Hand Cleaner 13.5 oz	12

C
L
E
A
N
I
N
G
P
R
O
D
U
C
T
S



IBS, INCORPORATED

Aerosols & Chemicals S04

C
L
E
A
N
I
N
G
P
R
O
D
U
C
T
S

Battery Terminal Cleaner



Battery Terminal Cleaner removes corrosion from all battery parts and quickly identifies leaks. Color indicator turns red in the presence of acid. When neutralizing, color indicator shows yellow. Regular use increases battery performance and life expectancy.

- **Improves conductivity** — Seals out air to prevent corrosion that robs battery power and life.
- **Attacks and destroys corrosion** — Quick acting cleaner removes stubborn corrosion.
- **Extends battery life** — Seals air and dirt out to protect battery against corrosion build-up and battery voltage leakage.
- **No mess application**
- **Fast-acting formula** makes clean up quick.

Choke & Carb Cleaner



Choke & Carb Cleaner uses a high power blasting action plus a special blend of high strength solvents which quickly removes harmful deposits from internal chamber areas. This then restores the power, economy and performance to the engine.

- **Removes carbon**, dirt, gum and varnish deposits.
- **Safe on oxygen sensor and catalytic converters** - will not foul or coat oxygen sensor or catalytic converter.
- **Cleans, frees, renews** automatic chokes, carburetors, carburetor linkages, PCV Valves, manifold heat controls.
- **Eliminates** rough idling and removes carbon build up for better mileage and performance.
- **Eliminates corrosion** and frees parts from sticky operations.
- **Fast-acting, high pressure spray** delivers extra cleaning pressure to aid removal of all combustion build-up.
- **Saves time, money, labor and mess**

NOTE: Not available for sale in CALIFORNIA, COLORADO, UTAH, LADCO and OTC states.



IBS No.	Description	Qty
74103	Battery Terminal Cleaner 18 oz	12

IBS No.	Description	Qty
RL74115	Choke & Carb Cleaner 14 oz	12



Brake & Parts Cleaner II Non-Chlorinated



- **Non-Chlorinated solvent** for easy waste disposal.
- **Cleans and degreases brakes** and brake parts quickly and easily without disassembling. Just spray on and wipe off.
- **Perfect for cleaning** other dirty, greasy parts.
- **Removes many contaminants** including dirt, grease and brake fluid.
- **For use on brake linings**, disc brake pads, brake drums, springs, cylinders and other brake parts.
- **Safe to use** — Contains no carbon tetrachloride, silicone or petroleum solvents.
- **Leaves no film residue.**
- **Saves time, money, labor, and mess.**

NOTE: Not available for sale in California and New Jersey.

NOTE to customers in California, Colorado, Utah, Lake Michigan Air Directors Consortium (LADCO) state: This product is sold to and is to be used exclusively by establishments which manufacture or construct goods or commodities.



IBS No.	Description	Qty
74111	Brake & Parts Cleaner II 13 oz	12

Brake & Parts Cleaner II Non-Chlorinated 5 GALLON CONTAINER



121043

121080

Use with the Spot Spray sprayer (**pictured**), to repair and replace worn parts

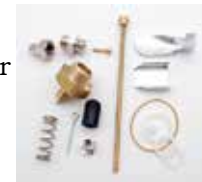

155070



123776

PLEASE NOTE

Due to product volume, this item is classified as a **HAZARDOUS MATERIAL** and must be shipped with additional precautions as required by law.

Additional shipping charges will apply. Please contact IBS, Inc. for shipping quotes or further information, if necessary. (800) 678-1906.



IBS No.	Description	Qty
120298	Brake & Parts Cleaner II 5 Gallon Container	1
121043	32 oz. Spot Spray Sprayer	1
121080	32 oz. Spot Spray Pitcher	1
155070	Spot Spray Repair Kit	1
123776	Spot Spray Filler Cap Assembly	1

C
L
E
A
N
I
N
G
P
R
O
D
U
C
T
S



IBS, INCORPORATED

Aerosols & Chemicals S04

C
L
E
A
N
I
N
G
P
R
O
D
U
C
T
S

Coil & Filter Cleaner Non-Acid /Foaming



Coil & Filter Cleaner is an easy to use, non-acid cleaner that foams heavily after penetrating deeply into coils to force out contaminants and oxides. Unlike acid cleaners, which are used to remove tarnish, and alkaline discoloration but are ineffective at removing grease and heavy grime, Coil & Filter Cleaner is a safe and effective formula that works fast, disperses grease and grime and leaves coils clean, while improving heat exchange efficiency.

- **Penetrates deeply first** and then begins foaming to force out dirt, contaminants and oxides to improve condenser performance.
- **Dissolves and disbursts grease** that acid cleaners won't.
- **Meets USDA standards** for use in federally inspected meat and poultry establishments.
- **Excellent for** air conditioners, central cooling systems, refrigeration systems and auto air conditioners.

FOR USE IN

Hotels/Motels • Homes • Office Buildings
Air Conditioner Services
Auto & Fleet Repair Services

IBS No.	Description	Qty
74165	Coil & Filter Cleaner 18 oz	12

Aluma-Brite Multi-Purpose Acid Replacement Aluminum Cleaner Acid Replacement with Acid Performance



Aluma-Brite is a heavy-duty acid replacement product with all the performance of hydrofluoric and sulfuric acids but is non-corrosive to skin, making it a far safer alternative. As an aluminum brightener and cleaner it has outstanding calcium, lime scale and silicate deposit removal properties, and quickly removes corrosion and oxidation, leaving surfaces bright and clean. Use it regularly to clean coils for more efficient operation and lower power consumption. **Not for use on anodized aluminum.**

- **Replaces** hydrofluoric and sulfuric acids.
- **Non-Corrosive** to skin.
- **Cleans and brightens** corroded and oxidized aluminum.
- **Removes dust, grease and oxidation** from coils.
- **DOT Non-Regulated** for easier and lower cost shipping.
- Because it is non-corrosive, **No EPCRA risk management plan** filing required, saving time and money.
- **No Phosphorus.**

EFFECTIVE AGAINST

Calcium • Lime Scale • Silicate Deposit
Corrosion • Grease • Oxidation
Dust • Dirt • Grime

FOR USE ON

Trailer Bodies • Boats • Building Materials
Exterior Surfaces • Aluminum & Copper Coils
Cooling Units • Air Conditioner Fins
& Exterior Surfaces

IBS No.	Description	Qty
74302	Aluma-Brite Acid Replacement Aluminum & Coil Cleaner 1 Gallon	4



PowerSolve Cleaner/Degreaser



PowerSolve is a nonflammable, fast-evaporating strong solvent cleaner that penetrates instantly to remove dirt, oil, grease and wax from metallic and non-metallic surfaces. Also for use on engines, bearings, gears, electric motors (even while running), ignition systems, generators, brake parts, pumps, relays, etc. Increases the life of electrical components by removing foreign materials that can cause costly downtime. High dielectric strength of 26,000 volts per mil. Degreases more thoroughly and several times faster than alkaline cleaners. Equipped with a high-delivery valve for cleaning efficiency and extension tube for hard-to-reach areas.

- **Strong solvent formulation** quickly removes grease, dirt and oil.
- **High dielectric strength** prevents shorting of electrical and electronic equipment.
- **No flash or fire point** — eliminates fire and explosion hazards.
- **Fast evaporation** speeds clean-up and downtime.
- **Noncorrosive**, non-conductive and non-staining for safer application.

NOTE: Not available for sale in California and New Jersey.

IBS No.	Description	Qty
74126	PowerSolve 18 oz	12

Safety Solvent-IV Degreaser



Safety Solvent IV is a residue-free, fast-drying, high power spray that dissolves grease and rinses away dirt and grime without injury to working parts.

- **Contains no CFC's**, ozone-depleting chemicals, or petroleum distillates.
- **Features a 36,200 volt dielectric strength.**
- **High dielectric strength combined with non-flammability** make this the only degreaser safe for use on motors, generators, relays and control panels even while equipment is in operation.

FOR USE ON:

**Diesel Engines • Marine Equipment
Aircraft Parts • Industrial Equipment
Heating & Air Conditioning Equipment
Refrigeration Equipment • Generators
Motors • Windings • Power Tools
Food Processing Equipment**



IBS No.	Description	Qty
74156	Safety Solvent IV Degreaser 20 oz	12

C
L
E
A
N
I
N
G
P
R
O
D
U
C
T
S



IBS, INCORPORATED

Aerosols & Chemicals S04

C
L
E
A
N
I
N
G
P
R
O
D
U
C
T
S

CitruBlast

Heavy Duty Foaming Degreaser

**VOC
COMPLIANT
FORMULA
IN ALL
50 STATES!**



CitruBlast is an aggressive, heavy-duty foaming degreaser with a powerful foaming jet stream spray. This is an extremely effective emulsified degreaser that contains no harmful caustics or solvents.

- **Powerful foaming spray** removes and penetrates surface dirt, then clings to the surface for increased dwell time to break down even the toughest soils for a more thorough and effective clean.
- **Contains Citrus Terpenes** — a strong, biodegradable solvent that quickly removes grease, dirt and oil effectively and safer than toxic, hazardous and dangerous petroleum chemicals.
- **No caustics or solvents** mean no flash or fire point — eliminating fire and explosion hazards for a safe cleaner.
- **Water soluble** grease dissolving detergents can be easily rinsed and washed away, taking the dirt with it — leaving a clean and residue free surface.
- **Excellent for removing** accumulations of grease, tar and asphalt on engines and engine parts. Effectively removes most greases, oil, adhesives, waxes, gums, inks, tars and resin.
- **VOC Compliant in all 50 States.**

FOR USE ON:

Machinery • Tools • Industrial Equipment • Walls
Coils • Concrete • Protective Coatings



IBS No.	Description	Qty
74142	CitruBlast 16 oz	12

CitruSolve

Industrial Degreaser



CitruSolve is an industrial solvent made from natural steam distilled citrus oils and fortified with d'limonene, a powerful solvent that penetrates and suspends soils in the solution for fast and easy removal of hydrocarbons and industrial coatings, like cosmoline and undercoating.

CitruSolve's unique formula is specially blended to replace toxic petroleum-based solvents commonly found in degreasing products.

- **Made from natural distilled citrus oils and contains no chlorinated solvents or fluorocarbons that can deplete the ozone,** making it a safe and environmentally friendly cleaner and degreaser.
- **High pressure spray** removes surface grease and dirt, then penetrates harder to remove soils for a thorough cleaning requiring less effort, saving time and labor.
- **Fortified with 38% D-Limonene** for a more concentrated formula than other citrus cleaners for a better and more cost effective cleaning per can.
- **Biodegradable formula** is non-toxic and safe to use. Can be used in small confined areas and rinsed with water. No need for expensive PPE or ventilation which means faster cleanup and minimal preparation.
- **Non-foaming formula** means product does not limit visibility and allows for immediate clean up.

NOTE: Not available for sale in California, Colorado, Delaware, Maryland, Michigan, New Hampshire, New York, Ohio, Rhode Island and Utah. Other locales may also prohibit sale or use. Check local and state regulations.

VOC Content: 50%



IBS No.	Description	Qty
74115	CitruSolve 15 oz	12



CitruSolve II Citrus Organic Solvent Cleaner Degreaser

**VOC
COMPLIANT
FORMULA
IN ALL
50 STATES!**



CitruSolve II is a uniquely formulated organic safety solvent, cleaner and degreaser that is non-corrosive, non-conducting and removes grease, oils, dirt, wax and moisture — to extend both electrical performance and equipment life.

- **Powerful non-chlorinated solvent blend** features a technologically advanced formula that safely and efficiently cleans and improves performance by removing grease, oil, dirt and other contaminants from electrical motors, parts, and machinery.
- **High pressure delivery system** allows for thorough cleaning of all metal surface parts.
- **Dissolves grease, oils, tar, asphalt resins, brake fluid** and many other tough soils.
- **Does not contain chlorinated solvents** that can contaminate waste oil. Does not contain 1,1,1, Trichloroethane or Perchloroethylene.
- **For use in** machine shops, industrial plants, automotive shops, marine repair, schools and maintenance shops.
- **VOC Compliant in all 50 states.**

IBS No.	Description	Qty
74118	CitruSolve II 14 oz	12

Gold-N-Clean Concentrated Cleaner

**Quart Bottles
& Trigger
Sprayers
Sold
Separately**



Gold-N-Clean is a highly concentrated extremely powerful grease fighter that will quickly clean the toughest grime. Gold-N-Clean is safe on all surfaces and is entirely biodegradable. If you need it cleaned, this is the product of choice. USDA Approved.

- **A Super Concentrate** - Mix with water for the strength you need:
 - 50/1** — for light cleaning such as daily floor washing.
 - 25/1** — for all purpose cleaning on any surface.
 - 10/1** — for heavily soiled areas tires, grills, motors, fans, AC coils, concrete, and tile.
 - 2/1** — for extremely heavily soiled areas such as cleaning brick ovens, engines, industrial trucks, buses, crude oil deposits, soap scum, dumpsters, asphalt parking lots and restaurant equipment.
- **Biodegradable, USDA approved.**
- **Simplified dilution ratios:** Light, Medium, Medium-Heavy or Heavy duty strengths.
- **No Flashpoint** - Non-combustible.
- **Water based** - Replaces cleaners containing solvents, caustics or acids.
- **Environmentally friendly** - Very concentrated for minimum packaging.
- **Contains no chlorinated solvents**, phosphates, CFC's alcohol, ammonia, acids or abrasives.
- **Pleasant fragrance** - Cleans and deodorizes.
- **Versatile** - Apply with sprayer, brush, rag, immersion soak, power scrubber, pressure washer or in any ultrasonic cleaner. Hundreds of uses throughout any facility or home.

**NOTE: NOT AVAILABLE FOR SALE
IN THE STATE OF CALIFORNIA**

IBS No.	Description	Qty
74301	Gold-N-Clean 1 Gallon	4
74307	Empty Spray Bottle	1
74306	Trigger Sprayer	1
LS74301	Gold-N-Clean Label	1

C
L
E
A
N
I
N
G
P
R
O
D
U
C
T
S



IBS, INCORPORATED

Aerosols & Chemicals S04

C
L
E
A
N
I
N
G
P
R
O
D
U
C
T
S

Organic Stain & Odor Eliminator Enzyme Cleaner



Trigger
Sprayers
Sold
Separately

This advanced industrial multi surface enzymatic cleaner quickly removes all types of organic stains and provides long lasting odor control.

- **Formulated with powerful all natural active microorganisms** for a thorough, natural, and long lasting cleaner and odor eliminator that penetrates deep into any fabric or substrate breaking down the organic materials that cause stains and unpleasant odors to quickly neutralize stains and odors, preventing them from returning.
- **Active enzymes continue to work long after cleaning**, which eliminates the need for additional odor control products for less inventory.
- **Safe and versatile multi-surface organic cleaning solution** will not harm users, surfaces or the environment.
- **Effective on organic stains** such as grease, oils, food, coffee, urine, vomit, feces, blood and more.
- **Ideal for** transportation, automotive, agriculture, schools, public transit and facilities, hospitality, government, industrial, medical, food & beverage, and commercial and retail properties.
- Can be used on all surfaces.
- Two trigger sprayers included with every purchase of 12 bottles.¹

IBS No.	Description	Qty
74313	Organic Stain & Odor Eliminator Enzyme Cleaner	6
74306	Trigger Sprayer	1

Eco-Gel Green Degreaser Thixotropic Spray



Trigger
Sprayer
Sold
Separately

- **Maximum Strength** — degreases/cleans the toughest soils.
- **Thick, heavy duty spray** — won't drip.
- **Ultimate formula** — destroys grease and grime on contact.
- **Incredible wheel cleaner** — melts away brake dust.
- **Thixotropic Spray** — sticks to surfaces for more effective cleaning.

THIX'-O-TROPIC: The phenomenon exhibited by certain gels of becoming thick when shaken and returning to a fluid state upon standing.

- **Contains LS2;** a combination of surfactants and water softener designed to leave the surface clean and residue free.
- **Contains a new generation fragrance package** designed to encapsulate malodors.
- **Thixotropic clinging action** reduces product from volatilizing on the surface as quickly as most products. Clinging action also provides dwell time for the product to react to the surface.

NOTE: NOT AVAILABLE FOR SALE IN THE STATE OF CALIFORNIA

IBS No.	Description	Qty
74316	Eco-Gel Green Degreaser 32 oz	12
74306	Trigger Sprayer	1



Eco-Gel Orange Glass & Surface Cleaner Thixotropic Spray SAFE FOR USE ON PLEXIGLASS!



Trigger
Sprayer
Sold
Separately

- **Superior Strength Cleaner** — destroys tough soils.
- **Multi-Surface** — superb on glass, mirror, chrome, stainless, paint, etc.
- **Ultimate formula** — impossible to streak or spot. Prevents fingerprints and smudging.
- **Eliminates odors** — leaves pleasant citrus scent.
- **Thixotropic Spray** — sticks to surfaces for more effective cleaning.

THIX'-O-TROP'IC: The phenomenon exhibited by certain gels of becoming thick when shaken and returning to a fluid state upon standing.

- **Contains LS2;** a combination of surfactants and water softener designed to leave the surface clean and residue free.
- **Contains a new generation fragrance package** designed to encapsulate malodors.
- **Thixotropic clinging action** reduces product from volatilizing on the surface as quickly as most products. Clinging action also provides dwell time for the product to react to the surface.

**NOTE: NOT AVAILABLE FOR SALE
IN THE STATE OF CALIFORNIA**

IBS No.	Description	Qty
74315	Eco-Gel Orange Glass & Surf 32 oz	12
74306	Trigger Sprayer	1

Glass Cleaner Non-Ammoniated



Glass Cleaner is an effective industrial strength, non-ammoniated, foaming glass cleaner. Unique blend of detergents with heavy-bodied foam to cling to vertical surfaces and to dry streak free.

- **Contains no oils, waxes or silicones** to cause dirt attracting film.
- **Easily removes** smudges, film, scum, bugs and soil.
- **Will not harm plastic** — safe for use on Plexiglass.
- **Chlorine free & ammonia free** absence of these chemicals produces a safer, more user-friendly product.
- **Special blend of detergents** leave surface clean and residue free.
- **Deionized water and pure SD40 Alcohol** — produces streak and haze free surfaces.
- **No perfume or reclaimed solvents** eliminates rainbow effects.
- **Safe on tinted windows.**

FOR USE ON:

Glass • Metal • Plastic • Tile • Ceramic
Porcelain • Rubber • Leather • Plexiglas®
Non-Porous Surfaces • Windows • Mirrors
Table Tops • Sneeze Guards • CRTs • Tile
Vinyl • Chrome • Stainless Steel
Windshields



IBS No.	Description	Qty
74120	Glass Cleaner 19 oz	12

C
L
E
A
N
I
N
G

P
R
O
D
U
C
T
S



IBS, INCORPORATED

Aerosols & Chemicals S04

C
L
E
A
N
I
N
G
P
R
O
D
U
C
T
S

Quicker Clean General Purpose Cleaner



Quicker Clean is a foaming multi-surface cleaner formulated to quickly and easily remove lipstick, dirt, grease, pencil marks, handprints and other grime from most surfaces.

- **Safe for all surfaces** - Use with confidence wherever water can be used.
- **Quick acting and easy-to-use** - Spray on, wipe off.
- **Cleans fast** - Leaves no residue.
- **Powerful activated foaming agents** cling to and penetrate dirt, grease and stains on vertical surfaces.
- **Will not irritate skin**
- **Light mint scent**

FOR USE ON:

Tile • Grout • Porcelain • Vinyl • Formica
Leather • Enameled Surfaces • Walls • Metal



IBS No.	Description	Qty
74105	Quicker Clean 18 oz	12

Pro-Wash Industrial Vehicle & Truck Wash



Pro-Wash is a highly concentrated high foaming vehicle wash that is economical to use and ideal for all types of finishes. Properly diluted, it removes dirt and road film quickly and safely. Effective on all vehicles!

- **Formulated with a water softener** that resists water spotting for a better finish that requires less drying time, saving money.
- **Contains special optical brighteners** to leave a bright shiny surface, reducing the need for additional buffing and waxing, saving time and money.
- **Contains no harsh detergents** so it will not streak or harm the car's wax finish, making it more versatile and safer to use.
- **Great for automatic and self-service car washes**, as well as hand use.
- **Concentrated** - effective with 1 to 2 ounces per gallon of water makes this product extremely economical, saving money.
- Has a great **cherry scent**.

IBS No.	Description	Qty
74320	Pro-Wash Industrial Vehicle Wash 1 Gallon bottle	4
74325	Pro-Wash Industrial Vehicle Wash 5 Gallon pail	1



Insta-Brite Rubber & Vinyl Dressing



Insta-Brite is a water-based interior and exterior rubber/vinyl dressing. This concentrated and highly effective dressing restores and leaves a satin gloss that lasts a long time. Insta-Brite is easy to apply and leaves no oily residue to collect dust and dull the finish. Protects from oxygen, ozone and UV rays that crack and dull rubber and vinyl. Insta-Brite is also safe on motor compartments.

- **Freshens and brightens rubber, vinyl and plastic** – ideal for restoring dull surfaces to look new again.
- **Leaves a dressing on the surface that protects** from oxygen, ozone and UV rays that can crack and dull rubber and vinyl.
- **Water-based formula leaves no oily residue** that can collect dust and dull the finish or dirty the surface – creating a longer lasting luster finish.
- **Easy to apply** – quart bottle with trigger sprayer makes applications a cinch on large or small surfaces – can be sprayed on directly or with a towel or sponge.
- **Non-flammable and water-based** makes the formula safe on motor components.
- **Contains no hazardous ingredients** making this product safer to the user and the environment.
- **Excellent for use on:** Trucks, Buses, Cars, Motorcycles, Boats, Upholstery, Bags, Shoes, Luggage, Sporting Goods, Furniture and Much More.
- 2 Sprayers included with every purchase of 12 bottles.

IBS No.	Description	Qty
74314	Insta-Brite 32 oz. bottle	12
74306	Trigger Sprayer	1

Insta-Clean Rubber & Vinyl Cleaner/ Protectant



Insta-Clean cleans and shines all rubber, vinyl and other synthetic surfaces without washing or wiping. Unique self-cleaning foaming action quickly removes caked on dirt while leaving a long lasting, high gloss shine.

- **Powerful foaming action.**
- **No washing or wiping necessary** — The amazing foaming action cleans and shines without washing or wiping.
- **Leaves a high gloss protective shine.** Repels dirt, salt and road grime. Protects from discoloration and oxidation.
- **Will not harm aluminum or painted surfaces.**
- **Ideal for use on rubber and vinyl** components of machinery/equipment; vinyl and plastic furniture; and auto/truck tires. . . it makes them look showroom new!
- **Easy to use** - Can be used on wet or dry surfaces.

Directions For Use: Shake can well before using. Spray foam 8 inches away from surface in one sweeping motion. Let cleaner dissolve (30 seconds) and shine to cure (approx. 5 minutes). For more gloss use two applications. For less gloss, wipe once with clean cloth. Extremely dirty surfaces may require a prewash.

NOTE: NOT AVAILABLE FOR SALE IN THE STATE OF CALIFORNIA



IBS No.	Description	Qty
74121	Insta-Clean 13 oz	12

C
L
E
A
N
I
N
G
P
R
O
D
U
C
T
S



IBS, INCORPORATED

Aerosols & Chemicals S04

C
L
E
A
N
I
N
G
P
R
O
D
U
C
T
S

FabriClean Carpet & Upholstery Cleaner & Odor Eliminator



FabriClean permanently removes stains and odors using active enzymes. The active enzymes get to the root of the problem digesting the stain and destroying the odor-causing bacteria. The advanced, deep-foaming formula penetrates and lifts stubborn stains on a variety of materials such as carpeting, upholstery and automotive interiors.

- **Active Enzymes** Eliminate Organic Matter & Foul Odors destroying the stain and odor causing bacteria in one-step to save time and money.
- **Advanced Cleaning With Foaming Action** penetrates the carpet or fabric for a deeper, effective clean using less product and less muscle saving money and time.
- **Cleans and deodorizes** in one step leaving behind a pleasant fresh fragrance saving time and money.
- **Ideal For Most Carpeting,** Upholstery And Automotive Interiors.
- **Inverted Valve** For Easy, Comfortable Application can be applied in any direction for easier application when applying downwards on carpeting or sideways on upholstery.

IBS No.	Description	Qty
74158	FabriClean 20 oz.	12

Spit Shine Clear Coating Formula



Spit Shine clear coating instantly improves the appearance of motorcycle parts and other vehicle trim and components. Spit Shine restores dull surfaces to new looking. Brightens color and gives a clean finish. Makes old items look like new. Spit Shine is easy to apply without rubbing — just spray on. Long lasting and safe to use on just about every surface.

- **Extends** the life of polished metal by forming a clear acrylic coating.
- **Brightens and renews** any vinyl or plastic surface.
- **Works instantly** with no wiping necessary.
- **Great for wrinkle paint** and polished surfaces - Makes it look like new.
- **Wicks** into hard to reach places.
- **No wiping** required.
- Great for **cars, trucks, boats and more.**
- **Produces a "SHOW" finish.**

Directions For Use: IMPORTANT — **Spit Shine** is slippery and should NOT be used on motorcycle tires, grips and brake or clutch pedals. Hold can 8 to 10 inches from surface to be sprayed. Apply thin mist coating to clean, dry surface for best results. For very smooth or painted surfaces, a light buffing may produce a more desirable shine. To reduce overspray, **Spit Shine** may be sprayed onto a rag and wiped on to trim and components. Although Spit-Shine will not harm most materials, always test first in a small, out of sight area before using.



IBS No.	Description	Qty
74154	Spit Shine 12 oz	12



Contact & Circuit Board Cleaner

Dries Residue Free
Safe on Most Plastics



Contact & Circuit Board Cleaner is ideal for removing dirt and grease from delicate or sensitive electronic equipment. It will not harm most plastics, paint or wire insulation like other chlorinated solvents.

- **Provides 3-way action** by cleaning, restoring and protecting. It will clean oil, grease, condensation and moisture from circuit boards, precision instruments, oxygen equipment, controls, switches, motors and film.
- **Avoid** use on PVC, ABS, acrylic styrenes and polycarbonates.
- **Flammable**
- **Pre-Test** on all plastic surfaces

IBS No.	Description	Qty
74128	Contact & Circuit Board Cleaner 11 oz	12

Zenatize Disinfectant

Antibacterial, Disinfecting
Spray & Deodorant



Disinfectant sprays are your much needed ally to protect all work environments.

IBS has you covered with our **ZENATIZE DISINFECTANT & DEODORANT SPRAY**.

This disinfectant spray **sanitizes, disinfects and deodorizes**. Use this disinfecting spray on high touch hard surface areas such as door handles, knobs, phones, switches, steering wheels, etc. Also effective for deodorizing garbage cans, restrooms, buses and other vehicles. Helps to control and prevent mold and mildew.

- **Kills 99.9% of germs, bacteria and viruses**, including cold, flu and coronavirus.
- **Kills HIV** on pre-cleaned environmental surfaces.
- **Kills MRSA, H1N1, Staph, Strep, Athlete's Foot Fungus, Influenza A & B viruses** and more.
- **Controls and prevents** mold & mildew.
- **Kills the organisms** that cause odors.
- **An effective Tuberculocidal, Fungicidal, Pseudomonacidal & Germicidal.**
- This product was tested according to the AOAC Germicidal Spray Product Test for Disinfectants.

For use in hospital rooms, nursing homes, schools, hotels, offices, vehicles and any surfaces as a disinfectant and deodorant.

IBS No.	Description	Qty
74195	Zenatize Anti-Bacterial Spray, Disinfectant & Deodorant	12

C
L
E
A
N
I
N
G
P
R
O
D
U
C
T
S



IBS, INCORPORATED

Aerosols & Chemicals S04

**C
L
E
A
N
I
N
G

P
R
O
D
U
C
T
S**



Coatings

A

Aerosols

Lubricants, Protectants

Battery Terminal Protector SCO-8

Cold Zinc Galv. SCO-10

Undercoat SCO-8

Paint / Primer

Ceiling Paint SCO-9

Clear Shield SCO-9

Gray Filler Primer Paint SCO-11

Gray Self-Etching Weld Thru Primer SCO-11

Green Zinc Phosphate Primer SCO-10

IBS Paint Products Chart SCO-15, SCO-16

Pro-Coat Paint SCO-13

Pro-Tect

Truck Bed Coating SCO-7

Rustore SCO-7

Slip Resistant Coating SCO-12

Assortments

DURA-INK Small Kit SCO-4, SCO-5

Spray Tool Samplers SCO-14

Cleaners SCO-14

Coatings SCO-14

Facilities Maintenance Kit SCO-14

Penetrants & Lubricants SCO-14

PRO-COAT Hi-Solids Paint SCO-14

Vehicle & Equipment Kit SCO-14

M

Markers

B Paintstik SCO-6

Felt-Tip, Industrial

DURA-INK #5

Extended Micro-Tip SCO-2

DURA-INK #15

Fine Bullet Tip SCO-2

DURA-INK Dual Tip Permanent Markers SCO-3

DURA-INK Retractable SCO-3

Valve Action Paint SCO-3



IBS, INCORPORATED

Marking & Wiping Products S01

DURA-INK® Industrial Ink Markers

DURA-INK® markers are the must have, multi-purpose felt-tip marker that all job sites, workshops and shipping departments demand. Use for identification of equipment, sign making, marking tools or shipping containers. These markers were designed to meet the most difficult marking applications.

- **Extra tough tips that won't spread or mush** provides superior durability and longer life.
- **Smear-resistant, water-resistant and fast drying** make these markers easier and cleaner to use.
- **Marks on metal, wood, cardboard, paper, plastic, cloth, glass** and much more, making them a must have for every shop.

DURA-INK #5



- Extended nose is ideal for marking through holes & hard to reach areas.
- Micro tip for precision marking on small surfaces.
- Industrial strength ink is smear and water-resistant for longer lasting marks.
- Durable plastic barrel and metal tip reduce breakage on the job site or in-plant.

Extended Micro Tip

IBS No.	Color	Pkg Qty
Mark Size: 1/32"		
96520	■ BLACK	12

DURA-INK #15



- Ideal for fine line marking.
- Extra tough tip won't spread or mush.
- Smear-resistant, water resistant, fast-drying.
- Marks on metal, wood, cardboard, paper, plastic, glass, etc.
- For identification of parts, layout work, and marking cartons and crates.
- Durable plastic barrel & cap with metal pocket clip.

Fine Bullet Tip

IBS No.	Color	Pkg Qty
Mark Size: 1/16"		
96022	■ RED	12
96023	■ BLACK	12
96025	■ BLUE	12
96026	■ GREEN	12
96027	■ SILVER	12

DURA-INK #25



- Heavy duty metal barrel with pocket clip on cap.
- Chisel tip makes 1/8" fine lines or 1/4" broad marks.
- Extra-large ink supply for greater mileage.
- Use on cardboard, wood, metal, paper, ceramics glass & leather.
- For identification of equipment, marking shipping cartons, making signs, etc.

King Size Chisel Tip

IBS No.	Color	Pkg Qty
Mark Size: Thin Side 1/8" Thick Side 1/4"		
96222	■ RED	6
96223	■ BLACK	6

DURA-INK #200



- Extra-wide chisel tip for 3/8" & 5/8" marks.
- Jumbo ink supply for greater mileage.
- Ink formulated for industrial strength usage
- Durable cap and barrel for heavy-duty use.
- Use on cardboard, wood, metal, paper, ceramics, cloth, & glass.
- For identification of equipment, marking shipping cartons, making signs, etc.

Broad Chisel Tip

IBS No.	Color	Pkg Qty
Mark Size: Thin Side 3/8" Thick Side 5/8"		
96800	■ BLACK	6

C
O
A
T
I
N
G
S



DURA-INK® Retractable Permanent Markers



No more dried-out markers! Introducing retractable permanent markers for one-handed operation while still remaining sealed when not in use for maximum life and wear. The easy push-button opening and closing makes this cap-less feature ideal for use in tight or busy work spaces and eliminates mess and lost caps.

- **One-handed push button operation** eliminates lost caps and prevents ink dryout.
- **Fast drying, wear and water-resistant formula** make these markers easier and cleaner to use.
- **Industrial grade fine bullet tip** will not spread or mush.
- **Auto-storing clip** instantly retracts tip to reduce mess or tip damage.
- **Xylene-free formula** reduces health risks.

Ideal for use on: paper and cardboard, steel and iron, pipes and tubes, glass and ceramic, lumber, timber, rubber and plastic.

IBS No.	Color	Pkg Qty
Mark Size: 1/16"		
96576	■ RED	6
96575	■ BLACK	6

DURA-INK® Dual Tip Permanent Markers



Experience the versatility of Dura-Ink Dual Tip permanent ink markers and conveniently create both fine and micro-sized marks with one marker instead of two!

- **Versatile two tip design** can tackle jobs both big and small.
- **Industrial-strength ink writes on most any surface**-allowing for faster, more efficient marking in a variety of applications.

IBS No.	Color	Pkg Qty
Mark Sizes: .07mm, 1mm		
96282	■ RED	12
96283	■ BLACK	12

Valve Action Paint Markers



PRO-LINE® HP is a liquid paint marker developed for superior marking performance on oily and greasy surfaces. The high performance paint penetrates through oils and greases to dry quickly and leave a bold, permanent mark that is wear, weather, and fade-resistant.

- **Unique paint formula resists spreading and dries quickly through oily surfaces** to leave precise, permanent marks eliminating the need to clean or dry surfaces before marking – saving users time and money.
- **Excellent on most types of metals, coatings, plastics, glass, ceramics and other non-porous surfaces** for a more versatile marker to eliminate the need to carry multiple types of marking tools – saving time and inventory costs.
- **Xylene-free formula** eliminates concern about California Proposition 65, EPA HAPS, and SARA 313 compliance, minimizing employee health, environmental and waste disposal concerns.
- **Low chloride/low halogens paint formula is safe for stainless steel and other superalloys**, again making it a versatile marking tool eliminating the need to carry additional marking tools which saves time and money.
- **Industrial paint formula leaves permanent, highly visible marks that dry quickly and resist wearing and fading** so marks are easier to read and don't require multiple applications saving users valuable time and money.
- **Durable metal barrel and stronger nip allows writing on rougher surfaces**, reduces breakage and lasts longer than other tips – making it easier to use and means a longer marker life for a better value marker.
- **NEW ClipGrip Cap for convenient pocket storage and easier removal** keeps the marker on hand when and where it is needed.
- **Marking temperature range:** -50°F to 150°F (-46°C to 66°C)
- **Made in the U.S.A.**

IBS No.	Color	Qty	IBS No.	Color	Qty
96820	White	6	96824	Orange	6
96821	Yellow	6	96825	Blue	6
96822	Red	6	96826	Green	6
96823	Black	6	96832	Aluminum	6

COATINGS



IBS, INCORPORATED

Assortments Z02

Industrial Felt Tip Ink Marker Assortments

ALL BLACK MARKERS FEATURE CAP-OFF TECHNOLOGY

DURA-INK Small Kit

IBS No. 694R • 7 ITEMS • 11 PIECES

PACKAGED IN A LOCKING PLASTIC DRAWER FOR STORAGE & ORGANIZATION















 IBS, Inc. <small>SPECIALTY PRODUCTS FOR MAINTENANCE & REPAIR INDUSTRIALBOLT.COM • 800-678-1906</small>		Dura-Ink Industrial Felt Tip Markers	
		Assortment 694R	
<p>96520 DURA INK 5 BLACK EXTENDED MICRO TIP</p> 	<p>96023 DURA INK 15 BLACK FINE BULLET TIP</p> 	<p>96022 DURA INK 15 RED FINE BULLET TIP</p> 	<p>96025 DURA INK 15 BLUE FINE BULLET TIP</p> 
			<p>96026 DURA INK 15 GREEN FINE BULLET TIP</p> 
			<p>96575 DURA INK 20 BLACK RETRACTABLE FINE BULLET TIP</p> 
			<p>96576 DURA INK 20 RED RETRACTABLE FINE BULLET TIP</p> 



Industrial Markers Assortment

IBS No. 695R • 13 ITEMS • 27 PIECES

PACKAGED IN A LOCKING STEEL DRAWER FOR STORAGE & ORGANIZATION

 IBS, Inc. <small>SPECIALTY PRODUCTS FOR MAINTENANCE & REPAIR INDUSTRIALBOLT.COM • 800-678-1906</small>		Industrial Markers	
		Assortment No. 695R	
<p>96520 DURA INK 5 BLACK EXTENDED MICRO TIP</p> 	<p>96823 VALVE ACTION PAINT PEN-BLACK</p> 		
<p>96023 DURA INK 15 BLACK FINE TIP</p> 	<p>96822 VALVE ACTION PAINT PEN-RED</p> 		
<p>96022 DURA INK 15 RED FINE TIP</p> 	<p>96821 VALVE ACTION PAINT PEN-YELLOW</p> 		
<p>96025 DURA INK 15 BLUE FINE TIP</p> 	<p>96820 VALVE ACTION PAINT PEN-WHITE</p> 		
<p>96026 DURA INK 15 GREEN FINE TIP</p> 			
<p>96283 DURA INK BLACK DUAL TIP MARKER</p> 	<p>96575 DURA INK 20 BLACK RETRACTABLE BULLET TIP</p> 		
<p>96282 DURA INK RED DUAL TIP MARKER</p> 	<p>96576 DURA INK 20 RED RETRACTABLE BULLET TIP</p> 		



COATINGS

IBS, INCORPORATED

Marking & Wiping Products S01



Quik Stik Mini Paint Markers



The Quik Stik® Mini is a compact solid paint marker in a convenient twist-up, plastic holder that is ideal for finer line marking on smooth or rough surfaces. This smaller version of the Markal® Quik Stik stores easily in a pocket or tool belt and easily advances with the turn of a knob, allowing for full use of the marker. The high-performance paint dries quickly to leave bold, permanent marks on most surfaces.

- **Fast-drying**, vibrant paint marks dry in 5 to 7 minutes for fast and easy use, allowing users to work faster and more efficiently.
- **Compact plastic holder with clip-cap** stores easily in pocket and keeps hands and clothing clean allowing users to keep the markers on hand for quick and convenient use which saves time and money.
- **Marks on virtually any surface**; metal, glass, plastic, wood, cardboard, paper, etc... - even marks on wet, smooth, rough, or hot – make these super versatile eliminating the need to carry multiple markers.
- **Durable, lead-free paint** is weather- and UV-resistant for long-lasting marks that are easier to read and don't require multiple applications saving users time and money.
- Solid paint marker **advances and retracts by turning twist-up knob** for a more convenient and cleaner application compared to messy sticks – allowing users to mark with better precision and without mess – eliminates peeling off paper wrappers and no cleanup required.
- **Xylene, 2-Butoxyethanol and lead-free formula** reduces health risks, environmental and waste disposal concerns.
- Marking range: 0°F to 392°F (-18°C to 200°C)

IBS No.	Color	Qty
80120	Quik Stik Mini Paint Stick White	6
80121	Quik Stik Mini Paint Stick Yellow	6
80123	Quik Stik Mini Paint Stick Black	6

Quik Stik Mini Paint Stick Travel Tray Assortment

IBS No. 806R • 6 ITEMS • 6 PIECES

Packaged in a Locking Plastic Tray for Easy Storage & Organization



IBS, Inc.

SPECIALTY PRODUCTS FOR MAINTENANCE & REPAIR
INDUSTRIALBOLT.COM © © © 800-678-1906

Quik Stik and Paint Markers

80120
QUIK STIK MINI PAINT
STICK WHITE



80121
QUIK STIK MINI PAINT
STICK YELLOW



80123
QUIK STIK MINI PAINT
STICK BLACK



96820
VALVE ACTION PAINT
PEN-WHITE



96821
VALVE ACTION PAINT
PEN-YELLOW



96823
VALVE ACTION PAINT
PEN-BLACK



Assortment 806R



COATINGS



IBS, INCORPORATED

Marking & Wiping Products S01

Markal® Silver-Streak® Pencils



Silver-Streak® welders pencil offers torch resistant, highly visible marks that will not burn or rub off like soapstone. Writes on all types of metal surfaces, even oily, wet surfaces, making these pencils an economical must for any welder or fabricator.

- **Economical, high-strength** pencil is ideal for marking all types of metal surfaces — even oily, rusty or wet surfaces
- Perfect for **metal layout and fabrication work.**
- Marks **resistant to torch flames**; will not rub off or burn off like soapstone.

IBS No.	Color	Qty
96101	Markal Silver Streak Pencil	12
96006	Markal Silver Streak Mechanical Round	1
96007	Markal Silver Streak Mech REFILL 6PK	1

B Paintstik® Marker



- **All-purpose, cold surface marker.**
- **Real paint** in stick form, dries overnight.
- **Marks on any surface** or material.
- **Weather-resistant and fade-resistant.**
- **Ideal for layout**, color coding, inspection or fabrication.
- **Lead-free.**
- **Marks on metal**, wood, plastic, concrete, rubber, glass, cardboard and paper.
- **Marking range: -50°F to 150°F.**

IBS No.	Color	Qty
80223	B Paintstick Marker - Black	6
80221	B Paintstick Marker - Yellow	6
80220	B Paintstick Marker - White	6

Industrial Marker & Silver Streak Pencils Assortment













IBS No. 807R • 12 ITEMS • 23 PIECES

Packaged in a Locking Steel Drawer for Easy Storage & Organization



Industrial Markers & Welder's Pencils

Assortment No. 807R

<p>96023 DURA INK 15 BLACK FINE BULLET TIP</p> 	<p>96823 VALVE ACTION PAINT PEN-BLACK</p> 
<p>96022 DURA INK 15 RED FINE TIP</p> 	<p>96822 VALVE ACTION PAINT PEN- RED</p> 
<p>96025 DURA INK 15 BLUE FINE TIP</p> 	<p>96821 VALVE ACTION PAINT PEN-YELLOW</p> 
<p>96026 DURA INK 15 GREEN FINE TIP</p> 	<p>96820 VALVE ACTION PAINT PEN-WHITE</p> 
<p>96101 MARKAL SILVER STREAK PENCIL WELDERS</p> 	<p>96575 DURA INK 20 BLACK RETRACTABLE BULLET TIP</p> 
<p>96006 MARKAL SILVER STREAK MECHANICAL WELDERS ROUND PENCIL</p> 	<p>96576 DURA INK 20 RED RETRACTABLE BULLET TIP</p> 



Rustore

One Step Rust Neutralizer & Metal Primer



Rustore is a one-step rust converter and corrosion neutralizer in a convenient aerosol form. Rustore chemically neutralizes rust on metal surfaces, and converts it to a tough, black long-term protective coating that can be painted after fully cured (6 hours).

- **Minimal surface preparation** - eliminates costly sandblasting and scraping.
- **Synthetic Polymeric Formula** - seals out moisture and produces a durable coating that prevents future corrosion.
- **Fast Drying** - material can be handled within 15-60 minutes so equipment may be returned to use quickly.
- **Goes on Black** for easy visual inspection to ensure adequate coverage and to prevent over-application, waste and re-work.
- **Primes Metal** - fully cured coating can be painted.
- **Cure Time** - 6-24 hours depending on climate and temperature.

IBS No.	Description	Qty
74185	Rustore 12 oz	12

Pro-Tect

Truck Bed Coating



Pro-Tect is a thick, durable black sealant that forms a protective skin that is both tough and flexible.

- **Professional, high-viscosity liner spray that goes on thick** and will not run for a faster, easier coating and a better finish on vertical surfaces compared to other brands, saving time and money.
- **Fast drying formula means** a superior coating that will resist regular wear and last longer.
- **Texturized coating leaves a slip resistant finish** for a safer surface that prevents slipping and hides small imperfections.
- **Repairs existing liner coatings to keep surfaces protected** and eliminates costly replacements.
- **Heat resistance:** 300°F
- **Chemical Resistant** to: Gasoline, Transmission Fluid, Motor Oil, Brake Fluid, MEK, Acetone, Ethanol, Mineral Spirits.
- **Resin System:** Polyurethane
- **Dry time** (@ 72°F, 50% humidity, 1.5 mil. thick): to touch - 10 minutes to handle 4 to 6 hours
- **Estimated Coverage:** Approximately 10 Sq Ft per can (actual coverage will vary by application method, type of surface, etc...).

USE ON:

Truck Beds • Trailers • Vehicle Panels
Wheel Wells • Roll Bars • Running Bars

IBS No.	Description	Qty
74041	Pro-Tect Truck Bed Coating 15 oz	12



IBS, INCORPORATED

Aerosols & Chemicals S04

C
O
A
T
I
N
G
S

Undercoat Rubberized



Undercoat touches up vehicles previously undercoated. Protects all outside equipment from moisture and the elements.

- Dries Faster
- More Flexible
- Improved Coverage
- Prevents Rust
- Protects and Seals body undersides on trucks, buses and automobiles.
- **Protects Drums**, tanks and other outside storage vessels.
- **Seals Out Moisture.**
- **Absorbs Shock** and noise, eliminating rattles and squeaks.
- **Bonds Securely to Most Surfaces.**
- **Saves Time, Money, Labor, Mess**

Battery Terminal Protector Extends Battery Life



A **unique film** designed to **protect battery terminals** from corrosion.

Industrial battery terminal protector extends battery life, allows for maximum flow.

- **Extends battery life** by preventing corrosion.
- Improves electrical output keeping connections clean and in direct contact with terminals.
- **Remains flexible** so it won't crack when installing, removing or tightening connections.
- Dielectric strength: 30,000 volts.

USE ON: Battery posts, terminals, in automobiles, trucks, power equipment, boats, handling equipment.

DIRECTIONS:

- **MAKE SURE CELL COVERS ARE CLOSED.**
- Remove corrosion with IBS Battery Terminal Cleaner (IBS No. 74103).
- Shake well before using.
- Spray a uniform coat on to cables, posts or carriers.



IBS No.	Description	Qty
74127	Undercoat 16 oz	12

IBS No.	Description	Qty
74109	Battery Terminal Protector 15 oz	12



Clear Shield

Rubberized Peelable Coating
WHILE SUPPLIES LAST



Clear Shield is an aerosol coating that forms a skin tight rubber film that will protect surfaces and can be peeled away at any time, (or washed off with **CitruSolve** IBS No. 74115). Clear Shield **prevents nicks and scratches** on most surfaces, such as metal, wood, glass, fiberglass, and plastic. Plus, it resists humidity, corrosion, chipping and household chemicals.

- **Thick rubberized coating** means it can **protect** painted and non-painted surfaces saving costly repairs from damage.
- **Goes on clear** to provide **invisible protection from graffiti, scratches, nicks, and corrosion** saving valuable materials from defacing or damage that saves time and money in replacement costs.
- The **rubberized coating seals out moisture** and **protects against flash rusting** on any metal, making this a versatile coating for safe and easy storage of materials, saving time and money.
- **Durable rubber film** can be peeled away at any time, making removal quick and easy.

Dry Time*:

To touch 10 minutes
To recoat 10 minutes
To handle 1 hour

* At 72° F, 50% humidity, 1.5 mil thickness

** Curing/Recoat time is extended with multiple coats and excessively thick coats.**

Suggested Uses:

- Protect automotive body panels during transport
- Control overspray in paint booths
- Darken window glass
- Protect Boats and RV's during storage
- Signage

IBS No.	Description	Qty
74182	Clear Shield Coating 11 oz	12

Ceiling Tile Paint



- Special micro-void acoustical formula allows the paint to be absorbed without disturbing tile sound-reducing qualities.
- Tiles will not warp or sag.
- Eliminates water and smoke stains, or discoloring from heat and air-conditioning vents.
- Eliminates costly tile replacement.

C
O
A
T
I
N
G
S



IBS No.	Description	Qty
81751	Ceiling Tile Paint/New White 16 oz	6



IBS, INCORPORATED

Aerosols & Chemicals S04

Cold Zinc Galvanizing



Cold Zinc Galvanizing is a pure zinc spray coating scientifically compounded for complete metal protection. When sprayed on metal, the zinc and metal fuse - forming a lasting protective shield.

- **Prevents Rust and Corrosion** — Checks corrosion on previously coated damaged surfaces.
- **93% Pure Zinc Dust** — Air dries in 10 to 15 minutes.
- **Immediate Total Protection For Bare Metals.** Anywhere metal is subjected to corrosion.
- **Resistant to Salt**, corrosion, and water.
- **An Excellent Primer** for interior or exterior.
- **Rust proofs Welds.**

Meets MIL Specifications: MIL-P-46105 Weld thru primer; U.S. Navy: Galvanizing repair specification Mil-P-21035; U.S. Air Force: MIL-P-26915A for steel; U.S. Air force: MIL-P-26433 for towers (Temperate and Arctic zone)



IBS No.	Description	Qty
74112	Cold Zinc Galvanizing 15 oz	6

Green Zinc Phosphate Primer

Hi-Tech Spray Paint Zinc Phosphate Primer Coating



Specially formulated primer that is chromate-free and chemically bonds with iron, steel and aluminum to form a hard, highly adherent coating that is water-resistant.

- **Cone-shaped spray head** reduces overspray
- **Exceptional protection** against rust and corrosion
- **Resists corrosion** from seacoast exposure
- **Very effective with two part epoxies**
- **SAFE - Does not contain chlorinated solvents and is lead free**

Applications:

- **Excellent for priming** both aluminum and ferrous metals
- **Truck and automotive fleets**
- **Industrial, aeronautical and marine industries**
- **Ideal for spot repair of damaged coatings**

Technical Information:

Meets performance standards outlined in Federal Specification TT-P-1757A. Especially recommended for use over aluminum. Recommended film thickness: 0.5-1.0 mil. dry film. Exceeds 800 hours of 5% salt.

IBS No.	Description	Qty
81699	Green Zinc Phosphate Primer 15 oz	12



Gray Filler Primer Paint



Seymour Gray Filler Primer is a highly pigmented coating used to minimize the appearance of deep surface scratches and blemishes on metal surfaces. Durable and tough, it dries fast to form a hard sandable base coat. Large fan sprayhead gives a professional looking application. Eliminates the need for a spray gun for small repairs, reduces cleanup time. This user-friendly product saves time and money.

Suggested Uses:

- Fenders
- Fiberglass body panels
- Bumpers

Benefits:

- No mixing, waste, or cleanup
- Fast dry time
- Highly sandable
- Excellent adhesion
- Single coat hiding, quick film buildup
- Minimum overspray

Gray Self-Etching Weld Thru Primer



A smooth, cold galvanizing compound that dries to a durable, crack resistant coating to protect iron and steel surfaces.

- A durable, zinc enhanced coating that protects all metal surfaces
- Electrochemical galvanic action keeps on protecting even if scratched
- Dry film is 86-Percent pigment which results in less smoke and electrode wear when welding
- Cuts faster than 100-Percent zinc rich coatings
- Heat resistant up to 250°F
- Stops rust creepage

Suggested Uses:

- Effective touch-up for all marred or scratched hot dip galvanized surfaces.
- All vehicle bodies, Agricultural, mining and construction equipment.

COATINGS

IBS No.	Description	Qty
81674	Gray Filler Primer Paint 15 oz	6

IBS No.	Description	Qty
81675	Gray Self Etching Weld Thru Primer 15 oz	6



IBS, INCORPORATED

Aerosol Paint S06

Good Grip Slip Resistant Coating



C
O
A
T
I
N
G
S

- **Special epoxy resin system with plastic beads** provides a tough industrial coating that is oil and gas resistant and stands up to traffic and wear for superior life.
- **Aerosol spray can be applied to uneven surfaces and adheres better** than adhesive anti-slip tape for a safer, more permanent finish that won't lift and create a safety hazard.
- **Special valve and spray-head resists clogging** means it can be used multiple times saving time and money.
- **Easy to apply** with no special applicators or tools for a fast and effective finish that is traffic ready in 24 hours.

FOR USE ON:

**Ramps • Marine Docks • Boats • Steps
Ladder Rungs • Walkways • Railings**

IBS No.	Description	Qty
74163	Good Grip CLEAR 12 oz	6
74161	Good Grip BLACK 12 oz	6
74179	Good Grip YELLOW 12 oz	6



PRO-COAT

High Solids Industrial Protective Coating

A Maintenance Magic Product



Our unique, high solids, low solvent formulation paint that hides, covers, and protects better than any other aerosol on the market.

- **Protects** against weather, rust, oil, gasoline, corrosive chemicals and rough service.
- **Does not contain** lead, CFC's, chromates or chlorinated solvents.
- **Environmentally safe** - meets the most stringent air quality requirements in the USA.
- **High solids formulation** delivers single coat hiding power.
- **With a higher solids formula, larger can size and larger net fill weight, PRO-COAT** gives twice the coverage of conventional spray paints.

AVAILABLE IN 10 COLORS

IBS No.	Description	Qty
81433	PRO-COAT Flat Black 16 oz.	12
81415	PRO-COAT Gloss Black 16 oz.	12
81413	PRO-COAT Gloss White 16 oz.	12
81479	PRO-COAT Trim Semi-Gloss Black 15 oz.	12
81431	PRO-COAT Lt Gray Primer 17 oz.	12
81407	PRO-COAT Red Iron Oxide Primer 17 oz.	12
81672	PRO-COAT Black Sandable Primer 15 oz.	12
81427	PRO-COAT Safety Blue 16 oz.	12
81423	PRO-COAT Safety Red 16 oz.	12
81419	PRO-COAT Safety Yellow 16 oz.	12



PRO-COAT

ONE COAT COVERAGE SAVES YOU TIME & MONEY

COATINGS



IBS, INCORPORATED

Assortments Z08

Spray Tool Sampler Assortments



CLEANERS 50225-10

IBS No.	Description	Qty
74103	Battery Terminal Cleaner	1
74105	Quicker Clean	1
74111	Brake & Parts Cleaner II	2
74115	CitruSolve Aerosol	1
74158	Fabriclean	1
74120	Glass Cleaner	2
74121	Insta-Clean	1
74156	Safety Solvent IV / Degreaser	1
74165	Coil & Filter Cleaner	1
74142	Citrublast	1

PENETRANTS & LUBRICANTS 50225-12

IBS No.	Description	Qty
74107	4-Way Plus	2
74108	Silicone Spray	1
74114	Red Grease Aerosol	1
74116	PTFE Dry Lube	2
74119	Cable & Chain Lubricant	1
74125	Dry Graphite Lubricant	1
74144	PTFE Penetrating Gel Lube	2
74174	"Buster" Rust Penetrant	2

PRO-COAT HI-SOLIDS PAINT 50225-14

IBS No.	Description	Qty
81413	PRO-COAT Gloss White	2
81415	PRO-COAT Gloss Black	2
81419	PRO-COAT Safety Yellow	2
81423	PRO-COAT Safety Red	2
81427	PRO-COAT Safety Blue	2
81433	PRO-COAT Flat Black	2

FACILITIES MAINTENANCE KIT 50225-18

IBS No.	Description	Qty
74105	Quicker Clean	1
74113	Paint & Gasket Remover	1
74115	CitruSolve Aerosol	2
74116	PTFE Dry Lube	2
74120	Glass Cleaner	2
74130	Spray Adhesive	1
74144	PTFE Penetrating Gel Lube	1
74177	Sting Wasp & Hornet Repellent	1
74158	Fabriclean Carpet & Upholstery Clean	1

COATINGS 50225-20

IBS No.	Description	Qty
74041	Pro-Tect: Truck Bed Coating	1
74109	Battery Terminal Protector	1
74112	Cold Zinc Galvanizing	1
74127	Undercoating	2
74185	Rustore Rust Exterminator	2
74187	HotDam!	1
81407	PRO-COAT Red Iron Oxide Primer	2
81431	PRO-COAT Light Gray Primer	2

VEHICLE & EQUIPMENT KIT 50225-22

IBS No.	Description	Qty
74103	Battery Terminal Cleaner	1
74107	4-Way Plus	1
74109	Battery Terminal Protector	1
74114	Red Grease Aerosol	1
74121	Insta-Clean	1
74126	PowerSolve	1
74158	Fabriclean Carpet & Upholstery Clean	1
74135	Rapid Seal Heavy Bodied RTV	1
74144	PTFE Penetrating Gel Lube	1
74154	Spit Shine	1
74174	"Buster" Rust Penetrant	1
74185	Rustore Rust Exterminator	1

COATINGS

IBS, INCORPORATED

Aerosol Paints S06



IBS Paint Products

COATINGS

PRO-COAT High Solids Industrial Protective Coatings — VOC COMPLIANT

Our unique, high solids, low solvent formulation paint that hides, covers and protects better than any other aerosol on the market. Heat resistant up to 300°F. 20 oz. can size.

IBS No.	PRO-COAT	Color	IBS No.	PRO-COAT	Color
81433	PRO-COAT	Flat Black	81407	PRO-COAT	Red Iron Oxide Primer
81415	PRO-COAT	Gloss Black	81427	PRO-COAT	Safety Blue
81413	PRO-COAT	Gloss White	81423	PRO-COAT	Safety Red
81431	PRO-COAT	Lt. Gray Primer	81419	PRO-COAT	Safety Yellow
81672	PRO-COAT	Black Sandable Primer	81479	PRO-COAT	Trim Semi-Gloss Black

Industrial MRO High Solids Industrial Protective Coatings — VOC COMPLIANT

Advanced high solids coating with 3-4 times the coverage of standard aerosol paint. Heat resistant up to 300°F. 20 oz. can size

IBS No.	Seymour	Color	IBS No.	Seymour	Color
81448	620-1448	Cascade Green	81418	620-1418	Lt. Machine Gray (ANSI 70)
81447	620-1447	Cummins Beige	81443	620-1443	New CAT Yellow
81417	620-1416	Dark Machine Gray (ANSI 49)	81450	620-1450	Omaha Orange
81412	620-1412	Flat White	81452	620-1452	Safety Green
81430	620-1430	Genie Lift Blue	81451	620-1451	Safety Orange
81416	620-1416	Gray (ANSI 61)	81411	620-1411	Shiny Aluminum
81441	620-1441	ICH Red	81460	620-1460	Stainless Steel

FARM & INDUSTRY ENAMELS — HIGH SOLIDS — LEAD FREE — VOC COMPLIANT

Premium grade enamel formulated for maximum exterior durability and outstanding weather resistance. 3-4 times the coverage or standard aerosol paint. Heat resistant up to 300°F. 16 oz. can size.

IBS No.	Seymour	Color	IBS No.	Seymour	Color
81210	16-210	Allis Chalmers Orange	81266	16-266	New J.D. Yellow
81242	16-242	Ford Blue	81212	16-212	Old Cat Yellow
81224	16-224	John Deere Green	81286	16-286	School Bus Yellow
81268	16-268	New J.D. Green			

GENERAL PURPOSE ENAMELS — VOC COMPLIANT

Ideal for general purpose applications where maximum indoor/outdoor coating performance is required. Heat resistant up to 300°F. 16 oz. can size.

IBS No.	Seymour	Color	IBS No.	Seymour	Color
81360	EN-60	Alpine Green	81628	16-128	Hunter Green

SPECIALTIES

16 oz. can size.

IBS No.	Seymour	Color	IBS No.	Seymour	Color
74112	16-1445	Cold Zinc Galvanizing	81203	16-1203	Hi-Temp Black (1200°F)
81699	16-899	Green Zinc Phosphate	81674	20-1674	Gray Filler Primer Paint
81675	20-1675	Gray Self Etch Weld			



IBS, INCORPORATED

Aerosol Paints S06

IBS Paint Products



**Straight Tip
Applicator on
Inverted Tip
Marking Products**

WATER BASE MARKING PRODUCTS

Fast drying permanent marking paint applied In an inverted position To produce vivid lines and is safe on grass. 20 oz. can size.

Marking paints come with the converta-cap, a specially designed protective cover that does not need to be removed before using. This provides the user with a convenient marking tool without the worry of accidentally spraying.



IBS No.	Seymour	Color	Tip Style
82052	20-652	White	Straight
82054	20-654	Red Fluorescent	Straight
82057	20-657	Orange Fluorescent	Straight
82068	20-668	Green Fluorescent	Straight
82069	20-669	Blue Fluorescent	Straight
82076	20-676	Hi-Visibility Yellow	Straight



**T-Tip
Applicator on
Stripe Traffic
Marking Products**

STRIPE TRAFFIC & ATHLETIC FIELD MARKING PRODUCTS

Water based formulation for striping. Makes 2"- 4" wide stripes that are traffic 20 oz. can size.

Traffic Marker and Athletic Field Marker Inverted Tips have Universal Spray Tip. Crisp lines up to 4" wide and approximately 250 feet in length can be expected from each 20 ounce can. This Spray Tip allows product to be used with most types of marking equipment.



IBS No.	Seymour	Color	Tip Style
81642	20-642	White	T-Tip
81646	20-646	Yellow	T-Tip
81644	20-644	White (Athletic Field)	T-Tip

C
O
A
T
I
N
G
S



Lubricants

Lubricants

A

Aerosols

Lubricants

- Cable & Chain Lubricant SL-6
- Dry Graphite Lubricant SL-6
- Food Lube SL-7
- Gear Lube SL-8
- High-Temp Anti-Seize SL-8
- PTFE® Dry Lube SL-6, SL-9
- PTFE Penetrating Gel-Lube SL-9
- Red Grease SL-10
- Silicone Spray SL-11
- Tool Cool SL-12

Anti-Seize

- Anti-Seize Gel Aluminum Formula SL-3, SL-4
- Anti-Seize Gel Copper Formula SL-3, SL-4
- C5A Copper Based Anti-Seize SL-2
- C5A Copper Based Anti-Seize QuickStix™ SL-2
- High-Temp Anti-Seize SL-8
- White Food Grade Anti-Seize SL-2

Assortments

- Thread Locker, Anti-Seize & Dielectric Grease Assortment SL-4
- Thread Locker, Anti-Seize & Dielectric Grease Travel Tray SL-4

L

Loctite Products

Anti-Seize

- C5A Copper Based Anti-Seize SL-2
- C5A Copper Based Anti-Seize QuickStix™ SL-2
- White Food Grade Anti-Seize SL-2

Lubricants

Anti-Seize

- Anti-Seize Gel Aluminum Formula SL-3, SL-4
- Anti-Seize Gel Copper Formula SL-3
- C5A Copper Based Anti-Seize SL-2
- C5A Copper Based Anti-Seize QuickStix™ SL-2
- E-Z Coat SL-7
- White Food Grade Anti-Seize SL-2
- Cable & Chain Lubricant SL-6

- Dielectric Grease Pump SL-3, SL-4
- Dry Graphite Lubricant SL-6
- Food Lube SL-7
- Gear Lube SL-8
- Lubriplate No. 105
- White Motor Assembly Grease SL-9
- PTFE® Dry Lube SL-6, SL-9
- PTFE Penetrating Gel-Lube SL-9
- Red Grease II
- Aerosol SL-10
- Cartridge SL-10
- Silicone Spray SL-11
- Super Moly Grease SL-9, SL-11
- Tool Cool SL-12
- Tool Cool Blue SL-12
- Tool Ease SL-13
- Ultra Lube Super Premium
- Cutting Fluid SL-13
- White Guard Supreme SL-13



IBS, INCORPORATED

Loctite Products S08

L
U
B
R
I
C
A
N
T
S



C5-A Copper Based Anti-Seize

Exclusive formula suspends copper and graphite in a high quality grease. Protects metal parts from rust corrosion, galling and seizing at temperatures to 1800°F (982°C). Tested to MIL-PRF-907-E

IBS No.	Description	Qty
51007	C5-A Copper Based Anti-Seize 1 lb	1



C5-A Copper Based Anti-Seize Quickstix™

The same trusted performance characteristics as the Loctite C5-A Copper Based Anti-Seize paste in a convenient semi-solid stick form. Stick package offers more portability and less mess. Meets the performance requirements of MIL-PRF-907E and CFIA approved.

IBS No.	Description	Qty
37229	C5-A Copper Anti-Seize Quickstix™ 19 grams	1



Dielectric Grease

Provides a moisture-proof barrier that lubricates and protects electrical equipment from salt, dirt and corrosion. High dielectric strength. Good thermal, oxidation, and chemical stability.

IBS No.	Description	Qty
37535	Dielectric Grease 3 oz tube	1



Marine Grade Anti-Seize

Provides a moisture-proof barrier that lubricates and protects electrical equipment from salt, dirt and corrosion. High dielectric strength. Good thermal, oxidation, and chemical stability.

IBS No.	Description	Qty
34026	Marine Grade Anti-Seize 16 oz	1



White Food Grade Anti-Seize - Metal Free

Prevents seizure, galling and friction in stainless steel and other metal parts up to 750°F (400°C). NSF H1 approved for incidental food contact.

IBS No.	Description	Qty
51168	White Food Grade Anti-Seize 8 oz	1

LOCTITE ANTI-SEIZE & LUBRICANTS PROPERTIES CHART

PRODUCT	IBS No.	Container	Color	Temp Resistance	K Value
C5-A Copper Based Anti-Seize Lubricant	51007	1 Lb brush top can	Copper	1800°F (982°C)	0.16
C5-A Copper Based Anti-Seize Quick Stick	37229	19 gm	Copper	1800°F (982°C)	0.16
Marine Grade Anti-Seize	34026	16 oz brush top can	Black	1800°F (1315°C)	0.18
Dielectric Grease	37535	3 oz tube	—	450°F (204°C)	—
White Food Grade Anti-Seize	51168	8 oz brush top can	White	1800°F (400°C)	0.13



Anti-Seize Gel Pump - Aluminum Formula



ANTI-SEIZE GEL ALUMINUM FORMULA is a better, faster way to apply anti-seize to bolts, studs, or anywhere it is needed. The gel goes on without messy drips, globs and waste.

- **Comprised of uniform, fine flaked aluminum and graphite particles in a special blend of lubricants and oils** — prevents seizing, galling excessive wear, and corrosion.
- **Pump dispenser makes this product easy to dispense with no mess and exceptional control**, which minimizes waste and prevents cross contamination — **SAVES TIME & MONEY!**
- **Typical Applications:** Ideal for use on nuts, bolts, screws, pipe threads, o-rings, shafts and hubs. Other applications include: conveyor systems, valves, gear boxes, chains, cams, u-joints, sprockets and tracking.
- MAX Operating Temperature -65°F to +1800°F
- Meets Mill Spec MIL-A-907E

IBS No.	Description	Qty
74151	Anti-Seize Gel Aluminum Formula	1

Anti-Seize Gel Pump - Copper Formula



ANTI-SEIZE GEL COPPER FORMULA is a better, faster way to apply anti-seize to bolts, studs, or anywhere it is needed. The gel goes on without messy drips, globs and waste.

- **Comprised of uniform, fine flaked copper and graphite particles in a special blend of lubricants and oils.** Prevents seizing, galling excessive wear, and corrosion.
- **Pump dispenser makes this product easy to dispense with no mess and exceptional control**, which minimizes waste and prevents cross contamination — **SAVES TIME & MONEY!**
- **Typical Applications:** Ideal for use on softer metal parts such as copper, brass, plastics and non-metallic gaskets. It prevents seizing, galling, excessive wear.
- **Effective to Operating Temperature +1800°F**

IBS No.	Description	Qty
74152	Anti-Seize Gel Copper 1.18 fl. oz	1

Dielectric Grease Pump



DIELECTRIC GREASE ensures longevity of your connection points and helps create extra insulation for electrical connections.

- **Prevents fusing & corrosion** on battery terminals.
- **Prevents voltage leakage** in high energy ignition systems
- **Ideal for use on electrical connections** with rubber gaskets.
- **APPLICATIONS INCLUDE:** Spark Plug Boots, Battery Terminals, Ignition Coil Connectors, Headlamp Connectors, Trailer Electrical Connectors, Bulb Sockets, High Energy Electrical Systems and more.

IBS No.	Description	Qty
74160	Dielectric Grease Pump 1.18 fl. oz.	1

LUBRICANTS



IBS, INCORPORATED

Assortments Z02

Thread Locker, Anti-Seize & Dielectric Grease Assortment

IBS No. 833R • 6 Items • 12 Pcs

Packaged in a Locking Steel Drawer for Easy Storage & Organization



IBS, Inc.
SPECIALTY PRODUCTS FOR MAINTENANCE & REPAIR
INDUSTRIALBOLT.COM © © © 800-678-1906

Thread Locker, Anti-Seize
& Dielectric Grease

Assortment 833R

<p>74242 MEDIUM STRENGTH THREADLOCKER GEL BLUE 35ML</p> 	<p>74262 HIGH STRENGTH THREADLOCKER GEL RED 35ML</p> 	<p>74151 ANTI SEIZE GEL ALUMINUM 35ML</p> 	<p>74152 ANTI SEIZE GEL COPPER 35ML</p> 	<p>74159 PTFE PIPE SEALANT GEL 35ML</p> 	<p>74160 DIELECTRIC GREASE PUMP 35ML</p> 
---	--	---	--	---	--



L
U
B
R
I
C
A
N
T
S

Thread Locker, Anti-Seize & Dielectric Grease Travel Tray

IBS No. 832R • 6 Items • 6 Pcs

Packaged in a Plastic Travel Tray for Easy Storage & Organization



IBS, Inc.
SPECIALTY PRODUCTS FOR MAINTENANCE & REPAIR
INDUSTRIALBOLT.COM © © © 800-678-1906

Thread Locker, Anti-Seize
& Dielectric Grease

Assortment 832R

<p>74242 MEDIUM STRENGTH THREADLOCKER GEL BLUE 35ML</p> 	<p>74262 HIGH STRENGTH THREADLOCKER GEL RED 35ML</p> 	<p>74151 ANTI SEIZE GEL ALUMINUM 35ML</p> 	<p>74152 ANTI SEIZE GEL COPPER 35ML</p> 	<p>74159 PTFE PIPE SEALANT GEL 35ML</p> 	<p>74160 DIELECTRIC GREASE PUMP 35ML</p> 
---	--	---	--	---	--





Anti-Seize Lubricant & Sealant

Anti-Seize Lubricant & Sealant is a special blend of extra fine graphite and aluminum particles in synthetic oils. Its unique qualities prevent corrosion, seizure, and galling where two metals (including stainless steels) must come together to provide a tight fit. **It is effective to 2200°F** and also functions as a high temperature lubricant and sealant.

- **AS022 is absolutely non-melting**, will not drip or run.
- **Superior to copper or lead based lubricants because it:**
 1. Eliminates electrolysis.
 2. Withstands higher temperatures and pressures.
 3. Gives cleaner breakouts from high torques.
- **Unique brush pump dispenser for 16 oz cans** allows use of all the product in the can, cleaner application of the product (no messy hands), and keeps product from becoming contaminated.

FOR USE ON:

Rollers & Conveyors • Gears • Chains • Drives • All Threaded Fittings • Valve Stems • Cages • Gaskets
 Flanges • O-Rings • Key ways • Fuel Injectors • Spark Plugs • Shaft Coupling Bolts • Low RPM Bearings
 Cylinder Head Assemblies • Furnaces & Burner Assemblies



Technical Data:

Temperature Range.....-20° to 2200°F
 Flash Point.....C.O.C. 310°F
 Color.....Silver
 NLGI Grade.....No. 1
 Water Resistance.....Insoluble
 Protective equipment.....None
 Poison Classification.....Non-toxic
 Particle size.....Less than 1 micron

Note: Corrosive inhibitors: Conventional Imadazole Derivate, EP Additive: diester
 Type - contains no Phosphorous, sulfur, or metal salt. Raw materials used for manufacturing AS022 contains 0 ppm chlorides and 0 ppm heavy metals. AS022 in grease cartridge fortified with molybdenum disulfide.

IBS No.	Description	Qty
AS022	Anti-Seize Lubricant & Sealant 16 oz	1
EQ001	Brush Top Dispenser	1

LUBRICANTS



IBS, INCORPORATED

Aerosols & Chemicals S04

Air Tool Conditioner



Air Tool Conditioner provides a fast, effective way to clean, lubricate and extend the operating life of all air tools. It breaks loose deposits that create friction and impede smooth operation. It also provides long-lasting lubrication and protects tools from freeze up.

- **Fast and easy to use.**
- **Perfect for grinders, drills, polishers, impact wrenches, sanders, air motors & jackhammers.**
- **Enables motor parts** to move more freely.
- **Cleans, lubricates, and increases tool life.**
- **Inhibits rust.**
- **Restores air tools** to peak power and RPMs and enables tools to work more efficiently.
- **Helps prevent tool binding** and slow down.
- **Saves time, money, labor, mess.**
- **Protects tools** from freezing down to -25°F

IBS No.	Description	Qty
74137	Blaster Air Tool Conditioner 11 oz	12

Cable & Chain Lubricant



Cable & Chain Lubricant is the ultimate protection for wire rope and chain to prevent wear and corrosion in the presence of heat, friction, stress and even extreme moisture.

- **Thick foam clings to vertical surfaces** allowing the foam to penetrate into wire rope, links and roller mechanisms.
- **The Moly coats the metal strands of wire rope and chain links** to reduce friction and wearing, extending the life and reducing costly maintenance.
- **Will not break down even at high operating temperatures** for better versatility and broader applications.
- **Forms a thin, dry protective film** that extends the life of the equipment by preventing corrosion and rust.
- **Temperature Range:** +10°F degrees to +500°F degrees.

IBS No.	Description	Qty
74119	Cable & Chain Lubricant 16 oz	12

Dry Graphite Lubricant



Dry Graphite Lubricant is a fast drying graphite lubricant that reduces friction and noise. It is effective under heavy pressures and a range of temperature extremes.

- **Graphite based lubricant** makes this effective under **broad temperature ranges:** -100°F to 850°F (-73°C to 454°C) makes this a versatile lubricant can be used in extreme temperature applications for an all season lubricant that can help reduce inventory.
- **Contains no oil or moisture based diluents** — which results in a dry and effective lubricant **that won't gather dust and dirt** that can clog and wear machine parts saving costly repair and replacement.
- **Adheres and dries to the surface it is sprayed on and is inert to oils, water and alkalis** — Will not wash away, making this lubricant effective in a wide variety of applications eliminating the need for multiple products.

Applications:

- Where a dry lubricant is essential and petroleum products must be avoided.
- Tracts, bearings, conveyor parts, flat springs, hinges, die casting machines, oven parts.
- All pre-assembly operations where dust and dirt-free lubrication is required.

IBS No.	Description	Qty
74125	Dry Graphite Lubricant 14 oz	12

L
U
B
R
I
C
A
N
T
S



E-Z Coat Anti-Seize Compound



Remove nuts and bolts easily by applying this high quality **E-Z Coat Anti-Seize Compound** during assembly. It even works after the assembly has been exposed to extremely high temperatures (Up to 2100°F!).

- **Features a unique applicator system** which allows the compound to be quickly and neatly applied to threads without messy drips or waste.
- **E-Z Coat Anti-Seize Compound provides outstanding protection** against rust and corrosion on any type of metal.
- **Insures easy disassembly** for bolt, spark plugs, threaded fittings, gaskets, and bushings.

FOR USE ON:

Engine Head Bolts • Exhaust Manifold Studs Starter & Alternator Bolts • Spring Bolts
Lug Nuts & Spark Plugs

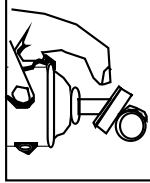

Directions For Use:

1. Clean surface before application.
2. Remove plastic cap from applicator.
3. Press applicator against threads to activate pressure valve to eject compound.
4. Move applicator around surface to apply compound evenly.
5. Replace plastic cap.

IBS No.	Description	Qty
74150	E-Z Coat Anti-Seize 8 oz	6

Food Lube - Food Grade Equipment Lubricant



FOOD LUBE is made up of USP liquid petroleum and propellant that provides a sanitary means of lubricating dairy and food processing equipment.

- **H1 Rated** for use in and around Food Processing Areas.
- No Water or Fillers
- Effective from -40°F to +250°F
- Lubricates Parts to ensure free and easy movement.

USED ON: Slides, bearings, pistons and rings, seals and pump parts, pants containers, belts, etc.

USED IN: Meat and poultry companies, dairy, egg operations, fast food restaurants, cut meat cold room packaging, prepackaged meat units for franchises, food filling equipment including milk and ice cream.

Non-Toxic - Odorless - Tasteless - Contains no silicones
Contains no CFC's - Made in the USA

IBS No.	Description	Qty
74110	Food Lube 12 oz	12

L
U
B
R
I
C
A
N
T
S



IBS, INCORPORATED

Aerosols & Chemicals S04

Gear Lube



Gear Lube is a solid film, highly viscous lubricant for use on gears, chains, cables, wire ropes, sprockets, industrial machinery and heavy construction equipment. It protects against rust and corrosion by repelling water from surfaces.

- **Tar Based Formula** is thick and tacky allowing it to stay on the gear where it is needed, extending the life of machinery, reducing downtime and maintenance.
- **High viscosity formula** clings to vertical and overhead surfaces and won't drip or run, making applications easier with less mess, saving preparation time and cleanup time.
- **Thick and tacky formula** resists washout, protecting against rust and corrosion extending life and saving time and money.
- **Excellent stretching** characteristics allow surfaces to be completely covered, reducing noise for a safer working environment.
- **Reduces noise and protects gears** in case of excessive loads.
- **Temperature range** of 20°F to 175°F.
- Contains **no chlorinated or fluorinated** solvents that can deplete the ozone, making it a safer

IBS No.	Description	Qty
74124	Gear Lube 12 oz	12

High-Temp Anti-Seize



High-Temp Anti-Seize is a high-quality, copper fortified lubricant and protective coating that is great for nuts, bolts, studs, etc.

- **Prevents galling, seizing and galvanizing action.**
- **Repels water and will not harden, gum or melt.**
- **Compatible with other lubricants.**
- **Multiple use product** — Eliminates the need for other coatings, protectorates or lubricants.
- **Effective to temperatures exceeding 2000°F** — Can be used effectively in many different temperatures making it an ideal choice for highly corrosive environments.
- **Prevents corrosion** from bearings, nuts, studs, etc.
- **Ideal for use as anti-seize on** nuts, bolts, studs, etc. Premium quality lubricant for bearings, slides, etc. Protective coating for use in highly corrosive environments.
- Copper fortified.

Directions For Use: Shake well before using. Make sure surface is cleaned of all dirt, grease and grime. Spray liberally 8 to 10 inches from surface to be sprayed. Invert can after use and spray short bursts to clear valve.

IBS No.	Description	Qty
74134	Hi-Temp Anti-Seize 14 oz	12

L
U
B
R
I
C
A
N
T
S



Lubriplate No. 105 - WHITE MOTOR ASSEMBLY GREASE



LUBRIPLATE No. 105 is a white, waterproof, NLGI No. 0, grease type lubricant possessing exceptional anti-seize properties and recommended extensively for coating all moving parts for motor assembly and rebuilding.

- Provides lubrication during the initial start-up before the motor oil has circulated.
- Protects freshly machined engine parts from rust and corrosion.

LUBRIPLATE No. 105 is also recommended for the following applications:

Press Fittings | Shackle Pin and Spring Assemblies | Door Hinges | Wheel and Nut Assemblies
 Striker Points | Hinges on Trunk and Hood | Battery Terminals | Anti-Seize Applications
 Windshield Wipers | General Rust Proofing of Parts and Tools | Radio Antennas
 Remote Control Gear Shift Mechanisms | Manual Operated Steering Gear Mechanisms

IBS No.	Description	Qty
74405	Lubriplate No. 105 10 oz.	12

PTFE® Dry Lube



PTFE Dry Lube is a chemically inert, non-oily, fast drying lubricant and release agent containing an extremely fine PTFE® powder. Features outstanding microscopic film-forming properties, more slippery than silicone. Provides superior friction reduction in all metal on metal, rubber on metal, and metal on plastic applications.

- Non-oily, fast drying lubricant
- Odorless
- Stainless
- Effective from -100°F to +500°F
- No chlorinated solvents
- More slippery than silicone, graphite, or oil.

SAFE ON:

Plastic • Aluminum • Rubber
 Glass • Wood • Paper • Metal

FOR USE BY:

Bottling Plants • Dairies Packaging Plants
 Processing Plants • Manufacturing Facilities
 Maintenance Depts. • Assembly Operations

IBS No.	Description	Qty
74116	PTFE Dry Lube 11 oz	12

PTFE Penetrating Gel Lube



PTFE® Penetrating Gel Lube is a transparent, high pressure lubricant with high adhesive strength. A unique combination of natural and synthetic lubrication agents coupled with a high molecule weight polymer (PTFE - also known as Teflon®) makes this PTFE® Penetrating Gel Lube one of the best on the market.

- **Long Lasting Protection**
- **Penetrating High-Tack Formula**
- **Forms a Moisture Barrier - Prevents Rust & Corrosion**
- **High Adhesive Strength** - Adheres to surface, resists throw-off and squeeze out when subjected to high pressures, vibrations or repeated impact.
- **Solvents Evaporate Quickly** - Allows maximum penetration and rapid set up of the grease-like lubricant.
- **Lubricates Over A Wide Temperature Range** - Will withstand high temperatures of -30°F to +500°F without melting. Has a high dropping point.
- **Coated Metal Parts Resist Water Wash-out** - Helps prevent rust and corrosion.
- **Use On** door hinges, open gears, wire ropes and cables, chains and sprockets, conveyors, and manifold heat valves. Also works well for above water line marine applications.

Directions For Use: Shake can well before using. Saturate area to be lubricated and allow solvent to evaporate. Use an extension tube for hard to reach areas

NOTE: NOT AVAILABLE FOR SALE IN THE STATE OF CALIFORNIA

IBS No.	Description	Qty
74144	PTFE Penetrating Gel Lube 13 oz	12

LUBRICANTS



IBS, INCORPORATED

Aerosols & Chemicals S04

Red Grease II Aerosol



Red Grease II is an aluminum based multi-purpose lubricant that provides extra protection under extreme pressures. It is superior to lithium or calcium greases because it resists thinning under high pressure and returns to a thick, gel-like consistency after exposure to high temperatures.

- **Excellent reversability (ability to return to original consistency after exposure to heat.)** - Will not harden, separate or emulsify when subjected to excessive heat or pressure.
- **100% waterproof.** Resists water, acid, salts, and alkaline chemicals. Prevents dust and grit from migrating into the grease.
- **Penetrates** as a liquid — Congeals to a thick grease. Maintains high viscosity under high load and resists oxidation during periods of no load and at rest for duration.
- **Good shear resisting structure** — Minimizes thinning under high load thereby maintaining the viscosity to provide good lubricity.
- **Non-freezing.**
- **Can be used on all electrical motor shafts**, fifth wheels, roller chains, agricultural hitches, heavy duty equipment, bearing surfaces, cables, pulleys, hinges, etc.
- **Temperature Range:** -40°F to 575°F.

IBS No.	Description	Qty
74114	Red Grease II Aerosol 11.25 oz	12

Red Grease II - HI-TEMP APPLICATIONS



Red Grease II is an all purpose heavy-duty non-melt lubricant specially formulated with extreme pressure and anti-wear additives.

- **Exceptional resistance** to acids, water, salts, weather, dirt, dust, steam and oxidation.
- **Contains extra tackifiers** which makes this grease stringier and stickier, giving it better holding and staying power — which means it stays where it belongs, keeping parts lubricated, sealing out contaminants and providing better resistance to washout.
- **With metallic additives** to provide additional anti-seize characteristics — helps to prevent parts from galling or seizing together under harsh conditions.
- **Excellent adhesive, cohesive and anti-wear properties.**
- **Resists harsh outdoor conditions**, extreme pressure, and high heat of up to 500° F.
- **High shock and impact resistance.** Extra cushioning reduces shock and noise.
- **Prolongs life of metals** with its special corrosion and rust inhibitors. Seals out dust, dirt, water, and other contaminants.
- **Excellent load carrying capabilities** 50 lb. Timken OK Load.
- **Temperature range:** 0°F – 450°F (-18°C - 232°C)
- **NLG12**
- **Totally non-conductive.**
- **Fits any standard cartridge-type grease gun**

MEETS MIL SPEC:

MIL-G-18709

MIL-G-24139

MIL-G-4906

IBS No.	Description	Qty
74402	Red Grease II Cartridge 14 oz	10

L
U
B
R
I
C
A
N
T
S

IBS, INCORPORATED

Aerosols & Chemicals S04



Silicone Spray - COLORLESS • ODORLESS • STAINLESS MEETS USDA REQUIREMENTS • USDA H1 RATED



Silicone Spray is a high-tech spray lube specifically formulated for the needs of the food industry. This product meets USDA requirements for use in federally inspected meat and poultry plants.

- **Rust proofs and waterproofs** — Repels moisture and prevents rust.
- **Reduces friction** on surfaces, lubricates and quiets moving parts.
- **Dresses and details** rubber, plastic, vinyl and other materials.
- **Colorless**
- **Odorless**
- **Heat stable**
- **Non-staining**
- **Versatile** — can be used on virtually any surface.
- **For Use** in producing, manufacturing, preparing, processing, treating, packaging, transporting, or handling food.
- **Saves time, money, labor, mess**

IBS No.	Description	Qty
74108	Silicone Spray 9.25 oz	12

Super Moly Grease

CALCIUM SULFONATE COMPLEX GREASE CARTRIDGE



Super Moly Grease is a high performance, EP2 extreme pressure grease intended for the lubrication of heavy duty machinery during severe operating conditions, such as high operating temperatures, heavy loads, extreme pressure and areas where high amounts of water washout will destroy typical EP2 grease.

- Unmatched natural lubrication properties due to the **high quality calcium sulfonate** thickener which offers superior load carrying properties. Calcium Sulfonate grease will last 2-3 times longer than standard base grease.
- **Fortified with 5% molybdenum (MoS2) additive** that plates itself to the metal surfaces in order to form a long lasting solid lubricant film that will withstand pressures up to 500,000 psi, which provides extended equipment life.
- **Outstanding film strength** and resistance to corrosive saltwater type environments provides exceptional anti-wear & EP (Extreme Pressure) properties, anticorrosive capacity and rust prevention - Equates to reduced grease consumption.

Technical Data:

Temperature Range..... -30°F to 500°F Continuous -30°F to 550°F Intermittent
 Color.....Gray-Black
 NLGI Grade.....No. 2
 Timken OK65 lbs.
 Dropping Point575°F
 Worked Penetration. 285

IBS No.	Description	Qty
74400	Super Moly Grease 14.4 Oz tube	10

L
U
B
R
I
C
A
N
T
S



IBS, INCORPORATED

Aerosols & Chemicals S04

Tool Cool



Tool Cool has a unique formulation that provides rapid evaporation for maximum cooling effect, plus special lubrication compounds for smoother cutting action, with the convenience of an aerosol. Its special blend reduces tool temperature by preventing heat build-up and reducing friction.

- **Instantly lowers temperature** for a cleaner, smoother cut.
- **Keeps cutting tools running** at lower temperatures for extended life.
- **Excellent for drilling**, tapping and threading. Use with drill bits, taps, reamers and saws.
- **Effective on all metals** (except aluminum and true cast iron). A must for hi-strength and exotic metals.
- **Does not contain** trichloroethylene, carbon tetrachloride, chloroform, or sulphur-containing compounds.
- **Leaves no residue** - no extra clean-up required. Simply wipe with rag or blow off with air hose.
- **Absorbs heat** generated by drilling and reaming.
- **Non-flammable.**
- **Special propellant** allows for use in cold weather temperatures.
- **Saves time, money, labor, mess.**

Directions For Use: Shake well before using.

Holding can in upright position, spray directly on tool and work surface from a distance of 8 inches. Repeat as necessary when surface or tool starts to warm.

IBS No.	Description	Qty
74102	Tool Cool 18 oz	12

Tool Cool Blue • EXOTIC METALS LUBRICANT



Tool Cool Blue is a specialized lubricant designed for tough metal-working operations on hard metals such as stainless, high carbon, high chrome, nickel-chrome, heat-treated steels, cast iron, monel and even non-ferrous metals like brass and aluminum. This compound contains no oil and eliminates the difficult cleaning problems associated petroleum lubricants that leave an oily mess.

Tool Cool Blue is a multipurpose lubricant, offering a new level of tool-life along with the cleanliness of a water/soap based compound, is a clean lubricant that contains no petroleum, chlorine or sulfur, and is a water-based soap, maintaining a clean work area with no oily surfaces.

It's also the solution for difficult metal working operations such as welds on carbon steel.

Tool Cool Blue can be used for drilling, tapping, sawing, spot facing, counterboring, milling, fly-cutting, seat forming, engraving, broaching, drawing, piercing, punching, hole extruding and more.

Tool Cool Blue can also be used on non-ferrous metals, such as brass and aluminum.

Tool Cool Blue is a an exceedingly clean lubricant. It contains no oil, and creates none of the difficult cleaning problems associated with white lead, molybdenum, and similar materials.

- Cuts 30% faster than dry cutting*
- Extends cutting tool life
- Reduces down time (*individual results may vary by material and drill)

Environmentally Safe: Contains no chlorine, fluorine, lead, sulfur, phosphorous, or silicone. Is acceptable for use in machine shops operating under the Federal Meat and Poultry Products Inspection Program (P-1).

IBS No.	Description	Qty
74208	Tool Cool Blue 8 oz	12

L
U
B
R
I
C
A
N
T
S

IBS, INCORPORATED

Aerosols & Chemicals S04



Tool Ease

DRY LUBE FOR DRILLING, THREADING AND CUTTING TOOLS



Tool Ease is a stick lubricant for use in all types of drilling applications. It's the clean, convenient way to extend drill and tap life. **Tool Ease** reduces friction and heat while increasing tool life an efficiency. Tools stay cooler and cut cleaner.

- **Simple-to-use:** Apply directly to cutting surface and re-apply as necessary.
- **Easily cleaned** and leaves no residue.
- **Contains no harmful chemicals** and is environmentally safe to use.



IBS No.	Description	Qty
74172	Tool Ease 3.2 oz.	12

Ultra Lube Super Premium Cutting Fluid (S04)



Ultra Lube is a multi-purpose cutting fluid specially formulated to extend tool life and reduce chip welding. **Ultra Lube** also provides a precision finish with closer tolerances on finished work.

- **Super concentrated formula** will not run and even clings to vertical surfaces keeping the lubricant on the tool or at the drilling/cutting point for continual lubrication resulting in cooler cutting which means longer tool life, saving time and money.
- **Contains no harsh chemicals or ozone depleting chemicals** which provides a virtual smoke free operation on even the most heat prone applications for a safer, cleaner cut making for faster clean up.
- **Available in a small, easier to handle 4 oz. bottle for hand drilling applications** that is easier to apply and get the lubricant exactly where it's needed, saving user time and money.
- **16 oz. bottle perfect for larger jobs** and coolant reservoir filling.

IBS No.	Description	Qty
96050	Ultra Lube Cutting Fluid 4 oz. bottle	12
96070	Ultra Lube Cutting Fluid 16 oz. bottle	12

White Guard Supreme - WITH PTFE • USDA "H1" RATED



Maintenance Magic White Guard Supreme is a specialty high temperature polymer grease engineered specifically for the food processing and packaging industry. It is authorized by USDA for use in federally inspected meat and poultry plants. It is compounded with EP and anti-wear additives as well as rust and oxidation inhibitors. It possesses good adhesion/cohesion properties and is water insoluble and very resistant to water washout. This premium grease has a neutral petroleum odor and is non-staining.

- **H1 Rated for incidental food contact and can be used in food processing areas.**
- **Aluminum Complex base grease**
- **Non-Staining**
- **Anti-Wear Additives**
- **500°F drop point**
- **Non-Toxic**
- **Odorless**
- **Will not discolor or oxidize**
- **50 Timken OK Load**

FOR USE ON:

Conveyors • Sprockets • Cams • Rollers • Gears • Chairs • Cables • Casters • Chains • Dicers
Grid Belts • Slides • Slicers • Guide Rails • Plungers • Open Lube Points • & Much More!

IBS No.	Description	Qty
74410	White Guard Supreme 14 oz	12

L
U
B
R
I
C
A
N
T
S



IBS, INCORPORATED

Aerosols & Chemicals S04

**L
U
B
R
I
C
A
N
T
S**



Miscellaneous

A

Aerosols

- De-Icer
 - D-Frost Frost & Ice Remover SMISC-3
- Freshen Up
 - Odor Eliminators SMISC-2
- Pesticides
 - Sting Wasp & Hornet Killer SMISC-4
- Vandalism Removers
 - Paint, Gasket & Vandalism Remover SMISC-3
- Welding
 - HOT DAM!
 - Heat Dissipating Spray SMISC-3

D

De-Icer

- D-Frost Frost & Ice Remover SMISC-3
- Drive Grip Anti Cam-Out Fluid SMISC-5**

I

Insect Repellent

- Fly-Away Wipes SMISC-2

L

Loctite Products

- Lubricants
 - VROOM Starting Fluid SMISC-6

Lubricants

- VROOM Starting Fluid SMISC-6
- White Guard Supreme SMISC-6

O

Odor Eliminators

- Citrus Creme SMISC-2
- Fresh Scent SMISC-2

P

Pesticides

- Wasp & Hornet Killer
 - STING SMISC-4

T

Tools

- Can-Gun SMISC-5

V

Vandalism Remover

- Paint, Gasket & Vandalism Remover SMISC-3

W

Welding

- HOT DAM!
 - Heat Dissipating Spray & Flame Retardant SMISC-3

Wipes

- Fly-Away
 - Insect Repellent SMISC-2

M
I
S
C
E
L
L
A
N
E
O
U
S



IBS, INCORPORATED

Aerosols & Chemicals (S04)

M
I
S
C
E
L
L
A
N
E
O
U
S

Fly-Away Insect Repellent Wipes



FLY-AWAY is an easy-to-use and effective product to help ward off even the most annoying insects.

- **Convenient**, easy to use wipes allow for quick and thorough application to skin, hair, and clothing to ensure maximum protection.
- **Easy to use**, just wipe onto exposed skin, and throw the wipes away.
- **25% Deet** — providing a cost effective, safe and effective repellent strength.
- **Water-Based** Insect Repellent Formula — **safer** to use than solvent formulas or aerosols that create airborne fumes that can be ingested.
- 4 hours of protection from insects.
- Leaves **No Sticky Residue** — more comfortable to use.
- Easier to apply to head, ears and face than sprays that can get into your eyes, ears and mouth.
- No Strong/Offensive Odor.
- **Non-VOC Formula** — can be shipped to all states.

Effective Against

Black Flies • Fleas • Mosquitoes • Stable Flies
Chiggers • Gnats • Sand Flies • Ticks

Uses

Construction • Biking • Fishing • Gardening
Utility Work • Camping • Hunting • Road Work
Sanitation Crews • Boating • Farming • Golfing

IBS No.	Description	Qty
74189	Fly-Away Insect Repellent Wipes 6.6 oz Net Wt., 40 Wipes	6

Odor Eliminators Multiple Scents



Odor Eliminators provide a versatile and effective solution for tough odors. They can be used to either completely fumigate an entire room or be kept on hand for the occasional freshen-up of a space.

- **Fine atomized micro mist** — encapsulates odors and chemically neutralizes them leaving a long-lasting, fresh, citrus or vanilla scent.
- **Dry Spray with No Fallout** — is safe on surfaces and fabrics without wetting or staining. No clean-up required.
- **Non-Chlorinated and VOC compliant** for safer use.
- **Unique Total Release Nozzle** can be used to set off like a "bomb" in a room or vehicle for deep reaching and effective mist to completely destroy odors in up to 6,000 cubic feet of space.
- **Dual-Function Nozzle** can also be pressed lightly for regular use emitting small amounts of odor eliminator to instantly "Freshen Up" any space.
- **Eliminates** tobacco smoke, cooking odors, mold and mildew odors and any other unpleasant odors.

Applications:

Cars • Buses • RVs • Boats • Utility Vehicles
Smoking Areas • Restrooms • Nursing Homes
Locker Rooms • Motels • Restaurants • Carpets
Upholstery • Draperies • Fabrics

IBS No.	Description / Scent	Qty
74190	Fresh Scent, 6.75 oz / 191g	12
74191	Citrus Creme, 5 oz / 142g	12

IBS, INCORPORATED

Aerosols & Chemicals (S04)



D-Frost Frost & Ice Remover



Our fast-acting frost and ice remover is specifically formulated to quickly dissolve ice, frost, and snow deposits on windows, locks, sidewalks & more.

- Melts ice, frost & snow instantly.
- Fast-acting and water rinseable.
- Thaws frozen locks.
- Helps prevent freezing when applied in advance.
- Eliminates scraping and potential damage to glass.
- Works in any temperature.

Applications:

Windows • Headlights • Windshields • Locks
Tires • Sidewalks & Steps • AC Equipment
Tail Lights • Hinges

Used By:

Police & Fire Departments
Fleet Maintenance
Food Service Operations
Maintenance Crews



HMIS RATINGS		NFPA	
HEALTH	3	HEALTH	3
FLAMMABILITY	3	FLAMMABILITY	3
REACTIVITY	1	REACTIVITY	1
PERSONAL PROTECTION	B	SPECIAL	—

IBS No.	Description	Qty
74186	D-Frost Frost & Ice Remover 13 oz	12

HOT DAM! Heat Dissipating Spray & Flame Retardant



HOT DAM! is a heat sink especially designed for brazing. **HOT DAM!** Protects valves, controls and surrounding areas from heat damage. Simply spray on surrounding areas or completely encircle copper tubing to prevent heat transfer.

- Prevents heat damage to components and surrounding surfaces during soldering, welding and brazing.
- Clear gel stays where sprayed and then evaporates.
- Non-Toxic, Odorless, Will Not Harm Skin

Applications:

For use when brazing, soldering or welding pipe to isolate heat. Can be used as a flame retardant on metal, wood, sheetrock, insulation and more.

HMIS RATINGS		NFPA	
HEALTH	1	HEALTH	1
FLAMMABILITY	0	FLAMMABILITY	0
REACTIVITY	0	REACTIVITY	0
PERSONAL PROTECTION	B	SPECIAL	—

IBS No.	Description	Qty
74187	Hot Dam! Heat Dissipating Spray 16 oz	12

M
I
S
C
E
L
L
A
N
E
O
U
S



IBS, INCORPORATED

Aerosols & Chemicals (S04)

M
I
S
C
E
L
L
A
N
E
O
U
S

Power Stripper



A fast-acting heavy-duty gel-spray that removes gaskets, paint, decals, dried oils, varnish, shellac and similar coatings from any metal, wood, tile, brick or concrete surface.

- Not for use on painted surfaces.
- Removes paint and varnish.
- Thick gel clings to and penetrates surfaces.
- May be wiped off or rinsed with water.
- Pressure washing is recommended for difficult vandal marks.
-

Applications:

For use on porous surfaces such as cinder block, sandstone, marble, brick, masonry, granite, concrete, terrazzo, slate. Removes paint, oil base, latex, enamel, lacquer, shellac, varnish, and most finishes.



HMIS RATINGS

HEALTH	2
FLAMMABILITY	1
REACTIVITY	0
PERSONAL PROTECTION	B

NFPA

HEALTH	2
FLAMMABILITY	1
REACTIVITY	0
SPECIAL	—

IBS No.	Description	Qty
74113	Power Stripper 18 oz	12

"STING"

Wasp & Hornet Killer



- **Long Range Spray** — Features a unique propellant and aerosol valve system that delivers a super powerful 20 foot fogging stream, letting you keep a comfortable distance away.
- **Low Shock Hazard** — Safe for use in environments where electricity is present.
- **Unique Formula** — 100% solvent-based formulation provides superior penetration and kill. Treats entire nests - ends reinfestation.
- **This product can be used both indoors** in attics and other places where nests are built) **and outdoors** for effective elimination of wasp and hornets nests.

DIRECTIONS FOR USE:

It is a violation of federal law to use this product in a manner inconsistent with its labeling. For control of wasps and hornets, it is preferable to apply this product in the evening after all the insects have returned to the nest. Aim valve opening at the nest and depress button, continuing to spray until the nest is soaked with the spray. Repeat as necessary.

HMIS RATINGS

HEALTH	2
FLAMMABILITY	2
REACTIVITY	0
PERSONAL PROTECTION	B

IBS No.	Description	Qty
74177	"Sting" Wasp & Hornet Killer 14 oz	12

IBS, INCORPORATED

Miscellaneous Tools T03



Drive Grip Anti Cam-Out Fluid



Works with all types of screws:
Phillips™, Slotted, Hex, Square, Torx®



Drive Grip makes removing or tightening screws and other fasteners a breeze. A single drop of Drive Grip creates a positive grip between the metal surfaces of the fastener head and assembly tool. Works great in applications where fastener heads or drives are worn or damaged.

Drive Grip increases the strength between the fastener head and tool by as much as 700% and virtually eliminates tool wear, rounding and deforming of fasteners.

APPLICATIONS:

- Drive Grip helps you remove rusted or "frozen-in-place" screws and bolts that won't budge.
- Use Drive Grip in conjunction with all types of screwdrivers, hex keys, pliers, channel locks, vise grips, sockets as well as open end and box-end wrenches.

FEATURES:

- **Economical:** Eliminates the time and expense involved with drilling out screws, using "easy-outs," or possibly having to re-tap holes. In addition, Drive Grip works with standard screwdrivers.
- **Simplifies Operation:** Reduces the need for specially designed screwdrivers, reamers or drilling out damaged screws.
- **Prevents Injury:** Helps reduce fatigue and extreme effort that could lead to injury.
- **Protects Surrounding Surfaces:** Prevents slippage of driver.
- **Environmentally Friendly:** Odorless, non-toxic, non-corrosive, wipes clean without staining and won't irritate skin.
- **Unlimited Shelf Life:** Will not evaporate or lose potency under normal storage Conditions.

IBS No.	Description	Qty
52010	Drive Grip Anti Cam-Out Fluid .5 oz	1

Can-Gun Aerosol Trigger Attachment



- **Minimizes user fatigue** associated with using aerosol nozzles.
- **Consistent pressure** means less clogging and even application.
- **Made of durable plastic** for long life.
- **Easy to attach, easy to remove**, fits most aerosol cans.
- **Balances can for easy, fatigue free application** — great for big jobs.
- **Handle eliminates finger on nozzle** and means less skin irritation and mess due to chemical over-spray.

IBS No.	Description	Qty
74200	Can Gun Aerosol Trigger Attachment	1

M
I
S
C
E
L
L
A
N
E
O
U
S



IBS, INCORPORATED

Aerosols & Chemicals (S04)

VROOM Starting Fluid



M
I
S
C
E
L
L
A
N
E
O
U
S

VROOM Starting Fluid is specifically designed to aid gasoline and diesel engines with quick and easy starting power in cold, wet or freezing weather.

Prevents excessive battery drain and functions after use as a corrosion inhibitor and upper cylinder lubricant.

- **Provides a quick, easy start up** in all weather conditions.
- **Contains upper cylinder lubricants** and anti-corrosive additives for a longer engine life.
- **For use on all internal combustion, gasoline and diesel engines.**
- **Reduces battery drain.**

FOR USE ON THE FOLLOWING ENGINES:

Automobiles, Trucks, Lawn Mowers, Boats, Chainsaws, Tractors, and other internal combustion engines.

FOR USE BY:

Automobile dealerships, auto repair shops, truck stops, equipment and auto rental outlets, marines, lawn mower services and company fleet divisions.

NOTE: DO NOT USE THIS PRODUCT ON GLOW PLUGS.

VROOM Starting Fluid

IBS No.	Description	Qty
74184	Vroom Starting Fluid 16 fl. oz.	12



Penetrants

A

Aerosols

Penetrants

4 Way Plus SP-2

BUSTER Rust Penetrant SP-2

Cryo Buster Freezing Penetrant SP-3

P
E
N
E
T
R
A
N
T
S



IBS, INCORPORATED

Aerosols & Chemicals S04

4 Way Plus Moisture Displacer



4 Way Plus is a fast and effective moisture displacer. It is a lubricant that dries wet ignition and electrical systems, penetrates and loosens frozen nuts and bolts, prevents rust on metal surfaces and makes assembly and disassembly of machinery easier.

Directions For Use: Shake well before using. Spray liberal amount on area to be treated. Reapply as needed. The button is designed for two different types of spraying. Press straight down for atomized (mist) spray. Tilt forward for pinpoint application (stream).

- **Displaces Moisture** - Moisture is pushed aside and floats off surface for quick evaporation.
- **Dries Wet Ignitions** - For fast starting of wet engines. Dries electrical systems, generators, alternators and starters.
- **Provides Moisture Barrier** - Excellent for all electrical equipment.
- **Frees Rusted Parts** - Keeps them free with rust protection.
- **Stops Squeaks** - Provides permanent protection against metal-to-metal wear.
- **Non-Flammable** - Safe to use.
- **Meets Gov't Specifications** - MIL-C-16173D, MIL-C-23411A, and VV-L-800A
- **Special Propellant** - Extends usage to cold weather temperatures.
- Temperature Range: -10°F to 200°F
- **Dielectric Strength = 30,000 Volts**
- **Saves Time, Money, Labor, Mess**

**NOTE: NOT AVAILABLE FOR SALE
IN THE STATE OF CALIFORNIA**

IBS No.	Description	Qty
74107	4-Way PLUS 15 oz	12

BUSTER Rust Penetrant



Buster is an outstanding penetrant that loosens the toughest rust and corrosion to free frozen parts. The penetrants in Buster creep between mating parts for faster, safer, loosening and the foaming action minimizes run off to keep more product working longer.

- **Outstanding penetrant** that loosens the toughest rust.
- **Contains a blend of oily lubricants formulated to assist in the separation** of mated or threaded parts.
- **Penetrants creep between mating parts** for faster, safer loosening.
- **Foaming action minimizes run off** and keeps more product working on the rusted part.

DIRECTIONS

Spray BUSTER Rust Penetrant on all corroded, rusted or frozen parts. Let stand for several minutes to allow for thorough penetration. In extreme cases a second application may be necessary.

Case Quantity - 12 Cans

IBS No.	Description	Qty
74174	Buster Rust Penetrant 15-3/4 oz	12

P
E
N
E
T
R
A
N
T
S



Cryo-Buster Freezing Penetrant



Cryo-Buster Freezing Penetrant features a new technology that immediately freezes and shrinks seized and corroded nuts, bolts, pins, hinges and studs, allowing the lubricant to penetrate and loosen the toughest applications.

The shock-freezing effect from a stream of lubricant at -43°C will instantly cool parts and cause microscopic cracks in the layer of rust allowing the lubricating ingredients to wick directly into the rust by capillary action

Spraying a liberal amount on the area allows CryoBuster to reach deeper in the toughest of applications and work more successfully than other penetrants. Will also shield against renewed corrosion.

Shock Freezing releases seized parts.

- **360° Spray Valve** for hard to reach areas.
- **Released parts remain lubricated** and protected from corrosion.
- **Non-Chlorinated and LOW VOC.**

IDEAL FOR USE in oil rigs, factories, automotive repair centers, manufacturing plants, machine shops and anywhere corrosion is a big problem.

IBS No.	Description	Qty
74176	Cryo-Buster Rust Penetrant 9 oz.	12

Freeze & Release Fast Acting Corrosion Release



LOCTITE Freeze & Release uses freezing technology to release rusted, corroded and seized components. It instantly chills parts down to -38°F to fracture rust, causing cracks in the layer of rust, allowing the lubricants to penetrate and wick directly into the rusted and seized areas.

- **Special mineral oil formulation frees** rusted, corroded and seized parts.
- The **shock freezing effect** from a stream of lubricant at -43°C will **instantly cool parts** and cause microscopic cracks in the layer of rust, **allowing the lubricating ingredients to wick directly into the rust** by capillary action.
- **Released parts remain lubricated** and protected from corrosion.
- **Highly resistant to micro-organisms**, bacteria and fungi.

IBS No.	Description	Qty
74193	Loctite Freeze & Release 13.52 fl. oz.	12

P
E
N
E
T
R
A
N
T
S



IBS, INCORPORATED

Aerosols & Chemicals S04

**P
E
N
E
T
R
A
N
T
S**



Safety Products

B

Bloodborne Pathogen Kit S-SAFETY18

Body Mats

IBS Body Mats & Knee Pads S-SAFETY30
IBS Extreme Standing Mat
S-SAFETY30

E

Ear Plugs

Fitting Instructions S-SAFETY28
PuraFit Ear Plug Dispenser S-SAFETY29
Purafit Ear Plugs
Corded S-SAFETY28, S-SAFETY29
without Cord S-SAFETY28, S-SAFETY29

Eye Wash Stations & Refills

Double Eye Wash Station S-SAFETY18
Eyewash Flushing Solution 16 oz. S-SAFETY18
Plastic Eye Cups - 6 per box S-SAFETY18

F

Face Shield

Ratchet Head Gear for Face Shield S-SAFETY11

First Aid

2 pr Exam Quality Gloves S-SAFETY17
Accessories
First Aid Station Signs S-SAFETY18
Alcohol Gel Sanitizer S-SAFETY16
Antiseptic Cleansing Wipes S-SAFETY16
Aspirin Tablets S-SAFETY17, S-SAFETY18
Band Aids, Plastic S-SAFETY15
Burn Cream S-SAFETY16
Certi-Cold Plus S-SAFETY16
Certi-Decon Tablets S-SAFETY16
Certi-Rip Elastic Cohesive Bandage S-SAFETY15
Conforming Gauze Roll
2" x 6 yd S-SAFETY15
4" x 6 yd S-SAFETY15
Cotton Swabs (100 pkg) S-SAFETY18
Dynarex CPR Shield - 7" x 7" S-SAFETY17
Elastic Bandage, 2" x 5 yd. S-SAFETY15
Eye Cups, Plastic S-SAFETY18
Eye Wash
4 oz. S-SAFETY16
16 oz. S-SAFETY18
Fabric Bandage
1 x 3 Fabric Bandage S-SAFETY15
Finger Tip S-SAFETY15
Knuckle S-SAFETY15
First Aid Burn Cream S-SAFETY16
First Aid Tape
1/2" x 2-1/2 yd S-SAFETY17

1/2" x 10 yd S-SAFETY17
Gauze Compress S-SAFETY16
Gauze Pads, 2" x 2" S-SAFETY16
Ibuprofen Tablets S-SAFETY17
Insect Sting Relief Pads S-SAFETY16
Instant Cold Compress 5" x 7" S-SAFETY17
Plastic Tweezers S-SAFETY17
Refill Components Chart S-SAFETY15
Scissors Nickel Plated S-SAFETY17
Sterile Eye Pads S-SAFETY16
Tourniquet, Forceps & Scissors S-SAFETY17
Tourniquet - Windlass S-SAFETY18
Triangular Sling S-SAFETY15
Triple Antibiotic Ointment S-SAFETY16
Water Jel Burn Dressing S-SAFETY17
Wound Seal Packs S-SAFETY17

First Aid Kits

Class "A" First Aid Kits S-SAFETY12
Class "B" First Aid Kit S-SAFETY14

G

Gloves

Chemical Resistant
Neoprene Big Job Gloves S-SAFETY21
Nitrile Big Job Gloves S-SAFETY21
PVC Big Job Double Dipped Gloves S-SAFETY22
Wonder Grip Liquid Proof Gloves S-SAFETY22
Cold Weather
Winter Lined Armor Skin Mechanics Work Gloves S-SAFETY26
Winter-Lined Mechanics Work Gloves
with Deerskin Palm & Knit Back S-SAFETY26
Cut-Resistant
Cut-Resistant 2 Nitrile Palm Gloves S-SAFETY27
Cut-Resistant 4 Nitrile Palm Gloves S-SAFETY27
Drivers
Premium Leather Driver Gloves — Lined S-SAFETY25
Premium Leather Driver Gloves - Unlined S-SAFETY25
Mechanics
Double Palm Mechanics Work Gloves S-SAFETY27
Heavy Duty Performance Work Gloves
with TPR Protection S-SAFETY26
Mechanics Work Gloves with Deerskin Palm & Knit
Back S-SAFETY26
Nitrile Disposable
Orange Nitrile Textured Heavy Duty Gloves S-SAFETY21
Semperforce Black Nitrile Gloves S-SAFETY21
Palm Dipped
Durable Knit/Rubber Coated Premium Work Gloves S-SAFETY24
Extreme Dexterity Breathable Nitrile Foam Gloves S-SAFETY23
Insulated Latex Coated
Work Gloves S-SAFETY24
Nitrile Palm with COOLMAX S-SAFETY24



IBS, INCORPORATED

Index

S
A
F
E
T
Y

P
R
O
D
U
C
T
S

- Nitrile Tough GT Gloves S-SAFETY24
- Wonder Grip Extra-Grip Hi-Vis, Latex Palm Gloves S-SAFETY23
- Wonder Grip Extra-Tough Hi-Vis Nitrile Palm Gloves S-SAFETY23
- WonderGrip Rock & Stone Double Latex Gloves S-SAFETY24
- WonderGrip U-Feel Nitrile Gloves S-SAFETY25

K

Knee Pads

- IBS Knee Pads S-SAFETY30

R

Respirators

- Disposable 3-Layer Face Masks S-SAFETY20
- Disposable Dust Masks S-SAFETY20
- Peak Fit
 - Unvented S-SAFETY20
 - Vented S-SAFETY20
- Reusable Respirator S-SAFETY19
- Reusable Respirator Low Profile S-SAFETY19
- TruAir
 - Vented & Unvented S-SAFETY20
 - TruAir Ultra S-SAFETY20

S

Safety Glasses Accessories

- Lens Cleaning Station S-SAFETY11
- Ratchet Head Gear for Face Shield S-SAFETY11

Safety Glasses & Goggles

- ANTI-FOG+ Orange Crush Safety Glasses S-SAFETY3
- ANTI-FOG+ Raider Safety Glasses S-SAFETY3
- ANTI-FOG+ Vader Shield Faceshield Combo S-SAFETY11
- Apocalypse Camo S-SAFETY4

Crews

- Bi-Focal Magnifiers S-SAFETY9
- CHECKMATE® Series Safety Glasses S-SAFETY6, S-SAFETY7
- Ratchet Head Gear for Face Shield S-SAFETY11
- STORM® Series Safety Glasses S-SAFETY7
- TACOMA Series S-SAFETY10

Crossfire

- CONCEPT Series S-SAFETY5
- Convertible Safety Glasses / Goggles S-SAFETY5
- Core Series Woodland Camo /HD Brown Lenses S-SAFETY5
- Over the Glasses Safety Glasses / Goggles S-SAFETY10
- Sniper Safety Glasses S-SAFETY4
- Dual Guard Safety Goggles S-SAFETY11
- Ellipse Series Safety Glasses S-SAFETY8
- FLIGHT Safety Glasses S-SAFETY6
- Freedom Safety Glasses S-SAFETY6
- Helmsman® Series Safety Glasses S-SAFETY9

- LED Safety Glasses
 - Standard Clear Lens S-SAFETY10
- Luminary Series S-SAFETY8, S-SAFETY9
- Prowler Safety Glasses S-SAFETY28
- Silverton Safety Glasses S-SAFETY4
- Visitors Glasses S-SAFETY10

W

Welders Gloves

- Leather Welders Gloves S-SAFETY25

Safety Glasses & Accessories

ANTI-FOG+ Raider Safety Glasses

MEETS OR EXCEEDS ANSI Z87+ Standard Fit



The two-piece clear polycarbonate lens design, with an 8 base curve to minimize distortion, offers impact resistance and blocks 99.9% of the sun's ultraviolet rays. A soft molded thermoplastic rubber (TPR) nosepiece won't slip and slide. The glossy black semi-rim design is executed in polycarbonate and rubber, with co-extruded temples in red and black. TempleTouch™ technology means raised rubber nibs are molded into the interior temple tip to provide a gentle yet secure grip on the sides of head. Tunnel vents added to the temple near the lens stimulate airflow.

The polycarbonate lens features **ANTI-FOG+** coating that offers superior performance under the highest heat and humidity for a long-lasting, fog-free view.

Features

- Ultra lightweight, weighing less than one ounce.
- Dynamic black-and-red design
- Integrated side protection
- TempleTouch™ technology for comfortable, head-hugging fit
- Molded TPR nosepiece
- ANSI-rated hardcoated polycarbonate lenses
- ANTI-FOG+ protection exceeds European EN 166/168 — lasts 45 times longer!



IBS No.	Description	Qty	Case
143010	ANTI-FOG+ Raider Safety Glasses	1	12

ANTI-FOG+ Orange Crush Safety Glasses

MEETS OR EXCEEDS ANSI Z87+ Standard Fit



The stylish wraparound styling of the one-piece 10 base curve lens offers high-impact protection and an unobstructed field of vision — for an almost unprecedented optic range. The thermoplastic rubber (TPR) temples provide hypoallergenic, non-slip comfort and super-flex fit without distorting vision. The polycarbonate lens features **ANTI-FOG+** coating that offers superior performance under the highest heat and humidity for a long-lasting, fog-free view. A secure fit is as simple as turning the PivotEase™ nosepiece to a narrow position and then sliding the eyewear on. It adjusts automatically and then “locks” into the perfect, no-slip positioning. The removable foam dust filter forms a seal with the brow, channeling dust, sweat and even splash away from the wearer's eyes.

Features

- Soft, adjustable, fully customizable PivotEase™ nosepiece
- Bendable, super-flex TPR temple in bright orange for visibility and style
- TempleTouch™ technology provides comfortable grip on sides of the head
- Integrated side protection
- Removable, contoured rubber gasket acts as a cradle, helps keep liquids and dust out
- ANSI-approved hardcoated polycarbonate lenses
- ANTI-FOG+ anti-fog protection exceeds European EN 166/168 — lasts 45 times longer

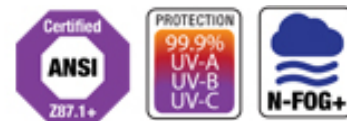

IBS No.	Description	Qty	Case
139695	ANTI-FOG+ Orange Crush / Clear Lens	1	12
139696	ANTI-FOG+ Orange Crush / Smoke Lens	1	12



IBS, INCORPORATED

Safety Products (S07)

Safety Glasses & Accessories



Sniper Safety Glasses by Crossfire

EXCEEDS ANSI Z87+

Designed for tactical vision, these glasses serve as a stylish option for anyone seeking long lasting eye protection.

- TR-90 ultraflex, ultralight frame technology.
- Meets and exceeds ANSI Z87+ high-impact specifications.
- Lenses provide 99.9% protection from harmful UVA/UVB rays.
- Comfort fit rubber nosepiece.
- Soft, non-slip rubber temple ends.



	IBS No.	Description	Qty	Case
 General Purpose	127650	Sniper Black Frame / Clear Lens	1	12
 Reflects Bright Light	127651	Sniper Black Frame / Mirror Lens	1	12
 Reduces Bright Light	127652	Sniper Camo Frame / Smoke Lens	1	12

Apocalypse Camo Safety Glasses

Meets ANSI Z87.1+ Standards

- Sleek, sporty, lightweight style.
- **Soft rubber temples with flared ends.**
- Coated **protective lenses.**
- Protective lenses provide 99.9% **UVA/UVB Standards.**
- Safety glasses **meet ANSI Z87.1+ standards.**
- **Neck cord** included.



IBS No.	Description	Qty	Case	
143021	Apocalypse Camo Clear Anti-Fog	1	12	 General Purpose
143022	Apocalypse Camo Smoke Anti-Fog	1	12	 Reduces Bright Light
143023	Apocalypse Camo Amber Anti-Fog	1	12	 Contrast in Low Light
143024	Apocalypse Camo Bronze Anti-Fog	1	12	 Reduces Bright Light

Silverton Safety Glasses

MEETS ANSI Z87.1+ & CSA Z94.3 STANDARDS





MEETS BALLISTIC IMPACT RESISTANCE REQUIREMENTS

FOR EYEWEAR IN US MILITARY PERFORMANCE SPECIFICATION

MIL PRF-32432 (GL)

With sleek industrial design qualities, these glasses deliver an amazing fit in a foam-lined protected safety glass. **SILVERTON** eyewear is designed for use in the dustiest environments.

- **Foam lining design fits tighter than a regular safety glass, but more comfortable and breathable than goggles** — perfect for dusty and dirty environments.
- **Special OptiFit foam lining** features a tapered design for a better seal, keeping out more dust and dirt particles for added safety.
- **Venting channels** along the foam allows for better airflow, which minimizes fogging and allows users to wear longer, and provides safety to the workforce.
- **FX2 Anti-Fog** is a concentrated water based anti-fog formula applied to lenses on both sides for superior anti-fog performance that lasts longer, allowing users to wear glasses in variable temperature conditions without fogging for a safer work environment.

	IBS No.	Description	Qty	Case
	143050	Gray Temple Clear Lens	1	10
	143051	Gray Temple Clear FX2 Anti-Fog Lens	1	10
	143052	Gray Temple Gray FX2 Anti-Fog Lens	1	10
	143053	Gray Temple Clear In/Out Mirror FX2 Anti-Fog Lens	1	10



S
A
F
E
T
Y

P
R
O
D
U
C
T
S



Safety Glasses & Accessories

Convertible Safety Glasses / Goggles

EXCEEDS ANSI Z87.1-2003 High Impact Standards

The Crossfire Journey Foam-Lined Convertible Safety Glasses/Goggles protect against airborne particles and can be worn as safety glasses or goggles.

- Temples are designed to gently curve with the natural curve of the head, resulting in a snug and comfortable fit.
- Frames are designed at an 8 to 10 base curve resulting in maximum side coverage and superior peripheral vision.
- Lens cavities designed for superior peripheral sight and maximum eye protection.
- Frames and temples made of highly durable, ultra-lightweight, flexible and impact-resistant material.
- 99% protection from harmful UVA and UVB rays.
- 2.2 mm Panlite polycarbonate lens material.



IBS No.	Description	Qty	Case
139690	Conv Safety Glasses/Goggle Black with Elastic Strap	1	12
139691	Conv Safety Glasses/Goggle Black / Smoke Lens with Elastic Strap	1	12
139694	Elastic Strap (included with glasses, but may be purchased separately)	1	12



Concept Series Safety Glasses

MEETS ANSI Z87.1-2003

High Impact Standards

- Meets ANSI Z87.1-2003 High Impact Standards
- Lenses block 99.9% UVA and UVB rays
- Fire retardant Ethylene Vinyl Acetate (EVA) closed cell foam (removable)
- Ultralight frame design

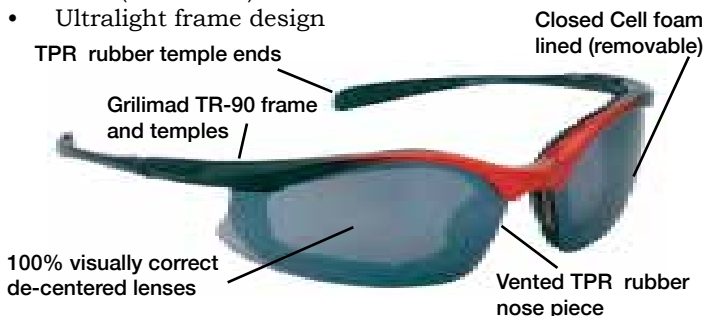

IBS No.	Description	Qty	Case
139685	Clear Anti-Fog Black Frame	1	12
139686	Smoke Anti-Fog Black Frame	1	12



Woodland Camo Safety Glasses HD Brown Lenses

Temples are designed to gently curve with the natural curve of the head, resulting in a snug and comfortable fit

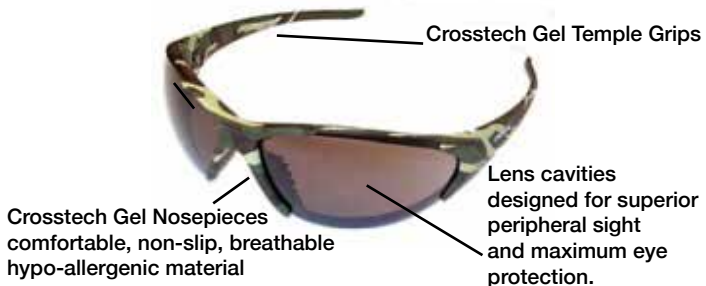

- **Meets ANSI Z87.1-2003 High Impact Standards**
- **Lenses block 99.9% UVA and UVB rays**
- **De-centered lens** cuts resulting in a 100% visually correct lens
- **2.2 mm Panlight brand polycarbonate lens** material resists impact
- **Ultralight frame** design

BEFORE HD LENS

AFTER HD LENS



IBS No.	Description	Qty	Case
143011	Core Series Woodland Camo	1	12

SAFETY PRODUCTS



IBS, INCORPORATED

Safety Products (S07)

Safety Glasses & Accessories

Freedom™ Safety Glasses MEETS OR EXCEEDS

ANSI Z87 2010

FREEDOM™ safety glasses, designed for outdoor sports provide a polished look with a light weight fit. The sleek framework provides substantial coverage for a variety of environments. Rubber nosepiece provides all day comfort.



General Purpose



Reflects Bright Light



Reduces Bright Light



Reflects Bright Light

IBS No.	Description	Qty	Case
127655	Shiny Pearl Gray Frame / Clear Lens	1	12
127656	Matte Black Frame / Clear I / O Lens	1	12
127657	Shiny Pearl Gray Frame/Smoke Lens	1	12
127658	Shiny Black Frame/Blue Mirror Lens	1	12

FLIGHT™ Safety Glasses

MEETS OR EXCEEDS ANSI Z87+, CSA Z94.3 and the Ballistics Section of the U.S. Military Standard

FLIGHT™ safety eyewear features an exclusive patent-pending temple design engineered for all-day comfort. Soft cushioned temple "wings" gently cushion the sides of the head. **FLIGHT™** offers absolute all-day comfort and a perfect fit without the pinching behind the ears that employees hate. This, in turn, helps employers increase worker compliance with personal protective requirements. In addition to its temple technology construction, **FLIGHT™** has a unique floating lens design that allows air to flow between the frame and the lens, which helps prevent fogging. **Meets and exceeds ANSI Z87+, CSA Z94.3, and the ballistics section of the U.S. Military Standard, MIL-PRF-31013, Clause 3.5.1.1.**



Cushioned temple "wings" softly hug the users head, while alleviating pinching
Floating lens design helps fight fog and provides ultramodern style
Additional features include lightweight construction and rubber nosepiece.



General Purpose



Reduces Bright Light



Contrast in Low Light



General Purpose



Reflects Bright Light



Reflects Bright Light

IBS No.	Description	Qty	Case
143015	Flight - Gray Frame / Clear Lens	1	10
143016	Flight - Black Frame / Gray Lens	1	10
143017	Flight - Gray Frame / Amber Lens	1	10
143018	Flight - Gray Frame / Clear Anti-Fog	1	10
143019	Flight - Gray Frame / Clear I/O Lens	1	10
143020	Flight - Black Frame/Silver Mirror Lens	1	10

S
A
F
E
T
Y

P
R
O
D
U
C
T
S



Safety Glasses & Accessories





CHECKMATE® Series Safety Glasses

MEETS OR EXCEEDS

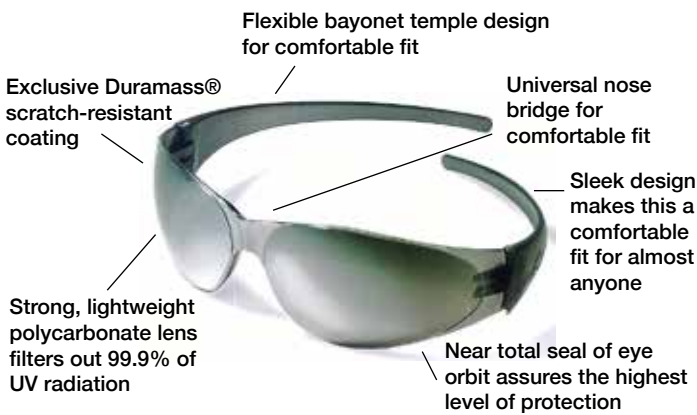
ANSI Z87.1 safety standards

The leader in trend-setting design offers the highest level of eye protection. The revolutionary, lightweight CheckMate® is engineered for near total eye orbital seal and with its flexible bayonet temple design and universal nosebridge, ensures compliance along with the most comfortable fit.



	IBS No.	Description	Qty	Case
 <i>General Purpose</i>	127606	Checkmate Clear Coated	1	12
 <i>Reflects Bright Light</i>	127609	Rainbow Mirror Coated	1	12
 <i>Reflects Bright Light</i>	127608	Silver Mirror Coated	1	12
 <i>Reflects Bright Light</i>	127610	Indoor Outdoor Clear Mirror	1	12

STORM® Series Safety Glasses

WHILE SUPPLIES LAST

MEETS OR EXCEEDS

ANSI Z87.1 Safety standards

Workers in the Storm® can expect extreme comfort with this face flattering protective eyewear. Ratchet action temples combined with non-slip rubber head grips create a customized fit for virtually any head size.

- Wraparound lens delivers advanced visual acuity & protection
- Features adjustable 5 position, ratchet action temples for maximum comfort and fit
- Exclusive Duramass® scratch resistant coating
- Strong, lightweight polycarbonate lens filters out 99.9% of UV radiation
- Meets or exceeds ANSI Z87.1 safety standards

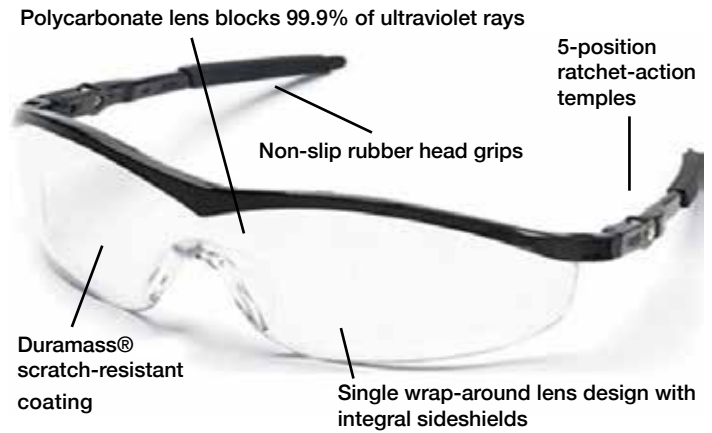

	IBS No.	Description	Qty	Case
 <i>General Purpose</i>	127614	Storm Clear	1	12
 <i>Brazing & Welding</i>	128063	Brazing Glasses Shade 3.0 Green	1	12
 <i>Brazing & Welding</i>	128064	Brazing Glasses Shade 5.0 Green	1	12

SAFETY PRODUCTS



IBS, INCORPORATED

Safety Products (S07)

Safety Glasses & Accessories

Luminary® Series Safety Glasses

**MEETS OR EXCEEDS ANSI Z87.1
Safety Standards**

- Luminary has the look, fit and feel that make it one of the lightest and brightest solutions in safety eyewear.
- **Ultra-lightweight design** - Just four-fifths of an ounce makes it easy to wear all day, every day.
- **Elastic temples help relieve pressure** behind the ears and provide superior comfort.
- **"Fingertip" nosepiece** reduces slippage so glasses stay on securely.
- **Independently certified** by Underwriters Laboratories to meet ANSI Z87.1+ and CSA Z94.3 standards. Meets ballistic impact resistance requirements for eyewear in US Military Performance Specification MIL PRF-31013.







	IBS No.	Description	Qty	Case
 <i>General Purpose</i>	143030	Black Temples, Clear Lens	1	10
 <i>Contrast in Low Light</i>	143032	Black Temples, Amber Lens	1	10
 <i>Contrast in Low Light</i>	143034	Black Temples, Orange Lens	1	10
 <i>Reflects Bright Light</i>	143036	Silver Temples, Silver Mirror Lens	1	10
 <i>General Purpose</i>	143038	Black Temples, Clear Anti-Fog Lens	1	10
 <i>Reduces Bright Light</i>	143031	Silver Temples, Gray Lens	1	10
 <i>Contrast in Low Light</i>	143033	Black Temples, Pacific Blue Lens	1	10
 <i>Reflects Bright Light</i>	143035	Black Temples, Clr In-Out Mirror Lens	1	10
 <i>Reflects Bright Light</i>	143037	Black Temples, Blue Mirror Lens	1	10

Ellipse® Series Safety Glasses MEETS OR EXCEEDS ANSI Z87.1+ & CSA Z94.3 standards

Ellipse safety glasses offer an extremely light weight design with unmatched temple comfort.

- Revolutionary, **feather-light** safety eyewear, weighing just 19.3 grams — one of the lightest safety glasses around for the most comfortable fit encouraging users to wear safety glasses for better safety compliance.
- **Longer temple tips** engineered to reach farther around the head to dissipate pressure, reducing fatigue and allows users to wear longer and stay safer in work environments.
- **Soft rubber temples** keep safety glasses in place without slipping for additional comfort and convenience.
- Independently tested and certified by Underwriters Laboratories to meet **ANSI Z87.1+ and CSA Z94.3 standards**. Meets ballistic impact requirements for eyewear in U.S. Military Performance Specification **MIL PRF-32432 (GL)**.
- **NEW fx3™ Premium Anti-Fog lens** option, a longer lasting, more superior anti-fog solution. Longer-Lasting Effectiveness: Adheres longer than water-based coatings, and stands up to multiple lens cleanings. **Greater Scratch Resistance:** Stands up to scratching **eight times better than standard anti-fog coatings**.

	IBS No.	Description	Qty	Case
	143040	Gray Temple, Clear Lens	1	10
	143042	Black Temple, Amber Lens	1	10
	143044	Gray Temple, Clear Premium Anti-Fog Lens	1	10
	143046	Gray Temple, Silver Mirror Lens	1	10
	143041	Gray Temple, Gray, Lens	1	10
	143043	Black Temple, Blue Mirror Lens	1	10
	143045	Gray Temple, Clear In-Out Mirror Lens	1	10



Safety Glasses & Accessories

Helmsman® Series Safety Glasses

**MEETS OR EXCEEDS ANSI Z87+,
CSA Z94.3 & MIL PRF-32432(GL)
Safety Standards**

The Helmsman is a new entry in Gateway Safety's line of eye protection. Helmsman intergrates high quality protection and user comfort with straight-forward styling to arrive in port 'on time' and 'on budget.'



- **Remarkably Lightweight**, weighing less than an ounce; makes it easy to wear all day, every day.
- **One-piece, wraparound polycarbonate lens** with a translucent faux frame for distinctive style.
- **All dielectric componets** for wide application use.
- **Cost-effective** safety eyewear that fits any budget.
- **Meets ANSI Z87+, CSA Z94.3 standards**, and ballistic impact resistance requirements for eyewear in US Military Performance Specification **MIL PRF-32432 (GL)**.

	IBS No.	Description	Qty	Case
 <i>General Purpose</i>	143060	Clear Temples, Clear Lens	1	10
 <i>Reduces Bright Light</i>	143061	Gray Temples, Gray Lens	1	10
 <i>Contrast in Low Light</i>	143062	Blue Temples, Blue Lens	1	10
 <i>General Purpose</i>	143063	Clear Temples, Clear Anti-Fog Lens	1	10
 <i>Reduces Bright Light</i>	143064	Gray Temples, Gray Anti-Fog Lens	1	10
 <i>General Purposer</i>	143065	Clear Temples, Clear Indoor Outdoor Mirror Lens	1	10
 <i>Reflects Bright Light</i>	143066	Gray Temples, Silver Mirror Lens	1	10
 <i>Reflects Bright Light</i>	143067	Grey Temples, Blue Mirror Lens	1	10

Bi-Focal Magnifier Safety Glasses

**by Crews, Inc.
MEETS ANSI Z87.1 Safety
Standards**

Bi-Focal Magnifier safety glasses combine the best in safety, comfort and affordability. Vision is unobstructed by the dual lens design, which by its tight fit provides maximum safety. Comfort is enhanced by the flexible temples and the non-slip rubber grips.

Non-slip rubber grips

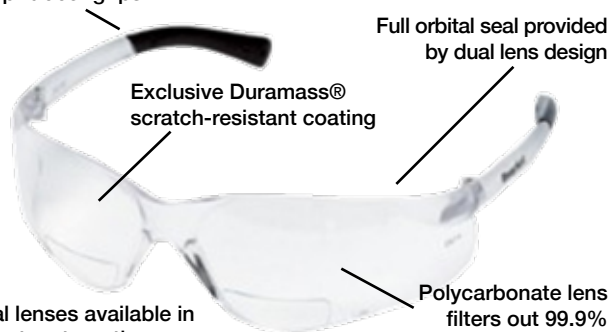

Bi-focal lenses available in two diopter strengths

	IBS No.	Description	Qty	Case
 <i>General Purpose</i>	143290	Frost Temple, Clear Lens 1.5 Diopter	1	12
 <i>General Purpose</i>	143291	Frost Temple, Clear Lens 2.0 Diopter	1	12
 <i>General Purpose</i>	143295	Frost Temple, Clear Lens 2.5 Diopter		12
	IBS No.	Description	Qty	Case
 <i>Reduces Bright Light</i>	143292	Black Temple, Gray Tinted Lens 1.5 Diopter	1	12
 <i>Reduces Bright Light</i>	143293	Black Temple, Gray Tinted Lens 2.0 Diopter	1	12

S
A
F
E
T
Y

P
R
O
D
U
C
T
S



IBS, INCORPORATED

Safety Products S07

Safety Glasses & Accessories

Over the Glasses Safety Glasses / Goggles

EXCEEDS ANSI Z87.1-2003

High Impact Standards

Safety glasses that fit over prescription glasses have always been bulky and awkward — until now! These new, smaller and sleeker Over the Glasses Safety Glasses are made to fit today's smaller prescription eyeglass styles.

- Temples are designed to gently curve with the natural curve of the head, resulting in a snug and comfortable fit.
- Frames are designed at an 8 to 10 base curve resulting in maximum side coverage and superior peripheral vision.
- Lens cavities designed for superior peripheral sight and maximum eye protection.
- Frames and temples made of highly durable, ultra-lightweight, flexible and impact-resistant material.
- 99% protection from harmful UVA and UVB rays.



General Purpose



Reduces Bright Light

IBS No.	Description	Qty	Cs
130310	OG Safety Glasses Gray/Clear S/M	1	12
130311	OG Safety Glasses Blk/Smoke S/M	1	12
130312	OG Safety Glasses Gray/Clear L/XL	1	12
130313	OG Safety Glasses Blk/Smoke L/XL	1	12

Tacoma Series Safety Glasses

"OTG" (Over the Glasses)

MEETS ANSI Z87.1 Safety Standards

Made of strong, lightweight, scratch-resistant polycarbonate, the one-piece wrap around lens delivers both a wide field of vision and maximum protection and is designed specifically to wear over prescription lenses.

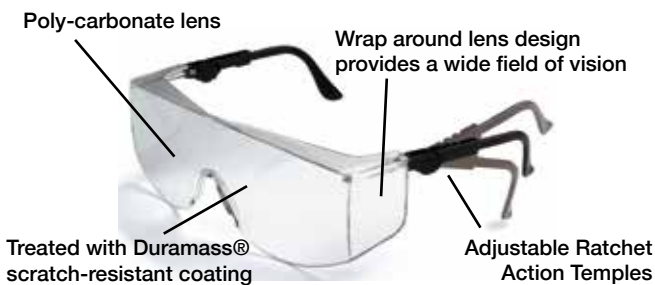

IBS No.	Description	Qty	Cs
130307	Black Temple, Clear Lens	1	12

Visitors Glasses

- High styled, wide frame with wrap around lens. Fits easily over prescription glasses.
- Detachable side shields. Provides for more comfort.
- Opaque brow bar. Provides added protection and reduces overhead glare.

IBS No.	Description	Qty	Cs
82000	Visitors Glasses	1	12



General Purpose

LED Safety Glasses Clear Lens

These safety glasses have two built-in LED lights. Each light has its own switch so they can be operated independently for optimum lighting and optimum performance.

- Ultra-bright LED Lights
- Non-Slip Nose Cushion
- Full Brow Guard
- Non-Slip Cushioned Temples
- Scratch Resistant
- High Impact Polycarbonate Lenses
- Anti-Fog Coating
- 99.9% UV Protection
- Meets ANSI Standards
- Uses LR44 Batteries (INCLUDED)



IBS No.	Description	Qty	Cs
127640	Clear Lens, Black Frame	1	6
127646	Clear Lens, Camo Green Frame	1	6
127647	Clear Lens, Camo Tan Frame	1	6



General Purpose



General Purpose



General Purpose

IBS No.	Description	Qty	Cs
127641	Diopter 1.5 Clear Lens, Black Frame	1	6
127642	Diopter 2.0 Clear Lens, Black Frame	1	6
127643	Diopter 2.5 Clear Lens, Black Frame	1	6
127644	Diopter 3.0 Clear Lens, Black Frame	1	6



General Purpose

S
A
F
E
T
Y

P
R
O
D
U
C
T
S



Safety Glasses & Accessories

Dual Guard Safety Goggles Premium Impact to Splash Goggle



- **Unique, removable vent inserts convert from impact only to impact and splash protection** for a more versatile goggle, eliminating the need to carry multiple goggles which saves money on inventory.
- **Strong, polycarbonate lens** is surrounded by a sturdy vinyl frame for extra durability.
- **Larger inside area allows these goggles to fit over many eyeglasses**, saving users hundreds of dollars on goggles with corrective lenses.
- **Adjustable headband** ensures a comfortable, yet secure fit.
- Meets **ANSI Z87.1+ and CSA Z94.3** impact standards.

IBS No.	Description	Qty
28085	DUAL GUARD Anti-Fog Safety Goggle	1

Eyeglass Cord

- Keep glasses secure and ready.
- Slip-on, Black.



IBS No.	Description	Qty
127597	Eyeglass Cord	1

Lens Cleaning Towelettes

Contains:

- 100 per box individually packaged anti-fog, anti-static lens cleaning towelettes.



IBS No.	Description	Qty
134060	Lens Cleaning Towelettes	1

ANTI-FOG Vader Shield Faceshield Combo Splash Goggle with Faceshield

- **Excellent anti-fog protection** — This mask features a proprietary anti-fog coating that **EXCEEDS** the standard with anti-fog properties last **15X** longer than normally required.
- **Military style splash goggle** is rated D3 for droplet and splash protection and offers 180° peripheral vision and face coverage.
- **Meets demanding industry test requirements** (ANSI Z87.1+, EN166K, EN166N, EN166UV). Meets or exceeds AS/NZS 1337.1:2010 for eye and face protection. Lic. # 40028.
- **99.9 percent UV protection-rated for outdoor wear and offers impact protection via goggles** designed with an ANSI-rated, polycarbonate lens with a hard coating.
- **Three-part adjustment system** provides a custom, comfortable fit for all-day use.

IBS No.	Description	Qty
28092	ANTI-FOG Vader Faceshield Combo Clear	1
28093	ANTI-FOG Vader Faceshield Combo Smoke	1



Maximum Safety Faceshield & Head Gear

- **Sleek, contemporary style offers maximum protection** from head to chin.
- **Three-part adjustment system** provides a custom, comfortable fit for all-day use.
- **Rotating ratchet adjustment** easily fits over the nape of the neck for a secure fit.
- Lightweight construction for comfort.
- **Extra soft brow pad and nape strap** delivers superior comfort.
- **Tension adjustment** ensures the visor will stay in place when raised.
- **Cylinder, Molded Polycarbonate visor** provides the best face coverage, clarity and durability for superior protection and life.
- **Blocks 99% of UV-A and UV-B with 91% VLT**
- **Complies with ANSI Z87.1-2003+**

IBS No.	Description	Qty
28095	Face Shield & Headgear Combo	1
28096	Maximum Safety Head Gear	1
28097	Clear Lens Face Shield	1
28098	IR Filter Shade 3.0 Lens Face Shield	1
28099	IR Filter Shade 5.0 Lens Face Shield	1



SAFETY PRODUCTS



IBS, INCORPORATED

Safety Products S07

Class "A" First Aid Kits

Every workplace is required to have a stocked first aid kit with necessary supplies to treat and care for workers or visitors in the event of a first aid emergency. In 2022, a revision was approved to the first aid standard ANSI Z308.1-2021 and it requires that certain first aid supplies must be included in all OSHA and ANSI approved first aid kits.

We have the perfect kits for large and small work environments, including a large metal cabinet or first aid box that can be carried, stored, or hung. Innovative and Convenient Cabinet Design eliminates disorganized and missing supplies with clearly labeled shelves that make it easy to use and restock. Both kits have easy-to-carry handles and fixed holes for wall mounting, making them perfectly portable or a fixed location.

Class "A" 3 Shelf First Aid Kit

Packaged in a Wall Mountable, Locking Steel Cabinet for Easy Storage and Organization

IBS No. 206125



- **Class A**, designed for common workplace injuries.
- **Wall mountable steel cabinet** protects contents from water, dirt, dust and contamination.
- **Labeled cabinet shelves** provide part numbers and descriptions for easy re-order and organization.
- **Cabinet dimensions:**
15" H x 10" W X 4.5" D
- **Meets the ANSI/ISEA Z308-1 - 2021 Standard**

IBS No.	CSM #	Qty	Description	Size	Pcs
134040	R519-553	1	Antiseptic Towelettes	5 x 7	25/bx
134041	R519-545	1	Antibiotic Cream	.9 g	25/bx
134042	R521-003	1	Eye Wash	15 ml	1
134023	R228-102	1	Elastic Bandage	2" x 5 yd	1
134033	R519-549	1	Dynarex CPR Shield	7" x 7"	1
134044	R220-170	1	Adhesive Strips - Plastic	1" x 3"	50/bx
134045	R220-228	1	Adhesive Bandages - Woven	Knuckle	25/bx
134046	R220-229	1	Adhesive Bandages - Woven	Fingertip-M	25/bx
134066	R211-011	1	Gauze Pads	3" x 3"	4/unit
134049	FK200-969	1	Bloodborne Pathogen - Econo	Bagged	1
134034	R513-037	1	Cold Pack	5" X 7"	1
134051	R224-204	1	Cotton Swabs	3"	100/pk
134052	R210-009	1	Adhesive Strips - XL	2" X 3"	6/unit
134053	R211-030	1	Non-Stick Pads	2" X 3"	4/unit
134054	R216-003	1	First Aid Tape	12" X 2-1/2 yd	2/unit
134055	R214-008	1	Eye Pads - 4 / Tape Strips - 4	Oval / Strips	8/unit
134031	R519-567	1	Insect Sting Wipe Ups	1" x 2"	10/unit
134022	R519-548	1	Triangular Bandage - with Pins	40"x40"x56"	3/unit
134037	R237-010	1	Scissors	4"	1
134024	R211-024	1	Gauze Roll	2" x 6 yd	2/unit
134025	R211-027	1	Gauze Roll	4" x 6 yd	1/unit
134229	R519-539	1	Burn Cream	.9 g	10/unit
134039	R522-520	1	Gloves - Nitrile	Large	2/pair
134057	R519-521	1	Hand Sanitizer	.9 g	10/unit
134067	R521-013	1	Burn Dressing	4" x 4"	1
134061	R231-400	1	Trauma Dressing - XL	4" x 60"	1
134062	R231-419	2	Trauma Pad - Compress	5" x 9"	1
134019	R286-038	1	Rescue Blanket Disposable	52" x 84"	1
134064	R234-010	1	First Aid Facts Guide	Book	1

S
A
F
E
T
Y

P
R
O
D
U
C
T
S

Class "A" First Aid Kit

Packaged in a Portable & Wall Mountable, Polypropylene Box for Easy Storage and Organization
IBS No. 133971



- **Class A kits** are designed for common workplace injuries.
- **Heavy duty poly cabinet** protects contents from water, dirt, dust and contamination.
- **Poly cabinet dimensions:**
7" H x 10" W X 3" D
- **Meets the ANSI/ISEA Z308-1 - 2021 Standard**

IBS No.	CSM #	Qty	Description	Size	Pcs
134065	R210-006	1	Plastic Strips	1" x 3"	16/unit
134022	R519-548	1	Triangular Bandage with Pins	40"x40"x56"	3/unit
134066	R211-011	1	Gauze Pads	3" x 3"	4/unit
134030	R519-543	1	Antibiotic Cream	.9 g	10/unit
134029	R519-551	1	Antiseptic Towelettes	5" x 7"	10/unit
134057	R519-521	1	Hand Sanitizer	.9 g	10/unit
134055	R214-008	1	Eye Pads with Strips	Oval / Strips	8/unit
134229	R519-539	1	Burn Cream	.9 g	10/unit
134039	R522-520	1	Gloves - Nitrile	Large	2/pair
134019	R286-038	1	Rescue Blanket Disposable	52" x 84"	1
134033	R519-549	1	Dynarex CPR Shield	7" x 7"	1
134067	R521-013	1	Water Gel Burn Dressing	4" x 4"	1
134034	R513-037	1	Cold Pack	5" x 7"	1
134042	R521-003	1	Eye Wash	15 ml	1
134068	R519-005	1	First Aid Tape	1/2"x2-1/2 yd	1
134024	R211-024	1	Gauze Roll	2" x 6 yd	1
134037	R237-010	1	Scissor /Bandage - Red Handle	4"	1
134062	R231-419	2	Trauma Pad - Compress	5" x 9"	1
134064	R234-010	1	First Aid Facts Guide	Book	1



IBS, INCORPORATED

Safety Products S07

Class "B" First Aid Kit

Packaged in a Portable & Wall Mountable, Locking Steel Box for Easy Storage and Organization
IBS No. 133979



IBS No.	CSM #	Qty	Description	Size	Pcs
134065	R210-006	1	Plastic Strips	1" x 3"	16/unit
134022	R519-548	2	Triangular Bandage with Pins	40"x40"x56"	1/unit
134066	R211-011	1	Gauze Pads	3" x 3"	4/unit
134029	R519-551	1	Antiseptic Towelettes	5" x 7"	10/unit
134057	R519-521	1	Hand Sanitizer	1g	10/unit
134068	R519-005	1	First Aid Tape	1/2 x 2-1/2 yd	2/unit
134055	R214-008	1	Eye Pads with Strips	Oval / Strips	8/unit
134037	R237-010	1	Scissors	4"	1
134039	R522-520	1	Gloves - Nitrile	Large	2 pair
134041	R519-545	1	Antibiotic Cream	.9 g	25/box
134069	R519-541	1	Burn Cream	.9 g	25/box
134033	R519-549	1	Dynarex CPR Shield	7" x 7"	1
134034	R513-037	1	Cold Pack	5" x 7"	1
134067	R521-013	1	Burn Dressing	4" x 4"	1
134032	R521-004	2	Eye Wash	4 oz.	1
134024	R211-024	2	Gauze Roll	2" x 6 yd.	1
134025	R211-027	1	Gauze Roll	4" x 6 yd.	1
134062	R231-419	2	Trauma Pad - Compress	5" x 9"	1
134070	R522-517	1	Sam Splint	36"	1
134064	R234-010	1	First Aid Facts Guide	Book	1
134019	R286-038	1	Rescue Blanket Disposable	52" x 84"	1
134017	R522-503	1	Tourniquet - Windlass	13.8" x 11.8" x 10"	1

- **Class B kits** are designed for high risk work zones.
- **Portable & wall mountable steel cabinet** protects contents from water, dirt, dust and contamination.
- **Poly cabinet dimensions:** 9" H x 14" W X 2.5" D
- **Meets the ANSI/ISEA Z308-1 - 2021 Standard**

S
A
F
E
T
Y

P
R
O
D
U
C
T
S

IBS, INCORPORATED

Safety Products S07



First Aid Kits - Refill Components

Individual refill components for our first aid kits are listed below.



- Designed with adhesive that sticks and won't hurt when removed
- Protects minor cuts and scrapes
- Sterile

IBS No.	CSM#	Description	Qty
134044	R220-170	1 x 3 Plastic Band-Aids (50 pkg)	1
134052	R210-009	2 x 3 Plastic Band-Aids (6 pkg)	1
134065	R210-006	1 x 3 Plastic Band-Aids (16 pkg)	1



- Designed with adhesive that sticks and won't hurt when removed.
- Flexible heavy duty fabric.
- Protects minor cuts and scrapes.
- Sterile.

IBS No.	CSM#	Description	Qty
134020	R220-205	1 x 3 Fabric Bandage (100 pkg)	1



- Designed with adhesive that sticks and won't hurt when removed
- Flexible heavy duty fabric that stretches and conforms to the knuckle
- Protects minor cuts and scrapes
- Sterile

IBS No.	CSM#	Description	Qty
134230	R210-020	Knuckle Fabric Bandage (8 pkg)	1
134045	R220-228	Knuckle Fabric Bandage (25 pkg)	1



- Designed with adhesive that sticks and won't hurt when removed
- Flexible heavy duty fabric that stretches and conforms to the fingertip
- Protects minor cuts and scrapes
- Sterile

IBS No.	CSM#	Description	Qty
134231	R210-015	Finger Tip Fabric Bandage (10 pkg)	1
134046	R220-229	Finger Tip Fabric Bandage (25 pkg)	1



- Triangular bandage with pins
- Use for arm sling or head dressing
- Fold in ways to fit any body part
- Non-sterile

IBS No.	CSM#	Description	Qty
134022	R519-548	Triangular Sling (3 pkg)	1



- For compression support of strains and sprains
- Secured with metal clips

IBS No.	CSM#	Description	Qty
134023	R228-102	2" x 5 yd Elastic Bandage (1 pkg)	1



- Easy to tear to the exact length desired.
- Sticks in wet or dry conditions.
- No need for clips - adheres to itself.
- For sprains and holding gauze in place.

IBS No.	CSM#	Description	Qty
134043	R228-346	Certi-Rip Elastic Cohesive Bandage	1



- Helps control bleeding
- Use when moderate compression is needed
- Sterile

IBS No.	CSM#	Description	Qty
134024	R211-024	2" x 6 yd Conforming Gauze (2 pkg)	1



- Helps control bleeding
- Use when moderate compression is needed
- Sterile

IBS No.	CSM#	Description	Qty
134025	R211-027	4" x 6 yd Conforming Gauze (1 pkg)	1



- A non-woven gauze that is more absorbent and less abrasive
- Won't stick to the wound and is extremely breathable
- No fraying or loose threads

IBS No.	CSM#	Description	Qty
134026	R231-202	2" x 2" Sterile Gauze Pads (10 pkg)	1
134053	R211-030	2" x 3" Sterile Gauze Pads (4 pkg)	1
134066	R211-011	3" x 3" Sterile Gauze Pads (4 pkg)	1
134047	R231-210	3" x 3" Sterile Gauze Pads (10 pkg)	1

SAFETY PRODUCTS



IBS, INCORPORATED

Safety Products S07

First Aid Kits - Refill Components

Individual refill components for our first aid kits are listed below.

S
A
F
E
T
Y

P
R
O
D
U
C
T
S



- Aids in the control of bleeding
- Provides a sterile cover over wounds

IBS No.	CSM#	Description	Qty
134027	R211-020	32 Sq. In. Gauze Compress (1 pkg)	1
134061	R231-400	4" X 60 " Gauze Compress (1 pkg)	1
134062	R231-419	5" X 9 " Gauze Compress (1 pkg)	1



- Oval shaped eye pads
- Helps provide protection of eye injury
- Sterile

IBS No.	CSM#	Description	Qty
134028	R231-115	Sterile Eye Pads (10 pkg)	1
134055	R214-008	Sterile Eye Pads (8 pkg)	1



- External analgesic
- Temporary relief for minor burns, cuts, scrapes
- Water soluble
- Contains aloe vera for soothing power
- Helps relieve pain, cools and helps prevent infections

IBS No.	CSM#	Description	Qty
134229	R519-539	First Aid Burn Cream (10 pkg)	1
134069	R233-375	First Aid Birn Cream (25 pkg)	1



- Perfect for quick antiseptic cleansing
- Helps prevent infection

IBS No.	CSM#	Description	Qty
134029	R519-551	Antiseptic Cleansing Wipe (10 pkg)	1
134040	R221-009	Antiseptic Cleansing Wipe (25 pkg)	1



- Topical antibiotic
- For use on small cuts and abrasions

IBS No.	CSM#	Description	Qty
134030	R519-543	Triple Antibiotic Ointment (10 pkg)	1
134041	R233-358	Triple Antibiotic Ointment (25 pkg)	1



- For temporary relief of pain and itching from stings and bites

IBS No.	CSM#	Description	Qty
134031	R213-014	Insect Sting Relief Pads (10 pkg)	1



- Use when soap and water are not available.
- Helps kill germs.

IBS No.	CSM#	Description	Qty
134057	R519-521	Alcohol Gel Sanitizer	1



- Isotonic buffered solution
- Use for safely washing skin and flushing small objects out of the eye
- Sterile

IBS No.	CSM#	Description	Qty
134042	R521-003	15 ml. Eye Wash (1 pkg)	1
134032	R521-004	4 oz. Eye Wash (1 pkg)	1



- Decongestant tablet for temporary relief of fever, headache, sinus pain and nasal congestion
- Active ingredients: Acetaminophen, Phenylephrine

IBS No.	CSM #	Description	Qty
134234	R222-010	Certi-Decon Tablets (100 pkg)	1



- Extra strength for temporary relief of cold, cough, fever and helps loosen phlegm
- Active ingredients: Acetaminophen, Dextromethorphan

IBS No.	CSM#	Description	Qty
134235	R504-072	Certi-Cold Plus (100 pkg)	1

IBS, INCORPORATED

Safety Products S07



First Aid Kits - Refill Components

Individual refill components for our first aid kits are listed below.



- Temporary relief of aches, pain, and fever

IBS No.	CSM#	Description	Qty
134035	R232-018	Aspirin Tablets (100 pkg)	1



- Temporary relief of muscular aches, pain, headaches, inflammation, and minor arthritis pains

IBS No.	CSM#	Description	Qty
134233	R504-046	Ibuprofen Tablets (50 pkg)	1



- 510(K) Registration meets the new FDA Standard
- Meets all requirements of ASTM F920-93 (American Society for Testing and Materials)
- Cross-section on bottom of stem prevents tongue blockage
- Stem length complies with new FDA standard & serves as a bite stick if needed
- Patented "Free Floating" valve allows better airflow to victim

IBS No.	CSM#	Description	Qty
134033	R519-549	Dynarex CPR Shield - 7" x 7"	1



- Gets cold instantly (3 sec) for treatment of swelling, burns, nose bleeds, headaches & other injuries requiring cold
- No refrigeration needed
- Remains cold for 15 minutes minimum.
- Disposable
- Durable, heavy plastic bags help prevent accidental breaking & leakage
- Instant action by impact, then shake gently

IBS No.	CSM#	Description	Qty
134034	R513-037	5" x 7" Instant Cold Compress (1pk)	1



- Non-woven
- Easy to tear — no scissors required
- Great adhesive

IBS No.	CSM#	Description	Qty
134036	R240-035	1/2" x 10 yd First Aid Tape (2 pkg)	1
134054	R216-003	1/2" x 2-1/2 yd First Aid Tape (2 pkg)	1
134068	R240-030	1/2" x 2-1/2 yd First Aid Tape (1 pkg)	1



- Flat blade on one side allows user to cut bandages next to skin without injury

IBS No.	CSM#	Description	Qty
134037	R237-010	4" Scissors Nickel Plated (1pkg)	1



- Corrugated Handle
- Serrated Tips

IBS No.	CSM#	Description	Qty
134038	R242-014	4" Plastic Tweezers (1 pkg)	1



- Tourniquet to be used as a last resort for the control of life threatening bleeding.

IBS No.	CSM#	Description	Qty
134056	R216-013	Tourniquet, Forceps & Scissors (3 pkg)	1



- Durable Nitrile Gloves
- Powder Free
- Textured

IBS No.	CSM #	Description	Qty
134039	R522-520	2 pr Exam Quality Gloves (2 pkg)	1



IBS No.	CSM #	Description	Qty
134063	R510-012	Wound Seal Packs 2 Pour - 3 Clamshells	1



- Stops the burning process
- Cools the burn and relieves the pain.
- Helps prevent contamination.
- Non-adherent dressing.

IBS No.	CSM #	Description	Qty
134067	R521-013	Water Jel Burn Dressing	1

SAFETY PRODUCTS



IBS, INCORPORATED

Safety Products S07

S
A
F
E
T
Y

P
R
O
D
U
C
T
S

First Aid Kits - Refill Components

Individual refill components for our first aid kits are listed below.



- Can help prevent or treat hypothermia
- Reflects up to 90% of radiated body heat
- Compact emergency protection
- Not made with natural rubber latex

IBS No.	CSM #	Description	Qty
134019	R286-038	Rescue Blanket 52" x 84"	1



- NEW ANSI Z308.1 Standard
- Slows the flow of blood down
- For emergency use on arms, legs, and other body parts
- Applies pressure to limbs
- Simple to understand and apply the tourniquet

IBS No.	CSM #	Description	Qty
134017	R522-503	Tourniquet - Windlass	1



- Tightly wound cotton heads reduce linting.
- Wooden shaft provides flexibility.

IBS No.	CSM #	Description	Qty
134051	R224-204	Cotton Swabs (100 pkg)	1

First Aid Accessories - Eye Wash Stations & Refills

Wall mountable eye wash station contains & holds (2) 16 oz. **one time use** plastic bottles of sterile, isotonic buffered eye wash flushing solution.



IBS No.	Description	Qty
133978	Double Eye Wash Station	1

16 oz. **one time use** plastic bottle of sterile, isotonic buffered eye wash flushing solution.
Refills IBS No. 133978, Double Eye Wash Station.



IBS No.	CSM#	Description	Qty
134093	R511-018	Eyewash Flushing Solution 16 oz.	1

First Aid Accessories - Eye Wash Stations & Refills



IBS No.	CSM#	Description	Qty
134232	R229-018	Plastic Eye Cups - 6 per box	1

First Aid Station Signs



IBS No.	Description	Qty
134174	First Aid Station Sign 14" x 10"	1

Bloodborne Pathogen Economy Kit ZLB - Zip Lock Bag



IBS No.	CSM#	Description	Qty
134049	FK200-969	Bloodborne Pathogen Kit	1



Safety Accessories - Miscellaneous

Reusable Respirator



replacement filters sold separately

Innovative design, a compact profile, and replaceable filters made of hypoallergenic materials protect against dust particles, metal fumes, mists, paint, solvents and organic vapors.

- **Unique kind of comfort** — the ergonomic shape of the mask provides maximum visibility and can safely be worn with goggles, helmets and hearing protection.
- **HEPA Efficiency Protection** — the use of **HESPA®** filter media (a synthetic material developed by GVS), ensures high efficiency with a minimum efficiency of 99.97% or higher at 0.3 microns particle size.
- **Low Breathing Resistance** — designed to be the smallest, lightest filters with the lowest breathing resistance to that of a similar particulate filters means less resistance to air flow, ensuring less fatigue for the user.
- **Soft and Lightweight** — one of the lightest on the market in its class, which allows the mask to create a perfect seal to the face.
- **Hypo-Allergenic Materials** — the materials that make up the mask are odorless and hypoallergenic, latex and silicone free and conform to ISO 10993-10:200.
- **Replaceable Filters** — the ability to replace filters extends the masks overall working life, providing maximum protection from vapors, dust, metal fumes, oil and water mists and micro-organisms.
- **NIOSH** approved.

IBS No.	Description	
28077	Respirator with Replacement Filters for Gas and Vapor	1
28078	Replacement Filters for Gas and Vapor Pair	1
28079	Hard Carry Case for Respirator for Gas and Vapor	1

LOW PROFILE VERSION boasts all the same features as the standard profile with additional **COMFORT** features — its ergonomic shape provides maximum visibility to wearers, can safely be worn with goggles, welding helmets, and hearing protection. Fits perfectly to the face, without hindering the user ensures the greatest possible field of vision during use.



REUSABLE RESPIRATOR - LOW PROFILE

IBS No.	Description	
28065	Low Profile Respirator with Replacement Filters for Gas and Vapor	1
28066	Low Profile Replacement Filters for Gas and Vapor Pair	1
28067	Hard Carry Case for Low Profile Respirator for Gas and Vapor	1

S
A
F
E
T
Y

P
R
O
D
U
C
T
S



IBS, INCORPORATED

Safety Products S07

Safety Accessories - Miscellaneous

TruAir Respirators

A comfortable design that is both cost effective and meets N95 respirator protection.

- Large shell helps reduce breathing resistance and minimizes user fatigue.
- Dual non-latex head straps provide a traditional yet safe and secure fit.

28072 - Unvented

28073 - Vented



IBS No.	Description	Qty
28072	TruAir Unvented N95 Particulate Respirator (20 per box)	1
28073	TruAir Vented N95 Particulate Respirator (10 per box)	1

TruAir Ultra Respirator

Provides P100 protection for more demanding applications and environments — provides the maximum protection from a disposable respirator.

- Ideal for welding applications where a disposable respirator can be used.
- 99.97% filtration against particulate aerosols below the Permissible Exposure Limit



IBS No.	Description	Qty
28074	TruAir Ultra Vented P100 Particulate Respirator (5 per box)	1

Peak Fit Respirators

The perfect fit for the best comfort and protection.

- A large, molded shell, with a distinctive tiered design, helps make breathing easier.
- Unique style that has no metal nosepiece to pinch and no metal staples that scratch.
- Integrated, one-piece cloth head strap that can be adjusted for a custom fit and seal.

28070 - Unvented

28071 - Vented



IBS No.	Description	Qty
28070	Peak Fit Unvented N95 Particulate Respirator (20 per box)	1
28071	Peak Fit Vented N95 Particulate Respirator (10 per box)	1

Disposable Dust Masks

- Adjustable metal nosepiece
- Lightweight fiber for comfort
- Low profile design
- Does not meet NIOSH



IBS No.	Description	Qty
---------	-------------	-----

Disposable 3-Layer Face Masks

- Filtration efficiency $\geq 90\%$. (For non-oily particles such as saliva, droplets, & secretions).
- 3 layers of protection filter out fine dust, germs, smoke & pollution.
- Not for medical use.



IBS No.	Description	Qty
28082	Disposable Face Masks (50 per box)	1

S
A
F
E
T
Y

P
R
O
D
U
C
T
S



Nitrile Disposable Gloves

Orange Nitrile Textured Heavy Duty Gloves

- Brighter color for easy visibility — The bright orange color stands out in work environments and enhances safety. Workers are more visible and easy to identify when gloves are required.
- These gloves feature 7 mil to 9 mil thickness, for strength, longer wear, and added protection from puncture or abrasion.
- Textured finish for additional grip — these gloves feature an aggressive diamond texture, providing better dexterity and better protection.
- Features excellent chemical resistance from common chemicals and is also powder-free for working with sticky adhesives or wet paint.
- Excellent for Industrial, Automotive, Chemical, Paint and Janitorial applications.



IBS No.	Description	Size	Qty
24035	Orange Nitrile Textured HD Gloves	M	100/bx
24036	Orange Nitrile Textured HD Gloves	L	100/bx
24037	Orange Nitrile Textured HD Gloves	XL	100/bx
24038	Orange Nitrile Textured HD Gloves	XXL	100/bx

Semperforce Black Nitrile Gloves

- Latex & powder free.
- 100% quality nitrile for superior strength and stretch to eliminate puncture and tearing.
- Textured fingertips for extra grip.
- Contains no latex proteins, and no powder that could leave a residue.
- Beaded cuff makes the gloves easy to put on and take off.
- Ambidextrous for quick & easy selection.
- Medical Grade.
- 100 gloves or 50 pairs per box.



IBS No.	Description	Size	Qty
23035	Semperforce Black Nitrile Gloves	S	100/bx
23036	Semperforce Black Nitrile Gloves	M	100/bx
23037	Semperforce Black Nitrile Gloves	L	100/bx
23038	Semperforce Black Nitrile Gloves	XL	100/bx
23039	Semperforce Black Nitrile Gloves	XXL	100/bx

Chemical Resistant Gloves

Nitrile Big Job Gloves

- Sturdy 15 mil unsupported nitrile protects against most acids, solvents, alcohols and animal fats.
- Resistant to puncture, cuts, snags, abrasion, oxidation and weathering.
- Embossed fingertips and palm for added grip.



IBS No.	Description	Size	Qty
24010	Nitrile Big Job 15 mil. x 14 in.	S	1 pr
24011	Nitrile Big Job 15 mil. x 14 in.	M	1 pr
24012	Nitrile Big Job 15 mil. x 14 in.	L	1 pr
24013	Nitrile Big Job 15 mil. x 14 in.	XL	1 pr

Neoprene Big Job Gloves

- Strong 28 mil neoprene over latex glove protects against a wide variety of organic solvents, many acids, and water soluble chemicals.
- Tough unsupported two layer coating for excellent abrasion, tear and puncture resistance.
- 14" length for extra protection
- Flocked lined to reduce sweating for a comfortable grip.
- Embossed fingertips and palm for added grip.
- Resists degradation from sunlight, ozone and oxidation.
- Effective from -10°F to 300°F.



IBS No.	Description	Size	Qty
24015	Neoprene Big Job 28 mil.x14 in.	S	1 pr
24016	Neoprene Big Job 28 mil.x14 in.	M	1 pr
24017	Neoprene Big Job 28 mil.x14 in.	L	1 pr
24018	Neoprene Big Job 28 mil.x14 in.	XL	1 pr

S
A
F
E
T
Y

P
R
O
D
U
C
T
S



IBS, INCORPORATED

Safety Products S07

Chemical Resistant Gloves

Wonder Grip® Liquid Proof Gloves

- Double-dipped latex-coated glove protects hands from wet, messy jobs.
- Textured palm for excellent grip.
- Soft, comfortable knit cuff for superior comfort and feel.
- Twice the grip of standard latex palm dipped gloves!
- Superior fit and dexterity while keeping hands safe, warm and dry.



IBS No.	Description	Size	Qty
23085	Wonder Grip® Liquid Proof	S	1 pr
23086	Wonder Grip® Liquid Proof	M	1 pr
23087	Wonder Grip® Liquid Proof	L	1 pr
23088	Wonder Grip® Liquid Proof	XL	1 pr
23089	Wonder Grip® Liquid Proof	XXL	1 pr

Wonder Grip® Thermo Plus Liquid Proof Double Coated Latex Palm Gloves

- Double-dipped latex-coated glove protects hands from wet, messy jobs.
- Looped terry insulation adds warmth - ideal for outdoor and cold weather use.
- Textured palm for excellent grip.
- Soft, comfortable knit cuff for superior comfort and feel.
- Twice the grip of standard latex palm dipped gloves!
- Superior fit and dexterity while keeping hands safe, warm and dry.



IBS No.	Description	Size	Qty
24040	Wonder Grip® Thermo Plus	S	1 pr
24041	Wonder Grip® Thermo Plus	M	1 pr
24042	Wonder Grip® Thermo Plus	L	1 pr
24043	Wonder Grip® Thermo Plus	XL	1 pr
24044	Wonder Grip® Thermo Plus	XXL	1 pr

PVC Big Job Double Dipped Gloves

- A durable double-dipped PVC coating features excellent chemical resistance with excellent wet or dry grip.
- Protects hands from messy jobs.
- Strong, yet extremely soft and flexible.
- 12" length for added protection.
- Textured palm for excellent grip.
- Remains flexible even in colder temperatures.



IBS No.	Description	Size	Qty
23095	PVC Big Job Double Dipped	S	1 pr
23096	PVC Big Job Double Dipped	M	1 pr
23097	PVC Big Job Double Dipped	L	1 pr
23098	PVC Big Job Double Dipped	XL	1 pr

S
A
F
E
T
Y

P
R
O
D
U
C
T
S



Palm Dipped Gloves

Extreme Dexterity Breathable Nitrile Foam Gloves

- Made with a **15 gauge liner** that provides an **enhanced tactile feel and comfort** which mean a user can wear these gloves longer with **less fatigue**, saving time and money.
- Has a **single dipped microfoam nitrile coating** that provides **excellent abrasion resistance** while producing an **optimum grip for precision handling**, even in oily conditions, keeping the user safer saving on accidents and downtime.
- The combination of the **thinner liner** and **single dip** process creates a glove with **incredible stretch** — Delivering precision dexterity and **flexibility** making users more productive because they can feel more through the glove better with less need to remove the glove — Saving time and money.
- The **knit wrist** helps prevent dirt from entering the glove **preventing irritation** to the user or the need to remove the glove for cleaning — saving time and money.
- The **Form, Fit and Feel** design mimics the "hand at rest" position, **reducing hand fatigue** and **increasing comfort**.
- **Durable and machine washable** with minimal shrinkage and **excellent recovery** for extended wear life with saves inventory and money.



IBS No.	Description	Size	Qty
24025	Ext Dexterity Breathable Nitrile	S	1 pr
24026	Ext Dexterity Breathable Nitrile	M	1 pr
24027	Ext Dexterity Breathable Nitrile	L	1 pr
24028	Ext Dexterity Breathable Nitrile	XL	1 pr

Wonder Grip® Extra-Tough Hi-Vis Nitrile Palm Gloves

Be Safe! Be Seen!

- Double-coated textured nitrile palm provides an excellent grip.
- Tough 13 gauge polyester knit glove is both strong and comfortable.
- Best used for carpentry, oily surfaces, tool handling, concrete and mechanical operations.



IBS No.	Description	Size	Qty
23080	Wonder Grip® XT Hi-Vis	S	1 pr
23081	Wonder Grip® XT Hi-Vis	M	1 pr
23082	Wonder Grip® XT Hi-Vis	L	1 pr
23083	Wonder Grip® XT Hi-Vis	XL	1 pr
23084	Wonder Grip® XT Hi-Vis	XXL	1 pr

Wonder Grip® Extra-Grip Hi-Vis, Latex Palm Gloves

Be Safe! Be Seen!

- **Double-coated, textured latex palm.**
- **Tough 13 gauge polyester knit construction.**
- **Ideal for general maintenance, material handling, tool handling and slick surfaces.**



IBS No.	Description	Size	Qty
23010	WonderGrip® Hi Vis Latex Palm	S	1 pr
23011	WonderGrip® Hi Vis Latex Palm	M	1 pr
23012	WonderGrip® Hi Vis Latex Palm	L	1 pr
23013	WonderGrip® Hi Vis Latex Palm	XL	1 pr
23014	WonderGrip® Hi Vis Latex Palm	XXL	1 pr

SAFETY PRODUCTS



IBS, INCORPORATED

Safety Products S07

Palm Dipped Gloves

Durable Knit/Rubber Coated Premium Work Gloves

- Premium, ergonomically shaped work glove.
- Tough, flexible, textured rubber palm.
- Seamless knit liner. Great grip, wet or dry.



IBS No.	Description	Size	Qty
23045	Durable Knit Rubber Coated	S	1 pr
23046	Durable Knit Rubber Coated	M	1 pr
23047	Durable Knit Rubber Coated	L	1 pr
23048	Durable Knit Rubber Coated	XL	1 pr

Insulated Latex Coated Work Gloves

- Napped 7 gauge polyester knit, fabric for warmth.
- Textured latex palm for excellent grip.
- Soft, comfortable knit cuff.
- Machine washable.



IBS No.	Description	Size	Qty
23090	Insulated Latex Coated Work Gl	S	1 pr
23091	Insulated Latex Coated Work Gl	M	1 pr
23092	Insulated Latex Coated Work Gl	L	1 pr
23093	Insulated Latex Coated Work Gl	XL	1 pr

Nitrile Tough GT Gloves

- Breathable micro-foam palm and fingertip coating protects hands and enhances grip.
- Lightweight Nylon and spandex knit liner ensures excellent fit and dexterity.
- Resists snags, punctures and cuts.



IBS No.	Description	Size	Qty
23040	Nitrile Tough® GT	S	1 pr
23041	Nitrile Tough® GT	M	1 pr
23042	Nitrile Tough® GT	L	1 pr
23043	Nitrile Tough® GT	XL	1 pr

Nitrile Palm with COOLMAX

- Made with PYT™ fiber — a combination of nylon, cotton and spandex fibers, spun — or plied together and knit into seamless liners that provide superior warmth, fit and comfort.
- Coated with breathable 2NFT™ - NFT™ coatings are filled with micro-capillaries that draw water and oil away from the surface, providing a better grip when handling wet and dry components.
- The ultimate glove for fit and comfort while providing a level of warmth and protection.



IBS No.	Description	Size	Qty
23005	Nitrile Palm with COOLMAX	S	1 pr
23006	Nitrile Palm with COOLMAX	M	1 pr
23007	Nitrile Palm with COOLMAX	L	1 pr
23008	Nitrile Palm with COOLMAX	XL	1 pr
23009	Nitrile Palm with COOLMAX	XXL	1 pr

WonderGrip® Rock & Stone Double Latex Gloves

Rock & Stone is a glove that provides optimum protection for heavy duty tasks, as well as cold protection and heat contact resistance.

- Specially designed **double latex coating** provides an outstanding grip.
- **Soft, comfortable knit cuff** for superior comfort and feel.
- Durable 10 gauge cotton and polyester liner protect against abrasive and sharp materials (Level B) for safety.
- Engineered specifically for the natural shape of the hand for added comfort.



IBS No.	Description	Size	Qty
23105	Rock & Stone Double Latex Glove	S	1 pr
23106	Rock & Stone Double Latex Glove	M	1 pr
23107	Rock & Stone Double Latex Glove	L	1 pr
23108	Rock & Stone Double Latex Glove	XL	1 pr
23109	Rock & Stone Double Latex Glove	XXL	1 pr

S
A
F
E
T
Y

P
R
O
D
U
C
T
S



Palm Dipped Gloves

WonderGrip® U-Feel Nitrile Gloves

U-Feel is our thinnest protective glove yet. With a high-performance nitrile coating constructed on an 18 gauge polyester and spandex liner, this glove provides optimum dexterity with superior grip and protection.



- **Performance dipped nitrile coating** offers an outstanding thin and smooth protective coating, delivering incomparable levels of sensitivity and dexterity at your fingertips
- Made with an **18 gauge liner** for a thin and soft glove that gives users a second skin feeling to provide an exceptional level of comfort and feel for precision tasks.
- **Soft, comfortable knit cuff** for superior comfort and feel.
- U-Feel nitrile gloves are **certified free of silicone** and are **heat contact level 1 certified**.
- Engineered specifically for the natural shape of the hand for added comfort.
- Cuff thread color denotes the glove size: Small=light purple, Medium=black, Large=gray, XL=yellow, XXL=beige

IBS No.	Description	Size	Qty
23100	Wonder Grip U-Feel 18G Nitrile Glove	S	1 pr
23101	Wonder Grip U-Feel 18G Nitrile Glove	M	1 pr
23102	Wonder Grip U-Feel 18G Nitrile Glove	L	1 pr
23103	Wonder Grip U-Feel 18G Nitrile Glove	XL	1 pr
23104	Wonder Grip U-Feel 18G Nitrile Glove	XXL	1 pr

Drivers Gloves

Premium Leather Driver Gloves - Unlined

- Premium grain cowhide provides superior fit, comfort and protection.
- Gunn cut, keystone improves comfort and durability.
- Soft, washable, eco-friendly leather tanning process.
- Slip on elastic wrist improves fit.



IBS No.	Description	Size	Qty
23070	Leather Driver Glove Unlined	M	1 pr
23071	Leather Driver Glove Unlined	L	1 pr
23072	Leather Driver Glove Unlined	XL	1 pr
23073	Leather Driver Glove Unlined	XXL	1 pr

Premium Leather Driver Gloves — Lined

- Premium grain cowhide provides superior fit, comfort and protection.
- Gunn cut, keystone improves comfort and durability.
- Soft, washable, eco-friendly leather tanning process.
- Slip on elastic wrist improves fit.
- Thinsulate® liner for warmth.



IBS No.	Description	Size	Qty
23075	Leather Driver Glove Lined	M	1 pr
23076	Leather Driver Glove Lined	L	1 pr
23077	Leather Driver Glove Lined	XL	1 pr

Welders Gloves

Leather Welders Gloves

- Side split leather welding gloves
- Specially treated with Heatshield to make leather fire resistant
- Sewn with Kevlar®
- Padded flame resistant sock lining in palm and back
- Welted in all stress areas



IBS No.	Description	Size	Qty
24045	Leather Driver Glove Unlined	L	1 pr
24046	Leather Driver Glove Unlined	XL	1 pr



IBS, INCORPORATED

Safety Products S07

S
A
F
E
T
Y

P
R
O
D
U
C
T
S

Mechanics Gloves

Winter-Lined Mechanics Work Gloves

with Deerskin Palm & Knit Back

- **100 gram Heatlok™ lining** for superior warmth & comfort.
- **Seamless gold deerskin palm** for maximum comfort & durability.
- **Stretch knit back with neoprene knuckle** allows for superior flexibility and movement.
- **Elastic wrist with Velcro closure** keeps the gloves on securely & comfortably.
- **Wing thumb allows for better mobility** and motion for superior grip.
- **Pre-curved finger design** to minimize hand fatigue.



IBS No.	Description	Size	Qty
24080	Winter Lined Deerskin Mech Work Gloves	M	1 pr
24081	Winter Lined Deerskin Mech Work Gloves	L	1 pr
24082	Winter Lined Deerskin Mech Work Gloves	XL	1 pr
24083	Winter Lined Mechanics Work Gloves	XL	1 pr

Mechanics Work Gloves

with Deerskin Palm & Knit Back

- **Seamless gold deerskin palm** for maximum comfort & durability.
- **Stretch knit back with neoprene knuckle** allows for superior flexibility and movement.
- **Elastic wrist with Velcro closure** keeps the gloves on securely & comfortably.
- **Wing thumb allows for better mobility and motion** for superior grip.
- **Pre-curved finger design** minimizes hand fatigue.



IBS No.	Description	Size	Qty
24050	Deerskin Mechanics Work Gloves	M	1 pr
24051	Deerskin Mechanics Work Gloves	L	1 pr
24052	Deerskin Mechanics Work Gloves	XL	1 pr
24053	Deerskin Mechanics Work Gloves	XXL	1 pr

Winter Lined Armor Skin Mechanics Work Gloves

More wear and abrasion resistant than leather and pound-for-pound the toughest synthetic glove material available, these work gloves have been developed to keep your hands comfortable & safe, and provide the perfect combination of abrasion resistance with fit & feel.

- **Armor Skin™ synthetic leather construction** with PVC palm patch.
- **Knit back with full finger and back of hand TPR impact protection.**
- **Elastic cuff** closure.
- Tests show the **back of hand protector reduced the load** at impact by 20.6%.
- Pre-curved finger design minimizes hand fatigue.



IBS No.	Description	Size	Qty
23110	Winter Lined Armor Skin Gloves	S	1 pr
23111	Winter Lined Armor Skin Gloves	M	1 pr
23112	Winter Lined Armor Skin Gloves	L	1 pr
23113	Winter Lined Armor Skin Gloves	XL	1 pr
23114	Winter Lined Armor Skin Gloves	XXL	1 pr

Heavy Duty Performance Work Gloves

with TPR Protection

- **Armor Skin™ synthetic leather construction** with PVC palm patch.
- **Knit back with full finger and back of hand TPR impact protection.**
- **Elastic cuff** closure.
- **Back of hand protector** reduces load at impact by 20.6%.
- **Pre-curved finger design** minimizes hand fatigue.



IBS No.	Description	Size	Qty
23051	HD Performance Work Gloves	M	1 pr
23052	HD Performance Work Gloves	L	1 pr
23053	HD Performance Work Gloves	XL	1 pr
23054	HD Performance Work Gloves	XXL	1 pr



Mechanics Gloves

Double Palm Mechanics Work Gloves

More wear and abrasion resistant than leather and pound-for-pound **the toughest synthetic glove material available**, these work gloves have been developed to keep your hands comfortable & safe, and provide the perfect combination of abrasion resistance with fit & feel.

- **Armor Skin™ synthetic leather** palm.
- **PVC reinforced** double padded palm.
- **PVC reinforced** fingertips.
- Black **stretch knit back**.
- **Neoprene knuckle**.
- **Elastic wrist**.
- **Velcro closure**.
- Available sizes: **S-XXL**



IBS No.	Description	Size	Qty
24061	Mechanics Glove - Double Palm	S	1 pr
24062	Mechanics Glove - Double Palm	M	1 pr
24063	Mechanics Glove - Double Palm	L	1 pr
24064	Mechanics Glove - Double Palm	XL	1 pr
24065	Mechanics Glove - Double Palm	XXL	1 pr

Cut-Resistant Gloves

Cut-Resistant 4 Nitrile Palm Gloves

- **ANSI-4 13-gauge high performance cut-resistant polyethylene fiber**.
- **Advanced Flex-Nitrile microfoam palm coat** provides durability, dexterity and outstanding grip.
- **Color-coded wrist** identifies cut value.
- Cuff thread color denotes the glove size: Medium=green, Large=beige, XL=light blue, XXL=black



IBS No.	Description	Size	Qty
24020	Cut-Resistant 4 Nitrile Glove	M	1 pr
24021	Cut-Resistant 4 Nitrile Glove	L	1 pr
24022	Cut-Resistant 4 Nitrile Glove	XL	1 pr
24023	Cut-Resistant 4 Nitrile Glove	XXL	1 pr

Cut-Resistant 2 Nitrile Palm Gloves

- **18-gauge ANSI 2 nylon/glass fiber/HDPE/spandex knit liner** for abrasion and cut protection.
- **Oil and waterproof double-dipped nitrile coating** adds protection and unbeatable wet/oily grip.
- **Ultralight liner** for excellent dexterity and comfort.



IBS No.	Description	Size	Qty
24030	Cut-Resistant 2 Nitrile Palm	S	1 pr
24031	Cut-Resistant 2 Nitrile Palm	M	1 pr
24032	Cut-Resistant 2 Nitrile Palm	L	1 pr
24033	Cut-Resistant 2 Nitrile Palm	XL	1 pr

S
A
F
E
T
Y

P
R
O
D
U
C
T
S



IBS, INCORPORATED

Safety Products S07

Banded Hearing Protection / Ear Plugs NRR 23 db Noise Reduction Rating

Banded Hearing Protection Earplugs offer quick on and off hearing protection. Lightweight dielectric design fitted with super soft Jelli Plugs. Jelli Plugs are washable and reusable. Earplug Angle is engineered to align with the ear canal for maximum sound attenuation and comfort.



Features & Specifications:

- **High density construction** is lightweight and very durable for maximum comfort and life.
- **Super soft Jelli Plugs** are made of FDA approved materials for added safety.
- Provides a **comfortable, low-pressure fit** for easy on and off.
- **Non-toxic, washable** and **reusable** — Saves money over disposable earplugs.
- **NRR 23 db** (Noise Reduction Rating). Most disposable earplugs typically receive NRR ratings in the low to mid twenties. The highest NRR Rating for earplugs is 33, and the highest available NRR rating for earmuffs is 31).

IBS No.	Description	Qty
23257	Banded Hearing Protectors	10
23258	Replacement Ear Plugs - PAIR	1



Purafit Ear Plugs

- **Noise Reduction Rating: 33**
- **Highest** independently tested **NRR**.
- **Tapered** for easier insertion.
- **Improved, softer foam** for maximum comfort.
- **Hygienically packaged** in biodegradable paper pouches.
- **Non-irritating**, smooth surface.
- **Longer length** for easy fitting and removal.
- **Brightly colored** for easy compliance checks.
- Available both corded and uncorded.

ORDER QUANTITY IS ONE BOX

IBS No.	Description	Qty
23250	Purafit Ear Plugs w/o cord (200 prs)	1
23255	Purafit Ear Plugs w/cord (100 prs)	1

Foam Plugs Fitting Instructions



1

ROLL & COMPRESS
With clean hands, hold earplug between thumb and forefinger as shown.

Roll and progressively compress the entire tapered end of the earplug to a small, wrinkle-free cylinder.



2

INSERT
To insure fitting, reach hand over head and gently pull ear upward and outward as shown. Insert compressed, tapered end of earplug well inside ear canal. Hold 30-60 seconds until earplug expands.

Release, then push in again for 5 seconds to insure fit.



3

CORRECT FIT
When properly inserted, the bottom edge of earplug is located at the opening of the ear canal.



4

INCORRECT FIT
A portion of the earplug not in the ear canal will reduce effectiveness.

S
A
F
E
T
Y
P
R
O
D
U
C
T
S

PuraFit Ear Plug Dispenser - 500 pieces



Keep An Earful Within Easy Reach

Put earplugs in all the places they're needed. Ear Plug Dispensers increase compliance, because they're clearly visible. No wasted time looking for earplugs.

From Dispenser to Your Hand

With the dispenser, earplugs drop right into the palm of your hand. No worries about earplugs falling to the floor, or trays collecting dust and contaminants because the chute is positioned right in the front of the turn handle.

Sealed & Disposable for Hygiene

When plugs are used up just pitch the used dirt dispenser into the recycle bin. Replace with a fresh, clean dispenser.

Purafit Ear Plugs

- **Noise Reduction Rating:** 33
- **Highest** independently tested **NRR**.
- **Tapered** for easier insertion.
- Improved, **softer foam** for maximum comfort.
- **Non-irritating**, smooth surface.
- **Longer length** for easy fitting and removal.
- **Brightly colored** for easy compliance checks.



Dispenser

- Give workers **easy access** to hearing protection.
- **High visibility** to increase awareness for your hearing conservation program.
- Clicking mechanism for **easy use** and dispensing.
- Chute delivers plugs right into the palm of your hand.
- Eliminates the mess of individual paper/ polybag packaging.
- Each dispenser is sealed & Completely **recyclable**.

Independently Tested Protection

Another benefit of the Ear Plug Dispenser is that the Pura-Fit (NRR 33) earplugs have been independently tested in accordance with ANSI S3.19-1974

IBS No.	Description	Qty
23253	Purafit Ear Plugs Dispenser (500 pcs)	1



IBS, INCORPORATED

Safety Products S07

S
A
F
E
T
Y

P
R
O
D
U
C
T
S

IBS Body Mats & Knee Pads



IBS Body Mats and Knee Pads & Pocket Knee Pads are made of heavy resilient, closed cell foam rubber, not hard plastic. Sized right for your shop, pocket or tool box, these mats will not compression set or absorb liquids. They are impervious to petroleum products and are self-extinguishing. Great for severe kneeling conditions on cold hard steel, concrete and gravel surfaces.

- Reduces knee trauma and low backs tress.
- 1" thick foam rubber construction.
- Silicone free
- Built-in handle, easy to carry and store.

IBS No.	Description	Qty
201608	IBS Pocket Knee Mat 6" x 4" x 1"	6
201610	IBS Carry Knee Pad Mat 8" x 16" x 1"	1
201606	IBS Knee Pad Mat 14" x 21" x 1"	1
201607	IBS Body Mat 41" x 17" x 1"	1

IBS Extreme Standing Mat



Just like the quality of our knee pads, the IBS Extreme Standing Mat is no ordinary mat — it's the ultimate shock absorber for extreme standing and kneeling.

- Keeps body in a gentle motion to improve circulation and joint lubrication.
- Eliminates high frequency vibrations.
- Designed for extreme standing at fixed work stations.
- Yellow safety caution bars alert to the 1" height to avoid tripping.
- Promotes a safer workplace environment.
- Made of heavy, resilient, closed-cell foam rubber, not plastic.
- Thick, 1" foam will not compression set.
- Impervious to petroleum products and will not absorb liquids.
- Self-extinguishing.
- Silicone-free.

IBS No.	Description	Qty
201609	IBS Extreme Standing Mat 36" x 18" x 1"	1



Sphag Sorb

B

Bags

Loose Fill

1 C.F. 3

2 C.F. 3

2 C.F., Enhanced with Microorganisms 3

3/4 C.F. 3

P

Pads & Pillows

Pad 4

Pillow 4

Pails & Drums

Loose Fill

3/4 C.F. 5 Gallon Pail with Lid & Handle 3

S

Socks

2" x 5' 4

4" x 4' 4

4" x 8' 4

Spill Kits

Drums

14 Gallon Drum Spill Kit 5

55 Gallon Drum Spill Kit 5

Totes

10 Gallon Tote Spill Kit 5

15 Gallon Tote Spill Kit 5



IBS, INCORPORATED

General Information

Sphag-Sorb®

The Solution to Industry's Toughest Cleanup Problems



The finest grade of sphagnum peat moss from the bogs of Canada is the starting point for Sphag-Sorb. The peat fibers are separated from inorganic hard material, then activated into a high-grade product with remarkable abilities to **absorb and encapsulate oils, solvents, heavy metals, pesticides, herbicides and all other organic chemicals.**

The key to Sphag-Sorb's effectiveness is the **natural capillary and porous structure** of the activated peat. This provides a **powerful wicking action, absorbing hydrocarbons, PCB's and solvents quickly.** But even more important, these properties allow it to **encapsulate these liquids on contact.** Sphag-Sorb securely takes in the oil, chemical, or solvent, rather than merely allowing it to temporarily "attach" to the surface of the product, as does clay.

Sphag-Sorb is **superabsorbent: Less is required for storage and disposal.** Since it is **oleophilic (absorbs oil quickly)** and **hydrophobic (resists taking on water),**

Sphag Sorb is ideal for a wide range of industrial and specialized uses. **It can absorb on land, on hard surfaces such as asphalt or concrete** and in drums or tanks. On the water it even removes the oil sheen. Sphag-Sorb removes contaminants from spill sites upon extraction because of its **non-leaching** and **encapsulating** characteristics.

CLEAN UP IS EASY

No "high-tech" application or equipment is required for a successful cleanup: a **broom or shovel** does the job. Sphag-Sorb **leaves behind no messy residue** after extraction, offering easy application to both mechanical and manual cleanup. These properties make Sphag Sorb ideal as a first response tool for emergency containment and cleanup as well as routine use in maintaining a clean and safe working environment for manufacturing plants, warehouses and fabrication or repair shops.

SPHAG-SORB IS VERSATILE

One product can absorb a wide range of organic chemicals, not just oil

This list includes some of the common hydrocarbons and industrial chemicals effectively absorbed by Sphag-Sorb:

Acetone	Chloroform	Ethylene Glycol	Methyl Phenol	Tetrachloroethane
Acetone Cyanohydrin	Chloromethane	Gasoline	Motor Oils	Tetrachloroethylene
Acetonitrile	Chlorobenzene	Heptane	Naphthalene	Toluene
Acrolein	Corn Oil	Hexachlorobenzene	2 Nitroaniline	Trichloroethylene
Allyl Chloride	Cresol	Hexachlorobutadiene	Nitrobenzene	Trichlorophenol
Amyl Acetate	Cutting Oils	Hexachloroethane	Oil Base Paint	Triethylamine
Benzene	Cyclohexane	Hexene (97%)	Oil Base Ink	Varsol
Bromodichloromethane	Dichlorobenzene	Isobutanol	Paraffin Oil	Vinyl Acetate
Bromoform	1, 2 Dichloroethene	Isoprene	Pentane	Vinyl Chloride
Bunker C Fuel Oil	1-1 Dichloroethylene	Isopropanol	Pentachlorophenol	Xylenes
2-Butanone	Dichloromothane	Jet Fuels	Petroleum Ether	
Butyl Acetate	Diesel Fuels	Kerosene	Phenol	Most organic solvents
Butyric Acid	2-4 Dinotoluene	Methanol	Propanol (48% Acetone)	Most acids & bases
Canola Oil	Ethanol	Methylene Chloride	Pyridine	
Carbon Disulfide	Ethyl Benzene	Methyl Ethyl Ketone	Silicone Oil (100 cs)	
Carbon Tetrachloride	Ethyl Ether	Methyl Methacrylate	Styrene	



Sphag Sorb - Bags

Sphag Sorb Loose Fill 3/4 C.F.

Description: 3/4 cubic foot loose-filled bag

Absorption: from 3 to 5 gallons

Shipping size:

7 bags per case

24" x 20" x 30"

Approx. weight: 55 lbs. per case (6 lbs per bag)

Palletizing: 15 cases / 105 bags



IBS No.	Description
SS-3/4	Sphag Sorb Loose Fill 3/4 C.F.

Sphag Sorb Loose Fill 1 C.F.

Description: One cubic foot loose-filled bag

Absorption: from 5 to 7 gallons

Shipping size:

six per case

24" x 15" x 30"

Approx. weight: 55 lbs. per case

(8.5 lbs per bag)

Palletizing: 15 cases / 90 bags



IBS No.	Description
SS-1	Sphag Sorb Loose Fill 1 C.F.

Sphag Sorb Loose Fill 2 C.F.

Description: Two cubic foot loose-filled bag

Absorption: from 8 to 14 gallons

Shipping size: 25" x 16" x 9"

Approx. weight: 17 lbs. per bag

Palletizing: 30 bags



IBS No.	Description
SS-2	Sphag Sorb Loose Fill 2 C.F.

Sphag Sorb Loose Fill 2 C.F.

Enhanced with Natural Occurring Microorganisms to Promote Hydrocarbon Digestion*

Description: Two cubic foot loose-filled bag

Absorption: from 12 to 15 gallons

Shipping size: 25" x 16" x 9"

Approx. weight: 17 lbs. per bag

Palletizing: 30 bags

** These microorganisms are certified non-toxic, non-pathogenic and non-hazardous*



IBS No.	Description
SS-2ME	Sphag Sorb Loose Fill 2 C.F. - Enhanced

Sphag Sorb Loose Fill 3/4 C.F. 5 Gallon Spill Kit WITH REUSABLE LID & HANDLE

Description: 3/4 c.f. loose-fill in a 5 gallon plastic pail with lid & handle

Absorption: from 4 to 5 gallons

Shipping size: 12" x 10" x 16"

Approx. weight: 8 lbs. per pail

Palletizing: 96 pails per pallet



IBS No.	Description
SS-5EZ	Sphag Sorb Loose Fill 3/4 C.F.

S
P
H
A
G
S
O
R
B



IBS, INCORPORATED

Industrial Absorbent Products S01

Pads & Pillows

Sphag Sorb Absorbent Pad

Description: 18" x 18" natural, unbleached knit-cotton pads filled with Sphag Sorb

Absorption: from 3/4 to 1-1/4 gallons

Shipping size:

15 pads per bundle

18" x 18" x 14"

Approx. weight: 22.5 lbs. per bundle

Palletizing: 28 bundles / 420 pads



IBS No.	Description
SS-PAD	Sphag Sorb Absorbent Pad

Sphag Sorb Absorbent Pillow

Description: 18" x 18" natural, unbleached knit-cotton pads filled with Sphag Sorb

Absorption: from 1 to 1-1/2 gallons

Shipping size:

10 pads per bundle

18" x 18" x 14"

Approx. weight: 17.5 lbs. per bundle

Palletizing: 28 bundles / 280 pillow



IBS No.	Description
SS-PILLOW	Sphag Sorb Absorbent Pillow

Socks

Sphag Sorb Sock - 2" x 5'

Description: natural, unbleached knit-cotton, 2" x 5' sock filled with Sphag Sorb, sealed in a plastic sleeve

Absorption: from 3/4 to 1 gallon

Shipping size:

20 socks per bundle

18" x 18" x 14"

Approx. weight: 20 lbs. per bundle

Palletizing: 28 bundles / 560 socks per pallet



IBS No.	Description
SS-60-2	Sphag Sorb 2" x 5' Sock

Sphag Sorb Sock - 4" x 4'

IBS No. SS-48

Description: natural, unbleached knit-cotton 4" x 4' sock filled with Sphag Sorb, sealed in a plastic sleeve

Absorption: from 1 to 1-1/2 gallons

Shipping size:

20 per case

20.5" x 24.5" x 30.5"

Approx. weight: 45 lbs. per case

Palletizing: 12 cases / 240 socks per pallet



IBS No.	Description
SS-48	Sphag Sorb 4" x 4' Sock

Sphag Sorb Sock - 4" x 8'

Description: natural, unbleached knit-cotton, 4" x 8' sock filled with Sphag Sorb, sealed in a plastic sleeve

Absorption: from 2 to 3 gallon

Shipping size:

10 per case

20.5" x 24.5" x 30.5"

Approx. weight: 45 lbs. per case

Palletizing: 12 cases / 120 socks per pallet



IBS No.	Description
SS-96	Sphag Sorb 4" x 8' Sock

S
P
H
A
G
S
O
R
B



Spill Kits

Sphag Sorb 10 Gallon Tote Spill Kit

Description: water-resistant nylon tote bag containing a spill response kit which includes:

- 2 - Pads
- 2 - 2" x 5' socks
- 1 - 8 quart loose-filled bag
- 1 - Waste Disposal Bag
- 1 - Dust Mask
- 1 pr - Nitrile Gloves
- 1 - 500 ml Plug It



Absorption: from 4 to 6 gallons
Shipping size: 14" x 27" x 6"
Approx. weight: 10 lbs. per kit
Palletizing: 75 per pallet

IBS No.	Description
SS-ST10	Sphag Sorb 10 Gal Tote Spill Kit

Sphag Sorb 15 Gallon Tote Spill Kit

Description: water-resistant nylon tote bag containing a spill response kit which includes:

- 4 -Pads
- 2 - 2" x 5' socks
- 1 - 3/4 cu. ft loose-filled bag
- 1 - Waste Disposal Bag
- 1 - Dust Mask
- 1 pr - Nitrile Gloves
- 1 - 500 ml Plug It



Absorption: from 8 to 12 gallons
Shipping size: 24" x 12" x 10"
Approx. weight: 15 lbs. per kit
Palletizing: 45 per pallet

IBS No.	Description
SS-ST15	Sphag Sorb 15 Gal Tote Spill Kit

Sphag Sorb 14 Gallon Drum Spill Kit

Description: 14 gallon UN/DOT-approved drum containing a spill response kit which includes:

- 2 - 2" x 5' socks
- 2 - 2" x 10' socks
- 2 - 3/4 cu ft loose-filled bags
- 1 - Waste Disposal Bag
- 1 - Dust Mask
- 1 pr - Nitrile Gloves
- 1 - 500 ml Plug It



Absorption: from 12 to 18 gallons
Shipping size: 26" x 16"
Approx. weight: 28 lbs. per kit
Palletizing: 27 per pallet

IBS No.	Description
SS-14SRK	Sphag Sorb 14 Gal Drum Spill Kit

Sphag Sorb 55 Gallon Spill Kit

Description: 55 gallon UN/DOT-approved drum containing a spill response kit which includes:

- 1 x 55 Gallon UN/DOT Approved Drum
- 3 - 3/4 cu. ft. Loose Fill Bag
- 10 - 18" x 18" Pad
- 5 - 18" X 18" Pillow
- 2 - 4" x 4' Socks
- 2 - 4" x 8' Socks
- 3 - Tyvek suits
- 3 pairs- nitrile gloves
- 3 pairs safety goggles
- 2 Waste Disposal Bags



Absorption: from 30 to 45 gallons
Shipping size: 37" x 24"
Approx. weight: 80 lbs. per kit
Palletizing: 8 per pallet

IBS No.	Description
SS-55SRK	Sphag Sorb 55 Gallon Spill Kit

S
P
H
A
G

S
O
R
B



**S
P
H
A
G

S
O
R
B**



Spill Response

D

DAM IT ALL SPILL- 4

H

HAZ-MATS SPILL- 4

I

Industrial Absorbents

DAM IT ALL SPILL- 4

HAZ-MATS SPILL- 4

Polypropylene Pads

Absorbent Drum Top Pad SPILL- 3

Gray - Universal SPILL- 3

White - Oil Only SPILL- 3

Polypropylene Roll

Gray SPILL- 3

White SPILL- 3

Sphag-Sorb® SPILL- 2

P

Polypropylene Pads

Absorbent Drum Top Pad

Gray - Universal SPILL- 3

White - Oil Only SPILL- 3

Gray Pads - Universal SPILL- 3

White Pads - Oil Only SPILL- 3

Polypropylene Rolls

Gray - Universal SPILL- 3

White - Oil Only SPILL- 3

S

Sphag-Sorb® SPILL- 2

S
P
I
L
L
R
E
S
P
O
N
S
E



IBS, INCORPORATED

Industrial Absorbents / Material Marking S01

Sphag-Sorb®

ORGANIC, ENVIRONMENTALLY SAFE, INDUSTRIAL ABSORBENT

IBS No. SS-2 2 CUBIC FT. BAG

SPHAG-SORB IS THE SOLUTION TO INDUSTRY'S TOUGHEST CLEANUP PROBLEMS



The finest grade of sphagnum peat moss from the bogs of Canada is the starting point for Sphag-Sorb. The peat fibers are separated from inorganic hard material, then activated into a high-grade product with remarkable abilities to **absorb and encapsulate oils, solvents, heavy metals, pesticides, herbicides and all other organic chemicals.**

The key to Sphag-Sorb's effectiveness is the **natural capillary and porous structure** of the activated peat. This provides a **powerful wicking action, absorbing hydrocarbons, PCB's and solvents quickly.** But even more important, these properties allow it to **encapsulate these liquids on contact.** Sphag-Sorb securely takes in the oil, chemical, or solvent, rather than merely allowing it to temporarily "attach" to the surface of the product, as does clay.

Sphag-Sorb is **superabsorbent: Less is required for storage and disposal.**

Since it is *oleophilic* (**absorbs oil quickly**) and *hydrophobic* (**resists taking on water**), Sphag Sorb is ideal for a wide range of industrial and specialized uses. **It can absorb on land, on hard surfaces such as asphalt or concrete** and in drums or tanks. On the water it even removes the oil sheen. Sphag-Sorb removes contaminants from spill sites upon extraction because of its **nonleaching and encapsulating** characteristics.

Clean Up is Easy

No "high-tech" application or equipment is required for a successful cleanup: a **broom or shovel** does the job. Sphag-Sorb **leaves behind no messy residue** after extraction, offering easy application to both mechanical and manual cleanup. These properties make Sphag Sorb ideal as a first response tool for emergency containment and cleanup as well as routine use in maintaining a clean and safe working environment for manufacturing plants, warehouses and fabrication or repair shops.

Sphag-Sorb Is Versatile

One product can absorb a wide range of organic chemicals, not just oil

This list includes some of the common hydrocarbons and industrial chemicals effectively absorbed by Sphag-Sorb:

Acetone	Chloroform	Ethylene Glycol	Methyl Phenol	Tetrachloroethane
Acetone Cyanohydrin	Chloromethane	Gasoline	Motor Oils	Tetrachloroethylene
Acetonitrile	Chlorobenzene	Heptane	Naphthalene	Toluene
Acrolein	Corn Oil	Hexachlorobenzene	2 Nitroaniline	Trichloroethylene
Allyl Chloride	Cresol	Hexachlorobutadiene	Nitrobenzene	Trichlorophenol
Amyl Acetate	Cutting Oils	Hexachloroethane	Oil Base Paint	Triethylamine
Benzene	Cyclohexane	Hexene (97%)	Oil Base Ink	Varsol
Bromodichloromethane	Dichlorobenzene	Isobutanol	Paraffin Oil	Vinyl Acetate
Bromoform	1, 2 Dichloroethene	Isoprene	Pentane	Vinyl Chloride
Bunker C Fuel Oil	1-1 Dichloroethylene	Isopropanol	Pentachlorophenol	
2-Butanone	Dichloromethane	Jet Fuels	Petroleum Ether	Xylenes
Butyl Acetate	Diesel Fuels	Kerosene	Phenol	Most organic solvents
Butyric Acid	2-4 Dinotroluene	Methanol	Propanol (48% Acetone)	
Canola Oil	Ethanol	Methylene Chloride	Pyridine	Most acids & bases
Carbon Disulfide	Ethyl Benzene	Methyl Ethyl Ketone	Silicone Oil (100 cs)	
Carbon Tetrachloride	Ethyl Ether	Methyl Methacrylate	Styrene	

SPILL RESPONSE



Polypropylene Pads & Rolls

These high loft meltblown sorbents are ultrasonically bonded between two layers of lint-free spunbond fabric creating maximum strength and are ideal for heavy spill situations.

- Laminated for maximum strength.
- Pure meltblown polypropylene fibers for cost effective absorption technology.
- Durable, medium-weight rolls and pads absorb petroleum-based liquids, but never water.
- Ideal for clean up of oily spills or drips.
- Great for tough spill situations.

White - Oil Only



WHITE POLYPROPYLENE PADS & ROLLS

IBS No.	Description	Qty
91719	White Polypropylene PADS 15"X17" - 100 pads per case/pack Absorbency = 19 Gallons / Case	1
91718	White Polypropylene ROLL 30"X150' Absorbency = 39 Gallons / Roll	1

Gray - Universal



GRAY POLYPROPYLENE PADS & ROLLS

IBS No.	Description	Qty
91714	Gray Polypropylene PADS 15"X17" - 100 pads per case/pack. Absorbency = 19 Gallons / Case	1
91713	Gray Polypropylene ROLL 30"X150' Absorbency = 39 Gallons / Roll	1

SPILL RESPONSE

Polypropylene Absorbent Drum Top Pad

White-Oil Only | Gray-Universal



Universal drum top sorbent pads eliminate messy drips and spills when mixing or pumping liquids. Drum top pads are easy to place on top of drums with pre-cut holes to fit evenly.

- Universal drum top pads soak up oil, coolants, solvents and water, even acids and bases.
- Soaks up pump drips that could later become puddles.
- 2 Pre-Cut holes to fit evenly on 55 gallon drums.
- Wringable and incinerable.

IBS No.	Description	Qty
91717	White Polypropylene Drum Pad 22"	25
91712	Gray Polypropylene Drum Pad 22"	25

Adjustable Absorbent Roll Dispenser



Free-standing steel frame easily adjusts and locks into position to dispense a wide variety of polypropylene and other absorbent rolls.

- Adjustable width from 16" to 33"
- Locks open for hassle-free moving
- Tilted design enhances stability when dispensing
- Durable painted steel resists rust and corrosion

IBS No.	Description	Qty
91720	Adjustable Absorbent Roll Dispenser	1



S
P
I
L
L
R
E
S
P
O
N
S
E

DAM IT ALL A Plug & Dike Product



Dam It All is a non-toxic, nonflammable blend of high absorption polymers in a blended bentonite base that forms an immediate seal. It has been used for over 15 years by fire departments, transportation companies, and industrial operations.

- Seal off fuels, solvents, & many other chemicals
- Seals immediately
- Sticks to dirty crumpled surfaces even with the fluid flowing out.

IBS No.	Description	Qty
98104	Dam It All	1

HAZ-MATS 24" x 16"



HAZ-MATS will seal even if the surface is dirty and rough. Just lay it over drains, storm sewer inlets, or in front of curb culverts to seal off and prevent the spill from entering. **Available as a non-stock item only.**

IBS No.	Description	Qty
98124	HAZ-MATS 24" X 16"	1



VINCULUM

THE CONNECTING MEDIUM

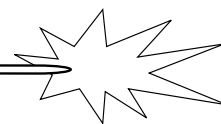

Welding Products

A

Assortments

- Drill Bits
 - IBS Type 187 Spotweld SW-30
- Solder Combos SW-3
- Welding Rod
 - Hi-Alloy SW-10
 - Vinculum Welding Electrode Assortment SW-26

B

Butane Products

- Refill (75mL) SW-28
- Torch
 - Excalibur Butane Solder Torch Kit SW-26, SW-27

D

Drill Bits

- Assortments
 - IBS Type 187 Spotweld SW-30
 - IBS Type 187 Spotweld SW-30

H

Heat Shield Compound

- "Dam-It" SW-4

M

MIG Wire

- Alum-Alloy 4043 SW-23
- Diverse-Alloy SW-22, SW-23
- Dual Shield, Flux Core SW-25
- Flux Core Gasless SW-22
- Mid-Alloy SW-21
- MRO Stainless SW-24

S

Safety Accessories

- STORM® Series Brazing Safety Glasses SW-30

Solder

- 60/40 Rosin Core Solder SW-2
- Assortments
 - Solder Combo Assortments SW-28
- NOKORODE® Regular Paste Flux SW-2
- Silvabrite 100% Solder SW-2
- Silver Bearing Solder SW-2

T

Tools

- Solder & Welding
 - Industrial Butane Torch SW-28
 - Microtorch Butane Torch SW-28
- Welding Products & Accessories
 - Butane Refill (75mL) SW-28
 - Excalibur Butane Solder Torch Kit SW-26, SW-27

Torches

- Industrial Butane Torch SW-28
- Microtorch Butane Torch SW-28

W

Welding Pencils

- Markal Silver-Streak Pencils SW-29

Welding Rod

- All Position Stainless SW-20
- Alum-Alloy SW-13
- Braze-Alloy SW-14
- Comparison Chart
 - Competitive Product SW-7
- Diverse-alloy SW-9
- Groovy SW-17
- Hi-Abrasion SW-18
- Hi-Alloy SW-11
- Mid-Alloy SW-8
- MIG Wire
 - Alum-Alloy 4043 SW-23
 - Diverse-Alloy SW-22, SW-23
 - Dual Shield, Flux Core SW-25
 - Flux Core Gasless SW-22
 - Mid-Alloy SW-21
 - MRO Stainless SW-24
- MRO Cast SW-19
- MRO Stainless SW-16
- "Quicksilver" Brazing Alloy SW-15
- Stainless SW-16
- Ultralloy SW-12



IBS, INCORPORATED

Vinculum S05

W
E
L
D
I
N
G

P
R
O
D
U
C
T
S

Silver Bearing Solder

Low Temperature

The highest strength, lowest melting point silver solder alloy for stainless steel, dissimilar metals and chrome plating.

- 500% stronger than common solders.
- Superior corrosion resistance with bright, shiny deposits.



IBS No.	Description	Qty
46001	1 oz. syringe	1
46000	9 ft. x 1/16 coil, acid core 96.5% tin - 3.5% silver	1

Silvabrite 100® Solder

Lead Free

Silvabrite 100® was developed to meet market demands for a safe and easy-to-use solder for drinking water systems and other applications. Silvabrite 100® is a lead-free and antimony free, non-toxic solder which contains the same metals used in dental fillings.

Features/Benefits:

- Lead-free composition — safe for use in drinking water systems.
- Low melting point — excellent penetration, flow and wetting out action means fast application and less waste.
- Wide melting range — 440°F to 500°F for maximum control.
- Excellent "capping off" ability.
- Tin, copper and silver composition — provides higher shear, creep and tensile strength than 50/50 for strong corrosion resistant leak-tight joints.



IBS No.	Description	Qty
460013	1/8 X 1# spool	1

60/40 Rosin Core Solder

Most Popular Solder for Electrical Applications

- Rosin flux is completely non-corrosive and non-conductive.
- Quick acting rosin flux dissolves surface oxides for good wetting and strong connections.
- Meets Fed. Spec. QQ-S-571
- 60% Tin / 40% Lead.
- Melting Temp: 370°F
- Made in the USA



IBS No.	Description	Qty
46044	.031 x 1# Spool	1
46045	.062 x 1# Spool	1
46046	.093 x 1# Spool	1

NOKORODE®

Regular Paste Flux

Will not freeze or decompose. No odor. Lead free. Recommended for use on all solder alloys including 95/5 and all lead-free solders. Meets specification O-F-506, Type 1A and A-A-51145, MIL-F04995-2.



IBS No.	Description	Qty
460014	1.7 oz. jar	1



SOLDER COMBOS



One of our bestselling assortments just got better! Solder Combos available in any combination - 2 of our Low Temperature Silver Bearing Solder in coil, paste, or one of each and includes the new **MICROTORCH BUTANE TORCH!**

MICROTORCH BUTANE TORCH
IBS No. 125738 (T03)
Retail Value \$39.95

At only 5-1/4" high with a 2500°F flame, the **MICROTORCH** is ideal for all types of professional use. Refillable with premium grade Butane Refill (**IBS No. 95007 - T03**)

Low Temperature Silver Bearing Soft Solder - the highest strength, lowest melting point silver solder alloy for stainless steel, dissimilar metals and chrome plating, available in coil, or syringe paste.

- 500% stronger than common solders
- Superior corrosion resistance with bright, shiny deposits

IBS No.	Description
418P	1 Solder Paste Syringe 1 Coil 1 Torch 1 Butane Refill
425P	2 Solder Paste Syringes 1 Torch 1 Butane Refill
426P	2 Solder Coils 1 Torch 1 Butane Refill

TYPICAL APPLICATIONS

- Stainless Escalator Parts
- Copper Tubing
- Air Pressure Tubing
- Chrome Plating
- Gas Lines
- Hospital Equipment
- Electrical Connections
- Water Pipes
- Dissimilar Metals
- Stainless Tables, Pans, Vats & Vessels

ONLY \$69.95
a \$91.00 value!



IBS, INCORPORATED

Vinculum S05

VINCULUM

THE CONNECTING MEDIUM

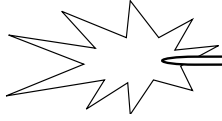

“Dam-It”

IBS No. 46060

Heat Resistant Material For Insulating and Positioning Parts for Welding

- Easy To Use
- Adheres To Most Surfaces
- Withstands Temperatures to 3000° F
- Maintains Shape When Heated
- Asbestos-free and non-toxic
- Reusable
- Helps Prevent Heat Distortion
- Can Be Reconstituted Using Water



Can't get that part to stay in place? Is heat distortion a problem? Then just say "DAM-IT!" **DAM-IT** is a product specially designed to handle these types of problems and more. **DAM-IT** easily holds or positions small and difficult to align parts for welding, brazing or soldering. It is an easy to mold compound that can be used as a heat dam and insulator to protect metal and other material from the effects of heat. The dough-like consistency of DAM-IT makes it easy to mold around intricate parts. It will adhere to most surfaces making it ideal for use as a jiggling fixture or insulator for parts to be welded and it will not distort or shrink when heated.

Applications: It can be used as a heat sink to absorb heat and avoid surface distortion on heat sensitive parts. It can also be used as a heat dam to prevent heat from traveling to areas that can be damaged by heat, such as seats, gaskets, glass and wiring. It will also prevent discoloration and will keep distortion down when welding on light gauge metals such as stainless steel. It is ideal for positioning or holding difficult to align parts.

W
E
L
D
I
N
G

P
R
O
D
U
C
T
S



VINCULUM

THE CONNECTING MEDIUM

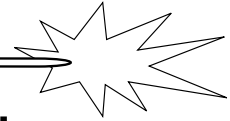

Premium Quality Arc Welding Electrodes

**Researched And Engineered To Meet
The Maintenance Welder's Total Needs**

**Precisely Formulated, Coated Electrodes
For The Welding Of Virtually All Metals**

- Cast Iron
- “Problem” Steels
- Aluminum
- Hardfacing
- Stainless Steel
- Dissimilar Metals
- Cutting Electrodes

Vinculum™ Means Connecting

**W
E
L
D
I
N
G

P
R
O
D
U
C
T
S**



IBS, INCORPORATED

Vinculum S05

VINCULUM

THE CONNECTING MEDIUM

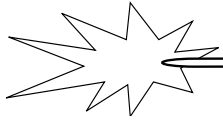

Standard "off the shelf" welding electrodes are mass produced for the limited demands of production welding!

Production welding has been greatly simplified!

1. The metals being used are clean.
2. Special jigs and fixtures are used for ease of application.
3. Production welding matches a single electrode to a metal of known analysis.
4. Day after day welding on the same job makes production welding easier.

IBS - Vinculum™ is formulated for the multiple problems of maintenance welding...Produces faster, easier, stronger, x-ray quality welds!

Maintenance welding is still extremely complex!

1. Unlike production, the maintenance welder must often weld rusty, oily, or painted metals.
2. Many welds must be made in hard to reach places with poor fit-up.
3. The exact chemistry of the metals being welded is seldom known.
4. The repair or maintenance welder must weld cast iron one day and stainless, tool, or alloy steels another day, with equal skill...Every job is different and difficult.

IBS-Vinculum™ is made only for maintenance welding!

W
E
L
D
I
N
G

P
R
O
D
U
C
T
S

IBS, INCORPORATED

Vinculum S05



IBS-Vinculum™ Welding Products Comparison Chart

The **Vinculum™** products listed below are available only through **INDUSTRIAL BOLT & SUPPLY, INC.**

Vinculum	MG Name	MG #	Karalloy	Bowman	Eutectic	Lawson	Certanium	X-Ergon	Rockmont	Mech. Choice
Mid-alloy	Gricon 33	500		885	Beautyweld	350	701	104	Tartan A	Torque II
Hi-alloy	Grinox 29	600	Super Tensile	990	680 680CGS	300	707 770	100 1000	Brutus A AA	Torque IV
Groovy	Gricon 53	570	Grooving Cutting	920	Exotrode	100	100	161	Electa	Torque Gouge-cut
Alum-alloy	Grilumin 14	400	Aluminum Alloy	980	2101 2109	450	608	141	Neptune A	Torque Aluminum
Braze-alloy	Grisil 1	130	Nickel Silver FC	914	16/185	400	70/87	201 202/271	Brutus G	
Stainless	Grinios 2	650		895	Stain B		710	121 123	Gemini A	Torque XI
Fix-a-cast	Gricast 89	289		880	2233	200	889		Jupiter A	Torque VI
Hi-abrasion	Gridur 18	770	Abrasion II	770	6006		247/250	716	Omega N	
Low Hydro	Gricon 15	540	Posi-Weld	25160	66		703/704	103	Polaris A	

S T C U D O R P I N G W E L D I N G



IBS, INCORPORATED

Vinculum S05

VINCULUM

THE CONNECTING MEDIUM

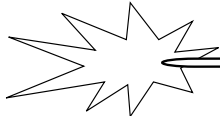

Mid-Alloy Premium General Purpose Alloy For Low Carbon Steels

AC or DC All Position

VINCULUM™ MID-ALLOY is designed to operate on all welding machines, even small AC type transformers when the open circuit voltage is very low. The specially formulated coating protects the deposit from adverse conditions normally encountered in maintenance welding. An ideal electrode for field repair work and out of position welding.

Features:

- Low amperage electrode
- Minimum spatter & Easy slag removal

Benefits:

- Controlled distortion
- Fast clean-up - Saving time

Applications

Use for fabrication of thin, medium, heavy and dissimilar gauge mild steel.

- Machine parts
- Sheets and Angle iron
- Beams
- Filling holes
- Pipes
- Build up

The outstanding restart characteristics of this electrode allow it to be used on applications requiring short, intermittent or spot welds.

Procedures:

As much foreign material as practical should be removed from the weld area. Deep penetration can be accomplished by using DC reverse polarity (electrode +). Limited penetration and a flatter bead will result from using DC straight polarity (electrode -). Arc blow can be prevented by using AC. Maintain medium arc length with either stringer or weave beads. Slag can be easily removed with a light chipping hammer.

Technical Data:

Tensile Strength.....up to 80,000 psi
 Yield Strength.....up to 68,000 psi
 Elongation %approx. 24%
 CurrentAC or DC either polarity
 ColorGold

IBS No.	Diameter	Amperage	Qty - lbs
46002	3/32	35 - 80	5, 10
46004	1/8	65 - 125	5, 10
46006	5/32	90 - 160	5,10

W
E
L
D
I
N
G
P
R
O
D
U
C
T
S



VINCULUM

THE CONNECTING MEDIUM

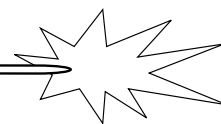

Diverse-alloy

A Premium High Strength Electrode For Welding High Strength Low Alloy Steels and Abrasion Resisting Plate AC or DC Reverse Polarity (Electrode +)

This superior quality, low-hydrogen electrode is the welder's choice for high strength, machinability and affordability. **DIVERSE-ALLOY** is excellent for welding most high-strength low alloy steels. It is recommended for the repair of heavy equipment and joints subjected to high stresses because of its high strength. The moisture resistant coating assures dense, crack-free deposits for outstanding impact resistance at all temperatures, and X-ray quality welds. This makes **DIVERSE-ALLOY** the ideal electrode for wear plate, steel fabrication and pipe welding. Engineered flux provides the flexibility of all position welding. **DIVERSE-ALLOY** deposits are easily cut with a torch and machinable for machine parts repairs.

Features

- 100,000 PSI
- All positron
- 30% elongation
- Rapid deposition
- Machinable
- Torch cuttable
- High impact resistance
- Crack-free X-ray quality deposits

Benefits

These features combine to offer reduced failure and labor costs plus maximum use of your valuable maintenance dollar.

Applications:

Use for welding High Strength Low Alloy (HSLA) steels and AR plates to themselves and in dissimilar combinations where good ductility is desired even at low temperatures. Use on any carbon or HSLA steel application where high tensile strength and ductility are desired. Excellent for steel fabrication and pipe welding.

Procedures:

Prepare weld by removing any fatigued metal. Bevel or chamfer heavy sections to a 90° vee. Short arc gap should be maintained. Use weave technique working from bottom up for vertical welding. Use stringer beads or slight weave on flat and horizontal fillets, but avoid whipping. Remove all slag between passes.

Technical Data:

Tensile Strength up to 93,000 psi
(70 kg/mm2)

Elongation % approx. 32

Current AC or DC Reverse Polarity
(Electrode +)

IBS No. by lb.	Diameter	Amperage	mm
46041	3/32	60 - 100	2.5
46042	1/8	100 - 150	3.25
46043	5/32	140 - 200	4.0

04-18-24



IBS, INCORPORATED

Vinculum S05

VINCULUM

THE CONNECTING MEDIUM



If Broken Bolts, Taps, Drills, Or E-Z Outs Are A Problem...



Then Vinculum™ Hi-Alloy Specialty Welding Rod Is The Answer!

Now Available In Three Convenient Assortments!

IBS No. 300P

3 lbs each

$\frac{5}{64}$ " • 46008

$\frac{3}{32}$ " • 46010

$\frac{1}{8}$ " • 46012

IBS No. 350P

2 lbs each

$\frac{5}{64}$ " • 46008

$\frac{3}{32}$ " • 46010

$\frac{1}{8}$ " • 46012

IBS No. 375P

1 lb each

$\frac{5}{64}$ " • 46008

$\frac{3}{32}$ " • 46010

$\frac{1}{8}$ " • 46012

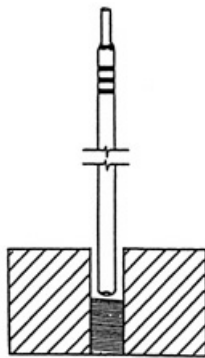

- Place the IBS Hi-Alloy rod vertically in center of hole without touching the edges. By remaining at the center, the flux will prevent the stud from fusing to the walls.
- Strike an arc & build up using short duration welds, making sure that the arc does not wander & weld the build-up to the edges. Allow the weld to cool between passes.
- Chip the slag at the center to expose the weld metal before the next step.

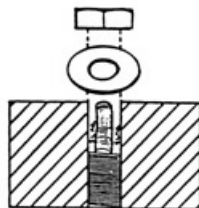

- Place a washer with an ID less than the ID over the hole itself, creating a spacer.
- Choose a nut of equal or greater size than the head of the broken bolt.

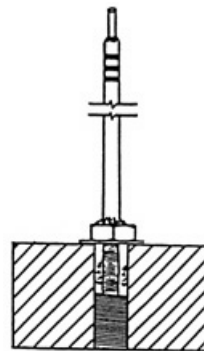

- Place the nut on the washer centered over the hole. Weld through the nut & washer so the weld pool fuses to the nut. Continue welding until the cavity of the nut is filled.
- The weld deposit, along with the nut & washer will create a new structure that will act as an extension of the original fastener.

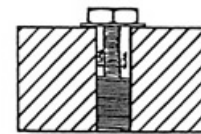

- Allow the work area to cool before proceeding.
- To remove the fastener, use hand tools only. DO NOT use an impact wrench of any kind.
- Back out the fastener with hand tools. After removal, run a tap over the threads to remove the slag residue.

W
E
L
D
I
N
G

P
R
O
D
U
C
T
S

VINCULUM

"THE CONNECTING MEDIUM"





VINCULUM

THE CONNECTING MEDIUM

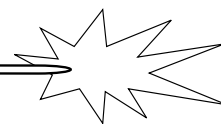

Hi-Alloy Welding Rod
A Superior Super Strength Electrode
 For Welding Alloy and Dissimilar Steels
 AC or DC Reverse Polarity • All Position

The Perfect Choice For Removing Broken Bolts, Studs, Taps & E-Z Outs!

VINCULUM™ HI-ALLOY is designed to weld low, medium and high alloy steels where super strength and high quality welds are desirable.

Features:

- Used for broken stud removal
- Replaces large size E-Z outs
- Joins any stainless to carbon steels
- Less errors and guess work

Welds:

- Low, medium and high alloy steels
- Spring steels
- Carbon Steels
- Stainless steel to carbon steel
- Stainless steel
- Manganese
- Any combination of weldable steels
- Cast steels
- Tool and die steel

Applications:

- Camshafts
- Drive Shafts • Gears
- Scraper teeth and arms
- Crane booms
- Dies
- Excellent underlayment prior to hardfacing
- Shovel buckets
- Rollers

Procedures:

Remove all foreign material from joint area. Heavy sections should be beveled to form a 90° vee. High carbon steel should be preheated to 400° F (204°C). Maintain alignment by use of jigs, fixtures and tack welds. Use stringer beads to prevent overheating and maintain a short arc. Allow to cool prior to removing slag.

Technical Data:

Tensile Strength - welded..... up to 120,000 psi
 work hardened..... up to 180,000 psi
 Yield strength..... up to 90,000 psi
 Elongation %..... approx. 28%
 Hardness (HB)..... approx. 300
 Current.....AC or DC Reverse Polarity
 (Electrode +)
 Color..... Blue

IBS No.	Diameter	Amperage	Extracts Bolt
46008	5/64	25 - 55	5/16
46010	3/32	40 - 80	3/8
46012	1/8	65 - 120	1
46014	5/32	90 - 150	2-1/2

HI-ALLOY ROD IS SOLD IN 5 & 10 LB PACKAGES



IBS, INCORPORATED

Vinculum S05

VINCULUM

THE CONNECTING MEDIUM

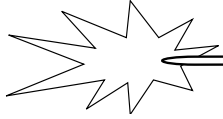

Ultralloy

The Ultimate Electrode for Welding All Types of Steels, Without Any Danger of Cracking or Breakage

AC or DC Reverse Polarity (Electrode +)

Especially Recommended for AC

W
E
L
D
I
N
G
P
R
O
D
U
C
T
S

A premium electrode designed to produce the highest tensile weld. Formulated to provide improved arc stability under adverse conditions where old or inexpensive welding equipment is used. It is amazingly stable on low, open circuit voltages and AC buzz boxes. The weld metal transfer creates smooth porosity-free welds with almost no spatter. Arc re-strike is instantaneous, virtually self-releasing slag.

Applications:

Due to exceptional strength and crack resistance, **ULTRALLOY** is ideal for repairing tools, dies, spring steel, carbon steel, stainless steel and any dissimilar metal combinations, with the exception of aluminum, cast iron and copper alloys. Due to the strength of the weld metal it is ideal for repairing worn parts and as an underlayment prior to hardfacing. Excellent for rebuilding blades and shafts used in construction, mining, and chemical industries. Truly the home hobbyist and maintenance welder's first choice for general applications.

Procedures:

The area in which the weld is to be made should be free of rust, grease, paint and other materials which cause weld contamination. A 90° vee joint should be used when joining heavy sections. Preheat is necessary only for high carbon steels, which should be preheated to 350° (204°C), the inter-pass temperature should be kept below 500°F (260°C). Alignment should be maintained by the use of fixtures, tack welds or other types of mechanical support. Maintain a short arc length and use stringer beads. Avoid weaving whenever possible.

Technical Data:

Tensile Strength
as welded..... up to 128,000 psi
work hardened..... up to 186,000 psi
Yield Strength..... up to 90,000 psi
Elongation % approx. 32
Hardness approx 320
Current AC or DC
..... Reverse Polarity (Electrode +)
Color Green

IBS No.	Diameter	Amperage
46082	3/32	60 - 80
46084	1/8	90- 110
46086	5/32	75 - 140

ULTRALLOY ROD IS SOLD IN 5 & 10 LB PACKAGES



IBS, INCORPORATED

Vinculum S05

VINCULUM

THE CONNECTING MEDIUM

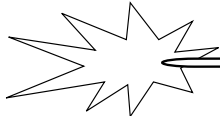

Braze-Alloy High Strength Brazing Alloy

Torch or Induction

W
E
L
D
I
N
G

P
R
O
D
U
C
T
S

VINCULUM™ BRAZE-ALLOY is a premium grade, flux coated, high strength alloy for general maintenance repair with a torch. It is an excellent choice for the build-up of parts subjected to high frictional wear and to repair gears with broken teeth. Also, at slightly higher temperatures its exceptional thin flow characteristics make it ideal for repairing broken bits, attaching carbide tips, etc.

Applications:

(Low temperature)

Build up of

- Valve seats
- Wedge bars
- Steering knuckles
- Gear teeth
- Reamers
- Shafts
- Bearings

(High temperature)

- Tool steel
- Cast iron
- Alloy steels
- Brass-Copper
- Galvanized iron
- Thin sheet metal

Procedures:

Clean joint area. This thin flowing alloy will have maximum strength with a joint clearance of .001" to .003" Using a neutral flame, heat the part uniformly until the flux is liquefied. Add sufficient alloy to fill the joint. Additional passes can be applied without the need to remove flux residue from previous passes.

Allow the part to cool slowly. Remove the flux by chipping and wire brushing.

Technical Data:

Tensile strength up to 113,000 psi
 Hardness (HB) 140 - 200
 Working temperature 1400° - 1750° F
 Remelt temperature approx. 1800° F
 Color Red

IBS No.	Dia. x Length
46020	3/32 x 18"
46022	1/16 x 18"
46023	1/8 x 18"

BRAZE-ALLOY ROD IS SOLD IN 5 & 10 LB PACKAGES



VINCULUM

THE CONNECTING MEDIUM

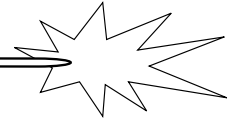

“Quicksilver” Brazing Alloy

56 % Silver, Cadmium Free

for joining Ferrous and Non-Ferrous metals

Torch, Furnace or Induction

VINCULUM™ “QUICKSILVER” BRAZING ALLOY features an exclusive thermal flux coating that makes this high silver, cadmium free brazing rod unique. The flux provides excellent cleaning action on most metals and does not blacken. It is ideal for food and pharmaceutical applications since it is cadmium free.

Applications:

Used in the food and dairy industry for joining stainless steels. Ideal for general maintenance and repair. For the repair and assembly of laboratory apparatus, control devices, instruments, tubing, trim work, switches, etc.

Procedures:

Joint must be clean. For maximum strength, joint clearances should not exceed .003". Maintain alignment by use of fixtures and jigs. Heat parts broadly with a slightly carburizing flame. Place thermal flux on the heated joint. When the flux becomes clear and fluid, melt a small amount of alloy onto the joint.

Continue heating until the alloy flows into the joint. **Base Metal Must Not Be Over Heated.** After part has cooled slowly, remove flux residue with warm water.

Technical Data:

Tensile strength..... up to 76,000 psi
Working temperature..... approx. 1220° F
Corrosion resistance..... Good
Color match..... Good on stainless steel
Electrical conductivity..... Good
Elongation %approx. 22

IBS No.	Dia. x Length	Pkg Qty
46056	1/16 x 18"	Each
46055	3/64 x 18"	Each

W
E
L
D
I
N
G

P
R
O
D
U
C
T
S



IBS, INCORPORATED

Vinculum S05

VINCULUM

THE CONNECTING MEDIUM

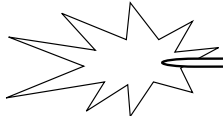

Hi-Abrasion Premium Hard Surfacing Electrode For Severe Abrasion

AC or DC Reverse Polarity

VINCULUM™ HI-ABRASION is designed for parts subjected to severe abrasion and light impact. Also for surfaces that must resist abrasion combined with scaling.

Features:

- High deposition rate
- Self releasing slag
- Excessive dilution with base metal easily prevented
- High chromium content to maintain abrasion resistance
- Smooth beads
- Easily controlled arc

Applications:

- Equipment for processing coal, rock, soil, cement and ceramic matter
- Grinding plates
- Conveying chains
- Open-hearth tools
- Earth augers
- Earth scrapers
- Annealing furnaces
- Rock crushers

Procedures:

All unsound metal or foreign material should be removed from the surface to be welded. An elastic cushion layer should be applied before surfacing for best results. On carbon and manganese steel use **VINCULUM™ HI-ALLOY**. When making the final surface, keep the electrode vertical to the work piece and maintain a short arc. Thin deposits never more than two layers thick should be used. Alternate welding area to prevent excessive local heat build-up. Allow part to cool slowly.

Technical Data:

HardnessRC 56 - 60
 CurrentAC or DC Reverse Polarity
 (Electrode +)
 Color Gray

IBS No.	Diameter	Amperage
46035	1/8	80 - 125
46037	5/32	100- 160

HI-ABRASION ROD IS SOLD IN 5 & 10 LB PACKAGES

04-18-24

W
E
L
D
I
N
G
P
R
O
D
U
C
T
S



VINCULUM

THE CONNECTING MEDIUM

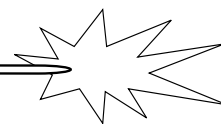

MRO Cast

Specially Designed for Dirty Cast Iron - The Problem Solver to Use When All Others Fail

AC or DC Reverse Polarity (Electrode +)

VINCULUM™ MRO CAST has a unique flux coating on alloyed cored wire which produces dense, strong crack-resistant welds on all types of cast iron. Especially good for contaminated, old, oil-soaked, dirty base metal. Also recommended for joining cast iron to steel. Use on gray, ductile, Meehanite, and nodular cast iron. Deposits are machinable.

Applications:

Use on sewer pipe, machine bases, transmission or gear housings, sprockets, repair of or build-up on gears, and any repair of cast iron to steel.

Procedures:

On heavy sections, remove worn, cracked metal, and bevel joint using **VINCULUM™ GROOVY** (46015 - 1/8") , or an **IBS Hi-Alloy Grinding Wheel** (see page PA-7 for grinding wheels). When repairing cracks, drill a "stop" hole at either end to prevent spreading while welding. On very heavy sections, preheat to approximately 400°F. Use short stringer beats for root pass and peen lightly after removing slag. Use a short to medium arc and lowest amperage possible to minimize base metal over-heating. When breaking arc, always back whip onto weld crater. Weaving two times rod diameter is acceptable for cover beads on multi-pass work. Weld joints should be allowed to slow cool for maximum strength and machinability.

Technical Data:

Tensile Strength.....	up to 75,000 psi (517N/mm ²)
Hardness	Brinnell 210
Current	AC or DC Reverse Polarity (Electrode +)

IBS No.	Diameter	Amperage
46030	3/32	40 - 70
46031	1/8	70- 110

MRO CAST Is SOLD IN 5 & 10 LB PACKAGES



IBS, INCORPORATED

Vinculum S05

VINCULUM

THE CONNECTING MEDIUM

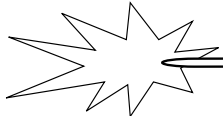

All Position Stainless

Special vertical position stainless steel electrode

- Unique “Fast-Freeze” coating simplifies vertical down and up welding.
- Ideal for poor fit-up joints in all positions.
- Controlled weld puddle allows for filling holes on stainless steels.

INTERNATIONAL SPECIFICATIONS	AWS/ASME IIC SFA F.5 E 316L-16
	DIN 8556 E19123L R 23
	ISO 3581 E19.12.3L R 23
	BS 2926 - 1984 19.12.3L R

APPLICATIONS:

Especially suited for vertical down and up welding of thin to medium gauge molybdenum bearing stainless steels.

MICROSTRUCTURE:

Austenite with 3-9% ferrite. Typical ferrite number is 6.

ALL WELD METAL ANALYSIS (TYPICAL WEIGHT %)									
C	Mn	Si	S	P	Cr	Ni	Mo	Cu	Fe
.018	.9	.75	.01	.02	19	12	2.65	.1	bal

WELDING TECHNIQUES:

For vertical welding, set amperage at high end of the scale. Maintain a sharp angle with the electrode pointing upward. Whip the electrode quickly back and forth while moving up or down. Electrode may show a red color from the excess amperage which is normal.

Technical Data:

Tensile strength..... up to 80,000 psi
 Yield strength 56,000 psi
 CurrentDC Reverse (+) or AC
 Elongation42%
 HardnessRockwell B96, Brinnell 209
 Welding Positions..... Flat, Vertical Up
Vertical Down, Horizontal, Overhead
 Color Ivory

IBS No.	Diameter	Amperage
46065	3/32 x 12"	60 - 80
46066	1/8 x 14"	90- 110

ALL POSITION STAINLESS IS SOLD IN 5 & 10 LB PKGS.

W
E
L
D
I
N
G
P
R
O
D
U
C
T
S



VINCULUM

THE CONNECTING MEDIUM

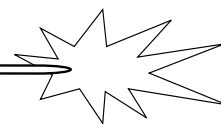

MIG Wire: Mid-Alloy Mild Steel MIG Wire for Multi-Pass Welds

GENERAL CHARACTERISTICS:

Mid-Alloy MIG Wire has excellent fluidity and bead appearance. High manganese and silicon content provides deoxidation when welding through mill scale and on rusty or oily surfaces. This is the wire to use when welding conditions are less than perfect. In a CO₂ atmosphere, Mid-Alloy MIG Wire produces a quiet, stable arc. It has out-of-position usability when using small diameters and short circuiting transfer.

APPLICATIONS:

Produces porosity free welds in applications where poor fit-ups, scale and rust are encountered. Use on steel castings, shaft build-up, tanks, truck bodies, farm and construction equipment.

RECOMMENDED WELDING PARAMETERS DCEP:

Diameter	Volts	Gas Flow Amps	Electrical (cfh)	Stick-Out
.024 (.6mm)	12-18	15-120	20	1/4" -3/8"
.030 (.8mm)	14-24	25-100	20	1/4" -3/8"
.035 (.9mm)	15-24	50-150	20	1/4" -3/8"

ALL WELD METAL ANALYSIS (TYPICAL WEIGHT %)				
C	Mn	P	S	Si
.08	1.59	.016	.010	1.00

TECHNICAL DATA:

Tensile Strength.....up to 85,900 psi (59 kg/mm²)
 Current.....DCEP
 Yield Strength.....up To 66,300 psi (46 kf/mm²)
 Elongation.....approx. 27
 Charpy V-Notch @ -20°F.....39 ft. lbs

MIG WIRE: MID-ALLOY

IBS No.	Dia.	Volts	Gas Flow Amps	Spool Size	Stickout	Qty
46104	.023	12-18	15-120	2 lb.	1/4"-3/8"	1
46105	.030	14-24	25-180	2 lb.	1/4"-3/8"	1
46106	.035	15-24	60-225	2 lb.	1/4"-3/8"	1
46114	.045	17-34	100-325	2 lb.	3/8"-3/4"	1
46107	.023	12-18	15-120	10 lb.	1/4"-3/8"	1
46108	.030	14-24	25-180	10 lb.	1/4"-3/8"	1
46109	.035	15-24	60-225	10 lb.	1/4"-3/8"	1
46115	.045	17-34	100-325	10 lb.	3/8"-3/4"	1
46116	.035	15-24	60-225	33 lb.	1/4"-3/8"	1
46117	.045	17-34	100-325	33 lb.	3/8"-3/4"	1



WELDING PRODUCTS



IBS, INCORPORATED

Vinculum S05

VINCULUM

THE CONNECTING MEDIUM

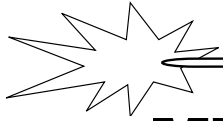

MIG Wire: Flux Core Gasless

For Use on Thin Gauge Galvanized & Mild Steel

W
E
L
D
I
N
G
P
R
O
D
U
C
T
S

GENERAL CHARACTERISTICS:

This self-shielded, flux-cored mild steel wire is designed for single pass, semi-automatic welding applications encountered by the maintenance and repair welder. It is excellent for carbon steels, galvanized steels and zinc coated steels. The specially formulated flux contained inside the wire eliminates the need for an external shielding gas and provides the necessary slag to produce high quality welds. Vinculum Diverse-Alloy MIG Wire is excellent for use with small constant current wire feeders which are lightweight.

APPLICATIONS:

Fabrication and repair of lightweight structural steel, trailers, tanks, hoppers and machinery parts. Excellent for use on fillet and lap welds on thin gauge steel where burn through is a problem with other wires and electrodes. An ideal electrode to use in drafty or windy conditions where gas-shielded wires cannot be used.

RECOMMENDED WELDING PARAMETERS DCEN(-):

Diameter	Volts	Amps	Stick-Out
.030	14-17	25-100	3/8"-1/2"
.035	13-19	50-150	3/8"-1/2"

TECHNICAL DATA:

Tensile Strength.....up to 83,000 psi (572 N/mm²)
 Current.....DCEN (electrode -)
 AWS Specification.....AWS A5.20 SFA 5/2- E71T-GS

MIG WIRE: DIVERSE-ALLOY

IBS No.	Diameter	Volts	Amperage	Spool Size	Stickout	Qty
46100	.030	14-17	25-100	2 lb.	3/8"-1/2"	1
46101	.035	13-19	50-150	2 lb.	3/8"-1/2"	1
46102	.030	14-17	25-100	10 lb.	3/8"-1/2"	1
46103	.035	13-19	50-150	10 lb.	3/8"-1/2"	1





VINCULUM

THE CONNECTING MEDIUM

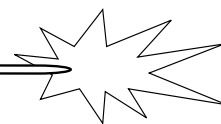

MIG Wire: Alum-Alloy 4043

For Use on Heat-Treatable Welding Alloys & 6XXX Series Alloys

GENERAL CHARACTERISTICS:

Alum-Alloy 4043 MIG is a great choice for the welding of heat-treatable base alloys and more specifically the 6XXX series alloys. It has a lower melting point and more fluidity than the 5XXX series filler alloys and is preferred by welders because of its favorable operating characteristics. ER4043 type wires are also less sensitive to weld cracking than the 6XXX series base alloys. 4043 is suitable for sustained elevating temperature service, i.e. above 150°F.

FEATURES:

- Superior wire surface finish for the best feedability and arc performance.
- Optimal manufacturing process to precisely control chemical composition.
- State-of-the art testing equipment to ensure trouble-free performance of the weld wire.
- Manufactured under quality system certified to ISO 9001 requirements.

SPECIFICATION:

- Conforms to ANSI/AWS A5.10 (ER & R) AMS 4190
- ISO designation: AlSi5

APPLICATION:

- For welding 6XXX alloys, and most casting alloys.
- Good all-purpose filler alloy.
- Automotive components such as frame and drive shafts.
- Bicycle frames.

TECHNICAL DATA:

Melting Range1065°F - 1170°F
 Conductivity.....42% IACS (-O)
 Density.....0.097 lbs./cu.in.
 Resistance to corrosion.....B (Gen) A (SCC)
 Anodize Color.....Gray

MIG WIRE: ALUMA-ALLOY 4043

IBS No.	Diameter	Volts	Amperage	Spool Size	Qty
46130	.030	100-130	18-22	1 lb.	1
46131	.035	85-120	20-23	1 lb.	1
46132	3/64	125-150	20-24	1 lb.	1



W
E
L
D
I
N
G

P
R
O
D
U
C
T
S



IBS, INCORPORATED

Vinculum S05

VINCULUM

THE CONNECTING MEDIUM

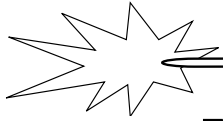

MIG Wire: MRO Stainless

For Type 316 Stainless Steel and other AISI Grade
(304, 304L, 308, 308L, 316 & 316L)
Meets AWS A5.9-9.3 under class ER316L Si

W
E
L
D
I
N
G
P
R
O
D
U
C
T
S

GENERAL CHARACTERISTICS:

MRO Stainless is suitable for welding AISI grades 316L & 308L when improved resistance to pitting corrosion is required. Deposits have superior resistance under salt-water conditions. When optimally applied, weld deposits are smooth and free from out-gassing and porosity.

APPLICATIONS:

Typical applications include valve and pump trim, digester tanks, pulp, paper and textile processing equipment, marine applications, evaporators, etc., with improved performance due to the molybdenum content.

TECHNICAL DATA:

Typical Tensile Strengthup to 75,000 psi
 Typical Yield Strength up to58,000 psi
 Typical Elongation (1=5d) min.....35%
 Typical Hardness (BHN)160
 Impact Strength.....35 Ft-lbs at -320°F (-160°C)
 Current.....DCEP (+)
 Typical Ferrite Number.....10 - DeLong Diagram

Diameters:	0.035" (0.9mm)	0.045" (1.2mm)
Short Arc Amperage:	65-145	120-175
Spray Arc Amperage:	145-225	180-260

Short-Arc Shielding Gas: 90% Ar + 7.5% He + 2.5%CO ₂ @ 25-25 scfh	75% Ar+25% CO ₂ @ 25-28 scfh
Spray-Arc Shielding Gas: 98% Ar 2% O ₂ @ 35-40 scfh	98% Ar 2% O ₂ @ 35-40 scfh

MIG WIRE: MRO STAINLESS

IBS No.	Diameter	Amperage Short Arc	Amperage Spray Arc	Spool Size	Qty
46110	.035 (0.9mm)	65-145	145-225	2 lb.	1
46111	.045(1.2mm)	120-175	180-260	2 lb.	1
46112	.035 (0.9mm)	65-145	145-225	10 lb.	1
46113	.045 (1.2mm)	120-175	180-260	10 lb.	1





IBS, INCORPORATED

Vinculum S05

VINCULUM

THE CONNECTING MEDIUM



Vinculum Welding Electrode Assortment

STEEL & CAST IRON

IBS No. 754R • 5 Items • 9 lbs.

W
E
L
D
I
N
G

P
R
O
D
U
C
T
S

IBS, Inc. SPECIALTY PRODUCTS FOR MAINTENANCE & REPAIR INDUSTRIALBOLT.COM 800-678-1906		Vinculum Welding Electrode Assortment Steel & Cast Iron	
		Assortment No. 754R	
46015 1/8 GROOVY VINCULUM Premium High Speed Gouging And Chamfering Electrode	VINCULUM™ GROOVY is designed to remove metal fast and efficiently without special skills or special equipment, expensive gases or compressed gas. Color: Gray	Technical Data: Current..... AC or DC Straight Polarity (Electrode -)	
46031 1/8 MRO CAST VINCULUM Specially Designed for Dirty Cast Iron - The Problem Solver to Use When All Others Fail	Vinculum™ MRO CAST has a unique flux coating on alloyed cored wire which produces dense, strong crack-resistant welds on all types of cast iron. Especially good for contaminated, old, oil-soaked, dirty base metal. Also recommended for joining cast iron to steel. Use on gray, ductile, Meehanite, and nodular cast iron. Deposits are machinable. Color: Dark Gray/Black	Technical Data: Tensile Strength..... up to 75,000 psi (517N/mm2) Hardness..... Brinell 210 Current..... AC or DC Reverse Polarity (Electrode+)	
46012 1/8 HI ALLOY VINCULUM A Superior Super Strength Electrode For Welding Alloy and Dissimilar Steels	VINCULUM™ HI-ALLOY is designed to weld low, medium and high alloy steels where super strength and high quality welds are desirable. Color: Blue	Technical Data: Tensile Strength - welded..... up to 120,000 psi work hardened..... up to 180,000 psi Yield strength..... up to 90,000 psi Elongation %..... approx. 28% Hardness (HB)..... approx. 300 Current..... AC or DC Reverse Polarity (Electrode+)	
46042 1/8 VINCULUM DIVERSE-ALLOY A Premium High Strength Electrode For Welding High Strength Low Alloy Steels and Abrasion	DIVERSE-ALLOY is excellent for welding most high-strength low alloy steels. It is recommended for the repair of heavy equipment and joints subjected to high stresses because of its high strength. The moisture resistant coating assures dense, crack-free deposits for outstanding impact resistance at all temperatures, and X-ray quality welds. Color: White	Technical Data: Tensile Strength . . . up to 93,000 psi (70 kg/mm2) Elongation % approx. 32 Current AC or DC Reverse Polarity (Electrode+)	
46004 1/8 MID ALLOY VINCULUM Premium General Purpose Alloy For Low Carbon Steels	Vinculum™ Mid-Alloy is designed to operate on all welding machines, even small AC type transformers when the open circuit voltage is very low. The specially formulated coating protects the deposit from adverse conditions normally encountered in maintenance welding. An ideal electrode for field repair work and out of position welding. Color: Gold	Technical Data: Tensile Strength..... up to 80,000 psi Yield Strength..... up to 68,000 psi Elongation %..... approx. 24% Current..... AC or DC either polarity	

IBS, INCORPORATED

Miscellaneous Tools (T03)



Excalibur Butane Solder Torch Kit IBS No. 141060



A self-igniting and cordless Soldering Iron, Hot Air Blower and Butane Torch complete in 1 great tool! The Piezo electric instant ignition system provides a quick start-up in any mode.

Includes a wide range of tips, wrench, sponge and a tube of solder for all your needs.

5 TIPS IN TOTAL

The Excalibur comes with 5 interchangeable tips: 1 Reflector, 1 Hot Air Blower, 1 Hot Knife, 1 3.5mm Chisel Tip, and 13mm Diagonal Tip. One tube of solder and cleaning sponge are also included.

IMPACT RESISTANT CASE

Includes a handy, impact-resistant travel case for complete mobility, moves easily from the workshop to the field. Case holds everything cleanly for quick, hassle-free storage.



FEATURES

- Sturdy & compact tool case
- Interchangeable tips - 5 in all
- Tube of 60/40 Coiled Silver Solder
- Tip cleaning sponge
- 2500°F Flame
- Easy start ignition switch

IDEAL FOR:

- Electronic system repair
- Automotive
- Industrial
- Woodworking
- Lapidary
- Optical
- General Maintenance
- Professional repair jobs



IBS, INCORPORATED

Vinculum S05

W
E
L
D
I
N
G
P
R
O
D
U
C
T
S

Solder Combo Assortments (Z08)

One of our bestselling assortments just got better! Solder combos available in any combination — 2 of our Low Temperature Silver Bearing Solder in coil, paste, or one of each and includes the new **MICROTORCH BUTANE TORCH!**

MICROTORCH BUTANE TORCH

IBS No. 125738 (T03)
Retail Value \$39.95

At only 5-1/4" high with a 2500°F flame, the **MICROTORCH** is ideal for all types of professional use. Refillable with premium grade Butane Refill. (IBS No. 95007 - T03).

Low temperature silver bearing soft solder — the highest strength, lowest melting point silver solder alloy for stainless steel, dissimilar metals and chrome plating, available in coil, or syringe paste.

- 500% stronger than common solders.
- Superior corrosion resistance with bright, shiny deposits.



IBS No.	Description
418P	1 Solder Paste Syringe 1 Coil 1 Torch 1 Butane Refill
425P	2 Solder Paste Syringes 1 Torch 1 Butane Refill
426P	2 Solder Coils 1 Torch 1 Butane Refill

Industrial Butane Torch

Powerful, portable, refillable and anti-flare with a flame temperature of over 2500°F, the Industrial Butane Torch is ideal for automotive, plumbing, and professional repair shop use.



Functions & Uses:

- Lead Gutters
- Toughen Metal
- Stripping Paint
- Automotive Repair
- Sweat Ftgs & Joints
- Lay or Remove Tiles
- Loose Bolts
- Plumbing
- Dry Cements

IBS No.	Description	Qty
125739	Industrial Butane Torch	1

Microtorch Butane Torch



At only 5-1/4" high with a 2500° flame, the **Microtorch** is ideal for all types of professional use. Refillable with premium grade butane (IBS No. 95007). A versatile and handy addition to any professional workshop.

IBS No.	Description	Qty
125738	Microtorch Butane Torch	1

Butane Refill



Universal tip fuels most leading butane lighters

Low in non-volatile contaminants which can cause burner valve to clog, affecting flame height and function.

WARNING: USE THIS PRODUCT ONLY AS DIRECTED ON THE PACKAGE. INTENTIONAL MISUSE BY DELIBERATELY CONCENTRATING AND INHALING THE CONTENTS CAN BE HARMFUL OR FATAL.

KEEP OUT OF REACH OF CHILDREN. DO NOT DISTRIBUTE TO MINORS.

IBS No.	Description	Qty
95007	Butane Refill 75 ml	1

Markal® Silver-Streak® Pencils



Markal® Silver-Streak® welders pencil offers torch resistant, highly visible marks that will not burn or rub off like soapstone. The new welders pencil writes on all types of metal surfaces, even oily, wet surfaces, making these pencils an economical must for any welder or fabricator.

- **Economical, high-strength** pencil is ideal for marking all types of metal surfaces — even oily, rusty or wet surfaces.
- Perfect for **metal layout and fabrication work**.
- Marks **resistant to torch flames**; will not rub off or burn off like soapstone.
- **Highly visible marks** illuminate when cutting or welding.
- **Durable marks** will not scratch or abrade metal surfaces.
- **Hexagonal shape** reduces barrel roll unlike competitive brands.
- Sharpen with any standard pencil sharpener.



IBS No.	Color	Qty
96101	Markal Silver Streak Pencil	12
96006	Markal Silver Streak Mechanical Round	1
96007	Markal Silver Streak Mech REFILL 6PK	1



IBS, INCORPORATED

Vinculum S05

VINCULUM

THE CONNECTING MEDIUM

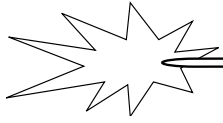

IBS Type 187 Spotweld Drill Bits



This rugged, high performance drill bit is designed to effectively cut auto body panel spot welds. The high red hardness of cobalt steel permits speeds up to 30% greater than H.S.S. drills. Cobalt Steel is substantially more abrasion resistant, resulting in very long wearing cutting edges.

IBS TYPE 187 SPOTWELD DRILL BITS

IBS No.	Diameter MM	Approx Spotweld Size (IN)	Overall Length (IN)	Flat Length (IN)	Pkg Qty
19341	8.0	1/3	2.25	none	1
19342	10.00	3/8	2.25	none	1
19343	8.0 TE	1/3	2.25	none	1
19344	10.0 TE	3/8	2.25	none	1
19340	IBS Type 187 Spotweld Drill Bit Assortment 4 Pc Set Contains one of each size listed above (P15)				



*TE - Twin End Drill Bits

These twin end drill bits will cut twice as many as spot welds with the added advantage of longer reach to drill the less accessible spotwelds.

STORM® Series Brazing Safety Glasses (S07)

by Crews, Inc.

MEETS OR EXCEEDS ANSI Z87. Safety Standards

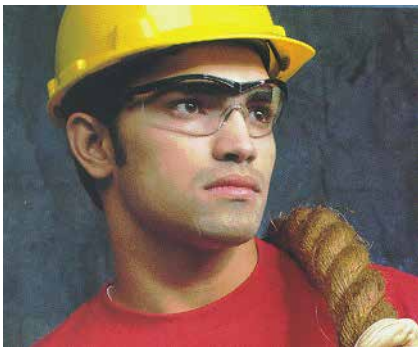

- Ratchet action temples combined with non-slip rubber head grips creates a customized fit.
- Wrap-around lens constructed of lightweight, scratch-resistant polycarbonate delivers advanced visual acuity and protection.
- Interchangeable lenses.
- Provides 99.9% UV protection.

STORM® SERIES BRAZING SAFETY GLASSES*



Brazing Glasses
Shade 3.0 Green
IBS No. 128063

Brazing Glasses
Shade 5.0 Green
IBS No. 128064

* STORM Series Glasses come with black frame unless otherwise noted.

W
E
L
D
I
N
G

P
R
O
D
U
C
T
S



Cabinets & Tools

A

Assortments

- Adhesives
- Drive Grip & Insert bits T-28
- Driver Bits
- Grabit Damaged Screw Remover & DriveGrip T-28

C

Cabinets

- Drill Dispensers & Organizers T-14, T-15
- Drill & Tap Indexes T-16, T-17
- Large Metal & Plastic Compartment Trays T-6, T-7
- Large Metal Racks & Accessories T-7, T-8
- Metal & Plastic Compartment Trays and Racks T-10
- Metal Storage Bins & Accessories T-5
- Metal Storage Drawers & Accessories T-6
- Small Metal & Plastic Compartment Trays T-8, T-9
- Small Metal Racks & Accessories T-9
- Specialty Storage: Peg Racks & Miscellaneous T-13
- Specialty Storage: Rod, Bar & Tie Racks T-12
- Specialty Storage: Utility & Aerosol Cabinets T-10
- Specialty Storage: Wire & Hose Racks T-11

Crimping Tools

- Ratcheting Crimp Tool T-38

D

Driver Bits

- Flexible Extension T-18
- GRABIT PRO Damaged Screw Remover T-27, T-29

E

Extractors

- Bolt Extractor
- 5 Pc. 3/8" Drive Bolt/Stud Extractor Set T-26
- Screw Extractors
- 5 Pc. 3/8" Drive Bolt/Stud Extractor Set T-26
- Power-Outs™ Double Edged Screw Extractors T-25
- Spin-It-Out Damaged Screw Removers T-25
- Screw Extractors, Sets
- Power-Outs Sets T-25

F

Fiskars Utility Knives & Tools

- Tools
- Fiskars PowerArc Easy Action Shears (10") T-31

- Fiskars PowerArc Utility Snips (8") T-31
- Fiskars PowerGear Plastic Pipe Cutter T-32

H

Hand

- 2 QT Pump Up Sprayer T-48

S

Snips, Shears & Pipe Cutters

- Fiskars
- PowerArc Easy Action Shears (10") T-31

Specialty Storage

- Sphag Sorb 30 Gallon Storage Drum with Locking Lid T-17
- Sure Can Fuel Containers
- 2.2G, 5G, & 5G Diesel T-17
- Wall Mountable Pegboard Panel
- 8" Pegboard Hooks T-13
- Wall Mountable Pegboard Panel w (10) 8" Hooks T-13

T

Threaded Rod

- Tools
- Deburring Tool (T03) T-30

Tools

- Battery & Crimping
- Ratcheting Crimp Tool T-38
- Driver Bits
- Flexible Extension T-18
- Hand
- 2 QT Pump Up Sprayer T-48
- 3 & 6 Pc NES Internal & External Tool Sets T-24
- 3 Pc iNES Internal Set T-24
- 4-in-1 Tube Fitting Brush T-38
- 4-Way Chuck Key Caddies T-18
- 12 Volt Tester T-37
- 16" Adjustable Pry Bar/Nail Puller T-48
- 25 Piece Hex Hd Spline Drive Screw Extractor Set T-26
- Automatic Center Punch T-20
- Battery Cable Stripper T-37
- Big Daddy Manual Rivet Tool T-45
- Butane Refill T-36
- Cable Cutter T-37
- Cable Tie Gun T-41
- Can-Gun T-41
- Cartridge Loading Snap Knife with Rubber Grip T-32
- Caulking Gun T-42
- Center Punch Band-It Clamp
- Light Duty Hand Tool T-40
- T300 Heavy Duty Hand Tool T-40
- Deutsch Connector Tools T-39
- Excalibur Butane
- Solder Torch Kit T-36
- Fiskars Power Arc Easy Action Shears T-31



Fiskars PowerArc Utility Snips (8") T-31
 Golden Grip™ Internal Pipe Wrenches T-26
 HD Retractable Blade
 8 Pt. Breakaway Knife T-32
 Heavy Duty Metal Scraper T-31
 Heavy Duty Nutsert Tool T-44
 Heavy Duty Rivet Tool T-45
 Hex Head Spline Drive Screw Extractors T-26
 High Capacity Hydraulic Crimper T-37
 Hose Crimper T-47
 Hose & Tubing Cutter T-47
 IBS "Rapid Razor" Utility Knife T-32
 IBS Service Broom T-48
 Indent Crimper T-37
 Indexing Pry Bars T-48
 Industrial Butane Torch T-36
 iNES Internal Rethreading Tap T-23
 iNES Replacement Blades T-24
 Locking Dual Wheel Adapter T-43
 LockNFlate Coupler T-43
 LockNLube Coupler T-43
 Medium Duty Grease Guns T-42
 Metripack Crimping Tool T-39
 Metripack Terminal Removal Tool T-39
 Microtorch Butane Torch T-36
 Mini Cable Tie Gun T-41
 Mini Grease Gun T-42
 NES Internal Thread Cleaner / Restoring Tool T-22
 NES Replacement Blades T-22
 NES Rethreading Tools T-21
 NES Universal Thread Restorer 4 Pc Tool Kit T-22
 Nicholson® Pro Series
 4-in1 Hacksaw Frame T-30
 Power-Outs Sets T-25
 Professional Hex Die Wrench T-19
 Professional Straight Handle Tap Wrench T-19
 Ratcheting Crimp Tool Sets T-38
 Reciprocating Saw Handle T-31
 ReelTek Hose Reels & Assemblies T-46
 Revo Folding Knife T-33
 Rivet Nut Gun T-44
 Rivet Nut Gun Mandrels & Nosepieces T-44
 Select-A-Bit Security Driver T-18
 SHARK Heavy Duty
 Combination Utility Knife T-33
 Shur-Shot Dispensing Gun T-41
 Spray Bottle &
 Trigger Sprayers T-42
 Static Mixers T-41
 Sure Shot 32 oz. Measuring Pitcher T-42
 Swivel Head Professional Rivet Tool T-44
 Tapping Tool & Guide T-19
 T-Handle Ratcheting
 Tap Wrenches T-20
 T-Handle Tap Wrench T-19, T-20
 ThreadMate Set & External Tool T-24

Transfer Punches T-20
 28 Pc Set T-20
 Universal Crimping Tool T-37
 Weatherpack 22-12GA Crimper T-39
 Weatherpack Terminal Extractor Tool T-39
 Wire Crimp Tool T-38
 Wire Cutter T-37
 Power
 1/4" 90° Angle
 Air Die Grinder T-19
 1/4" Air Die Grinder T-19
 7-1/4" Circular Saw T-35
 14" Circular Saw T-35
 Battery End Power Cleaning Brushes T-38
 Compact Magnetic Drill Press T-34
 Dual Temp Electric Heat Gun T-36
 Hydraulic Crimper T-37, T-47
 Magnetic Drill Press T-34
 Slugger Cutting Fluid for Mag Drills T-34
 Variable Speed / Reversible
 Magnetic Drill Press T-34
 Threaded Rod
 Deburring Tool 3Pc Set (T03) T-30



Turning Maintenance Departments into Profit Centers



**DOES YOUR SHOP LOOK
LIKE THIS?** 

The Supplies You Need, When & Where you Need Them



**WE'LL MAKE IT LOOK
LIKE THIS!** 

Eliminates Downtime, High Costs, Stock-Outs & Overstock



IBS, Inc.

1 (800) 678-1906
www.industrialbolt.com

C
A
B
I
N
E
T
S
&
T
O
O
L
S



IBS, INCORPORATED Cabinets T01

Inventory Control On 13,000 High Quality Maintenance Products

THE SUPPLIES YOU NEED WHERE YOU CAN FIND THEM!

With IBS Inc. cabinets and drawers the right part is always available when and where you need it. No more endless searching through piles of parts and through countless unidentified boxes for that 1/4" lockwasher you purchased last week. With the IBS inventory system you'll always know what you have and what you need to order. IBS' Sales Agent will work with you to specially design your system to meet your companies specific and unique needs.

The IBS Sales Agent will:

- Recommend required storage equipment.
- Identify each part carried.
- Determine inventory needs.
- Set minimum and maximum quantities.
- Check stock on a regular basis.
- Organize and clean bins.

IBS Inventory Control Helps To Eliminate:

- Excessive downtime.
- High maintenance costs.
- Stock-outs.
- Excessive inventories.



C
A
B
I
N
E
T
S
&
T
O
O
L
S



Metal Storage Bins & Accessories

- All welded, prime cold rolled steel.
- Fully hemmed, 1-1/8" bin fronts to hold and retain parts.
- Roll formed sides for increased strength and stability.
- Modular with all other 12" deep bins.
- Durable black powder coat finish.
- Optional base and bin labels available.
- Ships fully assembled.



72 HOLE STORAGE BIN

NOTE: AUTO FREIGHT ONLY

IBS No.	Dim: (W x D x H in.)	Holes	Hole Dim: (W x D x H in.)	Wt	Qty
72B	33-3/4 x 12 x 42	72	4 x 11-7/8 x 4-1/2	80 lbs	1
72BU	33-3/4 x 12 x 42 USED	72	4 x 11-7/8 x 4-1/2	80 lbs	1



56 HOLE STORAGE BIN

NOTE: AUTO FREIGHT ONLY

IBS No.	Dim: (W x D x H in.)	Holes	Hole Dim: (W x D x H in.)	Wt	Qty
56B	33-3/4 x 12 x 42	56	4-7/8 x 11-7/8 x 5-1/8	75 lbs	1
56BU	33-3/4 x 12 x 42 USED	56	4-7/8 x 11-7/8 x 5-1/8	75 lbs	1



42 HOLE STORAGE BIN

NOTE: AUTO FREIGHT ONLY

IBS No.	Dim: (W x D x H in.)	Holes	Hole Dim: (W x D x H in.)	Wt	Qty
42B	33-3/4 x 12 x 42	42	5-3/8 x 11-7/8 x 5-1/2	71 lbs	1
42BU	33-3/4 x 12 x 42 USED	42	5-3/8 x 11-7/8 x 5-1/2	71 lbs	1



40 HOLE STORAGE BIN

IBS No.	Dim: (W x D x H in.)	Holes	Hole Dim: (W x D x H in.)	Wt	Qty
40B	33-3/4 x 12 x 23-7/8	40	4 x 11-7/8 x 4-1/2	50 lbs	1
40BU	33-3/4 x 12 x 23-7/8 USED	40	4 x 11-7/8 x 4-1/2	50 lbs	1



36 HOLE STORAGE BIN - GRAY ONLY

IBS No.	Dim: (W x D x H in.)	Holes	Hole Dim: (W x D x H in.)	Wt	Qty
36B	17-7/8 x 12 x 42	36	4 x 11-7/8 x 4-1/2	50 lbs	1
36BU	17-7/8 x 12 x 42 USED	36	4 x 11-7/8 x 4-1/2	50 lbs	1



20 HOLE STORAGE BIN

NOTE: AUTO FREIGHT ONLY

IBS No.	Dim: (W x D x H in.)	Holes	Hole Dim: (W x D x H in.)	Wt	Qty
20B	33-1/4 x 12 x 42	20	8 x 11-7/8 x 8-1/2	55 lbs	1
20BU	33-1/4 x 12 x 42 USED	20	8 x 11-7/8 x 8-1/2	55 lbs	1



BASE FOR "B" TYPE BIN

- Prime cold rolled steel.
- Fits all 12" x 33-3/4" parts bins.
- Raises bins 5-3/4" above the floor
- Legs attach easily using fasteners provided
- Durable black powder coat finish

IBS No.	Dim: (W x D x H in.)	Fits Models	Wt	Qty
AJ364	33-3/4 x 12-1/4 x 5-3/4	72B, 56B, 42B, 40B, 36B, 24D, 20B	13 lbs	1
AJ364U	33-3/4 x 12-1/4 x 5-3/4 USED	72B, 56B, 42B, 40B, 36B, 24D, 20B	13 lbs	1



IBS, INCORPORATED

Cabinets T01

Metal Storage Drawers & Accessories

- Prime cold rolled steel construction.
- High density drawer cabinet; easy to store large quantities of small parts.
- Drawers feature interlocking design for superior strength.
- Drawers have full width handles and easy glide runners.
- Each drawer includes 2 easy-to-label dividers.
- Dividers are adjustable with 1" centers.
- Durable black powder coat finish.
- Cabinets can be stacked using mounting holes.
- Ships fully assembled.

18 DRAWER STORAGE CABINET



IBS No.	Dim: (W x D x H in.)	Drawers	Drawer Dim: (W x D x H in.)	Wt	Qty
18D	33-3/4x11-5/8 x10-7/8	18	5-3/8x11-1/4x2-3/4	50 lbs	1
18DU	33-3/4x11-5/8 x10-7/8 USED	18	5-3/8x11-1/4x2-3/4	50 lbs	1

9 DRAWER STORAGE CABINET



IBS No.	Dim: (W x D x H in.)	Drawers	Drawer Dim: (W x D x H in.)	Wt	Qty
9D	17-1/4 x 11-5/8 x 10-7/8	9	5-3/8 x11-1/4x2-3/4	28 lbs	1
9DU	17-1/4 x11-5/8 x 10-7/8 USED	9	5-3/8 x11-1/4x2-3/4	28 lbs	1
AJ023	Dividers	-	5-3/8x2-3/4	-	12

Large Metal & Plastic Compartment Trays

- Prime cold rolled steel outer shell construction
- Full piano hinge on cover provides rigidity.
- Positive pull-down catch keeps cover tightly closed to prevent part migration.
- Handle allows for easy transport.
- Durable black powder finish.

32 HOLE LARGE TRAY



IBS No.	Dimensions (W x D x H in.)	Holes	Weight	Qty.
DL-32C	18 x 12 x 3	32	8 lbs	1
DL-32CU	18 x 12 x 3 USED	32	8 lbs	1

24 HOLE LARGE TRAY



IBS No.	Dimensions (W x D x H in.)	Holes	Weight	Qty.
DL-24C	18 x 12 x 3	24	8 lbs	1
DL-24CU	18 x 12 x 3 USED	24	8 lbs	1

21 HOLE LARGE TRAY



IBS No.	Dimensions (W x D x H in.)	Holes	Weight	Qty.
DL-21C	18 x 12 x 3	21	8 lbs	1
DL-21CU	18 x 12 x 3 USED	21	8 lbs	1

20 HOLE LARGE TRAY



IBS No.	Dimensions (W x D x H in.)	Holes	Weight	Qty.
DL-20C	18 x 12 x 3	20	8 lbs	1
DL-20CU	18 x 12 x 3 USED	20	8 lbs	1

16 HOLE LARGE TRAY



IBS No.	Dimensions (W x D x H in.)	Holes	Weight	Qty.
DL-16C	18 x 12 x 3	24	8 lbs	1
DL-16CU	18 x 12 x 3 USED	24	8 lbs	1

C
A
B
I
N
E
T
S
&
T
O
O
L
S

IBS, INCORPORATED

Cabinets T01



Large Metal & Plastic Compartment Trays



12 HOLE LARGE TRAY

IBS No.	Dimensions (W x D x H in.)	Holes	Weight	Qty.
DL-12C	18 x 12 x 3	32	8 lbs	1
DL-12CU	18 x 12 x 3 USED	32	8 lbs	1



6 HOLE LARGE TRAY

IBS No.	Dimensions (W x D x H in.)	Holes	Weight	Qty.
DL-6C	18 x 12 x 3	6	8 lbs	1
DL-6CU	18 x 12 x 3 USED	6	8 lbs	1



ADJUSTABLE COMPARTMENT LARGE TRAY HORIZONTAL

IBS No.	Dimensions (W x D x H in.)	Holes	Weight	Qty.
AD-H	18 x 12 x 3	ADJ	8 lbs	1
AD-HU	18 x 12 x 3 USED	ADJ	8 lbs	1
AJ097	Dividers for AD-H (sold in pkgs of 9)		1 lb	9



ADJUSTABLE COMPARTMENT LARGE TRAY VERTICAL

IBS No.	Dimensions (W x D x H in.)	Holes	Weight	Qty.
AD-L	18 x 12 x 3	ADJ	8 lbs	1
AD-LU	18 x 12 x 3 USED	ADJ	8 lbs	1
AJ120	Dividers for AD-L (sold in pkgs of 9)		1 lb	9



ADJUSTABLE HOLE LARGE TRAY EXPANDABLE

IBS No.	Dimensions (W x D x H in.)	Holes	Weight	Qty.
AD-E	18 x 12 x 3	ADJ	8 lbs	1
AD-EU	18 x 12 x 3 USED	ADJ	8 lbs	1
125772	Horizontal Dividers for AD-E		1 lb	9
125773	Vertical Dividers for AD-E		1 lb	9

Large Metal Racks & Accessories

- Sturdy construction using prime cold-rolled steel.
- Each sliding cradle holds up to 75 lbs.
- Easy glide slides allow boxes to move in and out smoothly.
- Center braces on cradles provide extra rigidity.
- Boxes can be easily removed for transport to work areas.
- Reinforced rack keeps boxes level.
- Durable black powder coat finish.

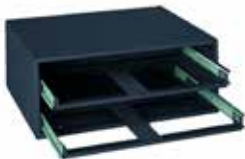

2 DRAWER LARGE RACK

HOLDS 2 LARGE COMPARTMENT TRAYS

IBS No.	Dimensions (W x D x H in.)	Drawers	Wt	Qty.
2LR-BT	20 x 15-3/4 x 8-1/8	2	20 lbs	1
2LR-BTU	20 x 15-3/4 x 8-1/8 USED	2	20 lbs	1



4 DRAWER LARGE RACK

HOLDS 4 LARGE COMPARTMENT TRAYS

IBS No.	Dimensions (W x D x H in.)	Drawers	Wt	Qty.
4LR-BT	20 x 15-3/4 x 15	4	37 lbs	1
4LR-BTU	20 x 15-3/4 x 15 USED	4	37 lbs	1



IBS, INCORPORATED

Cabinets T01

C
A
B
I
N
E
T
S
&
T
O
O
L
S

Large Metal Racks & Accessories



TRIPLE TRACK SPACE SAVER RACK (Holds 4 Lg Compartment Boxes)

IBS No.	Dimensions (W x D x H in.)	Drawers	Wt	Qty.
4LR-TT	20-1/4 x 12-1/2 x 15	4	37 lbs	1
4LR-TTU	20-1/4 x 12-1/2 x 15 USED	4	37 lbs	1



AJ304, AJ311

BASES FOR LARGE SLIDE RACKS

- Sturdy all steel construction.
- Available for both the Easy Glide and Space Saver Racks.
- Raises units off the floor.
- Legs attach easily using fasteners (included).
- Durable black powder coat finish.



AJ304S

IBS No.	Dimensions (W x D x H in.)	Fits	Wt	Qty.
AJ304	20-5/8 x 16-1/4 x 15-5/8	4LR-BT	13 lbs	1
AJ304U	20-5/8 x 16-1/4 x 15-5/8 USED	4LR-BT	13 lbs	1
AJ304S	20-5/8 x 16-1/4 x 5-3/4	4LR-BT	12 lbs	1
AJ304SU	20-5/8 x 16-1/4 x 5-3/4 USED	4LR-BT	12 lbs	1
AJ311	20-5/8 x 12-5/8 x 15-5/8	4LR-TT	12 lbs	1
AJ311U	20-5/8 x 12-5/8 x 15-5/8 USED	4LR-TT	12 lbs	1



LOCKING HINGE

- All steel for durability.
- Fits both the 4 section Easy Glide Slide and Triple Track Space Saver Racks.
- Holds boxes securely in place during transport.
- Swivel padlock attachment allows units to be locked for security (Padlock not included).
- Easy to install using pop rivets or sheet metal screws (fasteners not included).
- Chrome plate finish.

IBS No.	Dimensions (W x D x H in.)	Fits	Wt	Qty.
AJ312	Locking Hinge	4LR, 4LR-TT	1 lbs	1

Small Metal & Plastic Compartment Trays

- Prime cold rolled steel outer shell construction
- Full piano hinge on cover provides rigidity.
- Positive pull-down catch keeps cover tightly closed to prevent part migration.
- Handle allows for easy transport.
 - Durable gray powder finish.



24 HOLE SMALL TRAY

IBS No.	Dimensions (W x D x H in.)	Holes	Weight	Qty.
DS-24C	13-3/8 x 9-1/4 x 2	24	4 lbs	1
DS-24CU	13-3/8 x 9-1/4 x 2 USED	24	4 lbs	1



20 HOLE SMALL TRAY

IBS No.	Dimensions (W x D x H in.)	Holes	Weight	Qty.
DS-20C	13-3/8 x 9-1/4 x 2	20	4 lbs	1
DS-20CU	13-3/8 x 9-1/4 x 2 USED	20	4 lbs	1



16 HOLE SMALL TRAY

IBS No.	Dimensions (W x D x H in.)	Holes	Weight	Qty.
DS-16C	13-3/8 x 9-1/4 x 2	24	4 lbs	1
DS-16CU	13-3/8 x 9-1/4 x 2 USED	24	4 lbs	1

IBS, INCORPORATED

Cabinets T01



Small Metal & Plastic Compartment Trays



12 HOLE SMALL TRAY

IBS No.	Dimensions (W x D x H in.)	Holes	Weight	Qty.
DS-12C	13-3/8 x 9-1/4 x 2	32	4 lbs	1
DS-12CU	13-3/8 x 9-1/4 x 2 USED	32	4 lbs	1



ADJUSTABLE COMPARTMENT SMALL TRAY VERTICAL

IBS No.	Dimensions (W x D x H in.)	Holes	Weight	Qty.
AD-S	13-3/8 x 9-1/4 x 2	ADJ	4 lbs	1
AD-SU	13-3/8 x 9-1/4 x 2 USED	ADJ	4 lbs	1
AJ216	Dividers for AD-S (sold in pkgs of 9)		1 lb	9

Small Metal Racks & Accessories

- Sturdy construction using prime cold-rolled steel.
- Easy glide slides allow boxes to move in and out smoothly.
- Center braces on cradles provide extra rigidity.
- Boxes can be easily removed for transport to work areas.
- Reinforced rack keeps boxes level.
- Durable gray powder coat finish.



4 DRAWER SMALL RACK

IBS No.	Dimensions (W x D x H in.)	Drawers	Wt	Qty.
4SR	15-9/16 x 11-7/8 x 11-5/16	4	22 lbs	1
4SRU	15-9/16 x 11-7/8 x 11-5/16 USED	4	22 lbs	1



6 DRAWER SMALL RACK

IBS No.	Dimensions (W x D x H in.)	Drawers	Wt	Qty.
6SR	15-9/16 x 11-7/8 x 16-3/8	6	32 lbs	1
6SRU	15-9/16 x 11-7/8 x 16-3/8 USED	6	32 lbs	1



BASES FOR SMALL SLIDE RACKS

- Sturdy all steel construction.
- Raises units off the floor.
- Legs attach easily using fasteners (included).
- Durable black powder coat finish.

IBS No.	Dimensions (W x D x H in.)	Fits	Wt	Qty.
AJ315	15-7/8 x 12-1/8 x 15-1/8	4LR, 4LR-TT	12 lbs	1
AJ315U	15-7/8 x 12-1/8 x 15-1/8 USED	4LR, 4LR-TT	12 lbs	1

C
A
B
I
N
E
T
S
&
T
O
O
L
S



IBS, INCORPORATED

Cabinets T01

C
A
B
I
N
E
T
S
&
T
O
O
L
S

Metal & Plastic Compartment Trays and Racks



ADJUSTABLE COMPARTMENT SMALL PLASTIC TRAVEL TRAY

- Features IBS Logo on lid.
- Clear plastic for easy visual inspection.
- Locking hinges.
- Portable

IBS No.	Dimensions (W x D x H in.)	Sections	Wt	Qty.
17017	7-1/4 x 11 x 1-3/4	6 +ADJ	.8 lbs	1



STEEL RACK for PLASTIC TRAVEL TRAYS - GRAY ONLY

- Flexible offset handle prevents boxes from sliding out during transport.
- Holds up to 5 IBS Travel Trays
- Can be wall mounted, stacked or carried with removable handle.
- Keyhole slots in back allow for mounting on walls or panels.
- Durable gray powder coat finish.
- Dimensions: 11-1/4W x 6-3/4D x 10-3/4H

IBS No.	Dimensions (W x D x H in.)	Sections	Wt	Qty.
17057	7-1/4 x 11 x 1-3/4	6 +ADJ	.8 lbs	1

Specialty Storage: Aerosol Utility Cabinets



AEROSOL UTILITY CABINET

- Manufactured using prime cold rolled steel.
- All-welded construction prevents warping and twisting.
- Full piano hinges prevent door sag.
- Channeled shelves (AJ385) hold 88 standard aerosol cans.
- Pre-installed lock and 2 keys are included
- Key hole slots in back of unit for mounting.
- Durable black powder coat finish.

IBS No.	Dimensions (W x D x H in.)	Sections	Wt	Qty.
AJ386	33-3/4 x 11-7/8 x 23-7/8	2	40 lbs	1
AJ386U	33-3/4 x 11-7/8 x 23-7/8 USED	2	40 lbs	1



SMALL VERTICAL AEROSOL UTILITY CABINET

- Manufactured using prime cold rolled steel.
- All-welded construction prevents warping and twisting.
- Full piano hinges prevent door sag.
- 2 adjustable shelves are included.
- Holes in top and bottom allow secure stacking.
- Keyhole slots in back allow wall hanging.
- Built-in lock attachment.
- Durable black powder coat finish.

IBS No.	Dimensions (W x D x H in.)	Sections	Wt	Qty.
AJ382	13-3/4 x 12-3/4 x 30	Adjustable	31 lbs	1
AJ382U	13-3/4 x 12-3/4 x 30 USED	Adjustable	31 lbs	1



KEYS FOR CABINET

- Set of spare keys for locking cabinets.

IBS No.	Qty.
AJKEYS	1

Specialty Storage: Wire & Hose Racks



4 ROW WIRE SPOOL RACK

- Prime cold rolled steel construction.
- Includes 4 polished steel rods.
- Easy to store different sized spools on the same rod.
- Accommodates up to 10" diameter spools.
- Punched side panels allow quick spool changes.
- Ruled decal is supplied, making it easy to cut wire to tubing to the proper length.
- Keyhole slots are provided for wall mounting.
- Easy to assemble using fasteners provided.
- Durable black powder coat finish.

IBS No.	Dimensions (W x D x H in.)	Rows	Wt	Qty.
AJ368	26-1/8 x 5-7/8 x 36-1/2	4	18 lbs	1
AJ368U	26-1/8 x 5-7/8 x 36-1/2 USED	4	18 lbs	1



2 ROW WIRE SPOOL RACK

- Prime cold rolled steel construction.
- Includes 2 polished steel rods.
- Easy to store different sized spools on the same rod.
- Accommodates up to 10" diameter spools.
- Punched side panels allow quick spool changes.
- Keyhole slots are provided for wall mounting.
- Easy to assemble using fasteners provided.
- Durable black powder coat finish.

IBS No.	Dimensions (W x D x H in.)	Sections	Wt	Qty.
AJ384	26-1/8 x 5-7/8 x 21-1/2	2	11 lbs	1
AJ384U	26-1/8 x 5-7/8 x 21-1/2 USED	2	11 lbs	1



10 LOOP HOSE CLAMP RACK

- Manufactured using prime cold rolled steel.
- Holds 10 different diameters: Mini-clamp (7/32-5/8), Mini-clamp (5/16-7/8), #6, #10, #12, #16, #20, #28, #32, #36.
- Sign panel lists clamp diameters and hose ID's.
- Can be set on counter tops or hung on walls and panels.
- Durable black powder coat finish with black and white sign panel.
- Clamps not included.

IBS No.	Dimensions (W x D x H in.)	Loops	Wt	Qty.
AJ907	23-5/16 x 5-1/2 x 14-5/16	10	6 lbs	1
AJ907U	23-1/4 x 5-3/8 x 16-1/8 USED	10	5 lbs	1



5 LOOP HOSE CLAMP RACK FOR LARGE CLAMPS

- Manufactured using prime cold rolled steel.
- Holds 5 different diameters: #40, #48, #52, #56, #72.
- Sign panel lists clamp diameters and hose ID's.
- Can be set on counter tops or hung on walls and panels.
- Durable black powder coat finish with black and white sign panel.
- Clamps not included.

IBS No.	Dimensions (W x D x H in.)	Loops	Wt	Qty.
AJ910	23-5/16 x 5-1/2 x 14-5/16	5	6 lbs	1
AJ910U	23-1/4 x 5-3/8 x 16-1/8 USED	5	5 lbs	1



IBS, INCORPORATED

Cabinets T01

Specialty Storage: Rod, Bar & Tie Racks

C
A
B
I
N
E
T
S
&
T
O
O
L
S



3 SHELF HOSE CABLE AND TUBING CABINET

- Heavy duty all steel construction.
- Black powder coated finish and rust and acid resistant.

IBS No.	Dim. (W x D x H in.)	Shelves	Wt	Qty.
3HB	20 x 15-3/4 x 15	2 Fixed	45 lbs	1
3HBU	20 x 15-3/4 x 15 USED	2 Fixed	45 lbs	1



KEYSTOCK RACK

- Sturdy all steel construction.
- Holds keystock up to 3/4" square.
- Ten compartments.
- Keyhole slots allow for wall mounting.
- Durable black powder coat finish.

IBS No.	Dim. (W x D x H in.)	Holes	Wt	Qty.
AJ381	12-1/4 x 6-1/4 x 12	10	8 lbs	1
AJ381U	12-1/4 x 6-1/4 x 12 USED	10	8 lbs	1



THREADED ROD RACK

- Sturdy all-steel construction.
- Separates and protects threaded rods.
- (18) 2-1/16" diameter openings accommodate different sizes.
- Durable black powder coat finish.

IBS No.	Dim. (W x D x H in.)	Holes	Wt	Qty.
AJ367	24-1/8 x 6-7/8 x 24	18	16 lbs	1
AJ367U	24-1/8 x 6-7/8 x 24 USED	18	16 lbs	1

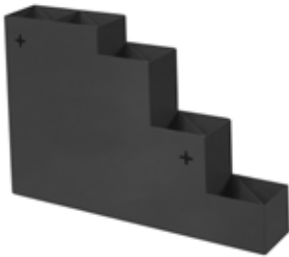

CABLE TIE RACK

- Sturdy all-steel construction.
- Each compartment is supplied with a removable divider to create from 5 to 10 compartments, for multiple tie lengths.
- Durable black powder finish
- Wall mountable.
- 18-5/32W x 3D x 12-1/4H

IBS No.	Dim. (W x D x H in.)	Holes	Wt	Qty.
AJ298	18-5/32 x 3 x 12-1/4	5-10	8 lbs	1



MAGNETIC DISPENSER FOR GLOVES

- **Magnetic glove dispenser** conveniently attaches to your toolbox or any ferrous metal.
- **Two large magnets hold the dispenser in place**, or mount it on a wall using screws.
- **Fits all common sizes** of disposable gloves,.
- **The dispenser has 3 adjusting springs** which can be adjusted as necessary **to hold the various box sizes.**
- Made of **powder coated steel.**

IBS No.	Description	Qty.
143865	Magnetic Dispenser for Gloves	1

IBS, INCORPORATED

Cabinets T01



Specialty Storage: Peg Racks & Miscellaneous



4-1/2" DISC DISPENSER

- **ORGANIZES CUT-OFF WHEELS:** Cut-off wheel dispenser allows wheels to be stored for easy access when needed.
- **HOLDS 4-1/2" WHEELS:** Dispenser will hold up to 48 Type 1 or Type 27 4-1/2" cut off wheels, up to 10 Type 27 Grinding Wheels with 7/8 arbor or 5 grinding wheels with 5/8-11 threaded arbor.
- **DURABLE CONSTRUCTION:** Powder-coated steel construction is tough and durable for long service life.
- **MADE IN THE U.S.A.**

IBS No.	Description	Qty.
17060	4-1/2" Disc Dispenser	1



MOLDED PLASTIC STORAGE CASES

- Durable molded plastic storage case.
- Locking hinge
- Portable

IBS No.	Description	Qty.
17018	4 Pc Hole Hog or Reamer Case	1
17335	10 PC EMPTY Hex Shank Drap Case	1
19376	EMPTY Box for Annular Cutters	1

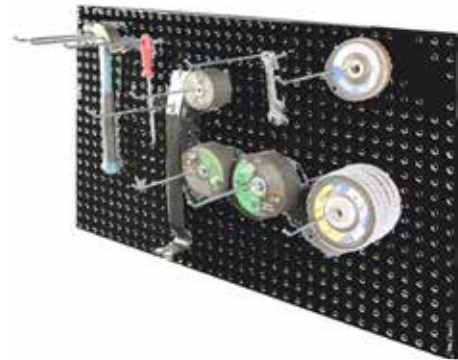
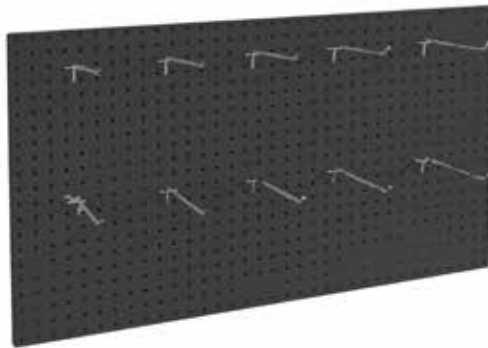

WALL MOUNTABLE PEGBOARD PANEL WITH (10) 8" HOOKS

- 18 Gauge, sturdy, formed steel.
- Hole punches allow for wall mounting.
- Peghole size is 1/4" and are spaced 1" apart.
- (10) 8" Pegboard hooks are included.
- Fully assembled and ready for use.
- Overall dimensions 34-3/4" W X 1" D X 20-1/3"H



IBS No.	Description	Qty.
AJ915	Wall Mountable Pegboard Panels with 10 Bin Hooks	1
AJ915H	8" Pegboard Hooks	1

C
A
B
I
N
E
T
S
&
T
O
O
L
S



IBS, INCORPORATED

Cabinets T01

Drill Dispensers & Organizers

C
A
B
I
N
E
T
S
&
T
O
O
L
S



17000, 17002

DRILL DISPENSERS

- **Dimensions: 14-5/8 W x 7-3/8" D x 7-3/4" H**
- Holds full packages of each size.
- Stackable for larger inventories.
- One piece drawer slide for long useful life.
- Decimal equivalents.

IBS No.	Description	Drawers	Wt	Qty.
17000	1/16th to 1/2" x 64ths drills	3	10.25 lbs	1
17001	#1 to #60 drills	5	10.25 lbs	1
17002	A to Z drills	3	10.25 lbs	1



17001



17008

FRACTIONAL TAP DISPENSER

- **Dimensions: 14-5/8 W x 7-3/8" D x 7-3/4" H**
- Holds popular **fractional sizes:** \
 - 1/4-20 NC, 1/4-28 NF, 5/16-18 NC, 5/16-24 NF, 3/8-16 NC, 3/8-24 NF
 - 7/16-14 NC, 7/16-20 NF, 1/2-13 NC, 1/2-20 NF, 9/16-12 NC, 9/16-18 NF
 - 5/8-11 NC, 5/8-18 NF, 3/4-10 NC, 3/4-16 NF, 7/8-9 NC, 7/8-14 NF, 1-8 NC, 1-12 NF
- Stackable for larger inventories.
- One piece drawer slide for long useful life.
- Finished with tough epoxy powder coating.

IBS No.	Description	Drawers	Wt	Qty.
17008	1/4 to 1" NC/NF Fractional Tap Dispenser	3	10.25 lbs	1



17015

TAP & DRILL DISPENSER

- **Dimensions: 14-5/8 W x 7-3/8" D x 7-3/4" H**
- Holds popular **Tap & Drill sizes:**
 - 6-32 (#36), 8-32 (#29), 10-24 (#25), 10-32 (#21), 1/4-20 (#7), 1/4-28 (#3), 5/16-18 (#24), 5/16-24 (I), 3/8-16 (5/16), 3/8-24 (Q), 7/16-14 (U), 7/16-20 (25/64), 1/2-13 (27/64), 1/2-20 (29/64).
- Stores and organizes correct drill with corresponding size tap.
- Stackable for larger inventories.
- One piece drawer slide for long useful life.
- Finished with tough epoxy powder coating.

IBS No.	Description	Drawers	Wt	Qty.
17015	Tap & Drill Dispenser	3	10.25 lbs	1



17024

METRIC TAP DISPENSER

- **Dimensions: 14-5/8 W x 7-3/8" D x 7-3/4" H**
- Holds 29 popular **Metric Tap sizes:**
 - 3mm x .50, 3mm x .60, 4mm x .70, 4mm x .75, 5mm x .80, 5mm x .90, 6mm x 1.00, 6.3mm x 1.00, 7mm x 1.00, 8mm x 1.00, 8mm x 1.25, 9mm x .75, 9mm x 1.00, 9mm x 1.25, 10mm x 1.00, 10mm x 1.25, 11mm x 1.50, 12mm x 1.25, 12mm x 1.50, 14mm x 1.25, 14mm x 1.50, 14mm x 2.00, 16mm x 1.50, 16mm x 2.00, 18mm x 2.50, 20mm x 2.50, 24mm x 3.00.
- Stackable for larger inventories.
- One piece drawer slide for long useful life.
- Finished with tough epoxy powder coating.

IBS No.	Description	Drawers	Wt	Qty.
17024	Metric Tap Dispenser	3	10.25 lbs	1



Drill Dispensers & Organizers



METRIC TAPS, DRILLS & DIES DISPENSER

- **Dimensions:** 14-5/8 W x 7-3/8" D x 7-3/4" H
- The dispenser for metric taps, drills and dies. From 2.5 x .45 tap to 12.0 x 1.75 tap:
Top Drawer: 2.5 x .45 tap - 2.05 drill & dies, 3.0 x .50 tap - 2.50 drill & dies, 3.5 x .60 tap - 2.90 drill & dies, 4.0 x .70 tap - 3.30 drill & dies.
2nd Drawer: 5.0 x .80 tap - 4.20 drill & dies, 6.0 x 1.0 tap - 5.0 drill & dies, 8.0 x 1.25 tap - 6.70 drill & dies.
3rd Drawer: 10.0 x 1.50 tap - 8.50 drill & dies, 12.0 x 1.75 tap - 10.20 drill & dies.
- Stackable for larger inventories.
- One piece drawer slide for long useful life.
- Finished with tough epoxy powder coating.

IBS No.	Description	Drawers	Wt	Qty.
17026	Metric Tap Drills and Dies Dispenser	3	10.25 lbs	1



METRIC DRILLS DISPENSER 1-13MM by 0.5

- **Dimensions:** 14-5/8 W x 7-3/8" D x 7-3/4" H
- Holds full packages of each size (12 PC Min).
- Stackable for larger inventories.
- One piece drawer slide for long useful life.
- Decimal equivalents
- Finished with tough epoxy powder coating.

IBS No.	Description	Drawers	Wt	Qty.
17031	Metric Drills Dispenser 1-10 mm by 0.5	3	10.25 lbs	1



FRACTIONAL WOODEN TAP STAND

- Easy storage and organization.
- Holds taper, plug and bottom taps.
- 4-40 - 1/2" sizes.

IBS No.	Description	Qty.
126539	Fractional Wooden Tap Stand	1



S & D REDUCED SHANK STAND

- Sturdy all steel construction.
- Holds Silver & Deming Reduced Shank drill bits.
- 1/2" to 1" by 64ths.

IBS No.	Description	Qty.
17019	S&D Reduced Shank Stand	1



IBS, INCORPORATED

Cabinets T01

Drill & Tap Indexes

CABINETS & TOOLS



IBS No.	Description	Size	Qty.
17003-BLK	13 Pc. Fractional Drills - Black	1/16" to 1/4" by 64ths	1
17004-BLK	15 Pc. Fractional Drills - Black	1/16" to 1/2" by 32nds	1
17005-BLK	29 Pc. Fractional Drills - Black	1/16" to 1/2" by 64ths	1
17006-BLK	26 Pc. Drill Index	A to Z	1
17007-BLK	60 Pc. Drill Index	No. 1 to No. 60	1
17009-BLK	18 Pc. Drill Index for Taps & Drills	--	1
17010-BLK	21 Pc. Drill Index	1/16th to 3/8" by 64ths	1
17012	8 Pc. S&D Drills	9/16" to 1" Steel Case	1
17013-BLK	115 Pc. Fractional, Letter, #, Black	--	1
17014	20 Pc. Drill Index	#61 - #80	1
17016	8 Pc Index for 1/4 Shank Tool	--	1
17021-BLK	10 Pc. NC & NF Taps - Black	1/4" to 1/2"	1
17022	10 Pc. NC Tap Index	4-40 through 5/8-11	1
17023	29 Pc. Stubby Drill Index	1/16" to 1/2" by 64ths	1
17025	4 Hole Spotweld Metal Index	--	1
17027	18 Pc. Metric Tap & Drill Index	2.5mm-2.05 to 12mm-10.20	1
17028	118 Pc Metric Drill Index	1MM to 13MM	1
17032-BLK	25 Pc. Metric Drill Index	1-10MM by .5MM	1
17041	15 Pc. Stubby Drill Index	1/16" to 1/2" by 32nds	1
17035	7 Pc Drill Pouch	—	1
17029	Handi-Bit Drill Index Mech Length Black		1
17030	Handi-Bit Drill Index Jobber Length Black		1
17039	Hi-Vis Handi-Bit Drill Index Mechanics Length Orange		1
17040	Hi-Vis Handi-Bit Drill Index Jobber Length Orange		1
17049	Cryo Red Handi Bit Drill Index Jobber Length Red		1
15913	Drill Gauge - Number Drills	#1 to #80 2"x5-1/4"x1/16"	1
15914	Drill Gauge - Fractional Drills	1/16" to 1/2" by 64ths 3"x 6"x1/16"	1



DRILL GAUGES
15913 — #1 to 80
15914 — 1/16" TO 1/2"



Drill & Tap Indexes



HANDI-BIT 29 PC DRILL INDEX

- Holds drill bits from 1/16" to 1/2" by 64ths.
- Screw-on hexagonal cover protects and contains drill bits.
- Water-resistant, great for outdoor job sites.
- Constructed of high impact, break resistant plastic.

IBS No.	Description	Holds	Qty.
17029	HANDI-BIT 29 Pc Drill Index - Mechanics Length BLACK	29	1
17030	HANDI-BIT 29 Pc Drill Index - Jobbers Length BLACK	29	1
17039	HANDI-BIT 29 Pc HI-VIS Drill Index Mech Length ORANGE	29	1
17040	HANDI-BIT 29 Pc HI-VIS Drill Index Jobbers Length ORANGE	29	1
17049	HANDI-BIT 29 Pc CRYO Drill Index Jobbers Length RED	29	1

Storage Containers

Sure Can Fuel Containers

SureCan fuel cans are **FM Approved**, meet **OSHA & MSHA** standards, **DOT compliant**, **UN approved**, accepted by the **EPA & CARB** and simply are the best fuel cans to use on the job, at home or out playing.

- **Patented spill proof technology** — uses gravity to dispense fuel from the bottom of the can, which means no bending, tipping, slipping or spilling for less mess, less waste and improved safety.
- **Thumb trigger to start, stop and control the flow** to eliminate spills and waste.
- **Flexible rotating nozzle** means no more tipping and easier dispensing.
- **Self-Ventilating action** enables a smooth flow without glugging — easy handling and **NO SPLASHING**.
- **Comfortable grip** is made to fit hands perfectly to make carrying easy for any user and less injury.
- **Child proof caps** for superior safety.
- **Durable — 6-layer, high density polyethylene design** protects vessel from punctures and cracking for extended life.
- **Stainless steel springs, aluminum rivets and viton seals** last longer, resist corrosion, and extend product life for maximum economy and value.



IBS No.	Description	Qty
SUR2SFG2	Sure Can 2.2 Gallon Container	1
SUR5SFG2	Sure Can 5 Gallon Container	1
SUR5SFD2	Sure Can 5 Gallon Diesel Container	1

Sphag Sorb 30 Gallon Storage Drum with Locking Lid

Description: 30 gallon UN/DOT-approved storage drum.



IBS No.	Description	Qty
SS-3D	Sphag Sorb 30 Gallon Storage Drum	1



IBS, INCORPORATED

Miscellaneous Tools T03

C
A
B
I
N
E
T
S
&
T
O
O
L
S

Select-A-Bit Security Driver

- Includes 14 security tips plus 2 standard tips on eight 3" double-ended bits.
- All bits store safely in the handle in separate bit compartments.
- When no bit is loaded, the nosepiece becomes a 1/4" nut driver.
- Extra long 3" nosepiece to reach even recessed fasteners.



BIT LOAD CHART

Hex	Spanner	Square	Torx	Phillips	Slotted
1/8	4		10		
9/64	6	1	15		
5/32	8	2	20	2	7/32
3/16	10		25		

IBS No.	Description	Qty
CA-141752	Select-A-Bit Security Driver	1

4-Way Chuck Key Caddies

Replace 8 Single Chuck Keys with 2 EZ-to-Find Key Caddies

Keys & Bodies are replaceable

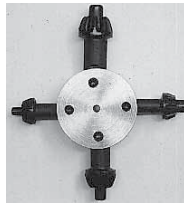

Combined these two caddies will fit a combination of 227 different chucks from 1/4" to 5/8".

LARGE 4-WAY DRILL CHUCK

IBS No.	Description
17051	Fits 100 different models in 3/8", 1/2", & 5/8" Fits Jacob Series: 3, 3A, 6A, 6B, 14H, 34, 55, 56, 634, 75, 11N, 32, 33, 3326, MC10, MC33, MC3326, 2A, MC5, 30, 31B, 8-1/2N, MC1.

SMALL 4-WAY DRILL CHUCK

IBS No.	Description
17052	Fits 127 different models in 1/4", 3/8", & 1/2" Fits Jacob Series: 1A, 1B, 1BS, MC, DC, H1, McU, 7A, 7BA, 7B, DC, H, MC, U

Flexible Extension



Flexible drive bit or drill bit extension holds any 1/4" hex shank bit to access tight or hard to reach areas. Can be used for drilling, driving, tapping or with any rotary tool with a 1/4" hex shank.

- Flexible extension flexes to a full 90 degrees allowing for access in tight and hard to reach areas saving time and money.
- Easy load quick disconnect provides fast and easy changeout of accessories and holds them in place eliminating lost tools.
- Outer cover does not rotate so it can be used safely at any speed and held by hand directing the operation exactly where it needs to be.
- 11" long for optimal reach and control.
- Rated for 13 ft.lbs. of torque makes this a powerful tool for most jobs.
- Can be used with standard 1" insert bits and power bits for added convenience and versatility.
- Standard 1/4" shank fits standard electric and cordless drills or screwdrivers.

IBS No.	Description	Qty
73614	Flexible Extension	1

IBS, INCORPORATED

Miscellaneous Tools T03



1/4" Air Die Grinder

- Designed for tight, tough quarter jobs that require fast metal removal.
- Very maneuverable and perfect for those hard-to-reach areas.
- 1/4" capacity collet with two collet wrenches included.



IBS No.	Description	RPM	HP
69282	1/4" Air Die Grinder	22,000	.33
69283	1/4" Air Die Grinder W/Regulator	25,000	.40

Grinder NOT for use with cut-off wheels over 3" in diameter. Refer to ASTM B7.1-2001

1/4" 90° Angle Air Die Grinder

- Great for tight or angled grinding jobs that an in-line die grinder won't reach.
- Rugged ball-bearing motor provides up to 22,000 RPM.
- Efficient rear exhaust air flow system is preferred by professionals everywhere.
- Lever throttle action and 90° angle provide mobility and control.
- Speed (RPM) 22,000.



IBS No.	Description	RPM	HP
127357	1/4" 90° Angle Air Die Grinder	22,000	.30

Grinder NOT for use with cut-off wheels over 3" in diameter. Refer to ASTM B7.1-2001

Professional Straight Handle Tap Wrench

- Solid construction for long life and ease of use.
- Straight handle design provides greater leverage, especially when using larger diameter taps.
- Ideal for hand tapping.



IBS No.	Description
120922	For Taps #0 to 1/2" (3mm to 12mm)
120923	For Taps #1/4" to 3/4" (6mm to 18mm)

Professional Hex Die Wrench

- Maintains alignment for accurate, straight threading.
- Dies easily lock in position with set screw.



IBS No.	Description
120925	For 1" Hexagon Dies
120926	For 1-7/16 Hexagon Dies

Tapping Tool & Guide

Perfect alignment provided for close tolerances and perpendicularity between the hardened sleeve of the tapper and the inside of the tapping guide.



- Stops tap breakage.
- Carbonitrided jaws for long life.
- Center drill on stem for floating center.
- Sliding T-Wrench Handle.
- 120° Vees on Aligner Body Base to accept round parts.
- Slotted body serves as wrench for tightening when changing jaws.

IBS No.	Description
17050	Tapping Tool & Guide

T-Handle Tap Wrench

- Designed for use with taps and on many other tools to be turned by hand.
- Adjusted and tightened to size by twisting knurled nut.
- Sliding T-Wrench Handle.
- Additional holding jaws are recessed and inside hole for tapping onto small sized taps.
- T-Handle may be extended full length in either direction for more leverage.
- Sliding T-handle has spring tension stop.



IBS No.	Description
120920	For Taps #0 to 1/4" (3mm to 6mm)
120921	For Taps #3/16 to 1/2" (4mm to 12mm)



IBS, INCORPORATED

Miscellaneous Tools T03

T-Handle Ratcheting Tap Wrenches

- Adjustable T-Handle may be slipped from side to side for positioning convenience and added leverage in tight spaces.
- It can be easily set for left or right handed operation, or locked for non-ratcheting use.
- Available in sizes to fit 1/16" up to 1/2" taps, and in extended lengths up to 12" for hard-to-reach areas.
- Designed for use with taps, reamers, screw extractors and other tools with a square shank.



IBS No.	Description
120930	1/16 -1/4 Ratcheting Tap Wrench
120931	1/4 -1/2 Ratcheting Tap Wrench
120932	1/16 -1/4 x 10 Ratcheting Tap Wrench
120933	1/4 -1/2 x 12 Ratcheting Tap Wrench

Transfer Punches

When you need to make identical holes in different pieces of metal, these punches mark the spot. They fit through existing holes and mark the center of the hole in a second workpiece. Punches are made of heat-treated and tempered steel and are approximately 4-7/8" long. Diameter tolerance is ± 0.0005 ".

Punch Sets come in a metal stand for easy storage and organization.



IBS No.	Size	Qty	IBS No.	Size	Qty	IBS No.	Size	Qty	
17346	3/32	1	17355	15/64	1	17364	13/32	1	
17347	7/64	1	17356	1/4	1	17365	27/64	1	
17348	1/8	1	17357	17/64	1	17366	7/16	1	
17349	9/64	1	17358	9/32	1	17367	27/64	1	
17350	5/32	1	17359	19/64	1	17368	7/16	1	
17351	11/64	1	17360	5/16	1	17369	29/64	1	
17352	3/16	1	17361	21/64	1	17370	15/32	1	
17353	13/64	1	17362	11/32	1				
17354	7/32	1	17363	23/64	1				
17345	28 Pc 3/32 - 17/32 Transfer Punch Set								1



Automatic Center Punch

IBS No. 141700

Automatic Center Punch delivers an automatic spring-driven strike when pressed down against a surface. Marks workpiece with a dimple, providing a starting point that prevents drill bits from wandering. Adjustable tensioner allows you to rotate the body of the center punch to regulate striking force. For use on various metals and woods. Hand operated, no hammer needed. Ball end for greater gripping power and reduced hand fatigue.

Features:

- Automatic spring-driven strike.
- Marks workpiece with a dimple.
- Prevents drill bits from wandering.
- Adjustable tensioner.
- Rotate body of center punch to regulate striking force.
- Use on various metals and woods.
- Hand operated.
- No hammer needed.
- Ball end for greater gripping power.

NES External Rethreading Tools



An essential tool for anyone who deals with nuts and bolts in: maintenance, construction, garages, plumbing, agriculture and engineering.

- Adjusts automatically to thread diameter & pitch.
- No measuring of thread required.
- Can be used on left and right hand threads.
- Can be used on both inch and metric threads.
- Two hardened steel blades (58RC) guided by the existing thread, regroove the damaged area.

Turn handle (A) to raise floating blades (B).

Place the tool over the thread to be repaired.



1 Open

Turn handle (A) to lower floating blades into grooves of thread and tighten by hand only.



2 Close

Turn the NES External fastener repair tool in the direction of the arrow.



3 Turn

NES 1 External Tool
IBS No. 99152



NES 2 External Tool
IBS No. 99162

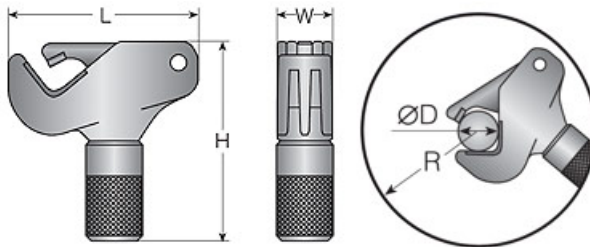

NES 1 EXTERNAL TOOL IBS No. 99152

NES 1	OD	Pipe	L	W	H	R
in.	5/32 to 11/16	up to 7/16	2-3/8	29/32	2-7/16	2-11/16
mm.	4-18		61	23	62	68

NES 3 External Tool
IBS No. 99163

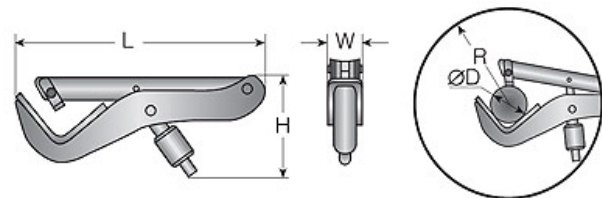

NES 3 EXTERNAL TOOL IBS No. 99163

NES 3	OD	Pipe	L	W	H	R
in.	1-1/4 to 5	1 to 4-1/2	12	1-3/4	5-1/8	9-7/8
mm.	32-128		305	44	130	250

NES 2 EXTERNAL TOOL IBS No. 99162

NES 2	OD	Pipe	L	W	H	R
in.	11/16 to 1-1/2	3/8 to 1-1/8	4-1/8	1-1/2	4-5/16	4-5/8
mm.	17-38		105	32	110	117



IBS, INCORPORATED

Miscellaneous Tools (T03)

C
A
B
I
N
E
T
S
&
T
O
O
L
S

NES Universal Thread Restorer 4 Pc Tool Kit



IBS No.	Description
122254	NES Universal Thread Restorer 4 Pc Tool Kit Contains all three NES Rethreading Tools. Replacement blades and internal thread cleaner tool included.

NES Internal Thread Cleaner / Restoring Tool



IBS No.	Description
122252	NES Internal Thread Cleaner Restoring Tool
122253	NES Internal Thread Cleaner Replacement Blades

NES Replacement Blades



IBS No.	Description
122249	NES1 Replacement Blades
122250	NES2 Replacement Blades
122251	NES3 Replacement Blades



iNES Internal Rethreading Tap



An essential tool for anyone who deals with nuts and bolts in: maintenance, construction, garages, plumbing, agriculture and engineering.

- Adjusts automatically to thread diameter & pitch.
- No measuring of thread required.
- Can be used on left and right hand threads.
- Can be used on both inch & metric threads.
- Hardened steel blade (62RC) guided by the existing threads, regrooves the damaged area.

Turn knurled knob (K) to fully retract the blade (B) into the housing. Insert iNES tool into the threaded hole or bore to be repaired.

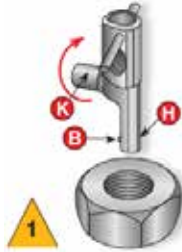

Turn knurled knob (K) to extend blade (B) into the thread groove on an undamaged section and tighten by hand only.



Rotate the iNES internal fastener repair tool by the cross rod, as shown, in the desired direction.

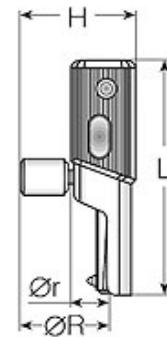
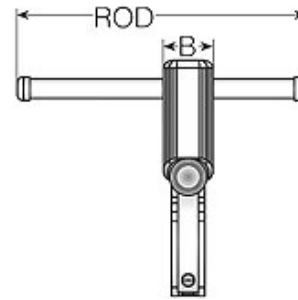

iNES #22 IBS No. 126294

iNES 22	OD	L	B	H	Rod	Or	OR
in.	1/2 to 5/8	4-5/8	11/16	1-3/4	5-3/8	11/16	1-9/16
mm.	12 to 16	109	18	45	136	17	39
pipes	1/4 - 3/8						

iNES #24 IBS No. 126296

iNES 24	OD	L	B	H	Rod	Or	OR
in.	7/8 to 1-1/4	5-3/8	1-1/16	2-1/2	6-3/8	1-1/16	2-1/8
mm.	22 to 32	136	27	64	161	27	54
pipes	1/2 to 7/8						

iNES #23 IBS No. 126295

iNES 23	OD	L	B	H	Rod	Or	OR
in.	11/16 to 13/16	4-3/8	13/16	2-1/16	5-3/4	13/16	1-3/4
mm.	16 to 20	111	21	53	146	20	45
pipes	3/8 - 1/2						

iNES #25 IBS No. 126297

iNES 25	OD	L	B	H	Rod	Or	OR
in.	1-1/4 to 2-1/8	6-7/16	1-1/2	3-3/16	7-9/16	1-3/8	2-7/8
mm.	32 to 54	163	38	81	192	35	62
pipes	7/8 to 1-3/4						



IBS, INCORPORATED

Miscellaneous Tools (T03)

C
A
B
I
N
E
T
S
&
T
O
O
L
S

3 Pc iNES Internal Set



IBS No.	Description
126302	Contains #22 Small, #23 Medium & #24 Large iNES tools. Replacement blades included.

3 & 6 Pc NES Internal & External Tool Sets



IBS No.	Description
126303	Contains NES 1A Small External Tool, #21 Small & #22 Medium iNES Internal tools. Replacement blades included.
126304	Contains NES 1A Small & #2 Large External Tools, #21 Small, #22 Small, #23 Medium & #24 Large iNES Internal tools. Replacement blades included for internal tools.

iNES Replacement Blades



IBS No.	Description
126298	iNES #22 Replacement Blades
126299	iNES #23 Replacement Blades
126300	iNES #24 Replacement Blades
NS-126301	iNES #25 Replacement Blades

ThreadMate™ Set & External Tool



- Fixes any thread in diameter between M5-M12 (#12 - 1/2") internal and M4-M13 (5/32" - 1/2") external.
- A great solution for outdoor technicians, industrial maintenance, workshops, auto garages, marine use, farmers, auto mechanics, professional and hobby users, etc.
- Small size fits any toolbox.
- External thread repair tool repairs and restores external threads.
- Easy to use set with built-in knob — just set and turn.
- Kit contains replaceable nylon pads for soft metal repair jobs.
- Clean thread in both ways - inside out, or outside in.
- Easy to operate, no special thread knowledge required — works on USS, SAE, Metric, Fine, Coarse, etc.

IBS No.	Description	Qty
126290	MINI ThreadMate™ Kit	1
126292	MINI ThreadMate™ External Tool	1
126291	Replacement Blades Ext. Tool 1 pr.	1



Spin-It-Out Damaged Screw Removers

The perfect tool for removing stripped and broken or damaged screws. The Spin-It-Out Damaged Screw Remover is extremely easy to operate. A Spin-It-Out extractor bit and a drill motor in reverse make light work of removing stripped out Phillips, Torx, Square Drive, Posi-Drive or even Tri-Wing head screws.

- Removes stripped and broken screws, saving time and money.
- The serrated design on the tip aggressively bites into damaged screws or drills into broken bolts helping to make broken screw removal faster and easier.
- Made of high quality M2 high speed steel for exceptional strength, making them strong enough to drill into hardened bolts.
- Number size corresponds with the number sizes of Phillips Head Screws.



IBS No.	Description	Qty
133310	Spin-It-Out 5 Pc Set	1

SPIN-IT-OUT REPLACEMENT BITS

IBS No.	Description	Qty
133311	#0 Spin-It-Out Extractor Bit	1
133312	#1 Spin-It-Out Extractor Bit	1
133313	#2 Spin-It-Out Extractor Bit	1
133314	#3 Spin-It-Out Extractor Bit	1
133315	#4 Spin-It-Out Extractor Bit	1

Power-Outs™ Double Edged Screw Extractors

These patented double-edged screw extractors are made from hardened chrome vanadium steel with a burnished finish. The cutting edges are polished, and the part number and dimensions are laser marked on the shank for easy identification.



IBS No.	Size	SW Diam (in)	Drill Diam (in)		Screw Size (in)	
			Min	Max	Min	Max
139501	1	1/4	1/8	3/16	3/16	1/4
139502	2	3/8	3/16	9/32	5/16	3/8
139503	3	1/2	1/4	3/8	7/16	1/2
139504	4	5/8	11/32	1/2	1/2	9/16
139505	5	3/4	7/16	5/8	5/8	3/4
139506	6	7/8	9/16	3/4	7/8	1
139507	7	1	3/4	15/16	1	1-1/8
139395	5 Pc Set (Sizes 1-5 in a plastic pouch)					

Power-Outs™ Sets



IBS No.	Description
670P	5 pc Power Outs & 8 Pc LH Drill Extractor Set (1/16, 1/8, 3/16, 1/4, 5/16, 3/8, 7/16, 1/2)
745R	5 pc Power Outs Travel Tray w/Corresponding LH Drill Bits (5/32, 1/4 5/16, 7/16 & 1/2)
818R	5 pc Power Outs Travel Tray w/Corresponding LH Stubby Drill Bits (5/32, 1/4 5/16, 7/16 & 1/2)

CABINETS & TOOLS



IBS, INCORPORATED

Screw Extractors P09

C
A
B
I
N
E
T
S
&
T
O
O
L
S

Hex Head Spline Drive Screw Extractors (P09)

- Designed to remove broken studs, bolts, socket screws and fittings.
- For use with sockets and flat wrenches.
- Made in the U.S.A.



IBS No.	Size	Hex Hd Size	Bolt Dia.	Drill Bit Dia.
53201	1/8	1/2	#12	1/8
53202	5/32	1/2	1/4	5/32
53204	7/32	1/2	3/8	7/32
53205	1/4	1/2	7/16	1/4
53206	9/32	1/2	1/2	9/32
53207	5/16	1/2	9/16	5/16
53208	11/32	1/2	5/8	11/32
53209	3/8	1/2	11/16	3/8
53210	13/32	1/2	3/4	13/32
53211	7/16	5/8	13/16	7/16
53213	1/2	5/8	15/32	1/2
53217	5/8	3/4	1-3/16	5/8
53220	23/32	7/8	1-3/8	23/32
53225	7/8	1	1-11/16	7/8

25 Piece Hex Hd Spline Drive Screw Extractor Set

- Sizes 1/8" - 7/8"
- Designed to remove broken studs, bolts & socket screws from #12 - 1-3/4"
- For use with sockets and flat wrenches
- Packaged in a sturdy red plastic box for easy storage and organization
- Made in the U.S.A.



IBS No.	Description
53227	25 Pc. Hex Head Spline Drive Screw Extractor Set

Golden Grip™

INTERNAL PIPE WRENCHES

No more busted knuckles, broken pipes or ruined walls. Golden Grip™ is the world's only self-locking, reversible internal pipe wrench that installs or extracts pipe nipples quickly and easily. Golden Grip is used with ratchets, extensions, and impact wrenches, making it easier to work in tight spaces.

Available in single grip sizes for 1/2" to 3/4" pipe, and double grip sizes ranging from 1" to 2" for Schedule 40 Pipe.

REVOLUTIONARY DESIGN

- Designed and manufactured from heat tempered steel to meet the demanding specifications of the professional tradesman.
- Each tool is individually inspected and assembled to assure the finest quality.
- Use on iron, chrome, and brass pipe - won't scar chrome!
- Self-locking and reversible.
- Will not damage threads.



IBS No.	Description	Qty
97250	1/2" Single Size	1
97251	3/4" Single Size	1
97252	1" & 1-1/4" Dual	1
97253*	1-1/2 & 2" Dual (* non-stock item)	1
97256	Set of all 4	1

5 Pc. 3/8" Drive Bolt/Stud Extractor Set

5/16" to 3/4"



IBS No.	Description
54115	Removes bolt sizes: 8mm, 10mm, 13mm, 19mm, 5/16, 11/16, & 3/4" in drive size 3/8"

GrabitPro®

Damaged Screw Remover

The GrabitPro quickly and easily removes most damaged screws such as Hex, Phillips, Torx, and Square Drive from wood, plastic or metal up to 3 inches in length. The serrated extracting end of the tool results in greater torque for hard to remove bolts and screws. The design of the shaft make them compatible with "quick change" chuck systems or can be chucked directly into a drill. Good for multiple extractions with a single tool.

FEATURES & BENEFITS

- The two ended design with a drill bit and extractor in one tool eliminates the need for multiple tools saving time and money.
- There is no bolt preparation required, such as grinding, smoothing, cutting, center punching or pre-drilling, making for a faster and more convenient repair.
- Self-centering drill tip eliminates walking or wandering, saving time and frustration.
- Works on jagged, uneven, and rough breaks where standard drills could chip or break.
- Tempered twice for extra hardness proving a tools with a longer life resulting in multiple extractions per tool saving time and money.
- Four (4) piece kit. Removes screw sizes AN4 to AN24, bolt sizes SAE 10 to 12, 1/4", 5/16", and 3/8" (Metric M5 to M10).
- Made in the U.S.A.



IBS No.	Description	Qty	For Screw Sizes
133318	#1 Grabit Pro	1	No. 4 to No. 7
133319	#2 Grabit Pro	1	No 8 to No. 10
133320	#3 Grabit Pro	1	No. 11 to No. 14
133321	#4 Grabit Pro	1	No. 16 to No. 24

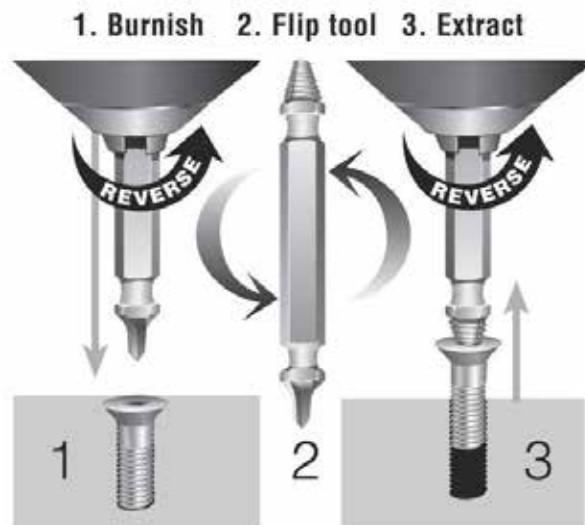

OPERATING INSTRUCTIONS

Burnishing

1. Insert GRABIT directly into drill or chuck - burnishing end is showing.
2. Set drill for reverse.
3. Place burnishing end of tool into damaged screw head until smooth.
4. NOTE: Burnishing end is not to be used to drill a hole.

Removing

1. Remove burnishing end from chuck, flip tool, replace into drill chuck — Remover end now showing.
2. Maintain reverse setting.
3. Place Remover end of tool into now smooth screw head.
4. Apply firm downward pressure, drill at slow speed. Apply lowest level of power to the hand drill.
5. Remover end of GRABIT will thread into screw head and remove.

WARNING:

Always wear safety glasses when operating or near power tools. Cutting tools may shatter when broken.



IBS, INCORPORATED

Assortments Z02

Grabit Damaged Screw Remover & DriveGrip Assortment

IBS No. 794R 5 Items • 5 Pcs

Packaged in a locking plastic travel tray for easy storage & organization

C
A
B
I
N
E
T
S
&
T
O
O
L
S

				Grabit Damaged Screw Remover and DriveGrip Assortment	
Assortment 794R					
<p>133318 #1 GRABIT PRO</p>  <p>For Screw Sizes: No. 4 - No. 7, Bolt Size: No. 10 (5mm)</p> 	<p>133319 #2 GRABIT PRO</p>  <p>For Screw Sizes: No. 8 - No. 10, Bolt Size: 1/4" (6mm)</p> 	<p>133320 #3 GRABIT PRO</p>  <p>For Screw Sizes: No. 11 - No. 14, Bolt Size: 5/16" (8mm)</p> 	<p>133321 # 4 GRABIT PRO</p>  <p>For Screw Sizes: No. 16 - No. 24, Bolt Size: 3/8" (10mm)</p> 	<p>52010 DRIVE GRIP ANTI CAM-OUT FLUID .5FL OZ</p>  	

Grabit® Drill-Out Broken Bolt Extractor Set

Removing stripped screws and bolts can be a frustrating experience, and now there's a solution! This 4 Pc. extractor kit removes broken bolts from as small as 1/4" to 1/2" (6mm-12mm) and can drill up to Grade 8 or 10.9 class fasteners. Each Drill-Out is a drill bit and extractor in one and is uniquely designed to drill into the rough surfaces when bolts break.

SINGLE STEP EXTRACTION FAST & EASY TO USE

A drill bit and extractor in one tool, the DRILL-OUT creates a unique interaction between drill bit and extractor, resulting in maximum impact and break out ability. Broken bolts and studs are removed quickly and easily without damaging the fastener threads.

- **Unique drill tip** allows the tool to stay on center
- **Self centering drill tip** eliminates walking or wandering.
- **No grinding, center punching or pilot hole** required.
- **Works on** jagged, uneven and rough breaks.
- **Tempered twice for extra hardness**; resulting in multiple extractions per tool.
- **Made from the highest quality M2 HSS Steel.**
- **MADE IN THE USA.**



USE IN REVERSE ONLY WHILE DRILLING OR EXTRACTING

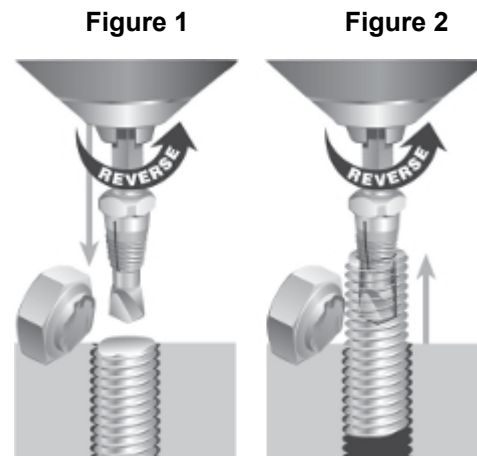

DRILLING:

1. **Choose the correct size DRILL-OUT.**
2. **Secure round end in the drill chuck and tighten.**
3. **Thread collet/extractor back against drill chuck.**
4. **Set drill in reverse and begin drilling a the suggested RPM's. (See Figure 1)**
5. **Tempered twice for extra hardness**; resulting in multiple extractions per tool.z
REMEMBER: Hole must be straight & on center. DO NOT allow collet/extractor to move down toward tip while drilling.
6. **Made from the highest quality M2 HSS Steel.**
7. **MADE IN THE USA.**

IBS No.	Description	Qty
133309	Grab-It Drill Out Extractor 4 Pc Set 1/4" to 1/2" (6mm to 12mm)	1



IBS, INCORPORATED

Tools (T03)

External Deburring Tools 3Pc Set (T03)

IBS No. 476P



- Quickly repairs damaged threads from 7/64" to 2-1/3".
- Hardened HRC 60 Steel blades remove burrs and uneven ridges from threaded rods, pipes and more.
- Works on hardened and mild steels, Grade 8 fasteners, stainless steel, brass copper, aluminum, plastics, wood, etc.
- 1/4" hex shank attaches to your drill quickly.
- Most effective at low speeds — recommended speed should not exceed 500 RPM in a clockwise direction only.

IBS No.	Description	Shank	Qty
51951	Small Deburring Tool 7/64" to 7/16"	1/4"	1
51950	Medium Deburring Tool 5/16" to 7/8"	1/4"	1
51952	Large Deburring Tool 23/32" to 2-1/3"	3/8"	1
476P	3 Piece Set - Deburring Tools		1



REMOVE BURS

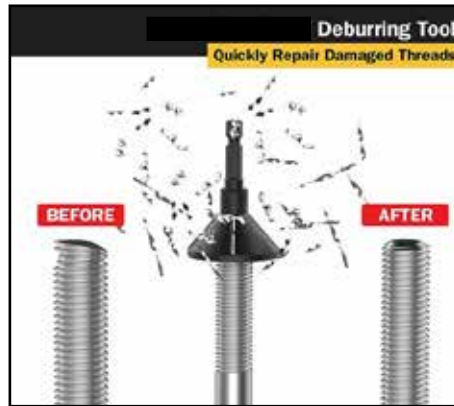

REPAIR DAMAGED THREADS



WORKS ON A VARIETY OF MATERIALS

Nicholson® Pro Series 4-in-1 Hacksaw Frame

Ideal for making flush, Sideways & Angle Cuts in Metal, Pipe & Tubing



The Nicholson® Pro-Series 4-in-1 hacksaw takes versatility and quality to an entirely new level. Its frame is designed to hold blades at a tension of up to 30,000 psi, for smooth straight cuts, whether in standard, 45° angle, or low profile configurations. And while some other hacksaws have jab saw capability, the unique design of the Nicholson Pro Series accommodates a heavy duty reciprocal saw blade for maximum performance in jab saw applications.

Four Ways to Get the Job Done!



IBS No.	Description	Qty
16411	4-in-1 Hacksaw Frame	1



Reciprocating Saw Handle

- Instantly turn any standard reciprocating saw blade into a hand saw!
- Ergonomic handle with angled setting for additional leverage.
- Quick-twist lock securely holds any standard reciprocating saw blade or any 1/4" hex shank bit.
- Converts to a multi-bit screwdriver — handle stores 6 of the most popular bits: #5 & #6 Slotted, #1 & #2 Phillips and T15 and T20 Torx.
- Use to cut metal, wood, drywall and much more.



IBS No.	Description	Qty
44600	Reciprocating Saw Handle	1

Heavy Duty Metal Scraper



- Protective cap keeps the blade covered until it is in use. The cover then snaps on the back of the scraper to keep from losing or misplacing the cap.
- Ergonomic grip for better control.
- No push-button slide to expose the blade which often causes the blade to slide back when in use.
- Includes one standard straight razor blade for added value and allows the scraper to be used immediately.
- Perfect for scraping labels, decals, paint and adhesive from glass and other surfaces.

IBS No.	Description	Qty
16400	Heavy Duty Metal Scraper	1

Snips & Shears (P11) Fiskars® PowerArc Utility Snips (8")

- PowerArc™ Utility Snips boast **intelligently curved blades** that alter the angle between the blades to give you over 2X more power, especially during the toughest part of the cut.
- **Offset design** with heavy-duty stainless steel blades can be used to cut materials from above or below, keeping waste material away from your hand.
- An **ergonomic, spring-assisted handle** helps reduce hand fatigue and features Softgrip® for enhanced dexterity and comfort.
- A **serrated edge, extended tang and bolted joint** improve control and durability.



IBS No.	Description	Qty
16420	Fiskars PowerArc™ Utility Snips	1

Fiskars® PowerArc Easy Action Shears (10")

- PowerArc™ Easy Action Shears™ boast **intelligently curved blades** that alter the angle between the blades to give you over 2X more power, especially during the toughest part of the cut.
- A radically **ergonomic, spring-assisted handle** features an open top loop, allowing you to rotate your hand over the handle to apply more power, especially during the toughest part of the cut.
- In addition, **Softgrip®** enhances dexterity and comfort, a bigger bottom loop fits large gloved hands and an easy-open lock protects the blades during transport.
- **Heavy-duty coined stainless steel blades** help prevent separation.
- A **serrated edge, extended tang and bolted joint** improve control and durability.



IBS No.	Description	Qty
16421	Fiskars PowerArc™ Easy Action Shears	1



IBS, INCORPORATED

Miscellaneous Tools (P11)

C
A
B
I
N
E
T
S
&
T
O
O
L
S

Fiskars® PowerGear Plastic Pipe Cutter

- **PowerGear® technology** gives you over 35% more power to make cutting plastic pipes easier, while eliminating the need for ratcheting.
- This ingenious technology features a gear that provides more power during the toughest parts of the cut.
- **Replaceable stainless steel blades** cut from start to finish in a single, smooth stroke, while a tough stainless exoskeleton maximizes durability.
- An **ergonomic, spring-assisted handle** helps reduce hand fatigue and features Softgrip for enhanced dexterity and comfort.
- An **easy-open lock** simplifies usage while cutting a range of plastic pipes, including up to 1-1/4" O.D. PVC.



IBS No.	Description	Qty
16422	Fiskars PowerGear Plastic Pipe Cutter	1
16423	Replacement Blade for Fiskars PowerGear Plastic Pipe Cutter	1

IBS "Rapid Razor" Utility Knife



- Autoloading design
- One-button blade change
- Ergonomic rubber grip
- Heavy duty die cast body
- Holds any standard utility or hook blade
- No tools needed
- 5 blades included



IBS No.	Description	Qty
16402	IBS "Rapid Razor" Utility Knife	1

HD Retractable Blade 8 Pt. Breakaway Knife



- Steel blade track.
- Auto-locking
- High-visibility yellow.
- Comes with premium steel blades.
- Accepts all standard 8 point blades.
- Spare blade compartment.
- Ideal for cutting cardboard, wood, leather and more.
- For replacement blades use IBS No. 16409

IBS No.	Description	Qty
16403	HD Retractable Breakaway Knife	1

Cartridge Loading Snap Knife with Rubber Grip



- Autoloading design
- Blade cartridge w/6 premium 8 pt blades
- Ratchet wheel for blade stability
- Ergonomic rubber grip
- Auto-locking
- For replacement blades use IBS No. 16409



IBS No.	Description	Qty
16408	Cartridge Loading Snap Knife	1

IBS, INCORPORATED

Miscellaneous Tools (P11)



Revo Folding Knife



- Comfort-grip finger loop for added safety and control.
- Two position cutting.
- 50% more blade-edge exposed for deeper cutting.
- Quick-change blade replacement.
- Metal belt clip.
- Use with IBS No. 16407 IBS Rapid Razor 100 BLADES/PK (purchase separately).

IBS No.	Description	Qty
16416	Revo Folding Knife	1

SHARK Heavy Duty Combination Utility Knife

The SHARK Heavy-Duty Combination Utility Knife is two tools in one, a utility knife and a wire cutter, stripper and crimper. With a wide variety of features, this multi-function tool will get the job done faster, safer and easier.

- Rugged, professional grade construction with a comfortable, ergonomic grip.
- Has its own patented RAPID EDGE serrated blades that are built to last. The blades withstand longer use because the cutting friction is handled by five individual cutting surfaces, other blades only have one straight edge.
- Slide 'n' Lock technology allows you to adjust the amount of the blade that is exposed for precise cutting.
- Extra blades can be stored within the holder and a quick change design allows you to efficiently remove an old blade and replace it with a new one.
- When you're ready to work with wire, a spring loaded wire cutter opens easily and cuts comfortably, which locks securely into the body of the knife when you are done. The precision ground stripping holes easily remove insulation from thick 10 to 18 gauge wires.



IBS No.	Description	Qty
16414	SHARK Combination Utility Knife	1
16415	100 PK Shark Serrated Blades	1

C
A
B
I
N
E
T
S
&
T
O
O
L
S



IBS, INCORPORATED

Miscellaneous Tools T03

C
A
B
I
N
E
T
S
&
T
O
O
L
S

Magnetic Drill Press

- The optimal drilling speed designed for use with carbide and hss cutters on the toughest jobs and applications.
- Effective solution for drilling harder materials.
- Powerful magnet for easier placement and better holding power on thinner material.
- Cost effective drill for running with carbide cutters for longer life, higher cutting rate and capable of cutting harder materials.
- 1-3/8" MAX diameter annular cutter.
- 2" maximum drilling depth.
- 15.75" Height, 1100W, 11.5 Amp, 450-590 RPM.



IBS No.	Description
19467	Magnetic Drill Press up to 1-3/8 - 2"
19456	Arbor Adapter
19457	Drill Chuck

Compact Magnetic Drill Press

Compact with Fixed Drill Motor for Work in Confined Spaces

- **Extremely compact** with ideal power to weight ratio for work at heights and in confined spaces.
- **Hand feed wheel mounts** on either side for use in special situations.
- **Die cast aluminum housing** for strength in the field.
- **Internal motor cable routing** prevents unintended threading or hanging up on the workpiece.
- Internal Cooling.
- **Easy** guide adjustment.
- **Stationary** drill motor.
- **Quill feed spindle** eliminates field maintenance and adjustments provides positive slug ejection.
- 1-5/8 maximum diameter annular cutter.
- 2" maximum drilling depth.



IBS No.	Description
19468	Compact Magnetic Drill Press for 1-3/8 - 2"

Variable Speed / Reversible Magnetic Drill Press

Universal with 2 Speed Gearbox

For Use with 1-9/16 to 2" Annular Cutters

Compact with high functionality for universal use on the construction site and in the workshop.

- Simple and error-proof control concept in the operator's field of view.
- **Double drill motor guides** enable use of the largest core bits.
- **Reversible.**
- **Electronic speed control.**
- **High power motor** with stable speed.
- **High magnetic holding force.**
- Convenient magnetic holding force gauge.
- **Integrated cooling tank.**
- **Hand feed wheel** can be mounted on either side.



IBS No.	Description
19469	Variable Speed / Reversible Magnetic Drill Press

Slugger Cutting Fluid for Mag Drills



- Water soluble concentrate makes up to 10 quarts of cutting fluid.
- Improves surface finish and reduces heat build up when drilling — extending the life of the cutter.
- Specially designed packaging with a sight window ensures proper mixing ratios.

IBS No.	Description
19463	Slugger Cutting Fluid for Mag Drills 1 Quart
19464	Slugger Cutting Fluid for Mag Drills 1 Gallon

Circular Saws (T03)

- Increase Productivity — No milling or deburring with near surgical dry-cut technology.
- Cuts a variety of Metals, Plastic and Wood.
- Cool to the Touch — No waiting for your workpiece to cool down.
- Precise Cutting — with integrated laser sighting system (7-1/4" saw only).



Circular & Chop Saw Blades Sold Separately

7-1/4" CIRCULAR SAW

SPECIFICATIONS	7-1/4"
Part Number	137759
Cutting Capacity	2-1/4"
Weight	15 lbs.
Blade Diameter	7.25"
Arbor	3/4" (20mm)
RPM	3800
Beveling/Mitering	Beveling / 45°
Motor	120V / 1400W
Depth Adjustment	Yes
Chip Cover	1 Cover for Metal
Applications	Pipe, plate, channel, grating, roof decking, silos, emergency rescue.

- Powerful double-insulated motor for continuous loads
- Internally powered laser (no batteries required)
- Spring loaded lower guard
- Integrated chip collection
- Soft Start
- Electric Brake
- Smooth bevel and angle cutting adjustments
- Well balanced handle design for better control

INCLUDES: 1 tool case, 1 blade, 1 wrench, 1 guide plate, 1 safety eyewear, 1 ear protection, 1 instruction manual

DO NOT USE on materials thicker than 3/8" solid for aluminum, 5/16" for mild steel, or 1/4" for solid stainless steel.

14" CIRCULAR SAW

SPECIFICATIONS	14"
Part Number	137760
Cutting Capacity	4-3/4"
Weight	54 lbs.
Blade Diameter	14"
Arbor	1" (25.4mm)
RPM	1300
Beveling/Mitering	Mitering / 45°
Motor	120V / 1800 W
Depth Adjustment	Two Position Vise
Chip Cover	Chip Tray
Applications	Pipe, plate, channel, conduit angle iron, metal studs, rebar, tubing, etc..

- Low speed high torque motor
- High Precision durable steel construction
- Cast aluminum base
- Quick release table/base clamp cuts 0o to 45o
- Smooth bevel and angle cutting adjustments
- Eye protection plate
- Table/base clamp with quick release
- Depth stop
- Well balanced handle design for better control
- Integrated chip collection

INCLUDES: 1 tool case, 1 blade, 1 wrench, 1 guide plate, 1 safety eyewear, 1 ear protection, 1 instruction manual

DO NOT USE on materials thicker than 3/8" solid for aluminum, 5/16" for mild steel, or 1/4" for solid stainless steel.



IBS, INCORPORATED

Miscellaneous Tools (T03)

C
A
B
I
N
E
T
S
&
T
O
O
L
S

Excalibur Butane Solder Torch Kit



A self-igniting and cordless Soldering Iron, Hot Air Blower and Butane Torch complete in 1 great tool! The Piezo electric instant ignition system provides a quick start-up in any mode.

Includes a wide range of tips, wrench, sponge and a tube of solder for all your needs.

Includes a handy, impact-resistant travel case for complete mobility, moves easily from the workshop to the field. Case holds everything cleanly for quick, hassle-free storage.

IDEAL for: Electronic System Repair, Automotive, Industrial, Woodworking, Lapidary, Optical, General Maintenance and Professional Repair Jobs.

IBS No.	Description
141060	Excalibur Solder Torch Kit

Microtorch Butane Torch

At only 5-1/4" high with a 2500°F flame, the MICROTORCH is ideal for all types of professional use. Refillable with premium grade butane (IBS No, 95007 - 42 grams). A versatile and handy addition to any professional workshop.



IBS No.	Description
125738	MICROTORCH Butane Torch

Industrial Butane Torch

Powerful, portable, refillable and anti-flare with a flame temperature of over 2500°F, the INDUSTRIAL TORCH is ideal for automotive, plumbing, and professional repair shop use.

Functions & Uses: Lead Gutters, Toughen Metal, Sweat Fittings & Joints, Loosen Bolts, Stripping Paint, Dry Cements, Automotive, Repair, Plumbing, Lay or Remove Tiles & Professional Use.



IBS No.	Description
125739	Industrial Butane Torch

Butane Refill

- Universal tip fuels most leading butane lighters
- Low in non-volatile contaminants which can cause burner valve to clog, affecting flame height and function.



WARNING: USE THIS PRODUCT ONLY AS DIRECTED ON THE PACKAGE.

INTENTIONAL MISUSE BY DELIBERATELY CONCENTRATING AND INHALING THE CONTENTS CAN BE HARMFUL OR FATAL.

KEEP OUT OF REACH OF CHILDREN. DO NOT DISTRIBUTE TO MINORS.

IBS No.	Description
95007	BUTANE Refill 75 ml

Dual Temp Electric Heat Gun

A general purpose heat gun that is ideal for most heating applications, including applying heat shrink tubing, stripping paint, thawing pipes and loosening floor tile.

- 2 temperature settings (750°F & 1000°F) for versatility & various applications.
- 4100 BTU output for removing multiple layers of paint.
- 1200 Watts make this a powerful heat gun.
- Measures 16.5 x 9.8 x 17 inches



IBS No.	Description
141096	Dual Temp Electric Heat Gun
141305	Concentrator Nozzle
141306	Flare Nozzle
141307	Glass Protector Nozzle

IBS, INCORPORATED

Miscellaneous Tools T03



Universal Crimping Tool

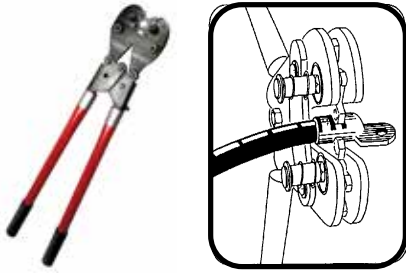

- Double Compound Action effortlessly exerts maximum force for fast, reliable crimps every time.
- Rotating Dies accommodate all sizes of battery terminals, lugs and connectors eliminating loss or need to store individual dies.
- Diamond Shape Crimp compresses all strands together to form a solid mass of copper. This assures a low resistance connection every time.
- Easy To Use Reference Chart located on tool eliminates guess work enabling competitive products to be crimped accurately.
- Wire Range : #8 Gauge through 250 MCM.

IBS No.	Description
B0283	Universal Crimping Tool

High Capacity Hydraulic Crimper



High Capacity Hydraulic Crimper creates strong mechanical connections with crisp and sharp corners. The powerful hydraulic action delivers 70kN (15,736 Lbf) of force for **secure crimps**. This crimper includes 8 hardened steel die sets, and is ideal for battery and welding cables.

- Powerful hydraulic action delivers nominal force of 10 tons for secure crimps.
- Ideal for battery and welding cables.
- Creates strong mechanical connections with crisp and sharp corners.
- Features non-slip handle and ON/OFF retractor knob for safety.
- Includes 8 hardened-steel die sets from #6 to 4/0 AWG.

IBS No.	Description	Qty
141981	High Capacity Hydraulic Crimper	1

Battery Cable Stripper

- Wire Range: 8 GA to 4/0
- Length: 3-3/4 inches



IBS No.	Description
B0285	Battery Cable Stripper

Indent Crimper

- Wire Range: 8 Ga. to 4/0
- Length : 3-3/4"



IBS No.	Description
B0840	Indent Crimper

Cable Cutter

- Wire Range: 8 Ga. to 350MCM
- Length : 16-1/2"

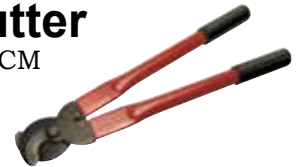

IBS No.	Description
B0014	Cable Cutter

Wire Cutter

- Wire Range: Up to 2/0
- Length : 7-3/4"



IBS No.	Description
B0012	Wire Cutter

12 Volt Tester

- Durable, High quality tester.
- Ideal for testing lighting and wiring circuits in auto, truck, trailer and marine applications.
- Insulated mini-gator clip for positive contact.
- Sharp pierce point for penetrating all low voltage wiring.
- Bulb replaceable with standard automotive bulb.



IBS No.	Description
0690T	12 Volt Tester

CABINETS & TOOLS



IBS, INCORPORATED

Miscellaneous Tools T03

C
A
B
I
N
E
T
S
&
T
O
O
L
S

Wire Crimp Tool



A versatile, heavy-duty tool, made of .140" high-strength, heat-treated carbon steel. It is lightweight without sacrificing strength. It handles a variety of terminal and connector styles, including FLAGS, closed-end connectors, crimp sleeves and standard parts, insulated and non-insulated, over a broad range of 26-6 AWG.

- Anvil Type wire cutter.
- Crimp dies for #26-10 AWG insulated terminals, and connectors, and closed-end connectors.
- Cuts & re-threads 4-40, 6-32, 8-32, 10-24, and 10-32 machine screws.
- Crimp die for #12-6 AWG non-insulated terminals, connectors, FLAGS, quickslides, crimp sleeves and high temperature terminals.
- Crimp die for insulated terminals and butt connectors, wire sizes #8-6 AWG.
- Crimp die for #26-14 AWG non-insulated terminals, connectors, FLAGS, quick-slides and crimp sleeves.
- Wire-stripping stations.
- Strip length guide.
- Textured, cushioned grips.

IBS No.	Description	Qty
TH450	Wire Crimp Tool	1

Battery End Power Cleaning Brushes (P25 & T03)

These brushes remove and polish corroded battery posts to ensure optimal conductivity. Brushes fit easily and securely in any electric, cordless or pneumatic drill.

- Cleans & polishes up to 1,000 battery posts.
- Heavy duty injected molded housing.
- Resilient steel bristles.
- Accepts 1/4" hex shank. Fits all drills or cordless screwdrivers.
- Acceptable RPM rating between 400-800



4-in-1 Tube Fitting Brush

Post Top

Marine

IBS No.	Description	Qty
133341	Post Top Power Brush	1
133343	Marine Power Brush	1
44690	4-in-1 Tube Fitting Brush (P25)	1
133457	Set of 4 Battery Power Brushes	1

Ratcheting Crimp Tool Sets



Available with 4 Additional Dies for Crimping A Variety of Terminals with One Tool!

- 4 Crimp Nests: 8 AWG Red; 12-10 AWG Yellow; 16-14 AWG Blue; 22-18 AWG Red
- Mating mechanism prevents jaws from slipping or misalignment.
- Long handles make it easier to crimp - Less force required.
- Easy-to-use and understand release mechanism.
- Ergonomic design to initiate the crimp process.



Dies Available:

- For open barrel terminals: 20GA thru 10GA
- For Insulated Closed End Connectors
- For Double Crimp Insulated Terminals: 24GA thru 10GA
- For Insulated Flag Terminals

IBS No.	Description	Qty
B0050	Ratcheting Crimp Tool	1
B0051	Ratcheting Crimp Tool & Dies Kit	1
B0052	Ratcheting Crimp Tool Case & Dies — No Tools	1
B0053	Ratcheting Crimp Tool Die for 22-10GA Insulated Closed End Term	1
B0054	Ratcheting Crimp Tool Die with Locator for 20-10 GA Open Barrel Connectors	1
B0055	Ratcheting Crimp Tool Die for 22--14 GA Insulated Flag Terminals	1
B0056	Ratcheting Crimp Tool Die for 26-10 GA Double Grip Insulated Terminals	1



Deutsch Connector Tools



Removal Tool Economy Crimp Crimping Tool

IBS No.	Description	Qty
125124	Deutsch Removal Tool	1
125125	Deutsch Crimping Tool	1
125127	Deutsch Economy Crimping Tool	1

Metripack Crimping Tool



IBS No.	Description	Qty
125225	Metripack Crimping Tool	1

Metripack Terminal Removal Tool



IBS No.	Description	Qty
125226	Metripack Terminal Removal Tool	1

Weatherpack 22-12GA Crimper



IBS No.	Description	Qty
125325	Weather-Pack 22-12GA Crimper	1

Weatherpack Terminal Extractor Tool



IBS No.	Description	Qty
125326	Weather-Pack Terminal Extractor	1



IBS, INCORPORATED

Miscellaneous Tools T03

C
A
B
I
N
E
T
S
&
T
O
O
L
S



**CENTER PUNCH BAND-IT CLAMP
LIGHT DUTY HAND TOOL**

IBS No.	Description	Qty
60150	Center Punch Band-It Clamp Light Duty Hand Tool	1

BAND-IT Center Punch Clamps Light Duty Hand Tool Instructions



1. Tool is designed specifically for 3/8" and 5/8" center punch clamps only. Insert clamp in tool and then insert wrench assembly. If you prefer, install wrench assembly before clamp is inserted. Slot must be aligned with clamp tail.

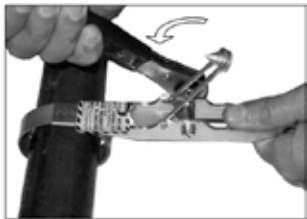

2. Start "pumping ratchet wrench forward until proper tension has been applied.

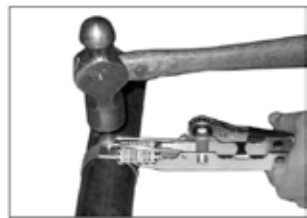

3. Place punch on clamp and while holding tension with ratchet wrench, lock clamp by striking punch once or more with hammer, depending on object being clamped.

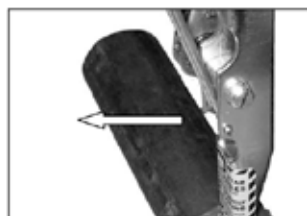

4. While holding tension with wrench, pivot tool up against buckle, then backward several times to break off clamp tail.

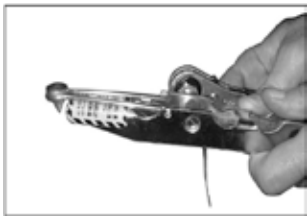

5. To loosen clamp tail, wind ratchet wrench until tail is free. Remove ratchet wrench assembly and clamp tail.



**CENTER PUNCH BAND-IT CLAMP
HEAVY DUTY HAND TOOL**

IBS No.	Description	Qty
60149	Center Punch Band-It Clamp T300 Heavy Duty Hand Tool	1

BAND-IT Center Punch Clamps Heavy Duty Hand Tool Instructions

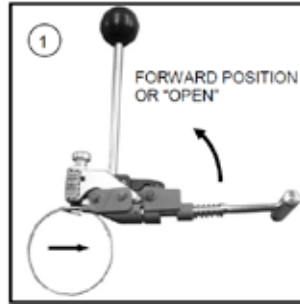

1. Push tension handle all the way forward. Insert BAND-IT Center punch clamp tail and push all the way into tool.

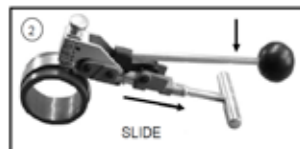

2. Tighten the clamp with short downward strokes. Tension handle should be in down position at completion of tightening clamp.



3. Holding tension down, lock clamp by hitting punch at least twice with a 2 lb. mallet.



4. Hold work-piece and pivot the tool back and forth to break off clamp tail. Remove tail from tool by operating tension handle. When tail has moved through holding dog, raise tension handle and pull tail free.



Cable Tie Gun (Q04) 3/32" - 3/16" Capacity



- **Capacity:** 3/32-Inch (2.4mm) to 3/16-Inch (4.8mm) wide and up to 1/16-Inch (1.58mm) thick — **works on 18 lb. to 50 lb. cable ties.**
- **Generates 18-50 Pounds** of tensile strength for a firm and snug bundle.
- **Flush cuts end of cable tie** for a clean and smooth end, eliminating the hazardous, sharp edges left behind with regular tie ends.
- **Adjustable bundling pressure**, allowing it to be used on various types of materials without damaging the material.
- Body is **constructed of high impact nylon and fiberglass** for strength and durability.
- Not compatible with stainless steel ties.



IBS No.	Description	Qty
141416	Cable Tie Gun	1

Mini Cable Tie Gun

- Secures and cuts cable ties.
- 18-50 lbs tensile strength.



ALWAYS WEAR SAFETY GLASSES
DO NOT OVER-TIGHTEN

IBS No.	Description	Qty
104487	Mini Cable Tie Gun	1

Can-Gun

Aerosol Trigger Attachment

- Minimizes user fatigue associated with using aerosol nozzles.
- Consistent pressure means less clogging and even application.
- Made of durable plastic for long life.
- Easy to attach, easy to remove, fits most aerosol cans.
- Balances can for easy, fatigue free application — great for big jobs.
- Handle eliminates finger on nozzle and means less skin irritation and mess due to chemical over-spray.



IBS No.	Description	Qty
74200	Can Gun Aerosol Trigger Attachment	1

Shur-Shot Dispensing Gun

Also works with LOCTITE 2-Part Clear (IBS No. 97434) and FAST SET STEEL

Static Mixers

Also works with LOCTITE 2-Part Clear (IBS No. 97434) and FAST SET STEEL



IBS No.	Description	Qty
EQ016	Shur-Shot Dispensing Gun	1
EQ115	Static Mixers	1



IBS, INCORPORATED

Miscellaneous Tools T03

C
A
B
I
N
E
T
S
&
T
O
O
L
S

32 oz. Pressurized Sprayer & 32 oz. Measuring Pitcher

Measuring and spraying system for use with the 5 gallon Brake & Parts Cleaner II.



121043 121080 155070 123776

IBS No.	Description	Qty
121043	32 oz Pressurized Sprayer	1
121080	32 oz Measuring Pitcher	1
155070	Spot Spray Measuring Kit	1
123776	Spot Spray Filler Cap Assembly	1

Caulking Gun



IBS No.	Description	Qty
49600	Caulking Gun	1

Spray Bottle & Trigger Sprayers



IBS No.	Description	Qty
74306	Trigger Sprayer for Spray Bottles	1
74307	Empty Spray Bottle	1

Medium Duty Grease Guns

- Develops pressure up to 10,000 psi.
- Automatic variable pressure.
- Delivery: 1 oz. per 21 strokes.
- Air vent fitting.
- Vinyl grip.
- Deluxe pull handle with heavy-duty rivets & positive stop.
- Heavy-duty one-piece head.
- Three-way loading - loader fitting included.



IBS No.	Description	Qty
500HD	Medium Duty Grease Gun	1

- Three-way loading - loader fitting included.
- 4500/3000 psi.
- Automatic variable pressure.
- Delivery - 1 oz. per 33, 16 strokes.
- Air vent fitting.
- Vinyl grip.
- Deluxe pull handle with heavy duty rivets.
- Heavy duty one-piece head.



IBS No.	Description	Qty
525HD	Medium Duty Grease Gun	1

Mini Grease Gun

- Uses standard 3 Oz. (85.05g) grease cartridge.
- Right hand direction.
- Capacity Range: 100 to 600 Ft lbs.



IBS No.	Description	Qty
25703	Mini Grease Gun	1



LockNLube Coupler

The LockNLube Coupler has a unique sliding sleeve, activated by thumb lever. The sleeve either locks the four spring-steel jaws onto the zerk fitting or releases the jaws from the zerk. No hands are needed to align or hold the coupler in place while greasing. The locked connection is positive and rigid, preventing the coupler from coming loose and breaking the leakproof seal. If a fitting becomes pressurized, especially a recessed one, just depress the thumb lever and release the coupler. Because it does not leak, the grease goes in, not on the machine, and the bearings get the grease they so desperately need.



- Works with all grease gun types: pneumatic, manual and electric.
- Works on all DIN and SAE specification zerks.
- Fits 1/8" pipe thread.
- Works with all grease gun manufacturers.
- No need to hold while greasing. Lock-on and free up both hands to operate the grease gun. — simply depress the trigger to release, even under pressure.
- Durable nitrile rubber seal for longevity under high pressure.
- Four hardened spring steel jaws are resilient under high pressure.
- Check valve to reduce leakage.
- LOCK N' LUBE XL with a longer barrel has a 3.6" effective reach.

IBS No.	Description	Qty
5855	LockNLube Locking Grease Coupler	1
5856	LockNLube XL Locking Grease Coupler	1
5860	LockNLube Repair Kit	1

LockNFlate Coupler

Like no other air chuck on the market, the LockNFlate's six steel jaws lock onto any Schrader valve to create a secure, hands-free connection. The heavy-duty construction is built to last and stand up to everyday use in even the busiest tire shops, service bays, and garages.



- **REVOLUTIONARY DESIGN:** six steel jaws lock onto any Schrader valve to create a secure, hands-free connection.
- **1/4" NPT THREAD SIZE:** compatible with most standard air hoses
- **HARDENED SEEL COLLET:** Fits all standard Schrader valves [VG8/8V1 valve threads]
- **RATED TO 150 PSI:** Suitable for garage and industrial airline systems, auto and manual tire inflators, portable pressure gauges, constant pressure systems
- **HEAVY-DUTY CONSTRUCTION** is built to last and stand up to everyday use in even the busiest tire shops, service bays, and garages.
- **DURABLE, SPRING-LOADED TPU SEAL:** Inflate tires with or without the valve core in place.

IBS No.	Description	Qty
5858	LockNFlate Locking Air Chuck	1

Locking Dual Wheel Adapter

A quick & easy way to inflate dual wheels. This new air chuck adapter features a two-jaw locking design and patented remote actuator. Easily attach and disconnect with the actuator — no need to reach in to disconnect.



The Dual Locking Head allows you to push onto valves facing towards you, or pull onto the valves facing away from you.

- Overall Length: 15.5 in. (40cm).
- Maximum pressure: 150 PSI (10.3 BAR)

IBS No.	Description	Qty
5859	Dual Wheel Locking Air Chuck Closed - 15.5"	1



IBS, INCORPORATED

Miscellaneous Tools T03

C
A
B
I
N
E
T
S
&
T
O
O
L
S

Rivet Nut Gun



This thin sheet setting tool has been designed to enable threaded nut inserts to be threaded easily by hand. Invaluable to maintenance engineers for on the spot repairs.

- Designed for the quick manual insertion of permanent load bearing threads in materials from 0.20" to 0.128."
- Simple set up and easy uniform stroke allows a nutsert to be set in thin sheet materials without causing surface damage.
- A comprehensive range of mandrels and nosepieces are available.

RIVET NUT GUN MANDRELS & NOSEPIECES

IBS No.	Description
49500	Rivet Nut Gun Tool Only No Mandrels or Nosepieces
49507	6-32 Mandrel & Nosepiece
49508	8-32 Mandrel & Nosepiece
49510	10-24 Mandrel & Nosepiece
49511	10-32 Mandrel & Nosepiece
49512	1/4-20 Mandrel & Nosepiece
49513	5/16-18 Mandrel & Nosepiece
49514	3/8-16 Mandrel & Nosepiece
NS-49520*	4mm Mandrel & Nosepiece
NS-49521*	5mm Mandrel & Nosepiece
NS-49522*	6mm Mandrel & Nosepiece
NS-49523*	8mm Mandrel & Nosepiece
NS-49524*	10mm Mandrel & Nosepiece

* Order as non-stock item

Heavy Duty Nutsert Tool

Ideal for installing larger size threaded inserts. This heavy-duty tool installs 1/4-20 through 3/8-16, and 5mm through 10mm threaded inserts in aluminum or steel. Quick changing mandrels, easily adjustable stroke. **1/4-20 nosepiece and mandrel included.**



HEAVY DUTY NUTSERT TOOL MANDRELS & NOSEPIECES

IBS No.	Description
49550	Heavy Duty Nutsert Tool includes 1/4-20 Mandrel & Nosepiece only
49551	1/4-20 Mandrel & Nosepiece
49552	5/16-18 Mandrel & Nosepiece
49553	3/8-16 Mandrel & Nosepiece

Swivel Head Professional Rivet Tool

- Rivet head swivels 360° for riveting at any angle.
- Hardened steel construction
- Extended nosepiece for hard to reach locations.
- Comfortable non-slip handle grips.
- Not recommended for nylon rivets.
- Includes nosepieces: 3/32, 1/8, 5/32 & 3/16.



IBS No.	Description
HP-5	Swivel Head Professional Rivet Tool

Rivet Diameter	3/32	1/8	5/32	3/16
Aluminum	YES	YES	YES	YES
Steel	YES	YES	YES	NO
Copper	NO	YES	NO	NO
Stainless Steel	NO	YES	NO	NO



Heavy Duty Rivet Tool



The **HP-2** is the number one selling hand rivet tool in the industry. Known and trusted for durability, quality and performance, the HP-2 is often copied but never duplicated. Its square shoulder fulcrum pin of cold-formed heat-treated steel prevents pin rotation that can elongate the engaging holes and cause premature tool failure in imitation tools. Other quality features include: precision die-cast, high-strength aluminum alloy body; drop-forged carbon steel upper handle; and thick, cushion molded vinyl grips for comfort. The HP-2 sets up to 3/16" steel rivets and comes with four mounted nosepieces (3/32", 1/8", 5/32" and 3/16") and a service wrench.

- **Square shoulder fulcrum pin of cold-formed heat-treated steel** prevents pin rotation that can elongate the engaging holes, a leading cause of premature tool failure in imitations – fewer failures means less rework time, faster installations – equals time and money savings!
- **Precision die-cast, high-strength aluminum alloy body** makes this tool super durable while keeping it light-weight – means longer life and comfortable to use.
- **Drop-forged steel upper handle gives this tool added strength** for extended service life.
- **Thick cushion-molded vinyl grips for comfort** means better productivity and less likely for fatigue and injury.
- **Sets steel and aluminum rivets** from 3/32" to 3/16", and stainless steel up to 5/32"

IBS No.	Description
HP-2	Heavy Duty Rivet Tool

Big Daddy Manual Rivet Tool



The Big Daddy is a **versatile and powerful hand riveter**, taking the hard work out of setting large diameter blind rivets.

- **Extra-long handles provide excellent leverage** and permit working a foot beyond natural reach.
- **Patented bearing design, self-adjusting two-piece jaws and single-unit body construction** with a steel insert to provide stronger threads for the nosepieces included.
- **Double gear reduction system** easily sets from 1/8" to 1/4" diameter rivets in all alloys.
- **One piece collet case eliminates the need to adjust the tool** when changing rivet diameters.
- **5/32", 3/16" and 1/4" nosepieces**, which are stored in the body
- Weighs 3.75 lbs

IBS No.	Description
49520	Big Daddy Manual Rivet Tool

C
A
B
I
N
E
T
S
&
T
O
O
L
S



IBS, INCORPORATED

Miscellaneous Tools T03

C
A
B
I
N
E
T
S
&
T
O
O
L
S

ReelTek™

Air / Water Reels for Light Industrial Use

A new, lighter spring-driven hose reel designed for applications that are less demanding, yet require a product that can withstand industrial use. ReelTek's hybrid design incorporates industrial-grade steel and composite materials to virtually eliminate corrosion.

Easy-to-install and maintain, ReelTek™ conveniently keeps hoses organized for a more efficient, safer work area. Simply pull out the hose to the desired length, lock into position during use, and retract when finished. Hoses stored on reel last five times longer, stay out-of-sight, and out-of-the-way.

REELTEK™ HOSE & REEL ASSEMBLIES

IBS No.	Description	Qty
131272	Reel for 3/8" x 50' Hose 3/8" x 50 Flexeel Hose Rubber Stopper	1
131294	Reel for 3/8" x 50' Hose 3/8" x 25' Flexeel Hose Rubber Stopper	1

REELTEK™ HOSE REELS

IBS No.	Description	Qty
131185	Reel for 3/8" x 50' Hose	1

REPLACEMENT HOSE

IBS No.	Description	Qty
130491	1/4" x 50' Flexeel Polyurethane Air Hose	1
130494	3/8" x 50' Flexeel Polyurethane Air Hose	1

ACCESSORIES

IBS No.	Description	Qty
131186	Rubber Stopper	1

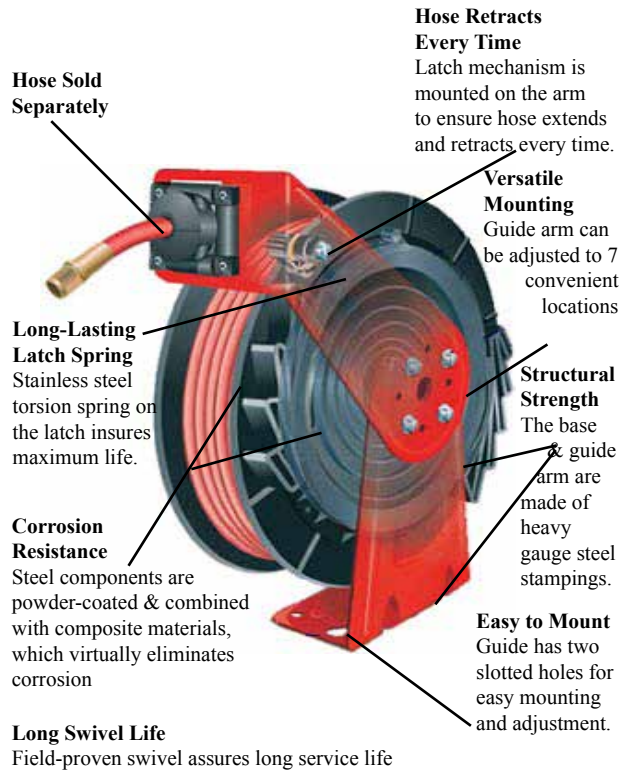

Installation . . . Easy as 1, 2, 3



Step 1

Locate stud & layout bolt hole pattern of the reel. Drill pilot holes into the stud

Step 2

Thread lag screws into pilot holes.

Step 3

Hang reel onto lag screws. Securely tighten lag screws. Ready to use.

ReelTek is ideal for . . .

- Light industrial
- Air-powered tools
- Assembly lines
- Machine shops
- Maintenance shops
- Auto / truck repair
- Auto Paint & Body
- Farm & ranch
- Woodworking
- Garden shops
- Home workshops
- Many more uses



Hose Crimper

- Provides production capability for crimping standard hose.
- Gives "big tool" crimping advantages at just a fraction of the cost.
- Comes with 5 dies to crimp 1/4"-1" braid to 3/8" - 2" braid.
- Die Sizes: 5/8" 37/64" 17/32" 31/64" 11/16"
- Rugged Construction: High strength ductile iron casting.
- Self-contained & Portable: All dies in one place, ready for use.
- One-hand operation: Positive camming action allows for good leverage at end of lever stroke.



IBS No.	Description	Qty
AM855	Hose Crimper	1

Hose & Tubing Cutter

CUTS FLEXIBLE HOSE UP TO 1-1/4"

- Cleanly cuts heater hoses, fuel lines and other types of flexible hose up to 1-1/4".
- Stainless steel blade is reversible for double the life.
- Plier is made of glass-filled nylon for strength.



IBS No.	Description
11420	Hose & Tubing Cutter
11450	Replacement Blades (1)

Hydraulic Crimper

DROP SHIPS FROM MANUFACTURER



- Heavy duty 60+ ton capacity
- 1/8 to 1-1/4 6-wire capability
- Fully adjustable crimp settings
- 0.125 to 2.75 crimp capability
- Auto micro-switch shut-off
- Good crimp visibility
- Comes with 5 dies standard
- Includes die holder
- Quick crimp cycle time
- Well accepted Dayco die configuration
- Interchangeable with Dayco dies
- Built for longevity

IBS No.	Description	Qty
KH60	Hydraulic Crimper	1



IBS, INCORPORATED

Miscellaneous Tools T03

C
A
B
I
N
E
T
S
&
T
O
O
L
S

Indexing Pry Bars

Designed to improve access in tight applications, the head of the pry bars can be adjusted to 14 different positions, offering more than 180° of angle. The new, innovative indexing feature allows the user to gain more leverage. The 8" Indexing Pry Bar can also function as a seal pick for removing engine and axle drive seals. In addition to the fixed length Indexing Pry Bars, an expandable version is available that extends from 18" to 29" .



IBS No.	Description
CA-82208	8" Indexing Pry Bar
CA-82210	10" Indexing Pry Bar
CA-82216	16" Indexing Pry Bar
CA-82224	24" Indexing Pry Bar
CA-82220	18 to 29" Extend Index Pry Bar
CA-82248	29 to 48" Extend Index Pry Bar

16" Adjustable Pry Bar/Nail Puller

An innovative demolition, renovation and construction tool.

- Recipient of the Popular Mechanics Editor's Choice Award for 2012.
- Adjustable jaws slide and clamp onto objects for straightening and prying.
- Crow bar end with nail puller slot.
- Striking hammer head surface for striking
- Large claw on head that adjusts for leverage in pulling nails.



IBS No.	Description	Qty
CA-82000	16" Adj Pry Bar / Nail Puller	1

IBS Service Broom

- Moderate stiffness, large angled trim upright broom has a sturdy metal capped construction and fused polypropylene bristles for superior performance and long life.
- The large angle bristle flare design and comfortable handle allow for fast clean up of a wide variety of jobs.
- Private labeled with the IBS Logo and tagline "The Mark of Our Quality is in Our Service."



IBS No.	Description	Qty
42010	IBS Service Broom	1

Pump Up Sprayer 0.5 Gallon

Hand pump sprayer is **convenient and easy to use** with cleaners, degreasers, solvents, insecticides and other solutions. Small enough for **hand-held applications** and large enough to **hold 0.5 gallons for effective cleaning** or application.



- **0.5 Gallon / 2 Liter** capacity tough poly tank - light weight, durable and chemical resistant.
- **Viton seals** provide maximum chemical resistance that extends the life of the sprayer.
- **Versatile** - nozzle adjusts from stream to fine mist.
- **Locking thumb-operated control valve** for easier and more comfortable dispensing.
- **Saves time** - **wide mouth opening** allows for quick refills.

IBS No.	Description	Qty
74310	Pump Up Sprayer 0.5 Gallon	1



Hardware & Springs

A

Assortments

- Polyurethane Straps Variety Pack U-3
- Springs
 - Compression U-12
 - Extension U-13
- Wire Rope Accessories
 - Quick Links & Spring Links U-8

B

Brushes, Misc.

- 4-in-1 Tube Fitting Brush U-15
- Acid U-15
- Chip and Oil U-15
- Counter Duster U-14
- Floor
 - IBS Service Broom U-14
- Handles & Braces U-14
- Parts Cleaning U-15
- Squeegees U-14

H

Hardware

- Clevis Grab Hooks U-9
- Cold Shuts U-7
- Machinery Hoist Eyes U-5
- Quick Links U-7
- Screw Pin Anchor Shackles U-9
- Spring Links U-7
- Turned Eye Bolts U-5
- Wire Rope U-6
- Wire Rope Clips U-9
- Wire Rope Sleeves U-7
- Wire Rope Thimbles U-7

P

Polyurethane Rope & Straps U-2

- Poly Strap with Hooks U-2
- Poly Synch Chord with Nylon Hooks U-2
- Polyurethane Rope & Nylon Hook Ends U-2
- Polyurethane Straps Variety Pack U-3

S

Springs

- Extension U-13
- General Information U-11

T

Tarp Cord U-3

- Ratcheting Tie Downs U-4

Tarp Cord Hooks U-3

Tie-Down Straps

- Molded Rubber
 - Snappi-Hookers U-3
- Ratcheting Retractable Tie Downs U-4
- Ratcheting Tie Downs U-4

Tools

- Cable Cutting Tools U-6
- Swaging Tools U-6

W

Wire Rope U-6



IBS, INCORPORATED

Tarp Cord U01

H
A
R
D
W
A
R
E
&
S
P
R
I
N
G
S

Polyurethane Rope & Straps

An improvement on the old rubber straps and standard bungee cord — a new high tech material made of polyurethane. It's a new, stronger material with the advantage of molded on nylon ends. These polyurethane ropes and straps are lightweight and strong, and the molded on nylon ends have superior construction with break ratings that exceed 180 lbs.

- **Industrial grade polyurethane rope** (no cloth or elastic) will not break, rot, or become brittle like rubber or cloth and maintains its stretch even under extreme conditions for a safer and longer lasting cord — saving time and money.
- **Polyurethane has a long, safe stretch of 2 times its length** for a superior reach and hold for all tie down and strapping needs — requiring fewer lengths — reducing inventory and storage of a variety of strap lengths.
- **Polyurethane has a better performance under extreme weather conditions** such as UV, hot and cold temp variations, water, ozone than rubber and cloth — even performs when exposed to diesel fuel, oil and most household chemicals — making this a superior cord for all areas, — saving time and money.
- **Quick attach hooks make customizing any size tie downs, cargo nets, or cord extremely fast and convenient** — saving time, money and the struggle to find the right cord length
- Fixed strap lengths are made with **fiberglass-filled nylon hooks that are overmolded into cord** for superior performance and durability with the same 2 times stretch and a break rating on hook of 180 lbs for maximum safety — keeping workers safe from snap back and injury.
- **Molded on nylon end hooks won't mar or scratch like metal hooks** — providing a strap that is safer to use on all materials, keeping vehicles and other areas where straps are used safe from damage.
- **The Synch™ Cord has a loop on one end and an over-molded super strong non-marring end on the other** — it can make an anchor point easily by wrapping the cord around a bar or through a hole; then put the hook through the loop, pull tight then secure the hook end — for a convenient and fast strap where two hooks just won't work.
- **Made in the USA, they won't break, crack or become brittle** — they retain their color, always remain stretchy, stretching up to twice their original length!

Polyurethane Rope & Nylon Hook Ends



IBS No.	Description	Qty
24006	5/16 x 50 ft. HD Poly Rope - Black	1
24007	5/16 Nylon Hook End for Rope (10 pk)	1

Poly Strap with Hooks Poly Synch Cord WITH NYLON HOOKS

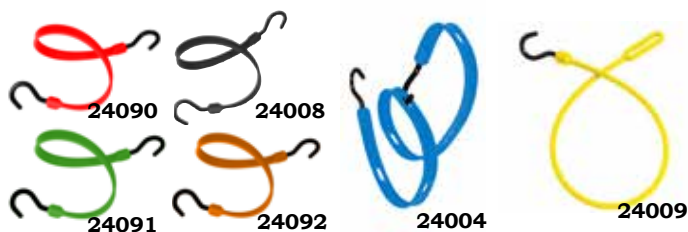

IBS No.	Description	Qty
24090	12" Poly Strap w/Hooks - Red	1
24091	18" Poly Strap w/Hooks - Green	1
24008	24" Poly Strap w/Hooks - Black	1
24004	36" Poly Slotted Strap w/Hooks - Blue	1
24092	36" Poly Strap w/Hooks - Orange	1
24009	30" Poly Synch Cord w/Molded Nylon Hook - Yellow	1

IBS, INCORPORATED

Tarp Cord U01



Polyurethane Straps

VARIETY PACK
IBS No. 588P

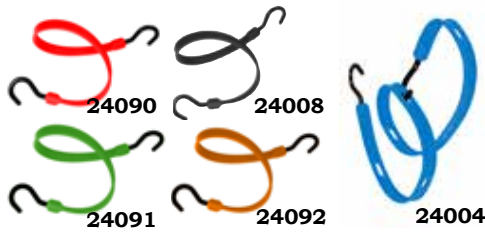

IBS No.	Contains 1 of Each Strap	Qty
24090	12" Poly Strap w/Hooks - Red	2
24091	18" Poly Strap w/Hooks - Green	2
24008	24" Poly Strap w/Hooks - Black	2
24004	36" Poly Slotted Strap w/Hooks - Blue	1
24092	36" Poly Strap w/Hooks - Orange	2

Tarp Cords

MOLDED TIE-DOWN STRAPS
Heavy-Duty Rubber Hold-Down Straps
With "S" Hooks



- Heavy duty EPDM lasts longer than rubber with excellent UV properties to resist cracking and extend strap life.
- Strong stretch and recovery performance with both hot and cold temperatures.
- 1/2" thick, teardrop ends to help prevent hooks from tearing through the strap.
- Zinc plated, rust-resistant steel S-hooks.
- Made in the USA.

IBS No.	Length	Box	Pkg
SH9	10"	50	ea.
SH15	15"	50	ea.
SH20	21"	50	ea.
SH30	31"	50	ea.
SHH	S-Hook Replacement	10	ea.

Tarp Cord & Hooks



The 7/16" tarp cord with attachable hooks is ideal for use with canvas, tarpaulins, covers and lids on RV's, boats, cars trucks, trailers and motorcycles. It comes in a 125 ft. roll that can be cut to length for any use. The hooks can be attached easily and quickly. It's perfect for holding extra gear on trucks and trailers, or for holding down tarps and canvas covers. It's made of the highest quality Neoprene so it won't rot, peel or crack under normal usage — even in demanding outdoor conditions.

IBS No.	Description	Qty
32071601	7/16 dia. Neoprene Cord 125'	1
320#710	Galvanized Double Eye Hooks	25

To Apply Fastener Hooks To Tarp Cord

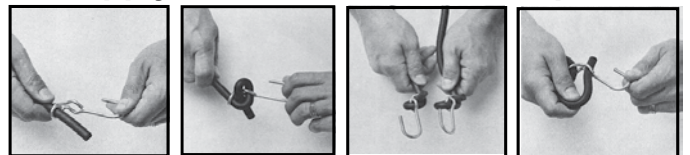

1. Insert cord through eye of hook.
2. Return through second position of eye, to form a loop.
3. Pull end through loop, forming a knot.
4. Same procedure at other end provides a tie-down strap that has many uses.

Tarp Cord Stretchability

Cut Length	Stretches To
12"	18"
24"	40"
36"	60"

HARDWARE & SPRINGS



IBS, INCORPORATED

Tie Down Straps U01

H
A
R
D
W
A
R
E
&
S
P
R
I
N
G
S

Ratcheting Retractable Tie Downs



Retractable ratcheting utility tie down straps features a retractable ratcheting system that keeps the webbing secure, contained and efficiently stored and protected on the spindle. Durable, fully sized S-hooks with safety clips efficiently and securely holds cargo in place.

- **Self-contained bolt-on style assembly** stores webbing on a built-in spindle.
- **Multi-position** lever release design.
- 1" polyester webbing.
- **Full size coated S-hooks** with safety clips.
- **Special gear spring design** restricts accelerated retraction.

IBS No.	Description	Qty
24095	15' X 1" 2 Pack Retractable Ratchet Tie Downs	1

Ratcheting Tie Downs

- Molded grip ratchet handle for easy and convenient use.
- Extra strong, heat treated steel, compact vinyl-coated S-hooks prevent scratching.
- Fully adjustable to 15' fits most tie downs.
- Locks secure for dependability.
- Working load limit: 500 lbs.
- Breaking strength: 1500 lbs.



IBS No.	Description	Qty
24005	1" x 15' 4 Pack Ratchet Tied Downs	1

Rope Ratchet

With the Rope Ratchet you simply attach the two hooks and pull the loose end of the rope for a secure, tight hold.

Rope Ratchets stay tight, locking in place as you pull the free end. To loosen you just pull the rope to reduce tension and push the handy thumb release. It's that easy!



IBS No.	Description	Load Rating	Qty
24000	1/4" x 8'	150LB Max.	1
24001	3/8" x 15'	250LB Max.	1
24002	1/2" x 15'	500LB Max.	1



Machinery Hoist Eyes

SHOULDER PATTERN EYEBOLTS

Made from drop forged steel. Heat treated after forging.

Maximum load rating for eyebolts are based on a straight vertical lift in a gradually increasing manner. Angular lifts will significantly lower loads and should be avoided whenever possible. If an angular lift is required, a properly seated Machinery Hoist Eye should be used and the lifting angle must not be more than a 45° pull. Refer to the chart below for the maximum load ratings for straight and 45° pulls.

MACHINERY HOIST EYES

IBS No.	Shank		Eye		Max Load (lbs.)		Pkg Qty
	Size	Length	ID	OD	Strt Pull	45° Pull	
20000	1/4-20	1	3/4	1-1/4	500	125	5
20001	5/16-18	1-1/8	7/8	1-1/2	900	225	5
20002	3/8-16	1-1/4	1	1-21/32	1400	350	5
20003	7/16-14	1-3/8	1-3/32	1-27/32	2000	500	3
20004	1/2-13	1-1/2	1-3/16	2-1/8	2600	650	2
20005	9/16-12	1-5/8	1-9/32	2-9/32	3000	750	2
20006	5/8-11	1-3/4	1-3/8	2-1/2	4000	1000	2
20007	3/4-10	2	1-1/2	2-13/16	6000	1500	2
20008	7/8-9	2-1/4	1-11/16	3-1/4	7000	1750	2
20009	1-8	2-1/2	1-13/16	3-9/16	9000	2250	2

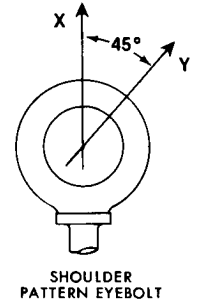

Turned Eye Bolts

Turned Eyebolts are manufactured from low carbon cold drawn steel wire, threaded and supplied with a nut.

TURNED EYEBOLTS

IBS No.	Dimensions in inches					MAX Load (Lbs)	Pkg Qty
	A	B	C	D	T		
22024	10-24	2	3/8	2-11/16	1	38	20
02539	10-24	3	3/8	3-11/16	1-1/2	38	20
22025	1/4-20	2	1/2	3	1-1/4	74	20
22027	1/4-20	3	1/2	4	1-1/2	74	20
22028	1/4-20	5	1/2	6	3	74	20
22029	5/16-18	3	5/8	4-1/8	1-1/2	96	20
22030	5/16-18	4	5/8	5-1/8	2-1/2	96	20
02549	5/16-18	5	5/8	6-1/8	3	96	20
02550	5/16-18	6	5/8	7-1/8	4	96	20
02552	3/8-16	3	3/4	4-1/2	1-1/2	144	20
02553	3/8-16	4	3/4	5-1/2	2-1/2	144	20
02554	3/8-16	5	3/4	6-1/2	3	144	20
22032	3/8-16	6	3/4	7-1/2	4	144	20

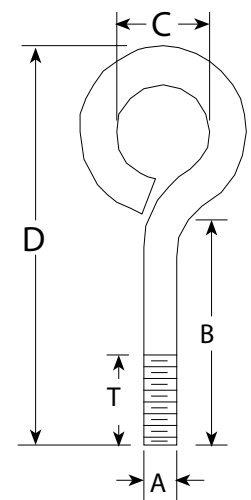
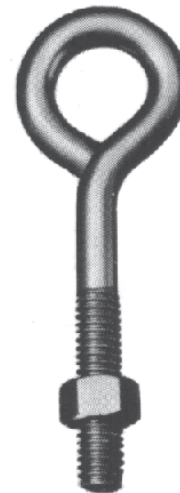



IBS, INCORPORATED

Eyebolts, Chain & Wire Hardware U02

Vinyl Coated, Galvanized Wire Rope

- High strength, quality flexible construction.
- All cable is made according to federal specification RR-W-410E.
- NOTE: Small diameter 7x7 and 7x19 wire rope (also referred to as Aircraft Cable) is not intended for aircraft use because it does not test according MIL-W-83420 request.
- Caution: Actual working loads may vary, but should never exceed 20% of nominal breaking strength.
- Working load limit is based on a design factor of 5:1.

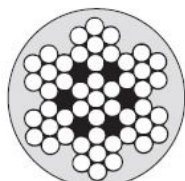

7X7 Wire Rope
Vinyl Coated

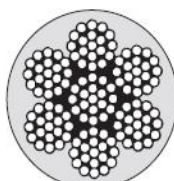

7X19 Wire Rope
Vinyl Coated



7X19 Wire Rope

IBS No.	Size (inches)	Description	Working Load Limit LBS	Spool Length	Pkg Qty
22052	1/16 X 1/8*	7X7 Wire Rope	96	100	1
22053	3/32 X 3/16*	Vinyl Coated	84	100	1
22058	1/8 X 3/16*	7X19 Wire Rope	400	100	1
22061	3/16	7X19 Wire Rope	840	100	1
22062	1/4		1400		1
22063	5/16		1960		1
22064	3/8		2880		1

* Bare Cable Diameter X Coated Diameter

Swaging Tools (T03)

- Heat-treated steel jaw used for making loops and splicing cable.
- Crimps and cuts accurately.
- Used only for copper or aluminum sleeves and stops.



22090



22091

IBS No.	Size (inches)	Description	Pkg Qty
22090	1/16 - 1/8	Swager	1
22091	1/16 - 3/16	Swager	1

Cable Cutting Tools (T03)

- 22092: For wire ropes up to 1/4" diameter.
- 22092: Bolted joint for precise blade guidance; re-adjustable.
- 22092: Chrome vanadium heavy duty steel; forged oil hardened.
- 22093: For ACSR, wire ropes and steel rods copper and aluminum cables up to 3/8" diam.
- 22093: Suitable for cutting overhead cables with strain relief wire.
- 22093: Bolted head cutter, replaceable.



22092



22093

IBS No.	Size (inches)	Description	Pkg Qty
22092	1/4	Knipex Steel Cable Cutter	1
22093	3/8	Knipex Steel Cable Cutter	1

H
A
R
D
W
A
R
E
&
S
P
R
I
N
G
S

IBS, INCORPORATED

Eyebolts, Chain & Wire Hardware U02



Wire Rope Sleeves

- Used to make a solid eye in cable.
- Made of aluminum.



IBS No.	Size	Description	Pkg Qty
22070	1/16	Wire Rope Sleeve	100
22071	3/32	Wire Rope Sleeve	50
22072	1/8	Wire Rope Sleeve	50
22074	3/16	Wire Rope Sleeve	50
22075	1/4	Wire Rope Sleeve	50
22076	5/16	Wire Rope Sleeve	50
22077	3/8	Wire Rope Sleeve	50

Wire Rope Thimbles

- Used with rope clips to make a solid eye in cable or rope.
- Zinc-plated steel construction combines strength and corrosion resistance
- Warning: Not recommended for overhead lifting.



IBS No.	Size	Description	Pkg Qty
22080	1/8	Wire Rope Thimble	25
22081	3/16	Wire Rope Thimble	25
22082	1/4	Wire Rope Thimble	25
22083	5/16	Wire Rope Thimble	25
22084	3/8	Wire Rope Thimble	25

Cold Shuts

Repair links for chain

- An economical way to join chain links and attach fittings.
- To close, drive the end through the eye and flatten the end to prevent opening (can also be welded shut).



IBS No.	Description	Qty
22036	1/4" Cold Shut	5
03602	5/16" Cold Shut	5
22038	3/8" Cold Shut	5

Quick Links

- Fast easy connections for permanent or temporary applications with low carbon chain.
- Use as a repair link, connecting link, or attaching device.
- Zinc plating offers good corrosion resistance.
- Working load limit is based on a design factor of 4:1.



IBS No.	Size (inch)	Working Load Limit (LBS)	Pkg Qty
22040	1/8	130	20
22041	3/16	400	20
22042	1/4	600	20
22043	5/16	800	20
22044	3/8	1200	10
22045	1/2	4500	10

Spring Links

- Designed for use with chain repair and wire rope.
- Working load limit is based on a design factor of 3:1



IBS No.	Size	Working Load Limit (LBS)	Pkg Qty
22046	1/8	35	20
22047	3/16	70	20
22048	1/4	140	20
22049	5/16	280	20
22050	3/8	400	10
22051	1/2	500	10

H
A
R
D
W
A
R
E
&
S
P
R
I
N
G
S



IBS, INCORPORATED























Assortments Z02

Quick Links & Spring Links Assortment

IBS No.748R • 11 Items - 72 Pcs

Packaged in a locking steel drawer for easy storage and organization

H
A
R
D
W
A
R
E
&
S
P
R
I
N
G
S

 IBS, Inc. <small>SPECIALTY PRODUCTS FOR MAINTENANCE & REPAIR INDUSTRIALBOLT.COM 800-678-1906</small>		Quick Links & Spring Links	
		Assortment No. 748R	
22040 1/8 QUICK LINK ZP  	22041 3/16 QUICK LINK ZP  	22042 1/4 QUICK LINK ZP  	
22043 5/16 QUICK LINK ZP  	22044 3/8 QUICK LINK ZP  	22045 1/2 QUICK LINK ZP  	
22047 3/16 SPRING LINK ZP  	22048 1/4 SPRING LINK ZP  	22049 5/16 SPRING LINK ZP  	
22050 3/8 SPRING LINK ZP  	22051 1/2 SPRING LINK ZP  		



Clevis Grab Hooks

- Made for use on Hi-Test Chain. All hooks are heat treated. They can also be used on BBB & proof coil.
- High test (H.T.) stamped on every hook.
- Zinc plated for corrosion resistance.

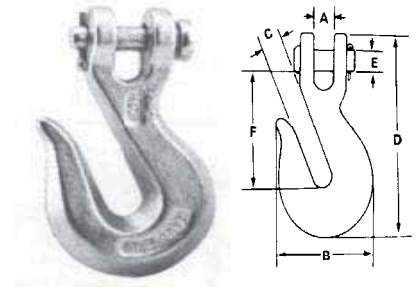

IBS No	Chain Size	A & E	B	C	D	F	Work Load (Lbs)	Pkg Qty
22010	1/4	5/16	1-5/16	3/8	3-3/8	2	2600	2
22021	5/16	3/8	2-1/4	7/16	3-15/16	2-3/8	4000	2
22022	3/8	7/16	2-11/16	1/2	4-1/2	2-11/16	5400	2

Wire Rope Clips — Zinc Plated

IBS No.	Rope Size	Dimensions in inches				Pkg Qty
		A	B	C	T	
22013	1/8	12-24	3/4	9/32	1/2	5
22014	3/16	1/4-20	15/16	5/16	5/8	5
22015	1/4	5/16-18	1-5/32	3/8	3/4	5
02702	5/16	3/8-16	1-1/2	1/2	1	5
02703	3/8	7/16-14	1-5/8	9/16	7/8	5
22016	1/2	1/2-13	1-7/8	5/8	1-1/4	5

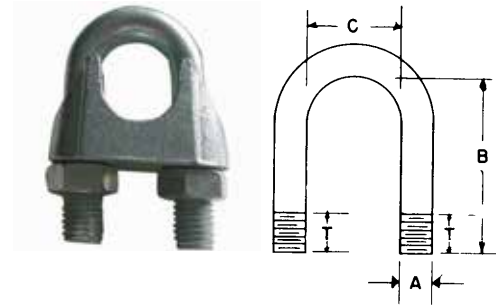

Screw Pin Shackles Forged Galvanized

Loads are based on a safety factor of 5 to 1. When tested all shackles are pulled at a uniform rate of speed in a direct tension. Any deviations as angular lifts, shock loads, modification of the basic forging, etc., will result in drastically reduced maximum loads.

IBS No.	Working Load Limit LBS.	Dimensions - Inches					Pkg Qty
		Thickness Size Dia.	Pin or Bolt Dia	Inside Length	Opening Width	Inside Width	
22017	650	3/16	1/4	3/4	3/8	19/32	2
22018	1000	1/4	5/16	1-1/8	15/32	25/32	2
22019	1500	5/16	3/8	1-1/4	17/32	27/32	2
22020	2000	3/8	7/16	1-1/2	21/32	1-1/32	2
22023	4000	1/2	5/8	2	13/16	1-5/16	1
22065	6500	5/8	3/4	2-1/2	1-1/16	1-11/16	1
22066	9500	3/4	7/8	3	1-1/4	2	1

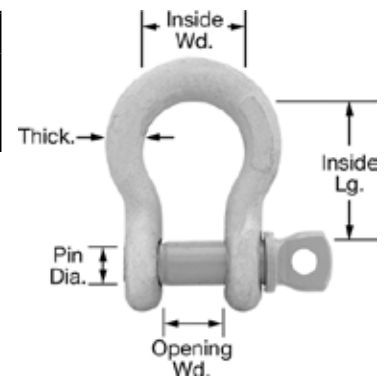



IBS, INCORPORATED

Eyebolts, Chain & Wire Hardware U02

H
A
R
D
W
A
R
E
&
S
P
R
I
N
G
S

Chain Parts

SLIP FIT CONNECTING LINKS



Slip-Fit Connecting Links or Rivet-Type Connecting Links are furnished with a pin link plate and a spring clip. Once the connecting link is inserted between the chain links, slide the pin link plate over ring and assemble with spring clip grooves on pins.

IBS No.	Chain No.	Description	Qty
20135	#35	.375 Pitch	10
20140	#40	.500 Pitch	10
20141	#41	.500 Pitch	10
20150	#50	.625 Pitch	10
20160	#60	.750 Pitch	10
20180	#80	1.00 Pitch	5

OFFSET LINKS



This is in reality a roll link at one end, and a pin link at the other end. An offset link is used whenever an odd number of pitches is required. The pin is removed to assemble the link into a chain.

IBS No.	Chain No.	Description	Qty
20235	#35	.375 Pitch (Half)	10
20240	#40	.500 Pitch (Half)	10
20241	#41	.500 Pitch (Half)	10
20250	#50	.625 Pitch (Half)	10
20260	#60	.750 Pitch (Half)	10
20280	#80	1.00 Pitch (Half)	5

Chain Repair Tools

#1 CHAIN BREAKER



A quality tool with forged jaws. The "push-out" pins are made of tempered alloy steel. Simplifies the disassembly of the roller chain. Use for disassembly of single pitch chains No. 25 thru 60 (1/4, 3/8, 1/2, 5/8 & 3/4" pitch; double pitch chains 1 and 1-1/4" pitch.

IBS No.	Description	Qty
20300	#1 Chain Breaker	1

Roller Chain & Offset Chain Links

IBS No. 208P • 13 Items • 67 Pcs

Packaged in a locking steel drawer for easy storage and organization

IBS, Inc. <small>SPECIALTY PRODUCTS FOR MAINTENANCE & REPAIR INDUSTRIALBOLT.COM © 2008 800-875-1906</small>						Roller Chain Links Offset Chain Links
<small>Assortment No. 208P</small>						
20135 #35 .375 PITCH CONN. LINK 	20140 #40 .500 PITCH CONN. LINK 	20141 #41 .500 PITCH CONN. LINK 	20150 #50 .625 PITCH CONN. LINK 	20160 #60 .750 PITCH CONN. LINK 		
20180 #80 1.00 PITCH CONN. LINK 						
20235 #35 .375 PITCH OFFSET (HALF) 	20240 #40 .500 PITCH OFFSET (HALF) 	20241 #41 .500 PITCH OFFSET (HALF) 	20250 #50 .625 PITCH OFFSET (HALF) 	20260 #60 .750 PITCH OFFSET (HALF) 		
20280 #80 1.00 PITCH OFFSET (HALF) 						



General Information Compression & Extension Springs



Compression springs generally have closed ends and the number of active coils (N) are two less than the total number of coils.

Extension springs - All coils are active and the body length is the number of coils + 1 times the wire diameter. For extension type springs the rate per inch is effective only after enough load is applied to separate the close wound coils and accept the initial tension load first.

Additional Notes:

1. Compression springs should be used between 20% and 80% of travel for optimum performance.
2. Compression springs that are over-stressed will take a set prior to full travel.
3. Rates of compression springs with less than two active coils will be subject to a plus or minus 20% load tolerance.
4. Initial tension of extension springs as shown in catalog is for reference only. This factor can vary with tensile of metal.

SPRING WIRE GAUGE
American Steel & Wire Co.

Gauge	Decimal	Gauge	Decimal
4/0	.3938	16	.0625
3/0	.3625	17	.0540
2/0	.3310	18	.0475
1/0	.3065	19	.0410
1	.2830	20	.0348
2	.2625	21	.0317
3	.2437	22	.0286
4	.2253	23	.0258
5	.2070	24	.0230
6	.1920	25	.0204
7	.1770	26	.0180
8	.1620	27	.0173
9	.1483	28	.0162
10	.1350	29	.0150
11	.1205	30	.0140
12	.1055	31	.0132
13	.0915	32	.0128
14	.0800	33	.0118
15	.0720	34	.0104

Basic Formula For Round Wire Compression & Extension Springs

$$R = \frac{Gd^4}{8ND^3}$$

$$S = \frac{8DP}{\pi d^3}$$

R = Rate in Pounds per Inch of Deflection

P = Load in Pounds

D = Mean Diameter—Inches

d = Wire Diameter—Inches

G = Modulus of Elasticity—Steel = 11.5x10⁶ psi

N = Number of Active Coils

S = Torsional Stress—p.s.i.



IBS, INCORPORATED

Springs U03

Compression Springs

IBS No.	O.D. (in)	Free Length (in)	Wire Dia. (in)	Mat'l	Total Coils	Solid Hgt (in)	Calc Rate (in)	Ends	Finish
47006	3/16	1	.014	A	10-1/2	.161	1.25	Closed	Zinc
47005	5/16	1-19/32	.024	B	15-1/2	.360	1.36	Cl/Grd	None
47000	5/16	10	.047	C	76-1/2	3.643	5.06	Closed	Cad.
47007	3/8	3/4	.041	D	6-3/4	.318	22.95	Closed	Zinc
47001	3/8	12	.062	D	119	7.440	5.92	Closed	Zinc
47013	7/16	2-7/8	.076	D	24	1.824	45.95	Cl/Grd	Cad.
47004	1/2	1	.072	D	8	.576	82.12	Cl/Grd	Ziinc
47012	1/2	2-1/2	.062	D	18	1.178	15.80	Closed	Zinc
47010	19/32	2-1/2	.072	D	12	.864	27.32	Cl/Grd	Zinc
47011	5/8	2-3/4	.072	C	15	1.080	17.57	Cl/Grd	Zinc
47002	5/8	12	.062	D	60	3.782	2.05	Closed	Zinc
47009	11/16	4	.105	D	23-1/4	2.441	41.71	Cl/Grd	Zinc
47015	7/8	2-1/32	.122	C	11-7/8	1.449	75.53	Cl/Grd	Gold/lr
47016	7/8	3	.091	D	12-1/2	1.138	19.48	Cl/Grd	Zinc
47003	7/8	12	.080	D	42-2/3	3.493	2.88	Closed	Zinc
47014	15/16	2-1/4	.100	C	10	1.00	30.53	Cl/Grd	Zinc
47006	1-1/64	3-1/8	.058	C	8	.522	3.09	Closed	Zinc
47017	1-1/16	3-5/8	.107	C	12	1.284	21.63	Cl/Grd	Zinc

HARDWARE & SPRINGS

Sold Each

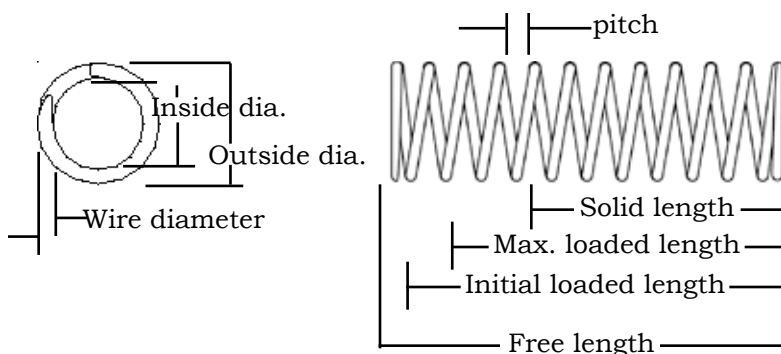

Material Code
A = Music Wire
B = Stainless
C = Spring Steel
D = Hard Drawn

Universal Compression Spring Asst. (Z02)

IBS No.116R • 18 Items - 54 Pcs

Packaged in a locking steel drawer for easy storage and organization

IBS, Inc. SPECIALTY PRODUCTS FOR MAINTENANCE & REPAIR INDUSTRIALMOLT.COM © © © 800-678-1906			Universal Compression Springs	
				Assortment No. 116R
47000 5/16 OD X 10 COMPRESSION*			47004 1/2 OD X 1 COMPRESSION	47005 5/16 OD X 1-19/32
47001 3/8 OD X 12 COMPRESSION*			47006 3/16 OD X 1 COMPRESSION*	47007 3/8 OD X 3/4 COMPRESSION
47002 5/8 OD X 12 COMPRESSION*			47008 1-1/64 OD X 3-1/8 COMPRESSION	
47003 7/8 OD X 12 COMPRESSION*			47009 11/16 OD X 4 COMPRESSION*	
47010 19/32 OD X 2-1/2 COMPRESSION	47011 5/8 OD X 2-3/4 COMPRESSION	47012 1/2 OD X 2-1/2 COMPRESSION	47013 7/16 OD X 2-7/8 COMPRESSION	
47014 15/16 OD X 2-1/4 COMPRESSION	47015 7/8 OD X 2-1/32 COMPRESSION	47016 7/8 OD X 3 COMPRESSION SPRING*	47017 1-1/16 OD X 3-5/8 COMPRESSION	

IBS, INCORPORATED

Springs U03



Extension Springs

IBS No.	O.D. (in)	Length Inside Hooks (in)	Wire Dia (in)	Mat'l	Initial Tension	Calculated Rate (#/in.)	Max. Deflect	Load	Finish
47037	15/64	1-1/32	.023	A	.25	1.63	1.45	2.62	Cad.
47038	1/4	4	.028	A	.49	0.65	5.92	4.33	Zinc
47041	1/4	5	.031	D	.76	0.84	4.75	4.76	Zinc
47035	19/64	13/16	.060	C	9.14	202.48	.10	28.66	Cad.
47042	21/64	5-7/8	.042	C	1.49	1.47	4.87	8.66	Zinc
47036	11/32	1-13/32	.050	C	2.86	18.80	.58	13.75	Zinc
47039	3/8	3	.041	C	.99	1.82	3.26	6.92	Zinc
47040	7/16	4-1/2	.041	C	.71	0.68	7.53	5.84	Zinc
47043	7/16	7	.062	D	4.13	3.87	4.05	19.82	Zinc
47034	1/2	1-5/8	.080	D	9.12	66.23	.41	36.40	Zinc
47030	1/2	9-5/8	.062	C	3.02	1.81	7.72	16.97	Zinc
47044	19/64	5	.075	C	4.63	5.69	3.52	24.64	Gld/Ir
47031	5/8	8-1/2	.072	D	3.45	2.14	8.00	20.60	Zinc
47046	23/32	3-3/16	.120	C	22.77	72.41	.79	79.83	Zinc
47047	47/64	3-7/8	.064	C	1.47	1.93	5.50	12.10	Blk/Ox
47048	3/4	4-1/2	.062	D	1.23	1.19	8.07	10.80	Zinc
47032	13/16	8-1/2	.072	D	1.93	0.92	14.69	15.39	Zinc
47033	1	8-1/2	.091	D	3.26	1.66	12.48	23.99	Zinc
47045	1-1/16	5-1/2	.120	D	9.18	9.51	4.36	50.68	Gld/Ir

HARDWARE & SPRINGS

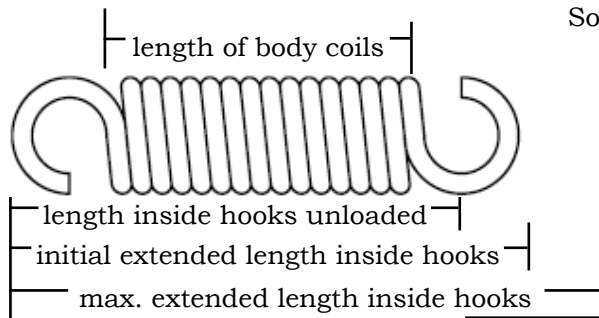

Sold Each

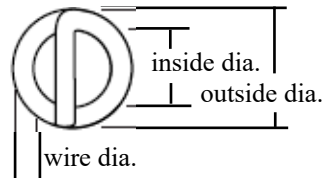

Material Code
A = Music Wire
B = Stainless
C = Spring Steel
D = Hard Drawn

Universal Extension Spring Asst. (Z02)

IBS No. 115R • 18 Items - 70 Pcs

Packaged in a locking steel drawer for easy storage and organization

IBS, Inc. SPECIALTY PRODUCTS FOR MAINTENANCE & REPAIR INDUSTRIALBOLT.COM © P.O. 500-675-1596		Universal Extension Springs	
		Assortment No. 115R	
47030 1/2 OD X 9-5/8 EXTENSION SPRING		47045 1-1/16 OD X 5-1/2' EXTENSION SPRING	
47031 5/8 OD X 8-1/2 EXTENSION SPRING		47044 19/32 OD X 5" EXTENSION SPRING	
47032 13/16 OD X 8-1/2 EXTENSION SPRING		47043 7/16 OD X 7" EXTENSION SPRING	
47033 1" OD X 8-1/2 EXTENSION SPRING		47042 21/64 OD X 5-7/8 EXTENSION SPRING	
47038 1/4 OD X 4" EXTENSION SPRING		47039 3/8 OD X 3" EXTENSION SPRING	
		47040 7/16 OD X 4-1/2 EXTENSION SPRING	
47041 1/4 OD X 5" EXTENSION SPRING			
47034 1/2 OD X 1-5/8 EXTENSION SPRING	47035 19/64 OD X 13/16 EXTENSION SPRING	47036 11/32 OD X 1-13/32 EXTENSION SPRING	47037 15/64 OD X 1-1/32 EXTENSION SPRING
		47046 23/32 OD X 3-3/16 EXTENSION SPRING	47047 47/64 OD X 3-7/8 EXTENSION SPRING



IBS, INCORPORATED

Maintenance Brushes P25

Miscellaneous Brushes

Floor Brushes



- Black Tampico fill
- **Medium** sweeping

FLOOR BRUSHES - MEDIUM

IBS No.	Block	Trim	Qty
42007	18"	3"	1
42008	24"	3"	1

- Black Tampico w/ **middle wire row**
- **Coarse** sweeping

FLOOR BRUSHES - COARSE

IBS No.	Block	Trim	Qty
42135	24"	3"	1



- Assembles in less than 1 minute.
- Handle/sweep connector flexes on impact, providing unbelievable shock absorbency.
- No brace needed.
- Light, easy-to-manuever and easy to manage in low surface areas.

24" PRO-FLEX FLOOR BRUSH

IBS No.	Description	Qty
42000	24" Pro-Flex Floor Brush	1

Floor Squeegees

- Black Neoprene rubber blade.
- Designed for rough, heavy use.



IBS No.	Description	Qty
45510	24" Floor Squeegee	1
45511	36" Floor Squeegee	1

Use with Tapered Wood Handle IBS No. 44020

IBS Service Broom

- Moderate stiffness, large angled trim upright broom has a sturdy metal capped construction and fused polypropylene bristles for superior performance and long life.
- The large angle bristle flare design and comfortable handle allow for fast clean up of a wide variety of jobs.
- Private labeled with the IBS Logo and tagline "The Mark of Our Quality is in Our Service."



IBS No.	Description	Qty
42010	IBS Service Broom	1

Truck Wash Brush

- Fill - Flagged white polystyrene.
- Foam Block Size: 9-1/2 x 2-3/4.
- Trim: 2-1/2".
- Protective Bumper.
- Two handle holes - tapered (44020) and threaded (44301 or 44578)



IBS No.	Description	Qty
44510	Truck Wash Brush	1

Counter Duster

8" MEDIUM - WOOD HANDLE TRIM LENGTH: 2 1/2"

Great for general factory dusting and bench cleaning. Made with grey Tampico - a natural vegetable fiber from the Mexican Century plant. Provides a medium sweeping or brushing action.



IBS No.	Description	Qty
44004	Counter Duster Brush	1

H
A
R
D
W
A
R
E
&
S
P
R
I
N
G
S



Handles & Braces

Metal handles provide a strong and durable alternative to wooden handles. Ideal for industrial and construction applications.

- Plastic Coat Finish - for a smooth & durable scratch & crack-proof coating.
- Comfort Foam Grip - reduces user fatigue & provides a comfortable grip.
- Swivel Hang Cap - Allows a broom to be easily stored, extends broom life.
- Heavy Duty Metal Tip - stronger than standard wooden thread.



Metal Handle with Comfort Grip

METAL HANDLE WITH COMFORT GRIP

IBS No.	Description	Qty
44578	5' Metal Handle Use with Floor Brushes	1

Wood handles are constructed of quality hardwood for long life. Ideal for industrial and construction applications.

PERMA-FLEX HANDLE

IBS No.	Description	Qty
44301	5' Perma-Flex Handle Use with Floor Brushes	2



TAPERED WOOD HANDLE

IBS No.	Description	Qty
44020	5' Tapered Wood Handle Use with Floor Squeegee	2



#2 HEAVY DUTY BRACE

IBS No.	Description	Qty
44290	H.D. Steel Brace Use with IBS No.42135	2



Chip and Oil Brushes

- New and improved to resist damage due to chemicals
- Multi-purpose econoline brushes
- White china bristle with wood handle



IBS No.	Width	Thickness	Bristle Length	Qty
40066	1"	5/16	1-5/8	6
40067	1-1/2"	5/16	1-5/8	6

Parts Cleaning Brush

- Stiff nylon fill
- Steel ferrule Diam. : 1"
- Chisel trim Bristle: 2³/₄"



IBS No.	Description	Qty
40035	Parts & Cleaning Brush	2

Acid Brushes

- Pure black horsehair
- Tin ferrule



IBS No.	Width	Trim	Overall	Qty
44088	5/16	3/4	5-3/4	24
44089	3/8	3/4	5-3/4	24
44090	1/2	3/4	5-3/4	24

4-in-1 Tube Fitting Brush (T03) ONE BRUSH REPLACES FOUR!

Steel Wire. Cleans the outside and inside diameters of 1/2" and 3/4" tubes and fittings. Use for soldering prep, deburring, drill hole cleaning and cleaning battery terminals.



IBS No.	Description	Qty
44690	4-in-1 Tube Fitting Brush	1

H
A
R
D
W
A
R
E
&
S
P
R
I
N
G
S



H
A
R
D
W
A
R
E
&
S
P
R
I
N
G
S



Air Line Fittings

A

Assortments, Air Line

- Automotive Couplers & Plugs & Hose Repair Kit VA-6
- Industrial Couplers & Plugs & Hose Repair Kit VA-5

F

Fittings, Air Line

- 3 in 1 Manifolds VA-12
 - Ball Swivel Connectors
 - ARO Series VA-7
 - Automotive Standard VA-6
 - Industrial Interchange VA-5
 - Blow Guns
 - Accessories
 - Coupler Blow Gun VA-16
 - Non-Safety Tips VA-17
 - Safety Tips VA-14, VA-15, VA-16
 - Coupler Blow Gun VA-16
 - In-Line Blow Gun VA-16
 - Pistol Grip VA-15
 - Super-Flow Blow Gun VA-15
 - Typhoon Max Flow Blow Gun VA-15
 - Vari-Flo Blow Gun VA-15, VA-17
 - Chuck VA-13
 - Couplers & Plugs
 - ARO Series VA-7
 - Auto. Standard VA-6
 - Gen'l Information VA-2
 - Ind. Interchange VA-5
 - Universal Fittings VA-8, VA-9
 - Ferrules, Brass VA-13
 - Hose Crimper VA-13
 - Interchange Chart
 - Coupler Plugs VA-3
 - Couplers VA-2
 - Universal VA-8, VA-9
- ##### Fittings, Airl Line
- Blow Guns
 - Typhoon Plus Blow Gun VA-15

H

Hose

- Accessories
 - Dual Swivel Fitting VA-12
 - ReelTek™ Hose & Reel Assemblies VA-18
 - Repair Fittings for Polyurethane Air Hose VA-11
 - Repair Fittings for Polyurethane Air Hose VA-11
 - Vinyl Hose Guards VA-12
 - Yellow Belly Repair Fittings VA-12

Polyurethane

- Flexeel Reinforced Ball Swivel Lead In Hose VA-11
- Flexeel Reinforced Polyurethane Air Hose VA-11
- Flexeel Reinforced Polyurethane Coiled Air Hose VA-10
- Yellow Belly PVC Air Hose VA-12

T

Tools

- Hand
 - LockNLube Coupler VA-14

W

Water Service

- Couplings & Rubber Washers VA-9



IBS, INCORPORATED

Air Line Accessories V03

Coupler Interchange

IBS	ARO	Auto	Camel	Coilhose	Foster	Hansen	Milton	Parker	Schrader	Tomco
C1	TFCM22	13-124	61-254	162	TF3103	—	786	12	3503	
C1-03	TFCM23-000	C1-03	C1-03	165	TF3303	B21QS-37M	—	B12E	C1-03	2182
C2	TFCF22	13-134	61-523	160	TF3003	—	785	13	3504	
C2-23	TFCF23-000	C2-23	C2-23	161	TF3203	B21QS-37F	—	B13E	C2-23	2185
C2-44	TFCH23-000	C2-44	C2-44	166	TF3703	B21Q-37H	786-6	B10-58	C2-44	2188
C20-42	23102-22	C20-42	C20-42	153	3603	1600	717	B20-3B	C20-42	186
C20-44	23102-24	C20-24	C20-44	156	3703	1700	717-6	B20-5B	C20-44	187
C25-02	23102-12	C25-02	C25-02	583A	4104	410	—	24C	C25-02	T410
C5	—	13-604	61-554	591	TF4304	—	1806	14	3515	
C6	—	13-612	61-553	590	TF4204	—	1805	15	3516	
C7	—	13-602	61-478	593	TF4104	—	—	14C	—	
C8	—	13-610	61-476	592	TF4004	—	1803	15C	3521	
C9	—	13-704	61-564	122	5305	530	1816	16	3511	
C10	—	13-712	61-563	120	5205	520	1815	17	3512	
C20	23102-200	13-234	61-573	150	3003	3000	715	23	5142-12	
C20-23	23102-3	—	61-103	151	3203	3200	718	—	5263-12	
C21	23102-212	13-224	61-574	152	3103	3100	716	22	5141-12	
C21-03	23102-213	—	61-101	155	3303	3300	719	—	5140-12	
C25	23103-313	13-526	61-483	581	4304	4300	1836	24	—	
C26	23103-300	13-536	61-482	580	4204	4200	1835	25	3541	
C27	—	13-424	61-486	—	LN3103	—	790	72	—	
C28	—	13-434	61-548	170	LN3003	—	—	73	3528	
C37	—	13-324	61-527	142	—	—	—	52	3525	
C38	—	13-334	61-526	140	—	—	—	53	3526	

Couplers & Plugs

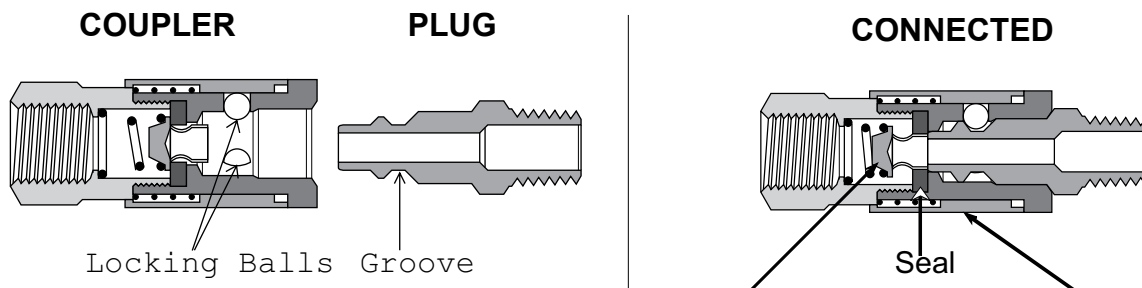

- Quick disconnect couplers are the fastest, easiest and most reliable means of joining pneumatic and fluid transfer lines. All quick disconnect couplers work on the same principle:
- Hardened balls or pins engage a groove in the coupler plug to hold it securely against a soft seal while permitting the assembly to swivel, thereby preventing kinking or twisting of hoses.
- A sliding sleeve releases the locking balls when retracted, permitting the plug to be inserted or removed. The sleeve automatically returns to the locked position when released.
- An automatic shutoff valve in the coupler seals instantly upon uncoupling, eliminating the need for a separate shutoff.



Coupler Plug Interchange

IBS	ARO	Auto	Camel	Coilhose	Foster	Hansen	Milton	Parker	Schrader	Tomco
CP1	TFPM22	12-124	61-538	1601	TF10	—	783	2C	3506	
CP1-03	TFPM23	—	61-150	—	TF14	—	—	2C-E	—	
CP2	TFPF22	12-134	61-539	1602	TF11	—	4784	3C	3507	
CP1-42	TFPH22-000	CP1-42	CP1-42	1606	TF16	21AP-25H	783-4	8C	CP1-42	2164
CP1-44	TFPH23-000	CP1-44	CP1-44	1608	TF17	21AP37H	783-6	9C	CP1-44	2166
CP17-03	23904-10	CP17-03	CP17-03	120A	52-5	52	1859	HOF	CP17-03	T52
CP2-23	TFPF23	—	—	—	TF-15	—	—	3C-E	—	
CP21-42	23902-220	CP21-42	CP21-42	1506	16-3	16	736	H8C	CP21-42	1824
CP21-44	23902-420	CP21-44	CP21-44	1508	17-3	17	736-6	H9C	CP21-44	1826
CP25-02	23903-210	CP25-02	CP25-02	5803	40-4	40	1839	HOE	CP25-02	T40
CP25-44	23903-420	CP25-44	CP25-44	5806	48-4	406	1837-6	H5E	CP25-44	T48
CP26-22	23903-300	CP26-22	CP26-22	5804	43-4	43	1838	H3E	CP26-22	T41
CP5	—	12-604	61-558	5901	TF42	—	107	2E	3517	
CP6	—	12-612	61-559	5902	TF43	—	1808	3E	3518	
CP7	—	12-602	61-480	5903	TF40	—	1809	0E	3519	
CP8	—	12-610	61-481	5904	TF41	—	1810	1E	3520	
CP10	—	12-712	61-569	—	55-5	55	1818	3F	3514	
CP17	23904-410	12-752	61-134	1201	54-5	54	1857	H2F	—	
CP20	23902-200	12-234	61-579	1502	11-3	11	728	H3C	5319-11	
CP20-23	23902-3	12-236	61-107	1505	15-3	15	732	H3C-E	5263-11	
CP21	23902-210	12-224	61-578	1501	10-3	10	727	H2C	5138-11	
CP21-03	23902-310	12-226	61-535	1503	14-3	14	733	H2C-E	—	
CP25	23903-310	12-526	61-484	5801	42-4	42	1837	H2E	3542	
CP26	23903-300	12-536	61-485	5802	43-4	43	1838	H3E	3543	
CP27	—	12-424	61-550	1701	LN11	—	791	L2C	3531	
CP28	—	12-434	61-551	1702	LN10	—	792	L3C	3532	
CP37	2608	12-324	61-528	1401	210-10	1G3	777	A2C	3529	
CP3703	22236	CP37-03	CP37-03	—	—	20AP-37M	—	—	CP37-03	
CP38	2609	12-334	61-529	1402	210-11	1G2	778	A3C	3530	

A
I
R

L
I
N
E

F
I
T
T
I
N
G
S

Features & Benefits

Long Service Life

- Zinc plated to provide a non-corrosive finish.
- Heat treated to harden critical wear points.
- Molded Buna-n seals create a leak proof connection.

Variety of Sizes and Styles

- Available in 1/4", 3/8", and 1/2" bodies with male and female pipe threads, or hose barb ends.

Efficient Performance

- Tubular valve design provides high flow rates.
- Steel locking balls ensure connection holds tight under the most rugged applications.
- Spring loaded sliding outer sleeve allow quick connect/disconnect.

Interchangeability

- Fully interchangeable with couplers and plugs made by other manufacturers. (See accompanying interchange chart.)



Prevost One-Touch Safety Push Button Air Couplers

Ergonomically designed for long lasting comfort

The Prevost One-Touch Safety Push Button Air Coupling meets the top level of quality standards required in the professional industry for quick and effortless coupling.

- **One push control** to decompress the system and disconnect in complete safety: eliminates hose whip to protect the user, surrounding tools and equipment.
- **Silicone free** manufacturing: avoids the risk of contaminating compressed air during the paint or varnish applications which can cause surface imperfections.
- **Functionally designed** to allow a natural grip and easy handling.
- **Composite body material:** anti-scratch body material also allows user to create a firm grip on the coupling.
- **Compact and lightweight** coupling for maximum user comfort when handling repetitively. Provides accuracy and increases work station efficiency.
- Resistant to abrasion, vibrations, corrosion, impacts and crushing: **reinforced composite body** is capable of withstanding the harsh conditions frequently found in production environments.
- **Color coded buttons** make the selection of profiles easy to identify: this system reduces the risk of connection errors which may cause damages or accidents.



INDUSTRIAL - MALE NPT COUPLERS

IBS No.	Body Size	Thread Size	Qty
137714	1/4	1/4 NPT	1



AUTOMOTIVE - MALE NPT COUPLERS

IBS No.	Body Size	Thread Size	Qty
137710	1/4	1/4 NPT	1



INDUSTRIAL - FEMALE NPT COUPLERS

IBS No.	Body Size	Thread Size	Qty
137715	1/4	1/4 NPT	1
137717	3/8	3/8 NPT	1
137770	1/2	3/8 NPT	1
137771	1/2	1/2 NPT	1



AUTOMOTIVE - FEMALE NPT COUPLERS

IBS No.	Body Size	Thread Size	Qty
137711	1/4	1/4 NPT	1
137713	3/8	3/8 NPT	1
137772	1/2	3/8 NPT	1
137773	1/2	1/2 NPT	1



INDUSTRIAL - BARB COUPLERS

IBS No.	Body Size	Thread Size	Qty
137716	1/4	3/8 HOSE BARB	1



AUTOMOTIVE - BARB COUPLERS

IBS No.	Body Size	Thread Size	Qty
137712	1/4	3/8 HOSE BARB	1

A
I
R
L
I
N
E
F
I
T
T
I
N
G
S



Industrial Interchange Series

Plated steel couplers with hardened steel springs

WARNING: Couplers and plugs on these pages are intended for use on compressed air lines only. All have a maximum rated working pressure of 300 PSI.



MALE COUPLERS

NPT End	Body Size			Qty
Male	1/4"	3/8"	1/2"	
1/4" MPT	C21	C25-02		5
3/8" MPT	C21-03	C25		5
1/2" MPT			C9*	5



FEMALE COUPLERS

NPT End	Body Size			Qty
Female	1/4"	3/8"	1/2"	
1/4" FPT	C20			5
3/8" FPT	C20-23	C26		5
1/2" FPT			C10*	5



BARBED COUPLERS

NPT End	Body Size			Qty
Barbed	1/4"	3/8"	1/2"	
1/4" Barbed	C20-42			5
3/8" Barbed	C20-44			5

* 1/2" Coupler is interchangeable with Industrial Interchange and Automotive Standard Series



MALE PLUGS

NPT End	Body Size			Qty
Male	1/4"	3/8"	1/2"	
1/4" MPT	CP21	CP25-02		5
3/8" MPT	CP21-03	CP25	CP17-03	5
1/2" MPT			CP17	5



FEMALE PLUGS

NPT End	Body Size			Qty
Female	1/4"	3/8"	1/2"	
1/4" FPT	CP20	CP26-22		5
3/8" FPT	CP20-23	CP26		5
1/2" FPT			CP18	5



BARBED PLUGS

NPT End	Body Size			Qty
Barbed	1/4"	3/8"	1/2"	
1/4" Barb	CP21-42			5
3/8" Barb	CP21-44	CP25-44		5

- Incorporates the features of an inline filter directly into the pneumatic connector or plug.
- Sintered-bronze filter element protects and extends tool life.
- Back pressure from tool automatically flushes filter.
- Ideal for pneumatic nailers, sanders, etc.

FILTER PLUG

NPT End	Body Size			Qty
Filter Plug	1/4"	3/8"	1/2"	
1/4" MPT	CP21F	CP25-02F		5
3/8" MPT	CP21-03F	CP25F		5
CPF-KIT	Filtering Element Kit			1



- Combines the features of ball swivel fitting & connectors
- Eliminates the need for an additional fitting.
- Provides an ergonomic & lightweight tool to hose connection.
- Connection and nut portion is nickel plated hardened steel and the threaded portion of the fitting is all brass.

BALL SWIVEL CONN

NPT End Size	Body Size			Qty
Ball Swivel	1/4"	3/8"	1/2"	
1/4" FPT	CP20S			5
1/4" MPT	CP21S	CP25-02S		5
3/8" MPT	CP21-03S	CP25S		5



Industrial Couplers, Plugs and Hose Repair Kit
IBS No. 717R • 9 Items • 36 Pcs
Packaged in a locking steel drawer for easy storage and organization



IBS Inc.
QUALITY PRODUCTS FOR PROFESSIONALS & HOBBYISTS
 INDUSTRIALREPAIRKIT.COM © IBS 2006-2010

Industrial Couplers, Plugs and Hose Repair Kit
Assortment No. 717R

<p>C20 1/4 COUPLER 1/4 FPT</p>	<p>VG-6 VINYL GUARD FOR 3/8 AIR HOSE</p>	<p>AM7328 21/32 I.D. FERRULE BRASS</p>	<p>11420 HOSE & TUBING CUTTER UP TO 1-1/4"</p>
<p>C21 1/4 COUPLER 1/4 MPT</p>		<p>10406B-106 3/8 LONG BARB UNION</p>	
<p>CP20 1/4 PLUG 1/4 FPT INDUSTRIAL</p>	<p>10506B-104 3/8 X 1/4 M. LONG BARB H. END</p>		
<p>CP21 1/4 PLUG 1/4 MPT INDUSTRIAL</p>			



IBS, INCORPORATED

Air Line Accessories V03

Automotive Standard Series

WARNING: Couplers and Plugs on these pages are intended for use on compressed air lines only. All have a maximum rated working pressure of 300 PSI.



MALE COUPLERS

NPT End	Body Size			Qty
Male	1/4"	3/8"	1/2"	
1/4" MPT	C1	C7		5
3/8" MPT	C1-03	C5		5
1/2" MPT			C9*	5



FEMALE COUPLERS

NPT End	Body Size			Qty
Female	1/4"	3/8"	1/2"	
1/4" FPT	C2	C8		5
3/8" FPT	C2-23	C6		5
1/2" FPT			C10*	5



BARBED COUPLERS

NPT End	Body Size			Qty
Barbed	1/4"	3/8"	1/2"	
1/4" Barb	C2-42			5
3/8" Barb	C2-44			5

* 1/2" Coupler is interchangeable with Industrial Interchange and Automotive Standard Series



MALE PLUGS

NPT End	Body Size			Qty
Male	1/4"	3/8"	1/2"	
1/4" MPT	CP1	CP7		5
3/8" MPT	CP1-03	CP5		5
1/2" MPT			CP9	5



FEMALE PLUGS

NPT End	Body Size			Qty
Female	1/4"	3/8"	1/2"	
1/4" FPT	CP2	CP8		5
3/8" FPT	CP2-23	CP6		5
1/2" FPT			CP10	5



BARBED PLUGS

NPT End	Body Size			Qty
Barbed	1/4"	3/8"	1/2"	
1/4" Barb	CP1-42			5
3/8" Barb	CP1-44			5

- Incorporates the features of an inline filter directly into the pneumatic connector or plug.
- Sintered-bronze filter element protects and extends tool life.
- Back pressure from tool automatically flushes filter.
- Ideal for pneumatic nailers, sanders, etc.

FILTER PLUG

NPT End	Body Size		Qty
Filter Plug	1/4"		
1/4" MPT	CP1F		5



- Combines the features of ball swivel fitting & connectors
- Eliminates the need for an additional fitting.
- Provides an ergonomic & lightweight tool to hose connection.
- Connection and nut portion is nickel plated hardened steel and the threaded portion of the fitting is all brass.

BALL SWIVEL CONN

NPT End	Body Size		Qty
Ball Swivel	1/4"	3/8"	
1/4" FPT	CP2S		5
1/4" MPT	CP1S	CP7S	5
3/8" MPT	CP1-03S	CP5S	5



Automotive Couplers, Plugs and Hose Repair Kit

IBS No. 719R • 9 Items • 36 Pcs

Packaged in a locking steel drawer for easy storage and organization



IBS, Inc.
SPECIALTY PRODUCTS FOR MAINTENANCE & REPAIR
INDUSTRIALBOLT.COM • © • 800-878-1996

Automotive Couplers, Plugs and Hose Repair Kit

Assortment No. 719R

<p>C2 1/4 COUPLER 1/4 FPT AUTO</p>	<p>VG-6 VINYL GUARD FOR 3/8 AIR HOSE</p>	<p>AM7328 21/32 I.D. FERRULE BRASS</p>	<p>11420 HOSE & TUBING CUTTER UP TO 1-1/4</p>
<p>C1 1/4 COUPLER 1/4 MPT AUTO</p>	<p>10506B-104 3/8 X 1/4 M. LONG BARB H. END</p>	<p>10406B-106 3/8 LONG BARB UNION</p>	
<p>CP2 1/4 PLUG 1/4 FPT AUTO</p>			
<p>CP1 1/4 PLUG 1/4 MPT AUTO</p>			

IBS, INCORPORATED

Air Line Accessories V03



The ARO Series

This series of couplers and connectors is engineered to interchange with ARO design as well as similar designs of other manufacturers.



MALE COUPLERS

NPT End	Body Size			Qty
Male	1/4"	3/8"	1/2"	
1/4" MPT	C37			5



FEMALE COUPLERS

NPT End	Body Size			Qty
Female	1/4"	3/8"	1/2"	
1/4" FPT	C38			5



MALE PLUGS

NPT End	Body Size			Qty
Male	1/4"	3/8"	1/2"	
1/4" MPT	CP37			5



FEMALE PLUGS

NPT End	Body Size			Qty
Male	1/4"	3/8"	1/2"	
1/4" FPT	CP38			5

- Incorporates the features of an inline filter directly into the pneumatic connector or plug.
- Sintered-bronze filter element protects and extends tool life.
- Back pressure from tool automatically flushes filter.
- Ideal for pneumatic nailers, sanders, etc.

FILTER PLUG

NPT End	Body Size			Qty
Filter Plug	1/4"	3/8"	1/2"	
1/4" MPT	CP37F			5
3/8" MPT	CP38F			5
CPF-KIT	Filtering Element Kit			1



- Combines the features of ball swivel fitting & connectors
- Eliminates the need for an additional fitting.
- Provides an ergonomic & lightweight tool to hose connection.
- Connection and nut portion is nickel plated hardened steel and the threaded portion of the fitting is all brass.

BALL SWIVEL CONN

NPT End	Body Size			Qty
Ball Swivel	1/4"	3/8"	1/2"	
1/4" FPT	CP38S			5
1/4" MPT	CP37S			5
3/8" MPT	CP37-03S			5



Hi-Flo Couplers & Plugs

Hi-Flo series couplers and plugs are engineered to allow twice the flow of comparably-sized standard couplers and plugs. The flow rates on the 1/4" size are greater than many 3/8" body size couplers. Increased air flow results in greater tool efficiency and decreased air costs.

Ideal for High Volume and Low Pressure applications such as drills, grinders, sprayers and impact guns.

- Hi-Flo couplers will accept INDUSTRIAL and ARO style plugs — however to retain maximum flow, use Hi-Flo style plugs.
- Maximum inlet pressure: 300 PSI
- Maximum temperature: 250°F
- Air Flow: 40 SCFM @ 100 PSI
- Seals: Buna-N



MALE COUPLERS

NPT End	Body Size			Qty
Male	1/4"			
1/4" MPT	C91			5
3/8" MPT	C91-03			5



MALE PLUGS

NPT End	Body Size			Qty
Male	1/4"			
1/4" MPT	CP91			5
3/8" MPT	CP91-03			5



FEMALE COUPLERS

NPT End	Body Size			Qty
Female	1/4"			
1/4" FPT	C90			5
3/8" FPT	C90-23			5



FEMALE PLUGS

NPT End	Body Size			Qty
Female	1/4"			
1/4" FPT	CP90			5
3/8" FPT	CP90-23			5

AIR LINE FITTINGS



IBS, INCORPORATED

Air Line Accessories V03

Lincoln Interchange Series

Warning: Couplers and Plugs listed below are intended for use on compressed air lines only. All have a maximum rated working pressure of 250 PSI.



MALE COUPLERS

NPT End	Body Size			Qty
Male	1/4"	3/8"	1/2"	
1/4" MPT	C27			5



FEMALE COUPLERS

NPT End	Body Size			Qty
Female	1/4"	3/8"	1/2"	
1/4" FPT	C28			5



MALE PLUGS

NPT End	Body Size			Qty
Male	1/4"	3/8"	1/2"	
1/4" MPT	CP27			5



FEMALE PLUGS

NPT End	Body Size			Qty
Male	1/4"	3/8"	1/2"	
1/4" FPT	CP28			5

A
I
R

L
I
N
E

F
I
T
T
I
N
G
S

Universal Safety Couplers



- 5-in-1 coupler eliminates the guesswork and inconvenience of matching interchanges — fits Industrial, ARO, Automotive / Tru-Flate, Euro (Megaflo) and Lincoln 1/4," 3/8," & 1/2" series plugs.
- Designed to remain connected to the plug until the downstream air is completely bled off. Reduces the possibility of injury to personnel or damage to surrounding equipment from a whipping hose.
- Steel construction



MALE NPT COUPLER

Body Size	Thread Size	IBS No.	Qty
1/4	1/4-18	137720	1
	3/8-18	137723	1
3/8	1/4-18	137726	1
	3/8-18	137729	1
	1/2-14	137732	1
1/2	3/8-18	137735	1
	1/2-14	137738	1
	3/4-14	137741	1



FEMALE NPT COUPLER

Body Size	Thread Size	IBS No.	Qty
1/4	1/4-18	137721	1
	3/8-18	137724	1
3/8	1/4-18	137727	1
	3/8-18	137730	1
	1/2-14	137733	1
1/2	3/8-18	137736	1
	1/2-14	137739	1
	3/4-14	137742	1



HOSE BARB COUPLER

Body Size	Hose Barb Size	IBS No.	Qty
1/4	1/4	137722	1
	3/8	137725	1
3/8	1/4	137728	1
	3/8	137731	1
	1/2	137734	1
1/2	3/8	137737	1
	1/2	137740	1
	3/4	137743	1



Water Service Couplings

These water service couplings are ideal for use wherever water hoses are frequently connected and disconnected. They have a wide variety of applications which include garden hoses, wash down systems and mobile water tank lines.

- Valveless design permits maximum flow with minimum pressure drop.
- Brass and stainless steel construction for heavy duty service.
- Durable four ball locking mechanism for secure connections.
- Quality, temperature-resistant nitrile seals for a leak-free service life.



WATER SERVICE COUPLINGS

IBS No.	Description	Body Size	Thread Size	Qty
C1160	Coupler	3/4"	3/4 -11-1/2	5
CP1170	Nipple	3/4"	3/4 -11-1/2	5
CP1165	Rubber Washers			5

Universal Airline Fittings

- Fits Industrial, Automotive, and ARO 1/4" series plugs.
- Brass construction for durability and long life.
- Durable four ball locking mechanism for secure connections.
- Unique design keeps locking ring cocked when uncoupled allowing for quick, easy coupling with plugs. Simply push the coupling onto the plug and the locking ring snaps into place for a secure connection.



UNIVERSAL AIRLINE FITTINGS

IBS No.	Description	Qty
UC1	Female NPT	5
UC2	Male NPT	5

AIR LINE FITTINGS



IBS, INCORPORATED

Air Line Accessories V03

Flexeel® Reinforced Polyurethane Coiled Air Hose

Flexeel® is the original reinforced polyurethane self-storing hose. This extremely lightweight hose is extruded with an inner braid for additional strength, and this "integral piece" process eliminates the need of bonding individual layers of tubing, braiding and cover which tend to separate over time due to bending, flexing and pulsating. Flexeel® combines the durability of bulkier hoses with the kink resistance and elasticity of polyurethane to make a tough, long-lasting hose that is user-friendly.

AIR LINE FITTINGS

- Super flexible — 100% kink-proof Inner tube, braiding & outer cover will not separate
- Tight bend radius minimizes space requirements
- Rugged brass swivel fittings provide long life and minimal flow restrictions
- State-of-the-art strain relief system protects the hose and increases its maneuverability
- All swivel fittings include reusable thread sealant pre-applied at the factory
- Low tension retractability — minimizes user fatigue
- Abrasion resistant
- Soft Polyurethane material will not mar finishes
- Strong enough to repel most oils and chemicals
- 16" tail on the working (tool) end eliminates tangling of the tool coils
- 8" tail on the supply end makes the connection to the air source easy
- More durable and lighter weight than rubber hose — easy to handle
- Transparent yellow color



SPECIFICATIONS

Material:

- Inner Tube & Outer Cover — 85 Durometer Polyurethane
- Inner Braiding — Dacron Polyester
- Withstands 200 psi working pressure
- Factory applied thread sealant supplied on male swivel fitting
- Temperature Range: -40°F to 165°F

FLEXEEL REINFORCED POLYURETHANE COILED AIR HOSE with Reusable Strain Relief

IBS No.	I.D. x O.D. x L	FTG MPT	Working Pressure @ 70°F
130480	1/4 x 3/8 x 10'	1/4 S	200 psi
130481	1/4 x 3/8 x 15'	1/4 S	200 psi
130482	1/4 x 3/8 x 25'	1/4 S	200 psi
<i>Coil O.D. = 1-3/4" S = Swivel</i>			
130484	3/8 x 9/16 x 10'	3/8 S	200 psi
130485	3/8 x 9/16 x 25'	3/8 S	200 psi
<i>Coil O.D. = 2-7/8" S = Swivel</i>			



Flexeel® Reinforced Polyurethane Air Hose

Flexeel® Polyurethane Reinforced Hose offers an excellent alternative to much bulkier rubber and plastic hoses. Extremely lightweight and tough, it is ideal for either outdoor contractor use or indoor industrial use. Flexeel® retains its flexibility even in cold environments. The reinforced construction eliminates the possibility of having the various layers separate due to constant expansion and contraction during pulsating operations, such as with staple or nail guns. Reusable strain relief fittings are included.

Features:

- Lightest hose available
- Contemporary looking state-of-the-art strain relief system allows the hose to bend freely without kinking
- In the field repairs can be made quickly and easily with commercially available hose barbs and clamps — no special kits or hard to find fittings are needed
- Lays out flat and can be coiled into a loop even in sub-zero conditions
- Extremely tough and abrasion resistant
- Braiding, inner tube and outer cover will not separate
- Withstands 200 PSI working pressure
- Temperature Range: - 40°F to 165°F
- Available in yellow



FLEXEEL REINFORCED POLYURETHANE AIR HOSE with Reusable Strain Relief

IBS No.	I.D. x O.D. x L	FTG MPT	Working Pressure @ 70°F
130490	1/4 x 3/8 x 25'	1/4	200 psi
130491	1/4 x 3/8 x 50'	1/4	200 psi
130492	1/4 x 3/8 x 100'	1/4	200 psi
130493	3/8 x 9/16 x 25'	1/4	200 psi
130494	3/8 x 9/16 x 50'	1/4	200 psi
130495	3/8 x 9/16 x 100'	1/4	200 psi
130496	3/8 x 9/16 x 25'	3/8	200 psi
130497	3/8 x 9/16 x 50'	3/8	200 psi
130498	3/8 x 9/16 x 100'	3/8	200 psi



FLEXEEL REINFORCED POLYURETHANE AIR HOSE (BULK)

IBS No.	I.D. x O.D. x L	FTG IND	Working Pressure @ 70°F
130500	1/4 x 3/8 x any length	1/4	200 psi
130501	3/8 x 9/16 x any length	3/8	200 psi

Repair Fittings for Air Hose



REPAIR FITTINGS for Polyurethane Hose

IBS No.	Description	Qty
130788	Splicer for 1/4" Air Hose	1
130789	Splicer for 3/8" Air Hose	1
130790	1/4" NPT x 1/4" Hose Swivel / Strain	1
130791	1/4" NPT x 3/8" Hose Swivel / Strain	1
130792	3/8" NPT x 3/8" Hose Swivel / Strain	1



- Shock absorbing whip hose
- Ball swivel provides additional range of motion
- Maximum working pressure @ 70°F: 200psi

FLEXEEL REINFORCED BALL SWIVEL LEAD IN HOSE

IBS No.	FTG NPT	Hose ID	Hose Length	Working Pressure @ 70°F
130460	1/4	1/4	30"	200 psi
130461	1/4	1/4	60"	200 psi
130462	1/4	3/8	30"	200 psi
130463	1/4	3/8	60"	200 psi

AIR LINE FITTINGS



IBS, INCORPORATED

Air Line Accessories V03

AIR LINE FITTINGS

Yellow Belly PVC Air Hose



High Visibility Hose with Male NPT Rigid Ends

Yellow Belly Hybrid PVC Air Hose is constructed of a lightweight yet durable hybrid PVC material, and offers an superior alternative to the traditional rubber air hose.

- Half the weight of traditional rubber hose makes it easier to work with.
- Stays flexible in cold weather down to -40°F makes it ideal for colder, outdoor environments.
- Lays flat on the ground and resists kinking for safer use with less chance of tripping over or getting caught.
- Higher working pressure than traditional rubber hose — 300 psi vs 200 psi.
- Bright yellow color makes for improved shop safety.

Hose Material: Hybrid PVC resin

Working Pressure: 300 PSI

Temperature Range: -40°F to +200°F

Good Abrasion Resistance

Good Chemical Resistance

IBS No.	Hose ID (in.)	Length (ft.)	Fitting	Pkg Qty
130530	1/4	50	1/4" NPT Male	1
130531	1/4	100	1/4" NPT Male	1
130532	3/8	50	1/4" NPT Male	1
130533	3/8	100	1/4" NPT Male	1

Yellow Belly Repair Fittings



- Machined from quality brass stock
- Assembled with minimal tools
- Made in the USA

IBS No.	Hose ID (in.)	Fitting	Pkg Qty
130534	1/4	1/4" MPT Repair Fitting	1
130535	3/8	1/4" MPT Repair Fitting	1
130536	1/4	1/4" Splicer Yellow Belly Hose	1
130537	3/8	3/8" Splicer Yellow Belly Hose	1

Vinyl Hose Guards

Extends the life of your air hose as much as 75%! Vinyl Hose Guards are just as effective as metal spring guards yet the are less expensive and less cumbersome. They won't catch or scratch finished surfaces in manufacturing or auto repair applications. To install simply heat the Vinyl Hose Guard by inserting it into a bucket of hot water for a few minutes, or use a heat lamp, to expand it and slip it over the hose end. Allow it a couple minutes to cool down. Once it cools it will contract around the hose end providing a snug fit.



IBS No.	Description	Size	Qty
VG-4	Vinyl Hose Guards	1/4	2
VG-6		3/8	2

3 in 1 Manifolds

- Strong, lightweight machined aluminum construction.
- Supply 3 air operated tools from a single supply hose.
- Mount to pipe at workbench or overhead.
- Mount 3 different style couplers on one manifold.



IBS No.	Description	Inlet Thread	Outlet Thread	Qty
3404A	3 in 1 Manifold	1/4 NPT	1/4 NPT	1
3406A		3/8 NPT	3/8 NPT	1

Dual Swivel Fitting

Allows a full 360° rotation which eliminates the tool and hose from working against one another, reducing operator frustration and fatigue.



IBS No.	Description	Qty
130529	Dual Swivel Fitting 1/4"	1

IBS, INCORPORATED

Air Line Accessories V03



Hose Crimper (T03)

- Provides production capability for crimping standard hose.
- Gives "big tool" crimping advantages at just a fraction of the cost.
- Comes with 5 dies to crimp 1/4"-3/8" ID hose in either one or two braid design.
- Die Sizes: 5/8" 37/64" 17/32" 31/64" 11/16"
- Rugged Construction: High strength ductile iron casting.
- Self-contained & Portable: All dies in one place, ready for use.
- One-hand operation: Positive camming action allows for good leverage at end of lever stroke.



IBS No.	Description	Qty
AM855	Hose Crimper	1

Brass Ferrules

Use with standard hose barb fittings to make perfect connections to hose. Select ferrule I.D. dimension to closely match your hose O.D.



IBS No.	Description	ID	Qty
AM7325	Brass Ferrules	9/16	25
AM7326		39/64	25
AM7328		21/32	25
AM7329		11/16	25
AM7330		.725	25
AM7331		3/4	25

Tire Inflator Gauge

- Heavy, chrome plated castings with protective vinyl sleeve over dial tube.
- All brass internal parts.
- Plated steel is riveted to body - will not come off.
- Solid brass triangle dial with extra large markings can be read easily from any angle.
- Valve and dial units easily replaced in the field.
- Calibrated 10 - 120 psi in 2 psi increments.
- 12" hose with swivel dual-foot chuck.



IBS No.	Description	Qty
101D	Tire Inflator Gauge	1

Air Line Chuck

- Ball Foot Chuck with Clip
- 1/4" NPT Female
- LIVE Air Line Only



IBS No.	Description	Qty
10979	Air Line Chuck	1

AIR LINE FITTINGS



IBS, INCORPORATED

Air Line Accessories V03

LockNFlate Air Chuck

DEPRESS THE THUMB LEVER & PUSH ON THE TIRE VALVE, RELEASE THE LEVER TO SECURE THE AIR CHUCK & CREATE A LEAK-FREE CONNECTION!

LOCKS ON STAYS ON WON'T LEAK!



IBS No. 5858

SLIDING SLEEVE SECURELY LOCKS THE AIR CHUCK ONTO THE SHRADER VALVE

HARDENED STEEL COLLET FITS ALL SHRADER VALVES RATED TO 150 PSI

SECURE - HANDS-FREE - LEAK-FREE

- **REVOLUTIONARY DESIGN** six steel jaws lock onto any Schrader valve to create a secure, hands free connection.
- **1/4" NPT THREAD SIZE** compatible with most standard air hoses.
- **HARDENED STEEL COLLET** Fits ALL standard Schrader valves (VG8 /8V1 valve threads).
- **RATED TO 150 PSI** Suitable for garage & Industrial systems, auto and manual tire inflators, portable pressure gauges & constant pressure systems.
- **HEAVY DUTY CONSTRUCTION** is built to last and stand up to everyday use even in the busiest tire shops, service bays and garages.
- **DURABLE, SPRING LOADED TPU SEAL** Inflates tires with or without the core valve in place .

IBS No.	Description	Qty
5858	LockNFlate Air Chuck	1

DUAL WHEEL LOCKING AIR CHUCK



Two-jaw locking design with a patented remote actuator.

Extended reach to securely inflate duals.

Easily disconnect with the actuator. No need to reach in to disconnect.

Best for airing up inner wheels on semis and other large trucks.

- **Fixed Head** won't swivel or move when trying to attached.
- **Long Reach** for easier access to second wheels and harder to reach areas.
- Blue **Silicone Grip** for better ergonomics and hold.
- Standard **1/4" FNPT** thread for easy connection to air lines
- Overall Length: **15.5 in.** (40 cm.)
- Maximum pressure: **150 PSI** (10.3 BAR)



The Dual Locking Head allows you to push onto valves facing towards you, or pull onto valves facing away from you.

HOW TO USE: Pull the blue actuator collar back towards you to release the front jaws and push the collar away from you to release the rear jaws.

IBS No.	Description	Qty
5859	Dual Wheel Locking Air Chuck	1

AIR LINE FITTINGS

IBS, INCORPORATED

Air Line Accessories V03



Typhoon Max Flow Blow Gun

Our most powerful blowgun. Perfect for high-volume industrial cleanup and blow-off operations. Delivers 34 CFM maximum blowing volume with a thrust of over 2 pounds at 125 psi.



- **Tapered high-flow tip** allows access to hard-to-reach areas for more thorough and complete cleanup saving users time and money.
- **Light-weight and ergonomic design** provides more comfort for users, making them more productive and less likely for fatigue and injury.
- **Meets OSHA standard** 1910.95 for noise levels and standard 1910.242B for dead-end pressure to keep users safe and reducing injuries.
- **Variable flow trigger** for controlled blow-off allows for minimum or maximum pressure in areas where gentler or stronger pressure is required, avoiding damage or overblowing keeping debris better contained for less mess and faster cleanup – saves users time and money.
- OSHA 1910.242B, OSHA 1910.95

IBS No.	Description	Qty
130516	Typhoon Max Flow Blow Gun	1

Typhoon Plus Blow Gun

The Typhoon Plus Blow Gun is an ergonomic pistol grip blow gun made from durable high-performance polymer. The body and tip are designed to be non-marring, helping prevent scratches and scuffs on delicate or painted surfaces. The blow gun is OSHA compliant and an adjusting knob allows for precise flow control.



- **Durable polymer construction** provides the perfect combination of lightweight convenience with strength and durability.
- **Maximum power and performance with built-in airflow adjusting knob** to set the perfect amount for the job.
- **Non-marring body and tip** won't damage the surface when it comes into contact.
- **1/4" NPT inlet** for easy connectivity.
- OSHA Compliant.

IBS No.	Description	Qty
130517	Typhoon Plus Blow Gun	1

Super-Flow Blow Gun

- Specially designed tip has larger holes and more of them, which translates to more blow off power.
- Special internal valve designed to provide high power and maximum efficiency at the tip.
- Combines comfort, style, efficiency and economy while delivering more CFM (Cubic Feet per Minute) than any other lever operated blow gun.
- Ergonomically designed to fit the natural contour of the user's hand, maximizing comfort even during long term use.
- Provides a wider range of motion to direct the additional working capacity right where it's needed, resulting in increased blow-off efficiency.
- Unique thermoplastic wrap around body cover gives a distinctive look and maximizes user comfort.
- Unique tip design still meets safety requirements while offering superior air delivery.
- Full size hanging hook makes gun easy to store and use.
- Conforms to OSHA Standards for both psi dead-ended pressure and noise level exposure.



IBS No.	Description	Qty
130550	Super Flow Blow Gun	1

Pistol Grip Blow Guns

- Variable flow control for precise air delivery.
- Lightweight and ergonomic design reduces user fatigue.
- Brass reinforced inlet 1/4" FPT to fit standard hose ends and coupling plugs.
- IBS No. 130504 will support a variety of standard blow gun tips to suit any application.



**SAFETY WHISPER TIP
PISTOL GRIP BLOW GUN**

IBS No.	Description	Qty
130505	Permanently attached slender 4-1/4" bent nickel plated brass nozzle and a "star-tip" prevents dead-ending. This is a safety grip blow gun and the body color is black.	1

AIR LINE FITTINGS



IBS, INCORPORATED

Air Line Accessories V03

A
I
R

L
I
N
E

F
I
T
T
I
N
G
S



SAFETY TIP PISTOL GRIP BLOW GUN

IBS No.	Description	Qty
130504	Features a nickel plated brass 1/8" female NPT adapter to accommodate all other tips. Body color is black.	1

In-Line Blow Gun

This in-line blow gun is compact, durable and provides maximum flow. The blow gun's small size and light weight make it ideal for at-the-tool use. This allows users to quickly clean off a workspace without changing tools. The chrome-plated body will hold up in even the harshest environments. Ideal for use with pneumatic grinders and sanders.

- Unique "full-flow" straight-through design will not restrict downstream air flow.
- 1/4" supply ports; 1/8" nozzle port.
- Made of zinc and chrome-plate for durability and superior corrosion resistance.



Specifications:

Pressure Rating 150 PSI
Operating Temperature 32°F - +175°F

Material:

Body: Chrome plated die cast
Internals: Nickel plated brass
Stainless steel spring

Length: 1-7/8"
Width: 3/4"
Height: 1-5/8"
Weight: 0.2 lbs.

IBS No.	Description	Qty
130520	In-Line Blow Gun	1

Coupler Blow Gun A Blow Gun on Every Hose!



An innovative combination quick coupling and blow gun in one! This convenient unit is perfect for metalworking or woodworking operations, which often produce shavings or sawdust making it difficult to view the work surface.

A quick burst or two from the Coupler Blow Gun Combo allows the operator to get back to work quickly and easily without needing to disconnect the tool, connect a dedicated blowgun and then reconnect the tool.

The Coupler Blow Gun Combo can be used with an air tool connected or disconnected and is currently available in our most popular 1/4" Industrial Interchange

- High quality six ball coupler for a secure and lasting connection.
- Already on your hose and ready to use allows the user to clean off a workspace without changing tools.
- Easy push button trigger located at the base of the tool for quick activation.
- Trigger location (on the back of the coupler) allows the blow gun portion to be used with a tool connected or disconnected for convenient use.
- Max working pressure: 120 PSI.
- 1/4" Industrial with 1/4" female NPT.

IBS No.	Description	Qty
130522	Coupler Blow Gun Combo 1/4 FPT Industrial	1
130523	Coupler Blow Gun Combo 1/4 FPT ARO	1
130524	Coupler Blow Gun Combo 1/4 FPT Automotive	1
130525	Coupler Blow Gun Combo 1/4 FPT Hi-Flow	1

IBS, INCORPORATED

Air Line Accessories V03



Vari-Flo Blow Gun



- Tough zinc die-cast body that is made to last even in the harshest environments.
- Ergonomic design of the body and large operating lever reduce user fatigue and discomfort, even during long term use.
- Chrome-plated finish for an attractive appearance and superior corrosion resistance
- Supplied with 1/4" NPT female outlet thread for use with the most standard blow gun tips.
- 1/8" NPT female outlet thread for use with most standard blow gun tips.
- Conforms to OSHA standards for noise levels (1910.95) and less than 30 PSI dead-ended pressure (1910.242B).
- Four self-lubricating "O-Rings" prevent valve leakage, making blow gun repairs unnecessary.

Specifications:

Pressure Rating: 150 psi
 Operating Temperature: 32° to 175°F
 Body: Die Cast Zinc (Chrome Plated)
 Nozzle: Brass
 Thumb Grip: Vinyl
 Internal Components: Brass

IBS No.	Description	Qty
130502	Vari-Flo Blow Gun with Safety Tip	1

Blow Gun Non-Safety Tips

RUBBER TIP



IBS No.	Description	Qty
130513	Soft rubber tip with nickel-plated brass base will not scratch or mar delicate surfaces.	1

NICKEL PLATED BRASS



IBS No.	Description	Qty
130515	Basic tip for blow off applications where a narrow, concentrated stream of air is required.	1

NOTE

Safety Tips do not have a safety by-pass and must be used on air lines that have a regulated maximum pressure of 30 psi in order to comply with OSHA standards.

Blow Gun Safety Tips



NICKEL PLATED BRASS BOOSTER TIP

IBS No.	Description	Qty
130507	Multiple holes create a venturi effect which increases air flow and working capacity.	1



NICKEL PLATED BRASS SAFETY TIP

IBS No.	Description	Qty
130506	General purpose tip for blowing away dust, chips, etc.	1



NICKEL PLATED STEEL STRAIGHT REPLACEMENT TIPS

IBS No.	Description	Qty
130509	3" Extension Tip	1
130510	6" Extension Tip	1
130511	12" Extension Tip	1
130512	24" Extension Tip	1

MEETS SAFETY STANDARDS

OSHA standard 1910.242 (B) permitting a maximum of 30 psi outlet pressure when dead ended with a maximum of 150 psi inlet pressure
 OSHA standard 1910.95 regulating occupational noise level exposure.

AIR LINE FITTINGS



IBS, INCORPORATED

Miscellaneous Tools T03

ReelTek™

Air / Water Reels for Light Industrial Use

A new, lighter spring-driven hose reel designed for applications that are less demanding, yet require a product that can withstand industrial use. ReelTek's hybrid design incorporates industrial-grade steel and composite materials to virtually eliminate corrosion.

Easy-to-install and maintain, ReelTek™ conveniently keeps hoses organized for a more efficient, safer work area. Simply pull out the hose to the desired length, lock into position during use, and retract when finished. Hoses stored on reel last five times longer, stay out-of-sight, and out-of-the-way.

REELTEK™ HOSE & REEL ASSEMBLIES

IBS No.	Description	Qty
131271	Reel for 1/4" x 50' Hose 1/4" x 50' Flexeel Hose Rubber Stopper	1
131293	Reel for 1/4" x 50' Hose 1/4" x 35' Flexeel Hose Rubber Stopper	1
131272	Reel for 3/8" x 50' Hose 3/8" x 50' Flexeel Hose Rubber Stopper	1
131294	Reel for 3/8" x 50' Hose 3/8" x 25' Flexeel Hose Rubber Stopper	1

REELTEK™ HOSE REELS

IBS No.	Description	Qty
131184	Reel for 1/4" x 50' Hose	1
131185	Reel for 3/8" x 50' Hose	1

REPLACEMENT HOSE

IBS No.	Description	Qty
130491	1/4" x 50' Flexeel Polyurethane Air Hose	1
130494	3/8" x 50' Flexeel Polyurethane Air Hose	1

ACCESSORIES

IBS No.	Description	Qty
131186	Rubber Stopper	1

Hose Sold Separately

Long-Lasting Latch Spring
Stainless steel torsion spring on the latch insures maximum life.

Corrosion Resistance
Steel components are powder-coated & combined with composite materials, which virtually eliminates corrosion

Long Swivel Life
Field-proven swivel assures long service life

Hose Retracts Every Time
Latch mechanism is mounted on the arm to ensure hose extends and retracts every time.

Versatile Mounting
Guide arm can be adjusted to 7 convenient locations

Structural Strength
The base & guide arm are made of heavy gauge steel stampings.

Easy to Mount
Guide has two slotted holes for easy mounting and adjustment.

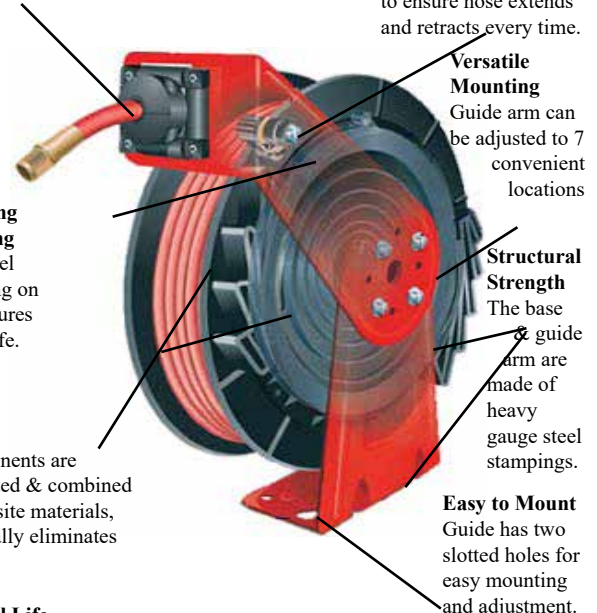

Installation . . . Easy as 1, 2, 3



Step 1
Locate stud & layout bolt hole pattern of the reel. Drill pilot holes into the stud



Step 2
Thread lag screws into pilot holes.



Step 3
Hang reel onto lag screws. Securely tighten lag screws. Ready to use.

ReelTek is ideal for . . .

- Light industrial
- Air-powered tools
- Assembly lines
- Machine shops
- Maintenance shops
- Auto / truck repair
- Auto Paint & Body
- Farm & ranch
- Woodworking
- Garden shops
- Home workshops
- Many more uses

AIR LINE FITTINGS

IBS, INCORPORATED

Air Line Accessories V03



Pressure Washer Couplers & Coupler Plugs

Pressure washer couplers offer a straight through design — which means they contain no valving, which increases flow through the connection.

- **Standard interchange style** works with Parker, Hansen, Foster, Adams and others.
- **No internal valves**, providing maximum flow with minimum pressure drop.
- **Ideal for** fluid transfer lines, pressure washers, high pressure water, steam washers and carpet cleaners.

BRASS COUPLERS



MPT FPT Straight

STAINLESS COUPLERS



MPT Straight FPT Straight

IBS No.	Description	Qty
CST3B	1/4 MPT Straight Through Coupler Brass	1
CST4B	1/4 FPT Straight Through Coupler Brass	1
CST5B	3/8 MPT Straight Through Coupler Brass	1
CST6B	3/8 FPT Straight Through Coupler Brass	1
CST7B	1/2 MPT Straight Through Coupler Brass	1
CST8B	1/2 FPT Straight Through Coupler Brass	1
CPST3	1/4 MPT Straight Through Coupler Plug Steel	1
CPST4	1/4 FPT Straight Through Coupler Plug Steel	1
CPST5	3/8 MPT Straight Through Coupler Plug Steel	1
CPST6	3/8 FPT Straight Through Coupler Plug Steel	1
CPST7	1/2 MPT Straight Through Coupler Plug Steel	1
CPST8	1/2 FPT Straight Through Coupler Plug Steel	1

Quick Disconnect Nozzles for Pressure Washers

Nozzles are color-coded and rated at 4.0 GPM @ 4000 PSI



- **RED = 0-degree** nozzle, delivers a small, very concentrated stream of water. This nozzle is typically used for tough stains and debris from concrete and metal. Do not use this nozzle on wood or siding as this stream is very strong and powerful, and can damage a soft surface.
- **YELLOW = 15-degree** is typically used for surface preparation such as removing dirt, mildew or paint, and can be used on most surfaces.
- **GREEN = 25-degree** nozzle is best used to sweep away dirt and mud. Use it to sweep way leaves from decks, driveways and sidewalks.
- **WHITE = 40-degree** nozzle is the best nozzle to start with. It has a wide spray area which means less force, but more coverage in one pass. Use it for vehicles, , windows and to clean large areas quickly.

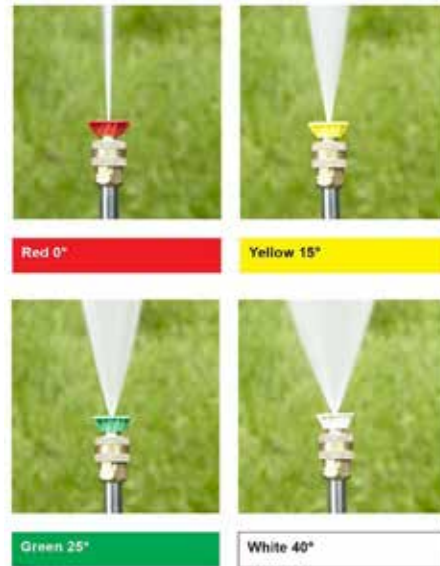

PRESSURE WASHER NOZZLES

IBS No.	Description	Qty
130560	Pressure Washer Nozzle 0 DGR RED	1
130561	Pressure Washer Nozzle 15 DGR YELLOW	1
130562	Pressure Washer Nozzle 25 DGR GREEN	1
130563	Pressure Washer Nozzle 40 DGR WHITE	1

AIR LINE FITTINGS



IBS, INCORPORATED













Assortments Z02

Pressure Washer Couplers, Plugs & Nozzles

IBS No. 831R • 12 Items • 32 Pcs

Packaged in a locking steel drawer for easy storage and organization

AIR LINE FITTINGS

 IBS, Inc. <small>SPECIALTY PRODUCTS FOR MAINTENANCE & REPAIR INDUSTRIALBOLT.COM • 800-678-1906</small>		Pressure Washer Couplers, Plugs and Nozzles Assortment No. 831R
CST3B 1/4 MPT STRAIGHT THRU COUPLER BRASS FOR PRESSURE WASHER 	CST5B 3/8 MPT STRAIGHT THRU COUPLER BRASS FOR PRESSURE WASHER 	130560 PRESSURE WASHER NOZZLE 0 DEGREE RED 
CST4B 1/4 FPT STRAIGHT THRU COUPLER BRASS FOR PRESSURE WASHER 	CST6B 3/8 FPT STRAIGHT THRU COUPLER BRASS FOR PRESSURE WASHER 	130561 PRESSURE WASHER NOZZLE 15 DEGREE YELLOW 
CPST3 1/4 MPT STRAIGHT THRU COUPLER PLUG STEEL FOR PRESSURE WASHER 	CPST5 3/8 MPT STRAIGHT THRU COUPLER PLUG STEEL FOR PRESSURE WASHER 	130562 PRESSURE WASHER NOZZLE 25 DEGREE GREEN 
CPST4 1/4 FPT STRAIGHT THRU COUPLER PLUG STEEL FOR PRESSURE WASHER 	CPST6 3/8 FPT STRAIGHT THRU COUPLER PLUG STEEL FOR PRESSURE WASHER 	130563 PRESSURE WASHER NOZZLE 40 DEGREE WHITE 

Pressure Washer Nozzles 4 Pc Travel Tray

IBS No. 830R • 4 Items • 4 Pcs

Packaged in a locking steel drawer for easy storage and organization

 IBS, Inc. <small>SPECIALTY PRODUCTS FOR MAINTENANCE & REPAIR INDUSTRIALBOLT.COM • 800-678-1906</small>				Pressure Washer Nozzles 4 Pc Travel Tray Assortment No. 830R	
130560 PRESSURE WASHER NOZZLE 0 DEGREE RED 	130561 PRESSURE WASHER NOZZLE 15 DEGREE YELLOW 	130562 PRESSURE WASHER NOZZLE 25 DEGREE GREEN 	130563 PRESSURE WASHER NOZZLE 40 DEGREE WHITE 		



Grease Fittings

A

Assortments

Grease Fittings

English Standard 124R VG-5

English Standard 225R VG-5

Inch & Metric Grease Fittings

849R VG-7

Metric Grease Fittings 232R VG-7

G

Grease Fittings

1/4"-28 Taper Thread VG-4

1/4" Pipe Thread VG-3, VG-4

1/8" Pipe Thread VG-3

Drive Fittings VG-4

English Standard 225R VG-5

Fitting Measurements VG-2

Gen'l Information VG-2

Drills & Taps Table VG-2

Installation VG-2

Measuring VG-2

Hydraulic Couplers VG-8

Lincoln Grease Ftg Coupler VG-8

Swivel Coupler VG-8

Thread Forming VG-4

Tools

Drive VG-8

Easy-Out VG-8

Grease Guns

Medium Duty VG-9

T

Tools

Easy-Out Fitting Tools VG-8

Hand

LockNLube Coupler VG-9

Hydraulic Fitting Tools VG-8

Z

Zerks. *See Grease Fittings*



IBS, INCORPORATED

Grease Fittings V01

Fitting Measurements

Fittings listed on these pages are shown approximately actual size with the complete dimensional data as indicated at right.

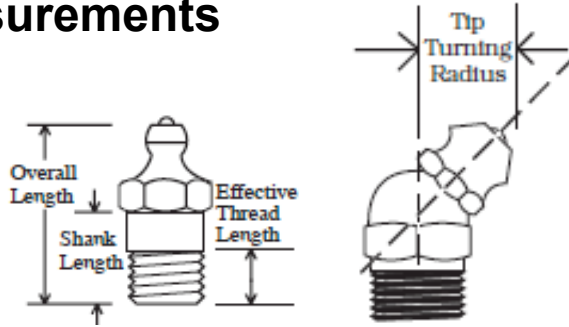

Select Proper Drills & Taps From This Table

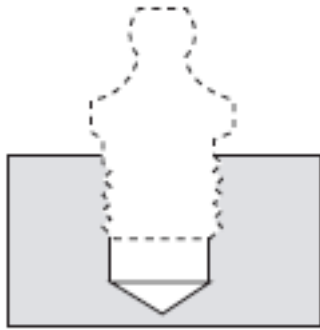

Thread (tap) Size	1/8" Pipe Thread	1/4"-28 Straight or Taper Thread
Drill Size	11/32" (For soft metal use "R" drill)	#3 (For soft metal use #5 drill)

Installation

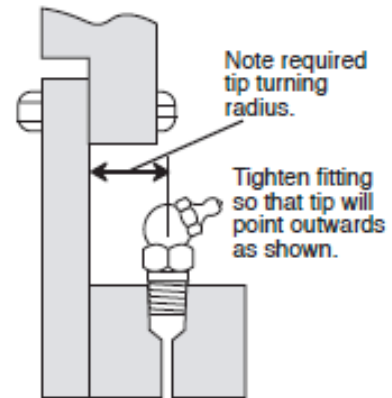
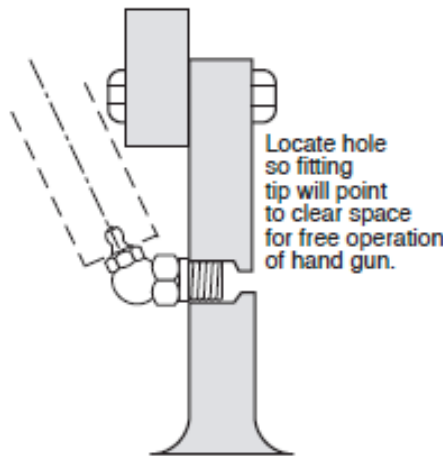
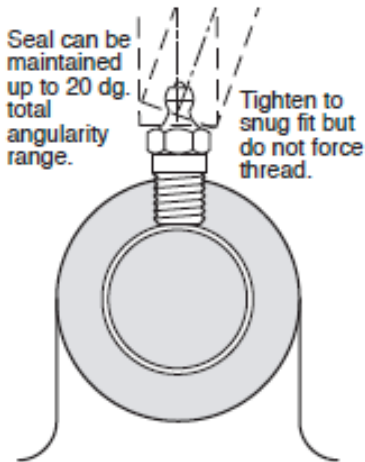

IMPORTANT - The tips of all fittings should be positioned to permit a clear space in a straight line away from fitting for free operation of a hand gun or control valve (seal can be maintained up to 20° total angularity range).

1. Select the proper angle or straight fitting to provide for proper clearance.
2. Be careful in positioning fittings in sub-assemblies to avoid interference from parts of other assemblies.

It is essential that all holes be accurately tapped so that fittings do not have to be screwed in too tight.

1. If original fittings are screwed in too far, the holes will become overly enlarged and service replacements will be difficult.
2. Overtightening, also, can easily strip the threads in soft alloyed metals frequently encountered. Accurate threads and moderate tightening will ensure a leakproof joint.

GREASE FITTINGS



Ball Check Type Grease Fittings

- Ball in tip of fitting keeps out dirt and foreign matter.
- Enlarged inner passaged admits more lubricant, helps cut time on important lubrication jobs.
- Balanced action spring retracts easily to allow maximum lubricant flow under pressure, yet holds ball firmly in sealing position at all other times.
- Better coupler connection — Perfect spherical shape of base allows coupler jaws to form leakproof seal, even at a wide angle.
- Easy installation — All threads accurately machine cut.
- Fitting body made of special hardened steel for long life.
- Accepts all standard makes of hydraulic couplers.
- Universal application — industrial motor equipment.

1/8" Pipe Thread

Fitting Angle	Overall Length (inches)	IBS No.	Qty
Straight, Short	.56	1644-B	25
Straight	.66	1610-B	25
Straight, Long	1.25	1607-B	25
Straight, Long	1.75	1669-B	10
Straight, Long	2.62	1684-B	10
Straight, Female	—	1618-B	25
30°	.90	1611-B	25
30°	2.09	1638-B	10
45°	1.07	1688-B	25
65°	.86	1612-B	25
90°	.84	1613-B	25



1/4" Pipe Thread

Fitting Angle	Overall Length (inches)	IBS No.	Qty
Straight	.88	1627-B	10
67.5°	.97	1629-B	10



- Recommended for heavy lubricants in cold weather.
- Typical application: Large bearings on farm machinery and industrial equipment such as mining equipment and trucks

GREASE FITTINGS



IBS, INCORPORATED

Grease Fittings V01

1/4"-28 Taper Thread

Fitting Angle	Overall Length	IBS No.	Qty
Tapered Thrd, Straight	.54	1641-B	25
Tapered Thrd, Straight	.69	1652-B	25
Tapered Thrd, Straight	.92	1680-B	25
Tapered Thread 45°	.94	1637-B	25
45° Long Shank	.82	1636-B	25
Tapered Thread 90°	.75	1911-B	25



- Conforms to Society of Automotive Engineers (SAE) lubrication thread specification.
- Small thread size make these fittings very popular for most cars and trucks.

Thread Forming

Fitting Angle	Overall Length	Hole Size	IBS No.	Qty
1/8 Strt, Thrd Cutting	.62	.373 - .380	1720-B	25
1/4-28 Strt, Thrd Cutting	.55	.230 - .235	3038-B	25



Fitting Angle	Overall Length	Hole Size	IBS No.	Qty
5/16-24 UNF - 2A		—	1711-B	25

- Special tapered drive threads reshape the material in an untapped hole to provide a leakproof seal.
- Most effectively installed by spinning into an untapped hole but may also be driven straight into an untapped hole.
- May be replaced by any standard threaded fitting.
- Dyed red for identification.

Drive Fittings

Fitting Angle	Overall Length	IBS No.	Qty
1/8 Straight, No Ball Check		3019-NB	25
3/16 Straight Ball Check		1728-B	25
3/16 45° Ball Check		1646-B	25
1/4 Straight Ball Check		1743-B	25
5/16 Straight Ball Check		1608-B	25
3/8 Straight, No Ball Check		1666-NB	25



G
R
E
A
S
E

F
I
T
T
I
N
G
S

IBS, INCORPORATED

Assortments (Z02)

























Grease Fittings Assortment

English Standard

IBS No. 124R 21 Items — 180 Pcs

Packaged in a locking steel drawer for easy storage & organization













				Grease Fittings	
Assortment No. 124R					
1641-B 1/4-28 TAPER TRD STRT ZERK 	1652-B 1/4-28 TAPER TRD 11/16 ZERK 	1680-B 1/4-28 TAPER TRD 31/32 STRT 	1637-B 1/4-28 TAPER TRD 45 DGR ZERK 	1911-B 1/4-28 TAPER TRD. 90 DGR ZERK 	1610-B 1/8 NPT STRT ZERK 
1644-B 1/8 NPT SHORT STRT. ZERK 	1607-B 1/8 NPT 1-1/4L STRT ZERK 	1611-B 1/8 NPT 30DGR STRT ZERK 	1688-B 1/8 NPT 45 DGR ZERK 	1613-B 1/8 NPT 90DGR ZERK 	1629-B 1/4 NPT 67-1/2 DGR ZERK 
1743-B 1/4 DRIVE ZERK BALL CHECK 	1608-B 5/16 DRIVE ZERK BALL CHECK 	1728-B 3/16 DRIVE ZERK BALL CHECK 	1666-NB 3/8 DRIVER ZERK - NO BALL CHECK 	1646-B 3/16 45DGR DRIVE ZERK 	
1711-B 5/16-24 ZERK (LEAF SPRINGS) 	1720-B 1/8 NPT STRT THREAD CUTTING 	3038-B 1/4-28 NPT STRT THREAD CUTTING 	5251 RUBBER ZERK CAP 		

Grease Fittings Assortment

English Standard

IBS No. 225R 12 Items — 178 pcs

Packaged in a locking steel drawer for easy storage & organization

				Grease Fittings	
Assortment No. 225R					
1641-B 1/4-28 TAPER TRD STRT ZERK 	1652-B 1/4-28 TAPER TRD 11/16 ZERK 	1637-B 1/4-28 TAPER TRD 45 DGR ZERK 	1911-B 1/4-28 TAPER TRD. 90 DGR ZERK 	317850-1F 18" LUB. HOSE 	
1610-B 1/8 NPT STRT ZERK 	1688-B 1/8 NPT 45 DGR ZERK 	1613-B 1/8 NPT 90DGR ZERK 			
1608-B 5/16 DRIVE ZERK BALL CHECK 	1728-B 3/16 DRIVE ZERK BALL CHECK 				
5251 RUBBER ZERK CAP 				308730 1/8 NPT GREASE FITTING COUPLER 	

GREASE FITTINGS



IBS, INCORPORATED

Grease Fittings V01

Metric Fittings

6mm x 1mm (pitch)

Fitting Angle	Length (inches)	IBS No.	Qty
Tapered Thrd, Straight	.63	Z-1600	25
Tapered Thrd, 45°	.82	Z-1621	25
Tapered Thrd, 90°	.71	Z-1690	25



Z-1600



Z-1621



Z-1690

8mm x 1mm (pitch)

Fitting Angle	Length (inches)	IBS No.	Qty
Tapered Thrd, Straight	.63	Z-2103	25
Tapered Thrd, 45°	.82	Z-2104	25
Tapered Thrd, 90°	.71	Z-2105	25



Z-2103



Z-2104



Z-2105

10mm x 1mm (pitch)

Fitting Angle	Length (inches)	IBS No.	Qty
Tapered Thrd, Straight	.63	Z-2109	25
Tapered Thrd, 45°	.82	Z-2110	25
Tapered Thrd, 90°	.71	Z-2111	25



Z-2109



Z-2110



Z-2111

Rubber Zerk Cap

- Rubber caps slip easily on and off grease fitting.
- Protects grease fitting against dirt, rocks, chemicals and impact from other sources.
- Reusable.



IBS No.	Description	Qty
5251	Rubber Zerk Cap	25

GREASE FITTINGS

IBS, INCORPORATED

Assortments (Z02)



Metric Grease Fittings Assortment











IBS No. 232R • 10 Items - 175 pcs

Packaged in a locking steel drawer for easy storage & organization



Metric Grease Fittings

Assortment No. 232R

<p>Z-1600 6MM X 1.0 STRT METRIC ZERK</p> 	<p>Z-1621 6MM X 1.0 45DGR METRIC ZERK</p> 	<p>Z-1690 6MM X 1.0 90DGR METRIC ZERK</p> 
<p>Z-2103 8MM X 1.0 STRT METRIC ZERK</p> 	<p>Z-2104 8MM X 1.0 45DGR METRIC ZERK</p> 	<p>Z-2105 8MM X 1.0 90DGR METRIC ZERK</p> 
<p>Z-2109 10MM X 1.0 STRT. METRIC ZERK</p> 	<p>Z-2110 10MM X 1.0 45DGR METRIC ZERK</p> 	<p>Z-2111 10MM X 1.0 90DGR METRIC ZERK</p> 
<p>5251 RUBBER ZERK CAP</p> 		



GREASE FITTINGS

Inch and Metric Grease Fittings Assortment























IBS No. 849R • 22 Items - 166 pcs

Packaged in a locking steel drawer for easy storage & organization



Grease Fittings Inch & Metric

Assortment No. 849R

<p>1911-B 1/4-28 TAPER TRD 90 DGR ZERK</p> 	<p>1613-B 1/8 NPT 90 DGR ZERK</p> 	<p>1608-B 5/16 DRIVE ZERK BALL CHECK</p> 	<p>Z-1690 M6 X 1.0 90DGR METRIC ZERK</p> 	<p>Z-2105 8MM X 1.0 90DGR METRIC ZERK</p> 	<p>Z-2111 10MM X 1.0 90DGR METRIC ZERK</p> 
<p>1637-B 1/4-28 TAPER TRD 45 DGR ZERK</p> 	<p>1688-B 1/8 NPT 45 DGR ZERK</p> 	<p>1743-B 1/4 DRIVE ZERK BALL CHECK</p> 	<p>Z-1621 M6 X 1.0 45DGR METRIC ZERK</p> 	<p>Z-2104 M8 X 1.0 45DGR METRIC ZERK</p> 	<p>Z-2110 10MM X 1.0 45DGR METRIC ZERK</p> 
<p>1652-B 1/4-28 TAPER TRD 11/16 ZERK</p> 	<p>1607-B 1/8 NPT 1-1/4L STRT ZERK</p> 	<p>1728-B 3/16 DRIVE ZERK BALL CHECK</p> 	<p>Z-1600 M6 X 1.0 STRT METRIC ZERK</p> 	<p>Z-2103 M8 X 1.0 STRT METRIC ZERK</p> 	<p>Z-2109 10MM X 1.0 STRT. METRIC ZERK</p> 
<p>1641-B 1/4-28 TAPER TRD STRT ZERK</p> 	<p>1610-B 1/8 NPT STRT ZERK</p> 			<p>5852 LINCOLN GREASE COUPLER</p> 	<p>5251 RUBBER ZERK CAP</p> 





IBS, INCORPORATED

Grease Fittings V01

GREASE FITTINGS

Hydraulic Couplers

- Provides quick, positive leak-proof connection with hydraulic fittings.
- Grease pressure forces 4 hardened steel jaws against the fitting.



IBS No.	Description	Thread	Qty
308730	Straight Coupler	1/8 NPTF	5

Swivel Coupler

- Coupler swivels a full 360°.
- Locks in any of eight positions.
- Ideal for engaging out-of-the-way fittings.
- Use 1/8" NPTF pipe extension to connect coupler to gun outlet.
- Narrow diameter coupler.
- Rubber seal.



IBS No.	Description	Thread	Qty
6509-E	Swivel Coupler	1/8" NPTF	1

Lincoln Grease Ftg Coupler

- 6,000 psi maximum operating pressure
- For all hydraulic grease fittings
- Small outside diameter permits easy contact with recessed fittings
- Replaceable hardened steel jaws
- Built-in ball check prevents leak and lubricant back up.



IBS No.	Description	Thread	Qty
5852	Lincoln Coupler	1/8" NPTF	1

Hydraulic Fitting Tools

Tools For Straight and Angle-type Drive Fittings



5253

IBS No.	For Drive Fittings	Qty
5253	1666-NB, 1743B, 3019NB	1
5253-1	1608-B, 1743B	1

Easy-Out Fitting Tools

Extract broken fittings, rethread holes and install fittings with one tool.



B315790

B315791

IBS No.	For Fittings with Thread	Qty
B315790	14-28" Taper Thread	1
B315791	18" NPT	1

Flex Lubricator Extension Hose

For Lever & Screw-Type Hand Guns

- End connections are 1/8" NPTF (m).
- Maximum working pressure: 4800 psi.
- Minimum burst pressure: 12,000 psi.



317850-1 317850-1F

IBS No.	Description	Qty
317850-1	12" Length	1
317850-1F	18" Length	1



Medium Duty Grease Guns

- Develops pressure up to 10,000 psi.
- Automatic variable pressure.
- Deliver: 1 ounce per 21 strokes
- Air vent fitting.
- Vinyl grip.
- Deluxe pull handle with heavy duty rivets and positive stop.
- Heavy-duty one-piece head.
- Three-way loader -fitting included.



500HD

IBS No.	Description	Qty
500HD	Grease Gun	1

- Three-way loading - Loader fitting included.
- 4500/3000 psi.
- Automatic variable pressure.
- Delivery — 1 Oz. per 33, 16 strokes.
- Air vent fitting.
- Vinyl grip.
- Deluxe pull handle with heavy duty rivets.
- Heavy duty one-piece head.



525HD

IBS No.	Description	Qty
525HD	Grease Gun	1

LockNLube Coupler

The LockNLube Coupler has a unique sliding sleeve, activated by thumb lever. The sleeve either locks the four spring-steel jaws onto the zerk fitting or releases the jaws from the zerk. No hands are needed to align or hold the coupler in place while greasing. The locked connection is positive and rigid, preventing the coupler from coming loose and breaking the leakproof seal. If a fitting becomes pressurized, especially a recessed one, just depress the thumb lever and release the coupler. Because it does not leak, the grease goes in, not on the machine, and the bearings get the grease they so desperately need.



- Works with all grease gun types: pneumatic, manual and electric.
- Works on all DIN and SAE specification zerks.
- Fits 1/8" pipe thread.
- Works with all grease gun manufacturers.
- No need to hold while greasing. Lock-on and free up both hands to operate the grease gun. — simply depress the trigger to release, even under pressure.
- Durable nitrile rubber seal for longevity under high pressure.
- Four hardened spring steel jaws are resilient under high pressure.
- Check valve to reduce leakage.
- LOCKNLUBE XL with a longer barrel has a 3.6" effective reach.

IBS No.	Description	Qty
5855	LockNLube Locking Grease Coupler	1
5856	LockNLube XL Locking Grease Coupler	1
5860	LockNLube Repair Kit	1

GREASE FITTINGS



IBS, INCORPORATED

Grease Fittings V01

**G
R
E
A
S
E

F
I
T
T
I
N
G
S**



Rivets & Inserts

A

Accessories

- Heavy Duty Nutsert Tool
Mandrels & Nosepieces W-16
- Rivet Nut Gun
Mandrels & Nosepieces W-19

Assortments

- Nutserts
 - Aluminum Nutserts W-18
 - Knurled Nutserts W-18
- Rivets, Pop
 - Aluminum W-6
 - Aluminum / Steel W-6
 - Multi-Grip Rivets W-12
 - Multi-Grip & Tri-Fold Rivets W-12
 - Steel W-8
- Thread Inserts
 - Thread Repair
 - Fill-In Segments W-25
 - Self-Tapping Threaded Inserts with Cabinets W-20
 - W-25

B

Back-Up Washers

- Aluminum Round W-9

I

Information

- Helical Thread Inserts W-21
- Helical Thread Installation W-21
- Low Profile Blind Rivets W-2
- Rivet Code Explanation W-2
- Rivet Nut Systems & Installation W-13
- Rivets W-3
- Thread Repair Inserts; Installation & Removal W-23

N

Nutsert Tool

- Heavy Duty W-16

R

Riveters

- Big Daddy Manual Rivet Tool W-10
- Heavy Duty Rivet Tool W-10
- Rivet Nut Gun W-19
- Swivel Head Professional Rivet Tool W-9

Rivet Nuts

- Flanged W-14
- “Nutsert” W-16
- Systems & Installation W-13

“Thin Skin” W-15

Rivets, Buttonhead W-4

- Alum. Rivet & Mandrel W-4
- Alum. Rivet & Stl Mandrel W-5
- Multi-Grip W-11
- S.S. Rivet & Stl Mandrel W-9
- Steel Rivet & Mandrel W-7
- Tri-Fold Rivets W-12

T

Thread Inserts

- Helical
 - Coarse W-22
 - Fine W-22
 - General Information W-21
 - Installation W-21
 - Kits, Coarse W-22
 - Kits, Fine W-22
 - Kits, Metric W-22
 - Metric W-22
- Nutserts
 - Knurled W-17
 - Steel & Aluminum W-16
- Thread Repair
 - Heavy Wall W-24
 - Installation & Removal W-23
 - Self-Tapping Threaded Inserts W-20
 - Thin Wall W-25

Tools

- Hand
 - Big Daddy Manual Rivet Tool W-10
 - Heavy Duty Rivet Tool W-10
 - Rivet Nut Gun Mandrels & Nosepieces W-19
- Heavy Duty Nutsert Tool W-16
 - Mandrels & Nosepieces W-16
- Rivet Nut Gun W-19
 - Mandrels & Nosepieces W-19
- Swivel Head Professional Rivet Tool W-9



IBS, INCORPORATED

Rivets W01

R
I
V
E
T
S
&
I
N
S
E
R
T
S

Low Profile Blind Rivets

- **Strong, positive assembly, neat appearance.**
- **Quick and easy installation for low in-place cost.**
- **Vibration and tamper resistant.**
- **Will not mar painted work surface.**
- **Eliminates thread strip out.**
- **Quickly set by one person from one side of the assembly.**
- **Fasten metal to metal, wood and plastics to metal, all materials to fiberglass, and most other materials.**
- **Available in steel, stainless steel, and aluminum.**
- **Available in buttonhead and large flange designs.**
- **Large flange rivets are especially useful when fastening soft or brittle top panels where greater load bearing surface is needed.**

Rivet Installation

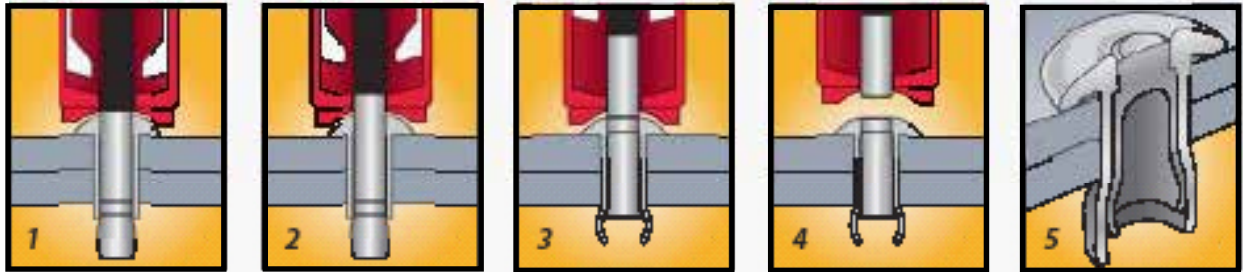

1 After drilling hole to proper diameter, rivet is placed into hole and rivet setting tool is placed over mandrel.

2 Actuating tool starts mandrel into rivet body, pulling work material together and expanding body on the blind side.

3 A solid circle lock is created between the body and mandrel creating a weather resistant assembly that virtually eliminates pin push out

4 After the mandrel is broken, the mandrel is flush with the rivet body removing the need for grinding.

5 The expansion of the body tightly fills the hole creating a weather resistant joint, and the flush break eliminates the need for grinding.

Rivet Code Explanation

Example: ABL6-6A

A—First Letter Rivet Material (A-Aluminum, S-Steel, SS-Stainless Steel)

B—Second Letter Style of Head (B-Buttonhead)

L—Third Letter (if any) Large Flange Head

6—First Number Diameter in 32nd's

6—Second Number Maximum Grip Length in 16th's

A—Final Letter..... Mandrel Material (A-Aluminum, S-Stainless Steel). No letter indicates steel.

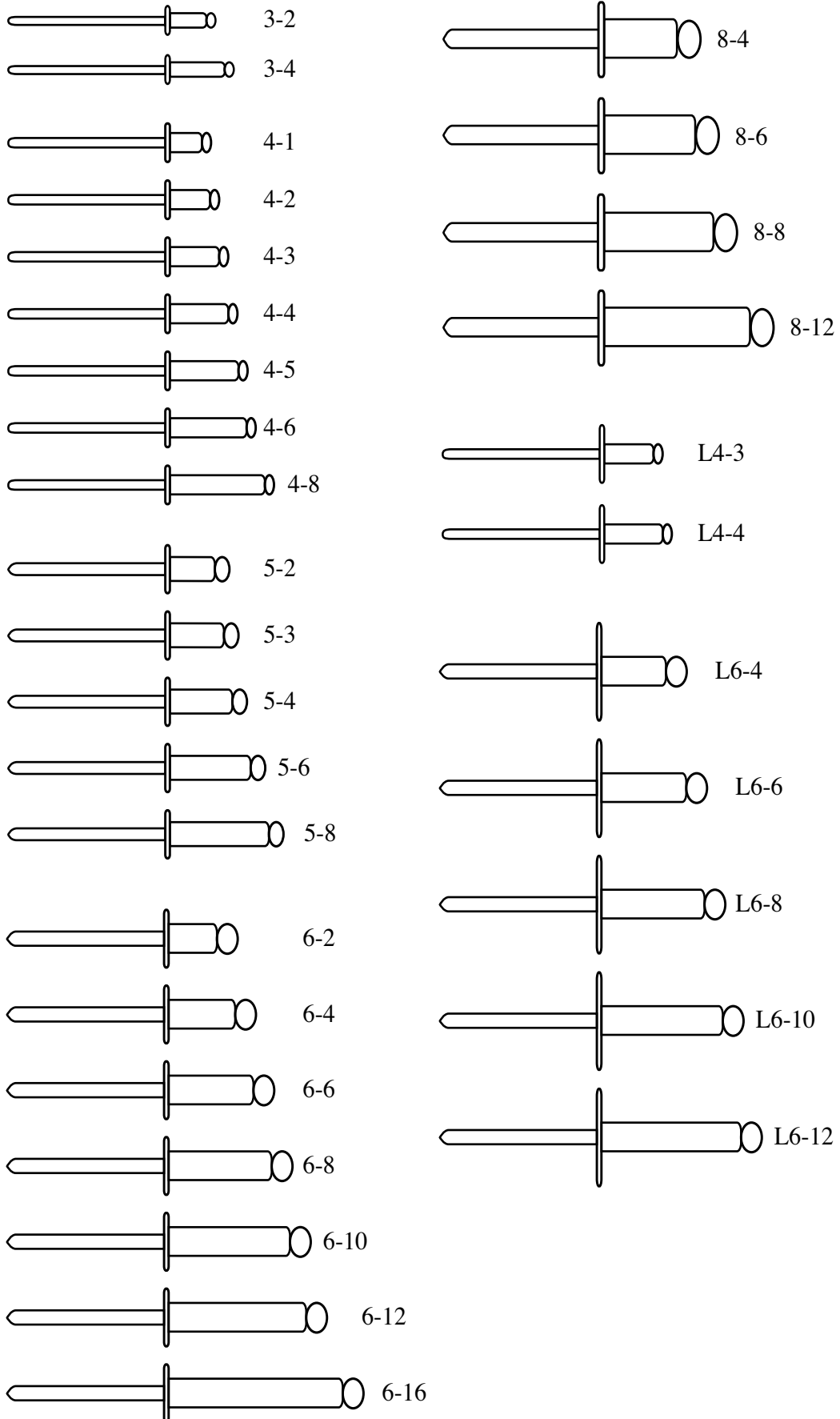

R
I
V
E
T
S
&
I
N
S
E
R
T
S



IBS, INCORPORATED

Rivets W01

Buttonhead Rivets Aluminum Rivet & Mandrel



RIVETS & INSERTS

IBS No.	Rivet	Drill No.	Head Dia. Inch (mm)	Head Height Inch (mm)	Rivet Length		Grip Range		Ultimate Strength lbs.		Pkg Qty
					inch	mm	inch	mm	Shear	Tens	
AB3-2A	3/32" (2.4)	#41	.188 (4.78)	.032 (.81)	.250	6.4	.032 - .125	0.8 - 3.2	70 (310)	80 (360)	100
AB3-4A					.375	9.5	.126 - .250	3.3 - 6.4			100
AB4-1A	1/8" (4.0)	#30	.250 (6.35)	.040 (1.02)	.212	5.4	.032 - .062	0.8 - 1.6	120 (530)	150 (670)	100
AB4-2A					.275	7.0	.063 - .125	1.7 - 3.2			100
AB4-3A					.337	8.6	.126 - .187	3.3 - 4.8			100
AB4-4A					.400	10.2	.188 - .250	4.9 - 6.4			100
AB4-5A					.462	11.7	.251 - .312	6.5 - 7.9			100
AB4-6A					.525	13.4	.313 - .375	8.0 - 9.5			100
AB4-8A					.650	16.5	.376 - .500	9.6 - 12.7			100
AB5-2A					5/32" (4.0)	#20	.312 (9.53)	.055 (1.40)			.300
AB5-3A	.362	9.2	.126 - .187	3.3 - 4.8					100		
AB5-4A	.425	10.8	.188 - .250	4.9 - 6.4					100		
AB5-6A	.550	14.0	.251 - .375	6.5 - 9.5					100		
AB5-8A	.675	17.2	.376 - .500	9.6 - 12.7					100		
AB6-2A	3/16" (4.8)	#11	.375 (9.53)	.055 (1.40)	.325	8.3	.062 - .125	1.6 - 3.2	260 (1160)	320 (1420)	100
AB6-4A					.450	11.5	.126 - .187	3.3 - 6.4			100
AB6-6A					.575	14.6	.251 - .375	6.5 - 9.5			100
AB6-8A					.700	17.8	.376 - .500	9.6 - 12.7			100
AB6-10A					.825	21.0	.501 - .625	12.8 - 15.9			100
AB6-12A					.950	24.2	.626 - .750	16.0 - 19.1			100
AB6-16A					1.20	30.5	.876 - 1.00	19.2 - 25.4			100
AB8-4A	1/4" (6.4)	"F"	.500 (12.7)	.074 (1.88)	.500	12.7	.126 - .250	1.6 - 6.4	580 (2580)	880 (3910)	100
AB8-6A					.625	15.9	.251 - .375	6.5 - 9.5			100
AB8-8A					.750	19.1	.376 - .500	9.6 - 12.7			100
AB8-12A					1.00	25.4	.501 - .750	12.8 - 19.1			100
Large Flange											
ABL4-3A	1/8" (3.2)	#30	.375 (9.53)	.045 (2.08)	.337	8.6	.126 - .187	3.3 - 4.8	120 (530)	150 (670)	100
ABL4-4A					.400	10.2	.188 - .250	4.9 - 6.4			100
ABL6-4A	3/16" (4.8)	#11	.625 (15.9)	.082 (2.08)	.450	11.5	.126 - .250	1.6 - 6.4	260 (1160)	320 (1420)	100
ABL6-6A					.575	14.6	.251 - .375	6.5 - 9.5			100
ABL6-8A					.700	17.8	.376 - .500	9.6 - 12.7			100
ABL6-10A					.825	21.0	.501 - .625	12.8 - 15.9			100
ABL6-12A					.950	24.2	.626 - .750	16.0 - 19.1			100

IBS, INCORPORATED

Rivets W01



Buttonhead Rivets

Aluminum Rivet & Steel Mandrel



IBS No.	Rivet	Drill No.	Head Dia. Inch (mm)	Head Height Inch (mm)	Rivet Length		Grip Range		Ultimate Strength lbs.		Pkg Qty
					inch	mm	inch	mm	Shear	Tens	
AB3-2	3/32"	#41	.188 (4.78)	.032 (.81)	.250	6.4	.032 - .125	0.8 - 3.2	70 (310)	80 (360)	100
AB3-4	(2.4)				.375	9.5	.126 - .250	3.3 - 6.4			100
AB4-2	1/8" (3.2)	#30	.250 (6.35)	1.02	.275	7.0	.063 - .125	1.7 - 3.2	120 (530)	150 (670)	100
AB4-3					.337	8.6	.126 - .187	3.3 - 4.8			100
AB4-4					.400	10.2	.188 - .250	4.9 - 6.4			100
AB4-5					.462	11.7	.251 - .312	6.5 - 7.9			100
AB4-6					.525	13.4	.313 - .375	8.0 - 9.5			100
AB4-8					.650	16.5	.376 - .500	9.6 - 12.7			100
AB5-2	5/32" (4.0)	#20	.312 (9.53)	.055 (1.40)	.300	7.6	.062 - 1.25	1.6 - 3.2	190 (850)	230 (1020)	100
AB5-3					.362	9.2	.126 - .187	3.3 - 4.8			100
AB5-4					.425	10.8	.188 - .250	4.9 - 6.4			100
AB5-6					.550	14.0	.251 - .375	6.5 - 9.5			100
AB5-8					.675	17.2	.376 - .500	9.6 - 12.7			100
AB6-2	3/16" (4.8)	#11	.375 (9.53)	.055 (1.40)	.325	8.3	.020 - .125	1.6 - 3.2	260 (1160)	320 (1420)	100
AB6-4					.450	11.5	.126 - .187	3.3 - 6.4			100
AB6-6					.575	14.6	.251 - .375	6.5 - 9.5			100
AB6-8					.700	17.8	.376 - .500	9.6 - 12.7			100
AB6-10					.825	21.0	.501 - .625	12.8 - 15.9			100
AB6-12					.950	24.2	.626 - .750	16.0 - 19.1			100
AB8-4	1/4" (6.4)	"F"	.500 (12.7)	.074 (1.88)	.500	12.7	.062 - .250	1.6 - 6.4	580 (2580)	880 (3910)	100
AB8-6					.625	15.9	.251 - .375	6.5 - 9.5			100
AB8-8					.750	19.1	.376 - .500	9.6 - 12.7			100
AB8-12					1.00	25.4	.501 - .750	12.8 - 19.1			100
Large Flange											
ABL4-3	1/8" (3.2)	#30	.375 (9.53)	.045 (2.08)	.337	8.6	.126 - .187	3.3 - 4.8	120 (530)	150 (670)	100
ABL4-4	(3.2)				.400	10.2	.188 - .250	4.9 - 6.4			100
ABL6-4	3/16" (4.8)	#11	.625 (15.9)	.082 (2.08)	.450	11.5	.062 - .250	1.6 - 6.4	260 (1160)	320 (1420)	100
ABL6-6					.575	14.6	.251 - .375	6.5 - 9.5			100
ABL6-8					.700	17.8	.376 - .500	9.6 - 12.7			100
ABL6-10					.825	21.0	.501 - .625	12.8 - 15.9			100
ABL6-12					.950	24.2	.626 - .750	16.0 - 19.1			100

RIVETS & INSERTS



















IBS, INCORPORATED

Assortments Z02

















Aluminum Rivet Assortment

IBS No. 156R • 16 Items • 1050 Pieces

IBS, Inc. SPECIALTY PRODUCTS FOR MAINTENANCE & REPAIR INDUSTRIALBOLT.COM • 800-678-1906		Rivet Code Explanation			Aluminum Blind Rivets				
<small> Example: ABL6-6A A - First Letter Rivet Material (A-Aluminum, S-Steel, SS- Stainless Steel) B - Second Letter Style of Head (B-Standard) L - Third Letter (if any) Large Flange Head H - First Number Diameter in Sixteenths B - Second Number Maximum Grip Length in 1/16's A - Final Letter Material Material (A-Aluminum, S- Stainless Steel, SS- Steel indicates steel) </small>					Assortment No. 156R				
AB3-2A 3/32 .032-.125 ALUM/ALUM RIVET 	AB3-4A 3/32 .126-.250 ALUM/ALUM RIVET 	AB4-2A 1/8 .063-.125 ALUM/ALUM RIVET 	AB4-3A 1/8 .126-.187 ALUM/ALUM RIVET 	AB4-4A 1/8 .188-.250 ALUM/ALUM RIVET 					
			AB5-3A 5/32 .126-.187 ALUM/ALUM RIVET 	AB5-4A 5/32 .188-.250 ALUM/ALUM RIVET 					
AB5-6A 5/32 .251-.375 ALUM/ALUM RIVET 	AB5-8A 5/32 .376-.500 ALUM/ALUM RIVET 	AB6-4A 3/16 .126-.250 ALUM/ALUM RIVET 	AB6-6A 3/16 .251-.375 ALUM/ALUM RIVET 	AB6-8A 3/16 .376-.500 ALUM/ALUM RIVET 					
AB6-10A 3/16 .501-.625 ALUM/ALUM RIVET 		ABL6-6A 3/16 .251-.375 LRG FLGE 	ABL6-8A 3/16 .376-.500 LRG FLGE 	ABL6-10A 3/16 .501-.625 LRG FLNGE 					

Aluminum / Steel Rivet Assortment

IBS No. 157R • 16 Items • 1050 Pieces

IBS, Inc. SPECIALTY PRODUCTS FOR MAINTENANCE & REPAIR INDUSTRIALBOLT.COM • 800-678-1906		Rivet Code Explanation			Aluminum / Steel Blind Rivets				
<small> Example: ABL6-6A A - First Letter Rivet Material (A-Aluminum, S-Steel, SS- Stainless Steel) B - Second Letter Style of Head (B-Standard) L - Third Letter (if any) Large Flange Head H - First Number Diameter in Sixteenths B - Second Number Maximum Grip Length in 1/16's A - Final Letter Material Material (A-Aluminum, S- Stainless Steel, SS- Steel indicates steel) </small>					Assortment No. 157R				
AB3-2 3/32 .032-.125 ALUM/STEEL 	AB3-4 3/32 .126-.250 ALUM/STEEL 	AB4-2 1/8 .063-.125 ALUM/STEEL RIVET 	AB4-3 1/8 .126-.187 ALUM/STEEL RIVET 	AB4-4 1/8 .188-.250 ALUM/STEEL RIVET 					
			AB5-3 5/32 .126-.187 ALUM/STEEL 	AB5-4 5/32 .188-.250 ALUM/STEEL 					
AB5-6 5/32 .251-.375 ALUM/STEEL 	AB5-8 5/32 .376-.500 ALUM/STEEL 	AB6-4 3/16 .126-.250 ALUM/STEEL 	AB6-6 3/16 .251-.375 ALUM/STEEL 	AB6-8 3/16 .376-.500 ALUM/STEEL 					
AB6-10 3/16 .501-.625 AI 		ABL6-6 3/16 .251-.375 LRG FLGE 	ABL6-8 3/16 .376-.500 LRG FLGE 	ABL6-10 3/16 .501-.625 LRG FLGE 					

R
I
V
E
T
S
&
I
N
S
E
R
T
S

IBS, INCORPORATED

Rivets W01



Buttonhead Rivets Steel Rivet & Mandrel



IBS No.	Rivet Diam. Inch (mm)	Drill No.	Head Diam. Inch (mm)	Head Height Inch (mm)	Rivet Length		Grip Range		Ultimate Strength lbs.		Pkg Qty
					inch	mm	inch	mm	Shear	Tens	
SB3-4	3/32" (2.4)	#41	.188 (4.78)	.032 (.81)	.375	9.5	.126 - .250	3.3 - 6.4	130 (580)	170 (760)	100
SB4-2	1/8" (3.2)	#30	.250 (6.35)	1.02	.275	7.0	.063 - .125	1.7 - 3.2	260 (1160)	310 (1380)	100
SB4-3					.337	8.6	.126 - .187	3.3 - 4.8			100
SB4-4					.400	10.2	.188 - .250	4.9 - 6.4			100
SB4-5					.462	11.7	.251 - .312	6.5 - 7.9			100
SB4-6					.525	13.4	.313 - .375	8.0 - 9.5			100
SB4-8					.650	16.5	.376 - .500	9.6 - 12.7			100
SB5-2	5/32" (4.0)	#20	.312 (7.92)	.055 (1.40)	.300	7.6	.020 - 1.25	1.6 - 3.2	370 (1650)	470 (2090)	100
SB5-4					.425	10.8	.188 - .250	4.9 - 6.4			100
SB5-6					.550	14.0	.251 - .375	6.5 - 9.5			100
SB5-8					.675	17.2	.376 - .500	9.6 - 12.7			100
SB6-2	3/16" (4.8)	#11	.375 (9.53)	.055 (1.40)	.325	8.3	.020 - .125	1.6 - 3.2	540 (2400)	680 (3020)	100
SB6-4					.450	11.5	.126 - .187	3.3 - 6.4			100
SB6-6					.575	14.6	.251 - .375	6.5 - 9.5			100
SB6-8					.700	17.8	.376 - .500	9.6 - 12.7			100
SB6-10					.825	21.0	.501 - .625	12.8 - 15.9			100
SB6-12					.950	24.2	.626 - .750	16.0 - 19.1			100
SB8-4	1/4" (6.4)	"F"	.500 (12.7)	.074 (1.88)	.500	12.7	.062 - .250	1.6 - 6.4	1150 (2580)	1500 (6670)	100
SB8-6					.625	15.9	.251 - .375	6.5 - 9.5			100
SB8-8					.750	19.1	.376 - .500	9.6 - 12.7			100
SB8-12					1.00	25.4	.501 - .750	12.8 - 19.1			100
Large Flange											
SBL4-4	1/8 (3.2)	#30	.375 (9.53)	.045 (1.14)	.400	10.2	.188 - .250	4.9 - 6.4	260 (1160)	310 (1380)	100
SBL6-4	3/16 (4.8)	#11	.625 (15.9)	.082 (2.08)	.450	11.5	.062 - .250	1.6 - 6.4	540 (2400)	680 (1380)	100
SBL6-6					.575	14.6	.251 - .375	6.5 - 9.5			100
SBL6-8					.700	17.8	.376 - .500	9.6 - 12.7			100
SBL6-10					.825	21.0	.501 - .625	12.8 - 15.9			100
SBL6-12					.950	24.2	.626 - .750	16.0 - 19.1			100

RIVETS & INSERTS

Rivet Code Explanation

Example: ABL6-6A

- A**—First LetterRivet Material (A-Aluminum, S-Steel, SS-Stainless Steel)
- B**—Second LetterStyle of Head (B-Buttonhead)
- L**—Third Letter (if any)Large Flange Head
- 6**—First NumberDiameter in 32nd's
- 6**—Second NumberMaximum Grip Length in 16th's
- A**—Final Letter.....Mandrel Material (A-Aluminum, S-Stainless Steel). No letter = steel.



IBS, INCORPORATED

Assortments Z02

Steel Rivet Assortment

IBS No. 174R • 15 Items • 975 Pieces

































IBS, Inc.
SPECIALTY PRODUCTS FOR MAINTENANCE & REPAIR
INDUSTRIALBOLT.COM © 2013 800-678-1906

Rivet Code Explanation
Example: ABL6-0A
A—First Letter Rivet Material (A-Aluminum, S-Steel, SS-Stainless Steel)
B—Second Letter Size of Head (B-Standard)
L—Third Letter (if any) Large Flange Head
Head First Number Diameter in 32nds
Head Second Number Maximum Grip Length in 32nds
A—Final Letter Material Material (A-Aluminum, S-Stainless Steel, No letter indicates steel)

Steel Blind Rivets

Assortment No. 174R

SB3-4 3/32 .126-.250 STEEL RIVET  		SB4-2 1/8 .063-.125 STEEL RIVET  	SB4-3 1/8 .126-.187 STEEL RIVET  	SB4-4 1/8 .188-.250 STEEL RIVET  
			SB5-2 5/32 .062-.125 STEEL RIVET  	SB5-4 5/32 .188-.250 STEEL RIVET  
SB5-6 5/32 .251-.375 STEEL RIVET  	SB5-8 5/32 .376-.500 STEEL RIVET  	SB6-4 3/16 .126-.250 STEEL RIVET  	SB6-6 3/16 .251-.375 STEEL RIVET  	SB6-8 3/16 .376-.500 STEEL RIVET  
SB6-10 3/16 .501-.625 STEEL RIVET  		SBL6-6 3/16 .251-.375 LRG FLGE STEEL  	SBL6-8 3/16 .376-.500 LRG FLGE STEEL  	SBL6-10 3/16 .501-.625 LRG FLGE STEEL  

R
I
V
E
T
S
&
I
N
S
E
R
T
S



Buttonhead Rivets

STAINLESS STEEL RIVET & STAINLESS MANDREL



IBS No.	Rivet Dia. Inch (mm)	Drill No.	Head Dia. Inch (mm)	Head Height Inch (mm)	Rivet Length		Grip Range		Ultimate Strength Lbs (N)		Pkg Qty		
					Inch	MM	Inch	MM	Shear	Tens			
SSB4-4S	1/8"	#30	.250	.040	.400	10.2	.188-.250	4.9 -6.4	420	530	100		
SSB4-6S	(3.2)		(63.5)	1.02	.525	13.4	.313-.375	8.0 - 9.5	(1870)	(2360)	100		
SSB5-4S	5/32"	#20	.312	.045	.425	10.8	.188-.250	4.9 - 6.4	650	820	100		
SSB5-6S	(4.0)		(7.92)	(1.14)	.550	14.0	.251-.375	6.5 - 9.5	(2890)	(3650)	100		
SSB6-2S	3/16"	#11	.375	.055	.325	8.3	.062-.125	1.6 - 3.2	950	1200	100		
SSB6-4S					.450	11.5	.125-.250	3.3 - 6.4			(4230)	(5340)	100
SSB6-6S					.575	14.6	.251-.375	6.5 - 9.5			100		
SSB6-8S					.700	17.8	.376-.500	9.6 - 12.7			100		

Back-Up Washers

ALUMINUM ROUND

Back-Up Washers are .056" thick for use when fastening soft materials or to compensate for oversize holes where access to both sides of the work is possible.

IBS No.	Hole Size	Diameter	Pkg Qty
AS-8	1/8"	3/8"	100
AS-9	5/32"	7/16"	100
AS-10	3/16"	1/2"	100



Swivel Head Professional Rivet Tool (T03)

IBS No. HP-5



- Rivet head swivels 360° for riveting at any angle.
- Hardened steel construction
- Extended nosepiece for hard to reach locations.
- Comfortable non-slip handle grips.
- Not recommended for nylon rivets.
- Includes nosepieces: 3/32, 1/8, 5/32 & 3/16.

Rivet Diameter	3/32	1/8	5/32	3/16
Aluminum	YES	YES	YES	YES
Steel	YES	YES	YES	NO
Copper	NO	YES	NO	NO
Stainless Steel	NO	YES	NO	NO



IBS, INCORPORATED

Tools T03

R
I
V
E
T
S
&
I
N
S
E
R
T
S

Heavy Duty Rivet Tool IBS No. HP-2

The HP-2 is the number one selling hand rivet tool in the industry. Known and trusted for durability, quality and performance, the HP-2 is often copied but never duplicated. Its square shoulder fulcrum pin of cold-formed heat-treated steel prevents pin rotation that can elongate the engaging holes and cause premature tool failure in imitation tools. Other quality features include: precision die-cast, high-strength aluminum alloy body; drop-forged carbon steel upper handle; and thick, cushion molded vinyl grips for comfort. The HP-2 sets up to 3/16" steel rivets and comes with four mounted nosepieces (3/32", 1/8", 5/32" and 3/16") and a service wrench.



- Square shoulder fulcrum pin of cold-formed heat-treated steel prevents pin rotation that can elongate the engaging holes, a leading cause of premature tool failure in imitations – fewer failures means less rework time, faster installations – equals time and money savings!
- Precision die-cast, high-strength aluminum alloy body makes this tool super durable while keeping it light-weight – means longer life and comfortable to use.
- Drop-forged steel upper handle gives this tool added strength for extended service life.
- Thick cushion-molded vinyl grips for comfort means better productivity and less likely for fatigue and injury.
- Sets steel and aluminum rivets from 3/32" to 3/16", and stainless steel up to 5/32"

Big Daddy Manual Rivet Tool IBS No. 49520

The Big Daddy is a versatile and powerful hand riveter, taking the hard work out of setting large diameter blind rivets.



- Extra-long handles provide excellent leverage and permit working a foot beyond natural reach.
- Patented bearing design, self-adjusting two-piece jaws and single-unit body construction with a steel insert to provide stronger threads for the nosepieces included.
- Double gear reduction system easily sets from 1/8" to 1/4" diameter rivets in all alloys.
- One piece collet case eliminates the need to adjust the tool when changing rivet diameters.
- 5/32", 3/16" and 1/4" nosepieces, which are stored in the body.
Weighs 3.75 lbs.

IBS, INCORPORATED

Rivets W01



Multi-Grip Blind Rivets

Aluminum Rivet • Steel Zinc Yellow Mandrel

Multi-Grip Rivets provide an effective and economical alternative to other, more costly methods of fastening, because one size handles the grip range capacity of up to 3 standard open end rivets. Multi-Grip rivets can be used in any application requiring open end rivets, while reducing inventory requirements. Use multi-grip rivets as a standard open-end rivet — no special tool is needed.

- Resists pull through on both thin and thick material.
- Greater holding power on areas with high vibration.
- Great for holes that are too large or have become elongated.



Large Flange Dome Head			
IBS No	Dia.	Grip Range	Pkg
170406	1/8	1/32 - 3/16	100
170408	1/8	1/8 - 5/16	100
170508	5/32	3/64 - 1/4	100
170608	3/16	1/4 - 1/2	100
170612	3/16	1/2 - 25/32	100

Regular Dome Head			
IBS No.	Dia.	Grip Range	Pkg
171406	1/8	1/32 - 3/16	100
171408	1/8	1/8 - 5/16	100
171508	5/32	3/64 - 1/4	100
171608	3/16	1/16 - 1/4	100
171612	3/16	3/16 - 7/16	100

Install

Insert rivet mandrel in the rivet setting tool



Using tool as a guide, insert rivet into prepared hole

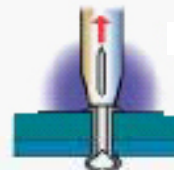

Or insert rivet into prepared hole and then engage the mandrel with rivet setting tool. Squeeze trigger or handles to set rivet. Mandrel ejects after rivet is set.

Features, Benefits & Applications



One length handles both



Hollow extrusions & tubes



High Grip Strength
No Surface Distortion



Hard and Soft Materials



Vibration & Tamper Resistant



High Strength



No Marred Surfaces



Low Profile Heads

R
I
V
E
T
S
&
I
N
S
E
R
T
S



IBS, INCORPORATED

Rivets W01

Tri-Fold Rivets

Aluminum Body/ Aluminum Mandrel

Tri-fold Rivets form three large folded wings which create excellent clamp-up and large blind side bearing surface.



- **Multi-Grip** - Adjusts to wide variation in application thickness.
- **Large Blindside Footprint** - Eliminates need for backup washer.
- **Distributed Clamping** - Helps prevent cracking of brittle materials.
- **Corrosion Resistant** - All aluminum construction.
- **High Pullout Resistance** - When used in thin or ductile materials.
- **Reduced Hole Sensitivity** - Works in oversized, misaligned or irregularly shaped holes.
- **Positive Mandrel Retention** - Rattle free fastener.

D- Body Diameter (Maximum)
 B- Head Height (Nominal)
 A- Head Diameter (Nominal)
 L- Rivet Body Length (Nominal)

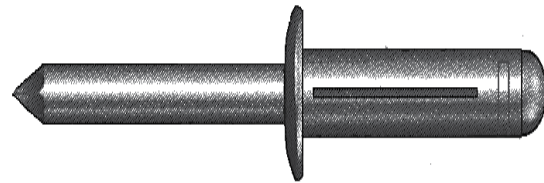

Head Style	Rivet Dia.	IBS No	Grip Range	Hole Size	Drill No.	Dimensions					Typ. Strength LBS	
						D	B*	A	L*	F*	Shear	Tensile
Dome	5/32	17254	.040 - .250	.162 - .167	#20	.161	.055	.312	.770	3880	200	225
		17256	.040 - .375						.832	.942		
	3/16	17264	.062 - .250	.209 - .221	#4	.205	.075	.385	.750	.875	350	450
		17266	.187 - .375						.875	1.0		
		17268	.312 - .500					1.0	1.125			

Package Quantity = 50

Multi-Grip & Tri-Fold Rivets Assortment (Z02)

IBS No. 369R • 12 Items • 800 Pieces

Packaged in a locking steel drawer for storage & organization

Multi-Grip Rivets Assortment (Z02)

IBS No. 368R • 10 Items • 1,000 Pieces

Packaged in a locking steel drawer for storage & organization

IBS, Inc. SPECIALTY PRODUCTS FOR MAINTENANCE & REPAIR INDUSTRIALRIVET.COM I I I © 200-678-1808			Multi-Grip & Tri-Fold Rivets		
Assortment No. 369R					
170406 1/8 LARGE FLG SHORT MULTIGRIP	170408 1/8 LARGE FLG LONG MULTIGRIP	170508 5/32 LARGE FLG MULTIGRIP			
170608 3/16 LARGE FLG SHORT MULTIGRIP	170612 3/16 LARGE FLG LONG MULTIGRIP	171406 1/8 DOME HD SHORT MULTIGRIP			
171408 1/8 DOME HD LONG MULTIGRIP	171608 3/16 DOME HD SHORT MULTIGRIP	171612 3/16 DOME HD LONG MULTIGRIP			
17256 5/32 TRI-FOLD RIVET .040-.375	17264 3/16 TRI-FOLD RIVET .062-.250	17266 3/16 TRI-FOLD RIVET .187-.375			

IBS, Inc. SPECIALTY PRODUCTS FOR MAINTENANCE & REPAIR INDUSTRIALRIVET.COM I I I © 200-678-1808			Multi-Grip Rivets		
Assortment No. 368R					
170406 1/8 LARGE FLG SHORT MULTIGRIP	170408 1/8 LARGE FLG LONG MULTIGRIP	170508 5/32 LARGE FLG MULTIGRIP			
170608 3/16 LARGE FLG SHORT MULTIGRIP	170612 3/16 LARGE FLG LONG MULTIGRIP				
171406 1/8 DOME HD SHORT MULTIGRIP	171408 1/8 DOME HD LONG MULTIGRIP	171908 5/32 DOME HD MULTIGRIP			
171608 3/16 DOME HD SHORT MULTIGRIP	171612 3/16 DOME HD LONG MULTIGRIP				

R
I
V
E
T
S
&
I
N
S
E
R
T
S



Rivet Nut Systems & Installation

Flanged Rivet Nuts and “Thin Skin” Rivet Nuts enjoy a wide range of applications. They are especially useful where threaded holes are needed, but both sides of the material cannot be reached.

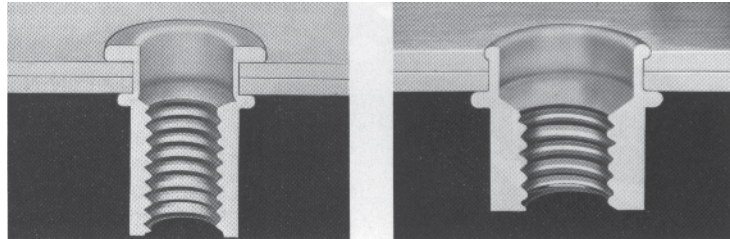

Flanged Rivet Nut

“Thin Skin” Rivet Nut

Flanged rivet nuts and “Thin Skin” rivet nuts can assure captive load bearing in materials too thin to independently provide efficient thread strength. They can easily be installed by one person from one side of the assembly using either air or hand powered tools.

Flanged Rivet Nuts, because of their large diameter head, can be used in soft materials which inherently offer little or no thread strength. “Thin Skin” Rivet Nuts allow for a nearly flush installation along with an excellent fit to mating materials.

Easy Installation

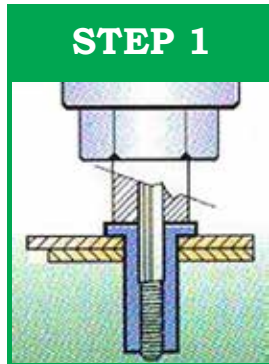

Drill hole to correct diameter; thread fastener onto tool mandrel and insert into hole.

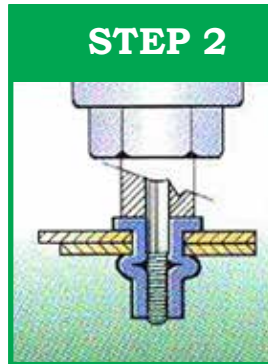

Actuate tool to properly set fastener into material.

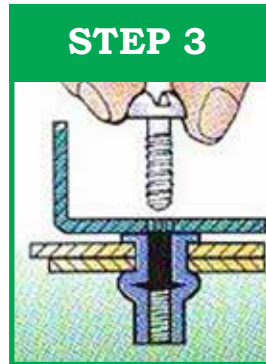

Complete your fastening operation with a bolt or screw with the proper thread.



The positive riveting action of both the Flanged and Thin Skin Rivet Nuts provide consistent firm fastening. Push out and shake loose are virtually eliminated.

Product Strength - Flanged Rivet Nuts

Thread Size	Typical Sheer Strength		Typical Tensile Strength	
	Aluminum	Steel	Aluminum	Steel
6-32	215	365	225	525
8-32	280	525	285	575
10-24	300	650	415	815
10-32	300	650	415	815
1/4-20	525	700	650	1250
5/16-18	640	900	905	1400
3/8-16	1000	1370	1300	1500

R
I
V
E
T
S
&
I
N
S
E
R
T
S



IBS, INCORPORATED

Thread Inserts W02

Flanged Rivet Nuts

ZINC PLATED STEEL OR ALUMINUM CLASS 2B THREADS

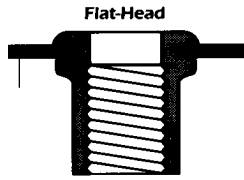
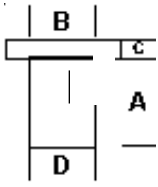

Flanged or Flathead Rivet Nuts can be used in a wide range of applications and are designed to provide a very efficient and cost-effective method of placing permanent threads in thin materials. Installed from one side, these rivet nuts are perfect for use in metal, fiberglass and rigid plastic previously too thin for tapped threads. Rivet nuts provide a neat appearance and once in place, the internal threads are ready for a screw or bolt.

Lightweight tooling assures easy installation and reduces costs compared to other methods. Provides permanent, captive threads that do not allow loosening under vibration and will not rotate when attached.

Rivet Nuts with **large diameter heads** can be used in soft materials which offer little, if any thread strength.

The **flathead design** provides the most bearing surface for higher torque applications. The larger flange extends above the material and provides a built in spacer.

Thread Size	IBS No.		Drill No. Hole Size	B	C	A	Grip Range	Pkg Qty
	Steel	Alum		Head Dia.	Head Height	Body Length		
6-32	49110	49210	#12 .189 / .193	.325	.032	.438	.010 / .075	25
8-32	49120	49220	#2 .2221 / .226	.357	.032	.438	.010 / .075	25
10-24	49130	49230	1/4" .250 / .254	.406	.038	.531	.010 / .080	25
10-32	49140	49240	1/4" .250 / .254	.406	.038	.531	.010 / .080	25
1/4-20	49150	49250	"Q" .332 / .338	.475	.058	.625	.020 / .080	25
		49252				.687	.080 / .140	25
5/16-18	49171	49271	"Z" .413 / .423	.665	.058	.750	.030 / .125	25
	49174					.875		25
3/8-16	49181	49281	1/2" .490 / .500	.781	.088	.844	.030 / .115	25

RIVETS & INSERTS

IBS, INCORPORATED

Thread Inserts W02



“Thin Skin” Rivet Nuts

STEEL ZINC PLATED OR ALUMINUM CLASS 2B THREADS

“Thin Skin” Rivet Nuts feature a small flange which allows for two distinct finishes:

Flushmount - obtained by drilling a standard hole and offers a low profile to the surface of the application;

Countersunk - obtained by drilling a counter sunk hole and allows the rivet nut to be set below the surface. During installation of the “Thin Skin” Rivet Nuts the threaded body draws upward against the blind side of the application material, while the flange clamps onto the surface and lock the fastener into place. They are available in aluminum and low carbon steel in sizes from 6-32 to 3/8-16.

“Thin Skin” rivet nuts can be used in a wide range of applications to place permanent threads in thin materials. They are ideal for use in metal, fiberglass, and rigid plastics. These rivet nuts provide a nearly flush appearance and provide permanent, captive threads that do not allow loosening under vibration and will not rotate when attached to the mating material.

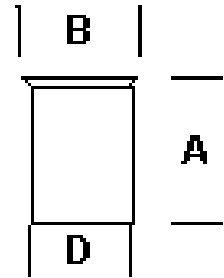
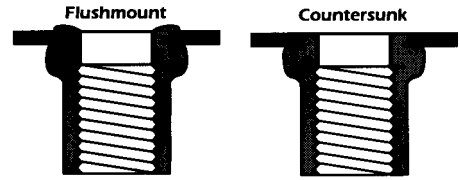

NOTE: HOLE SIZE IS CRITICAL FOR PROPER INSTALLATION.

Thread Size	IBS No.	Material	Drill No. Hole Size	B	C	Grip Range	Pkg Qty
				Head Diam.	Body Length		
6-32	49415	Steel	1/4"	.287	.41	.020 / .080	25
6-32	17500	Aluminum	.250/.254				
8-32	49425	Steel	1/4"	.287	.41	.020 / .080	25
8-32	17501	Aluminum	.250/.254				
10-24	49435	Steel	9/32"	.32	.465	.020 / .130	25
10-24	17502	Aluminum	.281/.285				
10-32	49445	Steel	9/32"	.32	.465	.020 / .130	25
10-32	17503	Aluminum	.281/.285				
1/4-20	49455	Steel	3/8"	.415	.61	.030 / .165	25
1/4-20	17504	Aluminum	.375/.379				
5/16-18	49475	Steel	1/2"	.54	.720	.030 / .165	25
5/16-18	17505	Aluminum	.500/.504				
3/8-16	17506	Aluminum	1/2"	.658	.535	.020 / .125	25

R
I
V
E
T
S
&
I
N
S
E
R
T
S



IBS, INCORPORATED

Thread Inserts W02

R
I
V
E
T
S
&
I
N
S
E
R
T
S

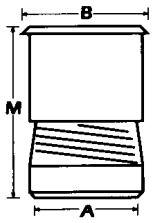

“Nutsert” Type Thread Inserts

“Nutserts” are a versatile threaded fastener that can be used in a variety of applications. Use in any thickness of metal or rigid material of at least 3/32" (.0937). Eliminate the need for tapping, welding, and brazing. "Nutserts" design consists of an upper sleeve and a base which has both internal and external threads.

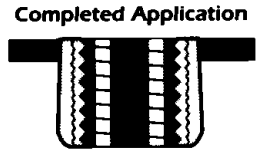

During installation, the base is drawn upwards inside the upper sleeve forcing a 360° contact between the sleeve and application material. No special preparation is needed; a drilled or punched hole is all that is required. Because of its unique setting ability, "nutserts" can be used in almost any thickness of material. Installation is made quite easy with a variety of tools and kits.

Thread Size	IBS No.		Material Thickness .0937 - .1562		Material Thickness .1562 - Infinity		A	B	Pkg Qty
	Steel	Alum	Hole	Drill	Hole	Drill			
1/4-20	17510	17516	.391	25/64	.391	25/64	.510	.408	25
5/16-18	17511	17517	.500	1/2	.516	33/64	.615	.537	25
3/8-16	17512	17518	.562	9/16	.578	37/64	.740	.600	25

Heavy Duty Nutsert Tool IBS No. 49550

Ideal for installing larger size steel inserts. This heavy-duty tool installs 1/4-20 through 3/8-16, and 5mm through 10mm threaded inserts in aluminum or steel. Quick changing mandrels, easily adjustable stroke. 1/4-20 mandrel and nosepiece included.



Heavy Duty Nutsert Tool (49550)
Mandrels & Nosepieces

IBS No.	Description
49551	1/4-20 Mandrel & Nosepiece
49552	5/16-18 Mandrel & Nosepiece
49553	3/8-16 Mandrel & Nosepiece



Knurled Nutserts

STEEL ZINC PLATED • CLASS 2B THREADS

These new blind threaded inserts with a large head are ideal for applications where large or irregular holes are a problem. Installed from one side, these knurled nutserts work in sheet metal, structural foam, fiberglass, and some plastics. They provide a neat appearance, and once in place the internal threads are ready for a screw or bolt. Additional features of the Knurled Nut Sert include:

- Increased torque or strength over conventional style nutserts.
- 360° knurled expansion after setting
- Vibration resistant
- Large flanged head increases push-out strength

After installation, Knurled Nut Serts provide permanent, captive threads that do not allow loosening under vibration and will not rotate when attached to the mating material. Nut Serts with large diameter heads can be used in soft materials which inherently offer little, if any thread strength. The flat-head design provides the most bearing surface for higher torque applications. The large flange extends above the material in which it is installed and provides a built-in spacer.



IBS No.	Thread Size	Grip Range	Hole Size	Drill Size	Min. Flange	Max. Length	Pkg Qty
49509	6-32	.080 - .130	.264	17/64	.390	.470	25
49501	8-32	.080 - .130	.264	17/64	.390	.470	25
49502	10-24	.020 - .130	.295	19/64	.415	.475	25
49503	10-32	.020 - .130	.295	19/64	.415	.475	25
49504*	1/4-20	.027 - .165	.390	25/64	.500	.580	25
49505*	5/16-18	.027 - .150	.530	17/32	.690	.685	25
49506*	3/8-16	.027 - .150	.530	17/32	.690	.685	25
NS-47360	M4 X .07	.5 - 2.0 mm	6.75+.15 mm	6.75 mm	9.91 mm	10.67 mm	25
NS-47385	M5 X 0.8	.5 - 3.3 mm	7.6+.15 mm	7.6 mm	10.54 mm	12.07 mm	25
NS-47386	M6 X 1.0	.7 - 4.2 mm	10.0+.15 mm	10.0 mm	12.7 mm	14.73 mm	25
NS-47388	M8 X 1.25	.7 - 3.8 mm	13.5+.15 mm	13.5 mm	17.4 mm	17.53 mm	10
NS-47390	M10 X 1.5	.7 - 3.8 mm	13.5+.15 mm	13.5 mm	17.4 mm	17.53 mm	10

* Recommend using Heavy Duty Nutsert Tool (IBS No. 49550) for installation























IBS, INCORPORATED

Assortments Z08

Knurled Nutsert Assortment





IBS No. 431P • 13 items • 127 pcs
 IBS No. 431P-NT • 13 items • 126 pcs • NO TOOL

R
I
V
E
T
S
&
I
N
S
E
R
T
S

 IBS, Inc. <small>SPECIALTY PRODUCTS FOR MAINTENANCE & REPAIR INDUSTRIALBOLT.COM • 800-678-1906</small>			Knurled Nutserts with Tool
Assortment No. 431P			
49514 3/8-16 MANDREL & NOSEPIECE 	49503 10-32 KNURLED GRIP SERT 	49506 3/8-16 KNURLED GRIP SERT 	49500 RIVET NUT GUN 
49513 5/16-18 MANDREL & NOSEPIECE 	NOTE: This size should be installed with Heavy Duty Nutsert Tool P/N 49550 	NOTE: This size should be installed with Heavy Duty Nutsert Tool P/N 49550 	
49512 1/4-20 MANDREL & NOSEPIECE 	49502 10-24 KNURLED GRIP SERT 	49505 5/16-18 KNURLED GRIP SERT 	
49511 10-32 MANDREL & NOSEPIECE 	NOTE: This size should be installed with Heavy Duty Nutsert Tool P/N 49550 	NOTE: This size should be installed with Heavy Duty Nutsert Tool P/N 49550 	
49510 10-24 MANDREL & NOSEPIECE 	49501 8-32 KNURLED GRIP SERT 	49504 1/4-20 KNURLED GRIP SERT 	
49508 8-32 MANDREL & NOSEPIECE 	NOTE: This size should be installed with Heavy Duty Nutsert Tool P/N 49550 	NOTE: This size should be installed with Heavy Duty Nutsert Tool P/N 49550 	

Aluminum Nutsert Assortment

IBS No. 432P • 15 items • 153 pcs

 IBS, Inc. <small>SPECIALTY PRODUCTS FOR MAINTENANCE & REPAIR INDUSTRIALBOLT.COM • 800-678-1906</small>			Aluminum Nutserts
Assortment No. 432P			
49514 3/8-16 MANDREL & NOSEPIECE 	17503 10-32 ALUM RIVET NUT Drill Hole Size 9/32" 	17506 3/8-16 ALUM RIVET NUT Drill Hole Size 1/2" 	49500 RIVET NUT GUN 
49513 5/16-18 MANDREL & NOSEPIECE 	17502 10-24 ALUM RIVET NUT Drill Hole Size 9/32" 	17505 5/16-18 ALUM RIVET NUT Drill Hole Size 1/2" 	
49512 1/4-20 MANDREL & NOSEPIECE 	17501 8-32 ALUM RIVET NUT Drill Hole Size 1/4" 	17504 1/4-20 ALUM RIVET NUT Drill Hole Size 3/8" 	
49511 10-32 MANDREL & NOSEPIECE 	17500 6-32 ALUM RIVET NUT Drill Hole Size 1/4" 		
49510 10-24 MANDREL & NOSEPIECE 	49507 6-32 MANDREL & NOSEPIECE 		
49508 8-32 MANDREL & NOSEPIECE 			



Rivet Nut Gun IBS No. 49500

This thin sheet setting tool has been designed to enable threaded nut inserts to be threaded easily by hand. Invaluable to maintenance engineers for on the spot repairs.

- Designed for the quick manual insertion of permanent load bearing threads in materials from 0.20" to 0.128."
- Simple set up and easy uniform stroke allows a nutsert to be set in thin sheet materials without causing surface damage.
- A comprehensive range of mandrels and nosepieces are available.

Ideal for:

- One side application • Moisture resistant
- Cost effective
- Strong
- Rapid
- Vibration resistant
- Portable

RIVET NUT GUN MANDRELS & NOSEPIECES

IBS No.	Description
49500	Rivet Nut Gun Tool Only No Mandrels or Nosepieces
49507	6-32 Mandrel & Nosepiece
49508	8-32 Mandrel & Nosepiece
49510	10-24 Mandrel & Nosepiece
49511	10-32 Mandrel & Nosepiece
49512	1/4-20 Mandrel & Nosepiece
49513	5/16-18 Mandrel & Nosepiece
49514	3/8-16 Mandrel & Nosepiece
NS-49520*	4mm Mandrel & Nosepiece
NS-49521*	5mm Mandrel & Nosepiece
NS-49522*	6mm Mandrel & Nosepiece
NS-49523*	8mm Mandrel & Nosepiece
NS-49524*	10mm Mandrel & Nosepiece

* Order as non-stock item



IBS, INCORPORATED

Thread Inserts W02

Self-Tapping Threaded Inserts

FOR USE IN ALUMINUM, ALUMINUM ALLOY, MAGNESIUM AND MILD STEEL



Our self-tapping thread inserts features both internal and external threads and cutting bores.

These inserts have a thick wall and the cutting force is distributed over three cutting edges, making them ideal for materials with difficult cutting properties: aluminum, aluminum alloy, magnesium and mild steel.

FEATURES & BENEFITS:

- Taps and installs in one easy step, saving time, money and labor.
- Provides maximum pull-out strength and wear resistant threads in aluminum, aluminum alloy, magnesium and mild steel.
- Three lateral cutting bores make for an easy self-tapping installation, providing a connection that is highly resistant to vibration.

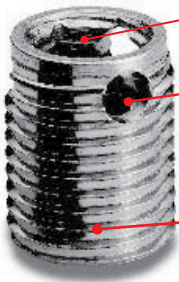

Internal threads are wear-resistant standard class 2B

Circular cutting bores self-tap and lock into the base material. Resists extreme vibration with no loss in performance.

Superior pull-out resistance in softer metals and plastics from the external v-form thread.

INSTALLATION INSTRUCTIONS: (Using a hex head cap screw & nut)

1. Drill to recommended hole size.
2. Thread hex nut onto capscrew. Screw insert onto capscrew with holes away from nut. Tighten the nut snugly to the top of the insert.
3. Using the appropriate wrench or socket, carefully align insert perpendicular to the hole and turn clockwise until flush with the surface. To remove capscrew, hold nut and loosen capscrew.

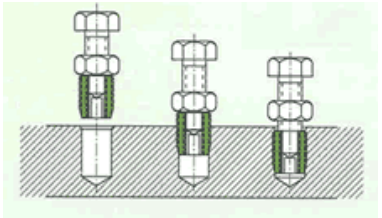

IBS No.	Size	Length	Drill # & Hole Size	Hole Depth	Pkg Qty	IBS No.	Size	Length	Drill # & Hole Size	Hole Depth	Pkg Qty
65935	1/4-20	.472	V (.366)	.591	20	65945	M6-1.0	.472	V (.377)	.591	20
65936	5/16-18	.551	29/64 (.453)	.669	20	65946	M8-1.25	.551	29/64 (.453)	.669	20
65937	3/8-16	.709	17/32 (.531)	.866	10	65947	M10-1.5	.709	17/32 (.531)	.866	10
65939	1/2-13	.945	11/16 (.68)	1.102	10	65948	M12-1.75	.866	39/64 (.609)	1.023	10

RIVETS & INSERTS

Self-Tapping Threaded Inserts Assortment (Z02)
IBS No. 696R • 8 Items
• 60 Pieces
Packaged in a locking steel drawer for storage & organization

Self-Tapping Threaded Inserts

Assortment No. 696R

65935 1/4-20 SELF-TAPPING THREAD INSERT (USE DRILL: V)	65936 5/16-18 SELF-TAPPING THREAD INSERT (USE DRILL: 29/64)	65937 3/8-16 SELF TAPPING THREAD INSERT (USE DRILL: 17/32)	65939 1/2-13 SELF TAPPING THREAD INSERT (USE DRILL: 11/16)
65945 M6-1.0 SELF-TAPPING THREAD INSERT (USE DRILL: V)	65946 M8-1.25 SELF-TAPPING THREAD INSERT (USE DRILL: 29/64)	65947 M10-1.5 SELF TAPPING THREAD INSERT (USE DRILL: 17/32)	65948 M12-1.75 SELF TAPPING THREAD INSERT (USE DRILL: 39/64)



Helical Thread Inserts



Thread inserts are used to replace stripped out or damaged threads in most metals including aluminum. They are made from high quality stainless steel wire, with diamond-shaped cross section, wound to the shape of a spring thread. The insert, which is larger in diameter than the tapped hole, is allowed to spring back, permanently anchoring it into place. Because it is bigger, the insert has greater area to hold in and is stronger than the original threads. The inserts compensatory action shares the load over the entire bolt and hole, thus reducing stud feature, and increasing holding or pull out strength. The Industrial Bolt insert system consists of stainless steel helically wound precision inserts, high quality HSS taps and metal installation tools. Inserts are available in both individual and kit form.

- Creates superior threads with greater holding power
- Quick and easy to use
- Suitable for new applications requiring strong threads
- Simplifies change-over from metric to U.S. threads
- Provides stronger and more efficient threads than other inserts.



**SAFER ON HEAVY DUTY APPLICATIONS
LESS DOWN TIME DUE TO REPLACEMENT**

**KITS INCLUDE TAP,
INSTALLATION TOOL,
& INSERTS**

Helical Thread Installation



STEP 1: DRILL
Drill out old threads, including any broken bolts or studs.



STEP 2: TAP
Tap hole for insert with tap provided in the kit.



STEP 3: INSTALL
Install the helical thread insert and the job is done!



IBS, INCORPORATED

Thread Inserts W02

Helical Thread Inserts

COARSE THREAD

Size	IBS No.		Rec. Drill Size	Inserts Per Pkg
	Kits	Inserts		
6-32	16000	16020	#25	12
8-32	16001	16021	11/64	12
10-24	16002	16022	13/64	12
12-24	16003	16023	15/64	12
1/4-20	16004	16024	17/64	12
5/16-18	16005	16025	21/64	10
3/8-16	16006	16026	25/64	10
7/16-14	16007	16027	29/64	6
1/2-13	16008	16028	17/32	6
9/16-12	16009	16029	19/32	6
5/8-11	16010	16030	21/32	6
3/4-10	16011	16031	25/32	4

FINE THREAD

Size	IBS No.		Rec. Drill Size	Inserts Per Pkg
	Kits	Inserts		
10-32	16012	16032	13/64	12
1/4-28	16013	16033	17/64	12
5/16-24	16014	16034	21/64	10
3/8-24	16015	16035	25/64	10
7/16-20	16016	16036	29/64	6
1/2-20	16017	16037	33/64	6
9/16-18	16017A	16041	37/64	6
5/8-18	16018	16038	41/64	6
3/4-16	16019	16039	49/64	4

ALL KITS & INSERTS SOLD AS PACKAGES ONLY!

FOR EXAMPLE:

1 KIT (16000) = 1 PKG

F

**INCLUDES (12) INSERTS,
(1) INSTALLATION TOOL,
& (1) TAP**

**1 PKG (16032) = 12 INSERTS
ORDER QTY = 1**

HELICAL THREAD INSERTS

Size	IBS No.		Rec. Drill Size	Inserts Per Pkg
	Kits	Inserts		
M6 X 1.0	16042	16051	1/4"	12
M8 X 1.25	16043	16052	21/64"	10
M10 X 1.5	16044	16053	13/32"	10
M12 X 1.75	16045	16054	31/64"	6
M14 X 1.25*	16049	16050		12**

* For Spark Plugs

** Includes 6 each 3/8 & 3/4

R
I
V
E
T
S
&
I
N
S
E
R
T
S



Thread Repair Inserts Installation & Removal



1. Drill out old threads with a standard drill. Countersink with a standard (82° - 100°) countersink.



2. Tap new threads with a standard tap. See charts for proper size and depth.



3. Screw in the insert until slightly below the surface.



4. Drive keys down with several hammer taps on the proper installation tool.

NOTE: Drill is oversized, see charts for proper dimensions.

IBS THREAD REPAIR INSERTS CAN BE REMOVED WITHOUT DAMAGE TO THE PARENT MATERIAL



1. Drill out material between keys and internal thread with standard drill to specified depth (refer to chart for proper dimensions).
2. Bend the keys inward and break off.
3. Remove the old insert using an E-Z Out or similar tool
4. Install the replacement insert into the original tapped hole.

TECHNICAL NOTES:

Material: Carbon Steel Inserts - C1215 or equivalent

Finish: Carbon Steel Insert - Parkerized

Tolerances: ± 0.10 inch or $+ .25$ mm unless specified otherwise

Dimensions: All dimensions are listed in inches.



IBS, INCORPORATED

Thread Inserts W02

Thread Repair Inserts

Heavy Wall



R
I
V
E
T
S
&
I
N
S
E
R
T
S

IBS No.		INSERT			INSTALLATION				REMOVAL	
Carbon Steel	Internal Thread Class 2A	External Thread Mod. Class 2A	Length	Installation Tool Part No.	Tap Drill Size	C'Sink Dia. +.010 - .000	Thread Tap		Drill	
							Size Class 2B	Min. Depth	Size	Depth
65900	8-32	5/16-18	.31	65999	I 16143	.32	5/16-18 17637	.37	7/32	1/8
65901	10-24	3/8-16	.31	65999	Q 16151	.38	3/8-16 17639	.37	9/32	1/8
66101	10-32									
65902	1/4-20	7/16-14	.37	65999	X 16158	.44	7/16-14 17641	.48	11/32	3/16
66102	1/4-28									
65903	5/16-18	1/2-13	.43	65999	29/64 17425	.51	1/2-13 17643	.50	13/32	3/16
66103	5/16-24									
65904	3/8-16	9/16-12	.50	65999	33/64 16833	.57	9/16-12 17645	.56	15/32	3/16
66104	3/8-24									
65905	7/16-14	5/8-11	.62	65999	37/64 16837	.63	5/8-11 17647	.68	17/32	3/16
66105	7/16-20									
65906	1/2-13	3/4-16	.62	65999	45/64 16845	.76	3/4-16 17650	.68	21/32	3/16
66106	1/2-20									
65907	9/16-12	3/4-16	.81	65999	45/64 16845	.76	3/4-16 17650	.94	21/32	3/16
65908	5/8-11	7/8-14	.87	65999	53/64 16853	.88	7/8-14 17652	1.00	25/32	5/16
66108	5/8-18									
65909	3/4-10	1-1/8-12	1.12	65999	1-1/16 16865	1.14	1-1/8-12 NS	1.31	31/32	5/16
66109	3/4-16									



Insert Tool

IBS No. 65999

Use for tapping down locking keys

IBS, INCORPORATED

Thread Inserts W02



Thread Repair Inserts Thin Wall

IBS No.	INSERT			INSTALLATION				REMOVAL			
	Carbon Steel	Internal Thread Class 2A	External Thread Mod. Class 2A	Length	Installation Tool Part No.	Tap Drill Size	C'Sink Dia. +.010 - .000	Thread Tap		Drill	
								Size Class 2B	Min. Depth	Size	Depth
65921	10-24	5/16-18	.31	65999	I 16143	.32	5/16-18 17637	.37	7/32	1/8	
66121	10-32										
65922	1/4-20	3/8-16	.37	65999	Q 16151	.38	3/8-16 17639	.43	9/32	3/16	
66122	1/4-28										
65923	5/16-18	7/16-14	.43	65999	X 16158	.44	7/16-14 17641	.50	11/32	3/16	
66123	5/16-24										
65924	3/8-16	1/2-13	.50	65999	29/64 17425	.51	1/2-13 17643	.56	13/32	3/16	
66124	3/8-24										
65925	7/16-14	9/16-12	.56	65999	33/64 16833	.57	9/16-12 17645	.62	15/32	3/16	
66125	7/16-20										
65926	1/2-13	5/8-11	.62	65999	37/64 16837	.63	5/8-11 17647	.68	17/32	3/16	
66126	1/2-20										

Thread Repair Insert Assortments (Z02)

Assortments with Cabinets

- 212R • USS Heavy Wall**
- 214R • USS Thin Wall**
- 213R • SAE Heavy Wall**
- 215R • USS Thin Wall**

IBS, Inc. <small>INDUSTRIAL SUPPLY COMPANY</small>		Thread Repair Insert Assortments					
<small>1/4-1/2 NC USS Heavy Wall (212R - Row #4 only) 1/4-1/2 NF SAE Heavy Wall (213R Row #2 only) 1/4-1/2 NC USS Thin Wall (214R Row #3 only) 1/4-1/2 NF SAE Thin Wall (215R Row #1 only)</small>							
66122 1/4-28 THIN WALL THD INSERT	66123 5/16-24 THIN WALL THD INSERT	66124 3/8-24 THIN WALL THD INSERT	66125 7/16-20 THIN WALL THD INSERT	66126 1/2-20 THIN WALL THD INSERT			
Use With P/N 16151 "Q" Drill P/N 17639 3/8-16 Tap	Use With P/N 16158 "X" Drill P/N 17641 7/16-14 Tap	Use With P/N 17425 29/64 Drill P/N 17643 1/2-13 Tap	Use With P/N 16833 33/64 Drill P/N 17645 9/16-12 Tap	Use With P/N 16837 37/64 Drill P/N 17647 5/8-11 Tap	Use With P/N 16837 37/64 Drill P/N 17647 5/8-11 Tap		
66102 1/4-28 HVY WALL THD INSERT	66103 5/16-24 HVY WALL THD INSERT	66104 3/8-24 HVY WALL THD INSERT	66105 7/16-20 HVY WALL THD INSERT	66106 1/2-20 HVY WALL THD INSERT	66108 5/8-18 HVY WALL THD INSERT		
Use With P/N 16158 "X" Drill P/N 17641 7/16-14 Tap	Use With P/N 17425 29/64 Drill P/N 17643 1/2-13 Tap	Use With P/N 16833 33/64 Drill P/N 17645 9/16-12 Tap	Use With P/N 16837 37/64 Drill P/N 17647 5/8-11 Tap	Use With P/N 16845 45/64 Drill P/N 17650 3/4-16 Tap	Use With P/N 16853 53/64 Drill P/N 17652 7/8-14 Tap		
65922 1/4-20 THIN WALL THD INSERTS	65923 5/16-18 THIN WALL THD INSERTS	65924 3/8-16 THIN WALL THD INSERTS	65925 7/16-14 THIN WALL THD INSERTS	65926 1/2-13 THIN WALL THD INSERTS	65999 INSERT TOOL FOR THD INSERTS		
Use With P/N 16151 "Q" Drill P/N 17639 3/8-16 Tap	Use With P/N 16158 "X" Drill P/N 17641 7/16-14 Tap	Use With P/N 17425 29/64 Drill P/N 17643 1/2-13 Tap	Use With P/N 16833 33/64 Drill P/N 17645 9/16-12 Tap	Use With P/N 16837 37/64 Drill P/N 17647 5/8-11 Tap			
65902 1/4-20 HVY WALL THD INSERT	65903 5/16-18 HVY WALL THD INSERT	65904 3/8-16 HVY WALL THD INSERT	65905 7/16-14 HVY WALL THD INSERT	65906 1/2-13 HVY WALL THD INSERT			
Use With P/N 16158 "X" Drill P/N 17641 7/16-14 Tap	Use With P/N 17425 29/64 Drill P/N 17643 1/2-13 Tap	Use With P/N 16833 33/64 Drill P/N 17645 9/16-12 Tap	Use With P/N 16845 45/64 Drill P/N 17647 5/8-11 Tap	Use With P/N 16845 45/64 Drill P/N 17650 3/4-16 Tap			

Thread Repair Insert Assortments

Fill-In Assortment Segments

- 221R • USS Heavy Wall**
- 223R • USS Thin Wall**
- 222R • SAE Heavy Wall**
- 224R • USS Thin Wall**

R I V E T S & I N S E R T S



R
I
V
E
T
S
&
I
N
S
E
R
T
S



Automotive

A

Assortments

Black Trim Screws (305P)	X-16
Copper Washer (160R)	X-21
Cyl. Head & Man. Stud (119R)	X-24
Drain Plug Gaskets (322R)	X-20
Drain Plugs & Gaskets (321R)	X-20
J.I.S. Hex Head Capscrews 697R	X-4
Metric Body Hardware (306P)	X-16
Metric J.I.S. Flange Bolts 779R	X-4
Nylon Connectors & Vacuum Caps (301P)	X-26
Phil Pan & Oval Head T/S - Black Oxide (767R)	X-14
Phil Pan & Oval Head T/S - Black Oxide Assortment	X-14
Screws, Tapping	
Phil Oval Head T/S S.S. Assortment	X-14
X-Mas Tree Retainers (303P & 304P)	X-9, X-10

Automotive

Body Hardware	X-13
Rivets	X-12

Au-Ve-Co

Automotive Pigtails	X-27
Cylinder Head & Manifold Studs	X-24
Expansion Plugs	X-23
Rivets & Fasteners	X-12
Screw Grommets & Nuts	X-11
Special Nuts	X-17, X-18, X-22
"X-Mas Tree" Retainers	X-6, X-8, X-27

C

Connectors

Nylon Vacuum	X-25
4-Way	X-25
5-Way	X-25
Straight	X-25
Straight, Reducing	X-25
"Y" Type	X-25

Cylinder Head & Manifold Studs

Universal Studs	
Grade 5	X-24

D

Drain Plug Gaskets

Oil	X-19
-----	------

Drain Plugs

Oil	X-17, X-18
-----	------------

E

Electrical Terminals

GM	
56 Series	X-27

Expansion Plugs

Zinc Plated	
Concave	X-23
Cup Type	X-23

F

Fasteners

Flange Lock Nuts	X-22
Stainless Steel	
Phillips Tapping Screws Pan Head	X-14, X-15

Fasteners, Steel

JIS B1180, Heat Treated	
Class 8.8 Zinc Plated	X-3

G

Gaskets

Drain Plug	X-19
Aluminum	X-19
Black Fibre	X-19
Copper	X-19
Crushable Copper	X-19
Crushable Steel	X-19
Green Fibre	X-19
Nylon	X-19
Rubber/Steel	X-19

J

J.I.S Fasteners

Steel	X-3
-------	-----

N

Nuts

Flange Lock	X-22
Nylon	X-11
Specialty	
Flat, Washer, Tube, "J" & "U" Nuts	X-22

P

Plugs

Drain	X-17, X-18
Expansion, Zinc Plated	X-23
Cup Type	X-23

R

Rubber Vacuum Caps

Hi-Temp	X-26
---------	------



IBS, INCORPORATED

Automotive Index

AUTOMOTIVE

S

Screws

Stainless Steel
Phil Pan Head X-14, X-15

Special Nuts X-17, X-18, X-22

T

Tees & Connectors

Nylon X-25
Reducing X-25

Terminals

Quick Connectors
Instant Auto Connectors X-28

Tire Repair

Chemicals
Bead Sealer X-30
Buffing Solution X-30
Chemical Vulcanizing Cement X-30
Euro-Paste Mounting Compound X-31

CP Cross Ply Bias
Repair Units X-28

Heavy Truck Valves
Brass Valves, Metric X-32

Lead-Wire
Combination Units - Dipped X-30

Passenger & Light Truck Valves
High Pressure Snap-In Valves X-32
Tubeless Snap-In Valves X-32

Tools
Ball Bearing Stitcher X-31
Buffing Wheels X-31
Die-Cast T-Handle Split Eye Needle X-31
Large Applicator Brush, 2" Dia. X-31

Pistol Grip Spiral Cement Probe X-31
Pistol Grip Split-Eye Insert Needle X-31

Universal Quilled Combination Units X-30

Universal String Type Inserts X-28

USA Style COI Radial
Repair Units X-28

USA Style Universal
Repair Units X-28

Valve Accessories & Tools
4-WAY Valve Tool X-33
Air Chucks X-33
Metal Extensions, Passenger X-33
Valve Caps & Cores (Non-TPMS) X-32
Valve Core Remover Tools X-33
Valve Installation Tools X-33

U

Universal Studs

Assortment X-24
Black Oil Finish
High Carbon, Heat Treated X-24

V

Vacuum Caps

Hi-Temp
Rubber X-26

Vacuum Tees & Connectors X-25

W

Washers

Copper X-21
Metric X-22

Washers, Flat

Copper X-21

Wheel Weights

Standard height
Truck X-37
Steel, Adhesive Backed
Low Profile X-37
Low Profile Roll X-37
Standard height X-37
Tools & Accessories
Adhesive Scraper X-38
Hammers X-38
Pliers X-38
Rim Gauges X-38
Steel Weight Roll Stand X-37

Zinc

AW-Series - Coated X-34
EN-Series - Coated X-36
FN Series - Coated X-36
IAW-Series - Coated X-35
LH-Series - Coated X-35
MC-Series - Coated X-35
P Series - Uncoated X-34
T-Series - Coated X-36

Wire

Mechanics
Coil X-26
Spool X-26

IBS, INCORPORATED

Automotive Rivets & Fasteners H04



J.I.S Fasteners

J.I.S. B1180 • STEEL • HEAT TREATED • I.S.O. CLASS 8.8 & 10.9 • ZINC PLATED

J.I.S. fasteners have a smaller hex dimension (across the flats) than DIN or ISO metric fasteners. They fit in those tight spots where the hex of an ISO or DIN fastener is too large. J.I.S. fasteners are OEM equipment on many GM and Japanese import car applications, as well as Japanese imported equipment and machinery.



J.I.S. Hex Head Bolts 8.8

IBS No.	Diameter & Pitch	Length	Pkg. Qty.
M8-1.25 (Width Across the Flats; 12mm)			
10801	8mm-1.25	12mm	100
10802	8mm-1.25	16mm	100
10803	8mm-1.25	20mm	100
10804	8mm-1.25	25mm	50
10805	8mm-1.25	30mm	50
10806	8mm-1.25	35mm	50
10807	8mm-1.25	40mm	50
10809	8mm-1.25	50mm	50
M10-1.25 (Width Across the Flats; 14mm)			
10811	10mm-1.25	20mm	50
10812	10mm-1.25	25mm	50
10813	10mm-1.25	30mm	25
10814	10mm-1.25	35mm	25
10815	10mm-1.25	40mm	25
10816	10mm-1.25	45mm	25
10817	10mm-1.25	50mm	25
10818	10mm-1.25	60mm	25
M12-1.25 (Width Across the Flats; 17mm)			
10821	12mm-1.25	20mm	50
10822	12mm-1.25	25mm	25
10823	12mm-1.25	30mm	25
10824	12mm-1.25	35mm	25
10825	12mm-1.25	40mm	25
10827	12mm-1.25	50mm	25



J.I.S. Hex Flange Bolts 10.9

IBS No.	Diameter & Pitch	Length	Pkg. Qty.
M6-1.00 (Width Across the Flats; 10mm)			
10850	6mm-1.00	12mm	100
10851	6mm-1.00	16mm	100
10852	6mm-1.00	20mm	100
10856	6mm-1.00	25mm	100
10853	6mm-1.00	30mm	100
10854	6mm-1.00	35mm	100
10855	6mm-1.00	40mm	100
M8-1.25 (Width Across the Flats; 12mm)			
10860	8mm-1.25	12mm	50
10861	8mm-1.25	16mm	50
10862	8mm-1.25	20mm	50
10863	8mm-1.25	25mm	50
10864	8mm-1.25	30mm	50
10865	8mm-1.25	35mm	50
10866	8mm-1.25	40mm	50
M10-1.25 (Width Across the Flats; 14mm)			
10870	10mm-1.25	16mm	25
10871	10mm-1.25	20mm	25
10872	10mm-1.25	25mm	25
10873	10mm-1.25	30mm	25
10874	10mm-1.25	35mm	25
10875	10mm-1.25	40mm	25
10876	10mm-1.25	45mm	25
10877	10mm-1.25	50mm	25



J.I.S. Small Hex Nuts

IBS No.	Diameter & Pitch	WAF	Pkg. Qty.
10840	8mm-1.25	12mm	100
10841	10mm-1.25	14mm	100
10842	12mm-1.25	17mm	100



J.I.S. Hex Flange Nuts - Serrated

IBS No.	Diameter & Pitch	WAF	Pkg. Qty.
10845	6mm-1.00	10mm	100
10843	8mm-1.25	12mm	100
10844	10mm-1.25	14mm	100

AUTOMOTIVE



IBS, INCORPORATED

Assortments Z02

J.I.S. Hex Head Capscrews Assortment

IBS No. 697R • 20 Pieces • 595 Items

























Packaged in a locking steel drawer for easy storage & organization

IBS, Inc. SPECIALTY PRODUCTS FOR MAINTENANCE & REPAIR INDUSTRIALBOLT.COM 800-678-1906		JIS Hex Head Capscrews				Assortment No. 697R
10802 M8-1.25 X 16 JIS HEX C/S ZP 	10803 M8-1.25 X 20 JIS HEX C/S ZP 	10804 M8-1.25 X 25 JIS HEX C/S ZP 	10805 M8-1.25 X 30 JIS HEX C/S ZP 	10807 M8-1.25 X 40 JIS HEX C/S ZP 	10811 M10-1.25 X 20 JIS HEX C/S ZP 	
10812 M10-1.25 X 25 JIS HEX C/S ZP 	10813 M10-1.25 X 30 JIS HEX C/S ZP 	10814 M10-1.25 X 35 JIS HEX C/S ZP 	10815 M10-1.25 X 40 JIS HEX C/S ZP 	10816 M10-1.25 X 45 JIS HEX C/S ZP 	10817 M10-1.25 X 50 JIS HEX C/S ZP 	
10822 M12-1.25 X 25 JIS HEX C/S ZP 	10823 M12-1.25 X 30 JIS HEX C/S ZP 	10824 M12-1.25 X 35 HEX C/S JIS ZP 	10825 M12-1.25 X 40 JIS HEX C/S ZP 	10827 M12-1.25 X 50 JIS HEX C/S ZP 		
10840 M8-1.25 JIS HEX NUT ZP 	10841 M10-1.25 JIS HEX NUT ZP 	10842 M12-1.25 JIS HEX NUT ZP 				

Metric J.I.S. Flange Bolts Assortment

IBS No. 779R • 24 Pieces • 605 Items

Packaged in a locking steel drawer for easy storage & organization

IBS, Inc. SPECIALTY PRODUCTS FOR MAINTENANCE & REPAIR INDUSTRIALBOLT.COM 800-678-1906		Metric JIS Flange Bolts				Assortment No. 779R
10850 M6-1.0 X 12 JIS FLANGE BOLT ZP 10.9 	10851 M6-1.0 X 16 JIS FLANGE BOLT ZP 10.9 	10852 M6-1.0 X 20 JIS FLANGE BOLT ZP 10.9 	10856 M6-1.0 X 25 JIS FLANGE BOLT ZP 10.9 	10853 M6-1.0 X 30 JIS FLANGE BOLT ZP 10.9 	10854 M6-1.0 X 35 JIS FLANGE BOLT ZP 10.9 	
10855 M6-1.0 X 40 JIS FLANGE BOLT ZP 10.9 	10860 M8-1.25 X 12 JIS FLANGE BOLT ZP 10.9 	10861 M8-1.25 X 16 JIS FLANGE BOLT ZP 10.9 	10862 M8-1.25 X 20 JIS FLANGE BOLT ZP 10.9 	10863 M8-1.25 X 25 JIS FLANGE BOLT ZP 10.9 	10864 M8-1.25 X 30 JIS FLANGE BOLT ZP 10.9 	
10865 M8-1.25 X 35 JIS FLANGE BOLT ZP 10.9 	10866 M8-1.25 X 40 JIS FLANGE BOLT ZP 10.9 	10870 M10-1.25 X 16 JIS FLANGE BOLT ZP 10.9 	10871 M10-1.25 X 20 JIS FLANGE BOLT ZP 10.9 	10872 M10-1.25 X 25 JIS FLANGE BOLT ZP 10.9 	10873 M10-1.25 X 30 JIS FLANGE BOLT ZP 10.9 	
10874 M10-1.25 X 35 JIS FLANGE BOLT ZP 10.9 	10875 M10-1.25 X 40 JIS FLANGE BOLT ZP 10.9 	10877 M10-1.25 X 50 JIS FLANGE BOLT ZP 10.9 	10845 M6-1.0 JIS SERR FLANGE NUT ZP 	10843 M8-1.25 JIS SERR FLANGE NUT ZP 	10844 M10-1.25 JIS SERR FLANGE NUT ZP 	

AUTOMOTIVE

IBS, INCORPORATED

Automotive Push (X-Mas Tree) Retainers X03



Push Retainers

AUTOMOTIVE

 <p>A-8853 Ford: C5AB-6220586A Door Weather strip (Natural) Hd Dia: 3/16 x 1/2 Stem: 3/16 x 5/8 PKG QTY: 50</p>	 <p>A-10621 GM: 2064891 & 9883583 Door Trim Panel & Headliner White Hd Dia: 3/4 Stem: 5/16 x 1/2 PKG QTY: 50</p>	 <p>A-10831 GM: 332364; Chry: 3691590; AMC: 4004 569; Ford: 389358 Fender & Bumper Shield Black Hd Dia: 11/16 Stem: 5/16 x 5/8 PKG QTY: 50</p>
 <p>A-10832 6270163 Gray Nylon Fender & Bumper Shield Retainer GM-1973-on PKG QTY: 50</p>	 <p>A-11110 Hex Sems Screw Size : 3/8-16 Length : 1-3/8" Across Flats : 9/16" Washer Diam : 1-1/8" Point Type : CA Finish : Phosphate PKG QTY: 25</p>	 <p>A-11120 GM: 87319109 Door Weather strip Black Hd Dia: 13/32 Stem: 5/32 x 3/8 PKG QTY: 100</p>
 <p>A-11129 Chry: 2964547 Weather strip Black Hd Dia: 3/8 Stem: 7/32 x 3/8 PKG QTY: 25</p>	 <p>A-11130 GM, Ford, AMC Hood Insulation Black Hd Dia: 2" Stem: 5/16 x 1/2 PKG QTY: 25</p>	 <p>A-11146 GM: 1605396 Chrysler: 6030441 Ford: 388577S Black Nylon Retainer Hd Dia: 11/16; Stem: 5/16 x 13/16 PKG QTY: 25</p>
 <p>A-11351 Ford: 385661-S Chry: 6003349 VW: N989022 Door Trim Panel Black Hd Dia: 15/16 Stem: 5/16 x 11/16 PKG QTY: 25</p>	 <p>A-11612 GM, Ford, AMC Weather strip Retainer Single Head, Black Nylon Bottom Hd Diam: 7/16" Stem Diam: 3/16" Stem Length: 5/8" PKG QTY: 50</p>	 <p>A-11677 GM: 20298365 Chry: 6013122 Trim Panel - Natural Hd Dia: 9/16 Stem: 11/32 x 11/16 PKG QTY: 50</p>
 <p>A-11678 Chry: 6003349 GM: 9685057 AMC: 4005470 VW: N98905101 Door Trim Panel, White Hd Dia: 15/16 Stem: 5/16 x 11/16 PKG QTY: 25</p>	 <p>A-11680 GM: 25016383 Dash Panel Black Hd Dia: 3/8 Stem: 3/16 x 3/4 PKG QTY: 50</p>	 <p>A-11705 Ford: 387843-S Fender Shield Retainer PKG QTY: 50</p>
 <p>A-11796 GM: 3065575 Trim Panel(White) Hd Dia: 7/8 Stem: 5/16 x 3/4 PKG QTY: 50</p>	 <p>A-11797 Ford: 387477-S Interior Trim (White) Hd Dia: 3/4 Stem: 11/32 x 9/16 PKG QTY: 50</p>	 <p>A-12137 GM: 1619321 Radiator Apron Panel (Black) Hd Dia: 1" Stem: 7/16 x 13/16 PKG QTY: 25</p>
 <p>A-12565 Ford: N801925S Door Trim Panel (White) Hd Dia: 25/32 Stem: 5/16 x 5/8 PKG QTY: 25</p>	 <p>A-12567 GM: 14019205 Front Fender Mud Skirt Retainer PKG QTY: 25</p>	 <p>A-12571 Ford Fascia to Bumper Retainer (Black) Top Hd Dia: 1" Stem Dia: 5/16" Stem Length: 3/16" PKG QTY: 25</p>
 <p>A-12737 GM: 20374473 Door Panel (White) Hd Dia: 3/4 Stem: 5/16 x 3/4 PKG QTY: 50</p>	 <p>A-12757 GM: 56974300 Fascia Retainer PKG QTY: 15</p>	 <p>A-12766 GM: 22512276 Front End Stone Shield,(Black) Hd Dia: 7/8 Stem: 7/16 x 13/16 PKG QTY: 25</p>



IBS, INCORPORATED

Automotive Push (X-Mas Tree) Retainers X03

Push Retainers

AUTOMOTIVE

 <p>A-12909 Ford: 388930-S Trim Panel (Black) Hd Dia: 1" Stem: 9/32 x 1-1/16 PKG QTY: 50</p>	 <p>A-12992 GM: 20421800 Door Trim Panel (White) Bottom Hd Dia: 3/4 x 7/8 Top Hd Dia: 9/32 x 19/32 Stem: 5/16 x 3/4 PKG QTY: 25</p>	 <p>A-13467 GM: 7642589 AMC: 4001 934 Firewall Insulations (Black) Hd Dia: 1-1/4" Stem: 5/16 x 1/2 PKG QTY: 25</p>
 <p>A-13945 015553-S3500 White Nylon Door Trim Panel Retainer Nissan Trucks PKG QTY: 50</p>	 <p>A-13993 GM: 20510029 Body Push Retainer PKG QTY: 25</p>	 <p>A-13994 GM: 20570245 Spare Tire Retainer PKG QTY: 25</p>
 <p>A-14011 GM: 14019226 14071289 Radiator, Overflow Bottle Windshield Washer Bottle Retainer PKG QTY: 25</p>	 <p>A-14012 GM: 15506827 Air Deflector Rivet PKG QTY: 25</p>	 <p>A-14020 Ford: N802781-S Splash Shield & Fascia Retainer PKG QTY: 25</p>
 <p>A-14021 Ford: N803170-S Fascia Retainer (Black) Hd Dia: 7/16 Stem: 7/32 x 1/2 PKG QTY: 25</p>	 <p>A-14144 GM: 95005064 Toyota: 67771-01010 Door Trim Panel (Black) Hd Dia: 18mm Stem: 9.5mm x 14mm PKG QTY: 25</p>	 <p>A-14147 GM: 20547865 Body Retainer PKG QTY: 25</p>
 <p>A-14147 GM: 20547865 Body Retainer PKG QTY: 25</p>	 <p>A-14260 Toyota Push-Type Retainer Screw Type - open end Head Diameter: 15mm Stem Length: 12mm Drive Type: Phillips Hole Size: 7mm PKG QTY: 15</p>	 <p>A-14267 Toyota Push-Type Retainer Screw Type - open end Head Diameter: 15mm Stem Length: 12mm Drive Type: Phillips Hole Size: 7mm PKG QTY: 25</p>
 <p>A-14369 Mazda Push-Type Retainer Screw Type - open end Head Diameter: 20mm Stem Length: 9mm Drive Type: Phillips Hole Size: 6mm PKG QTY: 15</p>	 <p>A-14697 GM: 94198687; Honda: 90657-SA6-0030 Mazda: N304-13-356-A Nylon Push-Type Retainer Head Dia: 14mm Stem Length: 11mm Fits Into 7mm Hole PKG QTY: 25</p>	 <p>A-14698 90688-SB0-003 Nylon Push-Type Retainer Head Dia: 18mm Stem Length: 11mm Fits Into 6 mm Hole PKG QTY: 25</p>
 <p>A-14737 Nissan: 01553-00172; Toyota: 90467-07050 Nylon Retaining Clip Head Dia: 13mm Fits Into 5mm Hole Panel Thickness: 3mm PKG QTY: 25</p>	 <p>A-14753 Push-Type Retainer Screw Type - open end Head Diameter: 20mm Stem Length: 9mm Drive Type: Phillips Hole Size: 6mm PKG QTY: 25</p>	 <p>A-14757 Nissan: 01553-00172; Toyota: 90467-07050 Nylon Retaining Clip Head Dia: 13mm Fits Into 5mm Hole Panel Thickness: 3mm PKG QTY: 25</p>
 <p>A-14947 Nissan: 01553-00172; Toyota: 90467-07050 Nylon Retaining Clip Head Dia: 13mm Fits Into 5mm Hole Panel Thickness: 3mm PKG QTY: 25</p>	 <p>A-14993 GM: 22538004 Black Nylon Push-Type Retainer Hole Dia: .250" Panel Range: .100-.197" Flange Dia: .700" Stem Length: .900" PKG QTY: 25</p>	 <p>A-14994 Ford: N804837S Black Nylon Push-Type Retainer Hole Dia: .250" Panel Range: .100-.240" Flange Dia: 1.000" Stem Length: .900" PKG QTY: 50</p>

IBS, INCORPORATED

Automotive Push (X-Mas Tree) Retainers X03



Push Retainers

 <p>A-15367 GM: 20514862 Screen Shroud Vent Grille to Panel (Black) Hd Dia: 19/32 Stem: 7/32 x 3/4 PKG QTY: 50</p>	 <p>A-15480 Ford Trim Panel & Hood Insulation Retainer Single Head, Black Stem Dia. 8mm Stem Length: 20mm PKG QTY: 50</p>	 <p>A-15668 Ford X-Mas Tree Retainer Single Head, Black Bottom Head Dia.: 1-3/4" Top Head Dia: None Stem Dia.: 9/32 Stem Length: 1" PKG QTY: 25</p>
 <p>A-15670 GM Trim Panel Retainer Triple Head, White Nylon Bottom Head Dia.: 1/2" Top Head Dia: 1/4 x 29/64" Stem Dia.: 5/16" Stem Length: 3/4" PKG QTY: 50</p>	 <p>A-15970 GM Trim Panel Retainer Triple Head, White Nylon Bottom Hd Dia.: 9/16 "x11/16" Top Head Dia: 9/32 x 1/2" Stem Dia.: 5/16" Stem Length: 3/4" PKG QTY: 50</p>	 <p>A-16000 Honda: 90675-SB3-003; Mazda: FB01-56-964; Nissan: 63876-95596 Black Nylon Push Retainer Head Dia: 20mm Stem Length: 9mm Fits Into 8mm Hole PKG QTY: 25</p>
 <p>A-16017 GM Truck Trim Panel Retainer Double Head, White Nylon Bottom Hd Dia.: 3/4" Top Head Dia: 1/2" Stem Dia.: 5/16" Stem Length: 1" PKG QTY: 25</p>	 <p>A-16237 Screw Size : 8-32 Head Diameter : 0.438" Overall Length : 0.499" Shank Length : 0.447" Shank Diameter : 0.312" Head Thickness : 0.052" Hole Size : 5/16" Grip Range : 0.015-0.156" Material : Neoprene Includes : Captive Brass Nut PKG QTY: 25</p>	 <p>A-16782 Honda: 91545-SE0-0030-W Nissan: 63848-01-G00 Nylon Push Retainer Head Dia: 20mm Stem Length: 14mm Fits into 8mm Hole PKG QTY: 25</p>
 <p>A-16835 GM: 10140480; Chry: 6502625 Nylon Rear Bumper Fascia Retainer Head Dia: 21mm (27/32") Panel Range: 3mm (1/8") Stem Length: 25mm (1") Fits Into 12mm (1/2" Hole) APV Vans 1990-on PKG QTY: 25</p>		 <p>A-16858 Nissan: 63844-01A00; Ford: MNA01-56145; NA01-56145 Inner Fender Shield Retainer Head Dia: 20mm (25/32") Stem Length: 18mm (25/32") Fits into 8mm (5/16") Hole Nissan 1980 - on Ford Probe & Aspire 1995- on PKG QTY: 25</p>
 <p>A-17057 90505-SM4-003 Nylon push-type Retainer Head Dia: 18mm Stem Length: 21mm Fits into 8mm hole Accord 1990 - on PKG QTY: 10</p>	 <p>A-17102 Double Head Trim Panel Retainer Color: White Bottom Head Dia: 3/4" Top Head Diameter 1/2" Stem Dia.: 5/16" Length: 1" PKG QTY: 50</p>	
 <p>A-17103 GM & Ford Fascia Retainer Push-Type with Closed End Head Diameter: 15mm Stem Length: 23mm Hole Size: 6mm Color: Black PKG QTY: 50</p>	 <p>A-17143 91502-SM4-0000 Nylon Push Type Retainer Head Dia: 20mm Stem Length: 27mm Fits into 10mm hole Bumper Fascia Accord 1990 - on PKG QTY: 10</p>	 <p>A-17144 91504-SM4-0000 Nylon push-type Retainer Head Dia: 20mm Stem Length: 24mm Fits into 10mm hole Bumper Fascia Accord 1990 - on PKG QTY: 10</p>
 <p>A-17205 91501-SM4-003 Nylon Cowl Top Retaining Clip Head Dia: 14mm Stem Length: 15mm Fits into 6mm Hole Accord 1990 - on PKG QTY: 15</p>	 <p>A-17216 Air Baffle to Under Carriage Retainer Push Type with Closed End Head Diameter: 20mm Stem Length: 20mm Hose Size: 8mm Color: Black PKG QTY: 25</p>	 <p>A-17339 Weather strip Retainer Double Head Bottom Head Dia: 5 x 15M Stem Diameter: 4mm Stem Length: 12MM Material: Nylon, Black PKG QTY: 25</p>
 <p>A-17379 91512-SM4-003 Nylon Fender Splash Shield Push-Type Retainer Head Dia: 20mm Stem Length: 9mm Fits into 8mm hole Accord 1990 - on PKG QTY: 10</p>	 <p>A-18030 Push Type Retainer Closed End Head Diameter: 11/16" Stem Length: 13/16" Hose Size: 1/4" Color: Black PKG QTY: 25</p>	 <p>A-18033 Weather strip Retainer Double Head Bottom Head Dia: 1/4" x 21/32" Stem Diameter: 1/4 Stem Length: 15/32" Material: Nylon, Color: White PKG QTY: 50</p>

AUTOMOTIVE



IBS, INCORPORATED

Automotive Push (X-Mas Tree) Retainers X03

Push Retainers

AUTOMOTIVE

 <p>A-18269 Lower Sill Molding Push Retainer Double Head Bottom Head Dia: 1/4" x 21/32" Stem Diameter: 1/4 Stem Length: 15/32" Material: Nylon, Color: Black PKG QTY: 15</p>	 <p>A-18310 Rear Bumper Fascia Retainer Push Type with Closed End Head Diameter: 1" Stem Length: 15/16" Hole Size: 3/8" Color: Black PKG QTY: 25</p>	 <p>A-18848 Ford Door Trim Panel Retainer Double Head Color: Yellow Bottom Hd Diameter: 3/4" Top Head Diameter: 1/2" Stem Diameter: 3/8" Stem Length: 11/16" PKG QTY: 25</p>
 <p>A-18353 GM Push-Type Retainer Double Head Diameter: 9/16" Stem Length: 41/64" Hose Size: 1/4" Color: White PKG QTY: 25</p>	 <p>A-19145 91560-SP0-003 Gray Nylon Front & Rear Door Trim Panel Retainer Small Head Dia: 13mm Large Head Dia: 17mm Stem Dia: 9mm Stem Length: 12mm Acura Integra & Legend, Honda Accord, Civic Prelude, Odyssey & Del Sol 1991-on PKG QTY: 25</p>	 <p>A-19244 Trunk TrimPanel Push Type Retainer Push-Type with Closed End Head Diameter: 1" Stem Length: 11/16" Hole Size: 1/4" x 1/4" Color: Black PKG QTY: 25</p>
 <p>A-19386 Chrysler Door Trim Panel Retainer Triple Head Bottom Head Diam: 20mm Top Head Diameter: 15mm Stem Length: 15mm Stem Diameter: 9mm Material: Nylon PKG QTY: 25</p>	 <p>A-19801 Wheel Opening Moulding Retainer Push Type with Closed End Head Diameter: 19/32" Stem Length: 3/4" Hole Size: 1/4" PKG QTY: 25</p>	 <p>A-19422 Chrysler Fascia Push-Type Retainer Stem Length: 29/32" Head Size: 1/4" x 1/4" Hole Size: 5/16" PKG QTY: 25</p>
 <p>A-19655 Nylon Hood Insulation Retainer Type: Single Head Head Diam: 1-3/16" Stem Length: 3/4" Stem Diam: 3/8" PKG QTY: 25</p>	 <p>A-19850 Weather strip Retainer Type: Double Head Bottom Hd Diam: 5X15M Stem Diameter: 5MM Stem Length: PKG QTY: 25</p>	 <p>A-20191 Push Type Retainer Screw Type w/Closed End Head Diam: 16MM Stem Length: 18MM Hole Size: 6MM PKG QTY: 25</p>
 <p>A-20349 Bumper Clip, Black Push-Type with Drive Pin Head Diameter: 18MM Stem Length: 12MM Hole Size: 8MM PKG QTY: 15</p>	 <p>A-20923 Cowl Vent Push-Type Retainer Screw Type with Closed End Head Diameter: 11/16" Stem Length: 7/8" Phillips Drive , 1/4" Hole Black PKG QTY: 15</p>	 <p>A-21173 Bumper & Splash Shield Retainer Push-Type with Drive Pin Head Diameter: 20MM Stem Length: 16MM Hole Size: 10MM Black, Includes Metal Insert PKG QTY: 10</p>
 <p>A-21241 Rocker, Pillar & Fender Liner Retainer, Single Head Bottom Head Diam: 26MM Stem Diameter: 7.5MM Stem Length: 28MM Black Nylon PKG QTY: 50</p>		

IBS, INCORPORATED

Assortments Z02



X-Mas Tree Retainers Assortment

IBS. No. 343P • 18 Items • 330 Pieces
Arranged and labeled in a 20 hole steel drawer



IBS, Inc. SPECIALTY PRODUCTS FOR THE AUTOMOTIVE MARKET INDUSTRIALBUILT.COM © P.O. 800-678-1906					X-mas Tree Retainers
					Assortment No. 343P
A-11851 GM 21284 Ford 2002-05 Chrysler 2002-05 AMC 40000000 Black Nylon Shield Retainer Head Dia. 3/8" Stem Length: 1/2" Fits into 1/2" Dia. & 1/2" Hole	A-17664 GM 10171812 Ford 2002-05 Black Nylon Shield Retainer Head Dia. 3/8" Stem Length: 1/2" Fits into 1/2" Dia. & 1/2" Hole	A-12992 GM 20427000 VW Beetle Black Nylon Shield Retainer Head Dia. 3/8" Stem Length: 1/2" Fits into 1/2" Dia. & 1/2" Hole	A-11945 GM 10171812 Ford 2002-05 Black Nylon Shield Retainer Head Dia. 3/8" Stem Length: 1/2" Fits into 1/2" Dia. & 1/2" Hole	A-11130 GM 10171812 Ford 2002-05 Black Nylon Shield Retainer Head Dia. 3/8" Stem Length: 1/2" Fits into 1/2" Dia. & 1/2" Hole	
A-11146 GM 10171812 Ford 2002-05 Black Nylon Shield Retainer Head Dia. 3/8" Stem Length: 1/2" Fits into 1/2" Dia. & 1/2" Hole	A-12737 GM 10171812 Ford 2002-05 Black Nylon Shield Retainer Head Dia. 3/8" Stem Length: 1/2" Fits into 1/2" Dia. & 1/2" Hole	A-11796 GM 10171812 Ford 2002-05 Black Nylon Shield Retainer Head Dia. 3/8" Stem Length: 1/2" Fits into 1/2" Dia. & 1/2" Hole	A-19356 GM 10171812 Ford 2002-05 Black Nylon Shield Retainer Head Dia. 3/8" Stem Length: 1/2" Fits into 1/2" Dia. & 1/2" Hole	A-11498 GM 10171812 Ford 2002-05 Black Nylon Shield Retainer Head Dia. 3/8" Stem Length: 1/2" Fits into 1/2" Dia. & 1/2" Hole	
A-12766 GM 10171812 Ford 2002-05 Black Nylon Shield Retainer Head Dia. 3/8" Stem Length: 1/2" Fits into 1/2" Dia. & 1/2" Hole	A-19541 GM 10171812 Ford 2002-05 Black Nylon Shield Retainer Head Dia. 3/8" Stem Length: 1/2" Fits into 1/2" Dia. & 1/2" Hole	A-12568 GM 10171812 Ford 2002-05 Black Nylon Shield Retainer Head Dia. 3/8" Stem Length: 1/2" Fits into 1/2" Dia. & 1/2" Hole	A-17612 GM 10171812 Ford 2002-05 Black Nylon Shield Retainer Head Dia. 3/8" Stem Length: 1/2" Fits into 1/2" Dia. & 1/2" Hole	A-12909 GM 10171812 Ford 2002-05 Black Nylon Shield Retainer Head Dia. 3/8" Stem Length: 1/2" Fits into 1/2" Dia. & 1/2" Hole	
A-20189 GM 10171812 Ford 2002-05 Black Nylon Shield Retainer Head Dia. 3/8" Stem Length: 1/2" Fits into 1/2" Dia. & 1/2" Hole	A-16818 GM 10171812 Ford 2002-05 Black Nylon Shield Retainer Head Dia. 3/8" Stem Length: 1/2" Fits into 1/2" Dia. & 1/2" Hole	A-12117 GM 10171812 Ford 2002-05 Black Nylon Shield Retainer Head Dia. 3/8" Stem Length: 1/2" Fits into 1/2" Dia. & 1/2" Hole	A-18391 GM 10171812 Ford 2002-05 Black Nylon Shield Retainer Head Dia. 3/8" Stem Length: 1/2" Fits into 1/2" Dia. & 1/2" Hole		

Nylon Push/Screw Type Retainers Assortment

IBS. No. 344P • 17 Items • 155 Pieces
Arranged and labeled in a 20 hole steel drawer



IBS, Inc. SPECIALTY PRODUCTS FOR THE AUTOMOTIVE MARKET INDUSTRIALBUILT.COM © P.O. 800-678-1906					Nylon Push/Screw Type Retainers
					Assortment No. 344P
A-18119 GM 10171812 Ford 2002-05 Black Nylon Push Type Retainer Head Dia. 20mm Stem Length: 20mm Fits into 1/2" Hole Honda 1990-On	A-13993 GM 10171812 Ford 2002-05 Black Nylon Push Type Retainer Head Dia. 18mm Stem Length: 18mm Fits into 1/2" Hole GM 1988-On	A-14993 GM 10171812 Ford 2002-05 Black Nylon Push Type Retainer Head Dia. 18mm Stem Length: 18mm Fits into 1/2" Hole GM 1988-On	A-17143 GM 10171812 Ford 2002-05 Black Nylon Push Type Retainer Head Dia. 18mm Stem Length: 18mm Fits into 1/2" Hole GM 1988-On	A-14698 GM 10171812 Ford 2002-05 Black Nylon Push Type Retainer Head Dia. 18mm Stem Length: 18mm Fits into 1/2" Hole GM 1988-On	
A-14997 GM 10171812 Ford 2002-05 Black Nylon Push Type Retainer Head Dia. 18mm Stem Length: 18mm Fits into 1/2" Hole GM 1988-On	A-14011 GM 10171812 Ford 2002-05 Black Nylon Push Type Retainer Head Dia. 18mm Stem Length: 18mm Fits into 1/2" Hole GM 1988-On	A-14994 GM 10171812 Ford 2002-05 Black Nylon Push Type Retainer Head Dia. 18mm Stem Length: 18mm Fits into 1/2" Hole GM 1988-On	A-14697 GM 10171812 Ford 2002-05 Black Nylon Push Type Retainer Head Dia. 18mm Stem Length: 18mm Fits into 1/2" Hole GM 1988-On		
A-14992 GM 10171812 Ford 2002-05 Black Nylon Push Type Retainer Head Dia. 18mm Stem Length: 18mm Fits into 1/2" Hole GM 1988-On	A-13994 GM 10171812 Ford 2002-05 Black Nylon Push Type Retainer Head Dia. 18mm Stem Length: 18mm Fits into 1/2" Hole GM 1988-On	A-17057 GM 10171812 Ford 2002-05 Black Nylon Push Type Retainer Head Dia. 18mm Stem Length: 18mm Fits into 1/2" Hole GM 1988-On	A-16000 GM 10171812 Ford 2002-05 Black Nylon Push Type Retainer Head Dia. 18mm Stem Length: 18mm Fits into 1/2" Hole GM 1988-On		
A-14260 GM 10171812 Ford 2002-05 Black Nylon Push Type Retainer Head Dia. 18mm Stem Length: 18mm Fits into 1/2" Hole GM 1988-On	A-17632 GM 10171812 Ford 2002-05 Black Nylon Push Type Retainer Head Dia. 18mm Stem Length: 18mm Fits into 1/2" Hole GM 1988-On	A-17222 GM 10171812 Ford 2002-05 Black Nylon Push Type Retainer Head Dia. 18mm Stem Length: 18mm Fits into 1/2" Hole GM 1988-On	A-16858 GM 10171812 Ford 2002-05 Black Nylon Push Type Retainer Head Dia. 18mm Stem Length: 18mm Fits into 1/2" Hole GM 1988-On		

Door Panel & Moulding Clips Assortment

IBS. No. 842R • 18 Items • 315 Pieces
Arranged and labeled in a 20 hole steel drawer



IBS, Inc. SPECIALTY PRODUCTS FOR THE AUTOMOTIVE MARKET INDUSTRIALBUILT.COM © P.O. 800-678-1906					Door Panel and Moulding Clips
					Assortment No. 842R
A-11612 WEATHERSTRIP RETAINER - GM FORD AMC	A-12871 FASCIA TO BUMPER RETAINER BLK FORD	A-12992 1/16 GM NYLON RET. DOOR TRIM PANEL	A-14021 FASCIA RETAINER BLK	A-15480 FORD INTERIOR TRIM PANEL RETAINER - BLACK NYLON	
A-15668 FORD TRIM PANEL RETAINER	A-15670 GM DOOR PANEL RETAINER	A-15970 GM DOOR TRIM PANEL RETAINER WHITE NYLON	A-16017 WHITE NYLON TRIM PANEL RETAINER	A-17102 WHITE TRIM PANEL RETAINER	
A-17339 LINCOLN WEATHERSTRIP RETAINER	A-18033 CHRYSLER WEATHERSTRIP RETAINER	A-18353 DOOR TRIM PANEL PUSH TYPE RETAINER	A-18848 YELLOW FORD DOOR TRIM PANEL RETAINER	A-19386 CHRYSLER TRIM PANEL RETAINER NYLON	
A-19655 HOOD INSULATION RETAINER BLK FORD	A-19850 WEATHER STRIP RETAINER	A-21241 FORD STRIP BLK NYLON ROCKER, FILLER & FENDER LINER 7.5MM X 25MM			

Push-In Fasteners Assortment

IBS. No. 843R • 16 Items • 135 Pieces
Arranged and labeled in a 20 hole steel drawer



IBS, Inc. SPECIALTY PRODUCTS FOR THE AUTOMOTIVE MARKET INDUSTRIALBUILT.COM © P.O. 800-678-1906					Push-In Fasteners
					Assortment No. 843R
A-14260 TOYOTA PUSH-TYPE RETAINER 18MM HEAD DIA.	A-14369 MAZDA PUSH-TYPE RETAINER 20MM HD DIA. 2MM LENGTH	A-14753 PUSH-TYPE RETAINER 11/16 HEAD DIA. 7/8 LENGTH	A-16835 12MM SCREW RETAINER NYLON	A-17103 FASCIA RETAINING CLIP	
A-17216 PUSH-TYPE RETAINER 20MM HEAD DIA. 20MM LENGTH	A-18030 CHRYSLER PUSH TYPE RTRN 11/16 HD 18/16 LOTH	A-18369 CHRYSLER LOWER SILL MOULDING CLIP	A-18310 GM REAR BUMPER FASCIA PUSH RETAINER	A-19244 FORD TRUNK TRIM PANEL RETAINER 1 HEAD DIA	
A-19422 CHRYSLER FASCIA PUSH TYPE RETAINER 29/32 STM LENGTH	A-19801 GM PUSH-TYPE RETAINER	A-20191 FORD PUSH TYPE RTRN 16MM HD DIA 18MM STM LOTH	A-20349 NISSAN BUMPER CLIP PUSH TYPE RETAINER	A-20923 FORD & MAZDA PUSH TYPE RETAINER	
A-21173 ACURA & HONDA PUSH TYPE RTRN BLK BUMPER & SPLASH SHIELD					





AUTOMOTIVE



IBS, INCORPORATED

Automotive Nylon Screw Grommets & Nuts X04





Screw Grommets & Nuts

 <p>A-8242 Chrysler: 6023925 Nylon 1/4" (#14) Screw Size License Plate Nut PKG QTY: 50</p>	 <p>A-9862 Ford: 379830-S Headlight Door, Grille & Mirror Nut Screw size: #8 / #10 PKG QTY: 50</p>	 <p>A-13933 General Motors Grille Nut Screw size: #8 / #10 PKG QTY: 50</p>
	 <p>A-14220 GM: 25525798 Grille Retaining Nut Screw size: #6 / #8 PKG QTY: 50</p>	

AUTOMOTIVE

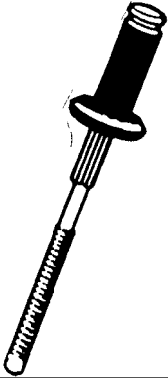

Automotive Rivets

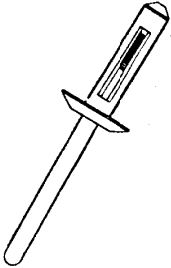
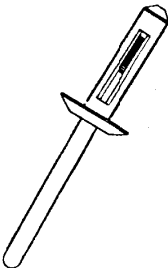
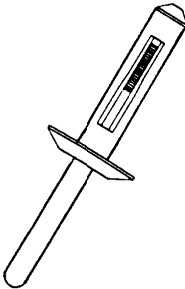
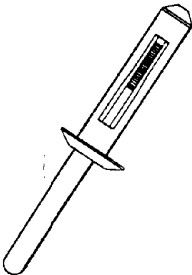
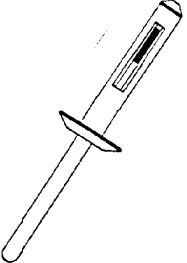
 <p>A-11620 GM: 9436175 Ford: 385189-5100 Chry: 6031115 Peel-type rivet, 1/4 Dia. Grip 1/32 - 9/64 PKG QTY: 25</p>	 <p>A-11621 Ford: 385323-S100 Chry: 6031091 Peel-Type Rivet; 1/4 Dia. Grip 33/64 - 19-32 PKG QTY: 10</p>	
 <p>A-12653 Ford: 388047-S102 Peel Type Rivet 1/4 Dia. Grip: 3/32 - 1/8 PKG QTY: 25</p>	 <p>A-12655 GM: 9437468 Peel Type Rivet 1/4 Dia. Grip: 9/64 - 3/16 PKG QTY: 25</p>	 <p>A-12658 GM: 20184399 Ford: 389268-S100 Peel Type Rivet 1/4 Dia. Grip: 11/16 - 3/4 PKG QTY: 25</p>
 <p>A-13747 GM: 20423647 AMC: 4007325 Auto Blind Rivet 1/16 - 11/64 PKG QTY: 25</p>	 <p>A-13748 GM: 20432975 VW: 175-853-57701C Auto Blind Rivet 13/64 Hole Dia. Grip: 1/8 - 5/32 PKG QTY: 25</p>	 <p>A-13750 GM: 14063981 Ford: N803043S Chry: 6500911 Auto Blind Rivet 1/4 Hole Dia. Grip 5/32 - 13/32 PKG QTY: 25</p>
 <p>A-13751 GM: 20452072 Ford: N83862 Auto Blind Rivet 1/4 Hole Dia. Grip 5/32 - 13/32 PKG QTY: 25</p>		
 <p>A-13755 Chry: 6500898 Auto Blind Rivet 13/64 Hole Dia. Grip 15/64 - 25/64 PKG QTY: 25</p>		

AUTOMOTIVE



IBS, INCORPORATED

Automotive Rivets & Fasteners X05

Body Hardware

AUTOMOTIVE

 <p>A-8847 380575-S2 Black Parkerized 5/16-18 x 1-1/4 Hex Head Sems® with Dog Point 7/8: Washer O.D. 1/2" Hex Ford PKG QTY: 50</p>	 <p>A-11641 015501193 Phosphate M10-1.50 x 40mm Class 9.8 15mm Hex (1-5/32") Washer O.D. GM PKG QTY: 25</p>	 <p>A-12060 11501884 Black Oxide M4.2-1.41 x 20mm (#8 x 25/32") Phillips Washer Head 11mm (7/16") Washer O.D. GM PKG QTY: 100</p>
 <p>A-12065 115503834, 20351035 Phosphate M6-1.0 x 25mm Hex Head Sems® Class 9.8; 10mm Hex 17mm (21/32") Washer O.D. GM PKG QTY: 50</p>	 <p>A-12160 N-606676-S2, S100 Phosphate M6-1.0 x 22mm High Hex Head Sems® with Dog Point Class 9.8; 8mm Hex 19mm (3/4") Washer O.D. Ford PKG QTY: 25</p>	 <p>A-12336 11503632 Black Polyseal M8-1.25 x 25mm Hex Washer Head Class 9.8 3mm Hex (No Sems®) 17mm (21/32") Washer Head O.D. GM PKG QTY: 25</p>
 <p>A-12339 11500996, 11505023 Phosphate M6.3-1.81 x 25mm (#14 x 1") Hex Head Sems® 17mm (21/32") Washer O.D. 10mm Hex GM PKG QTY: 50</p>	 <p>A-12693 11502941; 11560174 Phosphate M6-1.0 x 20mm Hex Head Sems® Class 9.8 17mm (21/32") Washer O.D. 10mm Hex GM PKG QTY: 25</p>	 <p>A-13619 Phosphate M10-1.50 x 30mm Hex Head Sems® Class 9.8 29mm (1-1/8") Washer O.D. 15mm Hex PKG QTY: 10</p>
 <p>A-13613 Phosphate M8-1.25 x 25mm Hex Head Sems® Class 9.8, 13mm Hex 24mm (15/16") Washer O.D. PKG QTY: 25</p>	 <p>A-15373 11503892; 11500434 M4.2-1.41 x 20 (#8 x 25/32") Hex Head Sems® 16mm (5/8") Washer O.D. 7mm Hex; GM PKG QTY: 50</p>	 <p>A-15780 N606690-S2 Phosphate M8-1.25 x 33mm Hex Head Sems® with Dog Point Class 9.8 10mm Hex 22mm (7/8") Washer O.D. Ford PKG QTY: 50</p>
 <p>A-15818 6100568 Phosphate M6-1.0 x 30mm Hex Head Sems® with Dog Point Class 9.8, 10mm Hex 19mm (3/4") Washer O.D. Chrysler PKG QTY: 50</p>	 <p>A-16589 Zinc & Yellow Dichromate #10 x 3/4 (19mm) Indented Hex Head Sems® Washer O.D.: 19/32" 5/16" (8mm) Hex Honda, Nissan, Toyota PKG QTY: 50</p>	 <p>A-16893 N800947-S, AB-181-GG Phosphate M6-1.0 x 28mm Hex Head Sems® with Dog Point Class 9.8 25mm (1") Washer O.D. 8mm Hex Ford PKG QTY: 25</p>
 <p>A-16828 Zinc & Yellow Dichromate M6.3-1.81 x 20mm (#14 x 25/32") Hex Head Sems® 18mm (45/64") Washer O.D. 10mm Hex Honda, Nissan & Toyota PKG QTY: 25</p>		

IBS, INCORPORATED

Automotive Screws X05



Phillips Pan Head Tapping Screws - Black Oxide (X05)



Length	Diameter			Length
	#6	#8	#10	
3/8	A-16889			3/8
1/2	A-11917	A-10180	A-11921	1/2
3/4	A-11918	A-10181	A-11922	3/4
1	A-11919	A-10182	A-11923	1
1-1/4		A-10183	A-11924	1-1/4
1-1/2			A-12800	1-1/2
Pkg Qty	100	100	100	Pkg Qty

Phillips Oval Head Tapping Screws - Black Oxide (X05)



Length	Diameter			Length
	#6	#8	#10	
1/2	A-12795	A-10163	A-11084	1/2
3/4	A-12796	A-10165	A-11086	3/4
1	A-12797	A-10167	A-11088	1
1-1/4		A-10169		1-1/4
Pkg Qty	100	100	100	Pkg Qty

Phil Pan & Oval Head T/S - Black Oxide Assortment

IBS No. 767R • 24 Items — 1100 Pieces

Packaged in a locking steel drawer for easy storage & organization.

IBS, Inc.
SPECIALTY PRODUCTS FOR MAINTENANCE & REPAIR
INDUSTRIALBOLT.COM • 800-678-1906

Phillips Bit Chart

This chart will help you match the screw size to the proper Phillips bit.

POINT #1 - FOR SCREWS AS SHOWN
POINT #2 - FOR SCREWS AS SHOWN
POINT #3 - FOR SCREWS AS SHOWN
POINT #4 - FOR SCREWS AS SHOWN

Phillips Pan and Oval Head Tapping Screws - Black Oxide

Assortment 767R

A-16889 6 X 3/8 PHIL PAN HD T/S B/O	A-11917 6 X 1/2 PHIL PAN HD T/S B/O	A-11918 6 X 3/4 PHIL PAN HD T/S B/O	A-11919 6 X 1 PHIL PAN HD T/S B/O	A-10180 8 X 1/2 PHIL PAN HD T/S B/O	A-10181 8 X 3/4 PHIL PAN HD T/S B/O
A-10182 8 X 1 PHIL PAN HD T/S B/O	A-10183 8 X 1-1/4 PHIL PAN HD T/S B/O	A-12799 8 X 1-1/2 PHIL PAN HD T/S B/O	A-11921 10 X 1/2 PHIL PAN HD T/S B/O	A-11922 10 X 3/4 PHIL PAN HD T/S B/O	A-11923 10 X 1 PHIL PAN HD T/S B/O
A-11924 10 X 1-1/4 PHIL PAN HD T/S B/O	A-12800 10 X 1-1/2 PHIL PAN HD T/S B/O	A-12795 6 X 1/2 PHIL OVAL HD T/S B/O	A-12796 6 X 3/4 PHIL OVAL HD T/S B/O	A-12797 6 X 1 PHIL OVAL HD T/S B/O	A-10163 8 X 1/2 PHIL OVAL HD T/S B/O
A-10165 8 X 3/4 PHIL OVAL HD T/S B/O	A-10167 8 X 1 PHIL OVAL HD T/S B/O	A-10169 8 X 1-1/4 PHIL OVAL HD T/S B/O	A-11084 10 X 1/2 PHIL OVAL HD T/S B/O	A-11086 10 X 3/4 PHIL OVAL HD T/S B/O	A-11088 10 X 1 PHIL OVAL HD T/S B/O



IBS, INCORPORATED

Automotive Screws X05

Phillips Flat Top Washer Head T/S - Black Oxide (X05)



Length	Diameter		Washer Head Dia.	Length
	#8	#10		
1/2	A-12213		13/32"	1/2
3/4	A-12215	A-12953	13/32"	3/4
1	A-12216	A-12954	13/32"	1
Pkg Qty	100	50		Pkg Qty

Phillips Oval Hd SEMS Flush Washer T/S - Black Oxide (X05)



Length	Diameter	Head Diam.	Length
	#8		
1-1/4	A-10654	#6	1-1/4
Pkg Qty	100		Pkg Qty

Phillips Pan Head SEMS T/S - Black Oxide (X05)



Length	Diameter	Washer Head Dia.	Length
	#8		
3/4	A-12820	1/2"	3/4
Pkg Qty	50		Pkg Qty

Black Trim Screws Assortment

IBS. No. 345P • 22 Items • 950 Pieces
Arranged and labeled in a locking steel drawer for easy storage & organization.



IBS, Inc. Black Trim Screws					
Assortment No. 345P					
A-10654 #8 X 1-1/4 PHIL OVAL SEMS T/S	A-12820 #8 X 3/4 PHIL PAN SEMS T/S B/O		A-12213 #8 X 1/2 PHIL FLT TOP WASH HD	A-12215 #8 X 3/4 PHIL FLT TOP WASH HD	A-12216 #8 X 1 PHIL FLT TOP WASH HD
A-12953 10 X 3/4 PHIL FLT TOP WASH HD	A-12954 10 X 1 PHIL FLT TOP WASH HD	A-10180 8 X 1/2 PHIL PAN HD T/S B/O	A-10181 8 X 3/4 PHIL PAN HD T/S B/O	A-10182 8 X 1 PHIL PAN HD T/S B/O	A-10183 8 X 1-1/4 PHIL PAN T/S B/O
A-11921 10 X 1/2 PHIL PAN HD T/S B/O	A-11922 10 X 3/4 PAN HD T/S B/O	A-11923 10 X 1 PHIL PAN HD T/S B/O	A-10163 8 X 1/2 PHIL OVAL T/S B/O	A-10165 8 X 3/4 PHIL OVAL T/S B/O	A-10167 8 X 1 PHIL OVAL T/S B/O
A-11086 10 X 3/4 PHIL OVAL T/S B/O	A-11085 10 X 1 PHIL OVAL T/S B/O		A-12060 M4.2 X 20 PHIL WASHER HD T/S	A-15373 M4.2 X 20 HEX HD SEMS T/S B/O	A-12359 M5.3 X 25 HEX HD SEMS T/S B/O

Metric Body Hardware Assortment

IBS. No. 346P • 19 Items • 215 Pieces
Arranged and labeled in a locking steel drawer for easy storage & organization.



IBS, Inc. Metric Body Hardware				
Assortment No. 346P				
A-12060 M4.2 X 20 PHIL WASHER HD T/S	A-15373 M4.2 X 20 HEX HD SEMS T/S B/O	A-12359 M5.3 X 25 HEX HD SEMS T/S B/O		
A-11921 10 X 1/2 PHIL PAN HD T/S B/O	A-11922 10 X 3/4 PAN HD T/S B/O	A-11923 10 X 1 PHIL PAN HD T/S B/O	A-10163 8 X 1/2 PHIL OVAL T/S B/O	A-10165 8 X 3/4 PHIL OVAL T/S B/O
A-10181 8 X 3/4 PHIL PAN HD T/S B/O	A-10182 8 X 1 PHIL PAN HD T/S B/O	A-10183 8 X 1-1/4 PHIL PAN T/S B/O		
A-12213 #8 X 1/2 PHIL FLT TOP WASH HD	A-12215 #8 X 3/4 PHIL FLT TOP WASH HD	A-12216 #8 X 1 PHIL FLT TOP WASH HD		
A-10654 #8 X 1-1/4 PHIL OVAL SEMS T/S	A-12953 10 X 3/4 PHIL FLT TOP WASH HD	A-12954 10 X 1 PHIL FLT TOP WASH HD		

IBS, INCORPORATED

Automotive Truck Oil Drain Plugs X01



Oil Drain Plugs

AUTOMOTIVE

 <p>A-8285 Oversize Oil Pan Drain Plug with Fibre Gasket Zinc & Yellow Self-Tapping Thread 5/8-18 / Single Oversize PKG QTY: 5</p>	 <p>A-14678 Plain Thread M14-1.5 / Hex: 16mm Length Under Head: 20mm fits the following M14-1.5 applications AMC: 4 Cyl. VW 121 Eng. 79-77 Chevrolet : 4 Cyl. 1.8 (Diesel) Eng 81-On Chrysler Corp. Imports: 4 Cyl. All 78-On 4 Cyl. K & W Engines (built after 10-81) 82 Ford Motor Co.: 4 & 6 cyl 98, 122, 140, 171 Eng. / 73-On Honda' 4 Cyl. Prelude 83-On Mazda; 4 Cyl. 72-On Pontiac; 4 Cyl. 1.8 (Diesel) 83-On Volkswagen; 4 Cyl. All (Water Cooled Engine) / 74-On PKG QTY: 5</p>	 <p>A-18024 Zinc / Thread M14-1.25 Hex: 13mm Length Under Head: 16mm Fits the following applications: Jeep PKG QTY: 5</p>
 <p>A-14196 Plain / Thread 1/2-20 / Hex: 7/8" Length Under Head: 1/2" Fits the following applications AMC: 6 & 8 Cyl. All 64-On Buick: 4,6 & 8 Cyl. All [Exc. 2.5 (151), 3.0, 4.3, 4.9 (301 Eng.) 59-On Cadillac: 6 & 8 Cyl. All [Exc. 4.1 Eng] 66-On Chevrolet (Includes Light Truck) 4,6 & 8 Cyl. All [Exc. 1.8 (diesel), 2.5 (151), 4.3 (diesel) Eng.] 28-On Chrysler Corp.: 6 & 8 Cyl. All 62-On Ford Motor Co. 4,6,* Cyl. All [Exc. 98, 122, 140, 171 Eng] 57-On GMC (Light Truck): 6 & 8 Cyl. all 39-On Oldsmobile 4,6 & 8 Cyl. All [Exc. 2.5 (151), 3.0, 4.3, (diesel) 4.3S, 4.9T (301)] 61-On Pontiac 4,6 & 8 Cyl. All [Exc. 1.8 (diesel), 2.5 (151), 4.3 (diesel), 4.3S, 4.9T (301)] 60-On PKG QTY: 10</p>	 <p>A-15527 Zinc / Thread M12-1.25 / Hex: 14mm / Length Under Head: 11mm Fits the following M12-1.25 applications: Nissan Sentra, Stanza & Pulsar w/FWD 82-On PKG QTY: 5</p>	 <p>A-18121 Oversize Oil Pan Drain Plug with Fibre Gasket Zinc & Yellow Self-Tapping Thread 1/2-20 Double Oversize PKG QTY: 5</p>
 <p>A-14677 Zinc / Thread M12-1.75, Hex: 15mm Length Under Head: M12-1.75 Fits the following applications AMC: 4 Cyl. 151 Eng. 83-81 Buick: 4 Cyl 151 (2.5) eng (80-On) 6 Cyl. 3.0, 4.3 (Diesel) Eng. 82-On 8 Cyl. 4.3, 4.9 Eng. 81-77 Cadillac: 8 Cyl. 4.1 Eng. 82-On Chevrolet: 4 Cyl. 151 (2.5) Eng 78-On 6 Cyl. 4.3 (Diesel) Eng. 82-On Oldsmobile: 4 Cyl. 151 (2.5) Eng. 78-On 6 Cyl. 3.0, 4.3 (Diesel) Eng. 82-On 8 Cyl. 4.3S, 4.9T (301) Eng. 80-79 Pontiac: 4 Cyl. 151 (2.5) Eng. 77-On 6 Cyl. 4.3 (Diesel) Eng 82-On 8 Cyl. 4.3S, 4.9T (301) Eng. 81-77 PKG QTY: 5</p>	 <p>A-15528 Zinc / Thread / M16.4-1.33 O.S. Hex: 19mm / Length Under Head: 13mm Fits the following M1 .4 O.S. applications: Nissan Sentra, Stanza & Pulsar w/FWD 62-On Renault: Fuego & LeCar 80-On PKG QTY: 5</p>	 <p>A-19130 (3921988) Plain Thread 1/2-20 Hex: 9/16" Length Under Head: 13/16" Fits the following applications Buick 4,6 & 8 Cyl. All [Exc. 2.5 (151), 3.0, 4.3, 4.9 (301 Eng.) 59-On Cadillac 6 & 8 Cyl. All [Exc. 4.1 Eng] 66-On Chevrolet (Includes GMC Light Truck) 4,6 & 8 Cyl. All [Exc. 1.8 (diesel), 2/5 (151), 4.3 (diesel) Eng.] 28-On Oldsmobile 4,6 & 8 Cyl. All [Exc. 2.5 (151), 3.0, 4.3, (diesel) 4.3S, 4.9T (301)] 61-On Pontiac 4,6 & 8 Cyl. All [Exc. 1.8 (diesel), 2.5 (151), 4.3 (diesel), 4.3S, 4.9T (301)] 60-On PKG QTY: 15</p>
 <p>A-15529 Zinc / Thread M18-1.5 Hex: 19mm Length Under Head: 12mm fits the following M18 .5 applications: Chrysler: All imports 70-On Renault: LeCar 79-76 Toyota: All 75-On PKG QTY: 5</p>	 <p>A-16308 Zinc / Thread M14-1.5 / Hex: 16mm Length Under Head: 11mm fits the following M14-1.5 applications: Chrysler Imports 83-On / Honda 83-On Isuzu 87-On / Mazda 72-On / Spectrum 88-On Sprint 88-On / VW Audi 74-On PKG QTY: 5</p>	
 <p>A-17145 Zinc Plated / Type 1 Thread 1/2-20 / Single Oversize Hex: 3/4" / Length Under Head: 13/16" PKG QTY: 2</p>		



IBS, INCORPORATED

Automotive Truck Oil Drain Plug Gaskets X09

Drain Plug Gaskets

OIL DRAIN PLUG GASKETS

IBS No.	I.D.	O.D	Thickness	Type	Qty
A-19538	1/2	3/4	5/64	Black Fibre	50
A-8277	1/2	3/4	3/32	Nylon	25
D-095-001	1/2	3/4	3/32	Copper	25
A-15918	1/2	7/8	1/16	Copper	25
A-16996	1/2	15/16	1/16	Nylon	25
D-095-002	5/8	1	3/32	Copper	25
A-8278	5/8	1	3/32	Nylon	25
D-097-010	9/16	13/16	3/32	Nylon	25
A-15919	9/16	13/16	3/32	Copper	25
A-8279	3/4	1-1/16	3/32	Nylon	25
A-16680	12mm	22mm	1.5mm	Nylon	50
A-18726	12mm	22mm	2mm	Black Fibre	50
A-16956	14mm	22mm	2mm	Aluminum	50
A-16681	14mm	24mm	1.5mm	Nylon	50
A-18828	14mm	24mm	1.5mm	Green Fibre	25
A-16682	14mm	24mm	2mm	Black Fibre	50
A-16683	16.5mm	27mm	1.5mm	Nylon	50
A-16955	18mm	25.5mm	2mm	Aluminum	50
A-18829	18mm	29mm	1.5mm	Green Fibre	25
A-19139	20mm	26mm	2mm	Steel	10

On vehicles equipped with aluminum gaskets, a new aluminum gasket must be installed at each oil change

OIL DRAIN PLUG CRUSHABLE GASKETS

A-19545	1/2	3/4	5/64	Copper	10
A-19319	12mm	17mm	2mm	Steel	15
A-19007	14mm	19mm	2mm	Steel	10
A-17263	16mm	22mm	2mm	Copper	10
A-17264	18mm	24mm	2mm	Copper	10

STEEL WITH RUBBER SEAL OIL DRAIN PLUG GASKETS

A-16026	1/2	1"	3/64	Rubber/Steel	5
A-18299	14mm	25mm	1mm	Rubber/Steel	10

A
U
T
O
M
O
T
I
V
E



IBS, INCORPORATED

Assortments Z02



Automotive Drain Plugs

IBS No. 321R • 12 Items • 72 Pieces
 Arranged and labeled in a locking steel drawer for easy storage & organization.



IBS Inc. SPECIALTY PRODUCTS FOR MAINTENANCE & REPAIR INDUSTRIALDRY.COM © © © 320-678-1808					Automotive Drain Plugs				
Assortment No. 321R									
A-14196 1/2-20 OIL DRAIN PLUG	A-19130 1/2 DRAIN PLUG	A-17145 1/2-20 OVERSIZE DRAIN PLUG	A-18121 1/2 OIL DRAIN PLUG	A-8285 5/8-18 OVERSIZE DRAIN PLUG W/ FIBRE					
A-15527 M12-1.25 OIL DRAIN PLUG	A-14677 M12-1.75 OIL PAN PLUG	A-18024 14MM DRAIN PLUG W/GASKET	A-16308 14MM DRAIN PLUG	A-14678 M14 DRAIN PLUG					
A-15528 16MM DRAIN PLUG	A-15529 18MM DRAIN PLUG								

Automotive Drain Plug Gaskets

IBS No. 322R • 20 Items • 260 Pieces
 Arranged and labeled in a locking steel drawer for easy storage & organization.



IBS Inc. SPECIALTY PRODUCTS FOR MAINTENANCE & REPAIR INDUSTRIALDRY.COM © © © 320-678-1808					Oil Drain Plug Gaskets				
Assortment No. 322R									
A-18726 12MM ID 22MM OD BLACK DRAIN	A-18665 DRAIN PLUG RUBBER GASKET M12-1.75	A-16996 1/2 NYLON DRAIN PLUG GASKET	A-19838 1/2ID X 3/4OD BLACK FIBER	A-8277 1/2 NYLON GASKET					
A-16026 1/2 STEEL & RUBBER DRAIN PLUG	A-15918 1/2 COPPER DRAIN WASHER	A-19545 1/2 COPPER DRAIN PLUG GASKET	A-16682 14MM DRAIN PLUG GASKET	A-16681 M14 NYLON DRAIN PLUG GASKET					
A-18299 14MM X 25MM RUBBER/STEEL FORD	A-19007 14MMX20MM STEEL CRUSHABLE	A-16956 M14 ALUMINUM DRAIN PLUG GASKET	A-8278 5/8 NYLON OIL DRAIN PLUG	A-17263 M16 COPPER WASHER					
A-16683 M16.5 NYLON DRAIN PLUG GASKET	A-18829 M18 GREEN OIL DRAIN PLUG	A-17264 M18 COPPER WASHER	A-16955 18MM ALUM OIL DRAIN PLUG	A-19139 20MM STEEL OIL DRAIN PLUG					

Copper Washers

Copper Washer Assortment (Z02)

IBS No. 160R • 10 Items - 250 Pieces
 Arranged and labeled in a locking steel drawer for easy storage & organization.



IBS No.	I.D.	O.D.	Thick	Qty
D-725-001	1/4"	5/8"	1/16"	50
D-725-002	5/16"	11/16"	1/16"	50
D-725-003	3/8"	3/4"	1/16"	50
D-725-004	7/16"	13/16"	1/16"	50
D-725-005	1/2"	7/8"	1/16"	50
D-725-011	1/4"	7/16"	1/32"	50
D-725-012	5/16"	1/2"	1/32"	50
D-725-013	3/8"	9/16"	1/32"	50
D-725-014	7/16"	5/8"	1/32"	50
D-725-015	1/2"	11/16"	1/32"	50

IBS Inc. SPECIALTY PRODUCTS FOR MAINTENANCE & REPAIR INDUSTRIALDRY.COM © © © 320-678-1808			Copper Washers		
Assortment No. 160R					
D-725-001 1/4ID X 5/8OD COPPER WASHER	D-725-002 5/16ID X 11/16OD COPPER WASHER	D-725-003 3/8ID X 3/4OD COPPER WASHER			
D-725-004 7/16ID X 13/16OD COPPER WASHER	D-725-005 1/2ID X 7/8OD COPPER WASHER				
D-725-011 1/4ID X 7/16OD COPPER WASHER	D-725-012 5/16ID X 1/2OD COPPER WASHER	D-725-013 3/8ID X 9/16OD COPPER WASHER			
D-725-014 7/16ID X 5/8OD COPPER WASHER	D-725-015 1/2ID X 11/16OD COPPER WASHER				



AUTOMOTIVE



IBS, INCORPORATED

Automotive Specialty Nuts X06

Special Nuts

 <p>A-2422 "U" Nuts #10 Screw Size PKG QTY: 100</p>	 <p>A-2611 Tubular Nut #12 Tapping Screw PKG QTY: 100</p>	 <p>A-9298 Pushnut Bolt Retainer Bolt Dia: 7/16" O.D.: 27/32" PKG QTY: 100</p>
 <p>A-9879 "U" Nut #8 Screw Size PKG QTY: 100</p>	 <p>A-10050 Extruded (Foldover) "U" Nut 1/4-20 Screw; 19/32 Edge to Center of Hole PKG QTY: 25</p>	 <p>A-10051 Extruded (Foldover) "U" Nut 1/4-20 Screw 25/32 Edge to Center of Hole PKG QTY: 50</p>
 <p>A-10053 Extruded (Foldover) "U" Nut 5/16-18 Screw 9/16 Edge to Center of Hole PKG QTY: 50</p>	 <p>A-10055 Extruded (Foldover) "U" Nut 3/8-16 Screw 1-1/8 Edge to Center of Hole PKG QTY: 25</p>	 <p>A-10064 Extruded (Foldover) "U" Nut #6 Screw Size PKG QTY: 50</p>
 <p>A-10073 Tubular Nut 3/16 Stud 7/32 Hole PKG QTY: 100</p>	 <p>A-11630 Extruded (Foldover) "U" Nut M10 - 1.25 Screw Size PKG QTY: 25</p>	 <p>A-11631 Extruded (Foldover) "U" Nut M10 - 1.50 Screw Size PKG QTY: 25</p>
 <p>A-11864 Extruded (Foldover) "U"-Nut M6-1.0 Screw Size GM PKG QTY: 50</p>	 <p>A-12575 Extruded (Foldover) "U" Nut M6 - 1.0 Screw Size PKG QTY: 25</p>	 <p>A-12667 Extruded (Foldover) "U" Nut M8 - 1.25 Screw Size PKG QTY: 25</p>
 <p>A-12669 Extruded (Foldover) "U" Nut M6 - 1.0 Screw Size PKG QTY: 25</p>		

Metric Washer & Flange Lock Nuts

METRIC FREE SPINNING WASHER NUTS									
	IBS No.	Thread Size	Type	Washer O.D.	Hex Size	Height	Plating	OEM No.	Pkg Qty.
	15329	M6-1.0	B	18mm	10mm	9mm	Phosphate	6100048	50
	15333	M8-1.25	B	18mm	13mm	10mm	Phosphate	6100050	50
	15334	M8-1.25	B	19mm	13mm	10mm	Phosphate	11501800	50
	15337	M10-1.5	B	24mm	15mm	13mm	Phosphate	N621942	50
METRIC FLANGE LOCK NUTS									
	IBS No.	Thread Size	Flange O.D.	Hex Size	Height	Plating	OEM No.	Pkg Qty.	
	15316	M6-1.0	14mm	10mm	7.5mm	Phosphate	N620480	50	
	11709	M8-1.25	17mm	13mm	8.5mm	Zinc	11502811	50	

AUTOMOTIVE

Expansion Plugs — Zinc Plated



Concave Expansion Plugs

IBS No.	Size	Pkg. Qty.
A-3937	1/2"	100
A-3938	5/8"	100
A-3939	3/4"	100
A-3941	15/16"	100
A-3942	1"	100
A-3944	1-1/8"	100
A-3946	1-1/4"	100
A-3949	1-5/8"	50

Cup Type Expansion Plugs

IBS No.	Size	Pkg. Qty.
A-3952	7/16"	25
D-555-002	1/2"	10
A-3956	5/8"	25
A-3957	3/4"	25
A-3958	7/8"	25
A-15212	15/16"	25
A-3960	1"	25
A-3961	1-1/8"	25
A-3962	1-7/32"	25
A-3963	1-1/4"	25
A-3964	1-3/8"	25
A-3965	1-1/2"	25
A-3966	1-5/8"	25
A3967	1-3/4"	25
A-3968	1-7/8"	25
A-3969	1-15/16"	25
A-3971	2"	25



Cup Type Expansion Plug

AUTOMOTIVE



IBS, INCORPORATED

Grade 5 Cylinder Head & Manifold Studs X08

Cylinder Head & Manifold Studs

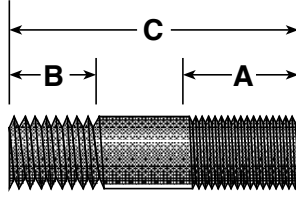

**Grade 5
Medium
Carbon
Heat Treated
Steel**

IBS No.	A Dia. x Length	B Dia. x Length	C Overall Length	Pkg Qty
A-9668	1/4-28 x 1/2	1/4-20 x 1/2	1-1/4	10
A-9669	1/4-28 x 3/4	1/4-20 x 1/2	1-1/2	10
A-9670	1/4-28 x 1	1/4-20 x 1/2	2	10
A-9673	5/16-24 x 1/2	5/16-18 x 3/8	1	10
A-9675	5/16-24 x 5/8	5/16-18 x 3/4	1-1/2	10
A-9677	5/16-24 x 1	5/16-18 x 9/16	2	10
A-9678	5/16-24 x 1/2	5/16-18 x 1/2	2-1/2	10
A-9683	3/8-24 x 3/4	3/8-16 x 1/2	1-1/2	10
A-9684	3/8-24 x 3/4	3/8-16 x 1/2	1-3/4	10
A-9685	3/8-24 x 3/4	7/16-14 x 7/8	1-7/8	10
A-9686	3/8-24 x 1	3/8-16 x 5/8	2	10
A-9690	3/8-24 x 2	3/8-16 x 5/8	3	10
A-9696	3/8-24 x 1-7/8	3/8-16 x 1/2	4	10
A-9699	7/16-20 x 3/4	7/16-14 x 9/16	1-3/4	10
A-9701	7/16-20 x 7/8	7/16-14 x 3/4	2	10
A-9711	7/16-20 x 1-1/4	7/16-14 x 3/4	2-1/2	10
A-9712	7/16-20 x 1-3/8	7/16-14 x 3/4	2-1/2	10
A-9715	7/16-20 x 1-13/16	7/16-14 x 3/4	3	10
A-9727	1/2-20 x 3/4	1/2-13 x 3/4	1-7/8	10
A-9731	1/2-20 x 1	1/2-13 x 3/4	2-1/2	10
A-9732	1/2-20 x 2	1/2-13 x 3/4	3	10
A-9739	9/16-18 x 1-1/4	9/16-12 x 1	3	10
A-9744	5/8-18 x 1-1/2	5/8-11 x 13/16	2-3/4	10
A-9745	5/8-18 x 1-1/4	5/8-11 x 1	3-1/2	10

Cylinder Head & Manifold Stud Assortment

Arranged and labeled in a locking steel drawer for easy storage & organization.

IBS No. 119R • 20 Items • 64 Pcs.

IBS, Inc. SPECIALTY PRODUCTS FOR MAINTENANCE & REPAIR INDUSTRIALBOLLY.COM © © © 999-879-1999		Universal Studs Black Oil Finish High Carbon - Heat Treated		Assortment No. 119R	
A-9668 1/4-28X1/2 X 1/4-20X1/2 OL 1-1/4 STUD	A-9669 1/4-28X3/4 X 1/4-20X1/2 OL 1-1/2 STUD	A-9670 1/4-28X1 X 1/4-20X1/2 OL 2" STUD	A-9673 5/16-24X1/2 X 5/16-18X3/8 OL 1" STUD	A-9675 5/16-24X5/8 X 5/16-18X3/4 OL 1-1/2 STUD	A-9690 3/8-24X2 X 3/8-16X5/8 OL 3" STUD
A-9677 5/16-24X1 X 5/16-18X9/16 OL 2" STUD	A-9683 3/8-24X3/4 X 3/8-16X1/2 OL 1-1/2 STUD	A-9684 3/8-24X3/4 X 3/8-16X1/2 OL 1-3/4 STUD	A-9686 3/8-24X1 X 3/8-16X5/8 OL 2" STUD	A-9699 7/16-20X3/4 X 7/16-14X9/16 OL 1-3/4" STUD	
A-9701 7/16-20X7/8 X 7/16-14X3/4 OL 2" STUD	A-9712 7/16-20X1-3/8 X 7/16-14X3/4 OL 2-1/2 STUD	A-9715 7/16-20X1-13/16 X 7/16-14X3/4 OL 3 STUD		A-9727 1/2-20X3/4 X 1/2-13X3/4 OL 1-7/8 STUD	A-9745 5/8-18X1-1/4 X 5/8-11X1 OL 3" STUD
A-9731 1/2-20X1 X 1/2-13X3/4 OL 2-1/2 STUD	A-9732 1/2-20X2 X 1/2-13X3/4 OL 3" STUD	A-9739 9/16-18X1-1/4 X 9/16-12X1 OL		A-9744 5/8-18X1-1/2 X 5/8-11X13/16	























IBS, INCORPORATED

Automotive Miscellaneous Items X11

















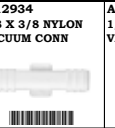





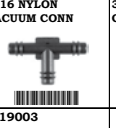

Nylon Tees & Connectors

	A-11419 3/16" 4-Way PKG QTY: 25		A-12916 1/8" x 3/16" x 1/8" Reducing Tee PKG QTY: 10		A-12918 3/16" Three-Way PKG QTY: 10
	A-12919 3/16" x 1/4" x 3/16" Reducing Tee PKG QTY: 10		A-12920 5/16" 3-Way PKG QTY: 10		A-12921 3/8" x 3/8" x 1/4" Reducing Tee PKG QTY: 10
	A-12923 1/8" 3-Way PKG QTY: 10		A-12925 3/8" 3-Way PKG QTY: 10		A-12926 3/16" x 3/16" x 1/8" Reducing Tee PKG QTY: 10
	A-12927 3/16" x 3/16" x 3/16" "Y" Connector PKG QTY: 10		A-12929 1/8" Straight PKG QTY: 10		A-12930 1/8" x 3/16" Straight Reducer PKG QTY: 10
	A-12931 1/4" Straight PKG QTY: 10		A-12934 3/8" Straight PKG QTY: 10		A-12935 3/16" x 1/4" Straight Reducer PKG QTY: 10
	A-12936 1/8" x 1/4" Straight Reducer PKG QTY: 10		A-12937 3/16" Straight PKG QTY: 10		A-12946 5/16" Straight PKG QTY: 10
	A-12949 3/16" 5-Way PKG QTY: 5		A-17629 1/4" 3-Way PKG QTY: 10		

Nylon Connectors & Vacuum Caps Assort (Z02)

IBS No. 301P • 24 Items • 310 Pcs

Packaged in a locking steel drawer for easy storage & organization

IBS, Inc.		Nylon Connectors and Vacuum Caps					
SPECIALTY PRODUCTS FOR MAINTENANCE & REPAIR INDUSTRIALBOLT.COM • 800-578-1906		Assortment No. 301P					
							
A-12929 1/8 STRT VACUUM CONNECTOR	A-12937 3/16 X 3/16 NYLON VACUUM CONN	A-12931 1/4 X 1/4 NYLON VACUUM CONN	A-12946 5/16 X 5/16 NYLON VACUUM CONN	A-12934 3/8 X 3/8 NYLON VACUUM CONN	A-12930 1/8X3/16 NYLON VACUUM CONN	A-12936 1/8 X 1/4 NYLON VACUUM CONN	A-12935 3/16 X 1/4 NYLON VACUUM CONN
							
A-12923 1/8 NYLON VACUUM CONN	A-12918 3/16 NYLON VACUUM CONN	A-17629 1/4 NYLON VACUUM TEE	A-12920 5/16 NYLON VACUUM CONN	A-12925 3/8 NYLON VACUUM CONN			A-12927 3/16 VACUUM \"Y\" CONNECTOR*
							
A-12209 1/8 HI-TEMP RUBBER VACUUM CONN	A-19000 3/16 HI-TEMP RUBBER VACUUM CONN	A-19001 1/4 HI-TEMP RUBBER VACUUM CONN	A-19003 3/8 HI-TEMP RUBBER VACUUM CONN				A-11419 3/16 4-WAY VACUUM CONN
							
A-12916 1/8X3/16X1/8 NYLON VACUUM CONN	A-12919 1/4X3/16X3/16 NYLON VACUUM CONN	A-12926 3/16X3/16X1/8 NYLON VACUUM CONN	A-12921 3/8X3/8X1/4 NYLON VACUUM TEE				A-12949 3/16 SWAY VACUUM CONNECTOR









AUTOMOTIVE



IBS, INCORPORATED

Automotive Pigtails X11

Automotive Pigtails - GM 56 Series

 <p>A-8774 (2084421, 2962447) Unplated Brass 16-14 Ga Insulates with shell 8777 Mates w/ term 8776 PKG QTY: 50</p>	 <p>A-8775 (2962984) Insulates 8776 and 15956 Mates w/ shell 8777 PKG QTY: 25</p>	 <p>A-8776 (2962987) Unplated Brass 16-14 Ga Insulated with shell 8775 Mates w/ term 8774 PKG QTY: 50</p>
 <p>A-8777 (2962448) Insulates 8774 and 15957 Mates w/shell 8775 PKG QTY: 25</p>	 <p>A-15956 (2971962) Tin Plated 16-14 Ga Insulated with shell 8775 Mates w/Term 15957 PKG QTY: 25</p>	 <p>A-15957 (2965142) Tin Plated 16-14 Ga Insulated with shell 8777 Mates w/Term 15956 PKG QTY: 25</p>

Automotive Miscellaneous Items (X09)

Mechanics Wire



IBS No.	Type	Lng / Wt	Gauge	Qty
D-110-100	Spool	1 lbs.	18	1
D-110-200	Spool	2 lbs.	18	1
D-110-300B	Spool	3 lbs.	14	1
D-110-325B	Spool	3 lbs.	16	1
D-110-500	Spool	5 lbs.	18	1

Hi-Temp Rubber Vacuum Caps

Can be used for capping lines and hoses while testing carburetors, emission control systems, vacuum lines, etc.

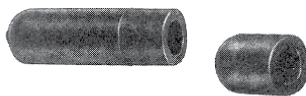

IBS No.	Fits Tube O.D.	Inside Length	Pkg. Qty.
A-4439	1/4	9/16	25
A-4440	3/16	9/16	25
A-12209	1/8	9/16	25
A-19000	3/16	1-1/4	25
A-19001	1/4	1-1/4	25
A-19003	3/8	1-1/2	25

AUTOMOTIVE

IBS, INCORPORATED

Automotive Tire Repair X13



COI RADIAL APPLICATION CHART

SIDEWALL INJURY		TREAD INJURY	PASSENGER		LIGHT TRUCK	HEAVY TRUCK		EARTHMOVER
Maximum Width	Maximum Length	Maximum Diameter			6.50 - 12.50	7.50 - 10.00	11.00 - 14.00	14.00 - 40.00
			125 - 195	205 - 255	7 - 10 215/85 - 255/85 215/75 - 265/75	8 - 11 235/80 - 275/80 245/75 - 295/75	12 - 16.5 295/80 - 315/80 315/75 - 425/65	15.5 - 50.5 20/65 - 65/65
1/8" (3mm)	1/8" (3mm)	1/8" (3mm)	10	10	10	10	10	44
			10	10	10	10	10	42
1/4" (6mm)	1/4" (6mm)	1/4" (6mm)	10	10	12	12	12	44
			10	10	20	42	40	42
			12	12	22	24	24	42
1 cable	1 1/2" (40mm)	3/8" (10mm)			20	20	20	
	3 1/8" (80mm)				22	22	22	
	4 3/4" (120mm)					24	24	
	6" (150mm)					26	26	
2 cables	3/4" (19mm)	1/2" (12mm)			20	20	22	
	1 1/2" (40mm)				22	22	24	
	2 3/8" (60mm)				22	24	26	
	5 1/8" (130mm)				26	28		
3/8" (10mm)	3/8" (10mm)	1/2" (12mm)	10	10	20	20	20	44
	1 1/2" (40mm)		10	10	20	20	20	42
	2" (50mm)		12	12	22	26	40	
	2 3/8" (60mm)		14	14	42	42	44	
	3 1/8" (80mm)							
	5 1/8" (130mm)							
1/2" (12mm)	1 1/2" (40mm)	3/4" (19mm)	12	12	22	25	25	
	2" (50mm)		12	12	22	40	40	
	2 3/4" (70mm)		14	14	40	42	44	
	3 3/4" (95mm)				40	44	44	
	5 1/8" (130mm)					44	44	
3/4" (19mm)	3/4" (20mm)	1" (25mm)	12	12	22	25	35	44
	1" (25mm)		12	12	22	40	40	
	1 1/2" (40mm)		14	14	24	42	42	
	2" (50mm)					42	44	
	2 1/2" (65mm)					44	44	
	4 3/8" (110mm)							
5 1/8" (130mm)								
1" (25mm)	1 1/2" (40mm)	1 1/4" (30mm)	14	14	25	35	35	44
	2" (50mm)		14	14	40	42	44	
	3 1/8" (80mm)					44	44	
	4" (100mm)					44	44	
1 1/4" (30mm)	2" (50mm)	1 1/2" (40mm)				35	35	42
	3 1/8" (80mm)					42	44	
	4" (100mm)					44	44	
1 1/2" (40mm)	2" (50mm)	1 1/2" (40mm)				45	45	44
	3 1/8" (80mm)					44	44	
SHOULDER INJURY		1/4" (6mm)	10	10	12	20	20	42
		3/8" (10mm)	12	12	20	22	40	44
		1/2" (12mm)						
		3/4" (19mm)		14	22	40	42	
		1" (25mm)			40	42	42	
		1 1/2" (40mm)				44	44	

AUTOMOTIVE



IBS, INCORPORATED

Automotive Tire Repair X13

AUTOMOTIVE

USA Style Universal Repair Units

For Radial or Bias Ply Tires

- The most popular universal repair.
- Designed for chemical vulcanization.
- Black vulcanizing gum, blue poly backing.



IBS No.	Description	Size (inches)	Size (mm)	Qty
10907	Small Round	1-3/4	41	30
10908	Medium Round	2-1/4	57	25
10909	Large Round	3-1/4	82	15

USA Style COI Radial Repair Units

- Each reinforcing ply is individually end-wrapped to deflect tire flexing stresses in a unique manner.
- Tie-gun construction eliminates the potential for delamination common in competitive products.
- Designed to vulcanize chemically or in low temperature systems.
- Gray vulcanizing gum, blue poly backing.



IBS No.	Description	Size (inches)	Size (mm)	Qty
10914	Radial 12, 1 Ply	2-1/4 x 4	57x100	10
10915	Radial 14, 1 Ply	3-3/4 x 4	95x100	10
10916	Radial 20, 2 Ply	2-7/8 x 5	72x124	10

See COI Radial Application Chart on following page.

CP Cross Ply Bias Repair Units

Bias ply repair units are designed for use in nail hole, reinforcing or section repairs and be applied in any repairable area of a tube or tubeless bias ply tire.



IBS No.	Description	Size (inches)	Size (mm)	Qty
10910	CP3, 2 Ply	4-3/8	112	10
10911	CP4, 4 Ply	5-1/2	140	10
10912	CP5, 4 Ply	6-3/4	172	10

Universal String Type Inserts

Universal String-Type Inserts are an excellent emergency repair when a full service repair utility is unavailable. Made of butyl rubber, these inserts are very strong, allowing easy insertion through steel belted radials. Perfect for repairing lawn tractor, golf cart and other off-road tires.



IBS No.	Description	Size (inches)	Size (mm)	Qty
10918	Fat, Brown String	4	102	50
10920	Fat, Brown String	8	204	25

Universal String Type Kits



IBS No.	Description	Qty
10919	Tire Repair Kit with 4" Strings and HD Metal Tools	1
10917	Tire Repair Kit with 8" Strings and HD Metal Tools	1

Universal Quilled Combination Units

- For use in radial and bias ply tires.
- Designed for chemical vulcanization.
- Black vulcanizing gum, white backing.
- Equipped with metal quill for easy installation.



IBS No.	Patch Size	Stem Dia. Inch (mm)	Qty
10921	1-5/8 (42mm) Round	5/32 (4mm)	20
10922	1-7/8 (47mm) Round	7/32 (5.5mm)	20

IBS, INCORPORATED

Automotive Tire Repair X13



Lead-Wire

Combination Units - Dipped

- For use in radial and bias ply tires.
- Designed for chemical vulcanization.
- Patch portion has gray vulcanizing gum, blue backing.
- Stem portion is dip coated with premium vulcanizing gum.
- No special insert tools required. Use carbide cutter to prepare injury channel. Install from the inside.



IBS No.	Patch Size	Stem Dia. Inch (mm)	Qty
10925	1-5/8 (42mm) Round	3/16 (5mm)	24
10926	2-1/8 (55mm) Round	1/4 (7.5mm)	24

Chemical Vulcanizing Cement

For chemical or heat vulcanization. The flammable vulcanizing cement is the most popular fast dry cement. For use with any repair unit or insert. When used on large reinforced patches, coat patch and inner liner with cement.



IBS No.	Description	Qty
10927	8 oz. Vulcanizing Cement Flammable	1

Buffing Solution

For removing dirt, debris and mold lubricants from the repair area prior to buffing.



IBS No.	Description	Qty
10928	32 oz. Rubber Prep Buffing Solution Flammable	1

Bead Sealer

Heavy Duty Flammable

For sealing small air leaks between the tire bead between the tire and the wheel.



IBS No.	Description	Qty
10929	32 oz. Bead Sealer Heavy Duty, Flammable	1

Euro-Paste

Mounting Compound

- Makes tire mounting/de-mounting easier.
- Protects tire beads from damage.
- Helps beads to seat properly.
- Non-Toxic, environmentally friendly.



IBS No.	Description	Qty
10951	6-1/2 Lb (3 kg) X-tra Seal Euro Paste, White	1
10952	Large Applicator Brush, 2" Dia.	1

Tire Repair Tools Required for Quality Repairs



SPLIT EYE NEEDLES

IBS No.	Description	Qty
10932	Pistol Grip Split-Eye Insert Needle	1
10933	Die-Cast T-Handle Split Eye Needle	1



PROBES

IBS No.	Description	Qty
10930	Pistol Grip Spiral Cement Probe	1
10931	Pistol Grip 2 Stage Knurled Probe	1



SKIVING KNIVES

IBS No.	Description	Qty
10935	Flexible Skiving Knife	1

AUTOMOTIVE



IBS, INCORPORATED

Automotive Tire Repair X13

AUTOMOTIVE



BALL BEARING STITCHER

IBS No.	Description	Qty
10937	3/16 x 1-1/2 Wood Handle Ball Bearing Stitcher	1



10940



10946



10947

BUFFING WHEELS

IBS No.	Description	Qty
10940	2-1/2" Light Duty Carbide Buffing Wheel, BC-1 (Use with 69027 Arbor Adapter)	1
10946	2" Dome Economy Buffing Wheel, 60G (Use with 10938 Arbor Adapter)	1
10947	2" Dome Carbide Buffing Wheel, SSG170 (Use with 10938 Arbor Adapter)	1

Maximum operating speed = 5,000 RPM



10938



69027

ARBOR ADAPTERS

IBS No.	Description	Qty
10938	Arbor Adapter, threads 3/8-24 x 1-1/2 long	1
69027	Arbor Adapter, 3/8 Arbor, 1/4 Shank	1

Passenger & Light Truck Valves

Meets or Exceeds All Industry Quality Standards



TUBELESS SNAP-IN VALVES

IBS No.	TR No.	Material	Height	Valve Hole	Qty
10963	413	EPDM Rubber	1.25"	.453"	10
10964	414	EPDM Rubber	1.50"	.453"	10
10965	415	EPDM Rubber	1.25"	.625"	10
10968	418	EPDM Rubber	2.00"	.425"	10

Application: 65 psi maximum cold inflation pressure and maximum rim thickness of 0.156".
NOTE: H, V, W, and Z speed rated tires require a metal bolt-in style valve.

HIGH PRESSURE SNAP-IN VALVES



IBS No.	TR No.	Material	Height	Valve Hole	Qty
10994	600HP	Brass/Rubber	1.27"	.453"	10
10995	602HP	Brass/Rubber	2.00"	.453"	10
10991	801HP	Brass/Rubber	1.31"	.625"	5
10992	802HP	Brass/Rubber	2.00"	.625"	5

Application:
600HP/602HP = 80 psi maximum cold inflation pressure and maximum rim thickness of 0.205"
801HP/802HP = 100 psi maximum cold inflation pressure and maximum rim thickness of 0.205"
NOTE: H, V, W, and Z speed rated tires require a metal bolt-in style valve

Heavy Truck Valves

Meets or Exceeds All Industry Quality Standards



BRASS VALVES, METRIC

IBS No.	TR No.	Material	H	L	Angle	Valve Hole	Qty
10993	V3-20-4	Brass	1.00"	2.38"	27°	.625"	1

Valve Accessories & Tools

VALVE CAPS & CORES (TPMS Compatible)



IBS No.	Description	Qty
10973	VC-8 Black Plastic Cap	100



VALVE CAPS & CORES

Warning: DO NOT USE with TPMS Valve Stems*

IBS No.	Description	Qty
10970	C-1 Short Valve Core	10
10971	C-1 Short Valve Core, High Temp	10
10972	VC-3 Long Metal Dome Cap with Seal	10
10974	Chrome Hex Cap with Seal	10
10982	Double Seal Valve Cap	5

* If a brass valve cap is installed on an aluminum valve, corrosion will occur and the cap may not be able to be removed without breaking the valve.



METAL EXTENSIONS, PASSENGER

IBS No.	Description	Qty
10975	3/4" Metal Valve Extension	10
10976	1-1/4 Metal Valve Extension	10



VALVE CORE REMOVER TOOLS

IBS No.	Description	Qty
10957	TPMS Valve Core Torque Tool, 4 in-lbs.	1
10958	Core Tool	1



4-WAY VALVE TOOL

IBS No.	Description	Qty
10986	4-Way Valve Tool	1



VALVE INSTALLATION TOOLS

IBS No.	Description	Qty
10987	Valve Installation Tool, Screw-On Type	1
10988	No-Mar Installation Tool Screw-On Type	1
10990	Pull-A-Stem Valve Installation Tool	1



AIR CHUCKS

IBS No.	Description	Qty
10977	Ball Foot Air Chuck, Closed	1
10979	Ball Foot Chuck with Clip	1
10978	Dual Foot Chuck Angled	1

AUTOMOTIVE



IBS, INCORPORATED

Wheel Weights X14

OEM Zinc Wheel Balance Weights

Zinc wheel balance weights are used by more OEMs worldwide than any other material available.

With over 2 billion parts used in the past 5 years, zinc remains the material of choice on a global scale for most OE manufacturers. The reason is because zinc is one of the most common and most recycled elements on earth, making it a perfect manufacturing material.

IBS provides you with the highest quality zinc wheel weights available

Order all Wheel Weights in Packages of 25

Coated Protection

Perfect Equipment zinc wheel weights are premium coated, giving them the corrosion protection you need and better matching today's rim styles.

No Rust

Zinc is a non-ferrous metal and is a natural anti-corrosive element. Zinc wheel weights will never rust, unlike other non-lead options.



Less Scratches

Zinc is a very strong, but soft metal. With proper installation, zinc wheel weights are less likely to scratch the rim during installation.



Custom Fit

Zinc wheel weights are a cast part which features the same contoured shape as traditional lead weights. This allows for an easier transition and a seamless look on the wheel.

AUTOMOTIVE

P-Series — Uncoated

The P-Series zinc clip-on wheel weight is used primarily on standard passenger car 13" - 17" steel wheels. Also available in an uncoated finish.

Fits: Steel wheels with a standard-width rim flange thickness.
Available Sizes: 0.25 oz. - 3 oz.



- Premium Zinc
- For Steel Wheels
- Ounces & Grams
- Uncoated
- OEM Approved
- Non-Lead

IBS No.	Wt (oz)	IBS No.	Wt (oz)	IBS No.	Wt (oz)
20301	1/4	20305	1-1/4	20309	2-1/4
20302	1/2	20306	1-1/2	20310	2-1/2
20303	3/4	20307	1-3/4	20311	2-3/4
20304	1	20308	2	20312	3

AW-Series — Coated

The AW-Series zinc clip-on wheel weight is used primarily on most domestic vehicles equipped with alloy rims that were manufactured prior to 1995.

Fits: Many brands like Acura, Buick, Chevrolet, Chrysler, Dodge, Infinity, Isuzu, Lexus, Oldsmobile & Pontiac.
Available Sizes: 0.25 oz. - 3 oz.



- Premium Zinc
- For Alloy Wheels
- Ounces & Grams
- Coated
- OEM Approved
- Non-Lead

IBS No.	Wt (oz)	IBS No.	Wt (oz)	IBS No.	Wt (oz)
20349	1/4*	20353	1-1/4	20357	2-1/4
20350	1/2	20354	1-1/2	20358	2-1/2
20351	3/4	20355	1-3/4	20359	2-3/4
20352	1	20356	2	20360	3

* Available in Steel only

MC-Series — Coated

The MC-Series zinc clip-on wheel weight is used primarily on most domestic vehicles equipped with alloy rims. The MC Series is the most sold & installed zinc series wheel weight for alloy rims.

Fits: Some brands like Buick, Chevrolet, Chrysler, Dodge, Ford, Mazda, Oldsmobile, Pontiac & Saturn.
Available Sizes: 0.25 oz. - 3 oz.



- Premium Zinc
- For Steel Wheels
- Ounces & Grams
- Coated
- OEM Approved
- Non-Lead

IBS No.	Wt (oz)	IBS No.	Wt (oz)	IBS No.	Wt (oz)
20337	1/4*	20341	1-1/4	20345	2-1/4
20338	1/2	20342	1-1/2	20346	2-1/2
20339	3/4	20343	1-3/4	20347	2-3/4
20340	1	20344	2	20348	3

* Available in Steel only

IBS, INCORPORATED

Wheel Weights X14



OEM Zinc Wheel Balance Weights

LH-Series - Coated

The LH-Series zinc clip-on wheel weight is used primarily on late model Chrysler cars and is designed to fit their unique rim flange.

Fits: Some brands like Chrysler, Dodge & Ford

Available Sizes: 0.25 oz. - 3 oz.



- Premium Zinc
- Coated
- For Alloy Wheels
- OEM Approved
- Ounces & Grams
- Non-Lead

IBS No.	Wt (oz)	IBS No.	Wt (oz)	IBS No.	Wt (oz)
20361	1/4*	20365	1-1/4	20369	2-1/4
20362	1/2	20366	1-1/2	20370	2-1/2
20363	3/4	20367	1-3/4	20371	2-3/4
20364	1	20368	2	20372	3

* Available in Steel only

IAW-Series —Coated

The IAW-Series zinc clip-on wheel weight is used primarily European and Asian vehicles with alloy wheels.

Fits: Many brands like Audi, BMW, Cadillac, Volkswagen & Volvo.

Available Sizes: 10g - 60g



- Premium Zinc
- Coated
- For Alloy Wheels
- OEM Approved
- Grams Only
- Non-Lead

IBS No.	Wt (g)	IBS No.	Wt (g)	IBS No.	Wt (g)
20373	10	20377	30	20381	50
20374	15	20378	35	20382	55
20375	20	20379	40	20383	60
20376	25	20380	45		

EN-Series — Coated

The EN-Series zinc clip-on wheel weight is used primarily on Audi, Mercedes Benz, and early model Japanese vehicles equipped with alloy wheels.

Fits: Many brands like Acura, Audi, Ford, Honda, Mercedes Benz & Volkswagen.

Available Sizes: 10g - 60g



- Premium Zinc
- Coated
- For Alloy Wheels
- OEM Approved
- Grams Only
- Non-Lead

IBS No.	Wt (g)	IBS No.	Wt (g)	IBS No.	Wt (g)
20395	10	20399	30	20403	50
20396	15	20400	35	20404	55
20397	20	20401	40	20405	60
20398	25	20402	45		

FN-Series — Coated

The FN-Series zinc clip-on wheel weight is used primarily on most Japanese vehicles equipped with alloy wheels.

Fits: Many brands like Acura, Honda, Infiniti, Lexus, Nissan & Toyota.

Available Sizes: 10g - 60g



- Premium Zinc
- Coated
- For Alloy Wheels
- OEM Approved
- Grams Only
- Non-Lead

IBS No.	Wt (g)	IBS No.	Wt (g)	IBS No.	Wt (g)
20384	10	20388	30	20392	50
20385	15	20389	35	20393	55
20386	20	20390	40	20394	60
20387	25	20391	45		

T-Series — Coated

The T-Series zinc clip-on wheel weight is used primarily on most domestic light trucks equipped with decorative and larger-thickness steel wheels and most late-model light-trucks equipped with alloy wheels.

Fits: Steel wheels with a thicker than standard rim flange and light trucks with alloy rims.

Available Sizes: 0.25 oz. - 3 oz.



- Premium Zinc
- Coated
- For Steel Wheels
- OEM Approved
- Ounces & Grams
- Non-Lead

IBS No.	Wt (oz)	IBS No.	Wt (oz)	IBS No.	Wt (oz)
20325	1/4*	20329	1-1/4	20333	2-1/4
20326	1/2	20330	1-1/2	20334	2-1/2
20327	3/4	20331	1-3/4	20335	2-3/4
20328	1	20332	2	20336	3

AUTOMOTIVE



IBS, INCORPORATED

Assortments (Z06)

Wheel Weight Assortment

Arranged in a 40 hole metal bin
IBS No. 857P • 40 Items • 181 Pcs.

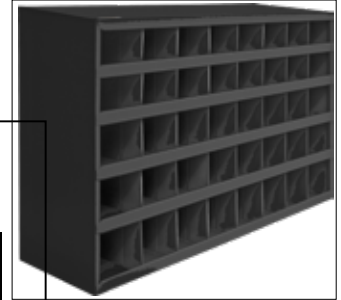

AUTOMOTIVE



Wheel Weights

Assortment No. 857P

20301 1/4OZ P PASS WEIGHT ZINC UNCOATED	20302 1/2OZ P PASS WEIGHT ZINC UNCOATED	20303 3/4OZ P PASS WEIGHT ZINC UNCOATED	20304 1OZ P PASS WEIGHT ZINC UNCOATED	20305 1-1/4OZ P PASS WEIGHT ZINC UNCOATED	20306 1-1/2OZ P PASS WEIGHT ZINC UNCOATED	20307 1-3/4OZ P PASS WEIGHT ZINC UNCOATED	20308 2OZ P PASS WEIGHT ZINC UNCOATED
20350 AW Type Zinc Weight- Coated 1/2 OZ	20351 AW Type Zinc Weight- Coated 3/4 OZ	20352 AW Type Zinc Weight- Coated 1 OZ	20353 AW Type Zinc Weight- Coated 1-1/4 OZ	20354 AW Type Zinc Weight- Coated 1-1/2 OZ	20355 AW Type Zinc Weight- Coated 1-3/4 OZ	20356 AW Type Zinc Weight- Coated 2 OZ	20358 AW Type Zinc Weight- Coated 2-1/2 OZ
20338 MC Type Zinc Weight- Coated 1/2 OZ	20339 MC Type Zinc Weight- Coated 3/4 OZ	20340 MC Type Zinc Weight- Coated 1 OZ	20341 MC Type Zinc Weight- Coated 1-1/4 OZ	20342 MC Type Zinc Weight- Coated 1-1/2 OZ	20343 MC Type Zinc Weight- Coated 1-3/4 OZ	20344 MC Type Zinc Weight- Coated 2 OZ	20346 MC Type Zinc Weight- Coated 2-1/2 OZ
20326 T Truck Zinc Weight- Coated 1/2 OZ	20327 T Truck Zinc Weight- Coated 3/4 OZ	20328 T Truck Zinc Weight- Coated 1 OZ	20329 T Truck Zinc Weight- Coated 1-1/4 OZ	20330 T Truck Zinc Weight- Coated 1-1/2 OZ	20331 T Truck Zinc Weight- Coated 1-3/4 OZ	20332 T Truck Zinc Weight- Coated 2 OZ	20334 T Truck Zinc Weight- Coated 2-1/2 OZ
20373 IAW Type Zinc Weight- Coated 10 GRAMS	20374 IAW Type Zinc Weight- Coated 15 GRAMS	20375 IAW Type Zinc Weight- Coated 20 GRAMS	20376 IAW Type Zinc Weight- Coated 25 GRAMS	20377 IAW Type Zinc Weight- Coated 30 GRAMS	20378 IAW Type Zinc Weight- Coated 35 GRAMS	20379 IAW Type Zinc Weight- Coated 40 GRAMS	20380 IAW Type Zinc Weight- Coated 45 GRAMS

IBS, INCORPORATED

Wheel Weights X14



OEM Steel Adhesive Wheel Balance Weights

Steel adhesive-backed wheel balance weights are used by more OEMs in North America than any other steel adhesive.

These wheel weights are the highest quality adhesive backed steel weights available. Featuring a patented shape and patented QuikTab® these adhesive wheel weights are easier fit and apply to the contour of the wheel during installation.

Order all Wheel Weights in Full Pack Qty

Standard height profile adhesive weights for use on most wheels. Low profile height for use where there is not enough brake caliper clearance for standard height profile adhesive weights.



IBS No.	Description	Qty
20410	Steel Weight, 1/4 oz segments, 3 oz strip — 25 strips per box, 300 segments, 0.225" height Standard profile: 0.75" x 0.37"	25



IBS No.	Description	Qty
20406	Steel Weight, 1/4 oz segments, 3 oz strip — 48 strips per box, 576 segments, grey coating Low profile: 0.1875" x 0.75"	48



IBS No.	Description	Qty
20407	Steel Weight, 1/4 oz segments, 3 oz strip — 52 strips per box, 624 segments Low profile: 0.1875" x 1"	52
20408	20lb Roll, 1280 segments	1

Save time and money — with an adhesive roll use only the amount you need with each application. Simply pull and rip — No cutting, no measuring.



IBS No.	Description	Qty
20411	Steel Weight Roll Stand	1

Unmatched Quality

Our steel wheel weights are OEM preferred in North America.

We Provide Options

Our steel adhesives are available in a variety of sizes and styles.



Patented QuikTab®

Nearly all of Perfect Equipment's adhesive wheel weights feature the patented QuikTab®, invented to increase efficiency, the protective tape backing is slightly wider than the weight, making the removal process easier. Just grab the edge and pull, it's that simple.

Patented Shape

Perfect Equipment steel adhesive wheel weights feature a patented isosceles trapezoid single segment design, allowing the technician to more easily contour the weight to the wheel when installing.

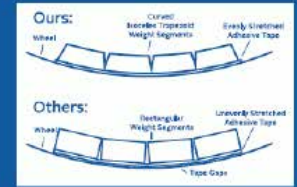

Coated Protection

Our OEM steel wheel weights come standard with a 10-year anti-corrosion protection coating to prevent unwanted and unsightly brown rust.



IBS No.	Description	Qty
20409	Steel Weight, Truck 1/2 oz segments, 6 oz strip — 30 strips per box, 360 segments Standard profile: 0.3125" x 1"	30

Wheel Weight Adhesive Scraper (T03)



For removal of adhesive wheel weights.

IBS No.	Description	Qty
20506	Adhesive Scraper	1



Wheel Weight Pliers

European designed installation and removal tool with clip claw.



IBS No.	Description	Qty
20500	Wheel Weight Pliers with Clip Claw	1

Unique replaceable "soft-head" design. Will not damage the wheel or the special coating on the wheel weight.



IBS No.	Description	Qty
20501	Wheel Weight Pliers with Soft Head	1

Wheel Weight Hammers

Used for the installation of coated clip-on weights. Soft head acetate face and clip claw horn quickly removes old weights.



IBS No.	Description	Qty
20502	Alloy Hammer & Clip Claw Horn	1

Specifically designed to install TAL clip-on wheel weights.



IBS No.	Description	Qty
20503	Alloy Hammer w/double side soft face	1

Rim Gauges

Rim gauges should be used when proper applications cannot be found in the application guide.



20504

20505

IBS No.	Description	Qty
20504	Rim Gauge for Trucks	1
20505	Rim Gauge for Cars	1



Screw & Bolt Anchors

A

Anchors

- Anchor Applications Guide Y-5
- Anchor Types & Designs Y-6, Y-7
- General Information Y-2

Assortments

- Rapidrive Anchor Screws Assortment Y-12
- Top 10 Concrete Screws with Drills & Installation Y-14

B

Bolt Anchors

- Single Unit Calking
- Open End Y-9

H

Hollow Wall Anchors

- Auger Anchors Y-15
- E-Z Anchors Y-13
- Heavy Duty Toggle Anchors Y-16
- Poly-Toggle® Screw Anchors Y-18
- Rapidrive Anchor Screws Y-10
- Toggle Bolts Y-19
- Toggle Wings Y-19

M

Masonry Fastening Systems

- SDS Drill Bits Y-24

Q

One Step Anchors

- Nylon Nail-In Anchors Y-20
- Zamac Nail-In Anchors Y-20

S

Screw Anchors

- Bantum Plugs Y-8
- Poly-Toggle® Screw Anchors Y-18
- Rapidrive Anchor Screws Y-10
- Super Plastic Anchors Y-8



IBS, INCORPORATED

Anchors Y04

General Information

The information on the following pages is designed to be used as a reference in selecting anchors and fasteners. It is intended to provide the user with practical information for the most common applications. It is not possible to include information on all applications and data for all construction materials. It is the responsibility of the user to verify the accuracy of the text and the data contained in this handbook as it pertains to each unique application.

Selection and Specification of Anchors

Until the beginning of this century, an anchor was a piece of wood or a plug of lead carved to size and wedged into a hole, into which a nail or screw was driven. These early anchors were then followed by lead and fiber anchors with hollow cores which were mass produced in a variety of sizes to match hole sizes and screw sizes.

A multitude of anchor types have been developed in subsequent years leading to today's proliferation of choices. But while this variety of choices does provide a better match up of anchors to specific needs, it also makes the selection process that much more difficult.

For that reason, before selecting the type, size and number of anchors to be used for any given application, all of the following factors should be taken into consideration.

Base Material

The strength of the masonry material is a key factor in selecting an anchor. Maximum anchor performance requires that the material in which the anchor is installed can also sustain the load to which the anchor will be subjected. Anchors installed in stone and dense concrete can withstand far greater "pullout loads" than the same anchor installed in lightweight concrete, block or brick. Medium-heavy to heavy loads cannot be safely installed in soft materials such as stucco, grout, plaster or plasterboard. Materials should be fully cured prior to anchor installation.

The length, width, and thickness of the base material should be considered. Normally, the width should be at least twice the recommended edge distance. The depth of anchor embedment should not exceed 80% of the base material thickness.

Material Composition of Anchors

IBS offers a selection of anchors to meet the requirements of most applications. When reviewing the basic considerations for selection of an anchor, the material from which the anchor is manufactured should be considered. The IBS anchor selection guide lists the basic material from which each anchor is manufactured.

Anchors selected should be manufactured from a material which is suitable for their intended use. For example, anchors manufactured from a material with a melting point of less than 1000° F are not normally recommended for overhead applications. Examples of these materials would include zinc (Zamac), lead, plastic and adhesives. A steel anchor usually meets the requirements of most fire codes. IBS offers several Factory Mutual Approved anchors for use in fire resistant construction.

Consideration should also be given to the strength of the anchor material in relation to the applied loads, including bending. The bolts used in conjunction with an anchor should be capable of sustaining the applied loads.

Information on this and the following pages obtained from Rawl Catalog #0013 ©1989 The Rawlplug Company, Inc.

A
N
C
H
O
R
S



Loading Conditions

The holding power required should be calculated to include not only the load factor, but also the way the load is transmitted to the anchor.

The conditions of use should be reviewed. Will the installed anchors be used to support a static load, or will they be subjected to vibration and/or shock loads?

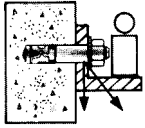

STATIC or Dead Load ... constant and unchanging.

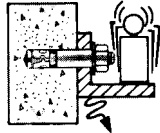

DYNAMIC or Vibration Load ... intermittent and of varying intensity.

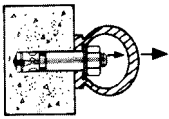

TENSION Load ... direct axial load applied to installed anchor.

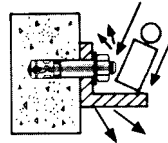

IMPACT or Shock Load ... periodic load of substantial intensity.

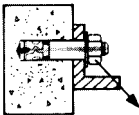

COMBINED Load ... a load applied to the anchor at any angle between 0 and 90°.

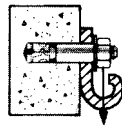

SHEAR Load ... a load applied at a right angle to the installed anchor.

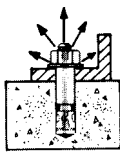

FLOOR ... may be tension, shear or combined load.

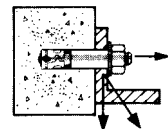

WALL ... usually either combined or shear load.

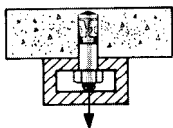

CEILING ... usually direct axial (tension) load.

Anchor Functioning

Anchor functioning is based on one of the following categories: friction, compression, clamping, undercutting, and adhesion. In some cases a combination of functions is used. Friction fasteners develop their load capacity by creating a friction force between the fastener and the base material. Fasteners of this type may be driven into the base material without predrilling and are suitable for light duty static loads. Clamping describes the category of anchors which is used to fasten to hollow base materials. Tension loads are sustained by spreading the load over a large bearing surface in the hollow walls while shear is resisted by the friction developed between the fixture and the base material. Most anchors function by developing a compression force against the wall of the drilled hole which resists the applied loads. This compression force is generated by a sleeve, ring, or wedge assembly which is actuated by a tapered cone, tapered plug, a nail or a screw depending upon the type. Undercut anchors expand into the base material at the bottom of the drilled hole. As they undercut the base material, a large load bearing surface is formed which can transfer greater loads to the base material. Adhesion involves bonding the anchor rod to the base material. This type of anchor can generally sustain the highest loads.

EXPANSION against the wall of the drilled hole.

UNDERCUTTING the masonry material at the base of the drilled hole.

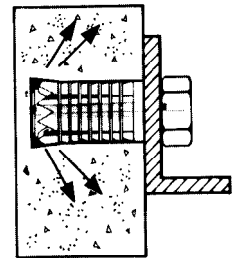
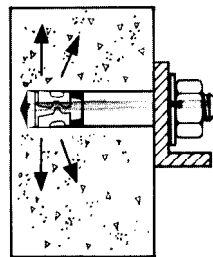

FRICITION between the fastener and the masonry material.

CLAMPING the item to be fastened to the masonry material.

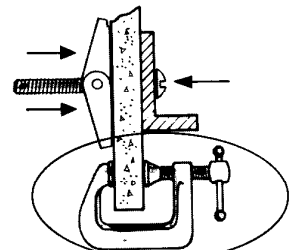
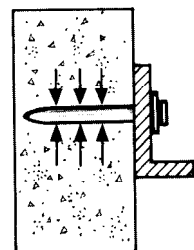



IBS, INCORPORATED

Anchors Y04

Safety Factors

Because of varying conditions of field installations a 4:1 safety factor (25% of the ultimate value) is the minimum accepted industry standard for static loads. Critical applications (vibratory loads, overhead installations, etc.) may require a safety factor of as much as 10:1, or more.

Anchor Installation Torque

Recommended installation procedures are detailed on the product catalog pages which follow. The effect of fixture coatings, lubrication of the anchor components due to the use of sealants, etc., strength of the base material, and other factors which affect the torque/tension relationship should be considered. The installation torque value used should be adjusted to suit the particular application.

As an anchor is expanded by applying a specified torque, a tension force is induced in the anchor. This tensioning force will govern the load vs. deflection characteristics of the anchor. As load is applied, the induced tension force is relieved. When vibratory loads are applied to an anchor, it is standard practice to induce a tension force in the anchor which is equal to 1.5 to 2.0 times the working load.

Load Capacity Tests

To assist in the selection and specification of anchors, load test data is provided for those products most frequently used in structural fastening and other critical applications. Such data are derived from tests performed in accordance with ANSI/ASTM standard E488. Illustrated above is a typical test setup for direct axial loading of an embedded anchor as governed by the ASTM standard. Detailed information is found in the product descriptions.

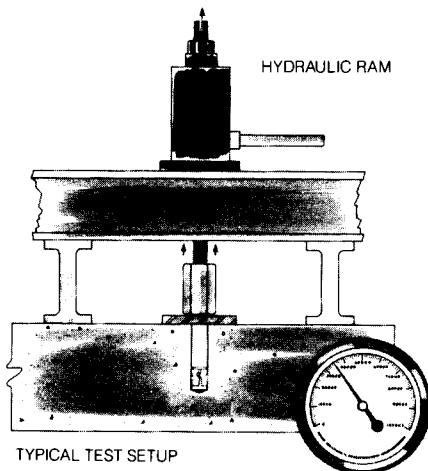

TYPICAL TEST SETUP

Spacing Recommendations

The load on an anchor is transmitted to the base material in which it is installed. Loading of anchors in closely spaced clusters of two or more can result in interaction of forces on the base material and lead to a reduction in anchor performance. The expansion anchor industry has established a minimum standard of 10 anchor diameters for spacing and 5 anchor diameters for edge distance to provide 100% anchor efficiency. Spacing may be reduced to 5 diameters with a 50% proportionate reduction in load.

The installation conditions are often determined by the manufacturer of the fixture or equipment to be fastened. The equipment or fixture often contains a specific number of mounting holes of a given screw or bolt size at a fixed spacing.

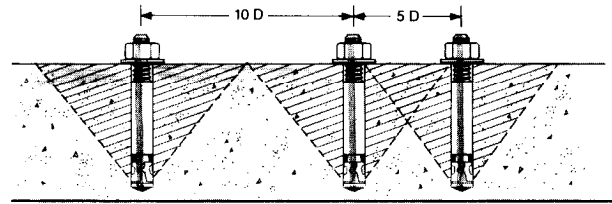

Installation Costs

A factor far less tangible than those previously discussed is the total installation cost. This includes the cost of the anchor, the drills, the drilling equipment, and the labor involved. Some anchors take longer to install than others; some require greater skill; some require deeper holes to obtain the same load capacity; some require layout or hole spotting while others do not. Ultimately, the selection and specification of an anchor requires a review of the application requirements such as the loading, base material, installation conditions, and other factors to assure maximum performance of the products. When properly selected, Industrial Bolt anchors can provide the best, most cost effective solution for most applications.

Corrosion Guide















The corrosive environment in which an anchor will be installed should be evaluated. The basic forms of corrosion can be described as chemical, electrochemical and galvanic. In addition, the pH factor of the environment should also be considered. To assure adequate protection, a detailed knowledge of corrosion is required to analyze the specific application.

ANCHORS

IBS, INCORPORATED

Anchor Applications Guide



ANCHOR TYPE	BASE MATERIAL						WORKING LOAD					ANCHOR MATERIAL		
	CONCRETE	STONE	STONE	BLOCK	WALLBOARD	PLYWOOD	< 25 LBS	< 50 LBS	< 400 LBS	< 400 TO 4000 LBS	4000+ LBS	STEEL	LEAD	PLASTIC
PLASTIC							LIGHT DUTY	MEDIUM	MEDIUM HEAVY	HEAVY				
 BANTAM PLUG	X	X	X	X	X			X						X
 SUPER PLASTIC	X	X	X	X	X	X		X	X					X
 NYLON NAIL-IN	X			X				X				X		X
TOGGLE														
 HOLLOW WALL ANCHOR					X	X		X	X			X		
 HEAVY DUTY TOGGLE			X	X	X	X		X	X			X		
 TOGGLE BOLTS				X	X	X		X	X			X		
 POLY TOGGLE				X	X	X		X						X
ONE-STEP														
 EZ ANCHORS, MUNGO JET PLUGS					X			X	X			X		X
 EZ TOGGLE					X			X				X		
 RAPIDRIVE ANCHOR SCREWS	X	X	X	X	X	X		X	X			X		
DRILL & DRIVE														
 ZAMAC NAIL-IN ANCHOR	X	X	X	X					X			X		
 MASONRY SCREWS	X							X	X			X		
SHIELD TYPE														
 LAG SHIELD	X							X	X			X		
 BOLT / CAULKING ANCHOR	X		X	X				X	X			X		
DROP & DRIVE														
 STUD / BOLT ANCHOR	X								X			X		

ANCHORS



IBS, INCORPORATED

Anchor Types & Designs

A
N
C
H
O
R
S

Plastic Anchors



Bantam Plug

This is a plastic anchor for **light duty fastening** applications in concrete, block, brick and wallboard. Use with sheet metal or wood screws and has a flange allowing it to be used with hollow base materials keeping it from sliding through the material. The anchor has three fins to prevent the anchor from turning during installation. **This anchor should not be used for overhead applications!**



Super Plastic Anchor

Designed **for use in both hollow and solid materials:** concrete, block, brick, stone and drywall. Use with sheet metal or lag screws. Has notched wings to prevent rotation in hole during and after installation. The unique design provides more gripping power than ordinary plastic anchors.



Nylon Nail-In Anchor

Used in concrete, block, brick, stone and wallboard. The body of the anchor is the same as that for the hole, which eliminates hole spotting. They withstand vibration and shock and have excellent thermal and insulating properties. **This anchor is not recommended for overhead applications.**

Toggle Anchors



Hollow Wall Screw

Also called a **Molly Anchor**, the **Hollow Wall Screw** is **for use in plaster, drywall, concrete block or hollow tile.** The anchor is a two-part assembly consisting to a machine screw and a multi-leg expansion sleeve. As the screw is tightened, the multi-legs expand and are drawn up tight against the substrate, this providing a firm grip.



Heavy Duty Toggle

This is a toggle-type anchor with several additional features and advantages and are **ideal for use in walls, ceilings, or floors of materials such as gypsum board, drywall with a steel stud, concrete block, tile over drywall, etc.** The Heavy Duty Toggle can be installed through smaller holes than that of standard toggle bolts and also has a higher load capacity. The unique plastic cap and channel allow the anchor to be pre-installed without a bolt allowing installation by just one person. This feature also allows the anchor to be re-used since the wing will not fall into the wall when the screw is removed like standard toggle bolts.



Toggle Bolt — Designed for use in block, drywall and other hollow base materials.

This is a two-part assembly consisting of a machine screw and spring wing toggle. Available in Mushroom, Flat and Round Head styles but can be used with any style machine screw with the appropriate thread-diameter and pitch. The spring loaded wing configuration is designed to sit flat against the underside of the wall, providing even distribution of load and maximum pull-through strength.



Poly-Toggle — The Poly-Toggle is a unique and easy-to-install plastic toggle-type anchor **for use with sheet metal screws in wallboard, solid masonry, hollow doors or any hollow wall applications** from 1/8 to 1-1/2 thick. Since the anchor is made of plastic it is completely rust-proof when used with stainless steel or brass screws in any corrosive environment.



One-Step Anchors

Mungo Jet Plugs & E-Z Anchors — A self-drilling anchor designed **for use in wallboard for light to medium duty loads**. Mungo Jet Plugs and E-Z Anchors are available in both Zinc and Nylon in two different sizes. Their unique thread design features thin, knife-like oversized threads that achieve unusually high holding power without sacrificing speed. Use with #6 and #8 screws.



E-Z Toggle — Another self-drilling anchor but with the added strength of a toggle built right in. The E-Z Toggle is **made to be used in wallboard**. Once it has been set into the wallboard, simply drive the sheet metal screw included. The sheet metal screw grabs the toggle and pulls it tight against the substrate providing a strong, sturdy anchor for light to medium duty loads.



Rapidrive Anchor Screws — An all steel, one piece threaded fastener which is **used to fasten various fixtures directly to drywall**. Rapidrive fasteners are fast. Unlike conventional screw anchors, which require a secondary step of threading a sheet metal screw into an anchor, the Rapidrive fastener is installed directly through the fixture into the drywall.



Drill & Drive Anchors

Masonry Screws

The masonry screw is a screw anchor that actually cuts its own threads into concrete. This anchor meets the needs for **most light to medium duty applications in concrete, block and brick**. Available in Hex and Flat head styles and is removable and reusable.



Zamac Nail-In Anchor

Designed **for use in concrete, block and brick** the Zamac Nail-In Anchor is another screw-type anchor. Its major difference is its availability in larger sizes and its unique thread design that gives it a "better bite" in concrete.



Shield Type Anchors

Bolt / Calking Anchor

A small anchor for **use with machine screws or bolts in concrete, block, brick or stone**. This anchor is set using the setting tool forcing the expansion cone and expanding the lead body outward against the walls of the anchor hole.



Drop & Drive Anchors

Bolt Anchor

A one piece wedge style anchor **for use in concrete**. The diameter of the Bolt Anchor is also the same as that of the hole and fixture, which eliminates layout and hole spotting. The collar on the Bolt Anchor is expanded outward against the substrate when the anchor is tightened. It is used for heavy duty fastening applications where high pullout values are required.



A
N
C
H
O
R
S



IBS, INCORPORATED

Anchors Y04

Screw Anchors

Bantam Plugs



Bantam Plugs are lightweight plastic anchors that can be used with either wood, sheet metal or lag screws. These economical anchors can be used for a number of different light duty applications for fastening fixtures such as mirrors and shelving brackets. Their load capacity will vary depending on the integrity of the base material into which they are installed. It is recommended that they be used for light duty static applications where holding power is not a critical factor. Collar flange allows for easy installation into hollow walls. They are made of corrosion resistant plastic and can be used in concrete, block, wallboard, tile or brick.

IBS No.	Color	Size	Drill Diam.	Min. Depth	Qty
55000	Blue	#6-8 X 3/4	3/16	3/4	100
55001	Red	#8-10 X 7/8	3/16	7/8	100
55002	Blue	#10-12 X 1	1/4	1	100
55003	Red	#14-16 X 1-1/2	5/16	1-1/2	50

Installation Procedure

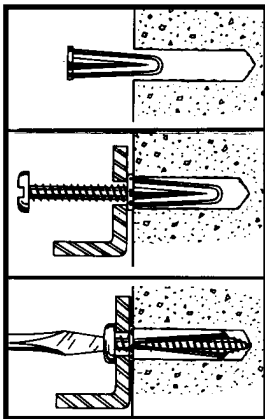

Drill hole 1/4" deeper than the length of the anchor. Insert the anchor so it is flush with the wall surface.

Insert the wood or sheet metal screw through the fixture and into the anchor. Tighten the screw so that the anchor will expand and hold firmly.

For best results the screw should protrude 1/4" through the bottom of the anchor.

Screw length = Fixture thickness + Anchor length + 1/4"

Super Plastic Anchors



Super Plastic Anchors are multi-size lightweight plastic anchors for use with wood, sheet metal and lag screws. Designed for light duty applications, they feature a ribbed body and pop-out anchors which grip the material into which they are installed allowing them to provide more gripping power than ordinary plastic anchors.

IBS No.	Size	Length	Drill	Qty
55230	#4-6-8-10	1	3/16	100
55231	#8-10-12-14	1-1/4	3/16	100
55232	#12-14-16	1-1/2	1/4	100

RECOMMENDED SCREW SIZES

Phil Flat	Phil Pan	Size	Use with
7792	7700	6 X 1-1/2	55230
7824	7735	10 X 1-1/2	55231
7851	7765	14 X 1-1/2	55232

ANCHORS



Bolt Anchors Single Unit Caulking Anchors

Open End



Open End Caulking Anchors are precision cast caulking type machine screw anchors and are used in concrete, brick, or stone. They can be used with either machine screws or bolts. They are made up of a lead sleeve and zinc alloy cone to protect against rust and corrosion. The zinc alloy cone is chamfered at the top for easy screw starting. The sharp collar prevents the cone from being drawn up through the sleeve when overloads are applied. Screw engagement should be a minimum of 2/3 of the anchor threads.

IBS No.	Size	Drill	Min. Depth	Safe Working Load (lbs)	Qty
55202	10-24	3/8	5/8	150	100
55206	3/8-16	3/4	1-1/4	450	50

Caulking Anchor Installation Procedure



Drill hole in masonry. Insert caulking anchor conical end first.

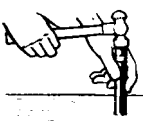

Use setting tool to expand lead sleeve into masonry.

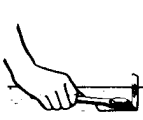

Install work by inserting and tightening a standard machine bolt or screw.

Hollow Wall Anchors Toggle Bolts



Toggle Bolts are commonly used in hollow walls, hung ceilings and horizontal surfaces where gravity-action toggles would be difficult to set. The winged head of a toggle bolt open automatically by means of a spring within the head. All toggle threads are National Standard Thread.

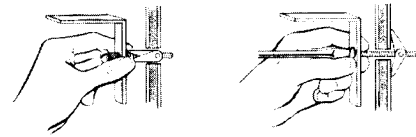

To Install: Drill hole completely through wall. Insert the bolt through the item to be fastened and thread the toggle wings onto the end of the bolt. Fold the wings completely back and push them through the hole until the wings spring open. Pull back to hold the wings against the inside wall and tighten with a screwdriver.

IBS No.			Size	Drill Dia.	Qty
Mush	Flat	Round			
55045	55073	55053	1/8 (6-32) X 2	3/8	50
55046	55074	55054	1/8 (6-32) X 3	3/8	50
55047	55075	55055	1/8 (6-32) X 4	3/8	50
		55056	3/16 (10-24) X 2	1/2	50
55049	55077	55057	3/16 (10-24) X 3	1/2	50
55050	55078	55058	3/16 (10-24) X 4	1/2	50
	55081	55061	1/4-20 X 3	5/8	50
	55082	55062	1/4-20 X 4	5/8	50
		55066	5/16-18 X 4	7/8	25
		55069	3/8-16 X 3	7/8	25
		55070	3/8-16 X 4	7/8	25
		55071	3/8-16 X 5	7/8	25

Toggle Wings Only For Toggle Bolts

IBS No.	Size	Drill	Qty
55085	1/8 (6-32)	3/8	100
55086	3/16 (10-24)	1/2	100
55087	1/4-20	5/8	100
55088	5/16-18	7/8	50
55089	3/8-16	7/8	50

ANCHORS



IBS, INCORPORATED

Anchors Y04

Rapidrive Anchor Screws Light to Medium Duty Anchors



143150
Chrome, Pan Head



143152
Chrome, Oval Head



143151
White, Pan Head



143153
White, Oval Head

The Rapidrive Anchor Screw is an all steel, one-piece screw anchor, which features high profile threads for easy fastening into wallboard and other masonry base materials. The deep cutting, corkscrew-like threads provide for smooth entry and a powerful hold. For fastening into wallboard or wood, no pre-drilling is required—the anchor is inserted through the fixture and screwed in with an ordinary Phillips screwdriver. Fastening into concrete, hollow or grout-filled concrete masonry, brick and plaster requires a pre-drilled hole using a 3/16" ANSI bit. The best anchor for light to medium duty applications.

Features & Benefits:

- All steel construction is stronger and can be installed in a variety of base material
- High profile threads prevents spinning and stripping
- One piece installs directly through fixtures – no second step required
- Deep cutting corkscrew-like threads for smooth entry and powerful hold
- Heat-treated points penetrates metal & wood studs
- Two Head Styles and two color finishes for better aesthetic finish in different color fixtures.
- Can be removed and leaves a much smaller hole than other anchors
- Ideal for lightweight fixtures, drapery supports, electrical boxes, telephone and cable accessories, etc.

For Use in:

Normal Weight Concrete • Grout Filled Concrete • Hollow Concrete Masonry
Brick Masonry • Wallboard • Plywood • Plaster

Pan Hd	Oval Hd	Description	Head Size	Drive	Qty
143150	143152	3/16 X 1-1/4 Chrome	No. 8	#2	100
143151	143153	3/16 X 1-1/4 White Head	No. 8	#2	100

Ultimate & Allowable Load Capacities for Rapidrive Anchor Screws In Normal Weight Concrete

Anchor Diameter In. (mm)	Minimum Embedment Depth In. (mm)	Minimum Concrete Compressive Strength $f'_c \geq 4,000$ psi (27.6 MPa)			
		Ultimate Load		Allowable Load	
		Tension lbs. (kN)	Shear lbs. (kN)	Tension lbs. (kN)	Shear lbs. (kN)
1/4 (6.4)	3/4 (6.4)	350 (1.6)	1,030 (4.6)	90 (0.4)	260 (1.2)
	1 (25.4)	700 (3.2)	1,070 (4.8)	175 (0.8)	270 (1.2)

Ultimate Load Capacities for Rapidrive Anchor Screws In Wallboard & Plywood ¹

Anchor Diameter in. (mm)	1/2 Wallboard		5/8 Wallboard		3/4 Wallboard	
	Tension lbs. (kN)	Shear lbs. (kN)	Tension lbs. (kN)	Shear lbs. (kN)	Tension lbs. (kN)	Shear lbs. (kN)
1/4 (6.4)	85 (0.4)	245 (1.1)	135 (0.6)	360 (1.6)	255 (1.1)	600 (2.7)

1. The values listed above are **ultimate** load capacities which should be reduced by a minimum safety factor of 4.0 or greater to determine the allowable working load.

A
N
C
H
O
R
S

IBS, INCORPORATED

Anchors Y04



Rapidrive Anchor Screws (cont'd)

Allowable Load Capacities for Rapidrive Anchor Screws In Wallboard & Plywood ¹

Anchor Diameter in. (mm)	1/2 Wallboard		5/8 Wallboard		3/4 Wallboard	
	Tension lbs. (kN)	Shear lbs. (kN)	Tension lbs. (kN)	Shear lbs. (kN)	Tension lbs. (kN)	Shear lbs. (kN)
1/4 (6.4)	20 (0.1)	60 (0.3)	35 (0.2)	90 (0.4)	65 (0.3)	150 (0.7)

1. The values listed above are calculated using an applied safety factor of 4.0.

Ultimate & Allowable Load Capacities for Rapidrive Anchor Screws In Grout-Filled, Hollow Masonry & Structural Brick Masonry ¹

Anchor Diam. In. (mm)	Minimum Embed Depth In. (mm)	Anchor Location	Grout Filled Concrete Masonry ASTM C 90		Hollow Concrete Masonry ASTM C 90		Brick Masonry	
			Tension lbs. (kN)	Shear lbs.(kN)	Tension lbs. (kN)	Shear lbs. (kN)	Tension lbs. (kN)	Shear lbs. (kN)
1/4 (6.4)	3/4 (19.1)	Center of Masonry Unit	—	—	—	—	400 (1.8)	650 (1.8)
	3/4 (19.1)	T-Joint	—	—	—	—	350 (1.6)	600 (2.7)
	1 (25.4)	Center of Masonry Unit	285 (1.3)	825 (3.7)	305 (1.4)	825 (3.7)	600 (2.7)	900 (4.1)
	1 (25.4)	T-Joint	290 (1.3)	915 (4.1)	290 (1.3)	915 (4.1)	380 (1.7)	825 (3.7)

1. The values listed above are ultimate load capacities which should be reduced by a minimum safety factor of 5.0 or greater to determine the allowable working load.

Assortments Z02

Rapidrive Anchor Screws Assortment

IBS No. 675R • 6 Items • 205 pieces

Packaged in a locking plastic box for easy storage and organization

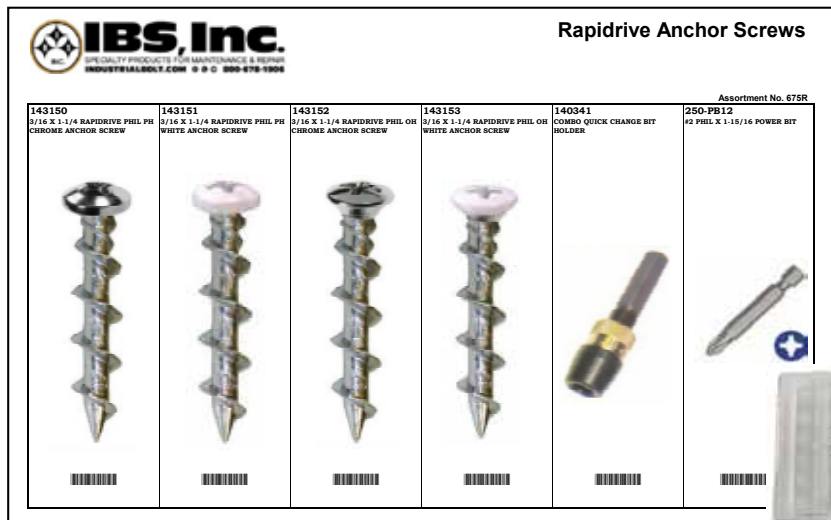



IBS, INCORPORATED

Anchors Y04

E-Z Anchor

Self-Drilling, One-Piece Anchor for Light Duty Drywall Attachments



- No hole preparation necessary; pre-drills own small precise hole in gypsum wallboard for fast and easy installation.
- Replaces plugs and plastic toggles to reduce inventory and save money.
- Deep thread design provides strong engagement in 3/8, 1/2 and 5/8 gypsum wallboard for better performance and pullout strength.
- Installs quickly and easily with a #2 phillips screwdriver or power driver.
- Full range of anchors to cover all wall fastening applications.
- Available in corrosion resistant, non-conductive white nylon to resist and eliminate chance of electrical arcing.

APPLICATIONS

- Electrical Fixtures
- Thermostats
- HVAC Fixtures
- Plumbing Fixtures
- Bathroom Accessories
- Shelving & Supports
- Telecommunications Equipment
- Decorative Wall Hangings
- Plaques & Awards
- Closet Organizers
- Coat Racks
- Curtain Rods
- Signs
- Bulletin Boards
- Control systems
- Picture Frames
- Remote Control Boxes
- Office Material Holders
- Smoke Detectors
- Clocks
- Kitchen Accessories
- Doorbells
- Mirrors
- Chalk Boards
- Brackets

PERFORMANCE DATA

These performance values are averages obtained under laboratory conditions. Note that these values will change depending on age, moisture content, and surface treatment of the drywall (gypsum) material. Appropriate safety factors should be applied to these values for design purposes.



HOLDING WEIGHT

Gypsum Thickness

	3/8	1/2	5/8
E-Z Mini Anchor	30	40	50
E-Z Anchor	40	50	75
E-Z Toggle	70	85	150

ANCHORS

	IBS No.	Description	Material	Qty.	MAX Thickness	Use with IBS No.
Light Duty	55038		Zinc	100	3/4	7699 #6 x 1-1/4 SMS 7718 #8 x 1-1/4 SMS
Medium Duty	55036 55037		Zinc White Nylon	100	3/4	7719 #8 x 1-1/2 SMS
Heavy Duty	55240		Zinc	50	5/8	Includes 50 #8 x 2-1/8 SMS



E-Z Anchors

SELF-DRILLING, ONE-PIECE ANCHOR FOR LIGHT DUTY DRYWALL ATTACHMENTS

Installation Guidelines

E-Z Mini-Ancor & Medium Duty E-Z Ancor

1. Place #2 Phillips screwdriver into recess of E-Z Mini Ancor or E-Z Ancor.
2. Press into drywall while turning the anchor clockwise until it is sealed flush with the wall.
3. Place fixture in position over installed E-Z Mini Anchor or E-Z Anchor. Insert with screwdriver. Tighten fixture in place.

Heavy Duty E-Z Toggle

1. Place #2 screwdriver into recess of E-Z Toggle. Press into drywall while turning the anchor clockwise until it is sealed flush with wall and arrows on head are parallel to stud.
2. Place fixture in position over installed E-Z Toggle. Insert screw and push through E-Z Toggle to engage clamp.
3. Continue turning screw until tight. The clamp will move back against the drywall as the screw is turned.

Hollow Wall Anchors & Fasteners

IBS No. 205R • 16 ITEMS • 650 PIECES

IBS, Inc. <small>SPECIALTY PRODUCTS FOR MAINTENANCE & REPAIR INDUSTRIALDOLY.COM © © © 800-678-1906</small>		Hollow Wall Anchors & Fasteners		
Assortment No. 205R				
7698 6 X 1 PHIL PAN HD T/S ZP 		55230 4-6-8 X 1 WING SCREW PLASTIC 	55038 E-Z MINI ANCHOR ZINC E-Z Ancor Mini Light Duty Hangs up to 40 lbs. 	
7717 8 X 1 PHIL PAN HD T/S ZP 	7719 8 X 1-1/2 PHIL PAN HD T/S ZP 	55231 8-10-12X1-1/4 WING SCREW 	55037 EZ-ANCHOR WHITE NYLON E-Z Ancor Plastic Plus Medium Duty Hangs up to 50 lbs. 	
7733 10 X 1 PHIL PAN HD T/S ZP 	7735 10 X 1-1/2 PHIL PAN HD T/S ZP 	55231 8-10-12X1-1/4 WING SCREW 	55036 EZ-ANCHOR ZINC E-Z Ancor Zinc Medium Duty Hangs up to 50 lbs. 	55035 MUNGO JET PLUG EZ-ANCHOR
7763 14 X 1 PHIL PAN HD T/S ZP 	7765 14 X 1-1/2 PHIL PAN HD T/S ZP 	55232 12-14-16X1-1/2 WING SCREW 	55240 E-Z TOGGLE STANDARD E-Z Toggle Heavy Duty Hangs up to 55 lbs. 	

**A
N
C
H
O
R
S**



IBS, INCORPORATED

Anchors Y04

Hollow Wall Anchors

Mungo Jet Plugs



Mungo Jet Plugs are one of the fastest and easiest hollow wall anchors that can be used in wallboard. They feature a unique **drill tip configuration** that uses **four offset blades** to insure fast and true cutting. **Two blades are cutting blades** while the other **two are used to stabilize** the anchor for speed and accuracy.

Their **unique thread design** features thin, **knife-like oversize threads** that achieve unusually high holding power in gypsum without sacrificing speed. **The tapered root** compacts the wall material around the anchor, further increasing holding power. The anchor is held in place by **anti-rotation ratchet teeth** under the collar. This allows removal of the screw without removing the anchor.

IBS No.	Description	Max. Thickness	Qty
55035	Mungo Jet Plug (Zinc)	Up to 1"	100

Special Features:

- **Self drilling plug** — eliminates pre-drilling.
- **Deep thread engagement** — offers excellent pullout values
- **Zinc Die Cast** — will not corrode.

Engineered for:

- HVAC Contractors
- Drywall, chipboard, & plasterboard
- Security System installers
- Interior Finishers
- Shelving Contractors

HOLDING WEIGHT

Gypsum Thickness

3/8	1/2	5/8
40 lbs	50 lbs	75 lbs

Screw Anchors



Hollow Wall Screw Anchors are designed for use in hollow materials, such as plaster, wallboard, concrete, block, hollow tile, paneling, etc. They are made of steel and do not require additional fasteners. Slotted round head screws come with each anchor. As the screw is tightened, the legs of the screw anchor expand and are drawn up tight in three planes against the wall of the hollow material, thus providing a secure firm grip. After setting the anchor the screw may be removed and replaced repeatedly without affecting the screw anchor.

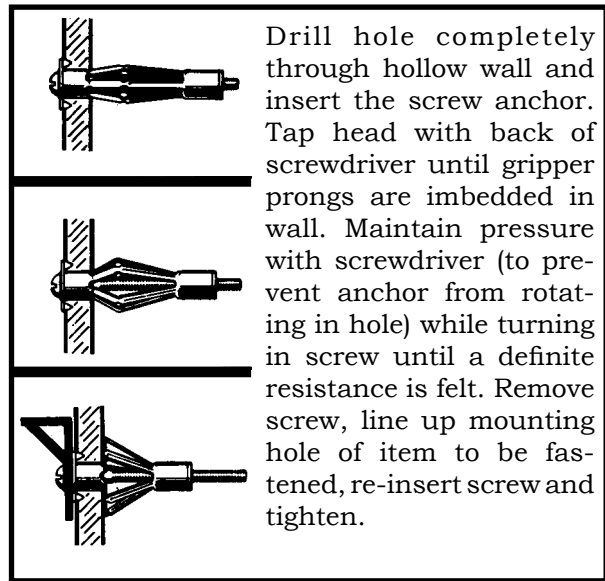

Drill hole completely through hollow wall and insert the screw anchor. Tap head with back of screwdriver until gripper prongs are imbedded in wall. Maintain pressure with screwdriver (to prevent anchor from rotating in hole) while turning in screw until a definite resistance is felt. Remove screw, line up mounting hole of item to be fastened, re-insert screw and tighten.

IBS No.	Size	Drill Bit	Wall Thickness	Qty
55025	1/8 Extra Short	5/16	1/16 to 1/4	100
55027	1/8 Long	5/16	5/8 to 1	100
55030	3/16 Long	3/8	3/4 to 1-1/8	50
55033	1/4 Long	1/4	5/8 to 1-1/8	50
55040	1/8 Long	Drive	1/2 to 3/4	100

ANCHORS



Hollow Wall Anchors

Heavy Duty Toggle Anchors

These heavy-duty hollow wall anchors are ideal for use in walls, ceilings, or floors of materials such as gypsum board, drywall with a steel stud, concrete block, tile over drywall, etc. The anchor is **pre-assembled** and ready for immediate use. The **ratcheting strap/locking cap assembly** positions the **one piece** zinc-plated steel anchoring channel flush against the rear of the wall. The straps on the outside of the wall are then easily and quickly snapped off by hand flush with the surface of the wall (**no extra tools required**). Holding is dependent only on a metal bolt to metal channel connection. Heavy Duty Toggle Anchors comply with all existing fire codes for critical applications.



IBS No.	Bolt Thread	Drill Diam.	Grip Range	Qty
55095	10-24	1/2	3/8 - 3-5/8	25
55096	1/4-20	1/2	3/8 - 3-5/8	25
55097	3/8-16	3/4	3/8 - 2-1/2	25
55098	1/2-13	3/4	3/8 - 2-1/2	25

Features & Benefits

- **Strong - up to 2x the load** of an old-fashioned wing toggle
- **Solid metal channel resists vibration and shock**
 - bolt is centered in channel and positioned for precise installation
 - bolt threads never touch interior surface of hole and will not cut/saw through substrate
- **Saves installation time** — at least 6 minutes per anchor versus wing toggles
- **Can use a screw gun** — anchor does not spin
- **Saves money** — turn a 2 person job into a 1 person job
- **Uses a shorter bolt** — no need to carry a wing through the wall
- **New, patented strap design** with sturdier straps and smaller ratchet interval:
 - adjusts more precisely and **snaps off flush** to wall, ceiling, or floor
 - **does not break** prematurely pushes aside insulation
- **Smallest installation hole for each bolt size**
 - maintains integrity of wall, ceiling, or floor, which strengthens the anchoring
 - ends the need to patch an oversized hole: a 1/4" wing toggle requires a 3/4" diameter hole: 50% larger than the 1/2" diameter hole used by the Heavy Duty Toggle Anchor
- **Plating is 7x more corrosion resistant** than B633-85 Type III/SC 1 government spec high quality zinc plating (350 hours to red rust in salt spray vs. only 48 hours for government spec).
- **Pre-installs without the bolt** for easy fixture handling.
- **Reusable in the same hole** — allows for removal without losing the anchor.
- **Ergonomic design** — means that fingers grab straps easily with no slipping.

INSTALLATION INSTRUCTIONS



Drill appropriate size hole. Hold metal channel flat alongside plastic straps and slide channel through the hole.

Minimum clearance behind wall: 1-7/8"

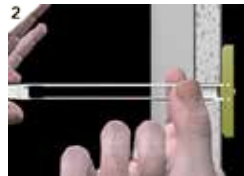

Hold ends of straps together between thumb and forefinger and pull toward you until channel rests behind wall. Ratchet cap along straps with other hand until flange of cap is flush with wall.



Place thumb between straps at wall. Push thumb side to side, snapping off straps level with flange of cap.

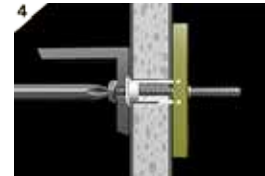

Place item over flange. Insert bolt and tighten until snug against item, then stop. Use machine screw or bolt to match thread in metal channel.



IBS, INCORPORATED

Anchors Y04

Heavy Duty Toggle Anchors

SPECIFICATIONS:

Description: Heavy Duty Toggle Anchors

Material: Zinc-plated, 1010 cold rolled steel metal channel, high impact polystyrene

Screw specification: UNC thread machine screw (bolt to match thread in metal channel)

Minimum screw length: thickness of wall or ceiling + thickness of item being fastened + 1/2"

Minimum clearance behind wall: 1-7/8"

Minimum drywall thickness: 3/8"

Maximum drywall thickness: 3-5/8" for 55095 & 55096
2-1/2" for 55097 & 55098

The plastic straps and cap washer are positioning and retention elements only. They do not otherwise function as anchoring elements. Holding is dependent only on a metal bolt to channel connection. The HEAVY DUTY TOGGLE ANCHOR complies with all existing fire codes for critical applications.



Applications

- Flat panel TV's
- TV mounts
- Lighting Fixtures
- Window Treatments
- Marine applications
- Hand Rails
- Grab bars
- ADA Hardware
- Office Furniture
- Heavy Machinery
- Partitions
- Cabinets
- Shelving
- Solar Panels
- Garage Doors
- Sinks
- Heavy Fans
- DSS antennas
- Reinstallations
- Roofs & Decking

For Use in

- Cinder Block
- Concrete Block
- Gypsum board
- Drywall
- Tile over drywall
- Plasterboard
- Composite Panels
- Cement board
- Greenboard
- Plaster
- Stucco
- Fiberglass
- Plywood
- Steel Plate
- Plastic
- Wood studs/beams

TENSILE (LBS)

IBS No.	UNC Thread	Drill Diam.	1/2 Drywall	5/8 Drywall	*1/2 with 25 GA stud	*5/8 with 25 GA stud	Concrete Block	1/2 Steel Plate
55095	10-24	1/2	238	356	412	462	802	918 ¹
55096	1/4-20	1/2	265	356	425	464	1080	1288 ²
55097	3/8-16	3/4	275	576	466	488	1745	1692
55098	1/2-13	3/4	275	576	468	513	**2038 ²	2605

* Failure measured as breakage drywall portion
** Failure of block
1 Stainless steel bolts used
2 Hardened bolts used

SHEAR (LBS)

IBS No.	UNC Thread	Drill Diam.	1/2 Drywall	5/8 Drywall
55095	10-24	1/2	247	298
55096	1/4-20	1/2	241	324
55097	3/8-16	3/4	292	406

Industry standards recommend 1/4 of ultimate test load.

Holding strength varies directly with the strength and condition of the substrate and the bolt size — and inversely with variations in hole diameter and the distance of the load from the wall.

All figures in pounds. Pull-out values based on independent laboratory tests done according to U.S. Government standards. They should be used as guides only and cannot be guaranteed. The age, condition, and capacity of the substrate must be considered.

ANCHORS

IBS, INCORPORATED

Anchors Y04



Hollow Wall Anchors Poly-Toggle® Screw Anchors



Poly-Toggle® Screw Anchors are patented, fast, easy-to-use hollow wall anchors. They are made of polypropylene for use with sheet metal screws in wallboard, solid masonry or hollow doors. Special design in the screw path allows the poly-Toggle® screw anchor to accept screw length as short as 3/4" over the thickness of the work. This allows the Poly-Toggles® to be used where plywood is used for furring strips. They also feature two pressure pads which help the Poly-Toggle® shape into a rigid, stable structure truss that spreads and distributes the load away from the hole. The net effect is increased holding power even when the inside of the hole is rough and other anchors tend to get pulled into the wallboard and distorted, losing shape and pull-out resistance.

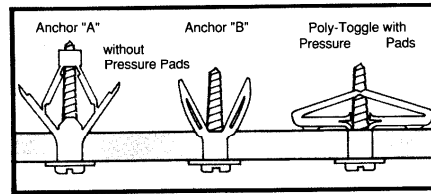
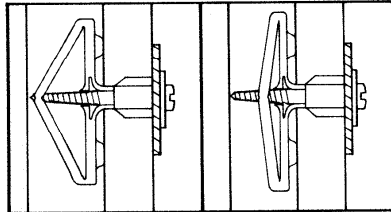

IBS No.	Size	Thick	Wallboard		Concrete Block		Drill Diam.	Qty
			Tension	Shear	Tension	Shear		
55093	Medium	5/8	1/2 - 5/8	150	280	230	5/16	100

Hollow Wall Anchors Assortment (Z02)

IBS No. 397R • 9 ITEMS • 180 PIECES



Hollow Wall Anchors & Fasteners

Assortment No. 397R

<p>55095 10-24 HVY DUTY TOGGLE ANCHOR</p>  	<p>55096 1/4-20 HVY DUTY TOGGLE ANCHOR</p>  	<p>55093 1/2 TO 5/8 POLY TOGGLE</p>   <p>55037 EZ-ANCHOR WHITE NYLON</p>  	<p>143150 3/16 X 1-1/4 RAPIDRIVE PHIL PH</p>  
<p>9585 10-24 X 3 PHIL ROUND HD M/S ZP</p>  	<p>9608 1/4-20 X 4 PHIL ROUND HD M/S</p>  	<p>7719 8 X 1-1/2 PHIL PAN HD T/S ZP</p>  	<p>143152 3/16 X 1-1/4 RAPIDRIVE PHIL OH</p>  

ANCHORS



IBS, INCORPORATED

Anchors Y04

One-Step Anchors

Nylon Nail-In Anchors



Nylon Nail-In Anchors install quickly, easily and economically in concrete, block, brick or wallboard. They are made of nylon casing with steel nails and the head design is mushroom (truss) style. They withstand vibration and shock and have excellent thermal and insulating properties. They resist chemicals, fungus and rot and can be used in hollow or solid base applications.

IBS No.	Size	Drill	Qty
55008	1/4 X 3/4	1/4	100
55009	1/4 X 1	1/4	100
55010	1/4 X 1-1/2	1/4	100
55011	1/4 X 2	1/4	100

Zamac Nail-In Anchors



Zamac Nail-In Anchors have a body made of Zamac #7, a special zinc alloy developed for its resistance to corrosion. The expansion device is a steel nail which is driven through the body. The head design is mushroom (truss) style. The anchors are tamper proof and can be used in concrete, block, brick or stone.

IBS No.	Size	Drill	Qty
55015	3/16 X 7/8	3/16	100
55016	1/4 X 3/4	1/4	100
55017	1/4 X 1	1/4	100
55018	1/4 X 1-1/4	1/4	100
55019	1/4 X 1-1/2	1/4	100
55020	1/4 X 2	1/4	100

Nail-In Anchor Installation Procedure

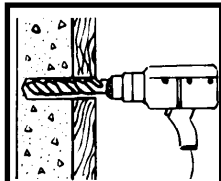

Drill hole same diameter as Nail-In Anchor (3/16" or 1/4") but slightly deeper than the anchor length.

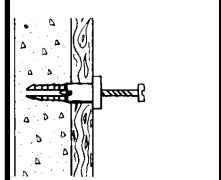

Insert Nail-In Anchor through item to be fastened and into drilled hole.

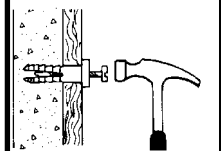

Drive expander pin flush with head of anchor. Nail-In anchor expands and is permanently anchored. If desired, the Nail-In anchor can be removed with a screwdriver and reused.

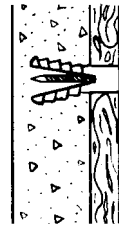

Solid Application
The entire length of the anchor body is compressed against the sidewalls of the hole.

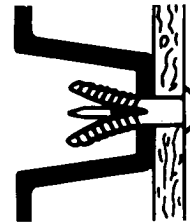

Hollow Application
A secure fastening is obtained when legs of Nail-In anchor are expanded.

A
N
C
H
O
R
S



One-Step Anchors

Wedge Type Stud/Bolt Anchors



Wedge Type Stud/Bolt Anchors are one-piece anchor bolts made of standard low carbon steel for use in highly corrosive environments.

Typical applications include:

Heavy Construction: bridges, dams, power plants, highway guard railings

General Construction: fastening elevator equipment, electro/mechanical apparatus, railings, door and window framing;

Industrial Maintenance: fastening conveyors, machinery, storage racks, loading docks.

IBS No.	Size	Min. Depth	Thread Length	Qty
55101	1/4 X 2-1/4	1-1/8	7/8	100
55102	1/4 X 3-1/4	1-1/8	7/8	100
55106	3/8 X 2-3/4	1-3/4	1-1/8	50
55107	3/8 X 3	1-3/4	1-1/8	50
55109	3/8 X 3-3/4	1-3/4	1-1/8	50
55110	3/8 X 5	1-3/4	1-1/8	50
55111	1/2 X 2-3/4	2-1/4	1-1/4	50
55112	1/2 X 3-3/4	2-1/4	1-1/4	50
55113	1/2 X 4-1/2	2-1/4	1-1/4	50
55114	1/2 X 5-1/2	2-1/4	1-1/4	50
55116	5/8 X 3-1/2	2-7/8	1-5/8	25
55117	5/8 X 4-1/2	2-7/8	1-5/8	25
55118	5/8 X 5	2-7/8	1-5/8	25
55119	5/8 X 6	2-7/8	1-5/8	25
55122	3/4 X 4-1/4	3-3/8	1-3/4	10
55123	3/4 X 4-3/4	3-3/8	1-3/4	10
55124	3/4 X 5-1/2	3-3/8	1-3/4	10

PULLOUT LOAD TEST—TENSION LOAD (LBS)

Anchor Size	Embed Depth	Install Torque (ft-lbs)	2,000 psi	4,000 psi	6,000 psi
1/4	1-1/8	8	1,670	2,380	2195
1/4	1-1/2	8	2,120	2,585	2560
1/4	2	8	2,725	2,925	3050
3/8	1-5/8	28	3,566	4,125	4150
3/8	2	28	2,900	4,310	4400
3/8	3	28	4,800	4,800	5070
1/2	2-1/4	60	6,525	6,625	6625
1/2	3	60	7,135	8,050	8050
1/2	4	60	7,945	9,945	9945
5/8	2-3/4	90	7,330	8,365	8390
5/8	4	90	9,375	10,140	11565
5/8	5	90	11,010	11,555	14100
3/4	3-3/8	175	10,745	10,745	1525
3/4	5	175	14,855	15,695	1930
3/4	6	175	17,385	18,745	21755

***NOTE:** Test data above represent average ultimate loads sustained in concrete having minimum compressive strengths as indicated.

ANCHORS



IBS, INCORPORATED

Anchors Y04

One-Step Anchors

Wedge Type Stud/Bolt Anchors

Wedge Type Stud/Bolt Anchors feature dual-pressure expansion collars to distribute the load equally in the lateral planes of the concrete, thereby preventing bolt cocking and premature rupture of the concrete due to distortion or uneven distribution of the load.

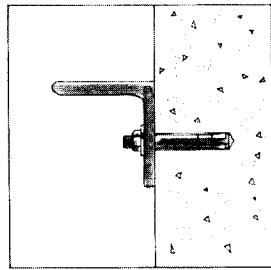
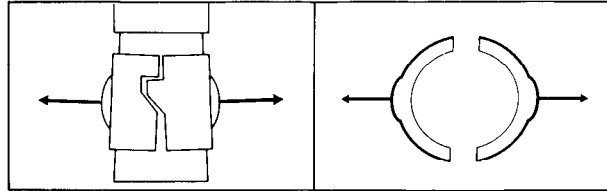

The **Wedge Type Stud/Bolt Anchor** is ideal for fastening angle brackets, support angles for floors and formwork, and high-load shelving.

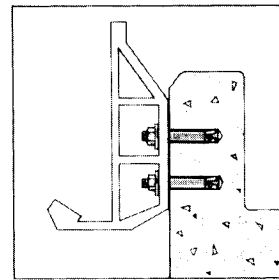

The **Wedge Type Stud/Bolt Anchors** are also used to securely attach highway and commercial sign supports to a wide variety of masonry materials.

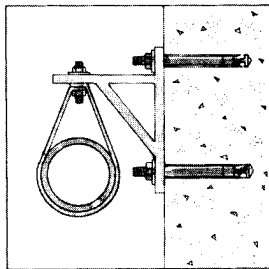

Wedge Type Stud/Bolt Anchors are also used to securely fasten supports for piping conduits and electrical junction boxes.

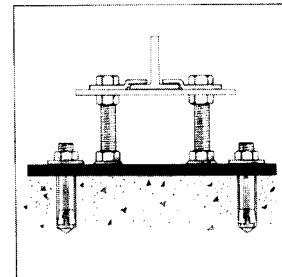

The **Wedge Type Stud/Bolt Anchor** is also ideal for the installation of equipment and elevator guide rails.

Wedge Type Stud/Bolt Anchor Installation Procedure

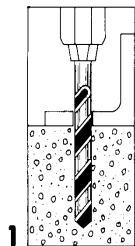

Drill hole in concrete (hole diameter same as thread diameter). Maximum depth of drilled hole could be any depth beyond minimum recommended.

1

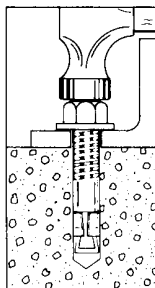

Drive wedge anchor into drilled hole through fixture so that nut is flush with fixture.

2

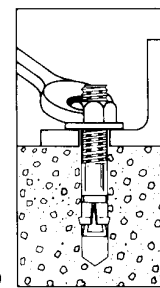

Tighten nut until wrench resistance is felt (approximately 3 to 4 full turns of the nut after snugged up). Anchorage is now complete.

3



Masonry Fastening Systems

The original masonry anchor . . . cuts threads into concrete, brick and cement block. Stalgard® coating offers better corrosion protection than zinc or cadmium.



Thread

Patented twin-lead design literally taps threads into concrete. The high thread with notched cutting edges cuts easily into masonry. The low threads provide stability.

Shank

Tapered shank creates progressive tapping action that cuts threads into concrete. 3/16" or 1/4" diameters available.

Point

Nail point guides anchor into pre-drilled hole. Also allows drilling into wood. Anchor is also reversible for easy removal.

The System:

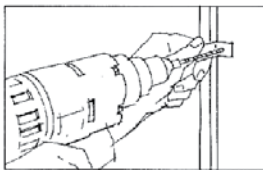

Drill

Just drill the hole



Drive

then drive the anchor

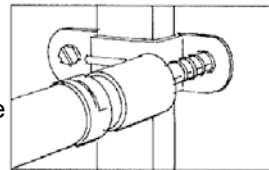

Fastened

replaces a wide variety of anchors, plugs and screws.

Selection / Specification:

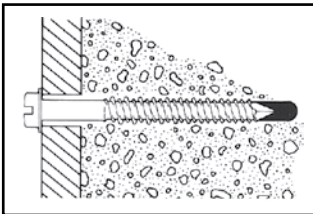

Thickness of the fixture being anchored and the desired embedment in the masonry material determines the anchor length. A minimum of 1" and a maximum of 1-3/4" embedment is recommended. 1/4" diameter anchors are recommended in lightweight block applications where strip-out may be a problem.

Concrete & Masonry Fastening Systems

SLOTTED HWH CONCRETE & MASONRY SCREWS

IBS No.	Size	Qty	Use with Drill Bit	IBS No.	Size	Qty	Use with Drill Bit
55300	3/16 X 1-1/4	100	55335	55307	1/4 X 1-1/4	100	55337
55301	3/16 X 1-3/4	100	55335	55308	1/4 X 1-3/4	100	55337
				55309	1/4 X 2-1/4	100	55338
				55310	1/4 X 2-3/4	100	55338
				55311	1/4 X 3-1/4	100	55338

Drill Bits Ordered Separately

PHILLIPS FLAT HEAD CONCRETE & MASONRY SCREWS

IBS No.	Size	Qty	Use with Drill Bit	IBS No.	Size	Qty	Use with Drill Bit
55314	3/16 X 1-1/4	100	55335	55322	1/4 X 1-3/4	100	55337
55315	3/16 X 1-3/4	100	55335	55323	1/4 X 2-1/4	100	55337
55316	3/16 X 2-1/4	100	55336	55324	1/4 X 2-3/4	100	55338
55317	3/16 X 2-3/4	100	55336	55325	1/4 X 3-1/4	100	55338
55318	3/16 X 3-1/4	100	55336				

Drill Bits Ordered Separately



ANCHORS



IBS, INCORPORATED

Anchors Y04

Tool Kit for Concrete Screws IBS No. 55330

Makes installation of concrete and masonry screws easy! Accessories are compatible with a standard, 3-jaw style chuck, and the sockets have been designed to prevent over-torquing and fastener failure. Packaged in a rugged plastic box ideal for storage of the installation tool kit and concrete masonry screws.

8 Pc Kit includes:

- Drill Bit Holder
- 5-3/4" sleeve
- 1/4" & 5/16" Hex Sockets
- #2 & #3 Phillips Bits
- Allen wrench



Masonry Drill Bits for use with Concrete Screws



IBS No.	Description	Qty
55335	5/32 X 5 Masonry Drill Bit	1
55336	5/32 X 7 Masonry Drill Bit	1
55337	3/16 X 5 Masonry Drill Bit	1
55338	3/16 X 7 Masonry Drill Bit	1



ANCHORS

Concrete Screws with Drills & Installation Kit (Z08) IBS No. 273P • 13 ITEMS • 253 PIECES



Concrete Screws with Drills & Installation Kit

Assortment No. 273P

<p>55309 1/4 X 2-1/4 HWH CONCRETE SCREW</p> 	<p>55316 3/16X2-1/4 PHIL FLT CONCRETE SCREW</p> 	<p>55336 5/32X7 SDS HEX CARBIDE DRILL Use with 3/16 Screws</p> 	<p>55330 TOOL KIT FOR CONCRETE SCREWS</p> 
<p>55308 1/4 X 1-3/4 HWH CONCRETE SCREW</p> 	<p>55315 3/16X1-3/4 PHIL FLT CONCRETE SCREW</p> 		<p>55338 3/16X7 SDS HEX CARBIDE DRILL Use with 1/4 Screws</p> 
<p>55307 1/4 X 1-1/4 HWH CONCRETE SCREW</p> 	<p>55314 3/16X1-1/4 PHIL FLT CONCRETE SCREW</p> 	<p>55317 3/16X2-3/4 PHIL FLT CONCRETE SCREW</p> 	<p>55324 1/4X2-3/4 PHIL FLT CONCRETE SCREW</p> 
<p>55300 3/16 X 1-1/4 HWH CONCRETE SCREW</p> 	<p>55310 1/4 X 2-3/4 HWH CONCRETE SCREW</p> 		

IBS, INCORPORATED

Assortments (Drawer & Bin) Z02 & Z06



Select-O-Sort Assortments

Select-O-Sorts are specially designed assortments which are unique for each customer. In these assortments the customer decides which products best suit their needs. Our standard assortments, while designed to fit a broad spectrum of customer needs, may not always be right for each customer. For more information on Select-O-Sorts, refer to your Administration Manual SM-201.

IBS No.	UNITS	CABINET
50200	36	36B
50201	40	40B
50202	42	42B
50203	56	56B
50204	72	72B
50205	30	18D
50206	50	18D
50207	12	DL-12C
50209	16	DL-16C
50211	20	DL-20C
50212	21	DL-21C
50213	24	DL-24C
50214	32	DL-32C
50216	ADJ	AD-H, AD-L, AD-E
50218	VARIES	DS (SMALL DRAWER)
50219	80	2 - 40B
50225	MISC	MISC

ASSORTMENTS





IBS, INCORPORATED

Assortment Drawers Z02

Large Drawers



















A
S
S
O
R
T
M
E
N
T
S

IBS, INCORPORATED

Assortments - Fasteners (A)



 Hex Flange Bolts				
Assortment No. 811R				
3198 1/4-20 FLANGE LOCK NUT GR.G PLN 	3110 1/4-20 X 3/4 GR8 HEX FLANGE BOLT PLN 	3111 1/4-20 X 1 GR8 HEX FLANGE BOLT PLN 	3112 1/4-20 X 1-1/4 GR8 HEX FLANGE BOLT PLN 	3113 1/4-20 X 1-1/2 GR8 HEX FLANGE BOLT PLN 
3199 5/16-18 FLANGE LOCK NUT GR.G PLN 	3120 5/16-18 X 3/4 GR8 HEX FLANGE BOLT PLN 	3121 5/16-18 X 1 GR8 HEX FLANGE BOLT PLN 	3122 5/16-18 X 1-1/4 GR8 HEX FLANGE BOLT PLN 	3123 5/16-18 X 1-1/2 GR8 HEX FLANGE BOLT PLN 
4000 3/8-16 FLANGE LOCK NUT GR.G PLN 	3200 3/8-16 X 1 GR8 HEX FLANGE BOLT PLN 	3201 3/8-16 X 1-1/4 GR8 HEX FLANGE BOLT PLN 	3202 3/8-16 X 1-1/2 GR8 HEX FLANGE BOLT PLN 	3204 3/8-16 X 2 GR8 HEX FLANGE BOLT PLN 

PRODUCT CATEGORY: A

Hex Flange Bolts

15 Items • 405 Pcs
IBS No. 811R



Packaged in a Locking Steel Drawer
for Easy Storage & Organization

ASSORTMENTS



IBS, INCORPORATED

Assortments - Hex Nuts (B)

ASSORTMENTS

IBS, Inc. SPECIALTY PRODUCTS FOR MAINTENANCE & REPAIR INDUSTRIALBOLT.COM © 9 0 800-678-1906		Machine Screw Nuts, Wing Nuts & Cap Nuts			
Assortment No. 126R					
5076 8-32 CAP NUT ZP 	5032 4-40 HEX MACHINE SCREW NUT ZP 	5036 10-32 HEX MACHINE SCREW NUT ZP 	5086 8-32 WING NUT ZP 	5089 1/4-20 WING NUT ZP 	
5077 10-24 CAP NUT ZP 	5033 6-32 HEX MACHINE SCREW NUT ZP 	5037 12-24 HEX MACHINE SCREW NUT ZP 	5087 10-24 WING NUT ZP 	5090 5/16-18 WING NUT ZP 	
5079 1/4-20 CAP NUT NP 	5034 8-32 HEX MACHINE SCREW NUT ZP 	5038 1/4-20 HEX MACHINE SCREW NUT 	5088 10-32 WING NUT ZP 	5091 3/8-16 WING NUT ZP 	
5080 5/16-18 CAP NUT NP 	5035 10-24 HEX MACHINE SCREW NUT ZP 	5039 5/16-18 HEX MACHINE SCREW NUT 			

PRODUCT CATEGORY: B

Machine Screw Nuts, Wing Nuts & Cap Nuts

18 Items • 1,225 Pcs

IBS No. 126R



Packaged in a Locking Steel Drawer
for Easy Storage & Organization

IBS, Inc. SPECIALTY PRODUCTS FOR MAINTENANCE & REPAIR INDUSTRIALBOLT.COM © 9 0 800-678-1906		Machine Screw Nuts & Washers			
Assortment No. 392R					
7100 #4 MEDIUM LOCKWASHER ZP 	7101 #6 MEDIUM LOCKWASHER ZP 	7102 #8 MEDIUM LOCKWASHER ZP 	7103 #10 MEDIUM LOCKWASHER ZP 	7104 #12 MEDIUM LOCKWASHER ZP 	7105 1/4 MEDIUM LOCKWASHER ZP
7044 #4 SAE FLAT WASHER ZP 	7045 #6 SAE FLAT WASHER ZP 	7046 #8 SAE FLAT WASHER ZP 	7047 #10 SAE FLAT WASHER ZP 	7048 #12 SAE FLAT WASHER ZP 	7049 1/4 SAE FLAT WASHER ZP
5032 4-40 HEX MACHINE SCREW NUT ZP 	5033 6-32 HEX MACHINE SCREW NUT ZP 	5034 8-32 HEX MACHINE SCREW NUT ZP 	5035 10-24 HEX MACHINE SCREW NUT ZP 	5036 10-32 HEX MACHINE SCREW NUT ZP 	5038 1/4-20 HEX MACHINE SCREW NUT
5037 12-24 HEX MACHINE SCREW NUT ZP 	5001 6-32 NYLOC NUT ZP 	5002 8-32 NYLOC NUT ZP 	5003 10-24 NYLOC NUT ZP 	6099 10-32 NYLOC NUT ZP 	5004 1/4-20 NYLOC NUT ZP

PRODUCT CATEGORY: B

Machine Screw Nuts & Washers

24 Items • 1,250 Pcs

IBS No. 392R



Packaged in a Locking Steel Drawer
for Easy Storage & Organization

IBS, INCORPORATED

Assortments - Washers (C)



IBS, Inc. SPECIALTY PRODUCTS FOR MAINTENANCE & REPAIR INDUSTRIALBOLT.COM • 800-878-1906		Heavy Duty Flat Washers		
Assortment No. 117R				
7303 7/16 HVY DUTY FLAT WASHER PLN 	7307 3/4 HVY DUTY FLAT WASHER PLN 			
7302 3/8 HVY DUTY FLAT WASHER PLN 	7306 5/8 HVY DUTY FLAT WASHER PLN 			
7301 5/16 HVY DUTY FLAT WASHER PLN 	7305 9/16 HVY DUTY FLAT WASHER PLN 	7309 1 HVY DUTY FLAT WASHER PLN 		
7300 1/4 HVY DUTY FLAT WASHER PLN 	7304 1/2 HVY DUTY FLAT WASHER PLN 	7308 7/8 HVY DUTY FLAT WASHER PLN 		

PRODUCT CATEGORY: C

Heavy Duty Flat Washers

10 Items • 330 Pcs
IBS No. 117R



Packaged in a Locking Steel Drawer for Easy Storage & Organization

IBS, Inc. SPECIALTY PRODUCTS FOR MAINTENANCE & REPAIR INDUSTRIALBOLT.COM • 800-878-1906		Fender Washers		
Assortment No. 320R				
7225 3/16 X 3/4 FENDER WASHER ZP 	7232 5/16 X 1-1/2 FENDER WASHER ZP 	7245 1/4 X 1-1/8 HVY DUTY FENDER WASHER ZP 		
7227 3/16 X 1-1/4 FENDER WASHER ZP 	7234 3/8 X 1-1/2 FENDER WASHER ZP 	7246 5/16 X 1-1/4 HVY DUTY FENDER WASHER ZP 		
7229 1/4 X 1 FENDER WASHER ZP 	7235 1/2 X 2 FENDER WASHER ZP 	7247 3/8 X 2 HVY DUTY FENDER WASHER ZP 		
7230 1/4 X 1-1/4 FENDER WASHER ZP 		7248 1/2 X 2 HVY DUTY FENDER WASHER ZP 		

PRODUCT CATEGORY: C

Fender Washers

11 Items • 650 Pcs
IBS No. 320R



Packaged in a Locking Steel Drawer for Easy Storage & Organization

IBS, Inc. SPECIALTY PRODUCTS FOR MAINTENANCE & REPAIR INDUSTRIALBOLT.COM • 800-878-1906		Sur-Lock Washers	
Assortment No. 698R			
7250 1/4 & M6 SUR-LOCK WASHER PAIR 	7251 5/16 & M8 SUR-LOCK WASHER PAIR 	7252 3/8 & M10 SUR-LOCK WASHER PAIR 	7253 7/16 & M11 SUR-LOCK WASHER PR
7254 1/2 & M12 SUR-LOCK WASHER PAIR 	7255 9/16 & M14 SUR-LOCK WASHER PR 	7256 5/8 & M16 SUR-LOCK WASHER PAIR 	7257 3/4 & M20 SUR-LOCK WASHER PAIR
7258 7/8 & M22 SUR-LOCK WASHER PAIR 	7259 1" & M24 SUR-LOCK WASHER PAIR 		

PRODUCT CATEGORY: C

Sur-Lock Washers

10 Items • 99 Pcs
IBS No. 698R



Packaged in a Locking Steel Drawer for Easy Storage & Organization

ASSORTMENTS



IBS, INCORPORATED

Assortments - Washers (C)



Internal and External Star Washers

Assortment No. 797R

Internal & External Star Washers

24 Items • 775 Pcs

IBS No. 797R



Packaged in a Locking Steel Drawer for Easy Storage & Organization

7162 #6 STAR WASHER INTERNAL ZP	7163 #8 STAR WASHER INTERNAL ZP	7164 #10 STAR WASH INTERNAL ZP	7165 #12 STAR WASHER INTERNAL ZP	7166 1/4 STAR WASHER INTERNAL ZP	7167 5/16 STAR WASHER INTERNAL ZP
7168 3/8 STAR WASHER INTERNAL ZP	7169 7/16 STAR WASHER INTERNAL ZP	7170 1/2 STAR WASHER INTERNAL ZP	7171 9/16 STAR WASHER INTERNAL ZP	7172 5/8 STAR WASHER INTERNAL ZP	7173 3/4 STAR WASHER INTERNAL ZP
7180 #6 STAR WASHER EXTERNAL ZP	7181 #8 STAR WASHER EXTERNAL ZP	7182 #10 STAR WASHER EXTERNAL ZP	7183 #12 STAR WASHER EXTERNAL ZP	7184 1/4 STAR WASHER EXTERNAL ZP	7185 5/16 STAR WASHER EXTERNAL ZP
7186 3/8 STAR WASHER EXTERNAL ZP	7187 7/16 STAR WASHER EXTERNAL ZP	7188 1/2 STAR WASHER EXTERNAL ZP	7189 9/16 STAR WASHER EXTERNAL ZP	7190 5/8 STAR WASHER EXTERNAL ZP	7191 3/4 STAR WASHER EXTERNAL ZP

PRODUCT CATEGORY: C

A
S
S
O
R
T
M
E
N
T
S



IBS, Inc. SPECIALTY PRODUCTS FOR MAINTENANCE & REPAIR INDUSTRIALBOLT.COM 8 8 8 800-678-1506						Phillips Pan Head Tapping Screws
						Assortment No. 113R
7693 6 X 3/8 PHIL PAN HD T/S ZP	7698 6 X 1" PHIL PAN HD T/S ZP	7717 8 X 1" PHIL PAN HD T/S ZP	7733 10 X 1-1/2 PHIL PAN HD T/S ZP	7748 12 X 1" PHIL PAN HD T/S ZP	7761 14 X 3/4 PHIL PAN HD T/S ZP	
7694 6 X 1/2 PHIL PAN HD T/S ZP	7713 8 X 1/2 PHIL PAN HD T/S ZP	7729 10 X 1/2 PHIL PAN HD T/S ZP	7735 10 X 1-1/2 PHIL PAN HD T/S ZP	7749 12 X 1-1/4 PHIL PAN HD T/S ZP	7763 14 X 1" PHIL PAN HD T/S ZP	
7695 6 X 5/8 PHIL PAN HD T/S ZP	7714 8 X 5/8 PHIL PAN HD T/S ZP	7730 10 X 5/8 PHIL PAN HD T/S ZP	7744 12 X 1/2 PHIL PAN HD T/S ZP	7750 12 X 1-1/2 PHIL PAN HD T/S ZP	7764 14 X 1-1/4 PHIL PAN HD T/S ZP	
7696 6 X 3/4 PHIL PAN HD T/S ZP	7715 8 X 3/4 PHIL PAN HD T/S ZP	7731 10 X 3/4 PHIL PAN HD T/S ZP	7746 12 X 3/4 PHIL PAN HD T/S ZP	7760 14 X 5/8 PHIL PAN HD T/S ZP	7765 14 X 1-1/2 PHIL PAN HD T/S ZP	

PRODUCT CATEGORY: E

Phillips Pan Head Tapping Screws

24 Items • 1500 Pcs
IBS No. 113R



Packaged in a Locking Steel Drawer for Easy Storage & Organization

IBS, Inc. SPECIALTY PRODUCTS FOR MAINTENANCE & REPAIR INDUSTRIALBOLT.COM 8 8 8 800-678-1506					Hex Washer Head Thread Cutting Screws Type "F"
					Assortment No. 150R
8207 8-32 X 1/2 HWH T/C TYPE F ZP	8209 8-32 X 3/4 HWH T/C TYPE F ZP	8211 8-32 x 1 HWH T/C TYPE F ZP	8214 10-24 X 1/2 HWH T/C TYPE F ZP	8215 10-24 X 5/8 HWH T/C TYPE F ZP	
Hex Size 1/4"	Hex Size 1/4"	Hex Size 1/4"	Hex Size 5/16"	Hex Size 5/16"	
8216 10-24 X 3/4 HWH T/C TYPE F ZP	8217 10-24 X 1 HWH T/C TYPE F ZP	8220 12-24 X 3/4 HWH T/C TYPE F ZP	8221 12-24 X 1 HWH T/C TYPE F ZP	8223 1/4-20 X 1/2 HWH T/C TYPE F ZP	
Hex Size 5/16"	Hex Size 5/16"	Hex Size 5/16"	Hex Size 5/16"	Hex Size 3/8"	
8225 1/4-20 X 3/4 HWH T/C TYPE F ZP	8226 1/4-20 X 1 HWH T/C TYPE F ZP	8227 1/4-20 X 1-1/4 HWH T/C TYPE F ZP	8229 5/16-18 X 3/4 HWH T/C TYPE F ZP	8230 5/16-18 X 1 HWH T/C TYPE F ZP	
Hex Size 3/8"	Hex Size 3/8"	Hex Size 3/8"	Hex Size 1/2"	Hex Size 1/2"	
8231 5/16-18 X 1-1/4 HWH T/C TYPE F ZP	8232 3/8-16 X 3/4 HWH T/C TYPE F ZP	8233 3/8-16 X 1 HWH T/C TYPE F ZP	8234 3/8-16 X 1-1/4 HWH T/C TYPE F ZP	8235 3/8-16 X 1-1/2 HWH T/C TYPE F ZP	
Hex Size 1/2"	Hex Size 9/16"	Hex Size 9/16"	Hex Size 9/16"	Hex Size 9/16"	

PRODUCT CATEGORY: E

Hex Washer Head Thread Cutting Screws Type "F"

20 Items • 380 Pcs
IBS No. 150R



Packaged in a Locking Steel Drawer for Easy Storage & Organization

IBS, Inc. SPECIALTY PRODUCTS FOR MAINTENANCE & REPAIR INDUSTRIALBOLT.COM 8 8 8 800-678-1506						Hex Washer Head Tapping Screws
						Assortment No. 152R
8097 6 X 1/4 SLTD HEX WASHER HD	8098 6 X 3/8 SLTD HEX WASHER HD	8099 6 X 1/2 SLTD HEX WASHER HD	8101 6 X 3/4 SLTD HEX WASHER HD	8102 6 X 1 SLTD HEX WASHER HD T/S	8160 14 X 3/4 SLTD HEX WASHER HD	
Hex Size 1/4"	Hex Size 1/4"	Hex Size 1/4"	Hex Size 1/4"	Hex Size 1/4"	Hex Size 3/8"	
8110 8 X 3/8 SLTD HEX WASHER HD	8111 8 X 1/2 SLTD HEX WASHER HD	8113 8 X 3/4 SLTD HEX WASHER HD	8114 8 X 1 SLTD HEX WASHER HD T/S	8115 8 X 1-1/4 SLTD HEX WASHER HD	8161 14 X 1 SLTD HEX WASHER HD T/S	
Hex Size 1/4"	Hex Size 1/4"	Hex Size 1/4"	Hex Size 1/4"	Hex Size 1/4"	Hex Size 3/8"	
8127 10 X 3/8 SLTD HEX WASHER HD	8128 10 X 1/2 SLTD HEX WASHER HD	8129 10 X 5/8 SLTD HEX WASHER HD	8130 10 X 3/4 SLTD HEX WASHER HD	8131 10 X 1 SLTD HEX WASHER HD T/S	8162 14 X 1-1/4 SLTD HEX WASHER HD	
Hex Size 5/16"	Hex Size 5/16"	Hex Size 5/16"	Hex Size 5/16"	Hex Size 5/16"	Hex Size 3/8"	
8133 10 X 1-1/2 SLTD HEX WASHER HD	8143 12 X 1/2 SLTD HEX WASHER HD	8145 12 X 3/4 SLTD HEX WASHER HD	8146 12 X 1 SLTD HEX WASHER HD T/S	8148 12 X 1-1/2 SLTD HEX WASHER HD	8163 14 X 1-1/2 SLTD HEX WASHER HD	
Hex Size 5/16"	Hex Size 5/16"	Hex Size 5/16"	Hex Size 5/16"	Hex Size 5/16"	Hex Size 3/8"	

PRODUCT CATEGORY: E

Slotted Hex Washer Head Tapping Screws

24 Items • 1,325 Pcs
IBS No. 152R



Packaged in a Locking Steel Drawer for Easy Storage & Organization



IBS, INCORPORATED

Assortments - Tapping Screws & Driver Bits (E)

ASSORTMENTS

IBS, Inc. SPECIALTY PRODUCTS FOR MAINTENANCE & REPAIR INDUSTRIALBOLT.COM • 800-678-1906		Square Bit Chart				Square Drive Pan Head Tapping Screws	
		NOTE: ALL - FOR SERRATED DR. & PH. POINTS - FOR SERRATED DR. & PH. POINTS - FOR SERRATED DR. & PH. POINTS - FOR SERRATED DR. & PH. POINTS				Assortment No. 162R	
7934 6 X 3/8 SQUARE DR PAN HD T/S	7938 6 X 1 SQUARE DR PAN HD T/S ZP	7950 8 X 1 SQUARE DR PAN HD T/S ZP	7965 10 X 1 SQUARE DR PAN HD T/S ZP	7980 12 X 1 SQUARE DR PAN HD T/S ZP	7994 14 X 3/4 SQUARE DR PAN HD T/S		
7935 6 X 1/2 SQUARE DR PAN HD T/S	7947 8 X 1/2 SQUARE DR PAN HD T/S	7962 10 X 1/2 SQUARE DR PAN HD T/S	7966 10 X 1-1/4 SQUARE DR PAN HD	7981 12 X 1-1/4 SQUARE DR PAN HD	7995 14 X 1 SQUARE DR PAN HD T/S ZP		
7936 6 X 5/8 SQUARE DR PAN HD T/S	7948 8 X 5/8 SQUARE DR PAN HD T/S	7963 10 X 5/8 SQUARE DR PAN HD T/S	7978 12 X 5/8 SQUARE DR PAN HD T/S	7982 12 X 1-1/2 SQUARE DR PAN HD	7996 14 X 1-1/4 SQUARE DR PAN HD		
7937 6 X 3/4 SQUARE DR PAN HD T/S	7949 8 X 3/4 SQUARE DR PAN HD T/S	7964 10 X 3/4 SQUARE DR PAN HD T/S	7979 12 X 3/4 SQUARE DR PAN HD T/S	7993 14 X 5/8 SQUARE DR PAN HD T/S	7997 14 X 1-1/2 SQUARE DR PAN HD		

PRODUCT CATEGORY: E

Square Drive Pan Head Tapping Screws
24 Items • 1250 Pcs
IBS No. 162R



Packaged in a Locking Steel Drawer for Easy Storage & Organization

IBS, Inc. SPECIALTY PRODUCTS FOR MAINTENANCE & REPAIR INDUSTRIALBOLT.COM • 800-678-1906		Phillips Bit Chart				Phillips Flat Head Tapping Screws	
		NOTE: ALL - FOR SERRATED DR. & PH. POINTS - FOR SERRATED DR. & PH. POINTS - FOR SERRATED DR. & PH. POINTS - FOR SERRATED DR. & PH. POINTS				Assortment No. 166R	
7785 6 X 3/8 PHIL FLAT HD T/S ZP	7790 6 X 1 PHIL FLAT HD T/S ZP	7807 8 X 1 PHIL FLAT HD T/S ZP	7820 10 X 3/4 PHIL FLAT HD T/S ZP	7834 12 X 3/4 PHIL FLAT HD T/S ZP	7847 14 X 3/4 PHIL FLAT HD T/S ZP		
7786 6 X 1/2 PHIL FLAT HD T/S ZP	7803 8 X 1/2 PHIL FLAT HD T/S ZP	7808 8 X 1-1/4 PHIL FLAT HD T/S ZP	7822 10 X 1 PHIL FLAT HD T/S ZP	7836 12 X 1 PHIL FLAT HD T/S ZP	7849 14 X 1 PHIL FLAT HD T/S ZP		
7787 6 X 5/8 PHIL FLAT HD T/S ZP	7804 8 X 5/8 PHIL FLAT HD T/S ZP	7818 10 X 1/2 PHIL FLAT HD T/S ZP	7823 10 X 1-1/4 PHIL FLAT HD T/S ZP	7837 12 X 1-1/4 PHIL FLAT HD T/S ZP	7850 14 X 1-1/4 PHIL FLAT HD T/S ZP		
7788 6 X 3/4 PHIL FLAT HD T/S ZP	7805 8 X 3/4 PHIL FLAT HD T/S ZP	7819 10 X 5/8 PHIL FLAT HD T/S ZP	7824 10 X 1-1/2 PHIL FLAT HD T/S ZP	7838 12 X 1-1/2 PHIL FLAT HD T/S ZP	7851 14 X 1-1/2 PHIL FLAT HD T/S ZP		

PRODUCT CATEGORY: E

Phillips Flat Head Tapping Screws
24 Items • 1550 Pcs
IBS No. 166R



Packaged in a Locking Steel Drawer for Easy Storage & Organization

IBS, Inc. SPECIALTY PRODUCTS FOR MAINTENANCE & REPAIR INDUSTRIALBOLT.COM • 800-678-1906		Serrated Hex Washer Head TEK/Drill Point Screws			
				Assortment No. 173R	
23630 8-18 X 1/2 HWH SERRATED TEK ZP HEX SIZE: 1/4"	23644 10-16 X 1/2 HWH SERRATED TEK ZP HEX SIZE: 5/16"	23654 12-14 X 5/8 HWH SERRATED TEK ZP HEX SIZE: 5/16"	23666 1/4-14 X 3/4 HWH SERRATED TEK ZP HEX SIZE: 3/8"		
23632 8-18 X 5/8 HWH SERRATED TEK ZP HEX SIZE: 1/4"	23646 10-16 X 5/8 HWH SERRATED TEK ZP HEX SIZE: 5/16"	23656 12-14 X 3/4 HWH SERRATED TEK ZP HEX SIZE: 5/16"	23668 1/4-14 X 1 HWH SERRATED TEK ZP HEX SIZE: 3/8"		
23636 8-18 X 3/4 HWH SERRATED TEK ZP HEX SIZE: 1/4"	23648 10-16 X 3/4 HWH SERRATED TEK ZP HEX SIZE: 5/16"	23658 12-14 X 1 HWH SERRATED TEK ZP HEX SIZE: 5/16"	23670 1/4-14 X 1-1/2 HWH SERRATED TEK ZP HEX SIZE: 3/8"		
23638 8-18 X 1 HWH SERRATED TEK ZP HEX SIZE: 1/4"	23650 10-16 X 1 HWH SERRATED TEK ZP HEX SIZE: 5/16"	23660 12-14 X 1-1/2 HWH SERRATED TEK ZP HEX SIZE: 5/16"	23672 1/4-14 X 2 HWH SERRATED TEK ZP HEX SIZE: 3/8"		

PRODUCT CATEGORY: E

Serrated HWH Tek/Drill Point Screws
16 Items • 900 Pcs
IBS No. 173R



Packaged in a Locking Steel Drawer for Easy Storage & Organization

IBS, INCORPORATED

Assortments - Tapping Screws & Driver Bits (E)



IBS, Inc. SPECIALTY PRODUCTS FOR MAINTENANCE & REPAIR INDUSTRIALBOLT.COM © 2013 800-678-1906		Phillips #2 Chart This list chart will help you match the screw size to the correct Phillips grade.			Stainless Steel Phillips Pan Head TEK Screws	
12740 6 X 1/2 PHIL PAN TEK SS	12741 6 X 3/4 PHIL PAN TEK SS	12742 6 X 1 PHIL PAN TEK SS	12745 8 X 1/2 PHIL PAN TEK SS	12746 8 X 3/4 PHIL PAN TEK SS	Assortment No. 310R	
12747 8 X 1 PHIL PAN TEK SS	12748 8 X 1-1/2 PHIL PAN TEK SS	12750 10 X 1/2 PHIL PAN TEK SS	12751 10 X 3/4 PHIL PAN TEK SS	12752 10 X 1 PHIL PAN TEK SS		
12753 10 X 1-1/2 PHIL PAN TEK SS	12755 12 X 3/4 PHIL PAN TEK SS	12756 12 X 1 PHIL PAN TEK SS	12757 12 X 1-1/4 PHIL PAN TEK SS	12758 12 X 1-1/2 PHIL PAN TEK SS		
12760 14 X 3/4 PHIL PAN TEK SS	12761 14 X 1 PHIL PAN TEK SS	12762 14 X 1-1/4 PHIL PAN TEK SS	12763 14 X 1-1/2 PHIL PAN TEK SS	12764 14 X 2 PHIL PAN TEK SS		

PRODUCT CATEGORY: E

Stainless Steel Phillips Pan Head TEK Screws

20 Items • 900 Pcs
IBS No. 310R



Packaged in a Locking Steel Drawer for Easy Storage & Organization

IBS, Inc. SPECIALTY PRODUCTS FOR MAINTENANCE & REPAIR INDUSTRIALBOLT.COM © 2013 800-678-1906		Stainless Steel Hex Washer Head TEK Screws			
12770 8 X 1/2 HWH TEK SS	12771 8 X 3/4 HWH TEK SS	12772 8 X 1 HWH TEK SS	12830 8 X 1-1/2 HWH TEK SS	Assortment No. 311R	
12774 10 X 1/2 HWH TEK SS	12775 10 X 3/4 HWH TEK SS	12776 10 X 1 HWH TEK SS	12778 10 X 1-1/2 HWH TEK SS		
12780 12 X 3/4 HWH TEK SS	12781 12 X 1 HWH TEK SS	12783 12 X 1-1/2 HWH TEK SS	12784 12 X 2 HWH TEK SS		
12788 14 X 3/4 HWH TEK SS	12786 14 X 1 HWH TEK SS	12788 14 X 1-1/2 HWH TEK SS	12789 14 X 2 HWH TEK SS		

PRODUCT CATEGORY: E

Stainless Steel HWH Tek Screws

16 Items • 550 Pcs
IBS No. 311R



Packaged in a Locking Steel Drawer for Easy Storage & Organization

IBS, Inc. SPECIALTY PRODUCTS FOR MAINTENANCE & REPAIR INDUSTRIALBOLT.COM © 2013 800-678-1906		Square Drive Pan Head TEK Screws			
8627 8 X 1/2 SQUARE DRIVE PN TEK ZP	8629 8 X 3/4 SQUARE DRIVE PN TEK ZP	Assortment No. 312R			
8630 8 X 1 SQUARE DRIVE PAN TEK ZP	8631 8 X 1-1/4 SQUARE DRIVE PAN TEK	8632 8 X 1-1/2 SQUARE DRIVE PAN TEK	8633 10 X 1/2 SQUARE DRIVE PAN TEK		
8635 10 X 3/4 SQUARE DRIVE PAN TEK	8636 10 X 1 SQUARE DRIVE PAN TEK ZP	8637 10 X 1-1/4 SQUARE DRIVE PAN	8638 10 X 1-1/2 SQUARE DRIVE PAN		
8640 12 X 3/4 SQUARE DRIVE PAN TEK	8641 12 X 1 SQUARE DRIVE PAN TEK ZP	8642 12 X 1-1/4 SQUARE DRIVE PAN	8643 12 X 1-1/2 SQUARE DRIVE PAN		

PRODUCT CATEGORY: E

Square Drive Pan Head Tek Screws

16 Items • 650 Pcs
IBS No. 312R



Packaged in a Locking Steel Drawer for Easy Storage & Organization

ASSORTMENTS



IBS, INCORPORATED

Assortments - Tapping Screws & Driver Bits (E)

ASSORTMENTS

IBS, Inc. SPECIALTY PRODUCTS FOR MAINTENANCE & REPAIR INDUSTRIALBOLT.COM © & © 800-678-1506					
Insert Driver Bits					
Assortment No. 641P					
MSH1/4 1/4 MAGNETIC NUT DRIVER	MSHL5/16 5/16 MAGNETIC NUT DRIVER	250-PB3 1/4 HEX PHILLIPS BITS #3	60-T20 1/4 HEX TORX 20	250R1 1/4 HEX SQ DRIVE #1	MBHL25225 1/4 X 2-1/4 MAG. DRIVER BIT
MSH5/16 5/16 MAGNETIC NUT DRIVER	MSHL3/8 3/8 MAGNETIC NUT DRIVER	250-PB11 #1 PHIL X 1-15/16 POWER BIT	60-T25 1/4 HEX TORX 25	250R2 1/4 HEX SQ DRIVE #2	133319 #2 GRABIT BIT
MSH3/8 3/8 MAGNETIC NUT DRIVER	250-PB1 1/4 HEX PHILLIPS BITS #1	250-PB12 #2 PHIL X 1-15/16 POWER BIT	60-T30 1/4 HEX TORX 30	250R3 1/4 HEX SQ DRIVE #3	133320 #3 GRABIT BIT
MSHL1/4 1/4 MAGNETIC NUT DRIVER	250-PB2 1/4 HEX PHILLIPS BIT #2	250-PB13 #3 PHIL X 1-15/16 POWER BIT	60-T40 1/4 HEX TORX 40	SSA-5 1/4 HEX-1/4 SQ DR 2-9/16" EXT	140341 COMBO QUICK CHANGE BIT HOLDER

PRODUCT CATEGORY: E

Insert Driver Bits

24 Items • 53 Pcs
IBS No. 641P



Packaged in a Locking Steel Drawer for Easy Storage & Organization

IBS, Inc. SPECIALTY PRODUCTS FOR MAINTENANCE & REPAIR INDUSTRIALBOLT.COM © & © 800-678-1506				
Hex Washer Head Tek Screws				
Assortment No. 709R				
8436 8-18 X 1/2 HEX WASHER HD TEK ZP	8438 8-18 X 3/4 HEX WASHER HD TEK ZP	8439 8-18 X 1 HEX WASHER HD TEK ZP	84390 8-18 X 1-1/4 HEX WASHER HD TEK ZP	84392 8-18 X 1-1/2 HEX WASHER HD TEK ZP
Hex Size: 1/4"	Hex Size: 1/4"	Hex Size: 1/4"	Hex Size: 1/4"	Hex Size: 1/4"
8440 10-16 X 1/2 HEX WASHER HD TEK ZP	8442 10-16 X 3/4 HEX WASHER HD TEK ZP	8443 10-16 X 1 HEX WASHER HD TEK ZP	84431 10-16 X 1-1/4 HEX WASHER HD TEK ZP	8445 10-16 X 1-1/2 HEX WASHER HD TEK ZP
Hex Size: 5/16"	Hex Size: 5/16"	Hex Size: 5/16"	Hex Size: 5/16"	Hex Size: 5/16"
8449 12-14 X 3/4 HEX WASHER HD TEK ZP	8450 12-14 X 1 HEX WASHER HD TEK ZP	84501 12-14 X 1-1/4 HEX WASHER HD TEK ZP	8451 12-14 X 1-1/2 HEX WASHER HD TEK ZP	84511 12-14 X 2 HEX WASHER HD TEK ZP
Hex Size: 5/16"	Hex Size: 5/16"	Hex Size: 5/16"	Hex Size: 5/16"	Hex Size: 5/16"
8452 1/4-14 X 3/4 HEX WASHER HD TEK ZP	8453 1/4-14 X 1 HEX WASHER HD TEK ZP	84531 1/4-14 X 1-1/4 HWH TEK ZP	8454 1/4-14 X 1-1/2 HEX WASHER HD TEK ZP	8455 1/4-14 X 2 HEX WASHER HD TEK ZP
Hex Size: 3/8"	Hex Size: 3/8"	Hex Size: 3/8"	Hex Size: 3/8"	Hex Size: 3/8"

PRODUCT CATEGORY: E

Hex Washer Head Tek Screws

20 Items • 1,075 Pcs
IBS No. 709R



Packaged in a Locking Steel Drawer for Easy Storage & Organization

IBS, Inc. SPECIALTY PRODUCTS FOR MAINTENANCE & REPAIR INDUSTRIALBOLT.COM © & © 800-678-1506		
Power Bits		
Assortment No. 712R		
133319 #2 GRABIT BIT	250SSP63 1/4 X 3 #6-8 SLOT POWER BIT	250SSP66 1/4x6 #6-8 SLOT POWER BIT
140341 COMBO QUICK CHANGE BIT HOLDER	250SSP83 1/4 X 3 #8-10 SLOT POWER BIT	250SSP106 1/4 X 6 #10-12 SLOT POWER BIT
250-PB11 #1 PHIL X 1-15/16 POWER BIT	250-PB31 #1 PHIL X 3-1/2 POWER BIT	250-PB61 #1 X 6 PHILLIPS POWER DRIVER
250-PB12 #2 PHIL X 1-15/16 POWER BIT	250-PB32 #2 PHIL X 3-1/2 POWER BIT	250-PB62 #2 X 6 PHILLIPS POWER DRIVER
250-PB13 #3 PHIL X 1-15/16 POWER BIT	250-PB33 #3 PHIL X 3-1/2 POWER BIT	250-PB63 #3 X 6 PHILLIPS POWER DRIVER
MBHL25225 1/4 X 2-1/4 MAG. DRIVER BIT	MBHL2530 1/4 X 3 MAG DRIVER BIT HOLDER	MBHL2560 1/4 X 6 MAG DRIVER BIT HOLDER

PRODUCT CATEGORY: E

Power Bits

17 Items • 31 Pcs
IBS No. 712R



Packaged in a Locking Steel Drawer for Easy Storage & Organization

IBS, INCORPORATED

Assortments - Tapping Screws & Driver Bits (E)



IBS, Inc.
SPECIALTY PRODUCTS FOR MAINTENANCE & REPAIR
INDUSTRIALBOLT.COM • 800-678-1906

Phillips Bit Chart

PHILLIPS BIT CHART
The back of each bit is marked with the size and length of the bit. The bit size is marked on the back of the bit.

Phillips Pan and Oval Head Tapping Screws - Black Oxide

Assortment 767R

A-16889 6 X 3/8 PHIL PAN HD T/S B/O	A-11917 6 X 1/2 PHIL PAN HD T/S B/O	A-11918 6 X 3/4 PHIL PAN HD T/S B/O	A-11919 6 X 1 PHIL PAN HD T/S B/O	A-10180 8 X 1/2 PHIL PAN HD T/S B/O	A-10181 8 X 3/4 PHIL PAN HD T/S B/O
A-10182 8 X 1 PHIL PAN HD T/S B/O	A-10183 8 X 1-1/4 PHIL PAN HD T/S B/O	A-12799 8 X 1-1/2 PHIL PAN HD T/S B/O	A-11921 10 X 1/2 PHIL PAN HD T/S B/O	A-11922 10 X 3/4 PHIL PAN HD T/S B/O	A-11923 10 X 1 PHIL PAN HD T/S B/O
A-11924 10 X 1-1/4 PHIL PAN HD T/S B/O	A-12800 10 X 1-1/2 PHIL PAN HD T/S B/O	A-12795 6 X 1-1/2 PHIL OVAL HD T/S B/O	A-12796 6 X 3/4 PHIL OVAL HD T/S B/O	A-12797 6 X 1 PHIL OVAL HD T/S B/O	A-10163 8 X 1/2 PHIL OVAL HD T/S B/O
A-10165 8 X 3/4 PHIL OVAL HD T/S B/O	A-10167 8 X 1 PHIL OVAL HD T/S B/O	A-10169 8 X 1-1/4 PHIL OVAL HD T/S B/O	A-11084 10 X 1/2 PHIL OVAL HD T/S B/O	A-11086 10 X 3/4 PHIL OVAL HD T/S B/O	A-11088 10 X 1 PHIL OVAL HD T/S B/O

PRODUCT CATEGORY: E

Phillips Pan & Oval Head Tapping Screws

Black Oxide

24 Items • 1,100 Pcs

IBS No. 767R



Packaged in a Locking Steel Drawer for Easy Storage & Organization

IBS, Inc.
SPECIALTY PRODUCTS FOR MAINTENANCE & REPAIR
INDUSTRIALBOLT.COM • 800-678-1906

Phillips Bit Chart

PHILLIPS BIT CHART
The back of each bit is marked with the size and length of the bit. The bit size is marked on the back of the bit.

Phillips Pan Head & K-Lath TEK Screws

Assortment No. 778R

8427 6-20 X 1/2 PHIL PAN HD TEK ZP	8426 6-20 X 3/4 PHIL PAN HD TEK ZP	8425 6-20 X 1 PHIL PAN HD TEK ZP	8428 8-18 X 1/2 PHIL PAN HD TEK ZP	8430 8-18 X 3/4 PHIL PAN HD TEK ZP
8431 8-18 X 1 PHIL PAN HD TEK ZP	8432 8-18 X 1-1/2 PHIL PAN HD TEK ZP	8433 10-16 X 1/2 PHIL PAN HD TEK ZP	8435 10-16 X 3/4 PHIL PAN HD TEK ZP	84351 10-16 X 1 PHIL PAN HD TEK ZP
8437 10-16 X 1-1/2 PHIL PAN HD TEK ZP	12790 8 X 1/2 PHIL K-LATH TEK ZP	12791 8 X 3/4 PHIL K-LATH TEK ZP	12792 8 X 1 PHIL K-LATH TEK ZP	12793 8 X 1-1/4 PHIL K-LATH TEK ZP
12794 8 X 1-5/8 PHIL K-LATH TEK ZP	12795 8 X 2 PHIL K-LATH TEK ZP			

PRODUCT CATEGORY: E

Phillips Pan Head & K-Lath Tek Screws

17 Items • 1,150 Pcs

IBS No. 778R



Packaged in a Locking Steel Drawer for Easy Storage & Organization

IBS, Inc.
SPECIALTY PRODUCTS FOR MAINTENANCE & REPAIR
INDUSTRIALBOLT.COM • 800-678-1906

Impact Torsion Phillips and Square Bits

Assortment No. 812R

21001 #1 PHILLIPS INSERT BIT	21004 #1 X 1-15/16 PHILLIPS POWER BIT	21007 #1 X 3-1/2 PHILLIPS POWER BIT	21010 #1 X 6 PHILLIPS POWER BIT
21002 #2 PHILLIPS INSERT BIT	21005 #2 X 1-15/16 PHILLIPS POWER BIT	21008 #2 X 3-1/2 PHILLIPS POWER BIT	21011 #2 X 6 PHILLIPS POWER BIT
21003 #3 PHILLIPS INSERT BIT	21006 #3 X 1-15/16 PHILLIPS POWER BIT	21009 #3 X 3-1/2 PHILLIPS POWER BIT	21012 #3 X 6 PHILLIPS POWER BIT
21017 #1 SQUARE INSERT BIT	21020 #1 X 1-15/16 SQUARE POWER BIT	21024 #1 X 3-1/2 SQUARE POWER BIT	21027 #1 X 6 SQUARE POWER BIT
21018 #2 SQUARE INSERT BIT	21021 #2 X 1-15/16 SQUARE POWER BIT	21025 #2 X 3-1/2 SQUARE POWER BIT	21028 #2 X 6 SQUARE POWER BIT
21019 #3 SQUARE INSERT BIT	21022 #3 X 1-15/16 SQUARE POWER BIT	21026 #3 X 3-1/2 SQUARE POWER BIT	21029 #3 X 6 SQUARE POWER BIT

PRODUCT CATEGORY: E

Impact Phillips & Square Bits

24 Items • 38 Pcs

IBS No. 812R



Packaged in a Locking Steel Drawer for Easy Storage & Organization

ASSORTMENTS









IBS, INCORPORATED

Assortments - Tapping Screws & Driver Bits (E)



Impact Torsion Torx
and Bit Holders

Assortment No. 813R

21031 T15 TORX INSERT BIT 	21037 T15 X 1-15/16 TORX POWER BIT 	21042 T15 X 3-1/2 TORX POWER BIT 	21047 T15 X 6 TORX POWER BIT 
21032 T20 TORX INSERT BIT 	21038 T20 X 1-15/16 TORX POWER BIT 	21043 T20 X 3-1/2 TORX POWER BIT 	21048 T20 X 6 TORX POWER BIT 
21033 T25 TORX INSERT BIT 	21039 T25 X 1-15/16 TORX POWER BIT 	21044 T25 X 3-1/2 TORX POWER BIT 	21049 T25 X 6 TORX POWER BIT 
21034 T30 TORX INSERT BIT 	21040 T30 X 1-15/16 TORX POWER BIT 	21045 T30 X 3-1/2 TORX POWER BIT 	21050 T30 X 6 TORX POWER BIT 
21035 T40 TORX INSERT BIT 	21041 T40 X 1-15/16 TORX POWER BIT 	21046 T40 X 3-1/2 TORX POWER BIT 	21051 T40 X 6 TORX POWER BIT 
21065 HEAVY DUTY MAGNETIC BIT AND SCREW HOLDER 	21066 COMBO QUICK CHANGE BIT HOLDER 3" 	21060 1/4 X 3 MAGNETIC DRIVER BIT HOLDER 	21061 1/4 X 6 MAGNETIC DRIVER BIT HOLDER 

PRODUCT CATEGORY: E

Impact Torsion Torx & Bit Holders

24 Items • 31 Pcs

IBS No. 813R



Packaged in a Locking Steel Drawer
for Easy Storage & Organization

A
S
S
O
R
T
M
E
N
T
S

IBS, INCORPORATED

Assortments - Machine Screws (G)



Slotted Round Head Machine Screws					
Assortment No. 105R					
5033 6-32 HEX MACHINE SCREW NUT ZP	5034 8-32 HEX MACHINE SCREW NUT ZP	5036 10-32 HEX MACHINE SCREW NUT ZP	5035 10-24 HEX MACHINE SCREW NUT ZP	9089 10-24 X 1-1/4 SLTD ROUND HD	9134 12-24 X 3/4 SLTD ROUND HD M/S
9044 6-32 X 1/2 SLTD ROUND HD M/S	9064 8-32 X 1/2 SLTD ROUND HD M/S	9108 10-32 X 1/2 SLTD ROUND HD M/S	9084 10-24 X 1/2 SLTD ROUND HD M/S	9090 10-24 X 1-1/2 SLTD ROUND HD	9136 12-24 X 1 SLTD ROUND HD M/S ZP
9046 6-32 X 3/4 SLTD ROUND HD M/S	9066 8-32 X 3/4 SLTD ROUND HD M/S	9110 10-32 X 3/4 SLTD ROUND HD M/S	9086 10-24 X 3/4 SLTD ROUND HD M/S	5037 12-24 HEX MACHINE SCREW NUT ZP	9137 12-24 X 1-1/4 SLTD ROUND HD
9048 6-32 X 1 SLTD ROUND HD M/S ZP	9068 8-32 X 1 SLTD ROUND HD M/S ZP	9112 10-32 X 1 SLTD ROUND HD M/S ZP	9088 10-24 X 1 SLTD ROUND HD M/S ZP	9132 12-24 X 1-1/2 SLTD ROUND HD M/S	9138 12-24 X 1-1/2 SLTD ROUND HD

PRODUCT CATEGORY: G

Phillips Pan Head Machine Screws & Nuts					
Assortment No. 169R					
5033 6-32 HEX MACHINE SCREW NUT ZP	5034 8-32 HEX MACHINE SCREW NUT ZP	5036 10-32 HEX MACHINE SCREW NUT ZP	5035 10-24 HEX MACHINE SCREW NUT ZP	9529 10-24 X 1-1/4 PHIL PAN HD M/S	9549 1/4-20 X 3/4 PHIL PAN HD M/S
9509 6-32 X 1/2 PHIL PAN HD M/S ZP	9516 8-32 X 1/2 PHIL PAN HD M/S ZP	9536 10-32 X 1/2 PHIL PAN HD M/S ZP	9524 10-24 X 1/2 PHIL PAN HD M/S ZP	9530 10-24 X 1-1/2 PHIL PAN HD M/S	9551 1/4-20 X 1 PHIL PAN HD M/S ZP
9511 6-32 X 3/4 PHIL PAN HD M/S ZP	9518 8-32 X 3/4 PHIL PAN HD M/S ZP	9538 10-32 X 3/4 PHIL PAN HD M/S ZP	9526 10-24 X 3/4 PHIL PAN HD M/S ZP	5038 1/4-20 HEX MACHINE SCREW NUT	9552 1/4-20 X 1-1/4 PHIL PAN HD
9512 6-32 X 1 PHIL PAN HD M/S ZP	9520 8-32 X 1 PHIL PAN HD M/S ZP	9540 10-32 X 1 PHIL PAN HD M/S ZP	9528 10-24 X 1 PHIL PAN HD M/S ZP	9547 1/4-20 X 1-1/2 PHIL PAN HD M/S	9553 1/4-20 X 1-1/2 PHIL PAN HD

PRODUCT CATEGORY: G

Stainless Steel Phillips Pan Head Machine Screws with Hex Nuts					
Assortment No. 194R					
11002 6-32 MACHINE SCREW NUT SS	11003 8-32 MACHINE SCREW NUT SS	11005 10-32 MACHINE SCREW NUT SS	11004 10-24 MACHINE SCREW NUT SS	12196 10-24 X 1-1/4 PHIL PAN M/S SS	12220 1/4-20 X 3/4 PHIL PAN M/S SS
12164 6-32 X 1/2 PHIL PAN M/S SS	12178 8-32 X 1/2 PHIL PAN M/S SS	12205 10-32 X 1/2 PHIL PAN M/S SS	12191 10-24 X 1/2 PHIL PAN M/S SS	12197 10-24 X 1-1/2 PHIL PAN M/S SS	12222 1/4-20 X 1 PHIL PAN M/S SS
12166 6-32 X 3/4 PHIL PAN M/S SS	12180 8-32 X 3/4 PHIL PAN M/S SS	12207 10-32 X 3/4 PHIL PAN M/S SS	12193 10-24 X 3/4 PHIL PAN M/S SS	11007 1/4-20 MACHINE SCREW NUT SS	12223 1/4-20 X 1-1/4 PHIL PAN M/S SS
12168 6-32 X 1 PHIL PAN M/S SS	12182 8-32 X 1 PHIL PAN M/S SS	12209 10-32 X 1 PHIL PAN M/S SS	12195 10-24 X 1 PHIL PAN M/S SS	12218 1/4-20 X 1-1/2 PHIL PAN M/S SS	12224 1/4-20 X 1-1/2 PHIL PAN M/S SS

PRODUCT CATEGORY: G

Slotted Round Head Machine Screws

24 Items • 2050 Pcs
IBS No. 105R



Packaged in a Locking Steel Drawer for Easy Storage & Organization

Phillips Pan Head Machine Screws & Nuts

24 Items • 1,525 Pcs
IBS No. 169R



Packaged in a Locking Steel Drawer for Easy Storage & Organization

Stainless Steel Phillips Flat Head Machine Screws

24 Items • 1,150 Pcs
IBS No. 194R



Packaged in a Locking Steel Drawer for Easy Storage & Organization

ASSORTMENTS



IBS, INCORPORATED

Assortments - Machine Screws (G)

ASSORTMENTS

IBS, Inc.		Phillips Flat Head Machine Screws				
SPECIALTY PRODUCTS FOR MAINTENANCE & REPAIR INDUSTRIALBOLT.COM © 2010 800-878-1986		Phillips Fit Chart		Assortment No. 391R		
9612 6-32 X 3/8 PHIL FLAT HD M/S ZP	9622 8-32 X 3/8 PHIL FLAT HD M/S ZP	9630 10-24 X 1/2 PHIL FLAT HD M/S	9638 10-32 X 1/2 PHIL FLAT HD M/S	9647 1/4-20 X 3/4 PHIL FLAT HD M/S		
9613 6-32 X 1/2 PHIL FLAT HD M/S ZP	9623 8-32 X 1/2 PHIL FLAT HD M/S ZP	9632 10-24 X 3/4 PHIL FLAT HD M/S	9640 10-32 X 3/4 PHIL FLAT HD M/S	9649 1/4-20 X 1 PHIL FLAT HD M/S ZP		
9615 6-32 X 3/4 PHIL FLAT HD M/S ZP	9625 8-32 X 3/4 PHIL FLAT HD M/S ZP	9634 10-24 X 1 PHIL FLAT HD M/S ZP	9642 10-32 X 1 PHIL FLAT HD M/S ZP	9651 1/4-20 X 1-1/2 PHIL FLAT HD M/S ZP		
9617 6-32 X 1 PHIL FLAT HD M/S ZP	9627 8-32 X 1 PHIL FLAT HD M/S ZP	9637 10-24 X 3/8 PHIL FLAT HD M/S	9645 1/4-20 X 1/2 PHIL FLAT HD M/S	9653 1/4-20 X 2 PHIL FLAT HD M/S ZP		

PRODUCT CATEGORY: G

Phillips Flat Head Machine Screws
20 Items • 1675 Pcs
IBS No. 391R



Packaged in a Locking Steel Drawer for Easy Storage & Organization

IBS, Inc.		Metric Phillips Pan Head Machine Screws				Flat Washers & Nuts	
SPECIALTY PRODUCTS FOR MAINTENANCE & REPAIR INDUSTRIALBOLT.COM © 2010 800-878-1986		Assortment No. 715R					
10713 M4-.7 X 10 PHIL PAN M/S ZP	10716 M4-.7 X 16 PHIL PAN M/S ZP	10718 M4-.7 X 20 PHIL PAN M/S ZP	10721 M4-.7 X 30 PHIL PAN M/S ZP	10564 M4 FLAT WASHER ZP	10599 M4-.7 FIN HEX NUT CL8 ZP		
602 M5-.8 X 10 PHIL PAN M/S ZP	604 M5-.8 X 16 PHIL PAN M/S ZP	606 M5-.8 X 20 PHIL PAN M/S ZP	608 M5-.8 X 30 PHIL PAN M/S ZP	10565 M5 FLAT WASHER ZP	10600 M5-.8 FIN HEX NUT CL8 ZP		
10730 M6-1.0 X 10 PHIL PAN M/S ZP	10733 M6-1.0 X 16 PHIL PAN M/S ZP	10735 M6-1.0 X 20 PHIL PAN M/S ZP	10738 M6-1.0 X 30 PHIL PAN M/S ZP	10566 M6 FLAT WASHER ZP	10601 M6-1.0 FIN HEX NUT CL8 ZP		
10750 M8-1.25 X 16 PHIL PAN M/S ZP	10752 M8-1.25 X 20 PHIL PAN M/S ZP	10754 M8-1.25 X 25 PHIL PAN M/S ZP	10755 M8-1.25 X 30 PHIL PAN M/S ZP	10568 M8 FLAT WASHER ZP	10603 M8-1.25 FIN HEX NUT CL8 ZP		

PRODUCT CATEGORY: G

Metric Phillips Pan Head Machine Screws, Flat Washers & Nuts

24 Items • 1,445 Pcs
IBS No. 715R



Packaged in a Locking Steel Drawer for Easy Storage & Organization

IBS, INCORPORATED

Assortments - Metric Fasteners (H)



 Metric Cap Screws & Nuts Class 8.8					
Assortment No. 122R					
10601 M6-1.0 FIN HEX NUT CL8 ZP	10603 M8-1.25 FIN HEX HUT CL8 ZP	10091 M8-1.25 X 40 HEX C/S 8.8 ZP	10605 M10-1.5 FIN HEX NUT CL8 ZP	10116 M10-1.5 X 40 HEX C/S 8.8 ZP	10606 M12-1.75 FIN HEX NUT CL8 ZP
10047 M6-1.0 X 30 HEX C/S 8.8 ZP	10086 M8-1.25 X 25 HEX C/S 8.8 ZP	10092 M8-1.25 X 50 HEX C/S 8.8 ZP	10111 M10-1.5 X 25 HEX C/S 8.8 ZP	10118 M10-1.5 X 50 HEX C/S 8.8 ZP	10140 M12-1.75 X 40 HEX C/S 8.8 ZP
10048 M6-1.0 X 35 HEX C/S 8.8 ZP	10089 M8-1.25 X 30 HEX C/S 8.8 ZP	10095 M8-1.25 X 60 HEX C/S 8.8 ZP	10114 M10-1.5 X 30 HEX C/S 8.8 ZP	10120 M10-1.5 X 60 HEX C/S 8.8 ZP	10142 M12-1.75 X 50 HEX C/S 8.8 ZP
10049 M6-1.0 X 40 HEX C/S 8.8 ZP	10090 M8-1.25 X 35 HEX C/S 8.8 ZP	10097 M8-1.25 X 70 HEX C/S 8.8 ZP	10115 M10-1.5 X 35 HEX C/S 8.8 ZP	10122 M10-1.5 X 70 HEX C/S 8.8 ZP	10144 M12-1.75 X 60 HEX C/S 8.8 ZP

PRODUCT CATEGORY: H

Metric 12.9 Socket Head Capscrews

24 Items • 440 Pcs
IBS No. 122R



Packaged in a Locking Steel Drawer for Easy Storage & Organization

 Metric 12.9 Socket Head Capscrews					
Assortment No. 266R					
816 M4 X 12 SOCKET HD C/S ALLOY	818 M4 X 16 SOCKET HD C/S ALLOY	820 M4 X 20 SOCKET HD C/S ALLOY	821 M4 X 25 SOCKET HD C/S ALLOY	822 M5 X 12 SOCKET HD C/S ALLOY	823 M5 X 16 SOCKET HD C/S ALLOY
823A M5 X 20 SOCKET HD C/S ALLOY	824 M5 X 25 SOCKET HD C/S ALLOY	824A M6 X 12 SOCKET HD C/S ALLOY	824B M6 X 16 SOCKET HD C/S ALLOY	824C M6 X 20 SOCKET HD C/S ALLOY	824D M6 X 25 SOCKET HD C/S ALLOY
825 M6 X 30 SOCKET HD C/S ALLOY	827 M6 X 40 SOCKET HD C/S ALLOY	829 M8 X 20 SOCKET HD C/S ALLOY	829A M8 X 25 SOCKET HD C/S ALLOY	830 M8 X 30 SOCKET HD C/S ALLOY	830A M8 X 35 SOCKET HD C/S ALLOY
831 M8 X 40 SOCKET HD C/S ALLOY	835 M10 X 20 SOCKET HD C/S ALLOY	835A M10 X 25 SOCKET HD C/S ALLOY	835B M10 X 30 SOCKET HD C/S ALLOY	835C M10 X 35 SOCKET HD C/S ALLOY	835D M10 X 40 SOCKET HD C/S ALLOY

PRODUCT CATEGORY: H

Metric 12.9 Socket Head Capscrews

24 Items • 475 Pcs
IBS No. 266R



Packaged in a Locking Steel Drawer for Easy Storage & Organization

 Metric 12.9 Flat Socket Head Cap Screws					
Assortment No. 267R					
84345 M4 X 12 FLAT SOCKET C/S ALLOY	84346 M4 X 16 FLAT SOCKET C/S ALLOY	84347 M4 X 20 FLAT SOCKET C/S ALLOY	84348 M4 X 25 FLAT SOCKET C/S ALLOY	84360 M5 X 12 FLAT SOCKET C/S ALLOY	84361 M5 X 16 FLAT SOCKET C/S ALLOY
84362 M5 X 20 FLAT SOCKET C/S ALLOY	84363 M5 X 25 FLAT SOCKET C/S ALLOY	84370 M6 X 12 FLAT SOCKET C/S ALLOY	84371 M6 X 16 FLAT SOCKET C/S ALLOY	84372 M6 X 20 FLAT SOCKET C/S ALLOY	84373 M6 X 25 FLAT SOCKET C/S ALLOY
84374 M6 X 30 FLAT SOCKET C/S ALLOY	84375 M6 X 40 FLAT SOCKET C/S ALLOY	84381 M8 X 20 FLAT SOCKET C/S ALLOY	84382 M8 X 25 FLAT SOCKET C/S ALLOY	84383 M8 X 30 FLAT SOCKET C/S 12.9	84384 M8 X 35 FLAT SOCKET C/S 12.9
84385 M8 X 40 FLAT SOCKET C/S ALLOY	84391 M10 X 20 FLAT SOCKET C/S ALLOY	84393 M10 X 25 FLAT SOCKET C/S ALLOY	84394 M10 X 30 FLAT SOCKET C/S ALLOY	84395 M10 X 35 FLAT SOCKET C/S ALLOY	84396 M10 X 40 FLAT SOCKET C/S 12.9

PRODUCT CATEGORY: H

Metric 12.9 Flat Socket Head Capscrews

24 Items • 435 Pcs
IBS No. 267R



Packaged in a Locking Steel Drawer for Easy Storage & Organization

























ASSORTMENTS



























IBS, INCORPORATED

Assortments - Metric Fasteners (H)





















ASSORTMENTS

IBS, Inc. SPECIALTY PRODUCTS FOR MAINTENANCE & REPAIR INDUSTRIALBOLT.COM © © © 950-670-1506						Stainless Steel Metric Socket Set Screws					
						Assortment No. 405R					
96900 M4 X 6 SOC SET SCREW SS  Hex Key: 2mm	96905 M5 X 6 SOC SET SCREW SS  Hex Key: 2.5mm	96910 M6 X 8 SOC SET SCREW SS  Hex Key: 3mm	96915 M8 X 10 SOC SET SCREW SS  Hex Key: 4mm	96920 M10 X 12 SOC SET SCREW SS  Hex Key: 5mm	96925 M12 X 16 SOC SET SCREW SS  Hex Key: 6mm						
96901 M4 X 8 SOC SET SCREW SS  Hex Key: 2mm	96906 M5 X 8 SOC SET SCREW SS  Hex Key: 2.5mm	96911 M6 X 10 SOC SET SCREW SS  Hex Key: 3mm	96916 M8 X 12 SOC SET SCREW SS  Hex Key: 4mm	96921 M10 X 16 SOC SET SCREW SS  Hex Key: 5mm	96926 M12 X 20 SOC SET SCREW SS  Hex Key: 6mm						
96902 M4 X 10 SOC SET SCREW SS  Hex Key: 2mm	96907 M5 X 10 SOC SET SCREW SS  Hex Key: 2.5mm	96912 M6 X 12 SOC SET SCREW SS  Hex Key: 3mm	96917 M8 X 16 SOC SET SCREW SS  Hex Key: 4mm	96922 M10 X 20 SOC SET SCREW SS  Hex Key: 5mm	96927 M12 X 25 SOC SET SCREW SS  Hex Key: 6mm						
96903 M4 X 12 SOC SET SCREW SS  Hex Key: 2mm	96908 M5 X 12 SOC SET SCREW SS  Hex Key: 2.5mm	96913 M6 X 16 SOC SET SCREW SS  Hex Key: 3mm	96918 M8 X 20 SOC SET SCREW SS  Hex Key: 4mm	96923 M10 X 25 SOC SET SCREW SS  Hex Key: 5mm	96928 M12 X 30 SOC SET SCREW SS  Hex Key: 6mm						

PRODUCT CATEGORY: H

IBS, Inc. SPECIALTY PRODUCTS FOR MAINTENANCE & REPAIR INDUSTRIALBOLT.COM © © © 950-670-1506						Metric JIS Flange Bolts					
						Assortment No. 779R					
10850 M6-1.0 X 12 JIS FLANGE BOLT ZP 10.9 	10851 M6-1.0 X 16 JIS FLANGE BOLT ZP 10.9 	10852 M6-1.0 X 20 JIS FLANGE BOLT ZP 10.9 	10856 M6-1.0 X 25 JIS FLANGE BOLT ZP 10.9 	10853 M6-1.0 X 30 JIS FLANGE BOLT ZP 10.9 	10854 M6-1.0 X 35 JIS FLANGE BOLT ZP 10.9 						
10855 M6-1.0 X 40 JIS FLANGE BOLT ZP 10.9 	10860 M8-1.25 X 12 JIS FLANGE BOLT ZP 10.9 	10861 M8-1.25 X 16 JIS FLANGE BOLT ZP 10.9 	10862 M8-1.25 X 20 JIS FLANGE BOLT ZP 10.9 	10863 M8-1.25 X 25 JIS FLANGE BOLT ZP 10.9 	10864 M8-1.25 X 30 JIS FLANGE BOLT ZP 10.9 						
10865 M8-1.25 X 35 JIS FLANGE BOLT ZP 10.9 	10866 M8-1.25 X 40 JIS FLANGE BOLT ZP 10.9 	10870 M10-1.25 X 16 JIS FLANGE BOLT ZP 10.9 	10871 M10-1.25 X 20 JIS FLANGE BOLT ZP 10.9 	10872 M10-1.25 X 25 JIS FLANGE BOLT ZP 10.9 	10873 M10-1.25 X 30 JIS FLANGE BOLT ZP 10.9 						
10874 M10-1.25 X 35 JIS FLANGE BOLT ZP 10.9 	10875 M10-1.25 X 40 JIS FLANGE BOLT ZP 10.9 	10877 M10-1.25 X 50 JIS FLANGE BOLT ZP 10.9 	10845 M6-1.0 JIS SERR FLANGE NUT ZP 	10843 M8-1.25 JIS SERR FLANGE NUT ZP 	10844 M10-1.25 JIS SERR FLANGE NUT ZP 						

PRODUCT CATEGORY: H

IBS, Inc. SPECIALTY PRODUCTS FOR MAINTENANCE & REPAIR INDUSTRIALBOLT.COM © © © 950-670-1506						Metric 10.9 Hex Flange Bolts - Zinc Plated					
						Assortment No. 810R					
30800 M6-1.0 HEX FLANGE NUT CL10 ZP 	30402 M6-1.0 X 16 HEX FLANGE BOLT 10.9 ZP 	30403 M6-1.0 X 20 HEX FLANGE BOLT 10.9 ZP 	30404 M6-1.0 X 25 HEX FLANGE BOLT 10.9 ZP 	30405 M6-1.0 X 30 HEX FLANGE BOLT 10.9 ZP 							
30801 M8-1.25 HEX FLANGE NUT CL10 ZP 	30510 M8-1.25 X 16 HEX FLANGE BOLT 10.9 ZP 	30511 M8-1.25 X 20 HEX FLANGE BOLT 10.9 ZP 	30512 M8-1.25 X 25 HEX FLANGE BOLT 10.9 ZP 	30513 M8-1.25 X 30 HEX FLANGE BOLT 10.9 ZP 							
30802 M10-1.5 HEX FLANGE NUT CL10 ZP 	30620 M10-1.5 X 20 HEX FLANGE BOLT 10.9 ZP 	30621 M10-1.5 X 25 HEX FLANGE BOLT 10.9 ZP 	30622 M10-1.5 X 30 HEX FLANGE BOLT 10.9 ZP 	30624 M10-1.5 X 40 HEX FLANGE BOLT 10.9 ZP 							
30803 M12-1.75 HEX FLANGE NUT CL10 ZP 	30730 M12-1.75 X 25 HEX FLANGE BOLT 10.9 ZP 	30731 M12-1.75 X 30 HEX FLANGE BOLT 10.9 ZP 	30733 M12-1.75 X 40 HEX FLANGE BOLT 10.9 ZP 	30735 M12-1.75 X 50 HEX FLANGE BOLT 10.9 ZP 							

PRODUCT CATEGORY: H

Stainless Steel Metric Socket Set Screws

24 Items • 206 Pcs
IBS No. 405R



Packaged in a Locking Steel Drawer for Easy Storage & Organization

Metric JIS Flange Bolts

24 Items • 595 Pcs
IBS No. 779R



Packaged in a Locking Steel Drawer for Easy Storage & Organization

Metric 10.9 Hex Flange Bolts Zinc Plated

20 Items • 515 Pcs
IBS No. 810R



Packaged in a Locking Steel Drawer for Easy Storage & Organization



IBS, Inc. SPECIALTY PRODUCTS FOR MAINTENANCE & REPAIR INDUSTRIALBOLT.COM © 2010 800-678-1906		Stainless Steel Phillips Oval Head Tapping Screws				Assortment No. 171R
Phillips fit Chart		PHILLIPS FIT CHART				
This chart will help you match the correct size for Stainless Phillips screws.		PHILLIPS FIT CHART				
12649 6 X 1/2 PHIL OVAL T/S SS	12653 6 X 1-1/4 PHIL OVAL T/S SS	12661 8 X 1 PHIL OVAL T/S SS	12669 10 X 3/4 PHIL OVAL T/S SS	12679 12 X 3/4 PHIL OVAL T/S SS	12689 14 X 3/4 PHIL OVAL T/S SS	
12650 6 X 5/8 PHIL OVAL T/S SS	12658 8 X 1/2 PHIL OVAL T/S SS	12662 8 X 1-1/4 PHIL OVAL T/S SS	12670 10 X 1 PHIL OVAL T/S SS	12680 12 X 1 PHIL OVAL T/S SS	12690 14 X 1 PHIL OVAL T/S SS	
12651 6 X 3/4 PHIL OVAL T/S SS	12659 8 X 5/8 PHIL OVAL T/S SS	12667 10 X 1/2 PHIL OVAL T/S SS	12671 10 X 1-1/4 PHIL OVAL T/S SS	12681 12 X 1-1/4 PHIL OVAL T/S SS	12691 14 X 1-1/4 PHIL OVAL T/S SS	
12652 6 X 1 PHIL OVAL T/S SS	12660 8 X 3/4 PHIL OVAL T/S SS	12668 10 X 5/8 PHIL OVAL T/S SS	12672 10 X 1-1/2 PHIL OVAL T/S SS	12682 12 X 1-1/2 PHIL OVAL T/S SS	12692 14 X 1-1/2 PHIL OVAL T/S SS	

PRODUCT CATEGORY: I

Stainless Steel Phillips Oval Head Tapping Screws

24 Items • 1,050 Pcs
IBS No. 171R



Packaged in a Locking Steel Drawer
for Easy Storage & Organization

IBS, Inc. SPECIALTY PRODUCTS FOR MAINTENANCE & REPAIR INDUSTRIALBOLT.COM © 2010 800-678-1906		Stainless Steel Phillips Pan Head Sheet Metal Screws				Assortment No. 195R
Phillips fit Chart		PHILLIPS FIT CHART				
This chart will help you match the correct size for Stainless Phillips screws.		PHILLIPS FIT CHART				
12528 6 X 3/8 PHIL PAN T/S SS	12532 6 X 1 PHIL PAN T/S SS	12541 8 X 1 PHIL PAN T/S SS	12550 10 X 1 PHIL PAN T/S SS	12560 12 X 1 PHIL PAN T/S SS	12569 14 X 3/4 PHIL PAN T/S SS	
12529 6 X 1/2 PHIL PAN T/S SS	12538 8 X 1/2 PHIL PAN T/S SS	12547 10 X 1/2 PHIL PAN T/S SS	12552 10 X 1-1/2 PHIL PAN T/S SS	12561 12 X 1-1/4 PHIL PAN T/S SS	12570 14 X 1 PHIL PAN T/S SS	
12530 6 X 5/8 PHIL PAN T/S SS	12539 8 X 5/8 PHIL PAN T/S SS	12548 10 X 5/8 PHIL PAN T/S SS	12557 12 X 1/2 PHIL PAN T/S SS	12562 12 X 1-1/2 PHIL PAN T/S SS	12571 14 X 1-1/4 PHIL PAN T/S SS	
12531 6 X 3/4 PHIL PAN T/S SS	12540 8 X 3/4 PHIL PAN T/S SS	12549 10 X 3/4 PHIL PAN T/S SS	12559 12 X 3/4 PHIL PAN T/S SS	12568 14 X 5/8 PHIL PAN T/S SS	12572 14 X 1-1/2 PHIL PAN T/S SS	

PRODUCT CATEGORY: I

Stainless Steel Phillips Pan Head Sheet Metal Screws

24 Items • 1,200 Pcs
IBS No. 195R



Packaged in a Locking Steel Drawer
for Easy Storage & Organization

IBS, Inc. SPECIALTY PRODUCTS FOR MAINTENANCE & REPAIR INDUSTRIALBOLT.COM © 2010 800-678-1906		Stainless Steel Square Drive Pan Head TEK Screws				Assortment No. 313R
Square fit Chart		SQUARE FIT CHART				
This chart will help you match the correct size for the proper Square Drive.		SQUARE FIT CHART				
12801 6 X 1/2 SQUARE DR PAN TEK	12802 6 X 3/4 SQUARE DR PAN TEK	12803 6 X 1 SQUARE DR PAN TEK SCREW	12805 8 X 1/2 SQUARE DR PAN TEK	12807 8 X 3/4 SQUARE DR PAN TEK		
12808 8 X 1 SQUARE DR PAN TEK SCREW	12810 8 X 1-1/2 SQUARE DR PAN TEK	12811 10 X 1/2 SQUARE DR PAN TEK	12813 10 X 3/4 SQUARE DR PAN TEK	12814 10 X 1 SQUARE DR PAN TEK		
12816 10 X 1-1/2 SQUARE DR PAN TEK	12817 10 X 2 SQUARE DR PAN TEK	12818 12 X 3/4 SQUARE DR PAN TEK	12819 12 X 1 SQUARE DR PAN TEK	12821 12 X 1-1/2 SQUARE DR PAN TEK		
12822 12 X 2 SQUARE DR PAN TEK	12823 14 X 3/4 SQUARE DR PAN TEK	12824 14 X 1 SQUARE DR PAN TEK	12826 14 X 1-1/2 SQUARE DR PAN TEK	12827 14 X 2 SQUARE DR PAN TEK		

PRODUCT CATEGORY: I

Stainless Steel Square Drive Pan Head Tek Screws

20 Items • 590 Pcs
IBS No. 313R



Packaged in a Locking Steel Drawer
for Easy Storage & Organization

ASSORTMENTS



IBS, INCORPORATED

Assortments - Stainless Steel Fasteners (I)

ASSORTMENTS

IBS, Inc. SPECIALTY PRODUCTS FOR MAINTENANCE & REPAIR INDUSTRIALBOLT.COM 8 8 8 800-678-1506					Stainless Steel Button Socket Security Machine Screws					Assortment No. 388R				
12850 6-32 X 1/2 SEC BS C/S SS 1/8 DRIVE	12851 6-32 X 3/4 SEC BS C/S SS 1/8 DRIVE	12852 6-32 X 1 SEC BS C/S SS 1/8 DRIVE	12853 8-32 X 1/2 SEC BS C/S SS 5/32 DRIVE	12854 8-32 X 3/4 SEC BS C/S SS 5/32 DRIVE	12855 8-32 X 1 SEC BS C/S SS 5/32 DRIVE	12857 10-24 X 1/2 SEC BS C/S SS 5/32 DRIVE	12859 10-24 X 3/4 SEC BS C/S SS 5/32 DRIVE	12860 10-24 X 1 SEC BS C/S SS 5/32 DRIVE	12863 10-32 X 1/2 SEC BS C/S SS 5/32 DRIVE	12865 10-32 X 3/4 SEC BS C/S SS 5/32 DRIVE	12866 10-32 X 1 SEC BS C/S SS 5/32 DRIVE	12871 1/4-20 X 3/4 SEC BS C/S SS 5/32 DRIVE	12872 1/4-20 X 1 SEC BS C/S SS 5/32 DRIVE	12874 1/4-20 X 1-1/2 SEC BS C/S SS 5/32 DRIVE
12880 10-24 SECURITY BREAKAWAY NUT	12881 1/4-20 SECURITY BREAKAWAY NUT		12945 1/8 HEX W/PIN 1/4 HEX DRIVER	12946 5/32 HEX W/PIN 1/4 HEX DRIVER										

PRODUCT CATEGORY: I

Stainless Steel Button Socket Security Machine Screws
 19 Items • 232 Pcs
 IBS No. 388R



Packaged in a Locking Steel Drawer for Easy Storage & Organization

IBS, Inc. SPECIALTY PRODUCTS FOR MAINTENANCE & REPAIR INDUSTRIALBOLT.COM 8 8 8 800-678-1506					Stainless Steel Button Socket Security Tapping Screws					Assortment No. 389R				
12900 6 X 3/8 SEC BS C/S SS 1/8 DRIVE	12901 6 X 1/2 SEC BS C/S SS 1/8 DRIVE	12902 6 X 3/4 SEC BS C/S SS 1/8 DRIVE	12903 6 X 1 SEC BS C/S SS 1/8 DRIVE	12904 8 X 3/8 SEC BS C/S SS 5/32 DRIVE	12905 8 X 1/2 SEC BS C/S SS 5/32 DRIVE	12906 8 X 3/4 SEC BS C/S SS 5/32 DRIVE	12907 8 X 1 SEC BS C/S SS 5/32 DRIVE	12908 8 X 1-1/4 SEC BS C/S SS 5/32 DRIVE	12909 8 X 1-1/2 SEC BS C/S SS 5/32 DRIVE	12910 10 X 1/2 SEC BS C/S SS 5/32 DRIVE	12911 10 X 3/4 SEC BS C/S SS 5/32 DRIVE	12912 10 X 1 SEC BS C/S SS 5/32 DRIVE	12913 10 X 1-1/4 SEC BS C/S SS 5/32 DRIVE	12914 10 X 1-1/2 SEC BS C/S SS 5/32 DRIVE
12915 10 X 2 SEC BS C/S SS 5/32 DRIVE			12945 1/8 HEX W/PIN 1/4 HEX DRIVER	12946 5/32 HEX W/PIN 1/4 HEX DRIVER										

PRODUCT CATEGORY: I

Stainless Steel Button Socket Security Tapping Screws
 18 Items • 162 Pcs
 IBS No. 389R



Packaged in a Locking Steel Drawer for Easy Storage & Organization

IBS, Inc. SPECIALTY PRODUCTS FOR MAINTENANCE & REPAIR INDUSTRIALBOLT.COM 8 8 8 800-678-1506					Stainless Steel Socket Head Cap Screws					Assortment No. 836R				
11501 6-32 X 1/2 SOCKET HD C/S SS	11503 6-32 X 1 SOCKET HD C/S SS	11504 8-32 X 1/2 SOCKET HD C/S SS	11505 8-32 X 3/4 SOCKET HD C/S SS	11506 8-32 X 1 SOCKET HD C/S SS	11512 10-24 X 1/2 SOCKET HD C/S SS	11513 10-24 X 3/4 SOCKET HD C/S SS	11514 10-24 X 1 SOCKET HD C/S SS	11520 10-32 X 1/2 SOCKET HD C/S SS	11521 10-32 X 3/4 SOCKET HD C/S SS	11522 10-32 X 1 SOCKET HD C/S SS	11526 1/4-20 X 1/2 SOCKET HD C/S SS	11528 1/4-20 X 3/4 SOCKET HD C/S SS	11530 1/4-20 X 1 SOCKET HD C/S SS	11532 1/4-20 X 1-1/2 SOCKET HD C/S SS
			11534 1/4-20 X 2 SOCKET HD C/S SS	11539 5/16-18 X 3/4 SOCKET HD C/S SS	11541 5/16-18 X 1 SOCKET HD C/S SS	11544 5/16-18 X 1-1/2 SOCKET HD C/S SS	11552 3/8-16 X 1 SOCKET HD C/S SS	11553 3/8-16 X 1-1/2 SOCKET HD C/S SS	11556 3/8-16 X 2 SOCKET HD C/S SS					

PRODUCT CATEGORY: I

Stainless Steel Socket Head Capscrews
 24 Items • 850 Pcs
 IBS No. 836R



Packaged in a Locking Steel Drawer for Easy Storage & Organization



IBS, Inc. SPECIALTY PRODUCTS FOR MAINTENANCE & REPAIR INDUSTRIALBOLTY.COM © & D 800-678-1906		Button Socket Head Screw Size Head Size		Stainless Steel Button Socket Cap Screws	
Assortment No. 837R					
11902 6-32 X 1/2 BUTTON SOCKET C/S SS	11903 6-32X 3/4 BUTTON SOCKET C/S SS	11904 6-32 X 1 BUTTON SOCKET C/S SS	11907 8-32 X 1/2 BUTTON SOCKET C/S SS	11908 8-32 X 3/4 BUTTON SOCKET C/S SS	11909 8-32 X 1 BUTTON SOCKET C/S SS
11912 10-24 X 1/2 BUTTON SOCKET C/S SS	11913 10-24 X 3/4 BUTTON SOCKET C/S SS	11914 10-24 X 1 BUTTON SOCKET C/S SS	11916 10-32 X 1/2 BUTTON SOCKET C/S SS	11917 10-32 X 3/4 BUTTON SOCKET C/S SS	11918 10-32 X 1 BUTTON SOCKET C/S SS
11920 1/4-20 X 1/2 BUTTON SOCKET C/S SS	11921 1/4-20 X 3/4 BUTTON SOCKET C/S SS	11922 1/4-20 X 1 BUTTON SOCKET C/S SS	11924 1/4-20 X 1-1/2 BUTTON SOCKET C/S SS	11926 5/16-18 X 3/4 BUTTON SOCKET C/S SS	11927 5/16-18 X 1 BUTTON SOCKET C/S SS
11928 5/16-18 X 1-1/4 BUTTON SOCKET C/S SS	11929 5/16-18 X 1-1/2 BUTTON SOCKET C/S SS	11931 3/8-16 X 3/4 BUTTON SOCKET C/S SS	11932 3/8-16 X 1 BUTTON SOCKET C/S SS	11933 3/8-16 X 1-1/4 BUTTON SOCKET C/S SS	11934 3/8-16 X 1-1/2 BUTTON SOCKET C/S SS

PRODUCT CATEGORY: I

Stainless Steel Button Socket Head Capcrews

24 Items • 1060 Pcs
IBS No. 837R



Packaged in a Locking Steel Drawer
for Easy Storage & Organization

IBS, Inc. SPECIALTY PRODUCTS FOR MAINTENANCE & REPAIR INDUSTRIALBOLTY.COM © & D 800-678-1906		Flat Socket Screw Size Head Size		Stainless Steel Flat Socket Cap Screws	
Assortment No. 838R					
11952 6-32 X 1/2 FLAT SOCKET C/S SS	11953 6-32X 3/4 FLAT SOCKET C/S SS	11954 6-32 X 1 FLAT SOCKET C/S SS	11957 8-32 X 1/2 FLAT SOCKET C/S SS	11958 8-32 X 3/4 FLAT SOCKET C/S SS	11959 8-32 X 1 FLAT SOCKET C/S SS
11962 10-24 X 1/2 FLAT SOCKET C/S SS	11963 10-24 X 3/4 FLAT SOCKET C/S SS	11964 10-24 X 1 FLAT SOCKET C/S SS	11966 10-32 X 1/2 FLAT SOCKET C/S SS	11967 10-32 X 3/4 FLAT SOCKET C/S SS	11968 10-32 X 1 FLAT SOCKET C/S SS
11970 1/4-20 X 1/2 FLAT SOCKET C/S SS	11971 1/4-20 X 3/4 FLAT SOCKET C/S SS	11972 1/4-20 X 1 FLAT SOCKET C/S SS	11974 1/4-20 X 1-1/2 FLAT SOCKET C/S SS	11976 5/16-18 X 3/4 FLAT SOCKET C/S SS	11977 5/16-18 X 1 FLAT SOCKET C/S SS
11978 5/16-18 X 1-1/4 FLAT SOCKET C/S SS	11979 5/16-18 X 1-1/2 FLAT SOCKET C/S SS	11981 3/8-16 X 3/4 FLAT SOCKET C/S SS	11982 3/8-16 X 1 FLAT SOCKET C/S SS	11983 3/8-16 X 1-1/4 FLAT SOCKET C/S SS	11984 3/8-16 X 1-1/2 FLAT SOCKET C/S SS

PRODUCT CATEGORY: I

Stainless Steel Flat Socket Head Capscrews

24 Items • 1080 Pcs
IBS No. 838R



Packaged in a Locking Steel Drawer
for Easy Storage & Organization

IBS, Inc. SPECIALTY PRODUCTS FOR MAINTENANCE & REPAIR INDUSTRIALBOLTY.COM © & D 800-678-1906		Fender Washers Stainless Steel	
Assortment No. 850R			
12074 10 X 1 FENDER WASHER SS	12075 1/4 X 1 FENDER WASHER SS	12076 1/4 X 1-1/4 FENDER WASHER SS	
12077 1/4 X 1-1/2 FENDER WASHER SS	12078 1/4 X 2 FENDER WASHER SS	12079 5/16 X 1 FENDER WASHER SS	
12080 5/16 X 1-1/2 FENDER WASHER SS	12081 5/16 X 2 FENDER WASHER SS	12082 3/8 X 1-1/2 FENDER WASHER SS	
12083 3/8 X 2 FENDER WASHER SS	12084 1/2 X 2 FENDER WASHER SS		

PRODUCT CATEGORY: I

Stainless Steel Fender Washers

11 Items • 345 Pcs
IBS No. 850R



Packaged in a Locking Steel Drawer
for Easy Storage & Organization

ASSORTMENTS



IBS, INCORPORATED

Assortments - Stainless Steel Fasteners (I)

ASSORTMENTS

IBS, Inc. SPECIALTY PRODUCTS FOR MAINTENANCE & REPAIR INDUSTRIALBOLTY.COM © © 800-678-1906						Cotter Pins
Assortment No. 125R						
13469 1/16 X 1 COTTER PIN ZP 	13471 1/16 X 1-1/2 COTTER PIN ZP 	13473 1/16 X 2 COTTER PIN ZP 	13481 3/32 X 1 COTTER PIN ZP 	13483 3/32 X 1-1/2 COTTER PIN ZP 	13577 1/4 X 3 COTTER PIN ZP 	
13485 3/32 X 2 COTTER PIN ZP 	13532 5/32 X 1 COTTER PIN ZP 	13534 5/32 X 1-1/2 COTTER PIN ZP 	13505 1/8 X 1 COTTER PIN ZP 	13507 1/8 X 1-1/2 COTTER PIN ZP 	13512 1/8 X 3 COTTER PIN ZP 	
13509 1/8 X 2 COTTER PIN ZP 	13536 5/32 X 2 COTTER PIN ZP 	13539 5/32 X 3 COTTER PIN ZP 	13558 3/16 X 1 COTTER PIN ZP 	13560 3/16 X 1-1/2 COTTER PIN ZP 	13565 3/16 X 3 COTTER PIN ZP 	
13562 3/16 X 2 COTTER PIN ZP 	13572 1/4 X 1-1/2 COTTER PIN ZP 	13574 1/4 X 2 COTTER PIN ZP 	13602 5/16 X 2 COTTER PIN ZP 	13616 3/8 X 2 COTTER PIN ZP 	13618 3/8 X 2-1/2 COTTER PIN ZP 	

PRODUCT CATEGORY: K

Cotter Pins
24 Items • 1,545 Pcs
IBS No. 125R



Packaged in a Locking Steel Drawer
for Easy Storage & Organization

IBS, Inc. SPECIALTY PRODUCTS FOR MAINTENANCE & REPAIR INDUSTRIALBOLTY.COM © © 800-678-1906						Clevis Pins
Assortment No. 132R						
13831 3/16 X 3/4 CLEVIS PIN 	13832 3/16 X 1 CLEVIS PIN 	13837 3/16 X 1-1/2 CLEVIS PIN 	13843 1/4 X 1 CLEVIS PIN 	13848 1/4 X 1-1/2 CLEVIS PIN 	13911 1/4 X 2 UNIVERSAL CLEVIS PIN 	
13851 5/16 X 1 CLEVIS PIN 	13856 5/16 X 1-1/2 CLEVIS PIN 	13859 5/16 X 2 CLEVIS PIN 	13867 3/8 X 1-1/2 CLEVIS PIN 	13870 3/8 X 2 CLEVIS PIN 	13915 5/16 X 2 UNIV CLEVIS PIN 	
13873 3/8 X 2-1/2 CLEVIS PIN 	13881 7/16 X 1-1/2 CLEVIS PIN 	13884 7/16 X 2 CLEVIS PIN 	13892 1/2 X 1-1/2 CLEVIS PIN 	13895 1/2 X 2 CLEVIS PIN 	13918 3/8 X 2 UNIVERSAL CLEVIS PIN 	
13898 1/2 X 2-1/2 CLEVIS PIN 	13902 5/8 X 1-1/2 CLEVIS PIN 	13904 5/8 X 2 CLEVIS PIN 	13922 7/16 X 2-1/2 UNIV CLEVIS PIN 	13928 1/2 X 3 UNIV CLEVIS PIN 	13932 5/8 X 3 UNIV CLEVIS PIN 	

PRODUCT CATEGORY: K

Clevis Pins
24 Items • 129 Pcs
IBS No. 132R



Packaged in a Locking Steel Drawer
for Easy Storage & Organization

IBS, INCORPORATED

Assortments - Rings & Pins (K)



Female Rod Ends, Yoke Ends, Clevis Pins, Cotter Pins & Jam Nuts			
Assortment No. 142R			
A-12034 10-32 RH F. BALL JOINT W/STUD 	A-10737 1/4-28 DROP FORGED-ADJ YOKE END 	13843 1/4 X 1 CLEVIS PIN 	13480 3/32 X 3/4 COTTER PIN ZP 5036 10-32 HEX MACHINE SCREW NUT ZP
A-12035 1/4-28 RH F. BALL JOINT W/STUD 	A-10738 5/16-24 DROP FORG-ADJ YOKE END 	13854 5/16 X 1-1/4 CLEVIS PIN 	13805 1/8 X 1 COTTER PIN ZP 6085 1/4-28 HEX JAM NUT NF ZP
A-12036 5/16-24 RH F. BALL JOINT 	A-10739 3/8-24 DROP FORGED ADJ YOKE END 	13865 3/8 X 1-1/4 CLEVIS PIN 	13532 5/32 X 1 COTTER PIN ZP 6086 5/16-24 HEX JAM NUT NF ZP
A-12037 3/8-24 RH F. BALL JOINT W/STUD 	A-10741 1/2-20 DROP FORGED ADJ YOKE END 	13891 1/2 X 1-3/8 CLEVIS PIN 	13532 5/32 X 1 COTTER PIN ZP 6087 3/8-24 HEX JAM NUT NF ZP

PRODUCT CATEGORY: K

Female Rod Ends, Yoke Ends, Clevis Pins, Cotter Pins & Jam Nuts

20 Items • 247 Pcs
IBS No. 142R



Packaged in a Locking Steel Drawer for Easy Storage & Organization

Woodruff Keys					
Assortment No. 148R					
13951 #2 3/32 X 1/2 WOODRUFF KEY 	13957 #7 1/8 X 3/4 WOODRUFF KEY 	13956 #61 3/16 X 5/8 WOODRUFF KEY 	13971 #16 3/16 X 1-1/8 WOODRUFF KEY 	13968 #15 1/4 X 1 WOODRUFF KEY 	13974 #C 5/16 X 1-1/8 WOODRUFF KEY
13953 #4 3/32 X 5/8 WOODRUFF KEY 	13955 #6 5/32 X 5/8 WOODRUFF KEY 	13959 #9 3/16 X 3/4 WOODRUFF KEY 	13975 #19 3/16 X 1-1/4 WOODRUFF KEY 	13973 #18 1/4 X 1-1/8 WOODRUFF KEY 	13983 #D 5/16 X 1-1/4 WOODRUFF KEY
13952 #3 1/8 X 1/2 WOODRUFF KEY 	13958 #8 5/32 X 3/4 WOODRUFF KEY 	13962 #11 3/16 X 7/8 WOODRUFF KEY 	13960 #91 1/4 X 3/4 WOODRUFF KEY 	13977 #21 1/4 X 1-1/4 WOODRUFF KEY 	13970 #152 3/8 X 1 WOODRUFF KEY
13954 #5 1/8 X 5/8 WOODRUFF KEY 	13961 #10 5/32 X 7/8 WOODRUFF KEY 	13966 #13 3/16 X 1 WOODRUFF KEY 	13964 #A 1/4 X 7/8 WOODRUFF KEY 	13969 #B 5/16 X 1 WOODRUFF KEY 	13978 #22 1/4 X 1-3/8 WOODRUFF KEY

PRODUCT CATEGORY: K

Woodruff Keys

24 Items • 185 Pcs
IBS No. 148R



Packaged in a Locking Steel Drawer for Easy Storage & Organization

Cotter Pins Large Diameter Long Length	
Assortment No. 155R	
13646 1/2 X 6 COTTER PIN ZP 	13645 1/2 X 5 COTTER PIN ZP
13624 3/8 X 6 COTTER PIN ZP 	13643 1/2 X 4 COTTER PIN ZP
13623 3/8 X 5 COTTER PIN ZP 	13579 1/4 X 4 COTTER PIN ZP
13621 3/8 X 4 COTTER PIN ZP 	13581 1/4 X 5 COTTER PIN ZP
13605 5/16 X 3 COTTER PIN ZP 	13609 5/16 X 5 COTTER PIN ZP
13641 1/2 X 3 COTTER PIN ZP 	13604 5/16 X 2-1/2 COTTER PIN ZP 13607 5/16 X 4 COTTER PIN ZP

PRODUCT CATEGORY: K

Cotter Pins

Large Diameter, Long Length

13 Items • 115 Pcs
IBS No. 155R



Packaged in a Locking Steel Drawer for Easy Storage & Organization



IBS, INCORPORATED

Assortments - Rings & Pins (K)

ASSORTMENTS

IBS, Inc. <small>SPECIALTY PRODUCTS FOR MAINTENANCE & REPAIR INDUSTRIALMOLTY.COM • • • 800-679-1506</small>								"E" Clips Regular & Reinforced
								Assortment No. 161R
A-8824 1/16 E-CLIP RETAINING RING	A-8825 3/32 E-CLIP RETAINING RING	A-8826 1/8 E-CLIP RETAINING RING	A-10130 9/64 E-CLIP RETAINING RING	A-10131 5/32 E-CLIP RETAINING RING	A-10132 11/64 E-CLIP RETAINING RING	A-8827 3/16 E-CLIP RETAINING RING	A-10133 7/32 E-CLIP RETAINING RING	
A-8828 1/4 E-CLIP RETAINING RING	A-8824 5/16 E-CLIP RETAINING RING	A-8829 3/8 E-CLIP RETAINING RING	A-8830 7/16 E-CLIP RETAINING RING	A-5602 1/2 E-CLIP RETAINING RING	A-5603 5/8 E-CLIP RETAINING RING	A-8831 3/4 E-CLIP RETAINING RING	A-8832 7/8 E-CLIP RETAINING RING	
A-8833 1" E-CLIP RETAINING RING						A-3165 1/8 HVY E-CLIP RETAINING RING	A-10134 5/32 HVY E-CLIP RETAINING RING	
A-3166 3/16 HVY E-CLIP RETAINING RING	A-10135 7/32 HVY E-CLIP RETAINING RING	A-3167 1/4 HVY E-CLIP RETAINING RING	A-3628 5/16 HVY E-CLIP RETAINING RING	A-5600 3/8 HVY E-CLIP RETAINING RING	A-2672 7/16 HVY E-CLIP RETAINING RING	A-8837 1/2 HVY E-CLIP RETAINING RING	A-5601 9/16 HVY E-CLIP RETAINING RING	

PRODUCT CATEGORY: K

"E" Clips
Regular & Reinforced
27 Items • 1345 Pcs
IBS No. 161R



Packaged in a Locking Steel Drawer
for Easy Storage & Organization

IBS, Inc. <small>SPECIALTY PRODUCTS FOR MAINTENANCE & REPAIR INDUSTRIALMOLTY.COM • • • 800-679-1506</small>								Internal and External Retaining Rings
								Assortment No. 163R
A-8701 1/4 EXTERNAL SNAP RING	A-8702 5/16 EXT SNAP RING	A-8703 3/8 EXT SNAP RING	A-8704 7/16 EXT SNAP RING	A-8705 1/2 EXT SNAP RING	A-8706 9/16 EXT SNAP RING	A-8707 5/8 EXT SNAP RING	A-10120 11/16 EXT. SNAP RING	
A-8708 3/4 EXT SNAP RING	A-10121 13/16 EXT E-CLIP RETAINING RIN	A-8709 7/8 EXT SNAP RING	A-10122 15/16 EXT. SNAP RING	A-8710 1" EXTERNAL SNAP RING	A-10123 1-1/16 EXT. SNAP RING	A-8711 1-1/8 EXT SNAP RING	A-10124 1-3/16 EXT. SNAP RING	
A-8712 1-1/4 EXT SNAP RING	A-8688 1/4 INT SNAP RING	A-8689 5/16 INTERNAL SNAP RING	A-8690 3/8 INT SNAP RING	A-8691 7/16 INT SNAP RING	A-8692 1/2 INTERNAL SNAP RING	A-8693 9/16 INT SNAP RING	A-8694 5/8 INT SNAP RING	
A-8695 3/4 INT SNAP RING	A-8696 7/8 INT SNAP RING	A-8697 1 INT SNAP RING	A-8698 1-1/8 INTERNAL SNAP RING	A-8699 1-1/4 INT SNAP RING				

PRODUCT CATEGORY: K

**Internal & External
Retaining Rings**
29 Items • 410 Pcs
IBS No. 163R



Packaged in a Locking Steel Drawer
for Easy Storage & Organization

IBS, Inc. <small>SPECIALTY PRODUCTS FOR MAINTENANCE & REPAIR INDUSTRIALMOLTY.COM • • • 800-679-1506</small>								Standard O-Rings
								Assortment No. 164R
15545 #006 1/16 WL 1/8 ID O-RNG	15549 #010 1/16 WL 1/4 ID O-RNG	15558 #111 3/32 WL 7/16 ID O-RNG	15562 #115 3/32 WL 11/16 ID O-RNG	15566 #212 1/8 WL 7/8 ID O-RNG	15570 #216 1/8 WL 1-1/8 ID O-RNG	15574 #220 1/8 WL 1-3/8 ID O-RNG	15600 #326 3/16 WL 1- 5/8 ID O-RNG	
15546 #007 1/16 WL 5/32 ID O-RNG	15550 #011 1/16WL 5/16ID X 7/16OD	15559 #112 3/32 WL 1/2 ID O-RNG	15563 #116 3/32 WL 3/4 ID O-RNG	15567 #213 1/8 WL 15/16 ID O-RNG	15571 #217 1/8 WL 1- 3/16 ID O-RNG	15575 #221 1/8 WL 1- 7/16 ID O-RNG	15607 #327 3/16 WL 1- 3/4 ID O-RNG	
15547 #008 1/16 WL 3/16 ID O-RNG	15551 #012 1/16 WL 3/8 ID O-RNG	15560 #113 3/32 WL 9/16 ID O-RNG	15564 #210 1/8 WL 3/4 ID O-RNG	15568 #214 1/8 WL 1 ID O-RNG	15572 #218 1/8 WL 1-1/4 ID O-RNG	15576 #222 1/8 WL 1-1/2 ID O-RNG		
15548 #009 1/16 WL 7/32 ID O-RNG	15557 #110 3/32 WL 3/8 ID O-RNG	15561 #114 3/32 WL 5/8 ID O-RNG	15565 #211 1/8 WL 13/16 ID O-RNG	15569 #215 1/8 WL 1- 1/16 ID O-RNG	15573 #219 1/8 WL 1- 5/16 ID O-RNG	15605 #325 3/16 WL 1- 1/2 ID O-RNG		

PRODUCT CATEGORY: K

Standard O-Rings
30 Items • 805 Pcs
IBS No. 164R



Packaged in a Locking Steel Drawer
for Easy Storage & Organization

IBS, INCORPORATED

Assortments - Rings & Pins (K)



IBS, Inc. SPECIALTY PRODUCTS FOR MAINTENANCE & REPAIR INDUSTRIALBOLT.COM © 2010 800-678-1996						Roll Pins
						Assortment No. 165R
13652 1/16 X 1/4 ROLL PIN ZP	13655 1/16 X 1/2 ROLL PIN ZP	13658 1/16 X 3/4 ROLL PIN ZP	13663 5/64 X 1/4 ROLL PIN ZP	13666 5/64 X 1/2 ROLL PIN ZP	13669 5/64 X 3/4 ROLL PIN ZP	
13679 3/32 X 3/8 ROLL PIN ZP	13683 3/32 X 3/4 ROLL PIN ZP	13685 3/32 X 1 ROLL PIN ZP	13690 1/8 X 3/8 ROLL PIN ZP	13696 1/8 X 1 ROLL PIN ZP	13698 1/8 X 1-1/4 ROLL PIN ZP	
13705 5/32 X 1/2 ROLL PIN ZP	13710 5/32 X 1 ROLL PIN ZP	13714 5/32 X 1-1/2 ROLL PIN ZP	13722 3/16 X 5/8 ROLL PIN ZP	13725 3/16 X 1 ROLL PIN ZP	13732 3/16 X 2 ROLL PIN ZP	
13738 7/32 X 3/4 ROLL PIN ZP	13744 7/32 X 1-1/2 ROLL PIN ZP	13746 7/32 X 1-3/4 ROLL PIN ZP	13753 1/4 X 1 ROLL PIN ZP	13760 1/4 X 2 ROLL PIN ZP	13764 1/4 X 3 ROLL PIN ZP	

PRODUCT CATEGORY: K

Roll Pins

24 Items • 570 Pcs
IBS No. 165R



Packaged in a Locking Steel Drawer
for Easy Storage & Organization

IBS, Inc. SPECIALTY PRODUCTS FOR MAINTENANCE & REPAIR INDUSTRIALBOLT.COM © 2010 800-678-1996						Metric O-Rings 1.5mm to 3.0mm	
						Assortment No. 184R	
15700 3.0 X 1.5 METRIC O RING	15701 5.0 X 1.5 METRIC O RING	15702 7.0 X 1.5 METRIC O RING	15703 9.0 X 1.5 METRIC O RING	15704 11.0 X 1.5 METRIC O RING	15705 6.0 X 2.0 METRIC O RING	15706 8.0 X 2.0 METRIC O RING	15707 10.0 X 2.0 METRIC O RING
15708 12.0 X 2.0 METRIC O RING	15709 14.0 X 2.0 METRIC O RING	15712 6.3 X 2.4 METRIC O RING	15713 8.3 X 2.4 METRIC O RING	15714 11.8 X 2.4 METRIC O RING	15715 13.3 X 2.4 METRIC O RING	15716 17.3 X 2.4 METRIC O RING	15717 5.0 X 2.5 METRIC O RING
15718 7.0 X 2.5 METRIC O RING	15719 10.0 X 2.5 METRIC O RING	15720 12.0 X 2.5 METRIC O RING	15721 15.0 X 2.5 METRIC O RING	15722 10.0 X 3.0 METRIC O RING	15723 12.0 X 3.0 METRIC O RING	15724 14.0 X 3.0 METRIC O RING	15725 16.0 X 3.0 METRIC O RING
15726 18.0 X 3.0 METRIC O RING	15727 20.2 X 3.0 METRIC O RING	15729 22.2 X 3.0 METRIC O RING	15730 24.2 X 3.0 METRIC O RING	15732 26.2 X 3.0 METRIC O RING	15734 30.2 X 3.0 METRIC O RING		

PRODUCT CATEGORY: K

Metric O-Rings 1.5mm to 3.0mm

30 Items • 220 Pcs
IBS No. 184R

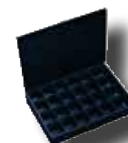

Packaged in a Locking Steel Drawer
for Easy Storage & Organization

IBS, Inc. SPECIALTY PRODUCTS FOR MAINTENANCE & REPAIR INDUSTRIALBOLT.COM © 2010 800-678-1996						Metric O-Rings 2.0mm to 5.0mm Large Diameter
						Assortment No. 185R
15710 18.0 X 2.0 METRIC O RING	15711 20.0 X 2.0 METRIC O RING	15728 22.0 X 3.0 METRIC O RING	15731 25.0 X 3.0 METRIC O RING	15733 28.0 X 3.0 METRIC O RING	15734 30.2 X 3.0 METRIC O RING	
15735 32.2 X 3.0 METRIC O RING	15736 38.0 X 3.0 METRIC O RING	15737 25.0 X 4.0 METRIC O RING	15738 30.0 X 4.0 METRIC O RING	15739 32.0 X 4.0 METRIC O RING	15740 35.0 X 4.0 METRIC O RING	
15741 36.0 X 4.0 METRIC O RING	15742 38.0 X 4.0 METRIC O RING	15743 40.0 X 4.0 METRIC O RING	15744 44.0 X 4.0 METRIC O RING	15745 45.0 X 4.0 METRIC O RING	15746 50.0 X 4.0 METRIC O RING	
15747 25.0 X 5.0 METRIC O RING	15748 30.0 X 5.0 METRIC O RING	15749 35.0 X 5.0 METRIC O RING	15750 40.0 X 5.0 METRIC O RING	15751 45.0 X 5.0 METRIC O RING	15752 50.0 X 5.0 METRIC O RING	

PRODUCT CATEGORY: K

Metric O-Rings 2.0mm to 5.0 Large Diameter

24 Items • 76 Pcs
IBS No. 185R

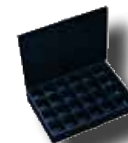

Packaged in a Locking Steel Drawer
for Easy Storage & Organization



IBS, INCORPORATED

Assortments - Rings & Pins (K)

ASSORTMENTS

IBS, Inc. SPECIALTY PRODUCTS FOR MAINTENANCE & REPAIR INDUSTRIALMOLLY.COM 800-678-1906				Hitch Pin Clips
Assortment No. 240R				
15530 1/32 X 9-1/16 HITCH PIN 31P	15520 3/64 X 19-3/32 HITCH PIN 21P	15521 1/16 X 1-5/16 HITCH PIN 22P	15524 5/64 X 1-3/32 HITCH PIN 25P	
15512 3/32 X 1-3/16 HITCH PIN 13P	15516 3/32 X 1-9/16 HITCH PIN 17P	15506 3/32 X 2-5/16 HITCH PIN 7P	15513 3/32 X 2-1/2 HITCH PIN 14P	
15515 1/8 X 1-15/16 HITCH PIN 16P	15510 1/8 X 2-9/16 HITCH PIN 11P	15526 1/8 X 2-1/2 HITCH PIN 27P	15509 5/32 X 2-15/16 HITCH PIN 10P	
15505 3/16 X 3-1/4 HITCH PIN 6P	15507 3/16 X 3-3/4 HITCH PIN 8P	15528 3/16 X 3-1/2 HITCH PIN 29P	15518 1/4 X 4 HITCH PIN 19P	

PRODUCT CATEGORY: K

Hitch Pin Clips
16 Items • 390 Pcs
IBS No. 240R



Packaged in a Locking Steel Drawer for Easy Storage & Organization

IBS, Inc. SPECIALTY PRODUCTS FOR MAINTENANCE & REPAIR INDUSTRIALMOLLY.COM 800-678-1906				Snapper & Lynch Pins
Assortment No. 394R				
28-01 1/4 X 1-3/4 SNAPPER PIN	63-01 3/16 X 1-9/16 LYNCH PIN	63-04 7/16 X 1-9/16 LYNCH PIN		
28-02 5/16 X 2-1/2 SNAPPER PIN	63-02 1/4 X 1-9/16 LYNCH PIN	63-05 7/16 X 1-3/4 LYNCH PIN		
28-03 3/8 X 1-3/8 SNAPPER PIN	A-11736 1/4 X 1-3/4 LYNCH PIN	63-11 7/16 X 1-9/16 LYNCH PIN		
28-04 3/8 X 2-1/4 SNAPPER PIN	63-03 5/16 X 1-9/16 LYNCH PIN			

PRODUCT CATEGORY: K

Snapper & Lynch Pins
11 Items • 33 Pcs
IBS No. 394R



Packaged in a Locking Steel Drawer for Easy Storage & Organization

IBS, Inc. SPECIALTY PRODUCTS FOR MAINTENANCE & REPAIR INDUSTRIALMOLLY.COM 800-678-1906								Viton O-Rings
Assortment No. 735R								
30006 #006 1/16 WL 1/8 ID VITON O-RING	30010 #010 1/16 WL 1/4 ID VITON O-RING	30111 #111 3/32 WL 7/16 ID VITON O-RING	30115 #115 3/32 WL 11/16 ID VITON O-RING	30212 #212 1/8 WL 7/8 ID VITON O-RING	30216 #216 1/8 WL 1-1/8 ID VITON O-RING	30220 #220 1/8 WL 1-3/8 ID VITON O-RING	30326 #326 3/16 WL 1-5/8 ID VITON O-RING	
30007 #007 1/16 WL 5/32 ID VITON O-RING	30011 #011 1/16 WL 1/8 ID VITON O-RING	30112 #112 3/32 WL 1/2 ID VITON O-RING	30116 #116 3/32 WL 3/4 ID VITON O-RING	30213 #213 1/8 WL 15/16 ID VITON O-RING	30217 #217 1/8 WL 1-3/16 ID VITON O-RING	30221 #221 1/8 WL 1-7/16 ID VITON O-RING	30327 #327 3/16 WL 1-3/4 ID VITON O-RING	
30008 #008 1/16 WL 3/16 ID VITON O-RING	30012 #012 1/16 WL 3/8 ID VITON O-RING	30113 #113 3/32 WL 9/16 ID VITON O-RING	30210 #210 1/8 WL 3/4 ID VITON O-RING	30214 #214 1/8 WL 1" ID VITON O-RING	30218 #218 1/8 WL 1-1/4 ID VITON O-RING	30222 #222 1/8 WL 1-1/2 ID VITON O-RING		
30009 #009 1/16 WL 7/32 ID VITON O-RING	30110 #010 3/32 WL 3/8 ID VITON O-RING	30114 #114 3/32 WL 5/8 ID VITON O-RING	30211 #211 1/8 WL 13/16 ID VITON O-RING	30215 #215 1/8 WL 1-1/16 ID VITON O-RING	30219 #219 1/8 WL 1-5/16 ID VITON O-RING	30325 #325 3/16 WL 1-1/2 ID VITON O-RING		

PRODUCT CATEGORY: K

Viton O-Rings
30 Items • 360 Pcs
IBS No. 735R



Packaged in a Locking Steel Drawer for Easy Storage & Organization

IBS, INCORPORATED

Assortments - Rings & Pins (K)



Stainless Steel Cotter Pins					
Assortment No. 798R					
13300 1/16 X 1-1/2 COTTER PIN SS 	13306 1/16 X 2 COTTER PIN SS 	13313 3/32 X 2 COTTER PIN SS 	13320 1/8 X 2 COTTER PIN SS 	13325 5/32 X 1-1/2 COTTER PIN SS 	13332 3/16 X 1-1/2 COTTER PIN SS
13301 1/16 X 3/4 COTTER PIN SS 	13308 3/32 X 3/4 COTTER PIN SS 	13315 1/8 X 3/4 COTTER PIN SS 	13321 1/8 X 2-1/2 COTTER PIN SS 	13327 5/32 X 2 COTTER PIN SS 	13334 3/16 X 2 COTTER PIN SS
13302 1/16 X 1 COTTER PIN SS 	13309 3/32 X 1 COTTER PIN SS 	13316 1/8 X 1 COTTER PIN SS 	13322 1/8 X 3 COTTER PIN SS 	13328 5/32 X 2-1/2 COTTER PIN SS 	13335 3/16 X 2-1/2 COTTER PIN SS
13304 1/16 X 1-1/2 COTTER PIN SS 	13311 3/32 X 1-1/2 COTTER PIN SS 	13318 1/8 X 1-1/2 COTTER PIN SS 	13323 5/32 X 1 COTTER PIN SS 	13329 5/32 X 3 COTTER PIN SS 	13336 3/16 X 3 COTTER PIN SS

PRODUCT CATEGORY: K

Stainless Steel Cotter Pins

24 Items • 845 Pcs
IBS No. 798R



Packaged in a Locking Steel Drawer
for Easy Storage & Organization

A/C O-Rings				
Nitrile for use with R134A & R12 Refrigerant				
Assortment No. 804R				
A-18134 4.5MM X 7.3MM X 1.4MM NITRILE A/C O-RING 	A-18195 6MM X 9.6MM X 1.8MM NITRILE A/C O-RING 	A-18196 6.5MM X 9.5MM 1.5MM NITRILE A/C O-RING 	A-18137 6.6MM X 10.2MM X 1.8MM NITRILE A/C O-RING 	A-17604 290 X .432 X .071 NITRILE A/C O-RING
A-18138 7.7MM X 11.3MM X 1.8MM NITRILE A/C O-RING 	A-18646 .375 X .500 X .063 NITRILE A/C O-RING 	A-17605 .400 X .546 X .073 NITRILE A/C O-RING 	A-18140 10.7MM X 15.5MM X 2.4MM NITRILE A/C O-RING 	A-18139 10.8MM X 14.4MM X 1.8MM NITRILE A/C O-RING
A-17606 .509 X .655 X .073 NITRILE A/C O-RING 	A-18141 13.3MM X 18.1MM X 2.4MM NITRILE A/C O-RING 	A-18143 13.4MM X 17.2MM X 1.9MM NITRILE A/C O-RING 	A-18142 14MM X 17.6MM X 1.8MM NITRILE A/C O-RING 	A-18144 14.8MM X 19.6MM X 2.4MM NITRILE A/C O-RING
A-17607 .617 X .769 X .076 NITRILE A/C O-RING 	A-18647 .688 X .813 X .063 NITRILE A/C O-RING 	A-19235 13/16 X 1-1/16 X 1/8 NITRILE A/C O-RING 		

PRODUCT CATEGORY: K

AC O-Rings

Nitrile for use with
R134A & R12 Refrigerant
18 Items • 180 Pcs
IBS No. 804R



Packaged in a Locking Steel Drawer
for Easy Storage & Organization

ASSORTMENTS



IBS, INCORPORATED

Assortments - Socket Products (L)

ASSORTMENTS

IBS, Inc. SPECIALTY PRODUCTS FOR MAINTENANCE & REPAIR INDUSTRIALBOLT.COM © & © 800-678-1996						Hex Socket Head Cap Screws					
Assortment No. 167R											
14450 6-32 X 1/4 SOCKET HD C/S ALLOY	14454 6-32 X 3/4 SOCKET HD C/S ALLOY	14562 8-32 X 1/2 SOCKET HD C/S ALLOY	14661 10-32 X 1/2 SOCKET HD C/S	14571 10-24 X 1/2 SOCKET HD C/S	14685 10-32 X 1-1/4 SOCKET HD C/S						
14451 6-32 X 3/8 SOCKET HD C/S ALLOY	14455 6-32 X 1 SOCKET HD C/ ALLOY	14563 8-32 X 5/8 SOCKET HD C/S ALLOY	14682 10-32 X 5/8 SOCKET HD C/S	14572 10-24 X 5/8 SOCKET HD C/S	14686 10-32 X 1-1/2 SOCKET HD C/S						
14452 6-32 X 1/2 SOCKET HD C/S ALLOY	14560 8-32 X 1/4 SOCKET HD C/S ALLOY	14564 8-32 X 3/4 SOCKET HD C/S ALLOY	14683 10-32 X 3/4 SOCKET HD C/S	14573 10-24 X 3/4 SOCKET HD C/S	14576 10-24 X 1-1/4 SOCKET HD C/S						
14453 6-32 X 5/8 SOCKET HD C/S ALLOY	14561 8-32 X 3/8 SOCKET HD C/S ALLOY	14565 8-32 X 1 SOCKET HD C/ ALLOY	14684 10-32 X 1 SOCKET HD C/S ALLOY	14574 10-24 X 1 SOCKET HD C/S ALLOY	14577 10-24 X 1-1/2 SOCKET HD C/S						

PRODUCT CATEGORY: L

Hex Socket Head Capscrews

24 Items • 925 Pcs
IBS No. 167R



Packaged in a Locking Steel Drawer for Easy Storage & Organization

IBS, Inc. SPECIALTY PRODUCTS FOR MAINTENANCE & REPAIR INDUSTRIALBOLT.COM © & © 800-678-1996								Socket Set Screws Knurled Point Thread							
Assortment No. 190R															
14168 6-32 X 1/4 SOC SET KNURLED PT	14169 6-32 X 5/16 SOC SET KNURLED PT	14170 6-32 X 3/8 SOC SET KNURLED PT	14178 8-32 X 1/4 SOC SET KNURLED PT	14179 8-32 X 5/16 SOC SET KNURLED PT	14180 8-32 X 3/8 SOC SET KNURLED PT	14182 8-32 X 1/2 SOC SET KNURLED PT	14187 10-24 X 3/16 SOC SET KNURLED								
14188 10-24 X 1/4 SOC SET KNURLED PT	14190 10-24 X 3/8 SOC SET KNURLED PT	14191 10-24 X 1/2 SOC SET KNURLED PT	14212 1/4-20 X 1/4 SOC SET KNURLED	14213 1/4-20 X 5/16 SOC SET	14214 1/4-20 X 3/8 SOC SET KNURLED	14216 1/4-20 X 1/2 SOC SET KNURLED	14218 1/4-20 X 3/4 SOC SET KNURLED								
14228 5/16-18 X 3/8 SOC SET	14300 5/16-18 X 1/2 SOC SET	14302 5/16-18 X 3/4 SOC SET	14314 3/8-16 X 1/2 SOC SET KNURLED	14315 3/8-16 X 5/8 SOC SET KNURLED	14316 3/8-16 X 3/4 SOC SET KNURLED	14318 3/8-16 X 1 SOC SET KNURLED PT	14335 1/2-13 X 1/2 SOC SET KNURLED								
14336 1/2-13 X 5/8 SOC SET KNURLED	14337 1/2-13 X 3/4 SOC SET KNURLED	14338 1/2-13 X 1 SOC SET KNURLED PT													

PRODUCT CATEGORY: L

Socket Set Screws Knurled Point Thread

27 Items • 490 Pcs
IBS No. 190R



Packaged in a Locking Steel Drawer for Easy Storage & Organization

IBS, Inc. SPECIALTY PRODUCTS FOR MAINTENANCE & REPAIR INDUSTRIALBOLT.COM © & © 800-678-1996					SAE Alloy Socket Set Screws Knurled Point				
Assortment No. 191R									
14198 10-32 X 3/16 SOC SET KNURLED	14361 1/4-28 X 1/4 SOC SET KNURLED	14366 1/4-28 X 3/4 SOC SET KNURLED	14384 3/8-24 X 1/2 SOC SET KNURLED	14398 1/2-20 X 1/2 SOC SET CUP					
14199 10-32 X 1/4 SOC SET KNURLED PT	14362 1/4-28 X 5/16 SOC SET KNURLED	14372 5/16-24 X 3/8 SOC SET KNURLED	14385 3/8-24 X 5/8 SOC SET KNURLED	14399 1/2-20 X 5/8 SOC SET CUP					
14201 10-32 X 3/8 SOC SET KNURLED	14363 1/4-28 X 3/8 SOC SET KNURLED	14374 5/16-24 X 1/2 SOC SET KNURLED	14386 3/8-24 X 3/4 SOC SET KNURLED	14400 1/2-20 X 3/4 SOC SET CUP					
14203 10-32 X 1/2 SOC SET KNURLED	14365 1/4-28 X 1/2 SOC SET KNURLED	14376 5/16-24 X 3/4 SOC SET KNURLED	14387 3/8-24 X 1 SOC SET KNURLED PT	14401 1/2-20 X 1 SOC SET CUP POINT					

PRODUCT CATEGORY: L

SAE Alloy Socket Set Screws Knurled Point

20 Items • 390 Pcs
IBS No. 191R



Packaged in a Locking Steel Drawer for Easy Storage & Organization

IBS, INCORPORATED

Assortments - Socket Products (L)



Socket Head Cap Screws 4-40 to 10-32 Assortment No. 371R					
14440 4-40 X 1/4 SOCKET HD C/S ALLOY	14441 4-40 X 3/8 SOCKET HD C/S ALLOY	14442 4-40 X 1/2 SOCKET HD C/S ALLOY	14443 4-40 X 5/8 SOCKET HD C/S ALLOY	14444 4-40 X 3/4 SOCKET HD C/S ALLOY	14450 6-32 X 1/4 SOCKET HD C/S ALLOY
14451 6-32 X 3/8 SOCKET HD C/S ALLOY	14452 6-32 X 1/2 SOCKET HD C/S ALLOY	14453 6-32 X 5/8 SOCKET HD C/S ALLOY	14454 6-32 X 3/4 SOCKET HD C/S ALLOY	14561 8-32 X 3/8 SOCKET HD C/S ALLOY	14562 8-32 X 1/2 SOCKET HD C/S ALLOY
14563 8-32 X 5/8 SOCKET HD C/S ALLOY	14564 8-32 X 3/4 SOCKET HD C/S ALLOY	14565 8-32 X 1 SOCKET HD C/S ALLOY	14570 10-24 X 3/8 SOCKET HD C/S	14571 10-24 X 1/2 SOCKET HD C/S	14573 10-24 X 3/4 SOCKET HD C/S
14574 10-24 X 1 SOCKET HD C/S ALLOY	14680 10-32 X 3/8 SOCKET HD C/S	14681 10-32 X 1/2 SOCKET HD C/S	14683 10-32 X 3/4 SOCKET HD C/S	14684 10-32 X 1 SOCKET HD C/S ALLOY	

PRODUCT CATEGORY: L

Socket Head Cap Screws 4-40 to 10-32 Assortment No. 371R					
14440 4-40 X 1/4 SOCKET HD C/S ALLOY	14441 4-40 X 3/8 SOCKET HD C/S ALLOY	14442 4-40 X 1/2 SOCKET HD C/S ALLOY	14443 4-40 X 5/8 SOCKET HD C/S ALLOY	14444 4-40 X 3/4 SOCKET HD C/S ALLOY	14450 6-32 X 1/4 SOCKET HD C/S ALLOY
14451 6-32 X 3/8 SOCKET HD C/S ALLOY	14452 6-32 X 1/2 SOCKET HD C/S ALLOY	14453 6-32 X 5/8 SOCKET HD C/S ALLOY	14454 6-32 X 3/4 SOCKET HD C/S ALLOY	14561 8-32 X 3/8 SOCKET HD C/S ALLOY	14562 8-32 X 1/2 SOCKET HD C/S ALLOY
14563 8-32 X 5/8 SOCKET HD C/S ALLOY	14564 8-32 X 3/4 SOCKET HD C/S ALLOY	14565 8-32 X 1 SOCKET HD C/S ALLOY	14570 10-24 X 3/8 SOCKET HD C/S	14571 10-24 X 1/2 SOCKET HD C/S	14573 10-24 X 3/4 SOCKET HD C/S
14574 10-24 X 1 SOCKET HD C/S ALLOY	14680 10-32 X 3/8 SOCKET HD C/S	14681 10-32 X 1/2 SOCKET HD C/S	14683 10-32 X 3/4 SOCKET HD C/S	14684 10-32 X 1 SOCKET HD C/S ALLOY	

PRODUCT CATEGORY: L

Flat Head Socket Capscrews 4-40 - 10-32 Assortment No. 373R					
147390 4-40 X 1/4 FLAT SOCKET C/S	147391 4-40 X 3/8 FLAT SOCKET C/S	147392 4-40 X 1/2 FLAT SOCKET C/S	147393 4-40 X 5/8 FLAT SOCKET C/S	147394 4-40 X 3/4 FLAT SOCKET C/S	147399 6-32 X 1/4 FLAT SOCKET HD C/S
147400 6-32 X 3/8 FLAT SOCKET C/S	147401 6-32 X 1/2 FLAT SOCKET C/S	147402 6-32 X 5/8 FLAT SOCKET C/S	147403 6-32 X 3/4 FLAT SOCKET C/S	147410 8-32 X 3/8 FLAT SOCKET C/S	147411 8-32 X 1/2 FLAT SOCKET C/S
147412 8-32 X 5/8 FLAT SOCKET C/S	147413 8-32 X 3/4 FLAT SOCKET C/S	147414 8-32 X 1 FLAT SOCKET C/S ALLOY	147420 10-24 X 3/8 FLAT SOCKET C/S	147421 10-24 X 1/2 FLAT SOCKET C/S	147423 10-24 X 3/4 FLAT SOCKET HD
147424 10-24 X 1 FLAT SOCKET HD C/S	14815 10-32 X 3/4 FLAT SOCKET C/S	14816 10-32 X 1/2 FLAT SOCKET C/S	14818 10-32 X 3/4 FLAT SOCKET C/S	14819 10-32 X 1 FLAT SOCKET C/S	

PRODUCT CATEGORY: L

Socket Head Capscrews

4-40 to 10-32
23 Items • 1,075 Pcs
IBS No. 371R



Packaged in a Locking Steel Drawer for Easy Storage & Organization

Socket Head Capscrews

1/4-20 to 1/2-13
19 Items • 403 Pcs
IBS No. 372R



Packaged in a Locking Steel Drawer for Easy Storage & Organization

Flat Head Socket Capscrews

4-40 to 10-32
23 Items • 1,050 Pcs
IBS No. 373R



Packaged in a Locking Steel Drawer for Easy Storage & Organization

ASSORTMENTS



IBS, INCORPORATED

Assortments - Socket Products (L)

ASSORTMENTS

IBS, Inc. SPECIALTY PRODUCTS FOR MAINTENANCE & REPAIR INDUSTRIALBOLT.COM © B © 800-678-1996					Flat Head Socket Capscrews 1/4-20 - 1/2-13 Assortment No. 374R				
14750 1/4-20 X 1/2 FLAT SOCKET C/S 	14752 1/4-20 X 3/4 FLAT SOCKET C/S 	14753 1/4-20 X 1 FLAT SOCKET C/S 	14754 1/4-20 X 1-1/4 FLAT SOCKET 	14755 1/4-20 X 1-1/2 FLAT SOCKET 	14760 5/16-18 X 1/2 FLAT SOCKET C/S 	14762 5/16-18 X 3/4 FLAT SOCKET C/S 	14763 5/16-18 X 1 FLAT SOCKET C/S 	14764 5/16-18 X 1-1/4 FLAT SOCKET 	14765 5/16-18 X 1-1/2 FLAT SOCKET
14772 3/8-16 X 3/4 FLAT SOCKET C/S 	14773 3/8-16 X 1 FLAT SOCKET C/S 	14774 3/8-16 X 1-1/4 FLAT SOCKET 	14775 3/8-16 X 1-1/2 FLAT SOCKET 	14777 3/8-16 X 2 FLAT SOCKET C/S 	14787 1/2-13 X 1 FLAT SOCKET C/S 	14788 1/2-13 X 1-1/4 FLAT SOCKET 	14789 1/2-13 X 1-1/2 FLAT SOCKET 	14791 1/2-13 X 2 FLAT SOCKET C/S 	

PRODUCT CATEGORY: L

IBS, Inc. SPECIALTY PRODUCTS FOR MAINTENANCE & REPAIR INDUSTRIALBOLT.COM © B © 800-678-1996					Button Head Socket Cap Screws 4-40 to 10-32 Assortment No. 376R				
148911 4-40 X 1/4 BUTTON SOC C/S Hex Key: 1/16" 	148912 4-40 X 3/8 BUTTON SOC C/S Hex Key: 1/16" 	148913 4-40 X 3/8 BUTTON SOC C/S Hex Key: 1/16" 	148915 6-32 X 3/8 BUTTON SOC C/S Hex Key: 1/12" 	148916 6-32 X 3/8 BUTTON SOC C/S Hex Key: 5/64" 	148917 6-32 X 1/2 BUTTON SOC C/S Hex Key: 5/64" 	148918 6-32 X 5/8 BUTTON SOC C/S Hex Key: 5/64" 	148920 8-32 X 1/4 BUTTON SOC C/S Hex Key: 3/32" 	148921 8-32 X 3/8 BUTTON SOC C/S Hex Key: 3/32" 	14902 8-32 X 1/2 BUTTON SOC C/S Hex Key: 3/32"
148925 10-24 X 1/4 BUTTON SOC C/S Hex Key: 1/8" 	148926 10-24 X 3/8 BUTTON SOC C/S Hex Key: 1/8" 	14907 10-24 X 1/2 BUTTON SOC C/S Hex Key: 1/8" 	14908 10-24 X 5/8 BUTTON SOC C/S Hex Key: 1/8" 	14909 10-24 X 3/4 BUTTON SOC C/S Hex Key: 1/8" 	14910 10-24 X 1 BUTTON SOC C/S Hex Key: 3/32" 	148930 10-32 X 1/4 BUTTON SOC C/S Hex Key: 1/8" 	148931 10-32 X 1/4 BUTTON SOC C/S Hex Key: 1/8" 	14911 10-32 X 1/2 BUTTON SOC C/S Hex Key: 1/8" 	148932 10-32 X 5/8 BUTTON SOC C/S Hex Key: 1/8"
14912 10-32 X 3/4 BUTTON SOC C/S Hex Key: 1/8" 	14913 10-32 X 1 BUTTON SOC C/S Hex Key: 1/8" 								

PRODUCT CATEGORY: L

IBS, Inc. SPECIALTY PRODUCTS FOR MAINTENANCE & REPAIR INDUSTRIALBOLT.COM © B © 800-678-1996					Button Head Socket Capscrews 1/4-20 to 1/2-13 Assortment No. 377R				
14915 1/4-20 X 3/8 BUTTON SOCKET C/S Hex Key 5/32" 	14916 1/4-20 X 1/2 BUTTON SOCKET C/S Hex Key 5/32" 	14917 1/4-20 X 5/8 BUTTON SOCKET C/S Hex Key 5/32" 	14918 1/4-20 X 3/4 BUTTON SOCKET C/S Hex Key 5/32" 	14919 1/4-20 X 1 BUTTON SOCKET C/S Hex Key 5/32" 	14920 5/16-18 X 3/8 BUTTON SOCKET C/S Hex Key 3/16" 	14921 5/16-18 X 1/2 BUTTON SOCKET C/S Hex Key 3/16" 	14922 5/16 X 5/8 BUTTON SOCKET C/S Hex Key 3/16" 	14923 5/16-18 X 3/4 BUTTON SOCKET C/S Hex Key 3/16" 	14924 5/16-18 X 1 BUTTON SOCKET C/S Hex Key 3/16"
14926 3/8-16 X 1/2 BUTTON SOCKET C/S Hex Key 7/32" 	14927 3/8-16 X 5/8 BUTTON SOCKET C/S Hex Key 7/32" 	14928 3/8-16 X 3/4 BUTTON SOCKET C/S Hex Key 7/32" 	14929 3/8-16 X 1 BUTTON SOCKET C/S Hex Key 7/32" 	14930 3/8-16 X 1-1/4 BUTTON SOCKET C/S Hex Key 7/32" 	14932 1/2-13 X 1 BUTTON SOCKET C/S Hex Key 5/16" 	14933 1/2-13 X 1-1/4 BUTTON SOCKET C/S Hex Key 5/16" 	14934 1/2-13 X 1-1/2 BUTTON SOCKET C/S Hex Key 5/16" 	14935 1/2-13 X 2 BUTTON SOCKET C/S Hex Key 5/16" 	

PRODUCT CATEGORY: L

Flat Socket Head Capscrews 1/4-20 to 1/2-13 19 Items • 356 Pcs IBS No. 374R



Packaged in a Locking Steel Drawer
for Easy Storage & Organization

Button Head Socket Capscrews 4-40 to 10-32 24 Items • 1,050 Pcs IBS No. 376R



Packaged in a Locking Steel Drawer
for Easy Storage & Organization

Button Head Socket Capscrews 1/4-20 to 10-32 19 Items • 1,050 Pcs IBS No. 377R



Packaged in a Locking Steel Drawer
for Easy Storage & Organization

IBS, INCORPORATED

Assortments - Steel Pipe Fittings (N)



 Steel Pipe Fittings							Assortment No. 139R
15021 1/2 HEX PLUG NPT ZP 	15071 1/2 4SDGR ST. ELB 150# NPT BMI 	15063 1/2 90DGR ST. ELB 150# NPT BMI 	15027 1/2 COUPLER 150# NPT BMI 	15135 1/2 X CLOSE (1-1/8) BLACK 	15136 1/2 X 1-1/2 BLACK NIPPLE 	15077 1/2 X 1/8 HEX BUSHING NPT ZP 	
15020 3/8 HEX PLUG NPT ZP 	15070 3/8 4SDGR ST. ELB 150# NPT BMI 	15062 3/8 90DGR ST. ELB 150# NPT BMI 	15026 3/8 COUPLER 150# NPT BMI 	15126 3/8 X CLOSE (1) BLACK NIPPLE 	15127 3/8 X 1-1/2 BLACK NIPPLE 	15076 3/8 X 1/4 HEX BUSHING NPT ZP 	
15019 1/4 HEX PLUG NPT ZP 	15069 1/4 4SDGR ST. ELB 150# NPT BMI 	15061 1/4 90DGR ST. ELB 150# NPT BMI 	15025 1/4 COUPLER 150# NPT BMI 	15115 1/4 X CLOSE (7/8) BLACK NIPPLE 	15116 1/4 X 1-1/2 BLACK NIPPLE 	15075 3/8 X 1/8 HEX BUSHING NPT ZP 	15079 1/2 X 3/8 HEX BUSHING NPT ZP 
15018 1/8 HEX PLUG NPT ZP 	15068 1/8 4SDGR ST. ELB 150# NPT BMI 	15060 1/8 90DGR ST. ELB 150# NPT BMI 	15201 1/8 COUPLER BLACK NPT STEEL 	15105 1/8 X CLOSE (3/4) BLACK NIPPLE 	15106 1/8 X 1-1/2 BLACK NIPPLE 	15074 1/4 X 1/8 HEX BUSHING NPT ZP 	15078 1/2 X 1/4 HEX BUSHING NPT ZP 

PRODUCT CATEGORY: N

Steel Pipe Fittings
30 Items • 34 Pcs
IBS No. 139R



**Packaged in a Locking Steel Drawer
 for Easy Storage & Organization**

**A
S
S
O
R
T
M
E
N
T
S**



IBS, INCORPORATED

Assortments - Brass Pipe Fittings (O)

ASSORTMENTS

IBS, Inc. SPECIALTY PRODUCTS FOR MAINTENANCE & REPAIR INDUSTRIALMOLY.COM 800-678-1906								Brass Pipe Fittings	
								Assortment No. 103R	
3152X8 1/2 BRASS HEX HD PLUG	3220X8X2 1/2 X 1/8 BRASS PIPE HX	3226X4 1/4 X CLOSE BRASS NIPPLE	3350X4 1/4 BRASS 45DGR ST. ELBOW	3400X4 1/4 X 1/4 BRASS ST. ELBOW	3750X4 1/4 BRASS PIPE ST. TEE	WHD145 1/4 BRASS EXT SEAT DRAINCK	3300X8 1/2 BRASS PIPE COUPLING		
3152X6 3/8 BRASS HEX HD PLUG	3220X6X4 3/8 X 1/8 BRASS PIPE HX	3226X2 1/8 X CLOSE BRASS NIPPLE	3350X2 1/8 BRASS 45DGR ST. ELBOW	3400X2 1/8 X 1/8 BRASS ST. ELBOW	3750X2 1/8 BRASS PIPE ST. TEE	WHD135 1/8 BRASS EXT SEAT DRAINCK	3300X6 3/8 BRASS PIPE COUPLING		
3152X4 1/4 BRASS HEX HD PLUG	3220X6X2 3/8 X 1/8 BRASS PIPE HX	3220X8X6 1/2 X 3/8 BRASS PIPE HX	3326X8 1/2 X CLOSE BRASS NIPPLE	3350X8 1/2 BRASS 45DGR ST. ELBOW	3400X8 1/2 X 1/2 BRASS ST. ELBOW	3750X8 1/2 BRASS PIPE ST. TEE	3300X4 1/4 BRASS PIPE COUPLING		
3152X2 1/8 BRASS HEX HD PLUG	3220X4X2 1/4 X 1/8 BRASS PIPE HX	3220X8X4 1/2 X 1/4 BRASS PIPE HX	3326X6 3/8 X CLOSE BRASS NIPPLE	3350X6 3/8 BRASS 45DGR ST. ELBOW	3400X6 3/8 X 3/8 BRASS ST. ELBOW	3750X6 3/8 BRASS PIPE ST TEE	3300X2 1/8 BRASS PIPE COUPLING		

PRODUCT CATEGORY: O

Brass Pipe Fittings
32 Items • 64 Pcs
IBS No. 103R



Packaged in a Locking Steel Drawer for Easy Storage & Organization

IBS, Inc. SPECIALTY PRODUCTS FOR MAINTENANCE & REPAIR INDUSTRIALMOLY.COM 800-678-1906				Brass Pipe Fittings	
				3/8" & 1/2"	
				Assortment No. 103R-LGR	
3220X6X4 3/8 X 1/4 BRASS PIPE HX	3326X8 1/2 X CLOSE BRASS NIPPLE	3400X8 1/2 X 1/2 BRASS ST. ELBOW	3300X8 1/2 BRASS PIPE COUPLING		
3220X6X2 3/8 X 1/8 BRASS PIPE HX	3326X6 3/8 X CLOSE BRASS NIPPLE	3400X6 3/8 X 3/8 BRASS ST ELBOW	3300X6 3/8 BRASS PIPE COUPLING		
3152X8 1/2 BRASS HEX HD PLUG	3220X8X6 1/2 X 3/8 BRASS PIPE HX	3350X8 1/2 BRASS 45DGR ST. ELBOW	3750X8 1/2 BRASS PIPE ST. TEE		
3152X6 3/8 BRASS HEX HD PLUG	3220X8X4 1/2 X 1/4 BRASS PIPE HX	3350X6 3/8 BRASS 45DGR ST. ELBOW	3750X6 3/8 BRASS PIPE ST TEE		

PRODUCT CATEGORY: O

Brass Pipe Fittings
3/8" & 1/2"
17 Items • 64 Pcs
IBS No. 103R-LGR



Packaged in a Locking Steel Drawer for Easy Storage & Organization

IBS, Inc. SPECIALTY PRODUCTS FOR MAINTENANCE & REPAIR INDUSTRIALMOLY.COM 800-678-1906				Brass Pipe Fittings	
				1/8" & 1/4"	
				Assortment No. 103R-SML	
3220X4X2 1/4 X 1/8 BRASS PIPE HX	3400X4 1/4 X 1/4 BRASS ST. ELBOW	3750X4 1/4 BRASS PIPE ST. TEE	WHD145 1/4 BRASS EXT. SEAT DRAIN COCK		
3152X4 1/4 BRASS HEX HD PLUG	3400X2 1/8 X 1/8 BRASS ST. ELBOW	3750X2 1/8 BRASS PIPE ST. TEE	WHD135 1/8 BRASS EXT. SEAT DRAIN COCK		
3152X2 1/8 BRASS HEX HD PLUG	3226X4 1/4 X CLOSE BRASS NIPPLE	3350X4 1/4 BRASS 45DGR ST. ELBOW	3300X4 1/4 BRASS PIPE COUPLING		
	3226X2 1/8 X CLOSE BRASS NIPPLE	3350X2 1/8 BRASS 45DGR ST. ELBOW	3300X2 1/8 BRASS PIPE COUPLING		

PRODUCT CATEGORY: O

Brass Pipe Fittings
1/8" & 1/4"
15 Items • 69 Pcs
IBS No. 103R-SML



Packaged in a Locking Steel Drawer for Easy Storage & Organization

IBS, INCORPORATED

Assortments - Brass Pipe Fittings (O)



IBS, Inc.
SPECIALTY PRODUCTS FOR MAINTENANCE & REPAIR
INDUSTRIALBOLT.COM • 800-678-1996

**SAE 45° Flare
Brass Fittings**

Assortment No. 104R

42X8 1/2 SAE 45DGR BRASS FLARE	48X5 5/16 X 1/8 SAE 45DGR BRASS	48X8 1/2 X 3/8 SAE 45DGR BRASS	48X10X6 5/8 X 3/8 SAE 45DGR BRASS	49X5X4 5/16 X 1/4 SAE 90DGR BRASS	49X8X4 1/2 X 1/4 SAE 90DGR BRASS	54X4 1/4 X 1/8 SAE 45DGR BRASS	54X10 5/8 X 1/2 SAE 45DGR BRASS
42X6 3/8 SAE 45DGR BRASS FLARE	48X4X4 1/4 X 1/4 SAE 45DGR BRASS	48X6X6 3/8 X 3/8 SAE 45DGR BRASS	48X10 5/8 X 1/2 SAE 45DGR BRASS	49X5 5/16 X 1/8 SAE 90DGR BRASS	49X6 1/2 X 3/8 SAE 90DGR BRASS	49X10X6 5/8 X 3/8 SAE 90DGR BRASS	54X8 1/2 X 3/8 SAE 45DGR BRASS
42X5 5/16 SAE 45DGR BRASS FLARE	48X4 1/4 X 1/8 SAE 45DGR BRASS	48X6 3/8 X 1/4 SAE 45DGR BRASS	48X8X8 1/2 X 1/2 SAE 45DGR BRASS	49X4X4 1/4 X 1/4 SAE 90DGR BRASS	49X6X6 3/8 X 3/8 SAE 90DGR BRASS	49X10 5/8 X 1/2 SAE 90DGR BRASS	54X6 3/8 X 1/4 SAE 45DGR BRASS
42X4 1/4 SAE 45DGR BRASS FLARE	42X10 5/8 SAE 45DGR BRASS FLARE	48X5X4 5/16 X 1/4 SAE 45DGR BRASS	48X8X4 1/2 X 1/4 SAE 45DGR BRASS	49X4 1/4 X 1/8 SAE 90DGR BRASS	49X6 3/8 X 1/4 SAE 90DGR BRASS	49X8X8 1/2 X 1/2 SAE 90DGR BRASS	54X5 5/16 X 1/8 SAE 45DGR BRASS

PRODUCT CATEGORY: O

**SAE 45° Flare
Brass Fittings**
32 Items • 95 Pcs
IBS No. 104R



Packaged in a Locking Steel Drawer
for Easy Storage & Organization

IBS, Inc.
SPECIALTY PRODUCTS FOR MAINTENANCE & REPAIR
INDUSTRIALBOLT.COM • 800-678-1996

**SAE 45° Flare
Brass Fittings**

Assortment No. 104R-LGR

42X8 1/2 SAE 45DGR BRASS FLARE	48X8X4 1/2 X 1/4 SAE 45DGR BRASS	48X8X8 1/2 X 1/2 SAE 45DGR BRASS	48X10 5/8 X 1/2 SAE 45DGR BRASS
42X10 5/8 SAE 45DGR BRASS FLARE	48X8 1/2 X 3/8 SAE 45DGR BRASS	48X10X6 5/8 X 3/8 SAE 45DGR BRASS	
54X8 1/2 X 3/8 SAE 45DGR BRASS	49X8X4 1/2 X 1/4 SAE 90DGR BRASS	49X8X8 1/2 X 1/2 SAE 90DGR BRASS	49X10 5/8 X 1/2 SAE 90DGR BRASS
54X10 5/8 X 1/2 SAE 45DGR BRASS	49X8 1/2 X 3/8 SAE 90DGR BRASS	49X10X6 5/8 X 3/8 SAE 90DGR BRASS	

PRODUCT CATEGORY: O

**SAE 45° Flare
Brass Fittings**
14 Items • 36 Pcs
IBS No. 104R-LGR



Packaged in a Locking Steel Drawer
for Easy Storage & Organization

IBS, Inc.
SPECIALTY PRODUCTS FOR MAINTENANCE & REPAIR
INDUSTRIALBOLT.COM • 800-678-1996

**SAE 45° Flare
Brass Fittings**

Assortment No. 104R-SML

42X4 1/4 SAE 45DGR BRASS FLARE	42X5 5/16 SAE 45DGR BRASS FLARE	42X6 3/8 SAE 45DGR BRASS FLARE	54X4 1/4 X 1/8 SAE 45DGR BRASS
48X4 1/4 X 1/8 SAE 45DGR BRASS	48X5 5/16 X 1/8 SAE 45DGR BRASS	48X6 3/8 X 1/4 SAE 45DGR BRASS	54X5 5/16 X 1/8 SAE 45DGR BRASS
48X4X4 1/4 X 1/4 SAE 45DGR BRASS	48X5X4 5/16 X 1/4 SAE 45DGR BRASS	48X6X6 3/8 X 3/8 SAE 45DGR BRASS	
49X4 1/4 X 1/8 SAE 90DGR BRASS	49X5 5/16 X 1/8 SAE 90DGR BRASS	49X6 3/8 X 1/4 SAE 90DGR BRASS	54X6 3/8 X 1/4 SAE 45DGR BRASS
49X4X4 1/4 X 1/4 SAE 90DGR BRASS	49X5X4 5/16 X 1/4 SAE 90DGR BRASS	49X6X6 3/8 X 3/8 SAE 90DGR BRASS	

PRODUCT CATEGORY: O

**SAE 45° Flare Brass
Fittings 1/4", 5/16" &
3/8"**

18 Items • 58 Pcs
IBS No. 104R-SML



Packaged in a Locking Steel Drawer
for Easy Storage & Organization



IBS, INCORPORATED

Assortments - Brass Pipe Fittings (O)

ASSORTMENTS

IBS, Inc. SPECIALTY PRODUCTS FOR MAINTENANCE & REPAIR INDUSTRIALBOLT.COM © © © 800-878-1906					Small Push-On Hose Fittings
Assortment No. 111R					
10004B-102 1/4 X 1/8 BRASS PUSH-ON M. PIPE 	10004B-104 1/4 X 1/4 BRASS PUSH-ON M. PIPE 	10005B-102 5/16 X 1/8 PUSH-ON M. PIPE 	10005B-104 5/16 X 1/4 PUSH-ON M. PIPE 	10004B-Y04 1/4 PUSH-ON HOSE MENDER 	
10006B-104 3/8 X 1/4 PUSH-ON M. PIPE 	10006B-106 3/8 X 3/8 PUSH-ON M. PIPE 	10004B-404 1/4 X 1/4 PUSH-ON SAE FE. 	10004B-405 1/4 X 5/16 PUSH-ON SAE FE. 	10005B-Y05 5/16 PUSH-ON HOSE MENDER 	
10006B-405 5/16 X 5/16 PUSH-ON SAE 	10006B-405 3/8 X 5/16 PUSH-ON SAE 	10006B-406 3/8 X 3/8 PUSH-ON SAE 	10004B-B04 1/4 X 1/4 PUSH-ON M. INV. 	10006B-Y06 3/8 PUSH-ON HOSE MENDER 	
10004B-B05 1/4 X 5/16 PUSH-ON 	10005B-B04 5/16 X 1/4 PUSH-ON M. 	10005B-B05 5/16 X 5/16 PUSH-ON M. INV. 	10006B-B05 3/8 X 5/16 PUSH-ON M. 	10006B-B06 3/8 X 3/8 PUSH-ON M. INV. 	

PRODUCT CATEGORY: O

Small Push-On Hose Fittings

20 Items • 88 Pcs
IBS No. 111R



Packaged in a Locking Steel Drawer
for Easy Storage & Organization

IBS, Inc. SPECIALTY PRODUCTS FOR MAINTENANCE & REPAIR INDUSTRIALBOLT.COM © © © 800-878-1906					Large Push-On Hose Fittings
Assortment No. 112R					
10008B-106 1/2 X 3/8 PUSH-ON M. PIPE 		10008B-108 1/2 X 1/2 PUSH-ON M. PIPE 		10008B-Y08 1/2 PUSH-ON HOSE MENDER 	
10010B-108 5/8 X 1/2 PUSH-ON M. PIPE 		10012B-112 3/4 X 3/4 PUSH-ON M. PIPE RIGID 		10010B-Y10 5/8 PUSH-ON HOSE MENDER 	
10008B-408 1/2 X 1/2 PUSH-ON SAE FE. SWIV 		10010B-410 5/8 X 5/8 PUSH-ON SAE FE. 		10012B-Y12 3/4 PUSH-ON HOSE MENDER 	
10012B-412 PUSH-ON SAE FEMALE SWIVEL 	10008B-B08 1/2 X 1/2 PUSH-ON M. INV. 	10006B-606 3/8 X 3/8 PUSH-ON JIC FE. 			

PRODUCT CATEGORY: O

Large Push-On Hose Fittings

12 Items • 51 Pcs
IBS No. 112R



Packaged in a Locking Steel Drawer
for Easy Storage & Organization

IBS, Inc. SPECIALTY PRODUCTS FOR MAINTENANCE & REPAIR INDUSTRIALBOLT.COM © © © 800-878-1906					Brass Draincocks & Shut-Off Valves
Assortment No. 121R					
WHD135 1/8 BRASS EXT. SEAT DRAIN COCK 	WHD145 1/4 BRASS EXT. SEAT DRAIN COCK 	WHD270 3/8 BRASS EXT. SEAT DRAIN COCK 	WHD130 1/8 BRASS INT. SEAT DRAIN COCK 	WHD108 1/2 BRASS EXT. SEAT DRAIN COCK 	
WHD-1424 1/8 INT. SEAT DRAIN VALVE BRASS 	WHD-1425 1/4 INT. SEAT DRAIN VALVE BRASS 	WHD-1426 3/8 INT. SEAT DRAIN VALVE BRASS 	6809 1/4 FE BRASS PIPE SHUT OFF 	WHD1423 5/8 X 3/8 PIPE TO HOSE SHUT 	
WHD6824 1/8 X 1/8 M. TO F. SHUT OFF 	6828 1/4 X 1/4 MARINE SHUT OFF 	WHD150 1/8 BRASS ANGLE BIB DRAIN COCK 	WHD6660 1/4 BRASS ANGLE BIB DRAIN COCK 	229KF SHUT OFF 	
WHD-1421 1/4 BRASS AIR TANK VALVE 	WHD6829 1/4 X 1/4 M TO F SHUT OFF 	WHD-6892 1/4 BRASS GROUND PLUG 	WHD-6893 3/8 BRASS GROUND PLUG 	WHD1422 3/8 X 3/8 PIPE TO HOSE SHUT 	

PRODUCT CATEGORY: O

SAE 45° Flare Brass Fittings

20 Items • 34 Pcs
IBS No. 121R



Packaged in a Locking Steel Drawer
for Easy Storage & Organization

IBS, INCORPORATED

Assortments - Brass Pipe Fittings (O)



IBS, Inc. <small>SPECIALTY PRODUCTS FOR MAINTENANCE & REPAIR INDUSTRIALBOLT.COM © © © 950-678-1506</small>				Air Brake Fittings for Hose	
Assortment No. 149R					
W15536 3/8 X 1/4 AIR BRAKE MALE CONNECTOR WITH SPRING GUARD 	W15539 3/8 X 1/2 AIR BRAKE MALE CONNECTOR 	W23907 3/8 X 3/8 AIR BRAKE MALE CONNECTOR WITH SPRING GUARD 	W33886 1/2 X 1/2 AIR BRAKE MALE CONNECTOR WITH SPRING GUARD 		
	W03624 3/8 AIR BRAKE NUT 		W33902 1/2 AIR BRAKE NUT 		
		W16678 3/8 AIR BRAKE HOSE MENDER 			
W15535 3/8 X 1/2 AIR BRAKE MALE CONNECTOR WITH SPRING GUARD 	W03613 3/8 AIR BRAKE NUT FOR SPRING GUARD 		W33801 1/2 AIR BRAKE SLEEVE 		
	W03610 3/8 AIR BRAKE SLEEVE 	W15540 3/8 X 1/4 AIR BRAKE MALE CONNECTOR 	W24887 3/8 X 3/8 AIR BRAKE MALE CONNECTOR 		

PRODUCT CATEGORY: O

Air Brake Fittings for Hose

13 Items • 35 Pcs
IBS No. 149R



Packaged in a Locking Steel Drawer for Easy Storage & Organization

IBS, Inc. <small>SPECIALTY PRODUCTS FOR MAINTENANCE & REPAIR INDUSTRIALBOLT.COM © © © 950-678-1506</small>						Compression Brass Fittings	
Assortment No. 177R							
60X3 3/16 OD BRASS COMP SLEEVE 	60X4 1/4 OD BRASS COMP SLEEVE 	60X5 5/16 OD BRASS COMP SLEEVE 	60X6 3/8 OD BRASS COMP SLEEVE 	61X3 3/16 OD BRASS COMP NUT 	61X4 1/4 OD BRASS COMP NUT 		
61X5 5/16 OD BRASS COMP NUT 	61X6 3/8 OD BRASS COMP NUT 	62X3 3/16 OD BRASS COMP UNION 	62X4 1/4 OD BRASS COMP UNION 	62X5 5/16 OD BRASS COMP UNION 	62X6 3/8 OD BRASS COMP UNION 		
68X3 3/16 X 1/8 BRASS COMP M CONN 	68X4 1/4 X 1/8 BRASS COMP M CONN 	68X4X4 1/4 X 1/4 BRASS COMP M CONN 	68X5 5/16 X 1/8 BRASS COMP M CONN 	68X5X4 5/16 X 1/4 BRASS COMP M CONN 	68X6 3/8 X 1/4 BRASS COMP M CONN 		
69X3 3/16 X 1/8 90DGR BRASS COMP M 	69X4 1/4 X 1/8 90DGR BRASS COMP M 	69X4X4 1/4 X 1/4 90DGR BRASS COMP M 	69X5 5/16 X 1/8 90DGR BRASS COMP M 	69X5X4 5/16 X 1/4 90DGR BRASS COMP M 	69X6 3/8 X 1/4 90DGR BRASS COMP M 		

PRODUCT CATEGORY: O

Compression Brass Fittings

24 Items • 209 Pcs
IBS No. 177R



Packaged in a Locking Steel Drawer for Easy Storage & Organization

IBS, Inc. <small>SPECIALTY PRODUCTS FOR MAINTENANCE & REPAIR INDUSTRIALBOLT.COM © © © 950-678-1506</small>						Inverted Flare Brass Fittings	
Assortment No. 178R							
105X3 3/16 INV TUBE NUT STEEL 	105X4 1/4 INV TUBE NUT STEEL 	105X5 5/16 INV TUBE NUT STEEL 	105X6 3/8 INV TUBE NUT STEEL 	202X3 3/16 X 1/8 INV M CONN BRASS 	202X4 1/4 X 1/8 INV M CONN BRASS 		
202X4X4 1/4 X 1/4 INV M CONN BRASS 	202X5 5/16 X 1/8 INV M CONN BRASS 	202X5X4 5/16 X 1/4 INV M CONN BRASS 	202X6 3/8 X 1/4 INV M CONN BRASS 	402X3 3/16 X 1/8 INV 90DGR ELBOW M 	402X4 1/4 X 1/8 INV 90DGR ELBOW M 		
402X4X4 1/4 X 1/4 INV 90DGR ELBOW M 	402X5 5/16 X 1/8 INV 90DGR ELBOW M 	402X5X4 5/16 X 1/4 INV 90DGR ELBOW M 	402X6 3/8 X 1/4 INV 90DGR ELBOW M 	352X3 3/16 X 1/8 INV 45DGR ELBOW M 	352X4 1/4 X 1/8 INV 45DGR ELBOW M 		
352X5 5/16 X 1/8 INV 45DGR ELBOW M 	352X6 3/8 X 1/4 INV 45DGR ELBOW M 	302X3 3/16 INV UNION BRASS 	302X4 1/4 INV UNION BRASS 	302X5 5/16 INV UNION BRASS 	302X6 3/8 INV UNION BRASS 		

PRODUCT CATEGORY: O

Inverted Flare Brass Fittings

24 Items • 129 Pcs
IBS No. 178R



Packaged in a Locking Steel Drawer for Easy Storage & Organization

ASSORTMENTS



IBS, INCORPORATED

Assortments - Brass Pipe Fittings (O)

ASSORTMENTS

IBS, Inc. SPECIALTY PRODUCTS FOR MAINTENANCE & REPAIR INDUSTRIALBOLT.COM © © © 800-678-1506		Fuller Transmission Fittings Compression & Push-On 1/8" & 5/32" Assortment No. 179R			
660A 1/8 SLEEVE FULLER TRANS	669A 1/8X1/8 M ELBOW FULLER TRANS	668AS 1/8X1/16 M CONN FULLER TRANS	1169X2X2S 1/8X1/8 90DGR M SWIV ELB POLY	56822 1/8 X 1/8 M CONN POLY PUSH NP	1162X2 1/8 UNION POLY PUSH NP BRASS
660B 5/32 SLEEVE FULLER TRANS	669B 5/32X1/8 M ELBOW FULLER TRANS	668A 1/8X1/8 M CONN FULLER TRANS	1169X3X2S 5/32X1/8 90DGR M SWIV ELB	56832 5/32 X 1/8 M CONN POLY PUSH	1162X3 5/32 UNION POLY PUSH NP BRASS
661A 1/8 NUT FULLER TRANS	662A 1/8 UNION FULLER TRANS	668BS 5/32 X1/16 M CONN FULLER TRANS	1169X3X4S 5/32X1/4 90DGR M SWIV ELB	56834 5/32 X 1/4 M CONN POLY PUSH	
661B 5/32 NUT FULLER TRANS	662B 5/32 UNION FULLER TRANS	668B 5/32X1/8 M CONN FULLER TRANS			

PRODUCT CATEGORY: O

Fuller Transmission Fittings Compression & Push-On

1/8" & 5/32"
20 Items • 95 Pcs
IBS No. 179R



Packaged in a Locking Steel Drawer for Easy Storage & Organization

IBS, Inc. SPECIALTY PRODUCTS FOR MAINTENANCE & REPAIR INDUSTRIALBOLT.COM © © © 800-678-1506		Push Lock DOT Air Brake Fittings 1/4" & 3/8" Assortment No. 180R	
86842 1/4 X 1/8 POLY-MATIC DOT MALE	87942 1/4 X 1/8 POLY-MATIC DOT M	86244 1/4 POLY-MATIC DOT UNION	
86844 1/4 X 1/4 POLY-MATIC DOT MALE	87944 1/4 X 1/4 POLY-MATIC M SWIVEL	86266 3/8 POLY-MATIC DOT UNION	
86864 3/8 X 1/4 POLY-MATIC DOT MALE	87964 3/8 X 1/4 POLY-MATIC DOT M	88244 1/4 POLY-MATIC DOT BULK HEAD	
86866 3/8 X 3/8 POLY-MATIC DOT MALE	87966 3/8 X 3/8 POLY-MATIC DOT M	88266 3/8 POLY-MATIC DOT BULK HEAD	

PRODUCT CATEGORY: O

Push-Lock DOT Air Brake Fittings

12 Items • 36 Pcs
IBS No. 180R



Packaged in a Locking Steel Drawer for Easy Storage & Organization

IBS, Inc. SPECIALTY PRODUCTS FOR MAINTENANCE & REPAIR INDUSTRIALBOLT.COM © © © 800-678-1506		Push Lock DOT Air Brake Fittings 1/4", 3/8" and 1/2" Assortment No. 181R	
87944 1/4 X 1/4 POLY-MATIC M SWIVEL ELBOW	87966 3/8 X 3/8 POLY-MATIC DOT M SWIVEL ELBOW	87988 1/2 X 1/2 POLY-MATIC DOT M SWIVEL ELBOW	
87942 1/4 X 1/8 POLY-MATIC DOT M SWIVEL ELBOW	87964 3/8 X 1/4 POLY-MATIC DOT M SWIVEL ELBOW	87986 1/2 X 3/8 POLY-MATIC DOT M SWIVEL ELBOW	
86844 1/4 X 1/4 POLY-MATIC DOT MALE CONNECTOR	86866 3/8 X 3/8 POLY-MATIC DOT MALE CONNECTOR	86888 1/2 X 1/2 POLY-MATIC DOT MALE CONNECTOR	
86842 1/4 X 1/8 POLY-MATIC DOT MALE CONNECTOR	86864 3/8 X 1/4 POLY-MATIC DOT MALE CONNECTOR	86886 1/2 X 3/8 POLY-MATIC DOT MALE CONNECTOR	
88244 1/4 POLY-MATIC DOT BULK HEAD UNION	88266 3/8 POLY-MATIC DOT BULK HEAD UNION	88288 1/2 POLY-MATIC DOT BULK HEAD UNION	
86244 1/4 POLY-MATIC DOT UNION	86266 3/8 POLY-MATIC DOT UNION	86288 1/2 POLY-MATIC DOT UNION	

PRODUCT CATEGORY: O

Push-Lock DOT Air Brake Fittings

1/4", 3/8" & 1/2"
18 Items • 45 Pcs
IBS No. 181R



Packaged in a Locking Steel Drawer for Easy Storage & Organization

IBS, INCORPORATED

Assortments - Brass Pipe Fittings (O)



IBS, Inc. <small>SPECIALTY PRODUCTS FOR MAINTENANCE & REPAIR INDUSTRIALBOLT.COM © © © 800-678-1906</small>					Nylon Air Brake Fittings 1/4" & 3/8"
192R					
1460X4 1/4 BRASS A/B SLEEVE 	1461X4 1/4 BRASS A/B NUT 	1462X4 1/4 BRASS A/B UNION 	1468X4 1/4 X 1/8 BRASS A/B M CONN 	1468X4X4 1/4 X 1/4 BRASS A/B M CONN 	
1469X4 1/4 X 1/8 BRASS A/B 90DGR M CONN 	1469X4X4 1/4 X 1/4 BRASS A/B 90DGR M CONN 	1480X4 1/4 X 1/8 BRASS A/B 45DGR M CONN 	1484X4 1/4 BRASS A/B INSERT 	1460X6 3/8 BRASS A/B SLEEVE 	
1461X6 3/8 BRASS A/B NUT 	1462X6 3/8 BRASS A/B UNION 	1468X6 3/8 X 1/4 BRASS A/B M CONN 	1468X6X2 3/8 X 1/8 BRASS A/B M CONN 	1468X6X6 3/8 X 3/8 BRASS A/B M CONN 	
1469X6 3/8 X 1/4 BRASS A/B 90DGR M CONN 	1469X6X2 3/8 X 1/8 BRASS A/B 90DGR M CONN 	1469X6X6 3/8 X 3/8 BRASS A/B 90DGR M CONN 	1480X6 3/8 X 1/4 BRASS A/B 45DGR M CONN 	1484X6 3/8 BRASS A/B INSERT 	

PRODUCT CATEGORY: O

Nylon Air Brake Fittings

1/4" & 3/8"
20 Items • 121 Pcs
IBS No. 192R



Packaged in a Locking Steel Drawer for Easy Storage & Organization

IBS, Inc. <small>SPECIALTY PRODUCTS FOR MAINTENANCE & REPAIR INDUSTRIALBOLT.COM © © © 800-678-1906</small>					1/2" Nylon Air Brake Fittings
Assortment No. 193R					
1460X8 1/2 BRASS A/B SLEEVE 	1461X8 1/2 BRASS A/B NUT 	1462X8 1/2 BRASS A/B UNION 	1468X8 1/2 X 3/8 BRASS A/B M. CONN 		
1468X8X4 1/2 X 1/4 BRASS A/B M. CONN 	1468X8X8 1/2 X 1/2 BRASS A/B M. CONN 	1469X8 1/2 X 3/8 BRASS A/B 90DGR 	1469X8X4 1/2 X 1/4 BRASS A/B 90DGR 		
1469X8X8 1/2 X 1/2 BRASS A/B 90DR 	1480X8 1/2 X 3/8 BRASS A/B 45DGR 	1484X8 1/2 BRASS A/B INSERT 			

PRODUCT CATEGORY: O

1/2" Nylon Air Brake Fittings

11 Items • 68 Pcs
IBS No. 193R



Packaged in a Locking Steel Drawer for Easy Storage & Organization

IBS, Inc. <small>SPECIALTY PRODUCTS FOR MAINTENANCE & REPAIR INDUSTRIALBOLT.COM © © © 800-678-1906</small>					Poly-Matic Nickel Plated Brass Fittings
Assortment No. 197R					
56822 1/8 X 1/8 COMPOSITE M CONN 	56842 1/4 X 1/8 COMPOSITE M CONN 	56844 1/4 X 1/4 COMPOSITE M CONN 	56862 3/8 X 1/8 COMPOSITE M CONN 	56864 3/8 X 1/4 COMPOSITE M CONN 	
56866 3/8 X 3/8 COMPOSITE M CONN 	56886 1/2 X 3/8 COMPOSITE M CONN 	1169X2X2S 1/2 X 1/8 90DGR M SWIV ELB POLY 	1169X4X2S 1/4 X 1/8 90DGR M SWIV ELB POLY 	1169X4X4S 1/4 X 1/4 90DGR M SWIV ELB POLY 	
1169X6X2S 3/8 X 1/8 90DGR M SWIV POLY 	1169X6X4S 3/8 X 1/4 90DGR M SWIV ELB POLY 	1169X6X6S 3/8 X 3/8 90DGR M SWIV ELB POLY 	1169X8X6S 1/2 X 3/8 90DGR M SWIV ELB POLY 		
1162X2 1/8 UNION POLY PUSH NP BRASS 	1162X4 1/4 UNION POLY PUSH NP BRASS 	1162X6 3/8 UNION POLY PUSH NP BRASS 	1162X8 1/2 UNION POLY PUSH NP BRASS 		

PRODUCT CATEGORY: O

Poly-Matic Nickel Plated Brass Fittings

18 Items • 44 Pcs
IBS No. 197R



Packaged in a Locking Steel Drawer for Easy Storage & Organization



IBS, INCORPORATED

Assortments - Brass Pipe Fittings (O)

ASSORTMENTS

IBS, Inc. SPECIALTY PRODUCTS FOR MAINTENANCE & REPAIR INDUSTRIALBOLTY.COM © © © 800-678-1906				Male/Female Pipe Thread Protectors
				Assortment No. 203R
18102 1/8 MALE NPT POLY PLUG 	18104 1/4 MALE NPT POLY PLUG 	18106 3/8 MALE NPT POLY PLUG 	18108 1/2 MALE NPT POLY PLUG 	
18112 3/4 MALE NPT POLY PLUG 	18116 1 MALE NPT POLY PLUG 	18120 1-1/4 MALE NPT POLY PLUG 	18124 1-1/2 MALE NPT POLY PLUG 	
18152 1/8 FEMALE NPT POLY CAP 	18154 1/4 FEMALE NPT POLY CAP 	18156 3/8 FEMALE NPT POLY CAP 	18158 1/2 FEMALE NPT POLY CAP 	
18162 3/4 FEMALE NPT POLY CAP 	18166 1 FEMALE NPT POLY CAP 	18170 1-1/4 FEMALE NPT POLY CAP 	18174 1-1/2 FEMALE NPT POLY CAP 	

PRODUCT CATEGORY: O

Pipe Thread Protector Assortment

16 Items • 340 Pcs
IBS No. 203R



Packaged in a Locking Steel Drawer for Easy Storage & Organization

IBS, Inc. SPECIALTY PRODUCTS FOR MAINTENANCE & REPAIR INDUSTRIALBOLTY.COM © © © 800-678-1906			5/8" Air Brake Fittings for Nylon
			Assortment No. 217R
1460X10 5/8 BRASS A/B SLEEVE 	1461X10 5/8 BRASS A/B NUT 	1462X10 5/8 BRASS A/B UNION 	
1468X10 5/8 X 1/2 BRASS A/B M. CONN 	1468X10X6 5/8 X 3/8 BRASS A/B M CONN 	1468X10X12 5/8 X 3/4 BRASS A/B M CONN 	
1469X10 5/8 X 1/2 BRASS A/B 90DGR 	1469X10X6 5/8 X 3/8 BRASS A/B 90DGR 	1469X10X12 5/8 X 3/4 BRASS A/B 90DGR 	
1480X10 5/8 X 1/2 BRASS A/B 45DR 	1484X10 5/8 BRASS A/B INSERT 		

PRODUCT CATEGORY: O

5/8" Air Brake Fittings for Nylon Tubing

11 Items • 25 Pcs
IBS No. 217R



Packaged in a Locking Steel Drawer for Easy Storage & Organization

IBS, Inc. SPECIALTY PRODUCTS FOR MAINTENANCE & REPAIR INDUSTRIALBOLTY.COM © © © 800-678-1906					Long-Barb Push-On Fittings 1/8", 3/16", 1/4", 5/16"
					Assortment No. 218R
10403B-103 3/16 LONG BARB UNION 	10404B-104 1/4 LONG BARB UNION 	10405B-105 5/16 LONG BARB UNION 	10406B-104 3/8 X 1/4 LONG BARB UNION 	10406B-105 3/8 X 5/16 LONG BARB UNION 	
10502B-102 1/8 X 1/8 M. LONG BARB H. END 	10503B-102 3/16 X 1/8 M. LONG BARB H. END 	10503B-104 3/16 X 1/4 M. LONG BARB H. END 	10504B-102 1/4 X 1/8 M. LONG BARB H. END 	10504B-104 1/4 X 1/4 M LONG BARB HOSE END 	
10504B-106 1/4 X 3/8 M. LONG BARB H. END 	10505B-102 5/16 X 1/8 M. LONG BARB H. END 	10505B-104 5/16 X 1/4 M. LONG BARB H. END 	10502B-202 1/8 X 1/8 F. LONG BARB H. END 	10503B-202 3/16 X 1/8 F. LONG BARB H. END 	
10504B-202 1/4 X 1/8 F. LONG BARB H. END 	10504B-204 1/4 X 1/4 F. LONG BARB H. END 	10505B-202 5/16 X 1/8 F. LONG BARB H. END 	10505B-204 5/16 X 1/4 F. LONG BARB H. END 		

PRODUCT CATEGORY: O

Push-On Hose Fittings 1/8", 3/16", 1/4" & 5/16"

19 Items • 78 Pcs
IBS No. 218R



Packaged in a Locking Steel Drawer for Easy Storage & Organization

IBS, INCORPORATED

Assortments - Brass Pipe Fittings (O)



Long-Barb Push-On Fittings 3/8", 1/2, 3/4"			
Assortment No. 219R			
10406B-106 3/8 LONG BARB UNION	10408B-108 1/2 LONG BARB UNION	10410B-110 5/8 LONG BARB UNION	10412B-112 3/4 LONG BARB UNION
10506B-104 3/8 X 1/4 M. LONG BARB H. END	10506B-106 3/8 X 3/8 M. LONG BARB H. END	10508B-106 1/2 X 3/8 M. LONG BARB H. END	10508B-108 1/2 X 1/2 M. LONG BARB H. END
10510B-108 5/8 X 1/2 M. LONG BARB H. END	10512B-108 3/4 X 1/2 M LONG BARB HOSE	10512B-112 3/4 X 3/4 M. LONG BARB H. END	10506B-204 3/8 X 1/4 F. LONG BARB H. END
10506B-206 3/8 X 3/8 F. LONG BARB H. END	10508B-204 1/2 X 1/4 F. LONG BARB H. END	10508B-206 1/2 X 3/8 F. LONG BARB H. END	10508B-208 1/2 X 1/2 F. LONG BARB H. END

PRODUCT CATEGORY: O

Push-On Hose Fittings 3/8", 1/2" & 3/4"

16 Items • 56 Pcs
IBS No. 219R



Packaged in a Locking Steel Drawer for Easy Storage & Organization

Poly-Push Composite Metric Fittings for Nylon Tubing M4, M6 & M8					
Assortment No. 332R					
301202 M4 X 1/8BSPT COMPOSITE M CONN	301212 M6 X 1/8BSPT COMPOSITE M CONN	301213 M6 X 1/4BSPT COMPOSITE M CONN	301218 M8 X 1/4BSPT COMPOSITE M CONN	301219 M8 X 3/8BSPT COMPOSITE M CONN	309250 M4 COMPOSITE STRAIGHT UNION
302202 M4 X 1/8BSPT COMP M SWIV	302212 M6 X 1/8BSPT COMP M SWIV	302213 M6 X 1/4BSPT COMP M SWIV	302218 M8 X 1/4BSPT COMP M SWIV	302219 M8 X 3/8BSPT COMP M SWIV	309263 M6 COMPOSITE UNION CONN POLY
307202 M4 X 1/8BSPT COMP M BRANCH	307212 M6 X 1/8BSPT COMP M BRANCH	307213 M6 X 1/4BSPT COMP M BRANCH	307218 M8 X 1/4BSPT COMP M BRANCH	307219 M8 X 3/8BSPT COMP M BRANCH	309268 M8 COMPOSITE STRAIGHT UNION
304250 M4 COMPOSITE UNION ELBOW POLY	304263 M6 COMPOSITE UNION ELBOW POLY	304268 M8 COMPOSITE UNION ELBOW POLY	305250 M4 COMPOSITE UNION TEE POLY	305263 M6 COMPOSITE UNION TEE POLY	305268 M8 COMPOSITE UNION TEE POLY

PRODUCT CATEGORY: O

Poly-Push Composite Metric Fittings for Nylon Tubing M4, M6 & M8

24 Items • 39 Pcs
IBS No. 332R



Packaged in a Locking Steel Drawer for Easy Storage & Organization

Poly-Push Composite Metric Fittings for Nylon Tubing M10 & M12				
Assortment No. 333R				
301223 M10 X 1/4BSPT COMPOSITE M	301224 M10 X 3/8BSPT COMPOSITE M	301225 M10 X 1/2BSPT COMPOSITE M	301229 M12 X 3/8BSPT COMPOSITE M	301230 M12 X 1/2BSPT COMPOSITE M
302223 M10 X 1/4BSPT COMP M SWIV ELB	302224 M10 X 3/8BSPT COMP M SWIV ELB	302229 M12 X 3/8BSPT COMP M SWIV ELB	302230 M12 X 1/2BSPT COMP M SWIV ELB	
304272 M10 COMPOSITE UNION ELBOW	304275 M12 COMPOSITE UNION ELBOW	305272 M10 COMPOSITE UNION TEE POLY	305275 M12 COMPOSITE UNION TEE POLY	
309272 M10 COMPOSITE STRAIGHT UNION	309275 M12 COMPOSITE STRAIGHT UNION	307224 M10 X 3/8BSPT COMP M BRANCH	307230 M12 X 1/2BSPT COMP M BRANCH	

PRODUCT CATEGORY: O

Poly-Push Composite Metric Fittings for Nylon Tubing M10 & M12

17 Items • 19 Pcs
IBS No. 333R



Packaged in a Locking Steel Drawer for Easy Storage & Organization

ASSORTMENTS



IBS, INCORPORATED

Assortments - Brass Pipe Fittings (O)

ASSORTMENTS

IBS, Inc. <small>SPECIALTY PRODUCTS FOR MAINTENANCE & REPAIR INDUSTRIALBOLT.COM © © © 800-678-1996</small>					Push Lock DOT Fittings 5/32", 1/4" & 3/8"				
					<small>Assortment No. 334R</small>				
86233 5/32 POLY-MATIC DOT UNION 	86244 1/4 POLY-MATIC DOT UNION 	86266 3/8 POLY-MATIC DOT UNION 	86444 1/4 POLY-MATIC DOT UNION TEE 	86466 3/8 POLY-MATIC DOT UNION TEE 					
86842 1/4 X 1/8 POLY-MATIC DOT MALE 	86844 1/4 X 1/4 POLY-MATIC DOT MALE 	86864 3/8 X 1/4 POLY-MATIC DOT MALE 	86866 3/8 X 3/8 POLY-MATIC DOT MALE 						
87242 1/4X1/8 POLY-MATIC DOT M SWIV 	87244 1/4X1/4 POLY-MATIC DOT M SWIV 	87264 3/8X1/4 POLY-MATIC DOT M SWIV 	87266 3/8X3/8 POLY-MATIC DOT M SWIV 						
87942 1/4 X 1/8 POLY-MATIC DOT M SWIVEL 	87944 1/4 X 1/4 POLY-MATIC M SWIVEL 	87964 3/8 X 1/4 POLY-MATIC DOT M 	87966 3/8 X 3/8 POLY-MATIC DOT M 						

PRODUCT CATEGORY: O

IBS, Inc. <small>SPECIALTY PRODUCTS FOR MAINTENANCE & REPAIR INDUSTRIALBOLT.COM © © © 800-678-1996</small>					Push Lock DOT Fittings 3/8" & 1/2"				
					<small>Assortment No. 335R</small>				
86266 3/8 POLY-MATIC DOT UNION 	86288 1/2 POLY-MATIC DOT UNIONS 	86466 3/8 POLY-MATIC DOT UNION TEE 	86488 1/2 POLY-MATIC DOT UNION TEE 						
86866 3/8 X 3/8 POLY-MATIC DOT MALE 	86884 1/2 X 1/4 POLY-MATIC DOT MALE 	86886 1/2 X 3/8 POLY-MATIC DOT MALE 	86888 1/2 X 1/2 POLY-MATIC DOT MALE 						
87266 3/8X3/8 POLY-MATIC DOT M SWIV 	87284 1/2X1/4 POLY-MATIC DOT M SWIV 	87286 1/2X3/8 POLY-MATIC DOT M SWIV 	87288 1/2X1/2 POLY-MATIC DOT M SWIV 						
87966 3/8 X 3/8 POLY-MATIC DOT M 	87984 1/2 X 1/4 POLY-MATIC DOT M 	87986 1/2 X 3/8 POLY-MATIC DOT M 	87988 1/2 X 1/2 POLY-MATIC DOT M 						

PRODUCT CATEGORY: K

IBS, Inc. <small>SPECIALTY PRODUCTS FOR MAINTENANCE & REPAIR INDUSTRIALBOLT.COM © © © 800-678-1996</small>						Poly-Push Composite Fractional Fittings for Nylon Tubing 1/8", 5/32", 1/4" & 5/16"					
						<small>Assortment No. 336R</small>					
56222 1/8 COMPOSITE STRAIGHT UNION 	56233 5/32 COMPOSITE STRAIGHT UNION 	56244 1/4 COMPOSITE STRAIGHT UNION 	56242 1/4 X 1/8 COMPOSITE UNION RED 	56255 5/16 COMPOSITE STRAIGHT UNION 							
56422 1/8 COMPOSITE UNION TEE POLY 	56444 1/4 COMPOSITE UNION TEE POLY 	56522 1/8 COMPOSITE UNION ELBOW 	56544 1/4 COMPOSITE UNION ELBOW 	57244 1/4 X 1/4 COMP M SWIV BR TEE 							
56822 1/8 X 1/8 COMPOSITE M CONN 	56824 1/8 X 1/4 COMPOSITE M CONN 	56832 5/32 X 1/8 COMPOSITE M CONN 	56842 1/4 X 1/8 COMPOSITE M CONN 	56844 1/4 X 1/4 COMPOSITE M CONN 	56854 5/16 X 1/4 COMPOSITE M CONN 						
57922 1/8 X 1/8 COMP M SWIV ELBOW 	57924 1/8 X 1/4 COMP M SWIV ELBOW 	57932 5/32 X 1/8 COMP M SWIV ELBOW 	57942 1/4 X 1/8 COMP M SWIV ELBOW 	57944 1/4 X 1/4 COMP M SWIV ELBOW 	57954 5/16 X 1/4 COMP M SWIV ELBOW 						

PRODUCT CATEGORY: O

Poly-Matic DOT Air Brake Fittings
17 Items • 33 Pcs
IBS No. 334R



Packaged in a Locking Steel Drawer for Easy Storage & Organization

Poly-Matic DOT Air Brake Fittings
16 Items • 21 Pcs
IBS No. 335R



Packaged in a Locking Steel Drawer for Easy Storage & Organization

Poly-Push Composite Fractional Fittings for Nylon Tubing
1/8", 5/32", 1/4" & 5/16"
22 Items • 41 Pcs
IBS No. 336R



Packaged in a Locking Steel Drawer for Easy Storage & Organization

IBS, INCORPORATED

Assortments - Brass Pipe Fittings (O)



Poly-Push Composite Fractional Fittings for Nylon Tubing 3/8" & 1/2" <small>Assortment No. 337R</small>				
56266 3/8 COMPOSITE STRAIGHT UNION 	56264 3/8 X 1/4 COMPOSITE UNION RED 	56288 1/2 COMPOSITE STRAIGHT UNION 	57264 3/8 X 1/4 COMP M SWIV BR TEE 	57286 1/2 X 3/8 COMP M SWIV BR TEE
56466 3/8 COMPOSITE UNION TEE POLY 	56488 1/2 COMPOSITE UNION TEE POLY 	56566 3/8 COMPOSITE UNION ELBOW 	56588 1/2 COMPOSITE UNION ELBOW 	
56864 3/8 X 1/4 COMPOSITE M CONN 	56866 3/8 X 3/8 COMPOSITE M CONN 	56886 1/2 X 3/8 COMPOSITE M CONN 	56888 1/2 X 1/2 COMPOSITE M CONN 	
57964 3/8 X 1/4 COMP M SWIV ELBOW 	57966 3/8 X 3/8 COMP M SWIV ELBOW 	57986 1/2 X 3/8 COMP M SWIV ELBOW 	57988 1/2 X 1/2 COMP M SWIV ELBOW 	

PRODUCT CATEGORY: O

Hydraulic Hose Shields <small>Assortment No. 367R</small>			
18180 4" BLACK HOSE SHIELD 	18185 6" BLACK HOSE SHIELD 	18191 8" BLACK HOSE SHIELD 	18197 10" BLACK HOSE SHIELD
18181 4" ORANGE HOSE SHIELD 	18186 6" ORANGE HOSE SHIELD 	18192 8" ORANGE HOSE SHIELD 	
18182 4" YELLOW HOSE SHIELD 	18187 6" YELLOW HOSE SHIELD 	18193 8" YELLOW HOSE SHIELD 	

PRODUCT CATEGORY: O

Boss and For-Seal O-Ring Fittings Cap and Plugs <small>Assortment No. 736R</small>				
7237X4 1/4 O-RING BOSS PLUG 	7237X6 3/8 O-RING BOSS PLUG 	7237X8 1/2 O-RING BOSS PLUG 	7237X10 5/8 O-RING BOSS PLUG 	7237X12 3/4 O-RING BOSS PLUG
4229X4 1/4 FOR-SEAL PLUG 	4229X6 3/8 FOR-SEAL PLUG 	4229X8 1/2 FOR-SEAL PLUG 	4229X10 5/8 FOR-SEAL PLUG 	4229X12 3/4 FOR-SEAL PLUG
4129X4 1/4 FOR-SEAL CAP 	4129X6 3/8 FOR-SEAL CAP 	4129X8 1/2 FOR-SEAL CAP 	4129X10 5/8 FOR-SEAL CAP 	4129X12 3/4 FOR-SEAL CAP

PRODUCT CATEGORY: O

Poly-Push Composite Fractional Fittings for Nylon Tubing

3/8" & 1/2"
17 Items • 24 Pcs
IBS No. 337R



Packaged in a Locking Steel Drawer for Easy Storage & Organization

Hydraulic Hose Shields

10 Items • 25 Pcs
IBS No. 367R



Packaged in a Locking Steel Drawer for Easy Storage & Organization

Boss & For-Seal O-Ring Fittings Caps & Plugs

15 Items • 45 Pcs
IBS No. 736R



Packaged in a Locking Steel Drawer for Easy Storage & Organization

ASSORTMENTS



IBS, INCORPORATED

Assortments - Brass Pipe Fittings (O)

ASSORTMENTS

IBS, Inc. INDUSTRIAL PRODUCTS FOR MAINTENANCE & REPAIR INDUSTRIALBOLT.COM © © © 800-678-1906					Boss O-Ring Fittings
Assortment No. 737R					
C5315X4 1/4 X 1/4 MALE JIC TO MALE O-RING BOSS	C5315X4X6 1/4 X 3/8 MALE JIC TO MALE O-RING BOSS	C5315X6X4 3/8 X 1/4 MALE JIC TO MALE O-RING BOSS	C5315X6 3/8 X 3/8 MALE JIC TO MALE O-RING BOSS	C5315X6X8 3/8 X 1/2 MALE JIC TO MALE O-RING BOSS	
C5315X8X6 1/2 X 3/8 MALE JIC TO MALE O-RING BOSS	C5315X8 1/2 X 1/2 MALE JIC TO MALE O-RING BOSS	C5315X12X8 3/4 X 1/2 MALE JIC TO MALE O-RING BOSS	C5315X12 3/4 X 3/4 MALE JIC TO MALE O-RING BOSS		
C5515X4 1/4 MALE JIC TO MALE O-RING BOSS 90DG	C5515X6 3/8 MALE JIC TO MALE O-RING BOSS 90DG	C5515X6X8 3/8 X 1/2 MALE JIC TO MALE O-RING BOSS 90DG	C5515X8X6 1/2 X 3/8 MALE JIC TO MALE O-RING BOSS 90DG	C5515X8 1/2 MALE JIC TO MALE O-RING BOSS 90DG	
C5515X12 3/4 MALE JIC TO MALE O-RING BOSS 90DG					

PRODUCT CATEGORY: O

Boss O-Ring Fittings
15 Items • 46 Pcs
IBS No. 737R



Packaged in a Locking Steel Drawer for Easy Storage & Organization

IBS, Inc. INDUSTRIAL PRODUCTS FOR MAINTENANCE & REPAIR INDUSTRIALBOLT.COM © © © 800-678-1906					JIC Fitting Adapters
Assortment No. 738R					
C5229X4 1/4 JIC PLUG	C5129X4 1/4 JIC CAP	C5305X4 1/4 JIC UNION	C5205X4 1/4 X 1/8 JIC M. CONN	C5205X8 1/2 X 3/8 JIC M. CONN	
C5229X6 3/8 JIC PLUG	C5129X6 3/8 JIC CAP	C5305X6 3/8 JIC UNION	C5205X4X4 1/4 X 1/4 JIC M. CONN	C5205X8X8 1/2 X 1/2 JIC M. CONN	
C5229X8 1/2 JIC PLUG	C5129X8 1/2 JIC CAP	C5305X8 1/2 JIC UNION	C5205X6 3/8 X 1/4 JIC M. CONN		
C5229X12 3/4 JIC PLUG	C5129X12 3/4 JIC CAP	C5305X12 3/4 JIC UNION	C5205X6X6 3/8 X 3/8 JIC M. CONN		

PRODUCT CATEGORY: O

JIC Fitting Adapters
18 Items • 52 Pcs
IBS No. 738R



Packaged in a Locking Steel Drawer for Easy Storage & Organization

IBS, Inc. INDUSTRIAL PRODUCTS FOR MAINTENANCE & REPAIR INDUSTRIALBOLT.COM © © © 800-678-1906					Swivel Fittings
Assortment No. 739R					
9205X2X4 1/8 X 1/4 FEMALE PIPE SWIVEL TO MALE PIPE	9205X4X4 1/4 X 1/4 FEMALE PIPE SWIVEL TO MALE PIPE	9205X4X6 1/4 X 3/8 FEMALE PIPE SWIVEL TO MALE PIPE	9205X6X4 3/8 X 1/4 FEMALE PIPE SWIVEL TO MALE PIPE	9205X6X6 3/8 X 3/8 FEMALE PIPE SWIVEL TO MALE PIPE	
9205X6X8 3/8 X 1/2 FEMALE PIPE SWIVEL TO MALE PIPE	9205X8X6 1/2 X 3/8 FEMALE PIPE SWIVEL TO MALE PIPE	9205X8X8 1/2 X 1/2 FEMALE PIPE SWIVEL TO MALE PIPE			
9405X4X4 1/4 X 1/4 FEMALE PIPE SWIVEL TO MALE PIPE 90DG	9405X4X6 1/4 X 3/8 FEMALE PIPE SWIVEL TO MALE PIPE 90DG	9405X6X4 3/8 X 1/4 FEMALE PIPE SWIVEL TO MALE PIPE 90DG	9405X6X6 3/8 X 3/8 FEMALE PIPE SWIVEL TO MALE PIPE 90DG	9405X6X8 3/8 X 1/2 FEMALE PIPE SWIVEL TO MALE PIPE 90DG	
9405X8X6 1/2 X 3/8 FEMALE PIPE SWIVEL TO MALE PIPE 90DG	9405X8X8 1/2 X 1/2 FEMALE PIPE SWIVEL TO MALE PIPE 90DG				

PRODUCT CATEGORY: O

JIC Swivel Fittings
15 Items • 30 Pcs
IBS No. 739R



Packaged in a Locking Steel Drawer for Easy Storage & Organization

IBS, INCORPORATED

Assortments - Brass Pipe Fittings (O)



IBS, Inc. SPECIALTY PRODUCTS FOR MAINTENANCE & REPAIR INDUSTRIALBOLT.COM © © © 800-678-1906		Field Attachable Fittings	
Assortment No. 750R			
20620-6-6 5/16 X 3/8 JIC 37DGR F STRAIGHT SWIVEL	20820-8-8 13/32 X 1/2 SAE 45DGR F STRAIGHT SWIVEL	27920-4-4 3/16 X 1/4 SAE 45DGR FLARE F SWIVEL 90DGR ELBOW	
20620-8-8 13/32 X 1/2 JIC 37DGR F STRAIGHT SWIVEL	20820-10-10 1/2 X 5/8 SAE 45DGR F STRAIGHT SWIVEL	27920-6-6 5/16 X 3/8 SAE 45DGR FLARE F SWIVEL 90DGR ELBOW	
20820-4-4 3/16 X 1/4 SAE 45DGR F STRAIGHT SWIVEL	20120-8-8 13/32 X 1/2 MALE PIPE RIGID	27920-8-8 13/32 X 1/2 SAE 45DGR FLARE F SWIVEL 90DGR ELBOW	
20820-6-6 5/16 X 3/8 SAE 45DGR F STRAIGHT SWIVEL		27920-10-10 1/2 X 3/8 SAE 45DGR FLARE F SWIVEL 90DGR ELBOW	

PRODUCT CATEGORY: O

Field Attachable Fittings

11 Items • 19 Pcs
IBS No. 750R



Packaged in a Locking Steel Drawer for Easy Storage & Organization

IBS, Inc. SPECIALTY PRODUCTS FOR MAINTENANCE & REPAIR INDUSTRIALBOLT.COM © © © 800-678-1906		Spiral Hose Wrap	
Assortment 777R			
19000 1/2 X 8 SIN BLK HOSE WRAP FOR 1/4ID HYD HOSE	19002 5/8 X 8 SIN RED HOSE WRAP FOR 1/4ID AND 3/8ID HYD HOSE	19004 3/4 X 8 SIN YELLOW HOSE WRAP FOR 3/8ID HYD HOSE	19006 1IN X 8 SIN GREEN HOSE WRAP FOR 1/2ID AND 5/8ID HYD HOSE
19008 1-1/4IN X 8IN PURPLE HOSE WRAP FOR 3/4ID HYD HOSE	19010 1-1/2IN X 8IN GRAY HOSE WRAP FOR 1IN AND 1-1/4 IN HYD HOSE		

PRODUCT CATEGORY: O

Spiral Hose Wrap

6 Items • 21 Pcs
IBS No. 777R



Packaged in a Locking Steel Drawer for Easy Storage & Organization

IBS, Inc. SPECIALTY PRODUCTS FOR MAINTENANCE & REPAIR INDUSTRIALBOLT.COM © © © 800-678-1906		Hydraulic O-Ring Assortment	
Assortment No. 805R			
8X252 1/2 SPLIT FLANGE O-RING	12X252 3/4 SPLIT FLANGE O-RING	16X252 1" SPLIT FLANGE O-RING	20X252 1-1/4 SPLIT FLANGE O-RING
24X252 1-1/2 SPLIT FLANGE O-RING	32X252 2 SPLIT FLANGE O-RING	4629X4 1/4 FOR-SEAL O-RING	4629X6 3/8 FOR-SEAL O-RING
4629X8 1/2 FOR-SEAL O-RING	4629X10 5/8 FOR-SEAL O-RING	7629X4 1/4 O-RING BOSS STRAIGHT THREAD	7629X6 3/8 O-RING BOSS STRAIGHT THREAD
7629X8 1/2 O-RING BOSS STRAIGHT THREAD	7629X10 5/8 O-RING BOSS STRAIGHT THREAD	7629X12 3/4 O-RING BOSS STRAIGHT THREAD	7629X16 1IN O-RING BOSS STRAIGHT THREAD

PRODUCT CATEGORY: O

Hydraulic O-Ring Assortment

19 Items • 162 Pcs
IBS No. 805R



Packaged in a Locking Steel Drawer for Easy Storage & Organization

ASSORTMENTS



IBS, INCORPORATED

Assortments - Brass Pipe Fittings (O)

ASSORTMENTS

IBS, Inc.
SPECIALTY PRODUCTS FOR MAINTENANCE & REPAIR
INDUSTRIALDOT.COM © & D © 500-678-1506

Hydraulic Quick Couplers

Assortment No. 825R

<p>137782 1/2 X 1/2 ISO-A F PIPE COUPLER HYDRAULIC QUICK DISCONNECT</p>	<p>137784 3/4 X 3/4 ISO-A F PIPE COUPLER HYDRAULIC QUICK DISCONNECT</p>	<p>137786 1 X 1 ISO-A F PIPE COUPLER HYDRAULIC QUICK DISCONNECT</p>	<p>137787 1 X 1 ISO-A F PIPE PLUG HYDRAULIC QUICK DISCONNECT</p>
<p>137783 1/2 X 1/2 ISO-A F PIPE PLUG HYDRAULIC QUICK DISCONNECT</p>	<p>137785 3/4 X 3/4 ISO-A F PIPE PLUG HYDRAULIC QUICK DISCONNECT</p>		

Hydraulic Quick Couplers

6 Items • 12 Pcs
IBS No. 825R



Packaged in a Locking Steel Drawer
for Easy Storage & Organization

PRODUCT CATEGORY: O

IBS, Inc.
SPECIALTY PRODUCTS FOR MAINTENANCE & REPAIR
INDUSTRIALDOT.COM © & D © 500-678-1506

Gladhands

Assortment No. 826R

<p>393SER GLADHAND SERVICE</p>	<p>393EME GLADHAND EMERGENCY</p>	<p>393UNIV GLADHAND UNIVERSAL</p>	<p>37535 LOCTITE DIELECTRIC GREASE 30Z TUBE</p>
<p>394GLB GLADHAND SEAL SERVICE - BLUE</p>	<p>394GLR GLADHAND SEAL EMERGENCY - RED</p>	<p>394GL GLADHAND SEAL UNIVERSAL - BLACK</p>	

Glad Hands

7 Items • 22 Pcs
IBS No. 826R



Packaged in a Locking Steel Drawer
for Easy Storage & Organization

PRODUCT CATEGORY: O

IBS, Inc.
SPECIALTY PRODUCTS FOR MAINTENANCE & REPAIR
INDUSTRIALDOT.COM © & D © 500-678-1506

Composite DOT Push Connect Fittings - 1/4", 3/8" and 1/2"

Assortment No. 829R

<p>86018 1/4 X 1/4 COMPOSITE DOT 90DGR MALE ELBOW PUSH CONNECT</p>	<p>86022 3/8 X 3/8 COMPOSITE DOT 90DGR MALE ELBOW PUSH CONNECT</p>	<p>86026 1/2 X 1/2 COMPOSITE DOT 90DGR MALE ELBOW PUSH CONNECT</p>
<p>86017 1/4 X 1/8 COMPOSITE DOT 90DGR MALE ELBOW PUSH CONNECT</p>	<p>86021 3/8 X 1/4 COMPOSITE DOT 90DGR MALE ELBOW PUSH CONNECT</p>	<p>86025 1/2 X 3/8 COMPOSITE DOT 90DGR MALE ELBOW PUSH CONNECT</p>
<p>86004 1/4 X 1/4 COMPOSITE DOT MALE PUSH CONNECT</p>	<p>86008 3/8 X 3/8 COMPOSITE DOT MALE PUSH CONNECT</p>	<p>86012 1/2 X 1/2 COMPOSITE DOT MALE PUSH CONNECT</p>
<p>86003 1/4 X 1/8 COMPOSITE DOT MALE PUSH CONNECT</p>	<p>86007 3/8 X 1/4 COMPOSITE DOT MALE PUSH CONNECT</p>	<p>86011 1/2 X 3/8 COMPOSITE DOT MALE PUSH CONNECT</p>
<p>86086 1/4 X 9/16-18 COMPOSITE DOT BULKHEAD UNION PUSH CONNECT</p>	<p>86087 3/8 X 7/8-14 COMPOSITE DOT BULKHEAD UNION PUSH CONNECT</p>	<p>86088 1/2 X 1-12 COMPOSITE DOT BULKHEAD UNION PUSH CONNECT</p>
<p>86072 1/4 COMPOSITE DOT UNION PUSH CONNECT</p>	<p>86073 3/8 COMPOSITE DOT UNION PUSH CONNECT</p>	<p>86074 1/2 COMPOSITE DOT UNION PUSH CONNECT</p>

Composite Body DOT Air Brake Fittings

18 Items • 30 Pcs
IBS No. 829R



Packaged in a Locking Steel Drawer
for Easy Storage & Organization

PRODUCT CATEGORY: O

IBS, INCORPORATED

Assortments - Brass Pipe Fittings (O)



IBS, Inc. <small>SPECIALTY PRODUCTS FOR MAINTENANCE & REPAIR INDUSTRIALBOLTY.COM © © © 800-878-1906</small>				Air Brake Fittings For 3/8" Hose
<small>Assortment No. 844R</small>				
W15536 3/8 X 1/4 AIR BRAKE FOR HOSE MALE CONNECTOR W/ SPRING 	W15540 3/8 X 1/4 AIR BRAKE FOR HOSE MALE CONNECTOR 	W16678 3/8 AIR BRAKE FOR HOSE MENDER 	W33470 3/8 X 3/8 BRASS AIR HOSE CONN 	
W23907 3/8 X 3/8 AIR BRAKE FOR HOSE MALE CONNECTOR W/ SPRING 	W24887 3/8 X 3/8 AIR BRAKE FOR HOSE MALE CONNECTOR 	W03624 3/8 AIR BRAKE FOR HOSE NUT 	W15992 3/8 X 1/2 AIR BRAKE FOR HOSE INSERT 	
W15535 3/8 X 1/2 AIR BRAKE FOR HOSE MALE CONNECTOR W/ SPRING 	W15539 3/8 X 1/2 AIR BRAKE FOR HOSE MALE CONNECTOR 	W03613 3/8 AIR BRAKE FOR HOSE NUT FOR SPRING GUARD 	W03610 3/8 AIR BRAKE FOR HOSE SLEEVE 	

PRODUCT CATEGORY: O

IBS, Inc. <small>SPECIALTY PRODUCTS FOR MAINTENANCE & REPAIR INDUSTRIALBOLTY.COM © © © 800-878-1906</small>				Air Brake Fittings For 1/2" Hose
<small>Assortment No. 845R</small>				
W33885 1/2 X 3/8 AIR BRAKE FOR HOSE MALE CONNECTOR W/ SPRING 	W33883 1/2 X 3/8 AIR BRAKE FOR HOSE MALE CONNECTOR 	W33887 1/2 AIR BRAKE FOR HOSE MENDER 	W33889 1/2 X 1/2 AIR BRAKE FOR HOSE INSERT 	
W33886 1/2 X 1/2 AIR BRAKE FOR HOSE MALE CONNECTOR W/ SPRING 	W33884 1/2 X 1/2 AIR BRAKE FOR HOSE MALE CONNECTOR 	W33802 1/2 AIR BRAKE FOR HOSE NUT 	W33801 1/2 AIR BRAKE FOR HOSE SLEEVE 	
		W33803 1/2 AIR BRAKE FOR HOSE NUT FOR SPRING GUARD 		

PRODUCT CATEGORY: O

IBS, Inc. <small>SPECIALTY PRODUCTS FOR MAINTENANCE & REPAIR INDUSTRIALBOLTY.COM © © © 800-878-1906</small>				SAE 37° JIC Flare 90° Elbows
<small>Assortment No. 846R</small>				
C5405X4 1/4 X 1/8 JIC 90DGR M ELBOW 	C5405X4X4 1/4 X 1/4 JIC 90DGR M ELBOW 	C5405X5 5/16 X 1/8 JIC 90DGR M ELBOW 	C5405X5X4 5/16 X 1/4 JIC 90DGR M ELBOW 	
C5405X6X2 3/8 X 1/8 JIC 90DGR M ELBOW 	C5405X6 3/8 X 1/4 JIC 90DGR M ELBOW 	C5405X6X6 3/8 X 3/8 JIC 90DGR M ELBOW 		
C5405X8X4 1/2 X 1/4 JIC 90DGR M ELBOW 	C5405X8 1/2 X 3/8 JIC 90DGR M ELBOW 	C5405X8X8 1/2 X 1/2 JIC 90DGR M ELBOW 		
C5405X10X6 5/8 X 3/8 JIC 90DGR M ELBOW 	C5405X10 5/8 X 1/2 JIC 90DGR M ELBOW 		C5405X12 3/4 X 3/4 JIC 90DGR M ELBOW 	

PRODUCT CATEGORY: O

Air Brake Fittings for 3/8" Hose

12 Items • 30 Pcs
IBS No. 844R



Packaged in a Locking Steel Drawer for Easy Storage & Organization

Air Brake Fittings for 1/2" Hose

9 Items • 22 Pcs
IBS No. 845R



Packaged in a Locking Steel Drawer for Easy Storage & Organization

SAE 37° JIC Flare 90° Elbows

13 Items • 23 Pcs
IBS No. 846R



Packaged in a Locking Steel Drawer for Easy Storage & Organization

ASSORTMENTS



IBS, INCORPORATED

Assortments - Brass Pipe Fittings (O)



For-Seal to Straight-Thread O-Ring Fittings

Assortment No. 847R

For-Seal to Straight Thread O-Ring Fittings

15 Items • 22 Pcs
IBS No. 847R



Packaged in a Locking Steel Drawer for Easy Storage & Organization

4315X4 1/4 X 1/4 MALE FACE SEAL TO STRAIGHT THREAD O-RING CONNECTOR	4315X6 3/8 X 3/8 MALE FACE SEAL TO STRAIGHT THREAD O-RING CONNECTOR	4315X8 1/2 X 1/2 MALE FACE SEAL TO STRAIGHT THREAD O-RING CONNECTOR	4315X10 3/4 X 3/4 MALE FACE SEAL TO STRAIGHT THREAD O-RING CONNECTOR	4315X12 5/8 X 5/8 MALE FACE SEAL TO STRAIGHT THREAD O-RING CONNECTOR
4365X4 1/4 45DGR FOR SEAL TO STRT THREAD O-RING CONN	4365X6 3/8 45DGR FOR SEAL TO STRT THREAD O-RING CONN	4365X8 1/2 45DGR FOR SEAL TO STRT THREAD O-RING CONN	4365X10 5/8 45DGR FOR SEAL TO STRT THREAD O-RING CONN	4365X12 3/4 45DGR FOR SEAL TO STRT THREAD O-RING CONN
4515X4 1/4 X 1/4 90DGR FOR-SEAL TO STRAIGHT THREAD O-RING CONN	4515X6 3/8 X 3/8 90DGR FOR-SEAL TO STRAIGHT THREAD O-RING CONN	4515X8 1/2 X 1/2 90DGR FOR-SEAL TO STRAIGHT THREAD O-RING CONN	4515X10 5/8 X 5/8 90DGR FOR-SEAL TO STRAIGHT THREAD O-RING CONN	4515X12 3/4 X 3/4 90DGR FOR-SEAL TO STRAIGHT THREAD O-RING CONN

PRODUCT CATEGORY: O

A
S
S
O
R
T
M
E
N
T
S

IBS, INCORPORATED

Assortments - Abrasives (PA)



IBS, Inc. SPECIALTY PRODUCTS FOR MAINTENANCE & REPAIR INDUSTRIALBOLT.COM © 2012 800-878-1996					Flap Wheels
					Assortment No. 398R
65056 3/4 X 3/4 120G FLAP WHEEL	65029 1 X 1 120G FLAP WHEEL	65036 1-1/2 X 1 120G FLAP WHEEL	65044 2 X 1 120G FLAP WHEEL	65052 3 X 1 120G FLAP WHEEL	
65055 3/4 X 3/4 80G FLAP WHEEL	65025 1 X 1 80G FLAP WHEEL	65034 1-1/2 X 1 80G FLAP WHEEL	65042 2 X 1 80G FLAP WHEEL	65050 3 X 1 80G FLAP WHEEL	
65054 3/4 X 3/4 60G FLAP WHEEL	65021 1 X 1 60G FLAP WHEEL	65030 1-1/2 X 1 60G FLAP WHEEL	65038 2 X 1 60G FLAP WHEEL	65046 3 X 1 60G FLAP WHEEL	
65053 3/4 X 3/4 40G FLAP WHEEL	65023 1 X 1 40G FLAP WHEEL	65032 1-1/2 X 1 40G FLAP WHEEL	65037 2 X 1 40G FLAP WHEEL	65045 3 X 1 40G FLAP WHEEL	

PRODUCT CATEGORY: PA

Flap Wheels

12 Items • 33 Pcs
IBS No. 398R



Packaged in a Locking Steel Drawer for Easy Storage & Organization

IBS, Inc. SPECIALTY PRODUCTS FOR MAINTENANCE & REPAIR INDUSTRIALBOLT.COM © 2012 800-878-1996					Roloc Style Surface Prep Discs with 1/4 Angle Air Die Grinder
					Assortment No. 501P
06521 2" Fine Surface Conditioning Disc	06532 3" Medium Surface Conditioning Disc	06535 3" Roloc Back Pad	CA-14050 1/4 Angle Air Die Grinder	06525 2" Roloc Back Pad	
06522 2" Medium Surface Conditioning Disc	06533 3" Coarse Surface Conditioning Disc	68024 3" 80 Grit Tapered Bristle Disc	68018 2" 50 Grit Tapered Bristle Disc		
06523 2" Coarse Surface Conditioning Disc	09420 2" 80 Grit Zirconium Grinding Disc	36699 3" 80 Grit Zirc Plus Grinding Disc	06531 3" Fine Surface Conditioning Disc		
09415 2" 60 Grit Zirconium Grinding Disc	09410 2" 36 Grit Zirconium Grinding Disc	36695 3" 36 Grit Zirc Plus Grinding Disc			

PRODUCT CATEGORY: PA

Roloc™ Style Surface Prep Discs with 1/4" Angle Air Die Grinder

17 Items • 64 Pcs
IBS No. 501P



Packaged in a Locking Steel Drawer for Easy Storage & Organization

IBS, Inc. SPECIALTY PRODUCTS FOR MAINTENANCE & REPAIR INDUSTRIALBOLT.COM © 2012 800-878-1996					Roloc Style Surface Prep Discs
					Assortment No. 504P
06521 2" Fine Surface Conditioning Disc	06532 3" Medium Surface Conditioning Disc	06535 3" Roloc Back Pad	CA-14050 1/4 Angle Air Die Grinder	06525 2" Roloc Back Pad	
06522 2" Medium Surface Conditioning Disc	06533 3" Coarse Surface Conditioning Disc	68024 3" 80 Grit Tapered Bristle Disc	68018 2" 50 Grit Tapered Bristle Disc		
06523 2" Coarse Surface Conditioning Disc	09420 2" 80 Grit Zirconium Grinding Disc	36699 3" 80 Grit Zirc Plus Grinding Disc	06531 3" Fine Surface Conditioning Disc		
09415 2" 60 Grit Zirconium Grinding Disc	09410 2" 36 Grit Zirconium Grinding Disc	36695 3" 36 Grit Zirc Plus Grinding Disc			

PRODUCT CATEGORY: PA

2" & 3" Roloc™ Surface Prep Assortment

16 Items • 66 Pcs
IBS No. 504P



Packaged in a Locking Steel Drawer for Easy Storage & Organization

ASSORTMENTS



IBS, INCORPORATED

Assortments - Abrasives (PA)

ASSORTMENTS

IBS, Inc. <small>SPECIALTY PRODUCTS FOR MAINTENANCE & REPAIR INDUSTRIALBOLT.COM © © © 800-678-1996</small>			Super Stripper Roloc™ Coating Removal Discs <small>Assortment No. 519P</small>
06525 2 ROLOC BACKING PAD* 	06535 3 ROLOC BACKING PAD* 	06545 4 ROLOC BACKING PAD* 	
06720 2 ROLOC COATING REMOVAL DISC* 	06730 3 ROLOC COATING REMOVAL DISC* 	06740 4 ROLOC COATING REMOVAL DISC* 	

PRODUCT CATEGORY: PA

IBS, Inc. <small>SPECIALTY PRODUCTS FOR MAINTENANCE & REPAIR INDUSTRIALBOLT.COM © © © 800-678-1996</small>			Roloc Surface Conditioning Discs <small>Assortment No. 523P</small>
06521 2IN FINE ROLOC SURF COND DISC 	06531 3IN FINE ROLOC SURF COND DISC 	06545 4IN ROLOC BACKING PAD 	
06522 2IN MED ROLOC SURF COND DISC 	06532 3IN MED ROLOC SURF COND DISC 	06542 4IN MED ROLOC SURF COND DISC 	
06523 2IN CRS ROLOC SURF COND DISC 	06533 3IN CRS ROLOC SURF COND DISC 	06543 4IN CRS ROLOC SURF COND DISC 	06535 3IN ROLOC BACKING PAD 06525 2IN ROLOC BACKING PAD

PRODUCT CATEGORY: PA

IBS, Inc. <small>SPECIALTY PRODUCTS FOR MAINTENANCE & REPAIR INDUSTRIALBOLT.COM © © © 800-678-1996</small>			3" Roloc™ Total Surface Prep Discs <small>Assortment No. 529P</small>
40423 3IN MED ROLOC X-TOUGH CERAMIC SURF DISC 	40339 3IN 80G ROLOC CERAMIC GRAIN GRIND DISC 	38862 3IN V FINE ROLOC HI STRENGTH SATIN DISC 	06535 3IN ROLOC BACKING PAD
40422 3IN CRS ROLOC X-TOUGH CERAMIC SURF DISC 	40338 3IN 60G ROLOC CERAMIC GRAIN GRIND DISC 	38861 3IN FINE ROLOC HI STRENGTH SATIN DISC 	
06730 3IN ROLOC SUPER STRIPPER COATING REMOVAL DISC 	40335 3IN 36G ROLOC CERAMIC GRAIN GRIND DISC 	38860 3IN MED ROLOC HI STRENGTH SATIN DISC 	

PRODUCT CATEGORY: PA

Super Stripper Roloc™ Coating Removal Discs

6 Items • 15 Pcs
IBS No. 519P



Packaged in a Locking Steel Drawer for Easy Storage & Organization

Roloc™ Surface Conditioning Discs

11 Items • 56 Pcs
IBS No. 523P



Packaged in a Locking Steel Drawer for Easy Storage & Organization

3" Roloc™ Total Surface Prep

10 Items • 58 Pcs
IBS No. 529P



Packaged in a Locking Steel Drawer for Easy Storage & Organization

IBS, INCORPORATED

Assortments - Abrasives (PA)



IBS, Inc.
SPECIALTY PRODUCTS FOR MAINTENANCE & REPAIR
INDUSTRIALBOLTY.COM © © © 800-678-1906

Roloc Bristle Discs

Assortment No. 534P

<p>68018 2IN 50G TAPERED BRISTLE DISC ROLOC DISC GREEN 25000RPM</p>	<p>68025 3IN 50G TAPERED BRISTLE DISC ROLOC DISC GREEN 15000RPM</p>	<p>06535 3IN ROLOC BACKING PAD</p>	
<p>68017 2IN 80G TAPERED BRISTLE DISC ROLOC DISC YELLOW 25000RPM</p>	<p>68024 3IN 80G TAPERED BRISTLE DISC ROLOC DISC YELLOW 15000RPM</p>	<p>06525 2IN ROLOC BACKING PAD</p>	

Roloc Bristle Discs & Backing Pads

6 Items • 12 Pcs
IBS No. 534P



Packaged in a Locking Steel Drawer for Easy Storage & Organization

PRODUCT CATEGORY: PA

IBS, Inc.
SPECIALTY PRODUCTS FOR MAINTENANCE & REPAIR
INDUSTRIALBOLTY.COM © © © 800-678-1906

Trim-Kut Discs

Assortment No. 537P

<p>69336 3IN 36G MID ALLOY TRIM KUT DISC</p>	<p>69360 3IN 60G MID ALLOY TRIM-KUT DISC</p>	<p>69399 3IN 120G MID ALLOY TRIM-KUT DISC</p>	

Trim-Kut Discs

4 Items • 76 Pcs
IBS No. 537P



Packaged in a Locking Steel Drawer for Easy Storage & Organization

PRODUCT CATEGORY: PA

IBS, Inc.
SPECIALTY PRODUCTS FOR MAINTENANCE & REPAIR
INDUSTRIALBOLTY.COM © © © 800-678-1906

Roloc Surface Conditioning Discs w/ Angle Air Die Grinder

Assortment No. 541P

<p>06521 2 FINE ROLOC SURF COND DISC</p>	<p>06531 3 FINE ROLOC SURF COND DISC</p>	<p>40420 2 CRS ROLOC X-TOUGH CERAMIC</p>	<p>06535 3 ROLOC BACKING PAD</p>
<p>06522 2 MED ROLOC SURF COND DISC</p>	<p>06532 3 MED ROLOC SURF COND DISC</p>	<p>40421 2 MED ROLOC X-TOUGH CERAMIC</p>	
<p>06523 2 CRS ROLOC SURF COND DISC</p>	<p>06533 3 CRS ROLOC SURF COND DISC</p>	<p>40422 3 CRS ROLOC X-TOUGH CERAMIC</p>	<p>CA-14050 1/4 ANGLE AIR DIE GRINDER</p>
<p>06525 2 ROLOC BACKING PAD</p>	<p>40423 3 MED ROLOC X-TOUGH CERAMIC</p>		

Roloc Surface Conditioning Discs with Angle Air Die Grinder

13 Items • 53 Pcs
IBS No. 541P



Packaged in a Locking Steel Drawer for Easy Storage & Organization

PRODUCT CATEGORY: PA

ASSORTMENTS



IBS, INCORPORATED

Assortments - Abrasives (PA)

ASSORTMENTS

IBS, Inc. <small>SPECIALTY PRODUCTS FOR MAINTENANCE & REPAIR INDUSTRIALBOLT.COM © © © 800-678-1906</small>				Roloc Surface Conditioning Discs			
				Assortment No. 542P			
06521 2 FINE ROLOC SURF COND DISC 	06531 3 FINE ROLOC SURF COND DISC 	40420 2 CRS ROLOC X-TOUGH CERAMIC 	06535 3 ROLOC BACKING PAD 	40421 2 MED ROLOC X-TOUGH CERAMIC 			
06522 2 MED ROLOC SURF COND DISC 	06532 3 MED ROLOC SURF COND DISC 	40422 3 CRS ROLOC X-TOUGH CERAMIC 					
06523 2 CRS ROLOC SURF COND DISC 	06533 3 CRS ROLOC SURF COND DISC 	40423 3 MED ROLOC X-TOUGH CERAMIC 					
06525 2 ROLOC BACKING PAD 							

PRODUCT CATEGORY: PA

Roloc Surface Conditioning Discs
12 Items • 52 Pcs
IBS No. 542P



Packaged in a Locking Steel Drawer
for Easy Storage & Organization

IBS, Inc. <small>SPECIALTY PRODUCTS FOR MAINTENANCE & REPAIR INDUSTRIALBOLT.COM © © © 800-678-1906</small>				2" & 3" Roloc Satin Discs			
				Assortment No. 546P			
38859 2" V FINE ROLOC HI STRENGTH 	38861 3" FINE ROLOC HI STRENGTH 	06535 3" ROLOC STYLE BACKING PAD 					
38858 2" FINE ROLOC HI STRENGTH 	38860 3" MED ROLOC HI STRENGTH 	06525 2" ROLOC STYLE BACKING PAD 					
38857 2" MED ROLOC HI STRENGTH 	38862 3" V FINE ROLOC HI STRENGTH 						

PRODUCT CATEGORY: O

2" & 3" Roloc Satin Discs

8 Items • 62 Pcs
IBS No. 546P



Packaged in a Locking Steel Drawer
for Easy Storage & Organization

IBS, Inc. <small>SPECIALTY PRODUCTS FOR MAINTENANCE & REPAIR INDUSTRIALBOLT.COM © © © 800-678-1906</small>				3" Roloc Grinding Discs			
				Assortment No. 548P			
09440 3 80G ROLOC ZIRC DISC* 	36699 3 80G ROLOC ZIRC+ GRINDING* 	40339 3 80G ROLOC CERAMIC GRAIN* 					
09435 3 60G ROLOC ZIRC DISC* 	36698 3 60G ROLOC ZIRC+ GRINDING* 	40338 3 60G ROLOC CERAMIC GRAIN* 					
09430 3 36G ROLOC ZIRC DISC* 	36695 3 36G ROLOC ZIRC+ GRINDING* 	40335 3 36G ROLOC CERAMIC GRAIN* 	06535 3 ROLOC BACKING PAD* 				

PRODUCT CATEGORY: PA

3" Roloc Grinding Discs
9 Items • 15 Pcs
IBS No. 548P



Packaged in a Locking Steel Drawer
for Easy Storage & Organization

IBS, INCORPORATED

Assortments - Abrasives (PA)



 IBS, Inc. <small>SPECIALTY PRODUCTS FOR MAINTENANCE & REPAIR INDUSTRIALBOLT.COM © © © 800-678-1506</small>				Stem Mounted Wire Brushes 1/4" Shank Assortment No. 702R	
50074 1/2 .006 SOLID END BRUSH 1/4 SHANK 7/8 TRIM STEEL 	50078 1 .020 SOLID END BRUSH 1/4 SHANK 1-1/8 TRIM STEEL 	50066 3 .008 CIRCULAR FLARED END 1 SHANK CIRC CRIMP STEEL 	50067 1-1/2 .0118 CONFLX WIRE WHEEL 1/4" SHANK 	   	
50077 3/4 .020 SOLID END BRUSH 1/4 SHANK 7/8 TRIM STEEL 	50065 1-1/2 FLARED END BRUSH 1/4 SHANK CIRC CRIMP STEEL 	04300 1-3/4 .006 WIRE CUP BRUSH 1/4 SHANK CRIMP 3/4 TRIM STEEL 	50069 3 .0118 CONFLX WIRE WHEEL 1/4 SHANK 	   	

PRODUCT CATEGORY: PA

Stem Mounted Wire Brushes

1/4" SHANK
8 Items • 8 Pcs
IBS No. 702R



Packaged in a Locking Steel Drawer for Easy Storage & Organization

 IBS, Inc. <small>SPECIALTY PRODUCTS FOR MAINTENANCE & REPAIR INDUSTRIALBOLT.COM © © © 800-678-1506</small>		Scratch Brushes Assortment No. 703R	
50088 4 X 16 SHOE HANDLE SCRATCH BRUSH 			
50089 4 X 16 SS SHOE HANDLE SCRATCH BRUSH 			
50090 4 X 18 BRASS SHOE HANDLE SCRATCH BRUSH 			
50091 3 X 7 SS SMALL SCRATCH BRUSH 	50092 3 X 7 BRASS SMALL SCRATCH BRUSH 	 	
50093 3 X 7 NYLON SMALL SCRATCH BRUSH 	44088 5/16 ACID BRUSH 	 	
44089 3/8 ACID BRUSH 	44090 1/2 ACID BRUSH 	 	















PRODUCT CATEGORY: PA

Scratch Brushes

9 Items • 45 Pcs
IBS No. 703R



Packaged in a Locking Steel Drawer for Easy Storage & Organization

 IBS, Inc. <small>SPECIALTY PRODUCTS FOR MAINTENANCE & REPAIR INDUSTRIALBOLT.COM © © © 800-678-1506</small>				Roloc™ Surface Conditioning Discs 3/4" to 4" Assortment No. 705R	
06516 3/4 FINE ROLOC SURF COND DISC 	06521 2IN FINE ROLOC SURF COND DISC 	06531 3IN FINE ROLOC SURF COND DISC 	06542 4IN MED ROLOC SURF COND DISC 		
06517 3/4 MED ROLOC SURF COND DISC 	06522 2IN MED ROLOC SURF COND DISC 	06532 3IN MED ROLOC SURF COND DISC 			
06518 3/4 CRS ROLOC SURF COND DISC 	06523 2IN CRS ROLOC SURF COND DISC 	06533 3IN CRS ROLOC SURF COND DISC 	06543 4IN CRS ROLOC SURF COND DISC 		
					

PRODUCT CATEGORY: PA

3/4" - 4" Roloc Surface Conditioning Discs

11 Items • 49 Pcs
IBS No. 705R



Packaged in a Locking Steel Drawer for Easy Storage & Organization



IBS, INCORPORATED

Assortments - Abrasives (PA)

ASSORTMENTS

IBS, Inc. <small>SPECIALTY PRODUCTS FOR MAINTENANCE & REPAIR INDUSTRIALBOLT.COM © © © 800-878-1506</small>				Roloc™ Surface Conditioning Discs 3/4" to 3"
<small>Assortment No. 707R</small>				
06516 3/4 FINE ROLOC SURF COND DISC 	06517 3/4 MED ROLOC SURF COND DISC 	06518 3/4 CRS ROLOC SURF COND DISC 	06520 3/4 ROLOC STYLE BACKING PAD 	
06521 2" FINE ROLOC SURF COND DISC 	06522 2" MED ROLOC STYLE SURF COND 	06523 2" CRS ROLOC STYLE SURF COND 	06525 2" ROLOC STYLE BACKING PAD 	
06531 3" FINE ROLOC SURF COND DISC 	06532 3" MED ROLOC STYLE SURF COND 	06533 3" CRS ROLOC STYLE SURF COND 	06535 3" ROLOC STYLE BACKING PAD 	

PRODUCT CATEGORY: PA

Roloc Surface Conditioning Discs
3/4" to 3"
12 Items • 48 Pcs
IBS No. 707R



Packaged in a Locking Steel Drawer for Easy Storage & Organization

IBS, Inc. <small>SPECIALTY PRODUCTS FOR MAINTENANCE & REPAIR INDUSTRIALBOLT.COM © © © 800-878-1506</small>				Flap Bands
<small>Assortment No. 733R</small>				
51022 1-1/4 X 3/4 FLAP BAND 40G 	51162 1-3/4 X 1-3/16 FLAP BAND 40G 	51262 2-1/2 X 1-3/16 FLAP BAND 40G 		
51024 1-1/4 X 3/4 FLAP BAND 60G 	51164 1-3/4 X 1-3/16 FLAP BAND 60G 	51264 2-1/2 X 1-3/16 FLAP BAND 60G 		
50950 1-1/4 X 3/4 FLAP BAND RUBBER EXPANDING DRUM 	50954 1-3/4 X 1-3/16 FLAP BAND RUBBER EXPANDING DRUM 	50956 2-1/2 X 1-3/16 FLAP BAND RUBBER EXPANDING DRUM 		

PRODUCT CATEGORY: PA

Flap Bands
9 Items • 15 Pcs
IBS No. 733R



Packaged in a Locking Steel Drawer for Easy Storage & Organization

IBS, Inc. <small>SPECIALTY PRODUCTS FOR MAINTENANCE & REPAIR INDUSTRIALBOLT.COM © © © 800-878-1506</small>				Flap Bands with Air Die Grinder w/Regulator
<small>Assortment No. 734R</small>				
51022 1-1/4 X 3/4 FLAP BAND 40G 	51162 1-3/4 X 1-3/16 FLAP BAND 40G 	51262 2-1/2 X 1-3/16 FLAP BAND 40G 	69283 1/4 AIR DIE GRINDER W/REGULATOR 	
51024 1-1/4 X 3/4 FLAP BAND 60G 	51164 1-3/4 X 1-3/16 FLAP BAND 60G 	51264 2-1/2 X 1-3/16 FLAP BAND 60G 		
50950 1-1/4 X 3/4 FLAP BAND RUBBER EXPANDING DRUM 	50954 1-3/4 X 1-3/16 FLAP BAND RUBBER EXPANDING DRUM 	50956 2-1/2 X 1-3/16 FLAP BAND RUBBER EXPANDING DRUM 		

PRODUCT CATEGORY: PA

Flap Bands with Air Die Grinder with Regulator
9 Items • 15 Pcs
IBS No. 734R



Packaged in a Locking Steel Drawer for Easy Storage & Organization

IBS, INCORPORATED

Assortments - Abrasives (PA)



IBS, Inc. SPECIALTY PRODUCTS FOR MAINTENANCE & REPAIR INDUSTRIALBOLT.COM • 800-678-1906			2" & 3" Roloc Satin & Felt Discs	
Assortment No. 759R				
38857 2IN MED ROLOC HI STRENGTH SATIN DISC	38860 3IN MED ROLOC HI STRENGTH SATIN DISC	37755 2IN ROLOC MINI FELT FLAP DISC		
38858 2IN FINE ROLOC HI STRENGTH SATIN DISC	38861 3IN FINE ROLOC HI STRENGTH SATIN DISC	37757 3IN ROLOC MINI FELT FLAP DISC		
38859 2IN V FINE ROLOC HI STRENGTH SATIN DISC	38862 3IN V FINE ROLOC HI STRENGTH SATIN DISC	06525 2IN ROLOC BACKING PAD		
		06535 3IN ROLOC BACKING PAD		
			74206 GRAY POLISHING COMPOUND FOR FELT DISCS	

PRODUCT CATEGORY: PA

2" & 3" Satin & Felt Discs

12 Items • 52 Pcs
IBS No. 759R



Packaged in a Locking Steel Drawer for Easy Storage & Organization

IBS, Inc. SPECIALTY PRODUCTS FOR MAINTENANCE & REPAIR INDUSTRIALBOLT.COM • 800-678-1906			Surface Conditioning Bands	
Assortment No. 774R				
51029 1/2 X 1/2 SURFACE CONDITIONING BAND COARSE	51034 1 X 1 SURFACE CONDITIONING BAND COARSE	51039 1-1/2 X 1 SURFACE CONDITIONING BAND COARSE		
51030 1/2 X 1/2 SURFACE CONDITIONING BAND MEDIUM	51035 1 X 1 SURFACE CONDITIONING BAND MEDIUM	51040 1-1/2 X 1 SURFACE CONDITIONING BAND MEDIUM		
51031 1/2 X 1/2 SURFACE CONDITIONING BAND VERY FINE	51036 1 X 1 SURFACE CONDITIONING BAND VERY FINE	51041 1-1/2 X 1 SURFACE CONDITIONING BAND VERY FINE		
51032 1/2 X 1/2 SURFACE CONDITIONING BAND DRUM	51037 1 X 1 SURFACE CONDITIONING BAND DRUM	51042 1-1/2 X 1 SURFACE CONDITIONING BAND DRUM		

PRODUCT CATEGORY: PA

Surface Conditioning Bands

12 Items • 40 Pcs
IBS No. 774R



Packaged in a Locking Steel Drawer for Easy Storage & Organization

IBS, Inc. SPECIALTY PRODUCTS FOR MAINTENANCE & REPAIR INDUSTRIALBOLT.COM • 800-678-1906			TriFlex Quick Change Discs	
Assortment No. 795R				
40351 2" 24G TRIFLEX QUICK CHANGE DISC	40352 2" 36G TRIFLEX QUICK CHANGE DISC	40353 2" 54G TRIFLEX QUICK CHANGE DISC		
40354 2" 80G TRIFLEX QUICK CHANGE DISC	40355 2" 120G TRIFLEX QUICK CHANGE DISC	06525 2 ROLOC BACKING PAD*		
40356 3" 24G TRIFLEX QUICK CHANGE DISC	40357 3" 36G TRIFLEX QUICK CHANGE DISC	40358 3" 54G TRIFLEX QUICK CHANGE DISC		
40359 3" 80G TRIFLEX QUICK CHANGE DISC	40360 3" 120G TRIFLEX QUICK CHANGE DISC	06535 3 ROLOC BACKING PAD*		

PRODUCT CATEGORY: PA

Tri-Flex Quick Change Disc Assortment

12 Items • 34 Pcs
IBS No. 795R



Packaged in a Locking Steel Drawer for Easy Storage & Organization



IBS, INCORPORATED

Assortments - Abrasives (PA)

ASSORTMENTS

IBS, Inc.
SPECIALTY PRODUCTS FOR MAINTENANCE & REPAIR
INDUSTRIALBOLT.COM © © © 800-678-1906

Power Tube Brushes

Assortment 816R

50080 5/8 .006 POWER TUBE BRUSH	50081 1/2 .006 POWER TUBE BRUSH	50082 5/8 .005 POWER TUBE BRUSH	50083 3/4 .006 POWER TUBE BRUSH	50084 1" .006 POWER TUBE BRUSH	50085 1-1/4" .0104 POWER TUBE BRUSH
------------------------------------	------------------------------------	------------------------------------	------------------------------------	-----------------------------------	--

Power Tube Brushes
6 Items • 6 Pcs
IBS No. 816R



Packaged in a Locking Steel Drawer
for Easy Storage & Organization

PRODUCT CATEGORY: PA

IBS, Inc.
SPECIALTY PRODUCTS FOR MAINTENANCE & REPAIR
INDUSTRIALBOLT.COM © © © 800-678-1906

SilverBack Roloc Disc

Assortment No. 821R

50016 2IN 40G ROLOC SILVERBACK FLAP DISC	50017 2IN 60G ROLOC SILVERBACK FLAP DISC	50018 2IN 80G ROLOC SILVERBACK FLAP DISC	50019 2IN 120G ROLOC SILVERBACK FLAP DISC
50020 3IN 40G ROLOC SILVERBACK FLAP DISC	50021 3IN 60G ROLOC SILVERBACK FLAP DISC	50022 3IN 80G ROLOC SILVERBACK FLAP DISC	50023 3IN 120G ROLOC SILVERBACK FLAP DISC
06525 2IN ROLOC BACKING PAD	06535 3IN ROLOC BACKING PAD		

Silverback Roloc Discs
10 Items • 22 Pcs
IBS No. 821R



Packaged in a Locking Steel Drawer
for Easy Storage & Organization

PRODUCT CATEGORY: PA

IBS, Inc.
SPECIALTY PRODUCTS FOR MAINTENANCE & REPAIR
INDUSTRIALBOLT.COM © © © 800-678-1906

Solid Roloc Ceramic+ Grinding Discs

Assortment No. 827R

36600 2IN 36G SOLID ROLOC CERAMIC+ GRINDING DISC	36602 2IN 60G SOLID ROLOC CERAMIC+ GRINDING DISC	36603 2IN 80G SOLID ROLOC CERAMIC+ GRINDING DISC	36605 2IN 120G SOLID ROLOC CERAMIC+ GRINDING DISC
36607 3IN 36G SOLID ROLOC CERAMIC+ GRINDING DISC	36609 3IN 60G SOLID ROLOC CERAMIC+ GRINDING DISC	36610 3IN 80G SOLID ROLOC CERAMIC+ GRINDING DISC	36612 3IN 120G SOLID ROLOC CERAMIC+ GRINDING DISC
06525 2IN ROLOC BACKING PAD	06535 3IN ROLOC BACKING PAD		

Solid Roloc Ceramic + Grinding Discs
10 Items • 42 Pcs
IBS No. 827R



Packaged in a Locking Steel Drawer
for Easy Storage & Organization

PRODUCT CATEGORY: PA

IBS, INCORPORATED

Assortments - Abrasives (PA)



 Solid Roloc Zirconia+ Grinding Discs			
Assortment No. 828R			
36620 2IN 36G SOLID ROLOC ZIRC+ GRINDING DISC 	36622 2IN 60G SOLID ROLOC ZIRC+ GRINDING DISC 	36623 2IN 80G SOLID ROLOC ZIRC+ GRINDING DISC 	36625 2IN 120G SOLID ROLOC ZIRC+ GRINDING DISC 
36627 3IN 36G SOLID ROLOC ZIRC+ GRINDING DISC 	36629 3IN 60G SOLID ROLOC ZIRC+ GRINDING DISC 	36630 3IN 80G SOLID ROLOC ZIRC+ GRINDING DISC 	36632 3IN 120G SOLID ROLOC ZIRC+ GRINDING DISC 
06525 2IN ROLOC BACKING PAD 	06535 3IN ROLOC BACKING PAD 		







PRODUCT CATEGORY: PA

Solid Roloc Zirconia+ Grinding Discs

10 Items • 42 Pcs
IBS No. 828R



Packaged in a Locking Steel Drawer for Easy Storage & Organization

 Stem Thread Brushes				
Assortment No. 839R				
50031 3/8" .012 1/4 STEM THREAD BRUSH COATED STEEL 	50032 1/2" .012 1/4 STEM THREAD BRUSH COATED STEEL 	50033 5/8" .012 1/4 STEM THREAD BRUSH COATED STEEL 	50034 3/4" .012 1/4 STEM THREAD BRUSH COATED STEEL 	50095 7/8" .012 1/4 STEM THREAD BRUSH COATED STEEL 















PRODUCT CATEGORY: PA

Stem Thread Cleaning Brushes

5 Items • 5 Pcs
IBS No. 839R



Packaged in a Locking Steel Drawer for Easy Storage & Organization

 Ceramic Roloc Flex Flap and Mini Flap Discs			
Assortment No. 841R			
67340 3IN 40GRIT CERAMIC FLEX FLAP ROLOC 	67360 3IN 60GRIT CERAMIC FLEX FLAP ROLOC 	67380 3IN 80GRIT CERAMIC FLEX FLAP ROLOC 	
64340 3IN 40GRIT CERAMIC MINI FLAP ROLOC 	64360 3IN 60GRIT CERAMIC MINI FLAP ROLOC 	64380 3IN 80GRIT CERAMIC MINI FLAP ROLOC 	
67240 2IN 40GRIT CERAMIC FLEX FLAP ROLOC 	67260 2IN 60GRIT CERAMIC FLEX FLAP ROLOC 	67280 2IN 80GRIT CERAMIC FLEX FLAP ROLOC 	06535 3IN ROLOC BACKING PAD 
64240 2IN 40GRIT CERAMIC MINI FLAP ROLOC 	64260 2IN 60GRIT CERAMIC MINI FLAP ROLOC 	64280 2IN 80GRIT CERAMIC MINI FLAP ROLOC 	06525 2IN ROLOC BACKING PAD 

PRODUCT CATEGORY: PA

Ceramic Roloc Flex Flap & Mini Flap Discs

14 Items • 30 Pcs
IBS No. 841R



Packaged in a Locking Steel Drawer for Easy Storage & Organization

ASSORTMENTS



IBS, INCORPORATED

Assortments - Abrasives (PA)



Sanding Belts
1/2 x 18

Assortment No. 848R

35036 1/2 X 18 36G ZIRC+ SANDING BELT	
35060 1/2 X 18 60G ZIRC+ SANDING BELT	
35080 1/2 X 18 80G ZIRC+ SANDING BELT	35120 1/2 X 18 120G ZIRC+ SANDING BELT
35001 1/2 X 18 SURFACE CONDITIONING MATERIAL SANDING BELT COARSE	
35002 1/2 X 18 SURFACE CONDITIONING MATERIAL SANDING BELT MEDIUM	
35003 1/2 X 18 SURFACE CONDITIONING MATERIAL SANDING BELT VERY FINE	

PRODUCT CATEGORY: PA

Sanding Belt Assortment
7 Items • 35 Pcs
IBS No. 848R



Packaged in a Locking Steel Drawer
for Easy Storage & Organization

A
S
S
O
R
T
M
E
N
T
S

IBS, INCORPORATED

Assortments - Taps, Burs & Blades (PT)



Special Purpose Reciprocating Saw Blades	
Assortment No. 393R	
44906 9 X 3/4 6TPI RECIP BIMETAL Wood, nail-embedded wood, compositions, plastic, cast aluminum, light gauge metals.	45499 4 TUNGSTEN CARBIDE GRIT RECIP BLADE Cutting fiberglass, lathe, plaster, ceramics, laminates, marble and hardened steel.
45699 6 TUNGSTEN CARBIDE GRIT RECIP BLADE Cutting fiberglass, lathe, plaster, ceramics, laminates, marble and hardened steel.	45899 8 TUNGSTEN CARBIDE GRIT RECIP BLADE Cutting fiberglass, lathe, plaster, ceramics, laminates, marble and hardened steel.
460906 9 X .062 6TPI DEMOLITION BIMETAL RECIP BLADE Specially designed for the toughest demolition jobs. Cuts all woods, nail-embedded wood and metals.	
461206 12 X .062 6TPI DEMOLITION BIMETAL RECIP BLADE Specially designed for the toughest demolition jobs. Cuts all woods, nail-embedded wood and metals.	
460910 9 X .062 10TPI DEMOLITION BIMETAL RECIP BLADE Specially designed for the toughest demolition jobs. Cuts all woods, nail-embedded wood and metals.	
461210 12 X .062 10TPI DEMOLITION BIMETAL RECIP BLADE Specially designed for the toughest demolition jobs. Cuts all woods, nail-embedded wood and metals.	

Special Purpose Reciprocating Saw Blades
 13 items • 16 Pcs
 IBS No. 393R

Packaged in a Locking Steel Drawer for Easy Storage & Organization

PRODUCT CATEGORY: PA

Hi-Alloy Reciprocating Saw Blades	
Assortment No. 512P	
441206 12" 6TPI HI ALLOY RECIP BLADE Wood, nail-embedded wood, compositions plastic, cast aluminum, light gauge metals.	44624 6" 24TPI HI ALLOY RECIP BLADE Metal, 18 gauge and under. Trim & tubing. Galvanized pipe under 18 gauge.
4481014 8" 10-14TPI HI ALLOY RECIP BLADE All woods, plastic, cast aluminum, nail-embedded wood, soil pipe.	44618 6" 18TPI HI ALLOY RECIP BLADE Heavy gauge metals of 18 gauge to 1/8" thick conduit, pipe, channels and tubing.
44614 6" 14TPI HI ALLOY RECIP BLADE Heavy gauge metals 1/8" thick and above. Barstock and angles.	4461014 6" 10-14TPI HI ALLOY RECIP All woods, plastic, cast aluminum, nail-embedded wood, soil pipe.
44610 6" 10TPI HI ALLOY RECIP BLADE Wood, nail-embedded wood, compositions plastic, cast aluminum, light gauge metals.	44656 6" 6TPI HI ALLOY RECIP BLADE Plaster with metal lathe plaster board, sheet rock, plaster walls. tooth design cuts both forward and on backward stroke.
44606 6" 6TPI HI ALLOY RECIP BLADE Wood, nail-embedded wood, compositions plastic, cast aluminum, light gauge metals.	44418 4" 18TPI HI ALLOY RECIP BLADE Heavy gauge metals of 18 gauge to 1/8" thick conduit, pipe, channels and tubing.
44414 4" 18TPI HI ALLOY RECIP BLADE Heavy gauge metals 1/8" thick and above. Barstock and angles.	44424 4" 24TPI HI ALLOY RECIP BLADE Metal, 18 gauge and under. Trim & tubing. Galvanized pipe under 18 gauge.

Hi-Alloy Reciprocating Saw Blades
 12 items • 60 Pcs
 IBS No. 512P



Packaged in a Locking Steel Drawer for Easy Storage & Organization

PRODUCT CATEGORY: PA

Nitro-Carb Power Taps, Hex Dies and Drill Bits with Tools	
Assortment No. 591P	
120922 Professional Tap Wrench	120925 Professional 1" Hex Die Wrench
1/2-13 129913 HSS Hex Die 17643 Nitro-Carb Power Tap 16823 27/64 Drill Bit	1/2-20 129922 HSS Hex Die 17644 Nitro-Carb Power Tap 16825 29/64 Drill Bit
7/16-14 129912 HSS Hex Die 17641 Nitro-Carb Power Tap 16820 3/8 Drill Bit	7/16-20 129921 HSS Hex Die 17642 Nitro-Carb Power Tap 16821 25/64 Drill Bit
5/16-18 129910 HSS Hex Die 17637 Nitro-Carb Power Tap 16141 "G" Drill Bit	5/16-24 129919 HSS Hex Die 17638 Nitro-Carb Power Tap 16143 "I" Drill Bit
3/8-16 129911 HSS Hex Die 17639 Nitro-Carb Power Tap 16149 "O" Drill Bit	3/8-24 129920 HSS Hex Die 17640 Nitro-Carb Power Tap 16152 "R" Drill Bit
10-32 129917 HSS Hex Die 17633 Nitro-Carb Power Tap 16099 #20 Drill Bit	12-24 129908 HSS Hex Die 17634 Nitro-Carb Power Tap 16095 #16 Drill Bit
1/4-20 129909 HSS Hex Die 17635 Nitro-Carb Power Tap 16086 #7 Drill Bit	1/4-28 129918 HSS Hex Die 17636 Nitro-Carb Power Tap 16082 #3 Drill Bit
4-40 129904 HSS Hex Die 17629 Nitro-Carb Taper Tap 16122 #43 Drill Bit	6-32 129905 HSS Hex Die 17631 Nitro-Carb Power Tap 16113 #34 Drill Bit
8-32 129906 HSS Hex Die 17632 Nitro-Carb Power Tap 16108 #29 Drill Bit	10-24 129907 HSS Hex Die 17632 Nitro-Carb Power Tap 16102 #23 Drill Bit

Nitro-Carb Power Taps, Hex Dies & Drill Bits with Tools
 12 items • 50 Pcs
 IBS No. 591P



Packaged in a Locking Steel Drawer for Easy Storage & Organization

PRODUCT CATEGORY: PT

ASSORTMENTS



IBS, INCORPORATED



Assortments - Taps, Burs & Blades (PT)

ASSORTMENTS



Nitro-Carb Plug/Power Taps, Hex Dies and Drill Bits with Tools

Assortment No. 592P

 120923 Professional Tap Wrench	
 120926 Professional 1-7/16 Hex Die Wrench	
129916 3/4-10 HSS Hex Die 17649 Nitro-Carb Power Tap 16842 21/32 Drill Bit	129925 3/4-16 HSS Hex Die 17650 Nitro-Carb Power Tap 16844 11/16 Drill bit
129915 5/8-11 HSS Hex Die 17647 Nitro-Carb Power Tap 16834 17/32 Drill Bit	129924 5/8-18 HSS Hex Die 17648 Nitro-Carb Power Tap 16836 9/16 Drill bit
129914 9/16-12 HSS Hex Die 17645 Nitro-Carb Plug Tap 16827 31/64 Drill Bit	129923 9/16-18 HSS Hex Die 17646 Nitro-Carb Plug Tap 16828 1/2 Drill bit

PRODUCT CATEGORY: PT

Nitro-Carb Power Taps, Hex Dies & Drill Bits with Tools

18 items • 20 Pcs
IBS No. 592P











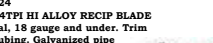

Packaged in a Locking Steel Drawer for Easy Storage & Organization

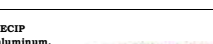

Hi-Alloy Reciprocating Saw Blades

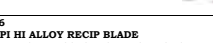
Assortment No. 512P

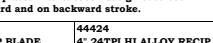
441206 12" 6TPI HI ALLOY RECIP BLADE Wood, nail-embedded wood, compositions plastic, cast aluminum, light gauge metals.		44618 6" 18TPI HI ALLOY RECIP BLADE Heavy gauge metals of 18 gauge to 1/8" thick conduit, pipe, channels and tubing.	
4481014 8" 10-14TPI HI ALLOY RECIP BLADE All woods, plastic, cast aluminum, nail-embedded wood, soil pipe.		44624 6" 24TPI HI ALLOY RECIP BLADE Metal, 18 gauge and under. Trim & tubing. Galvanized pipe under 18 gauge.	
44614 6" 14TPI HI ALLOY RECIP BLADE Heavy gauge metals 1/8" thick and above. Barstock and angles.		44610 6" 10TPI HI ALLOY RECIP BLADE Wood, nail-embedded wood, compositions plastic, cast aluminum, light gauge metals.	
44606 6" 6TPI HI ALLOY RECIP BLADE Wood, nail-embedded wood, compositions plastic, cast aluminum, light gauge metals.		44656 6" 6TPI HI ALLOY RECIP BLADE Plaster with metal lathe plaster board, sheet rock, plaster walls. tooth design cuts both forward and on backward stroke.	
44414 4" 14TPI HI ALLOY RECIP BLADE Heavy gauge metals 1/8" thick and above. Barstock and angles.		44418 4" 18TPI HI ALLOY RECIP BLADE Heavy gauge metals of 18 gauge to 1/8" thick conduit, pipe, channels and tubing.	
44424 4" 24TPI HI ALLOY RECIP BLADE Metal, 18 gauge and under. Trim & tubing. Galvanized pipe under 18 gauge.		44424 4" 24TPI HI ALLOY RECIP BLADE Metal, 18 gauge and under. Trim & tubing. Galvanized pipe under 18 gauge.	

PRODUCT CATEGORY: PT

Metric Nitro-Carb Power Taps, Hex Dies & Drill Bits with Tools

29 items • 29 Pcs
IBS No. 593P









Packaged in a Locking Steel Drawer for Easy Storage & Organization

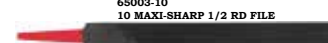

Maxi-Sharp Files

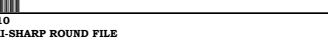
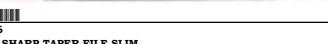
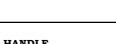
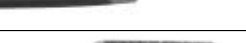
Assortment No. 699R

65018-10 10 MAXI-SHARP ALL PURPOSE 	65019-10 10 MAXI-SHARP FLAT MULTI-KUT 
65001-10 10 MAXI-SHARP FLAT FILE 	65003-10 10 MAXI-SHARP 1/2 RD FILE 
65000-10 10 MAXI-SHARP MILL FILE 	
65002-10 10 MAXI-SHARP ROUND FILE 	
65004-6 6 MAXI-SHARP TAPER FILE SLIM 	65008-6 6 SCRUIZ-ON FILE HANDLE 
65009 FILE CARD WITH BRUSH 	65008-10 10 SCRUIZ-ON FILE HANDLE 

PRODUCT CATEGORY: PT

Maxi Sharp Files

10 items • 12 Pcs
IBS No. 699R



Packaged in a Locking Steel Drawer for Easy Storage & Organization

IBS, INCORPORATED

Assortments - Taps, Burs & Blades (PT)



Advanced Bi-Metal Hole Saws 5/8" to 2"

14 items • 15 Pcs
IBS No. 729R



Packaged in a Locking Steel Drawer
for Easy Storage & Organization

Advanced Bi-Metal Hole Saws 2-1/8" to 4"

8 Items • 8 Pcs
IBS No. 730R



Packaged in a Locking Steel Drawer
for Easy Storage & Organization

Advanced Bi-Metal Hole Saws 3/4" to 4"

18 Items • 19 Pcs
IBS No. 731R



Packaged in a Locking Steel Drawer
for Easy Storage & Organization

 IBS, Inc. <small>SPECIALTY PRODUCTS FOR MAINTENANCE & REPAIR INDUSTRIALBOLT.COM • 9 • 800-670-1906</small>				Advanced Bi-Metal Hole Saws 5/8" to 2"			
				Assortment No. 729R			
29201 5/8 HOLE SAW ADVANCED EDGE	29209 1-1/8 HOLE SAW ADVANCED EDGE	29217 1-5/8 HOLE SAW ADVANCED EDGE	29036 LSS 4 H.S. ARBOR				
29203 3/4 HOLE SAW ADVANCED EDGE	29211 1-1/4 HOLE SAW ADVANCED EDGE	29219 1-3/4 HOLE SAW ADVANCED EDGE		29034 LSS 2 H.S. ARBOR			
29205 7/8 HOLE SAW ADVANCED EDGE	29213 1-3/8 HOLE SAW ADVANCED EDGE	29222 2" HOLE SAW ADVANCED EDGE		29039 1/4 PILOT DRILL			
29207 1" HOLE SAW ADVANCED EDGE	29215 1-1/2 HOLE SAW ADVANCED EDGE						

PRODUCT CATEGORY: PT

 IBS, Inc. <small>SPECIALTY PRODUCTS FOR MAINTENANCE & REPAIR INDUSTRIALBOLT.COM • 9 • 800-670-1906</small>				Advanced Bi-Metal Hole Saws 2-1/8" to 4"			
				Assortment No. 730R			
29224 2-1/8 HOLE SAW ADVANCED EDGE	29228 2-1/2 HOLE SAW ADVANCED EDGE	29237 3-1/2 HOLE SAW ADVANCED EDGE	29034 LSS 2 H.S. ARBOR				
29225 2-1/4 HOLE SAW ADVANCED EDGE	29233 3" HOLE SAW ADVANCED EDGE	29241 4" HOLE SAW ADVANCED EDGE	29039 1/4 PILOT DRILL				

PRODUCT CATEGORY: PT

 IBS, Inc. <small>SPECIALTY PRODUCTS FOR MAINTENANCE & REPAIR INDUSTRIALBOLT.COM • 9 • 800-670-1906</small>				Advanced Bi-Metal Hole Saws 3/4" to 4"			
				Assortment No. 731R			
29203 3/4 HOLE SAW ADVANCED EDGE	29217 1-5/8 HOLE SAW ADVANCED EDGE	29225 2-1/4 HOLE SAW ADVANCED EDGE	29237 3-1/2 HOLE SAW ADVANCED EDGE				
29207 1" HOLE SAW ADVANCED EDGE	29219 1-3/4 HOLE SAW ADVANCED EDGE	29228 2-1/2 HOLE SAW ADVANCED EDGE	29241 4" HOLE SAW ADVANCED EDGE				
29209 1-1/8 HOLE SAW ADVANCED EDGE	29222 2" HOLE SAW ADVANCED EDGE	29233 3" HOLE SAW ADVANCED EDGE	29036 LSS 4 H.S. ARBOR				
29211 1-1/4 HOLE SAW ADVANCED EDGE	29224 2-1/8 HOLE SAW ADVANCED EDGE		29034 LSS 2 H.S. ARBOR				
29213 1-3/8 HOLE SAW ADVANCED EDGE			29039 1/4 PILOT DRILL				
29215 1-1/2 HOLE SAW ADVANCED EDGE							

PRODUCT CATEGORY: PT

ASSORTMENTS



IBS, INCORPORATED

Assortments - Taps, Burs & Blades (PT)

ASSORTMENTS

IBS, Inc.
SPECIALTY PRODUCTS FOR MAINTENANCE & REPAIR
INDUSTRIALBOLT.COM © 2010 800-678-1906

Carbide Tipped Cutters
3/16" Depth
Assortment No. 762R

19205 7/8 CARBIDE TIPPED CUTTER - 3/16" DEPTH	19209 1-1/8 CARBIDE TIPPED CUTTER - 3/16" DEPTH	19213 1-3/8 CARBIDE TIPPED CUTTER - 3/16" DEPTH	19219 1-3/4 CARBIDE TIPPED CUTTER - 3/16" DEPTH
19233 2" CARBIDE TIPPED CUTTER - 3/16" DEPTH			

PRODUCT CATEGORY: PT

Carbide Tipped Cutters

1" Depth

5 Items • 5 Pcs
IBS No. 762R



Packaged in a Locking Steel Drawer for Easy Storage & Organization

IBS, Inc.
SPECIALTY PRODUCTS FOR MAINTENANCE & REPAIR
INDUSTRIALBOLT.COM © 2010 800-678-1906

Carbide Tipped Cutters
1" Depth
Assortment No. 763R

19250 5/8 CARBIDE TIPPED CUTTER - 1" DEPTH	19252 3/4 CARBIDE TIPPED CUTTER - 1" DEPTH	19254 7/8 CARBIDE TIPPED CUTTER - 1" DEPTH	19256 1" CARBIDE TIPPED CUTTER - 1" DEPTH

PRODUCT CATEGORY: PT

Carbide Tipped Cutters

1" Depth

4 Items • 4 Pcs
IBS No. 763R



Packaged in a Locking Steel Drawer for Easy Storage & Organization

IBS, Inc.
SPECIALTY PRODUCTS FOR MAINTENANCE & REPAIR
INDUSTRIALBOLT.COM © 2010 800-678-1906

Carbide Tipped Cutters
1" Depth
Assortment No. 764R

19254 7/8 CARBIDE TIPPED CUTTER - 1" DEPTH	19258 1-1/8 CARBIDE TIPPED CUTTER - 1" DEPTH	19262 1-3/8 CARBIDE TIPPED CUTTER - 1" DEPTH	19268 1-3/4 CARBIDE TIPPED CUTTER - 1" DEPTH
19272 2" CARBIDE TIPPED CUTTER - 1" DEPTH			

PRODUCT CATEGORY: PT

Carbide Tipped Cutters

IBS No. 764R

1" Depth

5 Items • 5 Pcs



Packaged in a Locking Steel Drawer for Easy Storage & Organization

IBS, INCORPORATED

Assortments - Taps, Burs & Blades (PT)



IBS, Inc.
SPECIALTY PRODUCTS FOR MAINTENANCE & REPAIR
INDUSTRIALBOLT.COM • 800-678-1906

Advanced Bi-Metal Hole Saws 5/8" to 2" with Rapid Core Ejecting Arbors
Assortment No. 782R

29201 5/8 HOLE SAW ADVANCED EDGE	29209 1-1/8 HOLE SAW ADVANCED EDGE	29217 1-5/8 HOLE SAW ADVANCED EDGE	29050 RAPID CORE EJECTING ARBOR FOR 1-1/4 TO 6 HOLE SAWS
29203 3/4 HOLE SAW ADVANCED EDGE	29211 1-1/4 HOLE SAW ADVANCED EDGE	29219 1-3/4 HOLE SAW ADVANCED EDGE	
29205 7/8 HOLE SAW ADVANCED EDGE	29213 1-3/8 HOLE SAW ADVANCED EDGE	29051 RAPID CORE EJECTING ARBOR FOR 9/16 - 1-3/16 DIAM HOLE SAWS	
29207 1" HOLE SAW ADVANCED EDGE	29215 1-1/2 HOLE SAW ADVANCED EDGE	29052 PILOT DRILL BIT FOR 29050	
			29053 PILOT DRILL BIT FOR 29051

PRODUCT CATEGORY: PT

Advanced Bi-Metal Hole Saws

5/8" to 2" with Rapid Core Ejecting Arbors

15 Items • 15 Pcs
IBS No. 782R



Packaged in a Locking Steel Drawer for Easy Storage & Organization

IBS, Inc.
SPECIALTY PRODUCTS FOR MAINTENANCE & REPAIR
INDUSTRIALBOLT.COM • 800-678-1906

Advanced Bi-Metal Hole Saws 2-1/8" to 4" with Rapid Core Ejecting Arbors
Assortment No. 783R

29224 2-1/8 HOLE SAW ADVANCED EDGE	29228 2-1/2 HOLE SAW ADVANCED EDGE	29237 3-1/2 HOLE SAW ADVANCED EDGE	29050 RAPID CORE EJECTING ARBOR FOR 1-1/4 TO 6 DIAM. HOLE SAWS
29225 2-1/4 HOLE SAW ADVANCED EDGE	29233 3" HOLE SAW ADVANCED EDGE	29241 4" HOLE SAW ADVANCED EDGE	
			29052 PILOT DRILL FOR 29050

PRODUCT CATEGORY: PT

Advanced Bi-Metal Hole Saws

2-1/8" to 4" with Rapid Core Ejecting Arbors

8 Items • 8 Pcs
IBS No. 783R



Packaged in a Locking Steel Drawer for Easy Storage & Organization

IBS, Inc.
SPECIALTY PRODUCTS FOR MAINTENANCE & REPAIR
INDUSTRIALBOLT.COM • 800-678-1906

Advanced Bi-Metal Hole Saws 3/4" to 4" with Rapid Core Ejecting Arbors
Assortment No. 784R

29203 3/4 HOLE SAW ADVANCED EDGE	29217 1-5/8 HOLE SAW ADVANCED EDGE	29225 2-1/4 HOLE SAW ADVANCED EDGE	29241 4" HOLE SAW ADVANCED EDGE
29207 1" HOLE SAW ADVANCED EDGE	29219 1-3/4 HOLE SAW ADVANCED EDGE	29228 2-1/2 HOLE SAW ADVANCED EDGE	
29209 1-1/8 HOLE SAW ADVANCED EDGE	29233 3" HOLE SAW ADVANCED EDGE	29050 RAPID CORE EJECTING ARBOR 1-1/4 - 6 DIAM HOLE SAW	
29211 1-1/4 HOLE SAW ADVANCED EDGE	29222 2" HOLE SAW ADVANCED EDGE	29051 RAPID CORE EJECTING ARBOR FOR 9/16 - 1-3/16 DIAM HOLE SAW	
29213 1-3/8 HOLE SAW ADVANCED EDGE	29224 2-1/8 HOLE SAW ADVANCED EDGE	29052 PILOT DRILL FOR 29050	
29215 1-1/2 HOLE SAW ADVANCED EDGE		29053 PILOT DRILL FOR 29051	

PRODUCT CATEGORY: PT

Advanced Bi-Metal Hole Saws 3/4" to 4"

3/4" to 4" with Rapid Core Ejecting Arbors

18 Items • 19 Pcs



Packaged in a Locking Steel Drawer for Easy Storage & Organization

ASSORTMENTS



IBS, INCORPORATED

Assortments - Taps, Burs & Blades (PT)

ASSORTMENTS

IBS, Inc.		Hi-Alloy Bi-Metal Hacksaw Blades	
SPECIALTY PRODUCTS FOR MAINTENANCE & REPAIR INDUSTRIALBOLT.COM 800-678-1966		Assortment No. 785R	
16395 12 18/14 HI-ALLOY HACKSAW BLADE			
16396 12 24/20 HI-ALLOY HACKSAW BLADE			
16398 12 32/26 HI-ALLOY HACKSAW BLADE			
16399 12 18/24/32 TRIPLE CUT BIMETAL HACKSAW BLADE			

PRODUCT CATEGORY: PT

Hi-Alloy Bi-Metal Hacksaw Blades

4 Items • 20 Pcs
IBS No. 785R



Packaged in a Locking Steel Drawer for Easy Storage & Organization

IBS, Inc.		Bore Blades and Demolition Blades	
SPECIALTY PRODUCTS FOR MAINTENANCE & REPAIR INDUSTRIALBOLT.COM 800-678-1966		Assortment No. 801R	
446710 6" 6X10TPI BORE BLADE. For metal and wood cutting.		448711 8" 10X14TPI BORE BLADE. For metal and wood cutting.	
446711 6" 14X18TPI BORE BLADE. For metal and wood cutting.		4410710 10" 8/12X10TPI BORE BLADE. For metal and wood cutting.	
448710 8" 6X10TPI BORE BLADE. For metal and wood cutting.		460906 9 X .062 6TPI DEMOLITION BIMETAL RECIP BLADE Specially designed for the toughest demolition jobs. Cuts all woods, nail-embedded wood and metals.	
460910 9 X .062 10TPI DEMOLITION BIMETAL RECIP BLADE Specially designed for the toughest demolition jobs. Cuts all woods, nail-embedded wood and metals.			
461206 12 X .062 6TPI DEMOLITION BIMETAL RECIP BLADE Specially designed for the toughest demolition jobs. Cuts all woods, nail-embedded wood and metals.			
461210 12 X .062 10TPI DEMOLITION BIMETAL RECIP BLADE Specially designed for the toughest demolition jobs. Cuts all woods, nail-embedded wood and metals.			

PRODUCT CATEGORY: PT

Bore Blades & Demolition Blades

9 Items • 18 Pcs
IBS No. 801R



Packaged in a Locking Steel Drawer for Easy Storage & Organization

IBS, Inc.		Advanced Edge Power Reciprocating Saw Blades	
SPECIALTY PRODUCTS FOR MAINTENANCE & REPAIR INDUSTRIALBOLT.COM 800-678-1966		Assortment No. 840R	
470610 6IN X .042 10TPI ADVANDED EDGE POWER RECIP BLADE 1IN WIDTH		470910 9IN X .042 10TPI ADVANDED EDGE POWER RECIP BLADE 1IN WIDTH	
471210 12IN X .042 10TPI ADVANDED EDGE POWER RECIP BLADE 1IN WIDTH			
470614 6IN X .042 14TPI ADVANDED EDGE POWER RECIP BLADE 1IN WIDTH		470914 9IN X .042 14TPI ADVANDED EDGE POWER RECIP BLADE 1IN WIDTH	
471214 12IN X .042 14TPI ADVANDED EDGE POWER RECIP BLADE 1IN WIDTH			
470618 6IN X .042 18TPI ADVANDED EDGE POWER RECIP BLADE 1IN WIDTH		470918 9IN X .042 18TPI ADVANDED EDGE POWER RECIP BLADE 1IN WIDTH	
471218 12IN X .042 18TPI ADVANDED EDGE POWER RECIP BLADE 1IN WIDTH		74172 TOOL EASE	

PRODUCT CATEGORY: PT

Advanced Edge Power Reciprocating Saw Blades with Tool Ease Lubricant Stick

10 Items • 21 Pcs
IBS No. 840R



Packaged in a Locking Steel Drawer for Easy Storage & Organization

IBS, INCORPORATED

Assortments - Electrical (Q)



IBS, Inc. <small>SPECIALTY PRODUCTS FOR MAINTENANCE & REPAIR INDUSTRIALBOLTY.COM • P O BOX 800-470-1906</small>					
Nylon Insulated Double Grip Solderless Terminal					
Assortment No. 101R					
61-SN 22-18 BUTT CONNECTOR	11-6SNB 22-18 X #6 RING TERMINAL	11-8SNB 22-18 X #8 RING TERMINAL	11-10NB 22-18 X #10 RING TERMINAL	21-10NB 22-18 X #10 SPADE TERMINAL	72F-250-32-NBL 16-14 FEMALE QUICK SLIDE
62-SN 16-14 BUTT CONNECTOR	12-6SNB 16-14 X #6 RING TERMINAL	12-10NB 16-14 X #10 RING TERMINAL	12-14SNB 16-14 X 1/4" RING TERMINAL	32-10NB 16-14 X #10 SPADE TERMINAL	72M-250-32-NBL 16-14 MALE QUICK SLIDE
63-SN 12-10 BUTT CONNECTOR	82F-156-NBL 16-14 FEMALE BULLET	82M-156-NB 16-14 MALE BULLET	33-10NB 12-10 X #10 SPADE TERMINAL	13-8SNB 12-10 X #8 RING TERMINAL	73M-250-32-NBL 12-10 MALE QUICK SLIDE
13-10NB 12-10 X #10 RING TERMINAL	13-14SNB 12-10 X 1/4" RING TERMINAL	13-565NB 12-10 X 5/16" RING TERMINAL	13-38SNB 12-10 X 3/8" RING TERMINAL	13-500NB 12-10 X 1/2" RING TERMINAL	73F-250-32-NBL 12-10 FEMALE QUICK SLIDE

PRODUCT CATEGORY: Q

Nylon Insulated Double Grip Solderless Terminals

24 Items • 270 Pcs
IBS No. 101R



Packaged in a Locking Steel Drawer for Easy Storage & Organization

IBS, Inc. <small>SPECIALTY PRODUCTS FOR MAINTENANCE & REPAIR INDUSTRIALBOLTY.COM • P O BOX 800-470-1906</small>	
Nylon Tie Wraps	
Assortment No. 107R	
15' 120lb. Black Nylon Tie B-14-120	
14-1/2' 50 lb. Black Nylon Tie B-14-50	
4' 18 lb. Black Nylon Tie B-4-18	11' 50 lb. Black Nylon Tie B-11-50
7-1/2' 50 lb. Clear Nylon Tie L-7-50	8' 50 lb. Mountng Tie MH-7-50
5-1/2' 40 lb. Clear Nylon Tie L-5-30	7-1/2' 50 lb. Black Nylon Tie B-7-50
4' 18 lb. Clear Nylon Tie L-4-18	5-1/2' 40 lb. Black Nylon Tie B-5-30

PRODUCT CATEGORY: Q

Nylon Tie Wraps

10 Items • 750 Pcs
IBS No. 107R



Packaged in a Locking Steel Drawer for Easy Storage & Organization

IBS, Inc. <small>SPECIALTY PRODUCTS FOR MAINTENANCE & REPAIR INDUSTRIALBOLTY.COM • P O BOX 800-470-1906</small>					
Crimp & Seal Terminals w/ Torch & Butane Refill					
Assortment No. 109R					
			B5223 16-14 CRIMP & SEAL #8 RING TERM	B5224 16-14 CRIMP & SEAL #10 RING TERM	125738 + 95007 MICROTORCH BUTANE TORCH + REFILL
B5225 16-14 CRIMP & SEAL 1/4 RING TERM	B5228 16-14 CRIMP & SEAL #10 SPADE TERM	B5245 16-14 CRIMP & SEAL .250 FEMALE CONN	B5255 16-14 CRIMP & SEAL .250 MALE CONN	B5265 16-14 CRIMP & SEAL .156 MALE BULLET	
B5275 16-14 CRIMP & SEAL .156 FEMALE BULLET	B5324 12-10 CRIMP & SEAL #10 RING TERM	B5325 12-10 CRIMP & SEAL 1/4 RING TERM	B5327 12-10 CRIMP & SEAL 3/8 RING TERM	B5345 12-10 CRIMP & SEAL .250 FEMALE CONN	B280 22-18 SOLDER&SEAL SHRINK TUBE
B5355 12-10 CRIMP & SEAL .250 MALE CONN	B5110 20-18 CRIMP & SEAL BUTT CONNECTOR	B5210 16-14 CRIMP & SEAL BUTT CONNECTOR	B5310 12-10 CRIMP & SEAL BUTT CONNECTOR	B5100 22-24 CRIMP & SEAL BUTT CONNECTOR	B281 16-14 SOLDER&SEAL SHRINK TUBE
					B282 12-10 SOLDER&SEAL SHRINK TUBE

PRODUCT CATEGORY: Q

Crimp & Seal Terminals w/ Torch & Butane Refill

21 Items • 315 Pcs
IBS No. 109R



Packaged in a Locking Steel Drawer for Easy Storage & Organization

ASSORTMENTS



IBS, INCORPORATED

Assortments - Electrical (Q)

ASSORTMENTS

IBS, Inc. SPECIALTY PRODUCTS FOR MAINTENANCE & REPAIR INDUSTRIALBOLT.COM © & © 800-878-1906		ECOMAX Post Top Battery Terminals		
Assortment No. 129P				
E2107 ECOMAX BATT TERM 1+2 GA NEG 	E2111 ECOMAX BATT. TERM 2/0 GA. NEG. 	E2309 ECOMAX BATT. TERM. RT. EL. 1/0 NEG. 	B1110 5/16 X 1-1/4 TIN PLTD BATT 1/0 NEG. 	
E2108 ECOMAX BATTERY TERM 1+2 GA POSITIVE 	E2112 ECOMAX BATT. TERM. 2/0 GA. POS. 	E2310 ECOMAX BATT. TERM. RT. EL. 1/0 POS. 		
E2109 ECOMAX BATT TERM 1/0 GA NEG 	E2113 ECOMAX BATT. TERM. 3/0 GA. NEG. 	E2311 ECOMAX BATT. TERM. RT. EL. 2/0 NEG. 	E2411 ECOMAX BATT. TERM. LT. EL. 2/0 NEG. 	E2211 ECOMAX BATT. TERM. FLAG 2/0 NEG.
E2110 ECOMAX BATT TERM 1/0 GA POS 	E2114 ECOMAX BATT. TERM. 3/0 GA. POS. 	E2312 ECOMAX BATT. TERM. RT. EL. 2/0 POS. 	E2412 ECOMAX BATT. TERM. LT. EL. 2/0 POS. 	E2212 ECOMAX BATT. TERM. FLAG 2/0 POS.

PRODUCT CATEGORY: Q

ECOMAX Post Top Battery Terminals

17 Items • 69 Pcs
IBS No. 129P



Packaged in a Locking Steel Drawer
for Easy Storage & Organization

IBS, Inc. SPECIALTY PRODUCTS FOR MAINTENANCE & REPAIR INDUSTRIALBOLT.COM © & © 800-878-1906		Rubber Insulated & Nylon Clamps	
Assortment No. 141R			
7120A 1/4 NYLON CLAMP 	7122A 3/8 NYLON CLAMP 	7124A 1/2 NYLON CLAMP 	7126A 5/8 NYLON CLAMP
7314A 1/4 INSULATED CLAMP 1/4 STUD STAMP #4 	7315A 3/8 INSULATED CLAMP 1/4 STUD STAMP #6 	7316A 1/2 INSULATED CLAMP 1/4 STUD STAMP #8 	7318A 3/4 INSULATED CLAMP 1/4 STUD STAMP #12
7320A 1 INSULATED CLAMP 1/4 STUD STAMP #16 	7322A 1-1/4 INSULATED CLAMP 1/4 STUD STAMP #20 	7324A 1-1/2 INSULATED CLAMP 1/4 STUD STAMP #24 	7514A 1/4 INSULATED CLAMP 3/8 STUD STAMP #4
7516A 1/2 INSULATED CLAMP 3/8 STUD STAMP #8 	7518A 3/4 INSULATED CLAMP 3/8 STUD STAMP #12 	7520A 1 INSULATED CLAMP 3/8 STUD STAMP #16 	7522A 1-1/4 INSULATED CLAMP 3/8 STUD STAMP #18

PRODUCT CATEGORY: Q

Rubber Insulated & Nylon Clamps

16 Items • 230 Pcs
IBS No. 141R



Packaged in a Locking Steel Drawer
for Easy Storage & Organization

IBS, Inc. SPECIALTY PRODUCTS FOR MAINTENANCE & REPAIR INDUSTRIALBOLT.COM © & © 800-878-1906		Nylon Clamps	
Assortment No. 145R			
7118A 1/8 NYLON CLAMP 	7119A 3/16 NYLON CLAMP 	7120A 1/4 NYLON CLAMP 	
7121A 5/16 NYLON CLAMP 	7122A 3/8 NYLON CLAMP 	7123A 7/16 NYLON CLAMP 	
7124A 1/2 NYLON CLAMP 	7125A 9/16 NYLON CLAMP 	7126A 5/8 NYLON CLAMP 	
7128A 3/4 NYLON CLAMP 	7129A 7/8 NYLON CLAMP 	7130A 1 NYLON CLAMP 	

PRODUCT CATEGORY: Q

Nylon Clamps

12 Items • 525 Pcs
IBS No. 145R



Packaged in a Locking Steel Drawer
for Easy Storage & Organization

IBS, INCORPORATED

Assortments - Electrical (Q)



IBS, Inc. <small>SPECIALTY PRODUCTS FOR MAINTENANCE & REPAIR INDUSTRIALBOLT.COM © 9 © 800-670-1906</small>			Rubber Insulated Clamps 1/4" Mounting Hole
			Assortment No. 146R
7314A 1/4 INSULATED CLAMP 1/4 STUD STAMP #4	7315A 3/8 INSULATED CLAMP 1/4 STUD STAMP #6	7316A 1/2 INSULATED CLAMP 1/4 STUD STAMP #8	
7317A 5/8 INSULATED CLAMP 1/4 STUD STAMP #10	7318A 3/4 INSULATED CLAMP 1/4 STUD STAMP #12	7319A 7/8 INSULATED CLAMP 1/4 STUD STAMP #14	
7320A 1 INSULATED CLAMP 1/4 STUD STAMP #16	7321A 1-1/8 INSULATED CLAMP 1/4 STUD STAMP #18	7322A 1-1/4 INSULATED CLAMP 1/4 STUD STAMP #20	
7323A 1-3/8 INSULATED CLAMP 1/4 STUD STAMP #22	7324A 1-1/2 INSULATED CLAMP 1/4 STUD STAMP #24	7325A 1-5/8 INSULATED CLAMP 1/4 STUD STAMP #26	

PRODUCT CATEGORY: Q

Rubber Insulated Clamps

1/4" Mounting Hole
12 Items • 90 Pcs
IBS No. 146R



Packaged in a Locking Steel Drawer for Easy Storage & Organization

IBS, Inc. <small>SPECIALTY PRODUCTS FOR MAINTENANCE & REPAIR INDUSTRIALBOLT.COM © 9 © 800-670-1906</small>			Rubber Insulated Clamps 3/8" Mounting Hole
			Assortment No. 147R
7514A 1/4 INSULATED CLAMP 3/8 STUD STAMP #4	7515A 3/8 INSULATED CLAMP 3/8 STUD STAMP #6	7516A 1/2 INSULATED CLAMP 3/8 STUD STAMP #8	
7517A 5/8 INSULATED CLAMP 3/8 STUD STAMP #10	7518A 3/4 INSULATED CLAMP 3/8 STUD STAMP #12	7519A 7/8 INSULATED CLAMP 3/8 STUD STAMP #14	
7520A 1 INSULATED CLAMP 3/8 STUD STAMP #16	7522A 1-1/4 INSULATED CLAMP 3/8 STUD STAMP #18		

PRODUCT CATEGORY: Q

Rubber Insulated Clamps

3/8 Mounting Hole
8 Items • 75 Pcs
IBS No. 147R



Packaged in a Locking Steel Drawer for Easy Storage & Organization

IBS, Inc. <small>SPECIALTY PRODUCTS FOR MAINTENANCE & REPAIR INDUSTRIALBOLT.COM © 9 © 800-670-1906</small>					Heavy Duty Wire Ends for #8, #6 & #4 GA Wire
					Assortment No. 159R
64-WP #8 BUTT CONNECTOR VINYL	65-WP #6 BUTT CONNECTOR VINYL	66-WP #4 BUTT CONNECTOR VINYL			
16-10-WN #4 RING TERM. 10 STUD NYLON	16-14-WN #4 RING TERM. 1/4 STUD NYLON	16-56-WN #4 RING TERM. 5/16 STUD NYLON	16-38-WN #4 RING TERM. 3/8 STUD NYLON	16-500S-WN #4 RING TERM. 1/2 STUD NYLON	
15-10S-WN #6 RING TERM. 10 STUD NYLON	15-14S-WN #6 RING TERM. 1/4 STUD NYLON	15-56-WN #6 RING TERM. 5/16 STUD NYLON	15-38-WN #6 RING TERM. 3/8 STUD NYLON	15-500S-WN #6 RING TERM. 1/2 STUD NYLON	
14-10S-WN #8 RING TERM. 10 STUD NYLON	14-14S-WN #8 RING TERM. 1/4 STUD NYLON	14-56-WN #8 RING TERM. 5/16 STUD NYLON	14-38-WN #8 RING TERM. 3/8 STUD NYLON	14-500S-WN #8 RING TERM. 1/2 STUD NYLON	

PRODUCT CATEGORY: Q

Heavy Duty Wire Ends for #8, #6 & #4 GA Wire

18 Items • 180 Pcs
IBS No. 159R



Packaged in a Locking Steel Drawer for Easy Storage & Organization

ASSORTMENTS



IBS, INCORPORATED

Assortments - Electrical (Q)

ASSORTMENTS

IBS, Inc.
SPECIALTY PRODUCTS FOR MAINTENANCE & REPAIR
INDUSTRIALBOLT.COM © © © 800-678-1506

Wire Nuts

Assortment No. 198R

6X682 GRAY WIRE NUTS	6X683 BLUE WIRE NUT/REPLACES BLK	6X684 ORANGE WIRE NUTS	6X685 YELLOW WIRE NUT	6X686 RED WIRE NUT	TH450 AUTO WIRE CRIMPER/STRIPPER
6X687 YELLOW WIRE NUT WINGED	6X688 RED WIRE NUT WINGED	6X689 GRAY WIRE NUT WINGED	6X690 BLUE WIRE NUT WINGED	6X691 TAN WIRE NUT WINGED	
6X692 GREEN GROUNDING WIRE NUT WINGED					
973 O/B MULTI WIRE NUT	974 RED/YELLOW MULTI WIRE NUT	975 BLUE / GRAY MULTI WIRE NUT			



PRODUCT CATEGORY: Q

Wire Nuts
15 Items • 256 Pcs
IBS No. 198R



Packaged in a Locking Steel Drawer for Easy Storage & Organization

IBS, Inc.
SPECIALTY PRODUCTS FOR MAINTENANCE & REPAIR
INDUSTRIALBOLT.COM © © © 800-678-1506

Wall Nuts & Lever Nuts

Assortment No. 199R

773-162 2 WIRE WALL NUT	773-164 4 WIRE WALL NUT	773-166 6 WIRE WALL NUT	773-168 8 WIRE WALL NUT	773-173 3 WIRE WALL NUT	TH450 AUTO WIRE CRIMPER/STRIPPER
222-412 2 WIRE LEVER NUT	222-413 3 WIRE LEVER NUT	222-415 5 WIRE LEVER NUT			
221-2401 INLINE SPlice CLEAR LEVER NUT	221-412 2 WIRE CLEAR LEVER NUT	221-413 3 WIRE CLEAR LEVER NUT	221-415 5 WIRE CLEAR LEVER NUT		

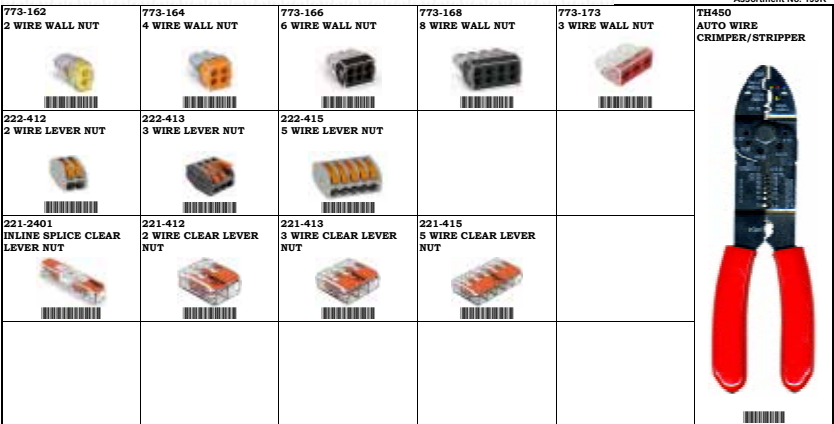

PRODUCT CATEGORY: Q

Wall Nuts & Lever Nuts

13 Items • 106 Pcs
IBS No. 199R



Packaged in a Locking Steel Drawer for Easy Storage & Organization

IBS, Inc.
SPECIALTY PRODUCTS FOR MAINTENANCE & REPAIR
INDUSTRIALBOLT.COM © © © 800-678-1506

Vinyl Insulated Solderless Terminals

Assortment No. 201R

61-P 22-18 BUTT CONN VINYL	11-6P 22-18 RING TERM #6 STUD VINYL	11-8P 22-18 RING TERM #8 STUD VINYL	11-10P 22-18 RING TERM #10 STUD VINYL	31-10P 22-18 SPADE TERM #10 STUD	72F-250-32P 16-14 FEMALE QIK SLIDE VINYL
62-P 16-14 BUTT CONN VINYL	12-6P 16-14 RING TERM #6 STUD VINYL	12-10-P 16-14 RING TERM 10 STUD VINYL	12-14SP 16-14 RING TERM 1/4 STUD VINYL	32-10P 16-14 SPADE TERM 10 STUD VINYL	72M-250-32P 16-14 MALE QIK SLIDE VINYL
63-P 12-10 BUTT CONN VINYL	82F-156-NL 16-14 FEMALE SNAP PLUG VINYL	82M-156P 16-14 MALE SNAP PLUG VINYL	33-10P 12-10 SPADE TERM #10 STUD	13-8P 12-10 RING TERM #8 STUD VINYL	73M-250-32P 12-10 MALE QIK SLIDE VINYL
13-10P 12-10 RING TERM 10 STUD VINYL	13-14SP 12-10 RING TERM 1/4 STUD VINYL	13-56P 12-10 RING TERM 5/16 STUD VINYL	13-38P 12-10 RING TERM 3/8 STUD VINYL	13-500P 12-10 RING TERM 1/2 STUD VINYL	73F-250-32P 12-10 FEMALE QIK SLIDE VINYL



PRODUCT CATEGORY: Q

Vinyl Insulated Solderless Terminals

24 Items • 515 Pcs
IBS No. 201R













Packaged in a Locking Steel Drawer for Easy Storage & Organization

IBS, INCORPORATED

Assortments - Electrical (Q)



IBS, Inc. SPECIALTY PRODUCTS FOR MAINTENANCE & REPAIR INDUSTRIALBOLT.COM © © © 800-670-1506		EcoMax Terminals Heavy Duty Lugs & Splices	
Assortment No. 202P			
BAL1038 1/0 X 3/8ST HVY DUTY TUBULAR LUG 	BAL1012 BATT TERM 1/0 X 1/2 STUD LUG HEAVY DUTY TUBULAR 	E2110 ECOMAX BATT TERM 1/0 GA POS 	E2109 ECOMAX BATT TERM 1/0 GA NEG 
BAL2038 2/0 X 3/8ST HVY DUTY TUBULAR LUG 	BAL2012 2/0 X 1/2ST HVY DUTY TUBULAR LUG 	E2112 ECOMAX BATT TERM 2/0 GA POS 	E2111 ECOMAX BATT TERM 2/0 GA NEG 
MS100 1/0GA HVY DUTY BUTT CONN 	MS200 2/0GA HVY DUTY BUTT CONN 		
B1110 5/16 X 1-1/4 BATT BOLT & NUT TIN PLATED 			





















PRODUCT CATEGORY: Q

EcoMax Terminals, Heavy Duty Lugs & Splices

11 Items • 75 Pcs
IBS No. 202P

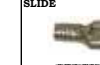

Packaged in a Locking Steel Drawer
for Easy Storage & Organization

IBS, Inc. SPECIALTY PRODUCTS FOR MAINTENANCE & REPAIR INDUSTRIALBOLT.COM © © © 800-670-1506		Non-Insulated Butted Seam Top 24 Wire Ends			
Assortment No. 211R					
61S 22-18 BUTT CONN NON INSUL 	11-6 22-18 RING TERM. 6 STUD NO-INS 	11-8 22-18 RING TERM 8 STUD NO-INS 	11-10 22-18 RING TERM 10 STUD NO-INS 	31-10 22-18 SPADE TERM #10 STUD 	72F-250-32 16-14 FEMALE QUICK SLIDE 
62S 16-14 BUTT CONN NON INSULATED 	12-6 16-14 RING TERM. 6 STUD NO-INS 	12-10 16-14 RING TERM 10 STUD NO-INS 	12-14 16-14 RING TERM #14 STUD NO-IN 	32-10 16-14 #10 SPADE TERM 	72M-250-32 16-14 MALE QIR SLIDE NO INSUL. 
63S 12-10 BUTT CONN. NON INSUL 	82F-156-NL 16-14 FEMALE SNAP PLUG VINYL 	82M-156 16-14 MALE SNAP PLUG 	13-8 12-10 RING TERM 8 STUD NON-INS 	33-10 12-10 SPADE TERM #10 STUD 	73M-250-32 12-10 MALE QIR SLIDE NO INSUL. 
13-10 12-10 RING TERM #10 STUD NO-IN 	13-14 12-10 RING TERM 1/4 STUD 	13-56 12-10 RING TERM 5/16 STUD 	13-38 12-10 RING TERM. 3/8 STUD NO-1 	13-500 12-10 RING TERM 1/2 STUD 	73F-250-32 12-10 FEMALE QUICK SLIDE 











PRODUCT CATEGORY: Q

Non-Insulated Butted Seam Top 24 Wire Ends

24 Items • 635 Pcs
IBS No. 211R



Packaged in a Locking Steel Drawer
for Easy Storage & Organization

IBS, Inc. SPECIALTY PRODUCTS FOR MAINTENANCE & REPAIR INDUSTRIALBOLT.COM © © © 800-670-1506		Grommet Kit	
Assortment No. 230R			
A-4410 5/32ID X 1/16 GROOVE RUBBER 	A-4413 3/16ID X 1/16 GROOVE RUBBER 	A-4414 3/16ID X 3/32 GROOVE RUBBER 	
A-16454 1/4ID X 1/16 GROOVE RUBBER 	A-4419 5/16ID X 1/16 GROOVE RUBBER 	A-4423 3/8ID X 1/16 GROOVE RUBBER 	
A-4428 1/2ID X 3/32 GROOVE RUBBER 	A-16458 1/2ID X 1/8 GROOVE RUBBER 	A-4432 5/8ID X 1/16 GROOVE RUBBER 	
A-4433 3/4ID X 1/16 GROOVE RUBBER 	A-4430 1/2ID X 1/4 GROOVE RUBBER 		

PRODUCT CATEGORY: Q

Grommet Kit

11 Items • 220 Pcs
IBS No. 230R



Packaged in a Locking Steel Drawer
for Easy Storage & Organization

ASSORTMENTS



IBS, INCORPORATED

Assortments - Electrical (Q)

ASSORTMENTS

IBS, Inc.
SPECIALTY PRODUCTS FOR MAINTENANCE & REPAIR
INDUSTRIALBOLTY.COM • 800-878-1906

Automotive Electrical Fuses

Assortment No. 290P

AGA15 AUTO FUSE	AGA20 AUTO FUSE	AGA30 AUTO FUSE	SFE7-1/2 AUTO FUSE GLASS TUBE	SFE14 AUTO FUSE GLASS TUBE	SFE20 AUTO FUSE GLASS TUBE	SFE30 AUTO FUSE GLASS TUBE	
AGC1 AUTO FUSE	AGC4 AUTO FUSE	AGC7-1/2 AUTO FUSE	AGC10 AUTO FUSE	AGC15 AUTO FUSE	AGC20 AUTO FUSE	AGC25 AUTO FUSE	AGC30 AUTO FUSE
ATC5 AUTO FUSE	ATC10 AUTO FUSE	ATC15 AUTO FUSE	ATC20 AUTO FUSE	ATC25 AUTO FUSE	ATC30 AUTO FUSE	EL-13 HVY DUTY 3 PRONG TRUCK FLASHER	
ATM5 AUTO FUSE	ATM10 AUTO FUSE	ATM15 AUTO FUSE	ATM20 AUTO FUSE	ATM25 AUTO FUSE	ATM30 AUTO FUSE	EL-13 HVY DUTY 3 PRONG TRUCK FLASHER	
19518 GLASS TUBE WATER-PROOF IN-LINE	19513 BLADE TYPE WATER-PROOF IN-LINE FUSE HLDR	FP-C FUSE PULLER					
0690T 12 VOLT TESTER	1588A 3/8 TEST CLIP JAW	MAX20 20 AMP MAXI FUSE YELLOW	MAX30 30 AMP MAX FUSE GREEN	MAX40 40 AMP MAXI FUSE ORANGE			

PRODUCT CATEGORY: Q

Automotive Electrical Fuses
37 Items • 235 Pcs
IBS No. 290P



Packaged in a Locking Steel Drawer for Easy Storage & Organization

IBS, Inc.
SPECIALTY PRODUCTS FOR MAINTENANCE & REPAIR
INDUSTRIALBOLTY.COM • 800-878-1906

Heavy Wall Shrink Tubing II

Assortment No. 295P

B3505 2-4/0GA X 6" BLACK HVY	B3405 2-4/0GA X 6" RED HVY WALL
B3503 8-1/0GA X 6" BLACK HEAVY SHRINK TUBE	B3404 8-1/0 GA X 6" RED HEAVY SHRINK TUBE
B3501 12-6GA X 6" BLACK HVY SHRINK	B3502 12-6GA X 6" RED HVY SHRINK
B3508 8-2GA X 6" CLEAR SHRINK TUBE	B282 12-10 SOLDER&SEAL SHRINK TUBE
B3507 14-8GA X 6" CLEAR SHRINK TUBE	B281 16-14 SOLDER&SEAL SHRINK TUBE
B3506 18-12GA X 6" CLEAR SHRINK	B280 22-18 SOLDER&SEAL SHRINK TUBE

PRODUCT CATEGORY: Q

Heavy Wall Shrink Tubing II
12 Items • 86 Pcs
IBS No. 295P



Packaged in a Locking Steel Drawer for Easy Storage & Organization

IBS, Inc.
SPECIALTY PRODUCTS FOR MAINTENANCE & REPAIR
INDUSTRIALBOLTY.COM • 800-878-1906

FUSION™ Solder-On Battery Ends & Shrink Tubing

Assortment No. 296P

B11381 1/0 X 3/8 FUSION HVY WALL LUG	B21381 2/0 X 3/8 FUSION HVY WALL LUG	B3405 2-4/0GA X 6" RED HVY WALL	B3505 2-4/0GA X 6" BLACK HVY
B2121 1/0 POS STRT FUSION BATTERY	B2123 2/0 POS STRT FUSION BATTERY		
B2120 1/0 NEG STRT FUSION BATTERY	B2122 2/0 NEG STRT FUSION BATTERY		

PRODUCT CATEGORY: Q

Fusion Solder-On Battery Ends & Shrink Tubing
8 Items • 34 Pcs
IBS No. 296P



Packaged in a Locking Steel Drawer for Easy Storage & Organization

IBS, INCORPORATED

Assortments - Electrical (Q)













IBS, Inc.
SPECIALTY PRODUCTS FOR MAINTENANCE & REPAIR
INDUSTRIALBOLT.COM • 800-678-1906

Automotive Shrink Tubing
With MicroTorch Butane Torch Included
Assortment No. 297R



<p>B281 16-14 SOLDER&SEAL SHRINK TUBE</p> 	<p>B282 12-10 SOLDER/SEAL SHRINK TUBE</p> 
<p>B280 22-18 SOLDER&SEAL SHRINK TUBE</p> 	<p>B279 24-22 SOLDER/SEAL SHRINK TUBE</p> 
<p>B3507 14-8GA X 6 CLEAR SHRINK TUBE*</p> 	<p>B3508 8-2GA X 6 CLEAR SHRINK TUBE*</p> 
<p>B3302 1/4 X 12 CLEAR DUAL WALL*</p> 	
<p>B3301 3/16 X 12 CLEAR DUAL WALL*</p> 	
<p>B3300 1/8 X 12 CLEAR DUAL WALL*</p> 	

PRODUCT CATEGORY: Q

Automotive Shrink Tubing

9 Items • 55 Pcs
IBS No. 297R



Packaged in a Locking Steel Drawer for Easy Storage & Organization



IBS, Inc.
SPECIALTY PRODUCTS FOR MAINTENANCE & REPAIR
INDUSTRIALBOLT.COM • 800-678-1906

Multilink Wire Ends
Assortment No. 314R

	<p>B5518 20-18 MULTILINK BUTT CONNECTOR</p> 	<p>125702 20-18 MULTILINK #8 RING TERM</p> 	<p>125703 20-18 MULTILINK #10 RING TERM</p> 	<p>125713 20-18 MULTILINK #10 SPADE TERM</p> 	
<p>B5514 16-14 MULTILINK BUTT CONNECTOR</p> 	<p>125714 16-14 MULTILINK #10 SPADE TERM</p> 	<p>125718 16-14 MULTILINK .250 MALE</p> 	<p>125719 16-14 MULTILINK .250 FEMALE</p> 	<p>125715 12-10 MULTILINK #10 SPADE TERM</p> 	
<p>125705 16-14 MULTILINK #8 RING TERM</p> 	<p>125706 16-14 MULTILINK #10 RING TERM</p> 	<p>125707 16-14 MULTILINK 1/4 RING TERM</p> 	<p>125708 16-14 MULTILINK 3/8 RING TERM</p> 	<p>125720 12-10 MULTILINK .250 MALE</p> 	
<p>B5510 12-10 MULTILINK BUTT CONNECTOR</p> 	<p>125709 12-10 MULTILINK #10 RING TERM</p> 	<p>125710 12-10 MULTILINK 1/4 RING TERM</p> 	<p>125711 12-10 MULTILINK 3/8 RING TERM</p> 	<p>125721 12-10 MULTILINK .250 FEMALE</p> 	

PRODUCT CATEGORY: Q

Multilink Wire Ends

19 Items • 145 Pcs
IBS No. 314R













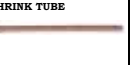





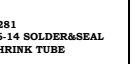



Packaged in a Locking Steel Drawer for Easy Storage & Organization



IBS, Inc.
SPECIALTY PRODUCTS FOR MAINTENANCE & REPAIR
INDUSTRIALBOLT.COM • 800-678-1906

Crimp-N-Seal Terminals
Assortment No. 316R

			<p>B5223 16-14 CRIMP & SEAL #8 RING TERM</p> 	<p>B5224 16-14 CRIMP & SEAL #10 RING TERM</p> 	<p>B280 22-18 SOLDER&SEAL SHRINK TUBE</p> 
<p>B5225 16-14 CRIMP & SEAL 1/4 RING TERM</p> 	<p>B5228 16-14 CRIMP & SEAL #10 SPADE TERM</p> 	<p>B5245 16-14 CRIMP & SEAL .250 FEMALE CONN</p> 	<p>B5255 16-14 CRIMP & SEAL .250 MALE CONN</p> 	<p>B5265 16-14 CRIMP & SEAL .156 MALE BULLET</p> 	<p>B281 16-14 SOLDER&SEAL SHRINK TUBE</p> 
<p>B5275 16-14 CRIMP & SEAL .156 FEMALE BULLET</p> 	<p>B5324 12-10 CRIMP & SEAL #10 RING TERM</p> 	<p>B5325 12-10 CRIMP & SEAL 1/4 RING TERM</p> 	<p>B5327 12-10 CRIMP & SEAL 3/8 RING TERM</p> 	<p>B5345 12-10 CRIMP & SEAL .250 FEMALE CONN</p> 	<p>B282 12-10 SOLDER&SEAL SHRINK TUBE</p> 
<p>B5355 12-10 CRIMP & SEAL .250 MALE CONN</p> 	<p>B5110 20-18 CRIMP & SEAL BUTT CONNECTOR</p> 	<p>B5210 16-14 CRIMP & SEAL BUTT CONNECTOR</p> 	<p>B5310 12-10 CRIMP & SEAL BUTT CONNECTOR</p> 	<p>B5100 24-22 CRIMP & SEAL BUTT CONNECTOR</p> 	

PRODUCT CATEGORY: Q

Crimp-N-Seal Terminals

20 Items • 348 Pcs
IBS No. 316R



Packaged in a Locking Steel Drawer for Easy Storage & Organization

ASSORTMENTS



IBS, INCORPORATED

Assortments - Electrical (Q)

ASSORTMENTS

Multilink Wire Ends
With Microtorch Butane Torch & Refill Included

Assortment No. 324R

B5518 20-18 MULTILINK BUTT CONNECTOR	125702 20-18 MULTILINK #8 RING TERM	125703 20-18 MULTILINK #10 RING TERM	125713 20-18 MULTILINK #10 SPADE TERM	125738 MICROTORCH BUTANE TORCH	
B5514 16-14 MULTILINK BUTT CONNECTOR	125714 16-14 MULTILINK #10 SPADE TERM	125718 16-14 MULTILINK .250 MALE	125719 16-14 MULTILINK .250 FEMALE	125715 12-10 MULTILINK #10 SPADE TERM	
125705 16-14 MULTILINK #8 RING TERM	125706 16-14 MULTILINK #10 RING TERM	125707 16-14 MULTILINK 1/4 RING TERM	125708 16-14 MULTILINK 3/8 RING TERM	125720 12-10 MULTILINK .250 MALE	
B5510 12-10 MULTILINK BUTT CONNECTOR	125709 12-10 MULTILINK #10 RING TERM	125710 12-10 MULTILINK 1/4 RING TERM	125711 12-10 MULTILINK 3/8 RING TERM	125721 12-10 MULTILINK .250 FEMALE	95007 42 GRAM BUTANE REFILL

PRODUCT CATEGORY: Q

Multilink Wire Ends
with Micro Butane Torch
21 Items • 147 Pcs
IBS No. 324R



Packaged in a Locking Steel Drawer for Easy Storage & Organization

Automotive Bulbs

Assortment No. 327R

B194 #194 12V INSTRUMENT / SIDE LIGHT	B194NA 12V AMBER PARKING / SIDE LIGHT	B1893 12V HD AUTO INSTRUMENT LIGHT	B1895 12V PARKING / SIDE MARKER LIGHT	B93 12V AUTO INSTRUMENT LIGHT	
B57 12V AUTO INSTRUMENT LIGHT	B1157 12V STOP - TURN - SIGNAL LIGHT	B1157NA 12V STOP - TAIL - SIGNAL LIGHT	B3157 12V STOP - TAIL - TURN LIGHT	B3157NA 12V STOP - TAIL - TURN LIGHT	
B2057 12V STOP - TAIL - TURN LIGHT	B3057 12V STOP - TAIL - TURN LIGHT	B1156 12V FRONT & REAR TURN LIGHT	B3156 12V FRONT & REAR TURN LIGHT		
B916 12V PARKING / SIDE MARKER LIGHT	B97 12V PARKING / LICENSE PLATE LIGHT				

PRODUCT CATEGORY: Q

Automotive Bulbs
16 Items • 160 Pcs
IBS No. 327R



Packaged in a Locking Steel Drawer for Easy Storage & Organization

Automotive Shrink Tubing
12" Cut Lengths

Assortment No. 338R

B3313 14-4AWG HI FLOW ADHESIVE	
B3312 16-8AWG HI FLOW ADHESIVE	
B3311 22-10AWG HI FLOW ADHESIVE	
B3310 24-12AWG HI FLOW ADHESIVE	
B3301 3/16 X 12" CLEAR DUAL WALL	
B3300 1/8 X 12" CLEAR DUAL WALL	

PRODUCT CATEGORY: Q

Automotive Shrink Tubing
12" Cut Lengths
6 Items • 30 Pcs
IBS No. 338R



Packaged in a Locking Steel Drawer for Easy Storage & Organization

IBS, INCORPORATED

Assortments - Electrical (Q)



 Heavy Duty Truck Circuit Breakers							Assortment No. 340R
CB1911-10 10AMP MAXI BREAKER	CB1911-20 20AMP MAXI BREAKER	CB1911-30 30AMP MAXI BREAKER	CB212-10 10AMP ATM MINI CIRCUIT BREAKER	CB212-15 15AMP ATM MINI CIRCUIT BREAKER	CB212-20 20AMP ATM MINI CIRCUIT BREAKER	CB212-25 25AMP ATM MINI CIRCUIT BREAKER	
CBC-15B 15AMP STUD MOUNTED	CBC-20B 20AMP STUD MOUNTED	CBC-30B 30AMP STUD MOUNTED	CBC-40B 40AMP STUD MOUNTED	CBC-50B 50AMP STUD MOUNTED	CCB-25 25AMP CIRCUIT BREAKER OE#	FCB-20 20AMP CIRCUIT BREAKER OE#	
UCB-10 10AMP UNIVERSAL CIRCUIT	UCB-15 15AMP UNIVERSAL CIRCUIT	UCB-20 20AMP UNIVERSAL CIRCUIT	UCB-25 25AMP UNIVERSAL CIRCUIT	UCB-30 30AMP UNIVERSAL CIRCUIT	CBF-20 20AMP CIRCUIT BREAKER-GLASS	CBF-30 30AMP CIRCUIT BREAKER-GLASS	
CB221-10 10AMP ATC BLADE BREAKER TYPE 1	CB221-15 15AMP ATC BLADE BREAKER TYPE 1	CB221-20 20AMP ATC BLADE BREAKER TYPE 1	CB221-30 30AMP ATC BLADE BREAKER TYPE 1	CBB-30 30AMP ATC STYLE CIRCUIT			

PRODUCT CATEGORY: Q

Heavy Duty Truck Circuit Breakers

26 Items • 26 Pcs
IBS No. 340R



Packaged in a Locking Steel Drawer for Easy Storage & Organization

 LED Smart Fuses						Assortment No. 364R
139212 ATM 5 Amp Mini / Amber	139214 ATM 10 Amp Mini / Red	139215 ATM 15 Amp Mini / Blue	139216 ATM 20 Amp Mini / Yellow	139217 ATM 25 Amp Mini / Clear	139447 ATM Mini In-Line Clear Cover Fuseholder	
139218 ATM 30 Amp Mini / Green		139222 ATC 5 Amp Amber	139224 ATC 10 Amp Red	139225 ATC 15 Amp Blue	139450 ATC In-Line Clear Cover Fuseholder	
139226 ATC 20 Amp Yellow	139227 ATC 25 Amp Clear	139228 ATC 30 Amp Green		139411 MAXI 20 Amp Yellow	139425 MAXI In-Line Fuseholder with Cover	
139412 MAXI 30 Amp Green	139413 MAXI 40 Amp Amber	139414 MAXI 50 Amp Red	139415 MAXI 60 Amp Blue	139416 MAXI 80 Amp Clear		









PRODUCT CATEGORY: Q

LED Smart Fuses

22 Items • 76 Pcs
IBS No. 364R



Packaged in a Locking Steel Drawer for Easy Storage & Organization

 Black Nylon Ty-Raps with Metal Tabs		Assortment No. 370R
104487 MINI CABLE TIE GUN		
104493 13IN 120LB BLACK NYLON TYRAP METAL TAB		
104492 14IN 50LB BLACK NYLON TYRAP METAL TAB		
104491 11IN 50LB BLACK NYLON TYRAP METAL TAB		
104490 7IN 50LB BLACK NYLON TYRAP METAL TAB		
104488 3-1/2 18LB BLACK NYLON TYRAP METAL TAB		
104489 5-1/2 30LB BLACK NYLON TYRAP METAL TAB		

PRODUCT CATEGORY: Q

Black Nylon Ty-Raps with Metal Tabs

7 Items • 251 Pcs
IBS No. 370R



Packaged in a Locking Steel Drawer for Easy Storage & Organization



IBS, INCORPORATED

Assortments - Electrical (Q)

ASSORTMENTS

IBS, Inc. SPECIALTY PRODUCTS FOR MAINTENANCE & REPAIR INDUSTRIALBOLTY.COM 800-678-1506						Multilink Wire Ends
						Assortment No. 385R
B5518 20-18 MULTILINK BUTT CONNECTOR	B5530 20-18 TO 16-14 MULTILINK STEP	B5514 16-14 MULTILINK BUTT CONNECTOR	B5540 16-14 TO 12-10 MULTILINK STEP	B5510 12-10 MULTILINK BUTT CONNECTOR	B5550 12-10 TO 8GA MULTILINK STEP	
125702 20-18 MULTILINK #8 RING TERM	125713 20-18 MULTILINK #10 SPADE TERM	125705 16-14 MULTILINK #8 RING TERM	125714 16-14 MULTILINK #10 SPADE TERM	125709 12-10 MULTILINK #10 RING TERM	125715 12-10 MULTILINK #10 SPADE TERM	
125703 20-18 MULTILINK #10 RING TERM	125716 20-18 MULTILINK .250 MALE	125706 16-14 MULTILINK #10 RING TERM	125718 16-14 MULTILINK .250 MALE	125710 12-10 MULTILINK 1/4 RING TERM	125720 12-10 MULTILINK .250 MALE	
125704 20-18 MULTILINK 1/4 RING TERM	125717 20-18 MULTILINK .250 FEMALE	125707 16-14 MULTILINK 1/4 RING TERM	125719 16-14 MULTILINK .250 FEMALE	125711 12-10 MULTILINK 3/8 RING TERM	125721 12-10 MULTILINK .250 FEMALE	

PRODUCT CATEGORY: Q

Multilink Wire Ends

24 Items • 175 Pcs

IBS No. 385R



Packaged in a Locking Steel Drawer for Easy Storage & Organization

IBS, Inc. SPECIALTY PRODUCTS FOR MAINTENANCE & REPAIR INDUSTRIALBOLTY.COM 800-678-1506						Crimp & Seal Wire Ends
						Assortment No. 386R
B5110 20-18 CRIMP & SEAL BUTT CONNECTOR	B5115 20-18 CRIMP & SEAL 1/4 RING TERM	B5210 16-14 CRIMP & SEAL BUTT CONNECTOR	B5227 16-14 CRIMP & SEAL 3/8 RING TERM	B5310 12-10 CRIMP & SEAL BUTT CONNECTOR	B5327 12-10 CRIMP & SEAL 3/8 RING TERM	
B5112 20-18 CRIMP & SEAL #6 RING TERM	B5118 20-18 #10 CRIMP & SEAL SPADE TERM	B5223 16-14 CRIMP & SEAL #8 RING TERM	B5228 16-14 CRIMP & SEAL #10 SPADE TERM	B5323 12-10 CRIMP & SEAL #8 RING TERM	B5331 12-10 CRIMP & SEAL #10 SPADE TERM	
B5113 20-18 CRIMP & SEAL #8 RING TERM	B5155 20-18 CRIMP & SEAL .250 MALE CONN	B5224 16-14 CRIMP & SEAL #10 RING TERM	B5255 16-14 CRIMP & SEAL .250 MALE CONN	B5324 12-10 CRIMP & SEAL #10 RING TERM	B5355 12-10 CRIMP & SEAL .250 MALE CONN	
B5114 20-18 CRIMP & SEAL #10 RING TERM	B5145 20-18 CRIMP & SEAL .250 FEMALE CONN	B5225 16-14 CRIMP & SEAL 1/4 RING TERM	B5245 16-14 CRIMP & SEAL .250 FEMALE CONN	B5325 12-10 CRIMP & SEAL 1/4 RING TERM	B5345 12-10 CRIMP & SEAL .250 FEMALE CONN	

PRODUCT CATEGORY: Q

Crimp & Seal Wire Ends

24 Items • 240 Pcs

IBS No. 386R



Packaged in a Locking Steel Drawer for Easy Storage & Organization

IBS, Inc. SPECIALTY PRODUCTS FOR MAINTENANCE & REPAIR INDUSTRIALBOLTY.COM 800-678-1506				Fusion Battery Ends
				Assortment No. 387R
B2117 4-6GA NEG STRT FUSION BATTERY	B21171 4-6GA POS STRT FUSION BATTERY	B2118 1-2GA NEG STRT FUSION BATTERY	B2119 1-2GA POS STRT FUSION BATTERY	
B2120 1/0 NEG STRT FUSION BATTERY	B2121 1/0 POS STRT FUSION BATTERY	B2122 2/0 NEG STRT FUSION BATTERY	B2123 2/0 POS STRT FUSION BATTERY	
B2124 3/0 NEG STRT FUSION BATTERY	B2125 3/0 POS STRT FUSION BATTERY	B2126 4/0 NEG STRT FUSION BATTERY	B2127 4/0 POS STRT FUSION BATTERY	

PRODUCT CATEGORY: Q

Fusion Battery Ends

12 Items • 22 Pcs

IBS No. 387R



Packaged in a Locking Steel Drawer for Easy Storage & Organization

IBS, INCORPORATED

Assortments - Electrical (Q)



IBS, Inc.
SPECIALTY PRODUCTS FOR MAINTENANCE & REPAIR
INDUSTRIALBOLTY.COM • 800-670-1906

Procell Alkaline Batteries

Assortment No. 395R

EN95 D SIZE PROCELL ALKALINE BATTERY	EN93 C SIZE PROCELL ALKALINE BATTERY	EN91 AA PROCELL ALKALINE BATTERY	EN92 AAA PROCELL ALKALINE BATTERY
			EN22 9 VOLT PROCELL ALKALINE BATTERY

PRODUCT CATEGORY: Q

Procell Alkaline Batteries

5 Items • 46 Pcs
IBS No. 395R



Packaged in a Locking Steel Drawer for Easy Storage & Organization

IBS, Inc.
SPECIALTY PRODUCTS FOR MAINTENANCE & REPAIR
INDUSTRIALBOLTY.COM • 800-670-1906

Red 22-18 Electrical Connectors

Assortment No. 400R

61-SN 22-18 BUTT CONN NYLON	61NBM 22-18 MOISTURE RESIST BUTT CON	B5518 20-18 MULTILINK BUTT CONNECTOR	31-6NB 22-18 SPADE TERM 6 STUD NYLON	31-8NB 22-18 SPADE TERM 8 STUD NYLON	31-10NB 22-18 SPADE TERM 10 STUD NYLON
11-6SNB 22-18 RING TERM 6 STUD NYLON	11-8SNB 22-18 RING TERM 8 STUD NYLON	11-10NB 22-18 RING TERM 10 STUD NYLON	11-14SNB 22-18 RING TERM 1/4 STUD NYLON	11-56NB 22-18 RING TERM 5/16 STUD NYL	11-38NB 22-18 RING TERM 3/8 STUD NYLO
81M-156-NB 22-18 MALE SNAP PLUG FULL NY	81F-156-NBL 22-18 FEMALE SNAP PLUG FULL NY	71M-250-32-NBL 22-18 MALE QIK SLIDE FULL	71F-250-32-NBL 22-18 FEMALE QIK SLIDE FULL NY	71M-250-32-NB 22-18 MALE QIK SLIDE NYLON	71F-250-32-NB 22-18 FEMALE QIK SLIDE NYLON
71F-250-90-NBL 22-18 1/4 90DGR F QIK NYLON	81P-47-NB 22-18 PIN TERMINAL NYLON				

PRODUCT CATEGORY: Q

Red 22-18 Electrical Connectors

20 Items • 215 Pcs
IBS No. 400R



Packaged in a Locking Steel Drawer for Easy Storage & Organization

IBS, Inc.
SPECIALTY PRODUCTS FOR MAINTENANCE & REPAIR
INDUSTRIALBOLTY.COM • 800-670-1906

Blue 16-14 Electrical Connectors

Assortment No. 401R

62-SN 16-14 BUTT CONN NYLON	62NBM 16-14 MOISTURE RESIST BUTT CON	B5514 16-14 MULTILINK BUTT CONNECTOR	32-6NB 16-14 SPADE TERM 6 STUD NYLON	32-8NB 16-14 SPADE TERM 8 STUD NYLON	32-10NB 16-14 SPADE TERM 10 STUD NYLON
12-6SNB 16-14 RING TERM 6 STUD NYLON	12-8SNB 16-14 RING TERM 8 STUD NYLON	12-10NB 16-14 RING TERM 10 STUD NYLON	12-14SNB 16-14 RING TERM 1/4 STUD NYLON	12-56SNB 16-14 RING TERM 5/16 STUD NYLO	12-38NB 16-14 RING TERM 3/8 STUD NYLON
82M-156-NB 16-14 MALE SNAP PLUG NYLON	82F-156-NBL 16-14 FEMALE SNAP PLUG FULL NY	72M-250-32-NBL 16-14 MALE QIK SLIDE FULL	72F-250-32-NBL 16-14 FEMALE QIK SLIDE FULL NY	72M-250-32-NB 16-14 MALE QIK SLIDE NYLON	72F-250-32-NB 16-14 FEMALE QIK SLIDE NYLON
72F-250-90-NBL 16-14 90DGR 1/4 F QIK NYLON	82P-47-NB 16-14 PIN TERMINAL NYLON				

PRODUCT CATEGORY: Q

Blue 16-14 Electrical Connectors

20 Items • 215 Pcs
IBS No. 401R



Packaged in a Locking Steel Drawer for Easy Storage & Organization



IBS, INCORPORATED

Assortments - Electrical (Q)

ASSORTMENTS

IBS, Inc. SPECIALTY PRODUCTS FOR MAINTENANCE & REPAIR INDUSTRIALBOLT.COM © © © 800-870-1506		Yellow 12-10 Electrical Connectors		
Assortment No. 402R				
63-5N 12-10 BUTT CONN NYLON	63NM 12-10 MOISTURE RESIST BUTT CON	B5510 12-10 MULTILINK BUTT CONNECTOR	33-8NB 12-10 SPADE TERM 8 STUD NYLON	33-10NB 12-10 SPADE TERM 10 STUD NYLON
13-10NB 12-10 RING TERM 10 STUD NYLON	13-14SNB 12-10 RING TERM 1/4 STUD NYLON	13-56SNB 12-10 RING TERM 5/16 STUD NYLON	13-38SNB 12-10 RING TERM 3/8 STUD NYLON	13-50NB 12-10 RING TERM 1/2 STUD NYLON
13-8SNB 12-10 RING TERM 8 STUD NYLON	73M-250-32-NBL 12-10 MALE QIK SLIDE FULL NYLON	73F-250-32-NBL 12-10 FEMALE QIK SLIDE FULL NY	73M-250-32-NB 12-10 MALE QIK SLIDE NYLON	73F-250-32-NB 12-10 FEMALE QIK SLIDE NYLON
83P-55-NB 12-10 PIN TERMINAL NYLON				

PRODUCT CATEGORY: Q

Yellow 12-10 Electrical Connectors

16 Items • 175 Pcs
IBS No. 402R



Packaged in a Locking Steel Drawer for Easy Storage & Organization

IBS, Inc. SPECIALTY PRODUCTS FOR MAINTENANCE & REPAIR INDUSTRIALBOLT.COM © © © 800-870-1506		Special Battery Ends		
Assortment No. 642P				
133328 8-6GA OEM POSITIVE BATTERY END	N7000 HVY DUTY TOP MOUNT BATT TERM	133338 POST TO SIDE MNT BATTERY END	133335 MARINE WING NUT BATTERY END	133336 MARINE WING NUT BATTERY END
133329 8-6GA OEM NEGATIVE BATTERY END	133332 AUTOMOTIVE EMERGENCY POS.	133338 POST TO SIDE MNT BATTERY END	B6007 SIDE MNT BATTERY ACC. BOLT	B6024 TOP MNT BATTERY ACC. BOLT
133330 4,2&1GA OEM POSITIVE BATTERY	133333 AUTOMOTIVE EMERGENCY NEG.	133339 SIDE MNT TO POST TOP BATT.	B1101 SIDE MOUNT BATT BOLT OEM	B1102 SIDE MOUNT BATT BOLT EX LONG
133331 4,2&1GA OEM NEGATIVE BATTERY	133334 AUTOMOTIVE SIDE MNT EMERG	133339 SIDE MNT TO POST TOP BATT.	B1110 5/16 X 1-1/4 BATT BOLT & NUT TIN PLATED	

PRODUCT CATEGORY: Q

Special Battery Ends

19 Items • 52 Pcs
IBS No. 642P



Packaged in a Locking Steel Drawer for Easy Storage & Organization

IBS, Inc. SPECIALTY PRODUCTS FOR MAINTENANCE & REPAIR INDUSTRIALBOLT.COM © © © 800-870-1506		Colored Cable Tie Wraps	
Assortment No. 710R			
BL-4-18 4" 18LB BLUE NYLON TIE		R-4-18 4" 18LB RED NYLON TIE	
Y-4-18 4" 18LB FLOURESCENT YELLOW NYLON TIE		L-4-18 4" 18LB NATURAL NYLON TIE	
B-7-50 7" 50LB BLACK NYLON TIE		B-4-18 4" 18LB BLACK NYLON TIE	
FB-7-50 7" 50LB FLOURESCENT BLUE NYLON TIE		L-7-50 7" 50LB NATURAL NYLON TIE	
FO-7-50 7" 50LB FLOURESCENT ORANGE NYLON TIE		FG-7-50 7" 50LB FLOURESCENT GREEN NYLON TIE	
FV-7-50 7" 50LB FLOURESCENT YELLOW NYLON TIE		FP-7-50 7" 50LB FLOURESCENT PINK NYLON TIE	

PRODUCT CATEGORY: Q

Colored Cable Tie Wraps

12 Items • 1200 Pcs
IBS No. 710R



Packaged in a Locking Steel Drawer for Easy Storage & Organization

IBS, INCORPORATED

Assortments - Electrical (Q)



IBS, Inc.
SPECIALTY PRODUCTS FOR MAINTENANCE & REPAIR
INDUSTRIALBOLT.COM © © © 800-678-1506

Electrical Tape

Assortment No. 711R

145237 3/4 X 60FT BLUE ELECTRICAL TAPE 	145238 3/4 X 60FT GREEN ELECTRICAL TAPE 	145239 3/4 X 60FT WHITE ELECTRICAL TAPE 	B9211 1" X 30' FUSION TAPE
145240 3/4 X 60FT BROWN ELECTRICAL TAPE 	145241 3/4 X 60FT ORANGE ELECTRICAL TAPE 	145242 3/4 X 60FT YELLOW ELECTRICAL TAPE 	B9201 SILICONE TAPE - RED
145243 3/4 X 60FT GRAY ELECTRICAL TAPE 	145244 3/4 X 60FT RED ELECTRICAL TAPE 	N9010 3/4 X 60YD PVC ELECTRICAL 	

PRODUCT CATEGORY: Q

Electrical Tape
11 Items • 20 Pcs
IBS No. 711R



Packaged in a Locking Steel Drawer
for Easy Storage & Organization

IBS, Inc.
SPECIALTY PRODUCTS FOR MAINTENANCE & REPAIR
INDUSTRIALBOLT.COM © © © 800-678-1506

Blade Fuses
ATM, ATC and MAX

720R

ATM2 	ATM3 	ATM4 	ATM5 	ATM7-1/2 	ATM10 	ATM15 	ATM20
ATM25 	ATM30 	ATC2 	ATC3 	ATC4 	ATC5 	ATC7-1/2 	ATC10
ATC15 	ATC20 	ATC25 	ATC30 	ATC40 			
MAX20 	MAX30 	MAX40 	MAX50 	MAX60 	MAX70 	MAX80 	FP-C FUSE PULLER

PRODUCT CATEGORY: Q

Blade Fuses
29 Items • 127 Pcs
IBS No. 720R



Packaged in a Locking Steel Drawer
for Easy Storage & Organization

IBS, Inc.
SPECIALTY PRODUCTS FOR MAINTENANCE & REPAIR
INDUSTRIALBOLT.COM © © © 800-678-1506

12V Miniature
Auto Bulb Assortment

Assortment No. 722R

B37 14V AUTO AIR COURTESY DOME IND AUTOMOTIVE BULB GLASS WEDGE 	B53 12V AUTO INSTRUMENT INDICATOR AUTOMOTIVE BULB MINI BASE 	B57 12V AUTO INSTRUMENT INDICATOR AUTOMOTIVE BULB MINI BASE 	B67 12V PARKING DOME INDICATOR AUTOMOTIVE BULB MINI BASE 	B89 12V PARKING DOME INSTRUMENT AUTOMOTIVE BULB MINI BASE 	B97 12V PARKING LICENSE PLATE AUTOMOTIVE BULB MINI BASE
B194 12V INSTRUMENT SIDE MARKER AUTOMOTIVE BULB GLASS WEDGE 	B194NA 12V SIDE MARKER PARK AMBER AUTOMOTIVE BULB 	B906 12V SIDE MARKER DOME AUTOMOTIVE BULB 	B912 12V SIDE MARKER DOME AUTOMOTIVE BULB 	B916 12V PARKING SIDE MARKER AUTOMOTIVE BULB 	B921 12V SIDE MARKER DOME AUTOMOTIVE BULB
B1156 12V FRONT REAR TURN LIGHT AUTOMOTIVE BULB 	B1157 12V STOP TURN SIGNAL LIGHT AUTOMOTIVE BULB 	B1157NA 12V STOP TAIL SIGNAL AMBER AUTOMOTIVE BULB 	B1893 14V HD INSTRUMENT MINI BASE AUTOMOTIVE BULB 	B1895 12V PARKING SIDE MARKER AUTOMOTIVE BULB 	B2057 12V STOP TAIL TURN LIGHT AUTOMOTIVE BULB
B3057 12V STOP TAIL TURN LIGHT AUTOMOTIVE BULB PLASTIC WEDGE 	B3156 12V FRONT REAR TURN LIGHT AUTOMOTIVE BULB PLASTIC WEDGE 	B3157 12V STOP TAIL TURN LIGHT AUTOMOTIVE BULB PLASTIC WEDGE 	B3157NA 12V STOP TAIL TURN LIGHT AMBER AUTOMOTIVE BULB PLASTIC WEDGE 	S457A INSTRUMENT PANEL BULB SOCKET HOLDER 1/2 HOLE 	S458A INSTRUMENT PANEL BULB SOCKET HOLDER 5/8 HOLE

For Bulb B194 & B194NA For Bulb B194 & B194NA

PRODUCT CATEGORY: Q

12V Mini Auto Fuses
24 Items • 186 Pcs
IBS No. 722R



Packaged in a Locking Steel Drawer
for Easy Storage & Organization

ASSORTMENTS



IBS, INCORPORATED

Assortments - Electrical (Q)

ASSORTMENTS

IBS, Inc. SPECIALTY PRODUCTS FOR MAINTENANCE & REPAIR INDUSTRIALBOLT.COM • 800-478-1506		Automotive Fuse Holders & Accessories	
Assortment No. 723R			
139433 ATR MICRO2 ADD A LINE FUSE HOLDER 20AMP 16GA	139431 ATM 16GA IN LINE FUSE HOLDER 32V 20AMP	139422 12GA ATC FUSE HOLDER & COVER BLACK IN LINE	19513 BLADE TYPE WATER-PROOF IN-LINE FUSE HLDR
139434 ATR MICRO2 INLINE FUSE HOLDER 15AMP 16GA 5IN LEADS	139420 ATM ADD A LINE FUSE HOLDER 32V 2 FUSE 30A	139427 ATC ADD A LINE FUSE HOLDER TAP 2 ATO/ATC MAX 30A	139425 MAXI IN-LINE FUSE HOLDER WITH COVER 32V 60A
139430 ATM LOW PROFILE ADD-A-LINE FUSE HOLDER	139447 14GA ATM FUSE HOLDER & COVER CLEAR MINI	139450 12GA ATC FUSE HOLDER & COVER CLEAR	139435 FMX INLINE FUSE HOLDER 60AMP 8GA 4IN LEADS 58V
139421 12GA ATM IN-LINE FUSE HOLDER W/ COVER 32V 30A	139428 ATM FUSE BLADE TAP .187 TAB	139429 ATC FUSE BLADE TAP .250 TAB	

PRODUCT CATEGORY: Q

Automotive Fuse Holders & Accessories

15 Items • 75 Pcs
IBS No. 723R



Packaged in a Locking Steel Drawer for Easy Storage & Organization

IBS, Inc. SPECIALTY PRODUCTS FOR MAINTENANCE & REPAIR INDUSTRIALBOLT.COM • 800-478-1506		Standard Cable Tie Wraps	
Assortment No. 724R			
L-4-18 4 18LB NATURAL NYLON TIE*	L-5-30 5-1/2 30LB NATURAL NYLON TIE*		
L-7-50 7 50LB NATURAL NYLON TIE*			
L-11-50 11 50LB NATURAL NYLON TIE*			
L-14-50 14 50LB NATURAL NYLON TIE*			
L-14-120 14 120LB NATURAL NYLON TIE*			
L-14-120 14 120LB NATURAL NYLON TIE*			

PRODUCT CATEGORY: Q

Standard Cable Tie Wraps

6 Items • 600 Pcs
IBS No. 724R



Packaged in a Locking Steel Drawer for Easy Storage & Organization

IBS, Inc. SPECIALTY PRODUCTS FOR MAINTENANCE & REPAIR INDUSTRIALBOLT.COM • 800-478-1506		Weather Resistant Cable Tie Wraps	
Assortment No. 725R			
B-4-18 4 18LB BLACK NYLON TIE*	B-5-30 5 30LB BLACK NYLON TIE*		
B-7-50 7 50LB BLACK NYLON TIE*			
B-11-50 11 50LB BLACK NYLON TIE*			
B-14-50 14 BLACK NYLON TIE*			
B-14-120 14 120LB BLACK NYLON TIE*			
B-14-120 14 120LB BLACK NYLON TIE*			

PRODUCT CATEGORY: Q

Weather-Resistant Cable Tie Wraps

6 Items • 600 Pcs
IBS No. 725R



Packaged in a Locking Steel Drawer for Easy Storage & Organization

IBS, INCORPORATED

Assortments - Electrical (Q)



IBS, Inc.
SPECIALTY PRODUCTS FOR MAINTENANCE & REPAIR
INDUSTRIALBOLT.COM © © © 800-678-1906

Releasable Cable Tie Wraps
Assortment No. 726R

RB-5-50 5' 50LB BLACK RELEASABLE NYLON TIE	
RB-8-50 8' 50LB BLACK RELEASABLE NYLON TIE	
RB-12-50 12' 50LB BLACK RELEASABLE NYLON TIE	
RB-14-50 14' 50LB BLACK RELEASABLE NYLON TIE	
141146 29.5 200# YELLOW NYLON*	

PRODUCT CATEGORY: Q

Releasable Cable Tie Wraps

5 Items • 310 Pcs
IBS No. 726R



Packaged in a Locking Steel Drawer for Easy Storage & Organization

IBS, Inc.
SPECIALTY PRODUCTS FOR MAINTENANCE & REPAIR
INDUSTRIALBOLT.COM © © © 800-678-1906

Mounting Tie Wraps
Assortment No. 727R

SM-6-50 6' 50LB STUD MOUNT CABLE TIE WRAP BLACK	
PMB-8-50 8' 50LB BLACK PUSH MOUNT CABLE TIE WRAP	
BH-10-100 9-5/8" 100LB BUTTON HD TIE WRAP BLACK	
MH-7-50 7' 50LB NATURAL MOUNTING NYLON TIE WRAP	MBH-7-50 7' 50LB BLACK NYLON MOUNTING TIE
MH-14-120 14' 120LB NATURAL MOUNTING NYLON TIE WRAP	
141140 13IN DUAL CLAMP CABLE TIE BLACK	

PRODUCT CATEGORY: Q

Cable & Tubing Mounting Cable Tie Wraps

7 Items • 255 Pcs
IBS No. 727R



Packaged in a Locking Steel Drawer for Easy Storage & Organization

IBS, Inc.
SPECIALTY PRODUCTS FOR MAINTENANCE & REPAIR
INDUSTRIALBOLT.COM © © © 800-678-1906

Silicone Sealing Tape
Assortment No. 743R

B9201 TAPE SILICONE RED 1" X 36'	B9202 TAPE SILICONE BLACK 1" X 36'	B9204 TAPE SILICONE GRAY 1" X 36'	B9205 TAPE SILICONE CLEAR 1" X 36'
B9206 TAPE SILICONE RED 2" X 10'	B9207 TAPE SILICONE BLACK 2" X 10'	B9208 TAPE SILICONE GRAY 2" X 10'	B9209 TAPE SILICONE CLEAR 2" X 10'

PRODUCT CATEGORY: Q

Silicone Sealing Tape

8 Items • 8 Pcs
IBS No. 743R



Packaged in a Locking Steel Drawer for Easy Storage & Organization

ASSORTMENTS



IBS, INCORPORATED

Assortments - Electrical (Q)

ASSORTMENTS

IBS, Inc. SPECIALTY PRODUCTS FOR MAINTENANCE & REPAIR INDUSTRIALBOLT.COM © © © 800-678-1506						Copper Tubular Lugs
Assortment 755R						
B8101 BATT TERM #8AWG #10 STUD LUG 	B6101 BATT TERM #6AWG #10 STUD LUG 	B4141 BATT TERM #4AWG 1/4 STUD LUG 	B2381 BATT TERM #2AWG 3/8 STUD LUG 	B10381 BATT TERM 1/0AWG 3/8 STUD LUG 	B30381 BATT TERM 3/0AWG 3/8 STUD LUG 	
B8141 BATT TERM #8AWG 1/4 STUD LUG 	B6141 BATT TERM #6AWG 1/4 STUD LUG 	B4561 BATT TERM #4AWG 5/16 STUD LUG 	B2503 BATT TERM #2AWG 1/2 STUD LUG 	B10501 BATT TERM 1/0AWG 1/2 STUD LUG 	B30501 BATT TERM 3/0AWG 1/2 STUD LUG 	
B8561 BATT TERM #8AWG 5/16 STUD LUG 	B6561 BATT TERM #6AWG 5/16 STUD LUG 	B4381 BATT TERM #4AWG 3/8 STUD LUG 	B1381 BATT TERM #1AWG 3/8 STUD LUG 	B20381 BATT TERM 2/0AWG 3/8 STUD LUG 	B40381 BATT TERM 4/0AWG 3/8 STUD LUG 	
B8383 BATT TERM #8AWG 3/8 STUD LUG 	B6583 BATT TERM #6AWG 3/8 STUD LUG 	B4503 BATT TERM #4AWG 1/2 STUD LUG 	B1501 BATT TERM #1AWG 1/2 STUD LUG 	B20501 BATT TERM 2/0AWG 1/2 STUD LUG 	B40501 BATT TERM 4/0AWG 1/2 STUD LUG 	

PRODUCT CATEGORY: Q

Copper Tubular Lugs
24 Items • 120 Pcs
IBS No. 755R



Packaged in a Locking Steel Drawer
for Easy Storage & Organization

IBS, Inc. SPECIALTY PRODUCTS FOR MAINTENANCE & REPAIR INDUSTRIALBOLT.COM © © © 800-678-1506						Tin Plated Copper Tubular Lugs
Assortment 760R						
B8101P BATT TERM #8AWG #10 STUD LUG 	B6101P BATT TERM #6AWG #10 STUD LUG 	B4141P BATT TERM #4AWG 1/4 STUD LUG 	B2381P BATT TERM #2AWG 3/8 STUD LUG 	B10381P BATT TERM 1/0AWG 3/8 STUD LUG 	B30381P BATT TERM 3/0AWG 3/8 STUD LUG 	
B8141P BATT TERM #8AWG 1/4 STUD LUG 	B6141P BATT TERM #6AWG 1/4 STUD LUG 	B4561P BATT TERM #4AWG 5/16 STUD LUG 	B2503P BATT TERM #2AWG 1/2 STUD LUG 	B10501P BATT TERM 1/0AWG 1/2 STUD LUG 	B30501P BATT TERM 3/0AWG 1/2 STUD LUG 	
B8561P BATT TERM #8AWG 5/16 STUD LUG 	B6561P BATT TERM #6AWG 5/16 STUD LUG 	B4381P BATT TERM #4AWG 3/8 STUD LUG 	B1381P BATT TERM #1AWG 3/8 STUD LUG 	B20381P BATT TERM 2/0AWG 3/8 STUD LUG 	B40381P BATT TERM 4/0AWG 3/8 STUD LUG 	
B8383P BATT TERM #8AWG 3/8 STUD LUG 	B6583P BATT TERM #6AWG 3/8 STUD LUG 	B4503P BATT TERM #4AWG 1/2 STUD LUG 	B1501P BATT TERM #1AWG 1/2 STUD LUG 	B20501P BATT TERM 2/0AWG 1/2 STUD LUG 	B40501P BATT TERM 4/0AWG 1/2 STUD LUG 	

PRODUCT CATEGORY: Q

Tin Plated Copper Tubular Lugs
24 Items • 120 Pcs
IBS No. 760R



Packaged in a Locking Steel Drawer
for Easy Storage & Organization

IBS, Inc. SPECIALTY PRODUCTS FOR MAINTENANCE & REPAIR INDUSTRIALBOLT.COM © © © 800-678-1506						Sealed Wire Connectors II
Assortment No. 761R						
B5560 26-24 TO 22-18 MULTILINK STEP BUTT CONNECTOR 	B5610 20-18 X 16-14 CRIMP & SEAL STEP BUTT CON 	B5716 20-18 HYDRALINK IN LINE BUTT CONNECTOR 	B5916 22-18 OPTISEAL BUTT CONNECTOR 	61-CS 22-18 COOL-SEAL BUTT CONNECTOR NYLON 		
B5530 20-18 TO 16-14 MULTILINK STEP BUTT CON 	B5620 16-14 12-10 CRIMP & SEAL STEP BUTT CON 	B5714 16-14 HYDRALINK IN LINE BUTT CONNECTOR 	B5914 16-14 OPTISEAL BUTT CONNECTOR 	62-CS 16-14 COOL-SEAL BUTT CONNECTOR NYLON 		
B5540 16-14 TO 12-10 MULTILINK STEP BUTT CON 	B5630 12-10 X 8GA CRIMP & SEAL STEP BUTT CONN 	B5710 12-10 HYDRALINK IN LINE BUTT CONNECTOR 	B5910 12-10 OPTISEAL BUTT CONNECTOR 	63-CS 12-10 COOL-SEAL BUTT CONNECTOR NYLON 		
B5550 12-10 TO 8GA MULTILINK STEP BUTT CONN 	B5814 22-14 HYDRALINK CLOSED END CONNECTOR 	B5810 18-10 HYDRALINK CLOSED END CONNECTOR 				

PRODUCT CATEGORY: Q

Sealed Wire Connectors II
17 Items • 145 Pcs
IBS No. 761R



Packaged in a Locking Steel Drawer
for Easy Storage & Organization

IBS, INCORPORATED

Assortments - Electrical (Q)



IBS, Inc. SPECIALTY PRODUCTS FOR MAINTENANCE & REPAIR INDUSTRIALBOLT.COM © © © 800-670-1506					Micro Fuses
					Assortment No. 766R
ATR5 5AMP MICRO2 FUSE 32V TAN FUSE 	ATR7-1/2 7-1/2AMP MICRO2 FUSE 32V BROWN FUSE 	ATR10 10AMP MICRO2 FUSE 32V RED FUSE 	ATR15 15AMP MICRO2 FUSE 32V BLUE FUSE 	ATR20 20AMP MICRO2 FUSE 32V YELLOW FUSE 	
ATR25 25AMP MICRO2 FUSE 32V CLEAR FUSE 	ATR30 30AMP MICRO2 FUSE 32V GREEN FUSE 	ATL5 5AMP MICRO3 FUSE 32V TAN FUSE 	ATL7-1/2 7-1/2AMP MICRO3 FUSE 32V BROWN FUSE 	ATL10 10AMP MICRO3 FUSE 32V RED FUSE 	
ATL15 15AMP MICRO3 FUSE 32V BLUE FUSE 	FMM15 15AMP MCASE FUSE 32V GREY 	FMM20 20AMP MCASE FUSE 32V BLUE 	FMM25 25AMP MCASE FUSE 32V WHITE 	FMM30 30AMP MCASE FUSE 32V PINK 	
FMM40 40AMP MCASE FUSE 32V GREEN 					

PRODUCT CATEGORY: Q

Micro Fuses
16 Items • 135 Pcs
IBS No. 766R



Packaged in a Locking Steel Drawer for Easy Storage & Organization

IBS, Inc. SPECIALTY PRODUCTS FOR MAINTENANCE & REPAIR INDUSTRIALBOLT.COM © © © 800-670-1506					Deutsch DT Connectors & Terminals with Crimping & Removal Tools	
					Assortment No. 768R	
125104 DEUTSCH 2WAY RECEPTACLE HOUSING 	125106 DEUTSCH 3WAY RECEPTACLE HOUSING 	125108 DEUTSCH 4WAY RECEPTACLE HOUSING 	125110 DEUTSCH 6WAY RECEPTACLE HOUSING 	125112 DEUTSCH 8WAY RECEPTACLE HOUSING 	125100 DEUTSCH 16-18GA SOCKET FOR PIN 	
125105 DEUTSCH 2WAY PLUG HOUSING 	125107 DEUTSCH 3WAY PLUG HOUSING 	125109 DEUTSCH 4WAY PLUG HOUSING 	125111 DEUTSCH 6WAY PLUG HOUSING 	125113 DEUTSCH 8WAY PLUG HOUSING 	125102 DEUTSCH 16-18GA PIN FOR RECEPTACLE 	
125114 DEUTSCH 2WAY RECEPTACLE WEDGE 	125116 DEUTSCH 3WAY RECEPTACLE WEDGE 	125118 DEUTSCH 4WAY RECEPTACLE WEDGE 	125120 DEUTSCH 6WAY FEMALE WEDGE 	125122 DEUTSCH 8WAY FEMALE WEDGE 	125101 DEUTSCH 14-16GA SOCKET FOR PLUG 	
125115 DEUTSCH 2WAY PLUG WEDGE 	125117 DEUTSCH 3WAY PLUG WEDGE 	125119 DEUTSCH 4WAY PLUG WEDGE 	125121 DEUTSCH 6WAY MALE WEDGE 	125123 DEUTSCH 8WAY MALE WEDGE 	125103 DEUTSCH 14-16GA PIN FOR RECEPTACLE 	

PRODUCT CATEGORY: Q

Deutsch DT Connectors & Terminals with Crimping & Removal Tools

26 Items • 134 Pcs
IBS No. 768R



Packaged in a Locking Steel Drawer for Easy Storage & Organization

IBS, Inc. SPECIALTY PRODUCTS FOR MAINTENANCE & REPAIR INDUSTRIALBOLT.COM © © © 800-670-1506					Deutsch DT Connectors & Terminals	
					Assortment No. 769R	
125104 DEUTSCH 2WAY RECEPTACLE HOUSING 	125106 DEUTSCH 3WAY RECEPTACLE HOUSING 	125108 DEUTSCH 4WAY RECEPTACLE HOUSING 	125110 DEUTSCH 6WAY RECEPTACLE HOUSING 	125112 DEUTSCH 8WAY RECEPTACLE HOUSING 	125100 DEUTSCH 16-18GA SOCKET FOR PIN 	
125105 DEUTSCH 2WAY PLUG HOUSING 	125107 DEUTSCH 3WAY PLUG HOUSING 	125109 DEUTSCH 4WAY PLUG HOUSING 	125111 DEUTSCH 6WAY PLUG HOUSING 	125113 DEUTSCH 8WAY PLUG HOUSING 	125102 DEUTSCH 16-18GA PIN FOR RECEPTACLE 	
125114 DEUTSCH 2WAY RECEPTACLE WEDGE 	125116 DEUTSCH 3WAY RECEPTACLE WEDGE 	125118 DEUTSCH 4WAY RECEPTACLE WEDGE 	125120 DEUTSCH 6WAY FEMALE WEDGE 	125122 DEUTSCH 8WAY FEMALE WEDGE 	125101 DEUTSCH 14-16GA SOCKET FOR PLUG 	
125115 DEUTSCH 2WAY PLUG WEDGE 	125117 DEUTSCH 3WAY PLUG WEDGE 	125119 DEUTSCH 4WAY PLUG WEDGE 	125121 DEUTSCH 6WAY MALE WEDGE 	125123 DEUTSCH 8WAY MALE WEDGE 	125103 DEUTSCH 14-16GA PIN FOR RECEPTACLE 	

PRODUCT CATEGORY: Q

Deutsch DT Connectors & Terminals

24 Items • 132 Pcs
IBS No. 769R



Packaged in a Locking Steel Drawer for Easy Storage & Organization

ASSORTMENTS



IBS, INCORPORATED

Assortments - Electrical (Q)

ASSORTMENTS

Metripack 280 Series Electrical Connectors					Assortment No. 770R
125204 METRIPACK 1 PIN MALE CONNECTOR BODY	125208 METRIPACK 1 PIN FEMALE CONNECTOR BODY	125218 METRIPACK 1 PIN T.P.A. MALE & FEMALE	125201 METRIPACK GREEN CABLE SEAL 18-16 & 20-18 GAUGE	125212 METRIPACK 16-18 GAUGE MALE TERMINAL	
125205 METRIPACK 2 PIN MALE CONNECTOR BODY	125209 METRIPACK 2 PIN FEMALE CONNECTOR BODY	125219 METRIPACK 2 PIN T.P.A. MALE & FEMALE	125202 METRIPACK GRAY CABLE SEAL 14-16 GAUGE	125215 METRIPACK 16-18 GAUGE FEMALE TERMINAL	
125206 METRIPACK 3 PIN MALE CONNECTOR BODY	125210 METRIPACK 3 PIN FEMALE CONNECTOR BODY	125220 & 125221 METRIPACK 3 PIN T.P.A. MALE AND FEMALE	125203 METRIPACK BLUE CABLE SEAL 12-14 GAUGE	125213 METRIPACK 12-14 GAUGE MALE TERMINAL	
125207 METRIPACK 5 PIN MALE CONNECTOR BODY	125211 METRIPACK 5 PIN FEMALE CONNECTOR BODY	125222 & 125223 METRIPACK 5 PIN T.P.A. MALE AND FEMALE	125224 METRIPACK CAVITY PLUG	125216 METRIPACK 12-14 GAUGE FEMALE TERMINAL	

PRODUCT CATEGORY: Q

Metripack 280 Series Electrical Connectors & Tools					Assortment No. 771R
125204 METRIPACK 1 PIN MALE CONNECTOR BODY	125208 METRIPACK 1 PIN FEMALE CONNECTOR BODY	125218 METRIPACK 1 PIN T.P.A. MALE & FEMALE	125201 METRIPACK GREEN CABLE SEAL 18-16 & 20-18 GAUGE	125212 METRIPACK 16-18 GAUGE MALE TERMINAL	
125205 METRIPACK 2 PIN MALE CONNECTOR BODY	125209 METRIPACK 2 PIN FEMALE CONNECTOR BODY	125219 METRIPACK 2 PIN T.P.A. MALE & FEMALE	125202 METRIPACK GRAY CABLE SEAL 14-16 GAUGE	125215 METRIPACK 16-18 GAUGE FEMALE TERMINAL	
125206 METRIPACK 3 PIN MALE CONNECTOR BODY	125210 METRIPACK 3 PIN FEMALE CONNECTOR BODY	125220 & 125221 METRIPACK 3 PIN T.P.A. MALE AND FEMALE	125203 METRIPACK BLUE CABLE SEAL 12-14 GAUGE	125213 METRIPACK 12-14 GAUGE MALE TERMINAL	
125207 METRIPACK 5 PIN MALE CONNECTOR BODY	125211 METRIPACK 5 PIN FEMALE CONNECTOR BODY	125222 & 125223 METRIPACK 5 PIN T.P.A. MALE AND FEMALE	125224 METRIPACK CAVITY PLUG	125216 METRIPACK 12-14 GAUGE FEMALE TERMINAL	

PRODUCT CATEGORY: Q

Weatherpack Connectors and Terminals					Assortment No. 772R
125307 WEATHERPACK 1 CAVITY SHROUD MALE	125309 WEATHERPACK 2 CAVITY SHROUD MALE	125311 WEATHERPACK 3 CAVITY SHROUD MALE	125313 WEATHERPACK 4 CAVITY SHROUD MALE	125315 WEATHERPACK 6 CAVITY SHROUD MALE	
125306 WEATHERPACK 1 CAVITY TOWER FEMALE	125308 WEATHERPACK 2 CAVITY TOWER FEMALE	125310 WEATHERPACK 3 CAVITY TOWER FEMALE	125312 WEATHERPACK 4 CAVITY TOWER FEMALE	125314 WEATHERPACK 6 CAVITY TOWER FEMALE	
125300 WEATHERPACK 20-18GA MALE TERMINAL	125302 WEATHERPACK 16-14GA MALE TERMINAL	125304 WEATHERPACK 12GA MALE TERMINAL	125201 METRIPACK AND WEATHERPACK SEAL	125203 METRIPACK AND WEATHERPACK SEAL	
125301 WEATHERPACK 20-18GA FEMALE TERMINAL	125303 WEATHERPACK 16-14GA FEMALE TERMINAL	125305 WEATHERPACK 12GA FEMALE TERMINAL	125202 METRIPACK WEATHERPACK SEAL	125224 METRIPACK & WEATHERPACK CAVITY PLUG	

PRODUCT CATEGORY: Q

Metripack 280 Series

20 Items • 430 Pcs
IBS No. 770R



Packaged in a Locking Steel Drawer for Easy Storage & Organization

Metripack 280 Series with Crimping & Removal Tools

22 Items • 432 Pcs
IBS No. 771R



Packaged in a Locking Steel Drawer for Easy Storage & Organization

Weatherpack Series

20 Items • 329 Pcs
IBS No. 772R



Packaged in a Locking Steel Drawer for Easy Storage & Organization

IBS, INCORPORATED

Assortments - Electrical (Q)



IBS, Inc.
SPECIALTY PRODUCTS FOR MAINTENANCE & REPAIR
INDUSTRIALBOLT.COM ☎ ☎ ☎ 800-678-1596

Weatherpack Connectors and Terminals with Tools

Assortment No. 773R

125307 WEATHERPACK 1 CAVITY SHROUD MALE	125309 WEATHERPACK 2 CAVITY SHROUD MALE	125311 WEATHERPACK 3 CAVITY SHROUD MALE	125313 WEATHERPACK 4 CAVITY SHROUD MALE	125315 WEATHERPACK 6 CAVITY SHROUD MALE	125325 WEATHERPACK 22-12GA CRIMPER 125326 WEATHERPACK TERM EXTRACTOR TOOL
125306 WEATHERPACK 1 CAVITY TOWER FEMALE	125308 WEATHERPACK 2 CAVITY TOWER FEMALE	125310 WEATHERPACK 3 CAVITY TOWER FEMALE	125312 WEATHERPACK 4 CAVITY TOWER FEMALE	125314 WEATHERPACK 6 CAVITY TOWER FEMALE	
125300 WEATHERPACK 20-18GA MALE TERMINAL	125302 WEATHERPACK 16-14GA MALE TERMINAL	125304 WEATHERPACK 12GA MALE TERMINAL	125201 METRIPACK/WEATHERPK SEALGRN 18-16/20-18GA	125203 METRIPACK/WEATHERPK SEAL BLUE 14-12 GA	
125301 WEATHERPACK 20-18GA FEMALE TERMINAL	125303 WEATHERPACK 16-14GA FEMALE TERMINAL	125305 WEATHERPACK 12GA FEMALE TERMINAL	125202 METRIPACK/WEATHERPK SEAL GRAY 16-14 GAUGE	125224 METRIPACK/WEATHERPK CAVITY PLUG	

PRODUCT CATEGORY: Q

Weatherpack Series with Crimping & Removal Tools

22 Items • 331 Pcs
IBS No. 773R



Packaged in a Locking Steel Drawer for Easy Storage & Organization

IBS, Inc.
SPECIALTY PRODUCTS FOR MAINTENANCE & REPAIR
INDUSTRIALBOLT.COM ☎ ☎ ☎ 800-678-1596

Deutsch DT Connectors & Terminals

Assortment No. 780R

125104 DEUTSCH 2WAY FEMALE HOUSING	125106 DEUTSCH 3WAY FEMALE HOUSING	125108 DEUTSCH 4WAY FEMALE HOUSING	125110 DEUTSCH 6WAY FEMALE HOUSING	125112 DEUTSCH 8WAY FEMALE HOUSING	125100 DEUTSCH 16-18GA FEM TERMINAL
125105 DEUTSCH 2WAY MALE HOUSING	125107 DEUTSCH 3WAY MALE HOUSING	125109 DEUTSCH 4WAY MALE HOUSING	125111 DEUTSCH 6WAY MALE HOUSING	125113 DEUTSCH 8WAY MALE HOUSING	125102 DEUTSCH 16-18GA MALE TERMINAL
125114 DEUTSCH 2WAY FEMALE WEDGE	125116 DEUTSCH 3WAY FEMALE WEDGE	125118 DEUTSCH 4WAY FEMALE WEDGE	125120 DEUTSCH 6WAY FEMALE WEDGE	125122 DEUTSCH 8WAY FEMALE WEDGE	125101 DEUTSCH 14-16GA FEM TERMINAL
125115 DEUTSCH 2WAY MALE WEDGE	125117 DEUTSCH 3WAY MALE WEDGE	125119 DEUTSCH 4WAY MALE WEDGE	125121 DEUTSCH 6WAY MALE WEDGE	125123 DEUTSCH 8WAY MALE WEDGE	125103 DEUTSCH 14-16GA MALE TERMINAL

PRODUCT CATEGORY: Q

Deutsch DT Connectors & Terminals II with Crimping & Removal Tools

26 Items • 134 Pcs
IBS No. 780R



Packaged in a Locking Steel Drawer for Easy Storage & Organization

IBS, Inc.
SPECIALTY PRODUCTS FOR MAINTENANCE & REPAIR
INDUSTRIALBOLT.COM ☎ ☎ ☎ 800-678-1596

Metripack 280 Series Electrical Connectors & Tools

Assortment No. 781R

125204 METRIPACK 1 PIN MALE CONNECTOR BODY	125208 METRIPACK 1 PIN FEMALE CONNECTOR BODY	125218 METRIPACK 1 PIN T.P.A. MALE & FEMALE	125201 METRIPACK GREEN CABLE SEAL 18-16 & 20-18 GAUGE	125212 METRIPACK 16-18 GAUGE MALE TERMINAL	125325 - CRIMPING TOOL 125226 - REMOVAL TOOL
125205 METRIPACK 2 PIN MALE CONNECTOR BODY	125209 METRIPACK 2 PIN FEMALE CONNECTOR BODY	125219 METRIPACK 2 PIN T.P.A. MALE & FEMALE	125202 METRIPACK GRAY CABLE SEAL 14-16 GAUGE	125215 METRIPACK 16-18 GAUGE FEMALE TERMINAL	
125206 METRIPACK 3 PIN MALE CONNECTOR BODY	125210 METRIPACK 3 PIN FEMALE CONNECTOR BODY	125220 & 125221 METRIPACK 3 PIN T.P.A. MALE AND FEMALE	125203 METRIPACK BLUE CABLE SEAL 12-14 GAUGE	125213 METRIPACK 12-14 GAUGE MALE TERMINAL	
125207 METRIPACK 5 PIN MALE CONNECTOR BODY	125211 METRIPACK 5 PIN FEMALE CONNECTOR BODY	125222 & 125223 METRIPACK 5 PIN T.P.A. MALE AND FEMALE	125224 METRIPACK CAVITY PLUG	125216 METRIPACK 12-14 GAUGE FEMALE TERMINAL	

PRODUCT CATEGORY: Q

Metripack 280 Series II with Crimping & Removal Tools

22 Items • 432 Pcs
IBS No. 761R



Packaged in a Locking Steel Drawer for Easy Storage & Organization

ASSORTMENTS



IBS, INCORPORATED

Assortments - Electrical (Q)

ASSORTMENTS

IBS, Inc. SPECIALTY PRODUCTS FOR MAINTENANCE & REPAIR INDUSTRIALBOLT.COM • 800-670-1906		7" Colored Cable Tie Wraps	
BL-7-50 7" SOLB BLUE NYLON TIE		GY-7-50 7" SOLB GRAY NYLON TIE	
Y-7-50 7" SOLB YELLOW NYLON TIE		GR-7-50 7" SOLB GREEN NYLON TIE	
R-7-50 7" SOLB RED NYLON TIE		P-7-50 7" SOLB PURPLE NYLON TIE	
BR-7-50 7" SOLB BROWN NYLON TIE		FO-7-50 7" SOLB FLUORESCENT ORANGE NYLON TIE	
FB-7-50 7" SOLB FLUORESCENT BLUE NYLON TIE		FP-7-50 7" SOLB FLUORESCENT PINK NYLON TIE	
FY-7-50 7" SOLB FLUORESCENT YELLOW NYLON TIE		FG-7-50 7" SOLB FLUORESCENT GREEN NYLON TIE	

Assortment No. 786R

PRODUCT CATEGORY: Q

8" Colored Cable Tie Wraps

12 Items • 1200 Pcs
IBS No. 786R



Packaged in a Locking Steel Drawer for Easy Storage & Organization

IBS, Inc. SPECIALTY PRODUCTS FOR MAINTENANCE & REPAIR INDUSTRIALBOLT.COM • 800-670-1906		Crimp & Seal Long Neck Terminals	
136025 22-18 CRIMP & SEAL #6 LONG NECK RING		136029 16-14 CRIMP & SEAL #8 LONG NECK RING	
136026 22-18 CRIMP & SEAL #8 LONG NECK RING		136030 16-14 CRIMP & SEAL #10 LONG NECK RING	
136027 22-18 CRIMP & SEAL #10 LONG NECK RING		136031 16-14 CRIMP & SEAL 1/4 LONG NECK RING	
136028 16-14 CRIMP & SEAL #6 LONG NECK RING		136032 16-14 CRIMP & SEAL 5/16 LONG NECK RING	
		136033 16-14 CRIMP & SEAL 3/8 LONG NECK RING	
		136034 12-10 CRIMP & SEAL #8 LONG NECK RING	
		136035 12-10 CRIMP & SEAL #10 LONG NECK RING	
		136036 12-10 CRIMP & SEAL 1/4 LONG NECK RING	
		136037 12-10 CRIMP & SEAL 5/16 LONG NECK RING	
		136038 12-10 CRIMP & SEAL 3/8 LONG NECK RING	

Assortment No. 790R

PRODUCT CATEGORY: Q

Long Neck Crimp & Seal Terminals

14 Items • 140 Pcs
IBS No. 790R



Packaged in a Locking Steel Drawer for Easy Storage & Organization

IBS, Inc. SPECIALTY PRODUCTS FOR MAINTENANCE & REPAIR INDUSTRIALBOLT.COM • 800-670-1906		Crimp & Seal Wire Ends w/ Long Neck Ring Terminals			
B5110 20-18 CRIMP & SEAL BUTT CONNECTOR		B5118 20-18 #10 CRIMP & SEAL SPADE TERM		136028 16-14 #6 CRIMP & SEAL LONG NECK RING	
136025 22-18 #6 CRIMP & SEAL LONG NECK RING		B5155 20-18 CRIMP & SEAL .250 MALE CONN		136029 16-14 #8 CRIMP & SEAL LONG NECK RING	
136026 22-18 #8 CRIMP & SEAL LONG NECK RING		B5145 20-18 CRIMP & SEAL .250 FEMALE CONN		136030 16-14 #10 CRIMP & SEAL LONG NECK RING	
136027 22-18 #10 CRIMP & SEAL LONG NECK RING		B5210 16-14 CRIMP & SEAL BUTT CONNECTOR		136031 16-14 1/4 CRIMP & SEAL LONG NECK RING	
		B5255 16-14 CRIMP & SEAL .250 MALE CONN		B5245 16-14 CRIMP & SEAL .250 FEMALE CONN	
		B5228 16-14 CRIMP & SEAL #10 SPADE TERM		136033 16-14 3/8 CRIMP & SEAL LONG NECK RING	
		B5310 12-10 CRIMP & SEAL BUTT CONNECTOR		136034 12-10 #8 CRIMP & SEAL LONG NECK RING	
		B5331 12-10 CRIMP & SEAL #10 SPADE TERM		136035 12-10 #10 CRIMP & SEAL LONG NECK RING	
		B5355 12-10 CRIMP & SEAL .250 MALE CONN		136036 12-10 1/4 CRIMP & SEAL LONG NECK RING	
		B5345 12-10 CRIMP & SEAL .250 FEMALE CONN			

Assortment No. 791R

PRODUCT CATEGORY: Q

Crimp & Seal Terminals with Long Neck Ring Terminals

24 Items • 240 Pcs
IBS No. 791R



Packaged in a Locking Steel Drawer for Easy Storage & Organization

IBS, INCORPORATED

Assortments - Electrical (Q)



IBS, Inc. SPECIALTY PRODUCTS FOR MAINTENANCE & REPAIR INDUSTRIALADULT.COM © IBS 800-478-1906					
Optiseal Terminals					
Assortment No. 793R					
B5916 22-18 OPTISEAL BUTT CONNECTOR 	136017 22-18 TO 16-14 OPTISEAL STEP BUTT 	B5914 16-14 OPTISEAL BUTT CONNECTOR 	136016 16-14 TO 12-10 OPTISEAL STEP BUTT 	B5910 12-10 OPTISEAL BUTT CONNECTOR 	136015 12-10 TO 8GA OPTISEAL STEP BUTT CONNECTOR
136018 24-22 TO 22-18 OPTISEAL STEP BUTT 	136014 22-18 #10 OPTISEAL RING TERMINAL 	136007 16-14 #8 OPTISEAL RING TERMINAL 	136011 16-14 3/8 OPTISEAL RING TERMINAL 	136001 12-10 #10 OPTISEAL RING TERMINAL 	136005 12-10 3/8 OPTISEAL RING TERMINAL
136012 22-18 #6 OPTISEAL RING TERMINAL 	136023 22-18 .250 FEMALE OPTISEAL CONNECTOR 	136008 16-14 #10 OPTISEAL RING TERMINAL 	136021 16-14 .250 FEMALE OPTISEAL CONNECTOR 	136002 12-10 #10 OPTISEAL RING TERMINAL 	136019 12-10 .250 FEMALE OPTISEAL CONNECTOR
136013 22-18 #8 OPTISEAL RING TERMINAL 	136024 22-18 .250 MALE OPTISEAL CONNECTOR 	136009 16-14 1/4 OPTISEAL RING TERMINAL 	136039 16-14 .250 MALE OPTISEAL CONNECTOR 	136003 12-10 1/4 OPTISEAL RING TERMINAL 	136020 12-10 .250 MALE OPTISEAL CONNECTOR

PRODUCT CATEGORY: Q

Optiseal Terminals

24 Items • 220 Pcs
IBS No. 793R



Packaged in a Locking Steel Drawer for Easy Storage & Organization

IBS, Inc. SPECIALTY PRODUCTS FOR MAINTENANCE & REPAIR INDUSTRIALADULT.COM © IBS 800-478-1906	
Low Profile and Releasable Cable Tie Wraps	
Assortment No. 796R	
BLP-14-120 14IN 120LB BLACK NYLON LOW PROFILE TIE WRAP 	
BLP-14-50 14IN 50LB BLACK NYLON LOW PROFILE TIE WRAP 	
RB-5-50 5 50LB BLACK RELEASABLE NYLON™ TIE WRAP 	BLP-11-50 11IN 50LB BLACK NYLON LOW PROFILE TIE WRAP
RB-8-50 8 50LB BLACK RELEASABLE NYLON™ TIE WRAP 	BLP-7-50 7IN 50LB BLACK NYLON LOW PROFILE TIE WRAP
RB-12-50 12 50LB BLACK RELEASABLE™ NYLON TIE WRAP 	
RB-14-50 14 50LB BLACK RELEASABLE™ NYLON TIE WRAP 	

PRODUCT CATEGORY: Q

Black Low Profile Cable Tie Wraps

8 Items • 700 Pcs
IBS No. 796R



Packaged in a Locking Steel Drawer for Easy Storage & Organization

IBS, Inc. SPECIALTY PRODUCTS FOR MAINTENANCE & REPAIR INDUSTRIALADULT.COM © IBS 800-478-1906	
Dual Wall Shrink Tubing	
Assortment No. 800R	
16486 3/16 X 6IN BLACK DUAL WALL SHRINK TUBE 	16481 3/16 X 6IN RED DUAL WALL SHRINK TUBE
16487 1/4 X 6IN BLACK DUAL WALL SHRINK TUBE 	16482 1/4 X 6IN RED DUAL WALL SHRINK TUBE
16488 3/8 X 6IN BLACK DUAL WALL SHRINK TUBE 	16483 3/8 X 6IN RED DUAL WALL SHRINK TUBE
16489 1/2 X 6IN BLACK DUAL WALL SHRINK TUBE 	16484 1/2 X 6IN RED DUAL WALL SHRINK TUBE
16490 3/4 X 6IN BLACK DUAL WALL SHRINK TUBE 	16492 3/4 X 6IN RED DUAL WALL SHRINK TUBE
16491 1IN X 6IN BLACK DUAL WALL SHRINK TUBE 	16493 1IN X 6IN RED DUAL WALL SHRINK TUBE

PRODUCT CATEGORY: Q

Dual Wall Shrink Tubing

12 Items • 72 Pcs
IBS No. 800R



Packaged in a Locking Steel Drawer for Easy Storage & Organization



IBS, INCORPORATED

Assortments - Electrical (Q)

ASSORTMENTS

IBS, Inc. SPECIALTY PRODUCTS FOR MAINTENANCE & REPAIR INDUSTRIALBOLTY.COM © © © 800-678-1396		Vinyl Coated Clamps	
Assortment No. 802R			
16540 1/4ID 1/4 STUD VINYL COATED LOOM CLAMP	16531 1/2ID 1/4 STUD VINYL COATED LOOM CLAMP	16547 1ID 3/8 STUD VINYL COATED LOOM CLAMP	16548 1-1/2ID 3/8 STUD VINYL COATED LOOM CLAMP
16541 5/16ID 3/8STUD VINYL COATED LOOM CLAMP	16534 5/8ID 1/4 STUD VINYL COATED LOOM CLAMP	16533 1-1/4ID 13/32 STUD VINYL COATED LOOM CLAMP	16550 2ID 3/8 STUD VINYL COATED LOOM CLAMP
16530 3/8ID 1/4 STUD VINYL COATED LOOM CLAMP	16545 3/4ID 3/8 STUD VINYL COATED LOOM CLAMP		

PRODUCT CATEGORY: Q

Vinyl Coated Clamps
10 Items • 197 Pcs
IBS No. 802R



Packaged in a Locking Steel Drawer
for Easy Storage & Organization

IBS, Inc. SPECIALTY PRODUCTS FOR MAINTENANCE & REPAIR INDUSTRIALBOLTY.COM © © © 800-678-1396		ATR, ATL & ATM Low-Profile Fuses	
Assortment No. 822R			
ATR5 5AMP MICRO2 FUSE 32V TAN FUSE	ATR7-1/2 7-1/2AMP MICRO2 FUSE 32V BROWN FUSE	ATR10 10AMP MICRO2 FUSE 32V RED FUSE	ATR15 15AMP MICRO2 FUSE 32V BLUE FUSE
ATR25 25AMP MICRO2 FUSE 32V CLEAR FUSE	ATR30 30AMP MICRO2 FUSE 32V GREEN FUSE	ATL5 5AMP MICRO3 FUSE 32V TAN FUSE	ATL7-1/2 7-1/2AMP MICRO3 FUSE 32V BROWN FUSE
ATL15 15AMP MICRO3 FUSE 32V BLUE FUSE	ATM5LP AUTO FUSE ATM LOW PROFILE 5AMP	ATM7-1/2LP AUTO FUSE ATM LOW PROFILE 7-1/2AMP	ATM10LP AUTO FUSE ATM LOW PROFILE 10AMP
ATM20LP AUTO FUSE ATM LOW PROFILE 20AMP	ATM25LP AUTO FUSE ATM LOW PROFILE 25AMP	ATM30LP AUTO FUSE ATM LOW PROFILE 30AMP	ATM15LP AUTO FUSE ATM LOW PROFILE 15AMP

PRODUCT CATEGORY: Q

**ATR, ATL & ATM
Low Profile Fuses**
18 Items • 160 Pcs
IBS No. 822R



Packaged in a Locking Steel Drawer
for Easy Storage & Organization

IBS, Inc. SPECIALTY PRODUCTS FOR MAINTENANCE & REPAIR INDUSTRIALBOLTY.COM © © © 800-678-1396		Micro Cartridge Fuses	
Assortment No. 823R			
FMX-20 20AMP BLUE MAXI FUSE JCASE	FMX-25 25AMP WHITE MAXI FUSE JCASE	FMX-30 30AMP PINK MAXI FUSE JCASE	FMX-40 40AMP GREEN MAXI FUSE JCASE
FMX-50 50AMP RED MAXI FUSE JCASE	FMX-60 60AMP YELLOW MAXI FUSE JCASE	FMX-20LP 20AMP BLUE LP MAXI FUSE JCASE LP - LOW PROFILE	FMX-25LP 25AMP WHITE LP MAXI FUSE JCASE LP - LOW PROFILE
FMX-30LP 30AMP PINK LP MAXI FUSE JCASE LP - LOW PROFILE	FMX-40LP 40AMP GREEN LP MAXI FUSE JCASE LP - LOW PROFILE	FMX-50LP 50AMP RED LP MAXI FUSE JCASE LP - LOW PROFILE	FMX-60LP 60AMP YELLOW LP MAXI FUSE JCASE LP - LOW PROFILE
FMM15 15AMP MCASE FUSE 32V GRAY	FMM20 20AMP MCASE FUSE 32V BLUE	FMM25 25AMP MCASE FUSE 32V WHITE	FMM30 30AMP MCASE FUSE 32V PINK
FMM40 40AMP MCASE FUSE 32V GREEN	FMS15 15AMP MCASE FUSE 32V GRAY SLOTTED	FMS20 20AMP MCASE FUSE 32V BLUE SLOTTED	FMS25 25AMP MCASE FUSE 32V WHITE SLOTTED
FMS30 30AMP MCASE FUSE 32V PINK SLOTTED	FMS40 40AMP MCASE FUSE 32V GREEN SLOTTED	FMS50 50AMP MCASE FUSE 32V RED SLOTTED	FMS60 60AMP MCASE FUSE 32V YELLOW SLOTTED

PRODUCT CATEGORY: Q

Micro Cartridge Fuses
24 Items • 48 Pcs
IBS No. 823R



Packaged in a Locking Steel Drawer
for Easy Storage & Organization

IBS, INCORPORATED

Assortments - Electrical (Q)



Automotive Circuit Breakers ATM & ATC							
Assortment No. 824R							
CB212-10 10AMP ATM MINI CIRC BREAKER II	CB212-15 15AMP ATM MINI CIRCUIT BREAKER II	CB212-20 20AMP ATM MINI CIRCUIT BREAKER II	CB212-25 25AMP ATM MINI CIRCUIT BREAKER II	CB212-30 30AMP ATM MINI CIRCUIT BREAKER II	CB233-05 5AMP ATM MINI RESET CB TYPE III	CB233-10 10AMP ATM MINI RESET CB TYPE III	CB233-15 15AMP ATM MINI RESET CB TYPE III
CB233-20 20AMP ATM MINI RESET CB TYPE III	CB233-25 25AMP ATM MINI RESET CB TYPE III	CB233-30 30AMP ATM MINI RESET CB TYPE III	CB221-10 10AMP ATC CIRCUIT BREAKER TYPE I	CB221-15 15AMP ATC CIRCUIT BREAKER TYPE I	CB221-20 20AMP ATC CIRCUIT BREAKER TYPE I	CB221-25 25AMP ATC CIRCUIT BREAKER TYPE I	CB221-30 30AMP ATC CIRCUIT BREAKER TYPE I
CB223-10 10AMP ATC 24V RESET CB TYPE III	CB223-15 15AMP ATC 24V RESET CB TYPE III	CB223-20 20AMP ATC 24V RESET CB TYPE III	CB223-25 25AMP ATC 24V RESET CB TYPE III	CB223-30 30AMP ATC 24V RESET CB TYPE III	CB227-10 10AMP ATC RESET CB TYPE III RED	CB227-15 15AMP ATC RESET CB TYPE III BLUE	CB227-20 20AMP ATC RESET CB TYPE III YELLOW
CB227-25 25AMP ATC RESET CB TYPE III WHITE	CB227-30 30AMP ATC RESET CB TYPE III GREEN	UCB-10 10AMP ATM CB SNAP OFF BLADES	UCB-15 15AMP ATM CB SNAP OFF BLADES	UCB-20 20AMP ATM CB SNAP OFF BLADES	UCB-25 25AMP ATM CB SNAP OFF BLADES	UCB-30 30AMP ATM CB SNAP OFF BLADES	

PRODUCT CATEGORY: Q

Automotive Circuit Breakers ATM & ATC

31 Items • 46 Pcs
IBS No. 824R



Packaged in a Locking Steel Drawer for Easy Storage & Organization

Eco-Max Battery Ends & Shrink Tubing			
Assortment No. 835R			
BAL1038 1/0 X 3/8ST HVY DUTY TUBULAR	BAL2038 2/0 X 3/8ST HVY DUTY TUBULAR	B3405 2-4/0GA X 6' RED HVY WALL	B3505 2-4/0GA X 6' BLACK HVY
E2110 ECOMAX BATT TERM 1/0 GA POS	E2112 ECOMAX BATT TERM 2/0 GA POS		
E2109 ECOMAX BATT TERM 1/0 GA NEG	E2111 ECOMAX BATT TERM 2/0 GA NEG		

PRODUCT CATEGORY: Q

EcoMax Battery Ends & Shrink Tubing

8 Items • 34 Pcs
IBS No. 835R



Packaged in a Locking Steel Drawer for Easy Storage & Organization

Multilink Wire Ends w/ Thermal Indicator Butt Connectors					
Assortment No. 859R					
BTS518 20-18 MULTILINK BUTT CONNECTOR WITH THERMAL INDICATOR	B5530 20-18 TO 16-14 MULTILINK STEP	BTS514 16-14 MULTILINK BUTT CONNECTOR WITH THERMAL INDICATOR	B5540 16-14 TO 12-10 MULTILINK STEP	BTS510 12-10 MULTILINK BUTT CONNECTOR WITH THERMAL INDICATOR	B5550 12-10 TO 8GA MULTILINK STEP
125702 20-18 MULTILINK #8 RING TERM	125713 20-18 MULTILINK #10 SPADE TERM	125705 16-14 MULTILINK #8 RING TERM	125714 16-14 MULTILINK #10 SPADE TERM	125709 12-10 MULTILINK #10 RING TERM	125715 12-10 MULTILINK #10 SPADE TERM
125703 20-18 MULTILINK #10 RING TERM	125716 20-18 MULTILINK .250 MALE	125706 16-14 MULTILINK #10 RING TERM	125718 16-14 MULTILINK .250 MALE	125710 12-10 MULTILINK 1/4 RING TERM	125720 12-10 MULTILINK .250 MALE
125704 20-18 MULTILINK 1/4 RING TERM	125717 20-18 MULTILINK .250 FEMALE	125707 16-14 MULTILINK 1/4 RING TERM	125719 16-14 MULTILINK .250 FEMALE	125711 12-10 MULTILINK 3/8 RING TERM	125721 12-10 MULTILINK .250 FEMALE

PRODUCT CATEGORY: Q

Multilink Wire Ends w/ Thermal Indicator Butt Connectors

24 Items • 175 Pcs
IBS No. 859R



Packaged in a Locking Steel Drawer for Easy Storage & Organization



IBS, INCORPORATED

Assortments - Hose Clamps (R)



Two-Ear
Hose Clamps

Two-Ear Hose Clamps
16 Items • 51 Pcs
IBS No. 756R



Packaged in a Locking Steel Drawer
for Easy Storage & Organization

Assortment No. 756R					
60041 5/32 TWO-EAR CLAMP .122-.161 	60305 3/16 TWO-EAR CLAMP .134-.197 	60507 1/4 TWO-EAR CLAMP .197-.276 	60709 5/16 TWO-EAR CLAMP .276-.354 	60811 3/8 TWO-EAR CLAMP .319-.433 	61098 EAR CLAMP STANDARD JAW PINCERS CRIMPER
61113 1/2 TWO-EAR CLAMP .425-.512 	61315 9/16 TWO-EAR CLAMP .492-.591 	61518 5/8 TWO-EAR CLAMP .591-.709 	61720 3/4 TWO-EAR CLAMP .638-.787 	62023 7/8 TWO-EAR CLAMP .748-.906 	
62327 1" TWO-EAR CLAMP.886- 1.063 	62831 1-1/8 TWO-EAR CLAMP 	63134 1-5/16 TWO-EAR CLAMP 	63437 1-7/16 TWO-EAR CLAMP 	63740 1-1/2 TWO-EAR CLAMP 	

PRODUCT CATEGORY: R

A
S
S
O
R
T
M
E
N
T
S

IBS, INCORPORATED

Assortments - Adhesives (SA)



IBS, Inc. SPECIALTY PRODUCTS FOR MAINTENANCE & REPAIR INDUSTRIALBOLT.COM © © © 800-670-1906		2-Part EZ-Poxy Sticks	
		Assortment No. 640P	
74509 EZ-POXY CONCRETE STICK			
74508 EZ-POXY ALUMINUM STICK			
74507 EZ-POXY PLASTIC STICK			
74506 EZ-POXY WOOD STICK			
74505 EZ-POXY AQUA STICK			
74502 EZ-POXY STEEL STICK			

PRODUCT CATEGORY: SA

2-Part Easy Epoxy Sticks

6 Items • 6 Pcs
IBS No. 640P



Packaged in a Locking Steel Drawer for Easy Storage & Organization

IBS, Inc. SPECIALTY PRODUCTS FOR MAINTENANCE & REPAIR INDUSTRIALBOLT.COM © © © 800-670-1906		Loctite Thread Lockers	
		Assortment No. 671R	
57087 LOCTITE 19GM BLUE		51604 LOCTITE TIGHT ANAEROBIC GEL	
37686 LOCTITE 19GM RED THREADLOCKER		21348 LOCTITE PRIMER-N AEROSOL 4.5OZ	
24231 LOCTITE REMOVABLE		29031 LOCTITE 50ML GREEN MEDIUM	
26231 LOCTITE HIGH STRENGTH		27240 LOCTITE 50ML HT TEMP HI	

PRODUCT CATEGORY: SA

Loctite Thread Lockers

8 Items • 8 Pcs
IBS No. 671R



Packaged in a Locking Steel Drawer for Easy Storage & Organization

IBS, Inc. SPECIALTY PRODUCTS FOR MAINTENANCE & REPAIR INDUSTRIALBOLT.COM © © © 800-670-1906		Loctite Glues & Epoxies	
		Assortment No. 674R	
39202 LOCTITE QUICKTITE INSTANT		74510 MULTI-PURPOSE ADHESIVE 3.7 OZ E6000	
20251 LOCTITE 330 DEPEND ADHESIVE		97434 FIXMASTER 2 PART 4 MINUTE	
		EQ115 STATIC MIXER	
		EQ016 DISPENSING GUN	
		21425 LOCTITE .12 OZ FAST CURE	
		96604 LOCTITE FIXMASTER FAST SET	

PRODUCT CATEGORY: SA

Loctite Glues & Epoxies

8 Items • 12 Pcs
IBS No. 674R



Packaged in a Locking Steel Drawer for Easy Storage & Organization

ASSORTMENTS



IBS, INCORPORATED

Assortments - Adhesives (SA)

ASSORTMENTS

IBS, Inc. SPECIALTY PRODUCTS FOR MAINTENANCE & REPAIR INDUSTRIALBOLT.COM • 800-678-1506		Loctite 10ml Threadlockers	
Assortment No. 676R			
37087 LOCTITE 19GM BLUE THREADLOCKER STICK	37686 LOCTITE 19GM RED THREADLOCKER STICK	51604 LOCTITE TIGHT ANAEROBIC GEL 50ML	21348 LOCTITE PRIMER-N AEROSOL 4.5OZ
24221 BLUE REMOVEABLE THREADLOCKER 10ml	26221 262 RED HIGH STRENGTH THREADLOCKER 10ml	29021 290 GREEN MEDIUM THREADLOCKER 10ml	32526 2760 RED HIGH THREADLOCKER 10ml

PRODUCT CATEGORY: SA

**Loctite 10ml
Threadlockers**
8 Items • 8Pcs
IBS No. 676R



Packaged in a Locking Steel Drawer
for Easy Storage & Organization

IBS, Inc. SPECIALTY PRODUCTS FOR MAINTENANCE & REPAIR INDUSTRIALBOLT.COM • 800-678-1506		Loctite RTV Tube Assortment			
Assortment 776R					
59530 LOCTITE SUPERFLEX 80ML TUBE RTV CLEAR	59430 LOCTITE SUPERFLEX 80ML TUBE RTV WHITE	59330 LOCTITE SUPERFLEX 80ML TUBE RTV BLACK	30560 LOCTITE SUPERFLEX 80ML TUBE RTV BLUE	59630 LOCTITE HI TEMP 80ML TUBE RTV RED	18718 LOCTITE GASKET MAKER 70ML TUBE RTV GRAY

PRODUCT CATEGORY: SA

**Loctite RTV Tube
Assortment**
6 Items • 12 Pcs
IBS No. 776R



Packaged in a Locking Steel Drawer
for Easy Storage & Organization

IBS, Inc. SPECIALTY PRODUCTS FOR MAINTENANCE & REPAIR INDUSTRIALBOLT.COM • 800-678-1506		Thread Locker, Anti-Seize & Dielectric Grease			
Assortment 833R					
74242 MEDIUM STRENGTH THREADLOCKER GEL BLUE 35ML	74262 HIGH STRENGTH THREADLOCKER GEL RED 35ML	74151 ANTI SEIZE GEL ALUMINUM 35ML	74152 ANTI SEIZE GEL COPPER 35ML	74159 PTFE PIPE SEALANT GEL 35ML	74160 DIELECTRIC GREASE PUMP 35ML

PRODUCT CATEGORY: SA

**Thread Locker, Anti-
Seize & Dielectric
Grease**
6 Items • 12 Pcs
IBS No. 833R















Packaged in a Locking Steel Drawer
for Easy Storage & Organization



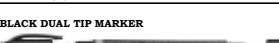







IBS, INCORPORATED

Assortments - Coatings (SCO)



 Industrial Markers	
Assortment No. 695R	
96520 DURA INK 5 BLACK EXTENDED MICRO TIP 	96823 VALVE ACTION PAINT PEN-BLACK 
96023 DURA INK 15 BLACK FINE TIP 	96822 VALVE ACTION PAINT PEN- RED 
96022 DURA INK 15 RED FINE TIP 	96821 VALVE ACTION PAINT PEN-YELLOW 
96025 DURA INK 15 BLUE FINE TIP 	96820 VALVE ACTION PAINT PEN-WHITE 
96026 DURA INK 15 GREEN FINE TIP 96283 DURA INK BLACK DUAL TIP MARKER  	96575 DURA INK 20 BLACK RETRACTABLE BULLET TIP 
96282 DURA INK RED DUAL TIP MARKER 	96576 DURA INK 20 RED RETRACTABLE BULLET TIP 

PRODUCT CATEGORY: SCO

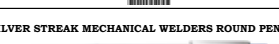
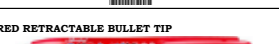
 Industrial Markers & Welder's Pencils	
Assortment No. 807R	
96023 DURA INK 15 BLACK FINE BULLET TIP 	96823 VALVE ACTION PAINT PEN-BLACK 
96022 DURA INK 15 RED FINE TIP 	96822 VALVE ACTION PAINT PEN- RED 
96025 DURA INK 15 BLUE FINE TIP 	96821 VALVE ACTION PAINT PEN-YELLOW 
96026 DURA INK 15 GREEN FINE TIP 	96820 VALVE ACTION PAINT PEN-WHITE 
96101 MARKAL SILVER STREAK PENCIL WELDERS 	96575 DURA INK 20 BLACK RETRACTABLE BULLET TIP 
96006 MARKAL SILVER STREAK MECHANICAL WELDERS ROUND PENCIL 	96576 DURA INK 20 RED RETRACTABLE BULLET TIP 

PRODUCT CATEGORY: SCO

Industrial Markers

13 Items • 27 Pcs
IBS No. 695R



Packaged in a Locking Steel Drawer for Easy Storage & Organization

Industrial Markers & Welder's Pencils

12 Items • 23 Pcs
IBS No. 807R



Packaged in a Locking Steel Drawer for Easy Storage & Organization

ASSORTMENTS



IBS, INCORPORATED

Assortments - Welding (SW)



Vinculum Welding Electrode Assortment Steel & Cast Iron

Assortment No. 754R

<p>46015 1/8 GROOVY VINCULUM Premium High Speed Gouging And Chamfering Electrode</p>	<p>VINCULUM™ GROOVY is designed to remove metal fast and efficiently without special skills or special equipment, expensive gases or compressed gas. Color: Gray</p>	<p>Technical Data: Current:..... AC or DC Straight Polarity (Electrode-)</p>
<p>46031 1/8 MRO CAST VINCULUM Specially Designed for Dirty Cast Iron - The Problem Solver to Use When All Others Fail</p>	<p>Vinculum™ MRO CAST has a unique flux coating on alloyed cored wire which produces dense, strong crack-resistant welds on all types of cast iron. Especially good for contaminated, oil, oil-soaked, dirty base metal. Also recommended for joining cast iron to steel. Use on grey, ductile, malleable, and nodular cast iron. Deposits are machinable. Color: Dark Gray/Black</p>	<p>Technical Data: Tensile Strength..... up to 75,000 psi (517N/mm²) Hardness..... Brinell 210 Current..... AC or DC Reverse Polarity (Electrode+)</p>
<p>46012 1/8 HI ALLOY VINCULUM A Superior Super Strength Electrode For Welding Alloy and Dissimilar Steels</p>	<p>VINCULUM™ HI Alloy is designed to weld low, medium and high alloy steels where super strength and high quality welds are desirable. Color: Blue</p>	<p>Technical Data: Tensile Strength - welded..... up to 120,000 psi work hardened..... up to 180,000 psi Yield strength..... up to 90,000 psi Elongation %..... approx. 28% Hardness (HR)..... approx. 300 Current..... AC or DC Reverse Polarity (Electrode+)</p>
<p>46042 1/8 VINCULUM DIVERSE-ALLOY A Premium High Strength Electrode For Welding High Strength Low Alloy Steels and Abrasion</p>	<p>DIVERSE ALLOY is excellent for welding most high-strength low alloy steels. It is recommended for the repair of heavy equipment and joints subjected to high stresses because of its high strength. The moisture resistant coating assures dense, crack-free deposits for outstanding impact resistance at all temperatures, and for dry quality welds. Color: White</p>	<p>Technical Data: Tensile Strength..... up to 93,000 psi (70 kg/mm²) Elongation %..... approx. 32 Current..... AC or DC Reverse Polarity (Electrode+)</p>
<p>46004 1/8 MID ALLOY VINCULUM Premium General Purpose Alloy For Low Carbon Steels</p>	<p>Vinculum™ MID Alloy is designed to operate on all welding machines, even small AC type transformers when the open circuit voltage is very low. The specially formulated coating protects the deposit from adverse conditions normally encountered in maintenance welding. An ideal electrode for field repair work and out of position welding. Color: Gold</p>	<p>Technical Data: Tensile Strength..... up to 80,000 psi Yield Strength..... up to 68,000 psi Elongation %..... approx. 24% Current..... AC or DC either polarity</p>

Vinculum Welding Electrodes Steel & Cast Iron

5 Items • 9 lbs
IBS No. 754R



Packaged in a Locking Steel Drawer
for Easy Storage & Organization

PRODUCT CATEGORY: SW

A
S
S
O
R
T
M
E
N
T
S

IBS, INCORPORATED

Assortments - Hardware / Springs (U)



IBS, Inc. SPECIALTY PRODUCTS FOR MAINTENANCE & REPAIR INDUSTRIALBOLT.COM 800-878-1986		Universal Extension Springs		Assortment No. 115R	
47030 1/2 OD X 9-5/8 EXTENSION SPRING		47045 1-1/16 OD X 5-1/2" EXTENSION SPRING			
47031 5/8 OD X 8-1/2 EXTENSION SPRING		47044 19/32 OD X 5" EXTENSION SPRING			
47032 13/16 OD X 8-1/2 EXTENSION SPRING		47043 7/16 OD X 7" EXTENSION SPRING			
47033 1" OD X 8-1/2 EXTENSION SPRING		47042 21/64 OD X 5-7/8 EXTENSION SPRING			
47038 1/4 OD X 4" EXTENSION SPRING		47039 3/8 OD X 3" EXTENSION SPRING		47040 7/16 OD X 4-1/2 EXTENSION SPRING	
47034 1/2 OD X 1-5/8 EXTENSION SPRING		47035 19/64 OD X 13/16 EXTENSION SPRING		47036 11/32 OD X 1-13/32 EXTENSION SPRING	
47037 18/64 OD X 1-1/32 EXTENSION SPRING		47046 23/32 OD X 3-3/16 EXTENSION SPRING		47047 47/64 OD X 3-7/8 EXTENSION SPRING	

PRODUCT CATEGORY: U

Universal Extension Springs

18 Items • 70 Pcs
IBS No. 115R



Packaged in a Locking Steel Drawer for Easy Storage & Organization

IBS, Inc. SPECIALTY PRODUCTS FOR MAINTENANCE & REPAIR INDUSTRIALBOLT.COM 800-878-1986		Universal Compression Springs		Assortment No. 116R	
47000 5/16 OD X 10 COMPRESSION*		47004 1/2 OD X 1 COMPRESSION		47005 5/16 OD X 1-19/32	
47001 3/8 OD X 12 COMPRESSION*		47006 3/16 OD X 1 COMPRESSION*		47007 3/8 OD X 3/4 COMPRESSION	
47002 5/8 OD X 12 COMPRESSION*		47008 1-1/64 OD X 3-1/8 COMPRESSION			
47003 7/8 OD X 12 COMPRESSION*		47009 11/16 OD X 4 COMPRESSION*			
47010 19/32 OD X 2-1/2 COMPRESSION		47011 5/8 OD X 2-3/4 COMPRESSION		47012 1/2 OD X 2-1/2 COMPRESSION	
47014 15/16 OD X 2-1/4 COMPRESSION		47015 7/8 OD X 2-1/32 COMPRESSION		47016 7/8 OD X 3 COMPRESSION SPRING*	
		47017 1-1/16 OD X 3-5/8 COMPRESSION			

PRODUCT CATEGORY: U

Universal Compression Springs

18 Items • 54 Pcs
IBS No. 116R



Packaged in a Locking Steel Drawer for Easy Storage & Organization

IBS, Inc. SPECIALTY PRODUCTS FOR MAINTENANCE & REPAIR INDUSTRIALBOLT.COM 800-878-1986		Roller Chain Links		Offset Chain Links		Assortment No. 208P	
20135 #35 .375 PITCH CONN. LINK		20140 #40 .500 PITCH CONN. LINK		20141 #41 .500 PITCH CONN. LINK		20150 #50 .625 PITCH CONN. LINK	
20160 #60 .750 PITCH CONN. LINK		20300 #1 CHAIN BREAKER					
20180 #80 1.00 PITCH CONN. LINK							
20235 #35 .375 PITCH OFFSET (HALF)		20240 #40 .500 PITCH OFFSET (HALF)		20241 #41 .500 PITCH OFFSET (HALF)		20250 #50 .625 PITCH OFFSET (HALF)	
20260 #60 .750 PITCH OFFSET (HALF)							
20280 #80 1.00 PITCH OFFSET (HALF)							

PRODUCT CATEGORY: U

Roller Chain Links Offset Chain Links

13 Items • 67 Pcs
IBS No. 208P



Packaged in a Locking Steel Drawer for Easy Storage & Organization

ASSORTMENTS



IBS, INCORPORATED











Assortments - Hardware / Springs (U)



IBS, Inc.
SPECIALTY PRODUCTS FOR MAINTENANCE & REPAIR
INDUSTRIALBOLTY.COM • • • • 800-670-1906

Quick Links & Spring Links

Assortment No. 748R

<p>22040 1/8 QUICK LINK ZP</p> 	<p>22041 3/16 QUICK LINK ZP</p> 	<p>22042 1/4 QUICK LINK ZP</p> 
<p>22043 5/16 QUICK LINK ZP</p> 	<p>22044 3/8 QUICK LINK ZP</p> 	<p>22045 1/2 QUICK LINK ZP</p> 
<p>22047 3/16 SPRING LINK ZP</p> 	<p>22048 1/4 SPRING LINK ZP</p> 	<p>22049 5/16 SPRING LINK ZP</p> 
<p>22050 3/8 SPRING LINK ZP</p> 	<p>22051 1/2 SPRING LINK ZP</p> 	

PRODUCT CATEGORY: U

**Quick Links
& Spring Links**
11 Items • 72 Pcs
IBS No. 748R



**Packaged in a Locking Steel Drawer
for Easy Storage & Organization**

A
S
S
O
R
T
M
E
N
T
S

IBS, INCORPORATED

Assortments - Air Fittings (VA)



Automotive Couplers, Plugs & Flexeel Repair Kit

9 Items • 36 Pcs
IBS No. 717R



Packaged in a Locking Steel Drawer for Easy Storage & Organization

Automotive Couplers, Plugs & Hose Repair Kit

9 Items • 36 Pcs
IBS No. 719R



Packaged in a Locking Steel Drawer for Easy Storage & Organization

Pressure Washer Couplers, Plugs & Nozzles

12 Items • 32 Pcs
IBS No. 831R



Packaged in a Locking Steel Drawer for Easy Storage & Organization

ASSORTMENTS

IBS, Inc. <small>SPECIALTY PRODUCTS FOR MAINTENANCE & REPAIR INDUSTRIALBOLT.COM © © © 800-878-1906</small>				Automotive Couplers, Plugs and Flexeel Repair Kit			
				<small>Assortment No. 718R</small>			
C2 1/4 COUPLER 1/4 FPT AUTO 	130789 SPLICER FOR 3/8 POLYURETHANE 	130791 1/4NPT X 3/8 HOSE SWIV 	11420 HOSE & TUBING CUTTER UP TO 1-1/4 				
C1 1/4 COUPLER 1/4 MPT AUTO 							
CP2 1/4 PLUG 1/4 FPT AUTO 							
CP1 1/4 PLUG 1/4 MPT AUTO 							

PRODUCT CATEGORY: VA

IBS, Inc. <small>SPECIALTY PRODUCTS FOR MAINTENANCE & REPAIR INDUSTRIALBOLT.COM © © © 800-878-1906</small>				Automotive Couplers, Plugs and Hose Repair Kit			
				<small>Assortment No. 719R</small>			
C2 1/4 COUPLER 1/4 FPT AUTO 	VG-6 VINYL GUARD FOR 3/8 AIR HOSE 	AM7328 21/32 I.D. FERRULE BRASS 	11420 HOSE & TUBING CUTTER UP TO 1-1/4 				
C1 1/4 COUPLER 1/4 MPT AUTO 		10406B-106 3/8 LONG BARB UNION 					
CP2 1/4 PLUG 1/4 FPT AUTO 	10506B-104 3/8 X 1/4 M. LONG BARB H. END 						
CP1 1/4 PLUG 1/4 MPT AUTO 							

PRODUCT CATEGORY: VA

IBS, Inc. <small>SPECIALTY PRODUCTS FOR MAINTENANCE & REPAIR INDUSTRIALBOLT.COM © © © 800-878-1906</small>				Pressure Washer Couplers, Plugs and Nozzles			
				<small>Assortment No. 831R</small>			
CST3B 1/4 MPT STRAIGHT THRU COUPLER BRASS FOR PRESSURE WASHER 	CST5B 3/8 MPT STRAIGHT THRU COUPLER BRASS FOR PRESSURE WASHER 	130560 PRESSURE WASHER NOZZLE 0 DEGREE RED 					
CST4B 1/4 FPT STRAIGHT THRU COUPLER BRASS FOR PRESSURE WASHER 	CST6B 3/8 FPT STRAIGHT THRU COUPLER BRASS FOR PRESSURE WASHER 	130561 PRESSURE WASHER NOZZLE 15 DEGREE YELLOW 					
CPST3 1/4 MPT STRAIGHT THRU COUPLER PLUG STEEL FOR PRESSURE WASHER 	CPST5 3/8 MPT STRAIGHT THRU COUPLER PLUG STEEL FOR PRESSURE WASHER 	130562 PRESSURE WASHER NOZZLE 25 DEGREE GREEN 					
CPST4 1/4 FPT STRAIGHT THRU COUPLER PLUG STEEL FOR PRESSURE WASHER 	CPST6 3/8 FPT STRAIGHT THRU COUPLER PLUG STEEL FOR PRESSURE WASHER 	130563 PRESSURE WASHER NOZZLE 40 DEGREE WHITE 					

PRODUCT CATEGORY: VA



IBS, INCORPORATED

Assortments - Grease Fittings (VG)

ASSORTMENTS

IBS, Inc. SPECIALTY PRODUCTS FOR MAINTENANCE & REPAIR INDUSTRIALBOLT.COM © © © 800-670-1906						Grease Fittings
						Assortment No. 124R
1641-B 1/4-28 TAPER TRD STRT ZERK	1652-B 1/4-28 TAPER TRD 11/16 ZERK	1680-B 1/4-28 TAPER TRD 31/32 STRT	1637-B 1/4-28 TAPER TRD 45 DGR ZERK	1911-B 1/4-28 TAPER TRD. 90 DGR ZERK	1610-B 1/8 NPT STRT ZERK	
1644-B 1/8 NPT SHORT STRT. ZERK	1607-B 1/8 NPT 1-1/4L STRT ZERK	1611-B 1/8 NPT 30DGR STRT ZERK	1688-B 1/8 NPT 45 DGR ZERK	1613-B 1/8 NPT 90DGR ZERK	1629-B 1/4 NPT 67-1/2 DGR ZERK	
1743-B 1/4 DRIVE ZERK BALL CHECK	1608-B 5/16 DRIVE ZERK BALL CHECK	1728-B 3/16 DRIVE ZERK BALL CHECK	1666-NB 3/8 DRIVER ZERK - NO BALL CHECK	1646-B 3/16 45DGR DRIVE ZERK		
1711-B 5/16-24 ZERK (LEAF SPRINGS)	1720-B 1/8 NPT STRT THREAD CUTTING	3038-B 1/4-28 NPT STRT THREAD CUTTING	5251 RUBBER ZERK CAP			

PRODUCT CATEGORY: VG

IBS, Inc. SPECIALTY PRODUCTS FOR MAINTENANCE & REPAIR INDUSTRIALBOLT.COM © © © 800-670-1906						Grease Fittings
						Assortment No. 225R
1641-B 1/4-28 TAPER TRD STRT ZERK	1652-B 1/4-28 TAPER TRD 11/16 ZERK	1637-B 1/4-28 TAPER TRD 45 DGR ZERK	1911-B 1/4-28 TAPER TRD. 90 DGR ZERK		317850-1F 18" LUB. HOSE	
1610-B 1/8 NPT STRT ZERK	1688-B 1/8 NPT 45 DGR ZERK	1613-B 1/8 NPT 90DGR ZERK				
1608-B 5/16 DRIVE ZERK BALL CHECK	1728-B 3/16 DRIVE ZERK BALL CHECK					
5251 RUBBER ZERK CAP			308730 1/8 NPT GREASE FITTING COUPLER			

PRODUCT CATEGORY: VG

IBS, Inc. SPECIALTY PRODUCTS FOR MAINTENANCE & REPAIR INDUSTRIALBOLT.COM © © © 800-670-1906						Metric Grease Fittings
						Assortment No. 232R
Z-1600 6MM X 1.0 STRT METRIC ZERK	Z-1621 6MM X 1.0 45DGR METRIC ZERK	Z-1690 6MM X 1.0 90DGR METRIC ZERK				
Z-2103 8MM X 1.0 STRT METRIC ZERK	Z-2104 8MM X 1.0 45DGR METRIC ZERK	Z-2105 8MM X 1.0 90DGR METRIC ZERK				
Z-2109 10MM X 1.0 STRT. METRIC ZERK	Z-2110 10MM X 1.0 45DGR METRIC ZERK	Z-2111 10MM X 1.0 90DGR METRIC ZERK				
5251 RUBBER ZERK CAP						

PRODUCT CATEGORY: VG

Grease Fittings

21 Items • 180 Pcs
IBS No. 124R



Packaged in a Locking Steel Drawer for Easy Storage & Organization

Grease Fittings

12 Items • 178 Pcs
IBS No. 225R



Packaged in a Locking Steel Drawer for Easy Storage & Organization

Metric Grease Fittings

10 Items • 150 Pcs
IBS No. 232R

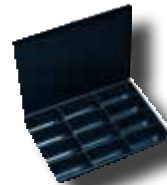























Packaged in a Locking Steel Drawer for Easy Storage & Organization

IBS, INCORPORATED

Assortments - Grease Fittings (VG)



 IBS, Inc. <small>SPECIALTY PRODUCTS FOR MAINTENANCE & REPAIR</small> <small>INDUSTRIALMOLLY.COM • P.O. BOX 878-1906</small>		Grease Fittings Inch & Metric				Assortment No. 849R
1911-B 1/4-28 TAPER TRD 90 DGR ZERK 	1613-B 1/8 NPT 90 DGR ZERK 	1608-B 5/16 DRIVE ZERK BALL CHECK 	Z-1690 M6 X 1.0 90DGR METRIC ZERK 	Z-2105 8MM X 1.0 90DGR METRIC ZERK 	Z-2111 10MM X 1.0 90DGR METRIC ZERK 	
1637-B 1/4-28 TAPER TRD 45 DGR ZERK 	1688-B 1/8 NPT 45 DGR ZERK 	1743-B 1/4 DRIVE ZERK BALL CHECK 	Z-1621 M6 X 1.0 45DGR METRIC ZERK 	Z-2104 8M X 1.0 45DGR METRIC ZERK 	Z-2110 10MM X 1.0 45DGR METRIC ZERK 	
1652-B 1/4-28 TAPER TRD 11/16 ZERK 	1607-B 1/8 NPT 1-1/4L STRT ZERK 	1728-B 3/16 DRIVE ZERK BALL CHECK 	Z-1600 M6 X 1.0 STRT METRIC ZERK 	Z-2103 8M X 1.0 STRT METRIC ZERK 	Z-2109 10MM X 1.0 STRT. METRIC ZERK 	
1641-B 1/4-28 TAPER TRD STRT ZERK 	1610-B 1/8 NPT STRT ZERK 			5852 LINCOLN GREASE COUPLER 	5251 RUBBER ZERK CAP 	

PRODUCT CATEGORY: VG

Inch & Metric Grease Fittings

22 Items • 166 Pcs
IBS No. 849R



Packaged in a Locking Steel Drawer
 for Easy Storage & Organization

ASSORTMENTS

IBS, INCORPORATED

Assortments - Rivets & Inserts (W)



Thread Repair Kit 1/4-1/2 NC USS Heavy Wall Assortment No. 212R					
					65999 INSERT TOOL FOR THD INSERTS
65902 1/4-20 HVY WALL THD INSERT 	65903 5/16-18 HVY WALL THD INSERT 	65904 3/8-16 HVY WALL THD INSERT 	65905 7/16-14 HVY WALL THD INSERT 	65906 1/2-13 HVY WALL THD INSERT 	
Use With P/N 16158 X Drill P/N 17641 7/16-14 Tap	Use With P/N 17425 29/64 Drill P/N 17643 1/2-13 Tap	Use With P/N 16833 33/64 Drill P/N 17645 9/16-12 Tap	Use With P/N 16845 37/64 Drill P/N 17647 5/8-11 Tap	Use With: P/N 16845 45/64 Drill P/N 17650 3/4-16 Tap	

PRODUCT CATEGORY: W

Thread Repair Kit 1/4-1/2 NF SAE Heavy Wall Assortment No. 213R					
					65999 INSERT TOOL FOR THD INSERTS
66102 1/4-28 HVY WALL THD INSERT 	66103 5/16-24 HVY WALL THD INSERT 	66104 3/8-24 HVY WALL THD INSERT 	66105 7/16-20 HVY WALL THD INSERT 	66106 1/2-20 HVY WALL THD INSERT 	66108 5/8-18 HVY WALL THD INSERT
Use With P/N 16158 X Drill P/N 17641 7/16-14 Tap	Use With P/N 17425 29/64 Drill P/N 17643 1/2-13 Tap	Use With P/N 16833 33/64 Drill P/N 17645 9/16-12 Tap	Use With P/N 16837 37/64 Drill P/N 17647 5/8-11 Tap	Use With P/N 16845 45/64 Drill P/N 17650 3/4-16 Tap	Use With P/N 16853 53/64 Drill P/N 17652 7/8-14 Tap

PRODUCT CATEGORY: W

Thread Repair Kit 1/4-1/2 NC USS Thin Wall Assortment No. 214R					
					65999 INSERT TOOL FOR THD INSERTS
65922 1/4-20 THIN WALL THD INSERTS 	65923 5/16-18 THIN WALL THD INSERTS 	65924 3/8-16 THIN WALL THD INSERTS 	65925 7/16-14 THIN WALL THD INSERTS 	65926 1/2-13 THIN WALL THD INSERTS 	
Use With P/N 16151 Q Drill P/N 17639 3/8-16 Tap	Use With P/N 16158 X Drill P/N 17641 7/16-14 Tap	Use With P/N 17425 29/64 Drill P/N 17643 1/2-13 Tap	Use With P/N 16833 33/64 Drill P/N 17645 9/16-12 Tap	Use With P/N 16837 37/64 Drill P/N 17647 5/8-11 Tap	

PRODUCT CATEGORY: W

Thread Repair Kit

1/4-12 NC USS Heavy Wall

6 Items • 81 Pcs
IBS No. 212R



Packaged in a Locking Steel Drawer
for Easy Storage & Organization

Thread Repair Kit

1/4-12 NF USS Heavy Wall

7 Items • 87 Pcs
IBS No. 213R



Packaged in a Locking Steel Drawer
for Easy Storage & Organization

Thread Repair Kit

1/4-1/2 NC USS Thin Wall

6 Items • 82 Pcs
IBS No. 214R



Packaged in a Locking Steel Drawer
for Easy Storage & Organization







ASSORTMENTS



IBS, INCORPORATED

Assortments - Rivets & Inserts (W)

ASSORTMENTS











IBS, Inc. SPECIALTY PRODUCTS FOR MAINTENANCE & REPAIR INDUSTRIALBOLT.COM © © © 800-678-1506					Thread Repair Kit 1/4-1/2 NF SAE Thin Wall
					Assortment No. 215R
66122 1/4-28 THIN WALL THD INSERT 	66123 5/16-24 THIN WALL THD INSERT 	66124 3/8-24 THIN WALL THD INSERT 	66125 7/16-20 THIN WALL THD INSERT 	66126 1/2-20 THIN WALL THD INSERT 	
Use With P/N 16151 "Q" Drill P/N 17639 3/8-16 Tap	Use With P/N 16158 "X" Drill P/N 17641 7/16-14 Tap	Use With P/N 17425 29/64 Drill P/N 17643 1/2-13 Tap	Use With P/N 16833 33/64 Drill P/N 17645 9/16-12 Tap	Use With P/N 16837 37/64 Drill P/N 17647 5/8-11 Tap	
					65999 INSERT TOOL FOR THD INSERTS 

PRODUCT CATEGORY: W

Thread Repair Kit
1/4-12 NF SAE Thin Wall
6 Items • 82 Pcs
IBS No. 215R



Packaged in a Locking Steel Drawer for Easy Storage & Organization













IBS, Inc. SPECIALTY PRODUCTS FOR MAINTENANCE & REPAIR INDUSTRIALBOLT.COM © © © 800-678-1506			Multi-Grip Rivets
			Assortment No. 368R
170406 1/8 LARGE FLG SHORT MULTIGRIP 	170408 1/8 LARGE FLG LONG MULTIGRIP 	170508 5/32 LARGE FLG MULTIGRIP 	
170608 3/16 LARGE FLG SHORT MULTIGRIP 	170612 3/16 LARGE FLG LONG MULTIGRIP 		
171406 1/8 DOME HD SHORT MULTIGRIP 	171408 1/8 DOME HD LONG MULTIGRIP 	171508 5/32 DOME HD MULTIGRIP 	
171608 3/16 DOME HD SHORT MULTIGRIP 	171612 3/16 DOME HD LONG MULTIGRIP 		

PRODUCT CATEGORY: W

Multi-Grip Rivets
10 Items • 1000 Pcs
IBS No. 368R



Packaged in a Locking Steel Drawer for Easy Storage & Organization

IBS, Inc. SPECIALTY PRODUCTS FOR MAINTENANCE & REPAIR INDUSTRIALBOLT.COM © © © 800-678-1506			Multi-Grip & Tri-Fold Rivets
			Assortment No. 369R
170406 1/8 LARGE FLG SHORT MULTIGRIP 	170408 1/8 LARGE FLG LONG MULTIGRIP 	170508 5/32 LARGE FLG MULTIGRIP 	
170608 3/16 LARGE FLG SHORT MULTIGRIP 	170612 3/16 LARGE FLG LONG MULTIGRIP 	171406 1/8 DOME HD SHORT MULTIGRIP 	
171408 1/8 DOME HD LONG MULTIGRIP 	171608 3/16 DOME HD SHORT MULTIGRIP 	171612 3/16 DOME HD LONG MULTIGRIP 	
17256 5/32 TRI-FOLD RIVET .040-.375 	17264 3/16 TRI-FOLD RIVET .062-.250 	17266 3/16 TRI-FOLD RIVET .187-.375 	

PRODUCT CATEGORY: W

Multi-Grip & Tri-Fold Rivets
12 Items • 800 Pcs
IBS No. 369R



Packaged in a Locking Steel Drawer for Easy Storage & Organization

IBS, INCORPORATED

Assortments - Rivets & Inserts (W)



IBS, Inc.
SPECIALTY PRODUCTS FOR MAINTENANCE & REPAIR
INDUSTRIALBOLT.COM • P.O. 800-878-1906

Knurled Nutserts with Tool

Assortment No. 431P

49514 3/8-16 MANDREL & NOSEPIECE	49503 10-32 KNURLED GRIP SERT	49506 3/8-16 KNURLED GRIP SERT	49500 RIVET NUT GUN
49513 5/16-18 MANDREL & NOSEPIECE		NOTE: This size should be installed with Heavy Duty Nutsert Tool P/N 49550	
49512 1/4-20 MANDREL & NOSEPIECE	49502 10-24 KNURLED GRIP SERT	49505 5/16-18 KNURLED GRIP SERT	
49511 10-32 MANDREL & NOSEPIECE		NOTE: This size should be installed with Heavy Duty Nutsert Tool P/N 49550	
49510 10-24 MANDREL & NOSEPIECE	49501 8-32 KNURLED GRIP SERT	49504 1/4-20 KNURLED GRIP SERT	
49508 8-32 MANDREL & NOSEPIECE		NOTE: This size should be installed with Heavy Duty Nutsert Tool P/N 49550	

Knurled Nutserts with Tool

13 Items • 127 Pcs
IBS No. 431P



Packaged in a Locking Steel Drawer for Easy Storage & Organization

PRODUCT CATEGORY: W

IBS, Inc.
SPECIALTY PRODUCTS FOR MAINTENANCE & REPAIR
INDUSTRIALBOLT.COM • P.O. 800-878-1906

Aluminum Nutserts

Assortment No. 432P

49514 3/8-16 MANDREL & NOSEPIECE	17503 10-32 ALUM RIVET NUT Drill Hole Size 9/32"	17506 3/8-16 ALUM RIVET NUT Drill Hole Size 1/2"	49500 RIVET NUT GUN
49513 5/16-18 MANDREL & NOSEPIECE	17502 10-24 ALUM RIVET NUT Drill Hole Size 9/32"	17505 5/16-18 ALUM RIVET NUT Drill Hole Size 1/2"	
49512 1/4-20 MANDREL & NOSEPIECE	17501 8-32 ALUM RIVET NUT Drill Hole Size 1/4"	17504 1/4-20 ALUM RIVET NUT Drill Hole Size 3/8"	
49511 10-32 MANDREL & NOSEPIECE			
49510 10-24 MANDREL & NOSEPIECE	17500 6-32 ALUM RIVET NUT Drill Hole Size 1/4"		
49508 8-32 MANDREL & NOSEPIECE	49507 6-32 MANDREL & NOSEPIECE		

Aluminum Nutserts

15 Items • 153 Pcs
IBS No. 432P



Packaged in a Locking Steel Drawer for Easy Storage & Organization

PRODUCT CATEGORY: W

IBS, Inc.
SPECIALTY PRODUCTS FOR MAINTENANCE & REPAIR
INDUSTRIALBOLT.COM • P.O. 800-878-1906

Self-Tapping Threaded Inserts

Assortment No. 696R

65935 1/4-20 SELF-TAPPING THREAD INSERT (USE DRILL: V)	65936 5/16-18 SELF-TAPPING THREAD INSERT (USE DRILL: 29/64)	65937 3/8-16 SELF TAPPING THREAD INSERT (USE DRILL: 17/32)	65939 1/2-13 SELF TAPPING THREAD INSERT (USE DRILL: 11/16)
65945 #6-1.0 SELF-TAPPING THREAD INSERT (USE DRILL: V)	65946 #8-1.25 SELF-TAPPING THREAD INSERT (USE DRILL: 29/64)	65947 #10-1.5 SELF TAPPING THREAD INSERT (USE DRILL: 17/32)	65948 #12-1.75 SELF TAPPING THREAD INSERT (USE DRILL: 39/64)

Self-Tapping Threaded Inserts

8 Items • 60 Pcs
IBS No. 696R



Packaged in a Locking Steel Drawer for Easy Storage & Organization

PRODUCT CATEGORY: W

ASSORTMENTS



IBS, INCORPORATED

Assortments - Automotive (X)

ASSORTMENTS

IBS, Inc. <small>SPECIALTY PRODUCTS FOR MAINTENANCE & REPAIR INDUSTRIALBOLT.COM © & © 800-878-1906</small>						Universal Studs Black Oil Finish High Carbon - Heat Treated					
						<small>Assortment No. 119R</small>					
A-9668 1/4-28X1/2 X 1/4-20X1/2 OL 1-1/4 STUD 	A-9669 1/4-28X3/4 X 1/4-20X1/2 OL 1-1/2 STUD 	A-9670 1/4-28X1 X 1/4-20X1/2 OL 2" STUD 	A-9673 5/16-24X1/2 X 5/16-18X3/8 OL 1" STUD 	A-9675 5/16-24X5/8 X 5/16-18X3/4 OL 1-1/2 STUD 	A-9690 3/8-24X2 X 3/8-16X5/8 OL 3" STUD 						
A-9677 5/16-24X1 X 5/16-18X9/16 OL 2" STUD 	A-9683 3/8-24X3/4 X 3/8-16X1/2 OL 1-1/2 STUD 	A-9684 3/8-24X3/4 X 3/8-16X1/2 OL 1-3/4 STUD 	A-9686 3/8-24X1 X 3/8-16X5/8 OL 2" STUD 	A-9699 7/16-20X3/4 X 7/16-14X9/16 OL 1-3/4" STUD 							
A-9701 7/16-20X7/8 X 7/16-14X3/4 OL 2" STUD 	A-9712 7/16-20X1-3/8 X 7/16-14X3/4 OL 2-1/2 STUD 	A-9715 7/16-20X1-13/16 X 7/16-14X3/4 OL 3" STUD 	A-9727 1/2-20X3/4 X 1/2-13X3/4 OL 1-7/8 STUD 	A-9745 5/8-11X1-1/4 X 5/8-11X1 OL 3" STUD 							
A-9731 1/2-20X1 X 1/2-13X3/4 OL 2-1/2 STUD 	A-9732 1/2-20X2 X 1/2-13X3/4 OL 3" STUD 	A-9739 9/16-18X1-1/4 X 9/16-12X1 OL 	A-9744 5/8-11X1-1/2 X 5/8-11X13/16 								

PRODUCT CATEGORY: X

Universal Studs
BLACK OIL FINISH
High Carbon - Heat Treated
21 Items • 67 Pcs
IBS No. 119R



Packaged in a Locking Steel Drawer for Easy Storage & Organization

IBS, Inc. <small>SPECIALTY PRODUCTS FOR MAINTENANCE & REPAIR INDUSTRIALBOLT.COM © & © 800-878-1906</small>			Copper Washers		
			<small>Assortment No. 160R</small>		
D-725-001 1/4ID X 5/8OD COPPER WASHER 	D-725-002 5/16ID X 11/16OD COPPER WASHER 	D-725-003 3/8ID X 3/4OD COPPER WASHER 			
D-725-004 7/16ID X 13/16OD COPPER WASHER 	D-725-005 1/2ID X 7/8OD COPPER WASHER 				
D-725-011 1/4ID X 7/16OD COPPER WASHER 	D-725-012 5/16ID X 1/2OD COPPER WASHER 	D-725-013 3/8ID X 9/16OD COPPER WASHER 			
D-725-014 7/16ID X 5/8OD COPPER WASHER 	D-725-015 1/2ID X 11/16OD COPPER WASHER 				

PRODUCT CATEGORY: W

Copper Washers
10 Items • 250 Pcs
IBS No. 160R



Packaged in a Locking Steel Drawer for Easy Storage & Organization

IBS, Inc. <small>SPECIALTY PRODUCTS FOR MAINTENANCE & REPAIR INDUSTRIALBOLT.COM © & © 800-878-1906</small>								Nylon Connectors and Vacuum Caps							
								<small>Assortment No. 301P</small>							
A-12929 1/8 STRT VACUUM CONNECTOR 	A-12937 3/16 X 3/16 NYLON VACUUM CONN 	A-12931 1/4 X 1/4 NYLON VACUUM CONN 	A-12946 5/16 X 5/16 NYLON VACUUM CONN 	A-12934 3/8 X 3/8 NYLON VACUUM CONN 	A-12930 1/8X3/16 NYLON VACUUM CONN 	A-12936 1/8 X 1/4 NYLON VACUUM CONN 	A-12935 3/16 X 1/4 NYLON VACUUM CONN 								
A-12923 1/8 NYLON VACUUM CONN 	A-12918 3/16 NYLON VACUUM CONN 	A-17629 1/4 NYLON VACUUM TEE 	A-12920 5/16 NYLON VACUUM CONN 	A-12925 3/8 NYLON VACUUM CONN 		A-12927 3/16 X 1/4 VACUUM Y" CONNECTOR 									
A-12209 1/8 HI-TEMP RUBBER VACUUM 	A-19000 3/16 HI-TEMP RUBBER VACUUM 	A-19001 1/4 HI-TEMP RUBBER VACUUM 	A-19003 3/8 HI-TEMP RUBBER VACUUM 			A-11419 3/16 4-WAY VACUUM CONN 									
A-12916 1/8X3/16X1/8 NYLON VACUUM CONN 	A-12919 1/8X3/16X3/16 NYLON VACUUM CONN 	A-12926 3/16X3/16X1/8 NYLON VACUUM CONN 	A-12921 3/8X3/8X1/4 NYLON VACUUM TEE 			A-12949 3/16 SWAY VACUUM CONNECTOR 									

PRODUCT CATEGORY: X

Nylon Connectors & Vacuum Caps
24 Items • 310 Pcs
IBS No. 301P



Packaged in a Locking Steel Drawer for Easy Storage & Organization

IBS, INCORPORATED

Assortments - Automotive (X)



Automotive Drain Plugs				
Assortment No. 321R				
A-14196 1/2-20 OIL DRAIN PLUG	A-19130 1/2 DRAIN PLUG	A-17145 1/2-20 OVERSIZE DRAIN PLUG	A-18121 1/2 OIL DRAIN PLUG	A-8285 5/8-18 OVERSIZE DRAIN PLUG W/FIBRE
A-15527 M12-1.25 OIL DRAIN PLUG	A-14677 M12-1.75 OIL PAN PLUG	A-19024 14MM DRAIN PLUG W/GASKET	A-16308 14MM DRAIN PLUG	A-14678 M14 DRAIN PLUG
A-15528 16MM DRAIN PLUG	A-15529 18MM DRAIN PLUG			

PRODUCT CATEGORY: X

Automotive Drain Plugs

12 Items • 72 Pcs
IBS No. 321R



Packaged in a Locking Steel Drawer for Easy Storage & Organization

Oil Drain Plug Gaskets				
Assortment No. 322R				
A-18726 12MM ID 22MM OD BLACK DRAIN	A-18665 DRAIN PLUG RUBBER GASKET M12-1.75	A-16996 1/2 NYLON DRAIN PLUG GASKET	A-19538 1/2ID X 3/4OD BLACK FIBER	A-8277 1/2 NYLON GASKET
A-16026 1/2 STEEL & RUBBER DRAIN PLUG	A-15918 1/2 COPPER DRAIN WASHER	A-19545 1/2 COPPER DRAIN PLUG GASKET	A-16682 14MM DRAIN PLUG GASKET	A-16681 M14 NYLON DRAIN PLUG GASKET
A-18299 14MM X 25MM RUBBER/STEEL FORD	A-19007 14MMX20MM STEEL CRUSHABLE	A-16956 M14 ALUMINUM DRAIN PLUG GASKET	A-8278 5/8 NYLON OIL DRAIN PLUG	A-17263 M16 COPPER WASHER
A-16683 M16.5 NYLON DRAIN PLUG GASKET	A-18829 M18 GREEN OIL DRAIN PLUG	A-17264 M18 COPPER WASHER	A-16955 18MM ALUM OIL DRAIN PLUG	A-19139 20MM STEEL OIL DRAIN PLUG

PRODUCT CATEGORY: X

Oil Drain Plug Gaskets

20 Items • 260 Pcs
IBS No. 322R



Packaged in a Locking Steel Drawer for Easy Storage & Organization

X-mas Tree Retainers				
Assortment No. 343P				
A-10831 GM 32254 Ford 28028 Chr. 389192, 5031321, AMC 6034091 Black Nylon Fender & Bumper Shield Retainer Stem Dia: 5/16" Stem Length: 3/4" HD Dia: 11/16" GM Ford Chrysler 8-03C	A-17664 GM 10121802 Chr. 803082, 6033940, Ford 390019-S Black Nylon Shield Retainer Bentley's Pilot Guide Shield Engine Splash Shield Radiators Side Air Barbs GM 1989-Ch	A-12492 MB00083, 29421900 White Nylon Door Trim Panel Retainer Stem Dia: 5/16" HD Dia: 3/4" x 1/8" Stem Length: 3/4" GM 1983-Ch	A-13945 01553-S-0905 Nylon Door Trim Panel Retainer Stem Dia: 9/32" HD Dia: 3/4" x 1/8" Stem Length: 3/4" Trucks	A-11130 0307811, 3077733 Black Nylon Hood Insulation Retainer Stem Dia: 5/16" HD Dia: 2" Length: 3/4" GM 1964-Ch
A-11146 JGM 1603306, Chr. 6020441, Ford 3889775 Black Nylon Nylon Radiator Hose Fender & Bumper Shield Retainer Stem Dia: 5/16" HD Dia: 11/16" Stem Length: 13/16" GM Ford & Chrysler	A-12737 11203920 333744731 White Nylon Door Panel Retainer Covers & Plastics 1983-Ch GM Truck 1989-Ch	A-11796 120955781 White Nylon Door Trim Panel Retainer Stem Dia: 5/16" HD Dia: 3/4" Stem Length: 3/4" GM 1978-Ch	A-19356 159066673 White Nylon Front & Rear Door Trim Panel Retainer GM Trucks S10 & S15 1999-Ch	
A-12766 1691904, 22512276 Black Nylon Front End Shield Retainer Stem Dia: 7/16" HD Dia: 2" Stem Length: 13/16" GM 1991-Ch	A-19541 6504125 Black Nylon Hood Insulation Retainer Overlays Max 18mm Dustcaps & Duraings 1987-Ch	A-12565 1891903-01 Black Nylon Door Trim Panel Retainer Stem Dia: 5/16" HD Dia: 25/32" Stem Length: 13/16" Ford 1981-Ch	A-17612 Black Nylon Chrysler 5520463 Ford 8607721-S Trim Panel Retainer Ford Explorer 1993-On Trunk Lid Latch Chrysler 1986-Ch	A-12909 138930-S1 Black Nylon Trim Panel Retainer Stem Dia: 9/32" HD Dia: 1" Stem Length: 11/16" Ford 1980-Ch
A-20189 GM 16074025 Ford 8606113-S, Chr. 8020463 Black Nylon Trim Panel Retainer	A-16818 GM 21034149 Chrysler 0501301 Black Nylon Trim Panel Retainer GM Saturn 1991-On Sliding Door & L/R Gate Trim Panel Retainer Chrysler Mini Vans 1987-Ch	A-12137 179162211 Black Nylon Radiator Support Panel Retainer GM 1977-Ch		A-18391 Black Nylon Trim Panel Retainer Chrysler & GM Saturn 1993-On

PRODUCT CATEGORY: X

X-Mas Tree Retainers

18 Items • 330 Pcs
IBS No. 343P



Packaged in a Locking Steel Drawer for Easy Storage & Organization



IBS, INCORPORATED

Assortments - Automotive (X)

ASSORTMENTS

IBS, Inc.
SPECIALTY PRODUCTS FOR MAINTENANCE & REPAIR
INDUSTRIALBOLT.COM © & © 800-878-1906

Nylon Push/Screw Type Retainers

Assortment No. 344P

 A-18119 <small>(387943-S)</small> Black Nylon Front & Rear Bumper Push-Type Retainer Hd Dia: 20mm Stem Length: 25mm Fits into 10mm Hole Honda 1990-On	 A-13993 <small>(20510029)</small> Black Nylon Body Retainer Hd Dia: 11/16" Fits 1/4" Hole GM 1984-On	 A-14993 <small>(20510029)</small> Hole Dia: 250" Panel Range: 100-197" Flange Dia: 700" Stem Length: 900" GM: 22538004	 A-17143 <small>(91502-SM4-0000)</small> Black Nylon Push-Type Retainer Hd Dia: 20 mm Stem Length: 27mm Fits 10mm Hole Bumper Fascia Accord 1990-On	 A-14698 <small>(90688-SB0-003)</small> Black Nylon Push-Type Retainer Hd Dia: 18mm Stem Length: 11 mm Fits 5 mm Hole
 A-14997 <small>(10053182)</small> Black Nylon Push-Type Retainer Head Dia: 19/32" Stem Length: 13/36" Fits into 5/16" Hole GM 1987-On	 A-14011 <small>(14019226)</small> 14071289) Black Nylon Radiator Overflow Bottle/Windshield Washer Bottle Retainer Hd Dia: 21/32" Fits 5/16" Hole GM 1981-On	 A-14994 <small>(20510029)</small> Hole Dia: 250" Panel Range: 100-240" Flange Dia: 1,000" Stem Length: 900" Ford: N8048375	 A-14697 <small>(GM: 94198887)</small> Honda: 90657-SA6-003; Mazda N304-13-356A) Black Nylon Push-Type Retainer Hd Dia: 14mm Stem Length: 11mm Fits 7mm Hole	
 A-14992 <small>(Ford: N803946S; Chevy: 8502871)</small> Black Nylon Push-Type Retainer Head Dia: 19/32" Stem Length: 29/32" Fits into 1/4" Hole Ford & Chrysler 1987-On	 A-13994 <small>(GM: 20570245; Ford: N8045145)</small> Black Nylon Spare Tire Retainer Hd Dia: 1" Fits 5/16" Hole GM 1984-On	 A-17057 <small>(90505-SM-4-003)</small> Black Nylon Push-Type Retainer Head Dia: 18mm Stem Length: 21mm Fits into 8m Hole Accord 1990 - On	 A-16000 <small>(Honda: 90675-SB3-003; Mazda: F801-56-994;</small> Nissan: 63879-95596 Black Nylon Push-Type Retainer Hd Dia: 20mm Stem Length: 8mm Fits 8mm Hole	
 A-14260 <small>(Toyota: 90497-08017; Mazda: 99060-50-026; GM: 20426301)</small> Black Nylon Push-Type Retainer Head Dia: 15mm Stem Length: 12mm Fits into 7mm Hole	 A-17632 <small>(Mazda: B092-51-833; Ford: M8455-50143)</small> Black Nylon Push-Type Retainer Head Dia: 18mm Stem Length: 12mm Fits into 8mm Hole Mazda & Ford Aspire	 A-17222 <small>(GM: 11561878; 21075686; Ford: F3LX-14573-B)</small> Black Nylon Push-Type Retainer Head Dia: 15mm Stem Length: 20mm Fits into 8mm Hole Saturn 1991 - On	 A-16858 <small>(Nissan: 63879-95596; Ford: N8A01-56145)</small> Nylon Inlet Fender Shield Retainer Hd Dia: 20mm(23/32") Stem Length: 18mm(23/32") Fits 8mm 5/16 Hole Nissan 1990-On Ford Probe & Aspire 1995-On	

PRODUCT CATEGORY: X

Nylon Push Screw Type Retainers

17 Items • 155Pcs
IBS No. 344P



Packaged in a Locking Steel Drawer for Easy Storage & Organization

IBS, Inc.
SPECIALTY PRODUCTS FOR MAINTENANCE & REPAIR
INDUSTRIALBOLT.COM © & © 800-878-1906

Black Trim Screws

Assortment No. 345P

 A-10654 #8 X 1-1/4 PHIL OVAL SEMS T/S	 A-12820 8 X 3/4 PHIL PAN SEMS T/S B/O	 A-12213 8 X 1/2 PHIL FLT TOP WASH HD	 A-12215 8 X 3/4 PHIL FLT TOP WASH HD	 A-12216 8 X 1 PHIL FLT TOP WASH HD
 A-12953 10 X 3/4 PHIL FLT TOP WASH HD	 A-12954 10 X 1 PHIL FLT TOP WASH HD	 A-10180 8 X 1/2 PHIL PAN HD T/S B/O	 A-10181 8 X 3/4 PHIL PAN HD T/S B/O	 A-10182 8 X 1 PHIL PAN HD T/S B/O
 A-10183 8 X 1-1/4 PHIL PAN T/S B/O	 A-11921 10 X 1/2 PHIL PAN HD T/S B/O	 A-11922 10 X 3/4 PAN HD T/S B/O	 A-11923 10 X 1 PHIL PAN HD T/S B/O	 A-10163 8 X 1/2 PHIL OVAL T/S B/O
 A-10165 8 X 3/4 PHIL OVAL T/S B/O	 A-10167 8 X 1 PHIL OVAL T/S B/O	 A-11086 10 X 3/4 PHIL OVAL T/S B/O	 A-11088 10 X 1 PHIL OVAL T/S B/O	 A-12060 M4.2 X 20 PHIL WASHER HD T/S
 A-15373 M4.2 X 20 HEX HD SEMS T/S B/O	 A-12339 M6.3 X 25 HEX HD SEMS T/S B/O			

PRODUCT CATEGORY: X

Black Trim Screws

22 Items • 950 Pcs
IBS No. 345P



Packaged in a Locking Steel Drawer for Easy Storage & Organization

IBS, Inc.
SPECIALTY PRODUCTS FOR MAINTENANCE & REPAIR
INDUSTRIALBOLT.COM © & © 800-878-1906

Metric Body Hardware

Assortment No. 346P

 A-13613 M8 X 25 HEX HEAD SEMS T/S	 A-12336 M8 X 25 HEX WASHER HD T/S	 A-15780 M8 X 33 HEX HD SEMS T/S DOG PT	 A-11641 M10 X 40 HEX HD SEMS T/S
 A-11709 M8-1.25 HEX FLANGE LOCKNUT 17MM FLANGE	 A-15334 M8-1.25 FREE SPINNING WASHER	 A-12667 M8-1.25 GM "U" NUT	 A-11630 M8-1.25 GM/FORD U NUT
 A-12065 M6 X 25 HEX HEAD SEMS T/S	 A-15818 M6 X 30 HEX HD SEMS T/S DOG PT	 A-12160 M6 X 22 HEX HD SEMS T/S DOG PT	 A-16893 M6 X 28 HEX HD SEMS T/S DOG PT
 A-11631 M10-1.5 GM U NUT	 A-12669 M6-1.0 GM/FORD "U" NUT	 A-12575 M6-1.0 GM "U" NUT	 A-13619 M10 X 30 HEX HD SEMS T/S

PRODUCT CATEGORY: X

Metric Body Hardware

19 Items • 215 Pcs
IBS No. 346P



Packaged in a Locking Steel Drawer for Easy Storage & Organization

IBS, INCORPORATED

Assortments - Automotive (X)



JIS Hex Head Capscrews					
Assortment No. 697R					
10802 M8-1.25 X 16 JIS HEX C/S ZP	10803 M8-1.25 X 20 JIS HEX C/S ZP	10804 M8-1.25 X 25 JIS HEX C/S ZP	10805 M8-1.25 X 30 JIS HEX C/S ZP	10807 M8-1.25 X 40 JIS HEX C/S ZP	10811 M10-1.25 X 20 JIS HEX C/S ZP
10812 M10-1.25 X 25 JIS HEX C/S ZP	10813 M10-1.25 X 30 JIS HEX C/S ZP	10814 M10-1.25 X 35 JIS HEX C/S ZP	10815 M10-1.25 X 40 JIS HEX C/S ZP	10816 M10-1.25 X 45 JIS HEX C/S ZP	10817 M10-1.25 X 50 JIS HEX C/S ZP
10822 M12-1.25 X 25 JIS HEX C/S ZP	10823 M12-1.25 X 30 JIS HEX C/S ZP	10824 M12-1.25 X 35 HEX C/S JIS ZP	10825 M12-1.25 X 40 JIS HEX C/S ZP	10827 M12-1.25 X 50 JIS HEX C/S ZP	
10840 M8-1.25 JIS HEX NUT ZP	10841 M10-1.25 JIS HEX NUT ZP	10842 M12-1.25 JIS HEX NUT ZP			

PRODUCT CATEGORY: X

JIS Hex Head Capscrews

20 Items • 595 Pcs
IBS No. 697R



Packaged in a Locking Steel Drawer
for Easy Storage & Organization

Door Panel and Moulding Clips				
Assortment No. 842R				
A-11612 WEATHERSTRIP RETAINER - GM FORD AMC	A-12571 FASCIA TO BUMPER RETAINER BLK FORD	A-12992 5/16 GM NYLON RET. DOOR TRIM PANEL	A-14021 FASCIA RETAINER BLK	A-15480 FORD INTERIOR TRIM PANEL RETAINER - BLACK NYLON
A-15668 FORD TRIM PANEL RETAINER	A-15670 GM DOOR PANEL RETAINER	A-15970 GM DOOR TRIM PANEL RETAINER WHITE NYLON	A-16017 WHITE NYLON TRIM PANEL RETAINER	A-17102 WHITE TRIM PANEL RETAINER
A-17339 LINCOLN WEATHERSTRIP RETAINER	A-18033 CHRYSLER WEATHERSTRIP RETAINER	A-18353 DOOR TRIM PANEL PUSH TYPE RETAINER	A-18848 YELLOW FORD DOOR TRIM PANEL RETAINER	A-19386 CHRYSLER TRIM PANEL RETAINER NYLON
A-19655 HOOD INSULATION RETAINER BLK FORD	A-19850 WEATHER STRIP RETAINER	A-21241 FORD TRIM BLK NYLON ROCKER, PILLER & FENDER LINER 7.5MM X 28MM		

PRODUCT CATEGORY: X

Door Panel & Moulding Clips

18 Items • 315 Pcs
IBS No. 842R



Packaged in a Locking Steel Drawer
for Easy Storage & Organization

Push-In Fasteners				
Assortment No. 843R				
A-14260 TOYOTA PUSH-TYPE RETAINER 15MM HEAD DIA.	A-14369 MAZDA PUSH-TYPE RETAINER 20MM HD DIA. 9MM LENGTH	A-14753 PUSH-TYPE RETAINER 11/16 HEAD DIA. 7/8 LENGTH	A-16835 12MM SCREW RETAINER NYLON	A-17103 FASCIA RETAINING CLIP
A-17216 PUSH-TYPE RETAINER 20MM HEAD DIA. 20MM LENGTH	A-18030 CHRYSLER PUSH TYPE RTNR 11/16 HD 13/16 LGTH	A-18269 CHRYSLER LOWER SILL MOULDING CLIP	A-18310 GM REAR BUMPER FASCIA PUSH RETAINER	A-19244 FORD TRUNK TRIM PANEL RETAINER 1 HEAD DIA
A-19422 CHRYSLER FASCIA PUSH TYPE RETAINER 29/32 STM LENGTH	A-19801 GM PUSH-TYPE RETAINER	A-20191 FORD PUSH TYPE RTNR 16MM HD DIA 18MM STM LGTH	A-20349 NISSAN BUMPER CLIP PUSH TYPE RETAINER	A-20923 FORD & MAZDA PUSH TYPE RETAINER
A-21173 ACURA & HONDA PUSH TYPE RTNR BLK BUMPER & SPLASH SHIELD				

PRODUCT CATEGORY: X

Push-In Fasteners

16 Items • 135 Pcs
IBS No. 843R



Packaged in a Locking Steel Drawer
for Easy Storage & Organization

















ASSORTMENTS



IBS, INCORPORATED

Assortments - Anchors (Y)

ASSORTMENTS

IBS, Inc. SPECIALTY PRODUCTS FOR MAINTENANCE & REPAIR INDUSTRIALBOLT.COM • • • 800-678-1906		Hollow Wall Anchors & Fasteners		
Assortment No. 205R				
7698 6 X 1 PHIL PAN HD T/S ZP 		55230 4-6-8 X 1 WING SCREW PLASTIC 	55038 E-Z MINI ANCHOR ZINC E-Z Anchor Plus Range up to 7/8 In. 	
7717 8 X 1 PHIL PAN HD T/S ZP 	7719 8 X 1-1/2 PHIL PAN HD T/S ZP 	55231 8-10-12X1-1/4 WING SCREW 	55037 EZ-ANCHOR WHITE NYLON E-Z Anchor Plus Plus Range up to 7/8 In. 	
7733 10 X 1 PHIL PAN HD T/S ZP 	7735 10 X 1-1/2 PHIL PAN HD T/S ZP 	55231 8-10-12X1-1/4 WING SCREW 	55036 EZ-ANCHOR ZINC E-Z Anchor Plus Range up to 7/8 In. 	55035 MUNGO JET PLUG EZ-ANCHOR 
7763 14 X 1 PHIL PAN HD T/S ZP 	7765 14 X 1-1/2 PHIL PAN HD T/S ZP 	55232 12-14-16X1-1/2 WING SCREW 		55240 E-Z TOGGLE STANDARD E-Z Toggle Range up to 1 1/2 In. 













PRODUCT CATEGORY: Y

Hollow Wall Anchors & Fasteners

16 Items • 650 Pcs
IBS No. 205R



Packaged in a Locking Steel Drawer for Easy Storage & Organization

IBS, Inc. SPECIALTY PRODUCTS FOR MAINTENANCE & REPAIR INDUSTRIALBOLT.COM • • • 800-678-1906		Concrete Screws with Drills & Installation Kit		
Assortment No. 273P				
55309 1/4 X 2-1/4 HWH CONCRETE SCREW 	55316 3/16X2-1/4 PHIL FLT CONCRETE SCREW 	55336 5/32X7 SDS HEX CARBIDE DRILL Use with 3/16 Screws 	55330 TOOL KIT FOR CONCRETE SCREWS 	
55308 1/4 X 1-3/4 HWH CONCRETE SCREW 	55315 3/16X1-3/4 PHIL FLT CONCRETE SCREW 	55338 3/16X7 SDS HEX CARBIDE DRILL Use with 1/4 Screws 		
55307 1/4 X 1-1/4 HWH CONCRETE SCREW 	55314 3/16X1-1/4 PHIL FLT CONCRETE SCREW 	55317 3/16X2-3/4 PHIL FLT CONCRETE SCREW 	55324 1/4X2-3/4 PHIL FLT CONCRETE SCREW 	
55300 3/16 X 1-1/4 HWH CONCRETE SCREW 	55310 1/4 X 2-3/4 HWH CONCRETE SCREW 			





PRODUCT CATEGORY: Y

Concrete Screws with Drills & Installation Kit

13 Items • 253 Pcs
IBS No. 273P



Packaged in a Locking Steel Drawer for Easy Storage & Organization

IBS, Inc. SPECIALTY PRODUCTS FOR MAINTENANCE & REPAIR INDUSTRIALBOLT.COM • • • 800-678-1906		Hollow Wall Anchors & Fasteners		
Assortment No. 397R				
55095 10-24 HVY DUTY TOGGLE ANCHOR 	55096 1/4-20 HVY DUTY TOGGLE ANCHOR 	55093 1/2 TO 5/8 POLY TOGGLE 	143150 3/16 X 1-1/4 RAPIDRIVE PHIL PH 	
		55037 EZ-ANCHOR WHITE NYLON 		
9585 10-24 X 3 PHIL ROUND HD M/S ZP 	9608 1/4-20 X 4 PHIL ROUND HD M/S 	7719 8 X 1-1/2 PHIL PAN HD T/S ZP 	143152 3/16 X 1-1/4 RAPIDRIVE PHIL OH 	

PRODUCT CATEGORY: Y

Hollow Wall Anchors & Fasteners

9 Items • 180 Pcs
IBS No. 397R



Packaged in a Locking Steel Drawer for Easy Storage & Organization

IBS, INCORPORATED

Travel Tray Assortments Z03



**A
S
S
O
R
T
M
E
N
T
S**

IBS, INCORPORATED

Travel Tray Assortments Z03



PRODUCT CATEGORY: PD

NITRO CARB DRAPS METRIC THREAD

IBS No. 17179 • 4 ITEMS • 4 Pcs



PRODUCT CATEGORY: PD

DOUBLE-ENDED DRILL BITS

IBS No. 17442 • 6 ITEMS • 6 Pcs



PRODUCT CATEGORY: PD

POWER OUT EXTRACTOR & LEFT HAND NITRO CARB DRILL BITS

IBS No. 745R • 10 ITEMS • 10 Pcs



PRODUCT CATEGORY: PD

NITRO-CARB-STEP DRILLS

IBS No. 749R • 6 ITEMS • 6 Pcs



PRODUCT CATEGORY: PD

CARBIDE-TIPPED STRAIGHT FLUTE DRILL BITS

IBS No. 834R • 5 ITEMS • 5 Pcs



PRODUCT CATEGORY: PD

POWER-OUT EXTRACTORS & STUBBY LEFT HAND DRILL BITS

IBS No. 818R • 10 ITEMS • 10 Pcs

ASSORTMENTS



IBS, INCORPORATED

Travel Tray Assortments Z03

ASSORTMENTS

Platinum Spiral Flute Step Drills for materials up to 1/8" thick Assortment 855R					
138672 1/8-1/2 X 1/32 PLATINUM SPIRAL FLUTE STEP DRILL 1/4 HEX SHANK 13 HOLES	138673 3/16-1/2 X 1/16 PLATINUM SPIRAL FLUTE STEP DRILL 1/4 HEX SHANK 6 HOLES	138675 3/16-7/8 X 1/16 PLATINUM SPIRAL FLUTE STEP DRILL 1/4 HEX SHANK 12 HOLES			

PRODUCT CATEGORY: PD

PLATINUM SPIRAL FLUTE STEP DRILLS

IBS No. 855R • 3 ITEMS • 3 Pcs

Platinum Spiral Flute Step Drills for materials up to 1/8" thick Assortment 856R					
138672 1/8-1/2 X 1/32 PLATINUM SPIRAL FLUTE STEP DRILL 1/4 HEX SHANK 13 HOLES	138673 3/16-1/2 X 1/16 PLATINUM SPIRAL FLUTE STEP DRILL 1/4 HEX SHANK 6 HOLES	138675 3/16-7/8 X 1/16 PLATINUM SPIRAL FLUTE STEP DRILL 1/4 HEX SHANK 12 HOLES	138674 3/16-3/4 X 1/16 PLATINUM SPIRAL FLUTE STEP DRILL 1/4 HEX SHANK 10 HOLES	138676 7/16-1/8 X 1/16 PLATINUM SPIRAL FLUTE STEP DRILL 1/4 HEX SHANK 2 HOLES	138677 7/8-1/8 X 1/4 PLATINUM SPIRAL FLUTE STEP DRILL 1/4 HEX SHANK 2 HOLES

PRODUCT CATEGORY: PD

PLATINUM SPIRAL FLUTE STEP DRILLS

IBS No. 856R • 6 ITEMS • 6 Pcs

M42 Thin Wall Hole Saws Assortment 820R					
29295 3/4 M42 THIN WALL HOLE SAW	29292 1 1/8 M42 THIN WALL HOLE SAW	29293 1-1/8 M42 THIN WALL HOLE SAW	29294 1-1/4 M42 THIN WALL HOLE SAW	29295 1-3/8 M42 THIN WALL HOLE SAW	29296 1-1/2 M42 THIN WALL HOLE SAW

PRODUCT CATEGORY: PT

M42 THIN WALL HOLE SAWS

IBS No. 820R • 7 ITEMS • 7 Pcs

Bi-Metal Air Saw Blades Assortment No. 513P					
441318 2 X 1/2 .025 18TPI AIR SAW	441324 2 X 1/2 .025 24TPI AIR SAW	441332 3 X 1/2 .025 32TPI AIR SAW	441418 4 X 1/2 .025 18TPI AIR SAW	441424 4 X 1/2 .025 24TPI AIR SAW	441432 4 X 1/2 .025 32TPI AIR SAW

PRODUCT CATEGORY: PT

BI-METAL AIR SAW BLADES

IBS No. 513P • 6 ITEMS • 30 Pcs

Reciprocating Saw Handle & Blade Kit Assortment No. 706R					
44600 RECIPROCATING SAW HANDLE	44606 6 TPI BIMETAL RECIP BLADE	44610 6 10TPI BIMETAL RECIP BLADE	44618 6 18TPI BIMETAL RECIP BLADE	44624 6 24TPI BIMETAL RECIP BLADE	44670 6 7X10TPI BORE BLADE

PRODUCT CATEGORY: PT

RECIPROCATING SAW HANDLE BLADE KIT

IBS No. 706R • 7 ITEMS • 11 Pcs

IBS, INCORPORATED

Travel Tray Assortments Z03

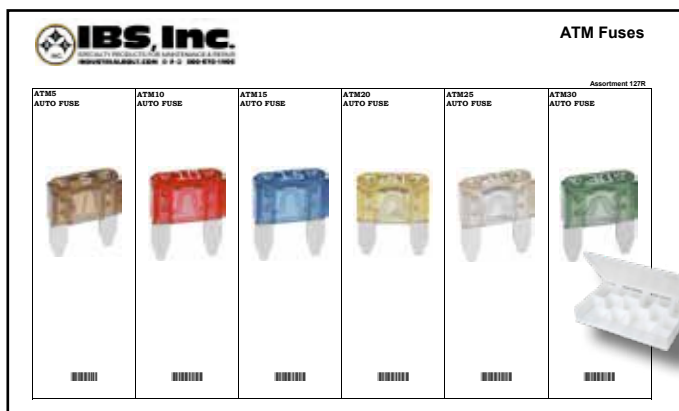

PRODUCT CATEGORY: Q

ATM FUSES

IBS No. 127R • 6 ITEMS • 60 Pcs



PRODUCT CATEGORY: Q

MAXI FUSES

IBS No. 128R • 7 ITEMS • 31 Pcs

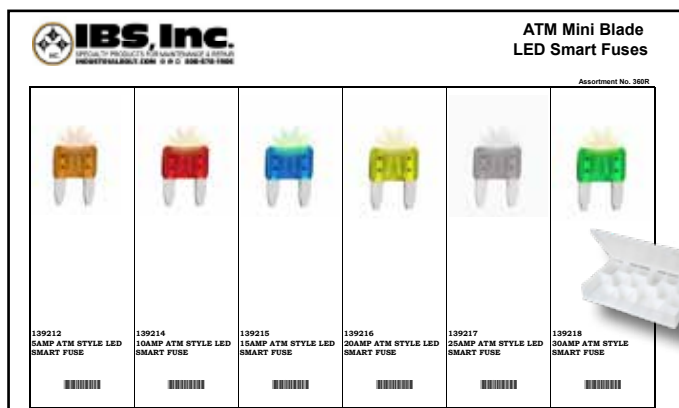

PRODUCT CATEGORY: Q

ATM MINI BLADE LED SMART FUSES

IBS No. 360R • 6 ITEMS • 36 Pcs



PRODUCT CATEGORY: Q

ATC STANDARD BLADE LED FUSES

IBS No. 361R • 6 ITEMS • 42 Pcs



PRODUCT CATEGORY: Q

MAXI BLADE LED SMART FUSES

IBS No. 362R • 6 ITEMS • 18 Pcs



PRODUCT CATEGORY: Q

ATM LOW PROFILE FUSES

IBS No. 721R • 7 ITEMS • 35 Pcs

ASSORTMENTS



IBS, INCORPORATED

Travel Tray Assortments Z03

ASSORTMENTS

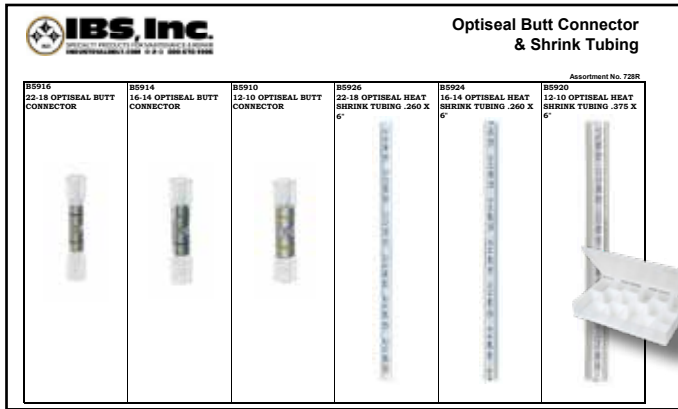

PRODUCT CATEGORY: Q

OPTI-SEAL BUTT CONNECTORS & SHRINK TUBING

IBS No. 728R • 6 ITEMS • 100 Pcs

IBS No. 728R-1 • KIT WITH CRIMP TOOL

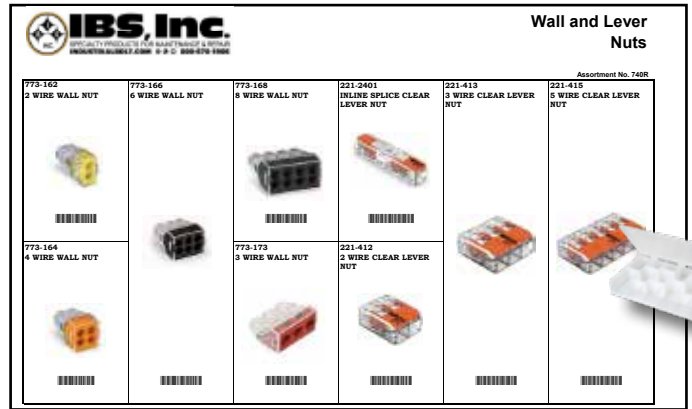

PRODUCT CATEGORY: Q

WALL & LEVER NUTS

IBS No. 740R • 9 ITEMS • 105 Pcs

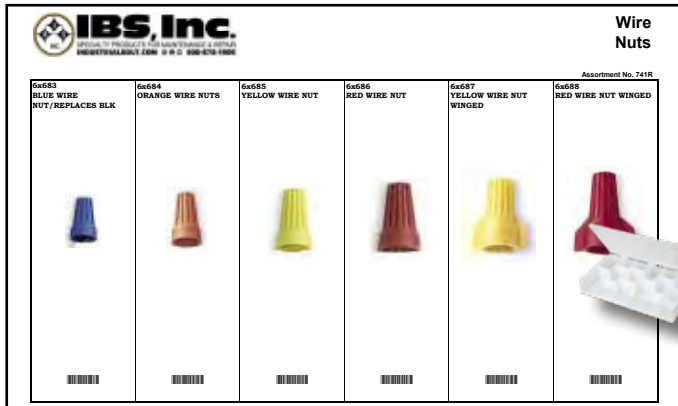

PRODUCT CATEGORY: Q

WIRE NUTS

IBS No. 741R • 6 ITEMS • 90 Pcs

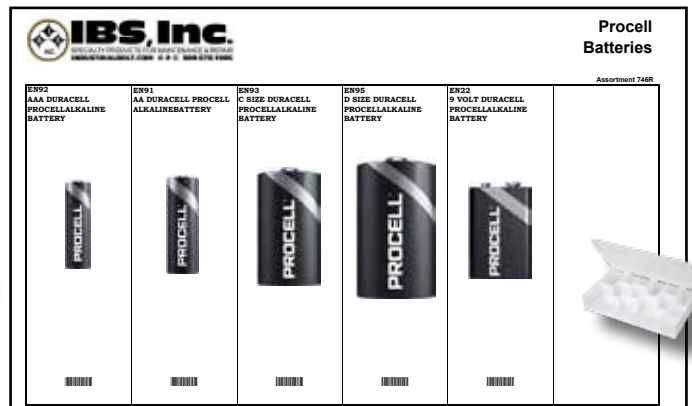

PRODUCT CATEGORY: Q

PROCELL BATTERIES

IBS No. 746R • 5 ITEMS • 30 Pcs



PRODUCT CATEGORY: Q

ATC FUSES

IBS No. 792R • 8 ITEMS • 40 Pcs

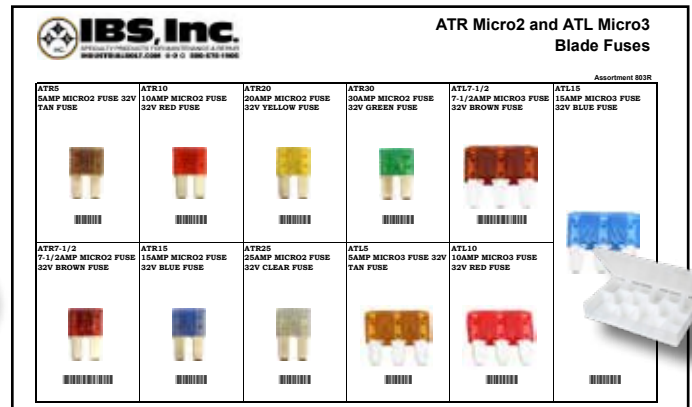

PRODUCT CATEGORY: Q

ATR MICRO2 & ATL MICRO3 BLADE FUSES

IBS No. 803R • 11 ITEMS • 55 Pcs

IBS, INCORPORATED

Travel Tray Assortments Z03



PRODUCT CATEGORY: Q

FMX FUSES

IBS No. 851R • 6 ITEMS • 12 Pcs



PRODUCT CATEGORY: Q

FMX LOW PROFILE FUSES

IBS No. 852R • 6 ITEMS • 12 Pcs



PRODUCT CATEGORY: Q

FMM FUSES

IBS No. 853R • 5 ITEMS • 30 Pcs

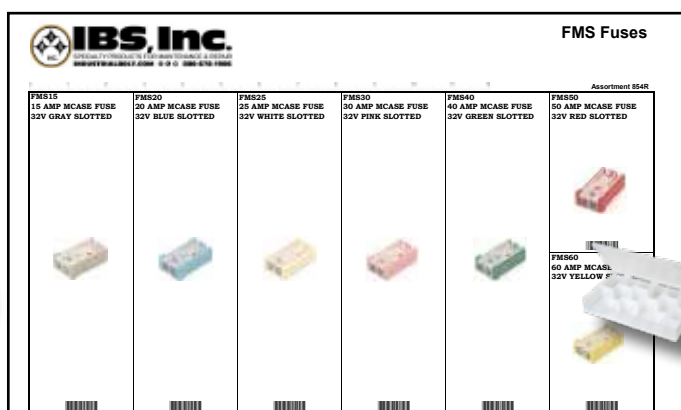

PRODUCT CATEGORY: Q

FMS FUSES

IBS No. 854R • 7 ITEMS • 35 Pcs



PRODUCT CATEGORY: SA

LOCTITE QUICK-STIX TRAVEL TRAY

IBS No. 673R • 6 ITEMS • 6 Pcs



PRODUCT CATEGORY: SA

LOCTITE 10ML TRAVEL TRAY

IBS No. 747R • 6 ITEMS • 6 Pcs

ASSORTMENTS



IBS, INCORPORATED

Travel Tray Assortments Z03

ASSORTMENTS



PRODUCT CATEGORY: Q

**NO MESS THREADLOCKER
TRAVEL TRAY**
IBS No. 817R • 4 ITEMS • 4 Pcs



PRODUCT CATEGORY: Q

**THREADLOCKER, ANTI-SEIZE
& DIELECTRIC GREASE TRAVEL TRAY**
IBS No. 832R • 6 ITEMS • 12 Pcs

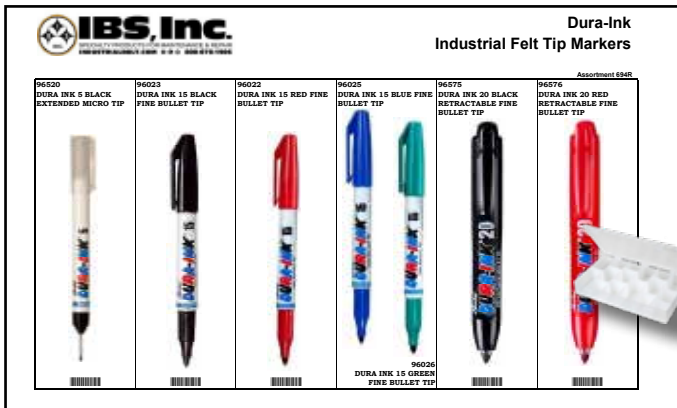

PRODUCT CATEGORY: SCO

DURA-INK INDUSTRIAL MARKERS
IBS No. 694R • 7 ITEMS • 11 Pcs

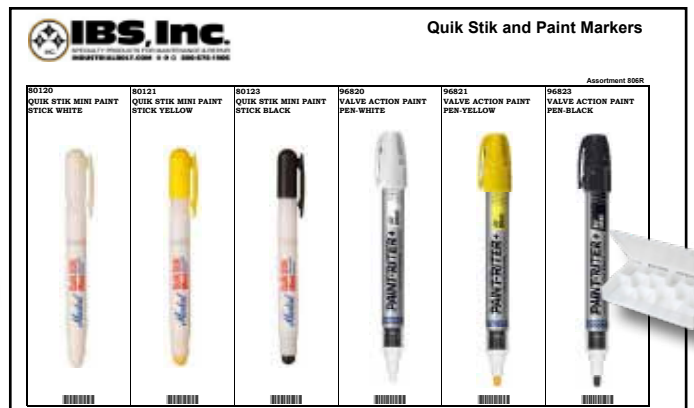

PRODUCT CATEGORY: SCO

QUIK STIK & PAINT MARKERS
IBS No. 806R • 6 ITEMS • 6 Pcs



PRODUCT CATEGORY: V

PRESSURE WASHER NOZZLES
IBS No. 830R • 4 ITEMS • 4 Pcs

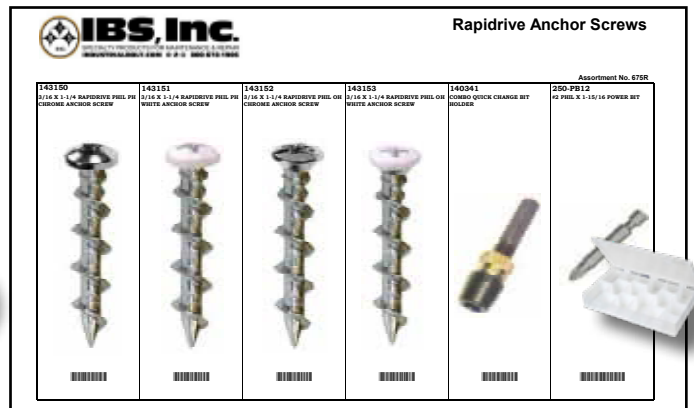

PRODUCT CATEGORY: Y

RAPIDRIVE ANCHOR SCREWS
IBS No. 675R • 6 ITEMS • 205 Pcs