



Electrical

A

Aerosols & Chemicals

Cleaners

Batt. Clean/Protect Q-119

Electrical

4 Way Plus Q-119

Contact and Circuit

Board Cleaner Q-120

Degreaser Q-119

Dielectric Grease Q-120

Undercoat Q-120

Assortments, Electrical

Automotive Electrical

Automotive Fuse Holders & Accessories Q-102

Deutsch DT Connectors & Terminals Q-37

with Crimping & Removal Tools Q-37

FMS (aka Slotted MCASE) Fuse Assortment Q-99, Q-100

FMX, FMX Low Profile & FMM Fuses Q-99, Q-100

Heavy Duty Truck Circuit Breakers Q-106

Metri-Pack 280 Series Assortment Q-40, Q-43

with Crimping & Removal Tools Q-40

Weather-Pack Series Assortment Q-43

Weather-Pack Series Assortment

with Crimping & Removal Tools Q-43

Batteries

Rayovac Ultra-Pro Alkaline Batteries Q-109

Battery

Tin Plated Copper Tubular Lugs Q-67

Battery Terminals

Copper Tubular Lug Q-66

EcoMax Battery Ends & Shrink Tubing Assortment Q-59

EcoMax Post Top Battery Terminals Q-59

Fusion Battery Ends Q-62

Fusion Solder-On Battery Ends & Shrink Tubing Q-59, Q-62

Post Top Terminals, HD Lugs & Splices Q-59

Special Battery Ends Q-64

Tin Plated Copper Tubular Lugs Q-67

Bulbs

12V Mini Auto Bulbs Q-87

Automotive Bulbs Q-87

12V Miniature Automotive Bulbs Assortment Q-87

Cable Ties

8" Colored Cable Tie Wraps Q-77

Black Low Profile Cable Tie Wraps Q-74

Black Nylon Ty-Raps with Metal Tabs Q-70, Q-71, Q-73

Cable Tie Rack Assortment Q-73

Cable & Tubing Mounting

Tie Wraps Q-79

Colored Cable Tie Wraps Q-77

Low Profile Cable Tie Wraps Assortment Q-74

Met-Tab Cable Tie Rack Assortment Q-70

Nylon Cable Tie Wraps Q-73

Releasable Cable Tie Wraps Q-75

Standard Cable Tie Wraps Q-73

Weather-Resistant Cable Tie Wraps Q-73

Circuit Breakers Q-106

Automotive Circuit Breakers ATM & ATC Q-106

Clamps

Nylon Clamps Q-82

Nylon & Rubber Clamp Q-82

Rubber Insulated Clamps

1/4" Mounting Hole Q-82

3/8" Mounting Hole Q-83

Vinyl Coated Q-82

Fuses

ATC Blade-Type Fuses Travel Tray Q-93

ATC LED Smart Fuse Travel Tray Q-97

ATM Blade-Type Fuses Travel Tray Q-92

ATM LED Smart Fuses Travel Tray Q-97

ATM Low Profile Fuse Assortment Q-91

ATM Mini-Blade LED Smart Fuse Q-97

ATR, ATL & ATM Low Profile Fuses Q-89

Automotive Electrical Fuses Q-95

Automotive Fuse Holders & Accessories Q-102

Blade Fuses Q-95

LED Smart Fuse Q-97

MAXI Blade LED Smart Fuses Q-97

Micro Fuses Assortment Q-89, Q-90

Micro Fuses Travel Tray Assortment Q-89, Q-90

Grommets

Q-83

Shrink Tubing

Automotive Dual Wall Heat Shrink Tubing Q-53

Automotive Shrink Tubing

Includes Torch Q-55, Q-56

Heavy Wall Heat Shrink Tubing Q-54

Solder

60/40 Rosin Core Solder &

Excalibur Torch Assts Q-116

Tapes & Sealants

Electrical Tape Assortment Q-45

Silicone Sealing Tape Q-46

Terminals

Blue 16-14 Electrical Connectors Q-13

Crimp & Seal

Long Neck Crimp & Seal Terminals Q-21

Crimp & Seal Sealed Wire Connectors Q-24

Crimp & Seal Terminals Q-22

includes Torch & Butane Refill Q-22

Deutsch DT Connectors & Terminals Q-37

DTP Deutsch Connectors & Tools Assortment Q-36

Heavy Duty Wire Ends for #8, #6 & #4 GA Wire Q-14

Long Neck Crimp & Seal Terminals Q-21

Multilink Wire Ends Q-17



Includes Torch & Butane Refill Q-17
 without Torch & Butane Refill Q-17
 with Thermal Indicator Butt Connectors Q-17
 Non-Insulated Terminals Q-7
 Nylon Insulated Terminals Q-7, Q-13
 Optiseal Heat Shrink Kits Q-27
 OptiSeal Terminals Q-27
 Red 22-18 Electrical Connectors Q-13
 Vinyl Insulated Terminals Q-8
 Wall & Lever Nut Travel Tray Q-33
 Wall Nuts & Wire Nuts
 Includes crimp tool Q-31, Q-33, Q-36
 Wire Nuts Travel Tray Q-33
 Yellow 12-10 Electrical Connectors Q-13

Wire

General Purpose Primary Wire Q-49
 Heavy Duty (Cross-Linked) Primary Wire Q-48

Automotive Electrical

Assortments

ATC Blade-Type Fuses Travel Tray Q-93
 ATC Mini-Blade LED Smart Fuse Q-97
 ATM Mini-Blade LED Smart Fuse Q-97
 Automotive Bulbs Q-87
 Automotive Circuit Breakers ATM & ATC Q-106
 Deutsch DT Connectors & Terminals Q-37
 Deutsch DT Connectors & Terminals Assortment
 with Crimping & Removal Tools Q-37
 Heavy Duty Truck Circuit Breakers Q-106
 LED Smart Fuse Q-97
 Metri-Pack 280 Series Assortment Q-40
 with Crimping & Removal Tools Q-40
 With Crimping & Removal Tools Q-40
 Weather-Pack Series Assortment Q-43
 Weather-Pack Series Assortment
 With Crimping & Removal Tools Q-43

Automotive Bulbs Q-84, Q-85, Q-86

Circuit Breakers

Blade-Type Q-103

Convuluted Tubing (Split Loom) Q-108

Deutsch Connectors & Terminals

Deutsch 2-Way Connectors Q-35
 Deutsch 3-Way Connectors Q-35
 Deutsch 4-Way Connectors Q-35, Q-36
 Deutsch 6-Way Connectors Q-35
 Deutsch 8-Way Connectors Q-35
 Deutsch 12-Way Connectors Q-35
 Deutsch Connector Tools Q-34, Q-38, Q-39, Q-40, Q-41
 , Q-42, Q-43
 Deutsch Seal Plug Q-34
 Deutsch Terminals Q-34
 DTP Deutsch Connectors
 DTP 2-Way Connectors Q-36
 DTP 4-Way Connectors Q-36
 DTP Terminals Q-36

Electronic Signal Flashers Q-107

Fabric Loom Q-108

Flashers Q-107

Fuse Holders Q-101

Fuses

ATC Blade-Type Fuses Q-93
 ATM Blade-Type Fuses Q-89, Q-91, Q-92
 FMM Fuses Q-98
 FMS Fuses Q-98
 FMX Q-98
 Glass Tube Fuses Q-88
 LED Smart Fuses Q-96
 MAXI Blade-Type Fuses Q-94

Metri-Pack 280 Series

Metri-Pack 1 Connectors Q-38
 Metri-Pack 2 Connectors Q-38
 Metri-Pack 3 Connectors Q-39
 Metri-Pack 5 Connectors Q-39
 Metri-Pack 12-14 Terminals Q-38
 Metri-Pack 16-18 Terminals Q-38
 Metri-Pack Cable Seals Q-38, Q-41, Q-42
 Metri-Pack Cavity Plug Q-39
 Metri-Pack Crimping Tool Q-39
 Metri-Pack Terminal Removal Tool Q-39

Relay, 5 Prong Q-107

Spiral Wrap Q-108

Test Clips Q-108

Weather-Pack Connectors & Terminals

Weather-Pack Cable Seals Q-41
 Weather-Pack Cavity Plug Q-41

Weather-Pack Terminals & Connectors

Weather-Pack 1 Connectors Q-41
 Weather-Pack 2 Connectors Q-41
 Weather-Pack 3 Connectors Q-42
 Weather-Pack 4 Connectors Q-42
 Weather-Pack 6 Connectors Q-42
 Weather-Pack 12 GA Terminals Q-42
 Weather-Pack 16-14 GA Terminals Q-42
 Weather-Pack 20-18 GA Terminals Q-42
 Weather-Pack Terminal Extractor Tool Q-42

Weather-Pack Terminals & Connectors

Weather-Pack 22-12GA Crimper Q-42

B

Batteries Q-109

Assortments

Procell Alkaline Batteries Q-109

Battery Terminals

Accessories

Accessory Bolts Q-63
 Battery Converters
 Side Terminal to Post Conversion Q-63
 Brushes Q-65
 Cable Slugs Q-64
 Converters Q-63
 Nuts & Bolts, Battery Q-63
 Power Cleaning Brushes, Battery End Q-65
 Terminal Protectors Q-65



Assortments

- Fusion Battery Ends Q-62
- Fusion Solder-On Battery Ends & Shrink Tubing Q-59, Q-62
- Post Top Terminals, HD Lugs & Splices Q-59
- Special Battery Ends Q-64

Automotive Series Emergency Style Q-63

Battery Bolts Q-63

- Accessory Q-63

Battery End Power Cleaning Brushes Q-65

Battery / Welding Cable Q-51

Converters Q-63

ECOMAX

- Flag Terminal Q-58
- Left Elbow Terminal Q-58
- Right Elbow Terminal Q-58

Fusion Solder-On

- Flag Terminal Q-62
- Lugs Q-62
- Right Q-58, Q-61
- Straight Q-58, Q-61

Heavy Duty Lugs Q-65

Heavy Duty Splices Q-65

Heavy Duty Universal Q-63

Lugs

- Copper Tubular Q-66, Q-67
- Fusion Solder-On Q-62
- Tin Plated Copper Q-67

Marine Wing Nut Style Q-63

Military Spec Q-63

Nuts Q-63

- Stud Top Q-60

OEM Style Q-63

Post Top / Side Mount

- Slugs Q-64
- Straight Clamp Terminal Q-60

Protectors Q-65

Stud Top / Side Mount Q-60

- Double Barrel (Splice) Q-60

Tubular Lugs Q-66, Q-67

Universal Q-63

Battery Terminals

ECOMAX Q-58

- Straight Clamp Q-58

Blade-Type Circuit Breakers Q-103

Booster Cables Q-69

Bulbs

Assortments

- Automotive Bulbs Q-87

Automotive Q-84, Q-85, Q-86

Replacement, Work Light

- 9W Fluorescent Q-113
- 12V 13W Fluorescent Q-113
- 13W Fluorescent Q-113
- 500W Halogen Work Light Bulb Q-113

Rough Service Q-109

C

Cable

- Battery / Welding Q-51

Cable Clamps Q-69

Cable Ties

- Adjustable Cable & Hose Mounts Q-80
- Buttonhead Q-78
- Cable Tie Bases Q-80
- Colored & Fluorescent Q-76
- Dual Clamp Cable Ties Q-79
- Low Profile Cable Tie Wraps Q-74
- Mounting Ties Q-78
- Natural Nylon Q-72
- Nylon Speedy Ties Q-75
- Push Mounting Q-78
- Stud Mount Cable Tie Wrap Q-78
- Ty-Rap Black Nylon with Metal Tabs Q-70, Q-80
- UV Black Weather-Resistant Q-72, Q-74

Circuit Breakers

Assortments

- Heavy Duty Truck Circuit Breakers Q-106

Blade Type

- ATC Style Breakers
- CB221 Q-104
- CBB Q-104
- CCB Q-104
- FCB Q-104
- MAXI Style Breakers
- CB1911 Q-103
- UCB Breakers
- UCB Q-104

Blade-Type

- Mini Breakers
- CB212 Q-103

Stud Mount

- AMG Q-105
- Heavy Duty Type 1
- CBC Q-105
- Standard Duty Type 2
- CBS Q-105
- Type II - 12 volt
- CBF Q-105

Clamps

Adjustable Q-81

Assortments

- Nylon Clamp Q-82
- Nylon & Rubber Clamp Q-82
- Rubber Insulated Clamps
- 1/4" Mounting Hole Q-82
- 3/8" Mounting Hole Q-83
- Vinyl Coated Clamps Q-82

Chassis Clips Q-81

Nylon Clamps Q-81

Rubber Insulated Clamps Q-81

Vinyl Dipped Hose Clamps Q-81



Clips, Test Q-108
Convolute Tubing Q-108
Crimping Tools
 Indent Crimper Q-69
 Ratcheting Crimp Tool Q-118
 Universal Crimping Tool Q-68
 Wire Crimp Tool Q-118

E

Extension Cords
 Heavy Duty
 50' Single Tap Q-114

F

Flashers Q-107
Flux Q-64
Fuse Holders Q-101
Fuses
 Assortments
 ATC Mini-Blade LED Smart Fuse Q-97
 ATM Mini-Blade LED Smart Fuse Q-97
 Automotive Electrical Fuses Q-91, Q-92, Q-93, Q-95, Q-102
 LED Smart Fuse Q-97

Blade Type
 LED Smart Fuses
 ATM Q-96
 ATO/ATC Q-96
 MAXI Q-96
Blade-Type
 ATC Q-93
 ATM Q-89, Q-91, Q-92
 MAXI Q-94

FMX Q-98
FMX Low-Profile Q-98
Fuse Holders Q-101
Fusepuller Q-88
Fusible Links Q-105

Glass Tube
 AGA Q-88
 AGC Q-88
 AGW Q-88
 AGX Q-88
 GBC Q-88
 SFE Q-88

Fusible Links Q-105

G

Grommets Q-83
 Assortments
 Grommet Kit Q-83

L

Light Bulbs
 Accessories

Replacement Bulbs
 9W Fluorescent Work Light Q-113
Rough Service Q-109
Lights
Accessories
 Adapters
 Single Tap Q-115
 Triple Tap Q-115
 Double Hooks for Tube Lights Q-113
 Extension Cords
 25' Single Tap Q-114
 50' Single Tap Q-114
 100' Single Tap Q-114
 Replacement Bulbs
 12V 13W Fluorescent Work Light Q-113
 13W Fluorescent Work Light Q-113
 Replacement Heads
 18W Fluorescent Light Q-113
 Replacement Plugs
 Female - 3 Wire Q-113
 Male - 3 Wire Q-113
 Replacement Tube Assembly
 13W Worklights Q-113
 Replacement Bulbs
 500W Halogen Worklight Q-113
Halogen Work Lights
 Professional Series 500W Halogen Work Light Q-111

LED Worklights (Corded)
 LED Work Light Q-111
 PRO 1200 LUMEN LED WORKLIGHT
 WITH 25 FT CORD Q-110
 Professional Series 60 LED
 on a 50" Metal Reel Q-110

Rechargeable
 Omni 2K Worklight Q-111
 Omni 3K Worklight Q-111
 Rechargeable LED Area Worklight with Magnetic
 Base Q-111
 Under-Hood Worklight Q-110

Loom

Fabric Q-108
Split Q-108

R

Rechargeable Work Lights Q-111

S

Shrink Tubing
6 to 1 Hi-Ratio Q-52
Assortments
 Automotive Shrink Tubing
 Includes Torch Q-55, Q-56
 Heavy Wall Heat Shrink Tubing Q-54
 Heavy Wall Heat Shrink Tubing Assortment II Q-52
Color Coded Dual Wall Shrink Tubing Q-55
Dual Wall



Clear Q-53
Heavy Wall Q-52
High Adhesive Flow Heat Q-54
Optiseal Adhesive-Lined Q-56
Thin Wall Q-55, Q-57
Solder
60/40 Rosin Core Solder Q-116
Assortments
60/40 Rosin Core Solder &
Excalibur Torch Assts Q-116
Solder Combo Assortments Q-117
NOKORODE® Regular Paste Flux Q-116
Silvabrite 100% Solder Q-115
Silver Bearing Solder Q-115
Slugs Q-64
Split Tubing & Sleeving
Convolute Tubing Q-108
Split Braided Sleeving Q-108
Split Tubing & Sleeve Installation Tool Q-108

I

Tapes & Sealants
Assortments
Electrical Tape Q-45
Black Liquid Electrical Tape Q-45
Blue Painter's Tape Q-47
Colored Electrical Tape Q-45
Duct Tape Q-47
Electrical Tape Q-44, Q-45
Fusion Tape Q-46
Liquid Electrical Tape Q-45
Masking Tape Q-47
Scotch Brand 33+
Electrical Tape Q-44
Scotch Brand 88 Electrical Tape Q-44
Sealing Compound Q-47
Silicone Sealing Tape Q-46
Teflon Tape Q-47
Terminals
Crimp & Seal

Butt Connectors Q-20
General Info Q-19
Quick Slides Q-20
Ring Terminals Q-20
Snap Plugs Q-20
Spade Terminals Q-20
Step Butt Connectors Q-20
Long Neck Terminals Q-21
Crimp & Seal Long Neck Terminals Q-21
Heavy Duty Large Gauge
Butt Connectors
Butt Connectors (WP) Q-14
HydraLink

HydraLink Closed End Connectors Q-23
HydraLink Inline Butt Connectors Q-23
Multilink

Butt Connectors Q-16
Butt Connectors with Thermal Indicator Q-16
General Info Q-15
Quick Slides - Female Q-16
Quickslides - Male Q-16
Ring Terminals Q-16
Spade Terminals Q-16
Step-Butt Connectors Q-16
Non-Insulated
Braze Seam
Butt Connectors Q-8
Ring Terminals Q-8
Butted Seam
Butt Connectors Q-7
Quickslide Terminals Q-7
Ring Terminals Q-7
Snap Plug Connectors Q-7
Spade Terminals Q-7
Nylon Insulated
3 & 4-Way Connectors Q-10
Butt Connectors
Insulation Grip (NB) Q-10
Moisture Resistant (NBM) Q-10
Seamless (SN) Q-10
Window Q-10
Closed End Connectors Q-12
Cool Seal Terminals
Butt Connectors Q-28
Flag Terminals Q-12
Heavy Duty Q-14
Heavy Duty Large Gauge
Ring Terminals Q-14
Multi-Stacks Q-12
Pin Terminals Q-11
Quick Slides
Female Q-12
Female - Fully Insulated Q-12
Male Q-12
Male Fully Insulated Q-12
Ring Terminals Q-11
Snap Plugs
Female Q-12
Male Q-12
Spade Terminals
Standard Q-11
Optiseal
Butt Connectors Q-25, Q-26
Female Bullet Receptacle Connectors Q-26
Male Bullet Plug Connectors Q-26
Male & Female Connectors Q-26
Ring Terminals Q-25
Spade Terminals Q-26



Step Butt Connectors Q-25

Quick Connectors

3M Performance Plus Wire Connectors Q-29

Instant Auto Connectors Q-32

Lever Nut Q-30

Lever-Nuts Q-31

Self-Stripping Disconnects Q-32

Self-Stripping Pigtail Connector Q-32

Wall Nuts Q-30, Q-31

Wire Nuts Q-32

Solder & Seal

Butt Connectors Q-18

Quick Slides Q-18

Ring Terminals Q-18

Spade Terminals Q-18

Vinyl Insulated Q-9

Butt Connectors Q-9

Quickslide Terminal Q-9

Ring Terminals Q-9

Snap Plugs Q-9

Spade Terminals Q-9

Step-Butt Connectors Q-9

Terminals, Battery

Accessories

Accessory Bolts Q-63

Battery Converters Q-63

Battery End Power Cleaning Brushes Q-65

Battery Nuts & Bolts Q-63

Terminal Protectors Q-65

Assortments

Cable Slugs Q-64

Fusion Battery Ends Q-62

Fusion Solder-On Battery Ends & Shrink Tubing Q-59, Q-62

Post Top Terminals, HD Lugs & Splices Asst Q-59

Special Battery Ends Q-64

Automotive Series Emergency Style Q-63

ECOMAX

Flag Terminal Q-58

Left Elbow Terminal Q-58

Right Elbow Terminal Q-58

Straight Clamp Q-58

Fusion Solder-On

Flag Terminal Q-62

Heavy Wall Lugs Q-62

Right Clamp Q-58, Q-61

Straight Clamp Q-58, Q-61

Heavy Duty Universal Q-63

Lugs

Heavy Duty Q-65

Tubular Q-66, Q-67

Marine Wing Nut Style Q-63

Military Spec Q-63

OEM Style Q-63

Stud Top / Side Mount

Double Barrel (Splice) Q-60

Straight Clamp Q-60

Stud Top Battery Bolts Q-60

Stud Top Battery Nuts Q-60

Test Clips Q-108

Tools

Battery & Crimping

12 Volt Tester Q-69

Battery Cable Stripper Q-69

Cable Clamps Q-69

Cable Cutter Q-69

High Capacity Hydraulic Crimper Q-68

Indent Crimper Q-69

Professional Grade Heavy Duty Booster Cables Q-69

Ratcheting Crimp Tool Q-118

Ratcheting Wire Terminal Crimper Q-118

Universal Crimping Tool Q-68

Wire / Cable Cutter Q-117

Wire Crimp Tool Q-118

Wire Cutter Q-69

Dual Temp Electric Heat Gun Q-117

Hand

Cable Tie Gun Q-80

High Capacity Hydraulic Crimper Q-68

Mini Cable Tie Gun Q-80

Power

Dual Temp Electric Heat Gun Q-117

Dual Temp Electric Heat Gun Q-117

Hydraulic Crimper Q-68

Solder & Welding

Butane Refill 42 Grams Q-116

IBS, INCORPORATED

Non-Insulated Connectors Q3A



Non-Insulated Butted Seam Terminals

The most economical terminal. Used where special performance or installation characteristics are not needed. Beveled mouth facilitates wire insertion.

RING TERMINALS

IBS No.	Wire	Stud	Qty
11-6	22-18	#6	100
11-8	22-18	#8	100
11-10	22-18	#10	100
12-6	16-14	#6	100
12-10	16-14	#10	100
12-14	16-14	1/4	100
13-8	12-10	#8	50
13-10	12-10	#10	50
13-14	12-10	1/4	50
13-56	12-10	5/16	50
13-38	12-10	3/8	50
13-500P	12-10	1/2	50



SPADE TERMINALS

IBS No.	Wire	Stud	Qty
31-10	22-18	#10	100
32-10	16-14	#10	100
33-10	12-10	#10	50



QUICKSLIDE TERMINALS

IBS No.	Wire	Type	Blade	Qty
72F-250-32	16-14	Female	1/4	100
72M-250-32	16-14	Male	1/4	100
73F-250-32	12-10	Female	1/4	50
73M-250-32	12-10	Male	1/4	50



BUTT CONNECTORS

IBS No.	Wire	Qty
61S	22-18	100
62S	16-14	100
63S	12-10	50



IBS No.	Wire	Type	Blade	Qty
82F-156-NL*	16-14	Female	.156	100
82M-156	16-14	Male	.156	100



* Nylon Insulated

Non-Insulated Terminal Assortment (Z02)

Top 24 Wire Ends

IBS No. 211R • 24 Items • 635 Pcs

Packaged in a locking steel drawer for easy storage and organization

IBS, Inc. SPECIALTY PRODUCTS FOR MAINTENANCE & REPAIR INDUSTRIALBOLT.COM © © © 800-678-1906		Non-Insulated Butted Seam Top 24 Wire Ends				Assortment No. 211R
61S 22-18 BUTT CONN NON INSUL	11-6 22-18 RING TERM. 6 STUD NO-INS	11-8 22-18 RING TERM 8 STUD NO-INS	11-10 22-18 RING TERM 10 STUD NO-INS	31-10 22-18 SPADE TERM #10 STUD	72F-250-32 16-14 FEMALE QUICK SLIDE	
62S 16-14 BUTT CONN NON INSULATED	12-6 16-14 RING TERM. 6 STUD NO-INS	12-10 16-14 RING TERM 10 STUD NO-INS	12-14 16-14 RING TERM #14 STUD NO-IN	32-10 16-14 #10 SPADE TERM	72M-250-32 16-14 MALE QIK SLIDE NO INSUL.	
63S 12-10 BUTT CONN. NON INSUL.	82F-156-NL 16-14 FEMALE SNAP PLUG VINYL	82M-156 16-14 MALE SNAP PLUG	13-8 12-10 RING TERM 8 STUD NON-INS	33-10 12-10 SPADE TERM #10 STUD	73M-250-32 12-10 MALE QIK SLIDE NO INSUL.	
13-10 12-10 RING TERM #10 STUD NO-IN	13-14 12-10 RING TERM 1/4 STUD	13-56 12-10 RING TERM 5/16 STUD	13-38 12-10 RING TERM. 3/8 STUD NO-I	13-500 12-10 RING TERM 1/2 STUD	73F-250-32 12-10 FEMALE QUICK SLIDE	

ELECTRICAL



IBS, INCORPORATED

Non-Insulated Connectors Q3A

Non-Insulated Brazed Seam

Beveled mouth facilitates wire insertion. It can be crimped anywhere on the barrel surface. Silver brazed seam will not open under crimping pressure or operating stresses. Unlike butted seam parts, stranded wire cannot escape barrel confines during or after crimping.

RING TERMINALS

IBS No.	Wire	Stud	Qty
14-10SW	#8	#10	10
14-14SW	#8	1/4	10
14-56W	#8	5/16	10
14-38W	#8	3/8	10
15-14SW	#6	1/4	10
15-56W	#6	5/16	10
15-38W	#6	3/8	10
15-500SW	#6	1/2	10
16-10W	#4	#10	10
16-14W	#4	1/4	10
16-56W	#4	5/16	10
16-38W	#4	3/8	10
16-500SW	#4	1/2	10



BUTT CONNECTORS

IBS No.	Wire	Qty
64W	#8	10
65W	#6	10
66W	#4	10



Vinyl Insulated Terminal Assortment (Z02)

Vinyl Insulated Solderless Terminals

IBS No. 201R • 24 Items • 515 Pcs

Packaged in a locking steel drawer for easy storage and organization



Vinyl Insulated Solderless Terminals

Assortment No. 201R

61-P 22-18 BUTT CONN VINYL 	11-6P 22-18 RING TERM #6 STUD VINYL 	11-8P 22-18 RING TERM #8 STUD VINYL 	11-10P 22-18 RING TERM #10 STUD VINYL 	31-10P 22-18 SPADE TERM #10 STUD 	72F-250-32P 16-14 FEMALE QIK SLIDE VINYL
62-P 16-14 BUTT CONN VINYL 	12-6P 16-14 RING TERM #6 STUD VINYL 	12-10-P 16-14 RING TERM 10 STUD VINYL 	12-14SP 16-14 RING TERM 1/4 STUD VINYL 	32-10P 16-14 SPADE TERM 10 STUD VINYL 	72M-250-32P 16-14 MALE QIK SLIDE VINYL
63-P 12-10 BUTT CONN VINYL 	82F-156-NL 16-14 FEMALE SNAP PLUG VINYL 	82M-156P 16-14 MALE SNAP PLUG VINYL 	33-10P 12-10 SPADE TERM #10 STUD 	13-8P 12-10 RING TERM #8 STUD VINYL 	73M-250-32P 12-10 MALE QIK SLIDE VINYL
13-10P 12-10 RING TERM 10 STUD VINYL 	13-14SP 12-10 RING TERM 1/4 STUD VINYL 	13-56P 12-10 RING TERM 5/16 STUD VINYL 	13-38P 12-10 RING TERM 3/8 STUD VINYL 	13-500P 12-10 RING TERM 1/2 STUD VINYL 	73F-250-32P 12-10 FEMALE QIK SLIDE VINYL

ELECTRICAL

IBS, INCORPORATED

Vinyl Insulated Terminals Q3B



Vinyl Insulated Butted Seam Terminals

Used where an insulated barrel is necessary and desirable. Terminal consists of butted part with flared, rigid, molded polyvinyl chloride sleeve securely attached and funneled for easy entry. Wire insulation positions itself against funnel portion of vinyl sleeve this eliminating strand hang-up. Crimping barrel and flared portion of vinyl sleeve provide excellent electrical contact plus mechanical stress relief at junction of insulation and barrel. Insulation has a non-skid ridge for ease of positioning crimping tool. Industry standard color coding indicates wire range. Insulators are rated at a continuous operating temperature range from -40°F to 220°F (-40°C to 105°C). U.L. Listed and CSA Certified for 600 volt building wire and 1000 volt signs and fixtures.

RING TERMINALS



IBS No.	Wire	Stud	Color	Qty
11-6P	22-18	#6	Red	100
11-8P	22-18	#8	Red	100
11-10P	22-18	#10	Red	100
12-6P	16-14	#6	Blue	100
12-8-P	16-14	#8	Blue	100
12-10-P	16-14	#10	Blue	100
12-14SP	16-14	1/4	Blue	100
13-8P	12-10	#8	Yellow	50
13-10P	12-10	#10	Yellow	50
13-14SP	12-10	1/4	Yellow	50
13-56P	12-10	5/16	Yellow	50
13-38P	12-10	3/8	Yellow	50
13-500P	12-10	1/2	Yellow	50

SPADE TERMINALS



IBS No.	Wire	Stud	Color	Qty
31-10P	22-18	#10	Red	100
32-10P	16-14	#10	Blue	100
33-10P	12-10	#10	Yellow	50

BUTT CONNECTORS



IBS No.	Wire	Color	Qty
61-P	22-18	Red	100
62-P	16-14	Blue	100
63-P	12-10	Yellow	100

STEP-BUTT CONNECTORS



IBS No.	Wire	Color	Qty
SB1210-1614	12-10 to 16-14	Yellow w/Blue	100
SB1614-2218	16-14 to 22-18	Blue w/Red	100

QUICKSLIDE TERMINALS



All 1/4" Blade Size

IBS No.	Wire	Type	Color	Qty
72F-250-32P	16-14	Female	Blue	50
72M-250-32P	16-14	Male	Blue	50
73F-250-32P	12-10	Female	Yellow	50
73M-250-32P	12-10	Male	Yellow	50

SNAP PLUGS



IBS No.	Wire	Color	Type	Qty
82F-156-NL	16-14	Blue	Female	100
82M-156P	16-14	Blue	Male	100

ELECTRICAL



IBS, INCORPORATED

Nylon Insulated With Grip Q3C

Nylon Insulated Butted Seam with Insulation Grip

These terminals are used where an insulated barrel and positive insulation grip are necessary or desirable. The terminal consists of a butted seam with a flared seamless brass sleeve securely attached and covered with a flared, molded nylon sleeve. Wire insulation positions itself against funnel portion of brass sleeve. Crimping barrel and flared portion of sleeve provide excellent electrical contact plus mechanical stress relief at junction of insulation and barrel. Positioning crimp tool is nearly mistake-proof due to a "step" in the nylon insulation. Industry standard color coding indicates wire range. Insulators are rated at a continuous operating temperature range from -40°F to 220°F (-40°C to 105°C). U.L. Listed and CSA Certified for 600 volt building wire and 1000 volt signs and fixtures.

Butt Connectors

Seamless

- Economical.
- Nylon Insulated.
- Crimp once on each end.



IBS No.	Wire	Color	Qty
60-SN	24-22	Yellow	100
61-SN	22-18	Red	100
62-SN	16-14	Blue	100
63-SN	12-10	Yellow	50

Insulation Grip

- Nylon Insulated.
- Double crimp to secure wire and insulation.
- Brass sleeve provides optimum grip on insulation to give strain relief and vibration protection.



IBS No.	Wire	Color	Qty
61-NB	22-18	Red	100
62-NB	16-14	Blue	100
63-NB	12-10	Yellow	50

Window

- Military approved according to MIL-T-7928/5.
- Nylon Insulated.
- Insulation grip provides superior strain relief.
- Military approved to withstand the most harsh environments.
- Inspection window guarantees proper wire insertion



IBS No.	MIL Spec	Wire	Color	Qty
61-WB	M7928/5-3	22-18	Red	50
62-WB	M7928/5-4	16-14	Blue	50
63-WB	M7928/5-5	12-10	Yellow	25

Moisture Resistant (NBM)

- Sealant Filled.
- Insulation grip for strain relief and vibration protection.
- Withstands high temperatures, car and truck wash solutions.
- Remains stable over a wide temperature range — accepts fine strand wire down to 0°F.
- Protects against corrosive environments — road chemicals, animal waste, salt spray and exhaust fumes.
- Withstands temperatures of -50°F to 220°F for improved brake and tail light integrity in all weather.
- Double crimp to secure wire and insulation — no heat or chemicals needed.



IBS No.	Wire	Color	Qty
61NBM	22-18	Red	50
62NBM	16-14	Blue	50
63NBM	12-10	Yellow	25

3 & 4-Way Connectors



3-WAY CONNECTORS

IBS No.	Wire	Color	Qty
322NB	22-18	Red	50
316NB	16-14	Blue	25
312NB	12-10	Yellow	25

4-WAY CONNECTORS

IBS No.	Wire	Color	Qty
416NB	16-14	Blue	25



ELECTRICAL

IBS, INCORPORATED

Nylon Insulated With Grip Q3C



Ring Terminals



IBS No.	Wire	Stud	Color	Qty
11-4SNB	22-18	#3-4	Red	100
11-6SNB	22-18	#5-6	Red	100
11-8SNB	22-18	#8	Red	100
11-10NB	22-18	#10	Red	100
11-14SNB	22-18	1/4	Red	100
11-56NB	22-18	5/16	Red	100
11-38NB	22-18	3/8	Red	100
12-4SNB	16-14	#4	Blue	100
12-6SNB	16-14	#6	Blue	100
12-8SNB	16-14	#8	Blue	100
12-10NB	16-14	#10	Blue	100
12-14SNB	16-14	1/4	Blue	100
12-56SNB	16-14	5/16	Blue	100
12-38NB	16-14	3/8	Blue	100
13-6SNB	12-10	#6	Yellow	50
13-8SNB	12-10	#8	Yellow	50
13-10NB	12-10	#10	Yellow	50
13-14SNB	12-10	1/4	Yellow	50
13-56SNB	12-10	5/16	Yellow	50
13-38SNB	12-10	3/8	Yellow	50
13-500NB	12-10	1/2	Yellow	50

Spade Terminals



IBS No.	Wire	Stud	Color	Qty
31-6NB	22-18	#6	Red	100
31-8NB	22-18	#8	Red	100
31-10NB	22-18	#10	Red	100
32-6NB	16-14	#6	Blue	100
32-8NB	16-14	#8	Blue	100
32-10NB	16-14	#10	Blue	100
33-8NB	12-10	#8	Yellow	50
33-10NB	12-10	#10	Yellow	50

Block Spade Terminals



IBS No.	Wire	Stud	Color	Qty
BS-31-6-NB	22-18	#6	Red	100
BS-31-10-NB	22-18	#10	Red	100
BS-32-6-NB	16-14	#6	Blue	100
BS-32-8-NB	16-14	#8	Blue	100
BS-32-10-NB	16-14	#10	Blue	100
BS-33-10-NB	12-10	#10	Yellow	50

Snap Spade Terminals



IBS No.	Wire	Stud	Color	Qty
SS-31-6-NB	22-18	#6	Red	100
SS-31-8-NB	22-18	#8	Red	100
SS-31-10-NB	22-18	#10	Red	100
SS-32-6-NB	16-14	#6	Blue	100
SS-32-8-NB	16-14	#8	Blue	100
SS-32-10-NB	16-14	#10	Blue	100

Hook Terminals



IBS No.	Wire	Stud	Color	Qty
41-6-NB	22-18	#6	Red	100
41-8-NB	22-18	#8	Red	100
42-8-NB	16-14	#8	Blue	100
42-10-NB	16-14	#10	Blue	100
43-10-NB	12-10	#10	Yellow	50

Pin Terminals



IBS No.	Wire	Color	Qty
81P-47-NB	22-18	Red	100
82P-47-NB	16-14	Blue	100
83P-55-NB	12-10	Yellow	25

ELECTRICAL



IBS, INCORPORATED

Nylon Insulated With Grip Q3C

ELECTRICAL

Quick Slides



MALE QUICK SLIDES - FULLY INSULATED
NYLON-INSULATED INSULATION GRIP

IBS No.	Wire	Blade	Color	Qty
71M-187-20-NBL	22-18	3/16	Red	50
71M-250-32-NBL	22-18	1/4	Red	50
72M-187-20-NBL	16-14	3/16	Blue	50
72M-250-32-NBL	16-14	1/4	Blue	50
73M-250-32-NBL	12-10	1/4	Yellow	25

FEMALE QUICK SLIDES - FULLY INSULATED
NYLON-INSULATED INSULATION GRIP

IBS No.	Wire	Blade	Color	Qty
71F-187-20-NBL	22-18	3/16	Red	50
71F-250-32-NBL	22-18	1/4	Red	50
72F-187-20-NBL	16-14	3/16	Blue	50
72F-250-32-NBL	16-14	1/4	Blue	50
73F-250-32-NBL	12-10	1/4	Yellow	25



MALE QUICK SLIDES

IBS No.	Wire	Blade	Color	Qty
71M-187-20-NB	22-18	3/16	Red	50
71M-250-32-NB	22-18	1/4	Red	50
72M-187-20-NB	16-14	3/16	Blue	50
72M-250-32-NB	16-14	1/4	Blue	50
73M-250-32-NB	12-10	1/4	Yellow	25



FEMALE QUICK SLIDES

IBS No.	Wire	Blade	Color	Qty
71F-187-20-NB	22-18	3/16	Red	50
71F-250-32-NB	22-18	1/4	Red	50
72F-187-20-NB	16-14	3/16	Blue	50
72F-250-32-NB	16-14	1/4	Blue	50
73F-250-32-NB	12-10	1/4	Yellow	25

Flag Terminals



FEMALE

IBS No.	Wire	Blade	Color	Qty
71F-250-90-NBL	22-18	1/4	Red	50
72F-250-90-NBL	16-14	1/4	Blue	50

Snap Plugs



MALE SNAP PLUGS

IBS No.	Wire	Blade	Color	Qty
81M-156-NB	22-18	5/32	Red	50
82M-156-NB	16-14	5/32	Blue	50
82M-180-NB	16-14	3/16	Blue	50



FEMALE SNAP PLUGS

IBS No.	Wire	Plug	Color	Qty
81F-156-NBL	22-18	5/32	Red	50
82F-156-NBL	16-14	5/32	Blue	50
82F-180-NBL	16-14	3/16	Blue	50

Multi-Stacks



IBS No.	Wire	Blade	Color	Qty
772-250-NB	16-14	1/4	Blue	50

Closed End Connectors



IBS No.	Wire	Color	Qty
722-N	22-14	Clear	50
718-N	18-10	Clear	100
4066A	#8	Clear	50

IBS, INCORPORATED

Nylon Insulated With Grip Q3C



Nylon Insulated Terminal Assortment (Z02)
Nylon Insulated Double Grip Solderless Terminals
IBS No. 101R • 24 Items • 270 Pcs
Packaged in a locking steel drawer for easy storage and organization



IBS Inc.
 INDUSTRIAL ELECTRIC PRODUCTS
 WWW.IBSINC.COM 800-879-1808

Nylon Insulated Double Grip Solderless Terminal
 Assortment No. 101R

01-SN 22-18 BUTT CONNECTOR	11-68NB 22-18 X #6 RING TERMINAL	11-88NB 22-18 X #8 RING TERMINAL	11-10NB 22-18 X #10 RING TERMINAL	01-10NB 22-18 X #10 SPADE TERMINAL	72F-250-32-NBL 16-14 FEMALE QUICK SLIDE
02-SN 16-14 BUTT CONNECTOR	12-68NB 16-14 X #6 RING TERMINAL	12-10NB 16-14 X #10 RING TERMINAL	12-148NB 16-14 X 1/4" RING TERMINAL	32-10NB 16-14 X #10 SPADE TERMINAL	72M-250-32-NBL 16-14 MALE QUICK SLIDE
03-SN 12-10 BUTT CONNECTOR	82F-156-NBL 16-14 FEMALE BULLET	82M-156-NB 16-14 MALE BULLET	33-10NB 12-10 X #10 SPADE TERMINAL	13-88NB 12-10 X #8 RING TERMINAL	72M-250-32-NBL 12-10 MALE QUICK SLIDE
13-10NB 12-10 X #10 RING TERMINAL	13-148NB 12-10 X 1/4" RING TERMINAL	13-568NB 12-10 X 5/16" RING TERMINAL	13-388NB 12-10 X 3/8" RING TERMINAL	13-508NB 12-10 X 1/2" RING TERMINAL	73F-250-32-NBL 12-10 FEMALE QUICK SLIDE

Red 22-18 Electrical Connectors
IBS No. 400R • 20 Items • 215 Pcs
Packaged in a locking steel drawer for easy storage and organization



IBS Inc.
 INDUSTRIAL ELECTRIC PRODUCTS
 WWW.IBSINC.COM 800-879-1808

Red 22-18 Electrical Connectors
 Assortment No. 400R

01-SN 22-18 BUTT CONN NYLON	01NM 22-18 MOISTURE RESIST BUTT CON	05518 22-18 MULTILINK BUTT CONNECTOR	01-6NB 22-18 SPADE TERM 6 STUD NYLON	01-8NB 22-18 SPADE TERM 8 STUD NYLON	01-10NB 22-18 SPADE TERM 10 STUD NYLON
11-68NB 22-18 RING TERM 6 STUD NYLON	11-88NB 22-18 RING TERM 8 STUD NYLON	11-10NB 22-18 RING TERM 10 STUD NYLON	11-148NB 22-18 RING TERM 1/4 STUD NYLON	11-56NB 22-18 RING TERM. 5/16 STUD NYL	11-38NB 22-18 RING TERM. 3/8 STUD NYLON
81M-156-NB 22-18 MALE SNAP PLUG FULL NY	81F-156-NBL 22-18 FEMALE SNAP PLUG FULL NY	71M-250-32-NBL 22-18 MALE QIK SLIDE FULL	71F-250-32-NBL 22-18 FEMALE QIK SLIDE FULL NY	71M-250-32-NB 22-18 MALE QIK SLIDE NYLON	71F-250-32-NB 22-18 FEMALE QIK SLIDE NYLON
71F-250-90-NBL 22-18 1/4 90DGR F QIK	81P-47-NB 22-18 PIN TERMINAL NYLON				

Blue 16-14 Electrical Connectors
IBS No. 401R • 20 Items • 215 Pcs
Packaged in a locking steel drawer for easy storage and organization



IBS Inc.
 INDUSTRIAL ELECTRIC PRODUCTS
 WWW.IBSINC.COM 800-879-1808

Blue 16-14 Electrical Connectors
 Assortment No. 401R

02-SN 16-14 BUTT CONN NYLON	02NM 16-14 MOISTURE RESIST BUTT CON	05514 16-14 MULTILINK BUTT CONNECTOR	02-6NB 16-14 SPADE TERM 6 STUD NYLON	02-8NB 16-14 SPADE TERM 8 STUD NYLON	02-10NB 16-14 SPADE TERM 10 STUD NYLON
12-68NB 16-14 RING TERM 6 STUD NYLON	12-88NB 16-14 RING TERM 8 STUD NYLON	12-10NB 16-14 RING TERM 10 STUD NYLON	12-148NB 16-14 RING TERM 1/4 STUD NYLON	12-56NB 16-14 RING TERM 5/16 STUD NYLO	12-38NB 16-14 RING TERM 3/8 STUD NYLON
82M-156-NB 16-14 MALE SNAP PLUG NYLON	82F-156-NBL 16-14 FEMALE SNAP PLUG FULL NY	72M-250-32-NBL 16-14 MALE QIK SLIDE FULL	72F-250-32-NBL 16-14 FEMALE QIK SLIDE FULL NY	72M-250-32-NB 16-14 MALE QIK SLIDE NYLON	72F-250-32-NB 16-14 FEMALE QIK SLIDE NYLON
72F-250-90-NBL 16-14 90DGR 1/4 F QIK	82P-47-NB 16-14 PIN TERMINAL NYLON				

Yellow 12-10 Electrical Connectors (Z02)
IBS No. 402R • 16 Items • 175 Pcs
Packaged in a locking steel drawer for easy storage and organization



IBS Inc.
 INDUSTRIAL ELECTRIC PRODUCTS
 WWW.IBSINC.COM 800-879-1808

Yellow 12-10 Electrical Connectors
 Assortment No. 402R

03-SN 12-10 BUTT CONN NYLON	03NM 12-10 MOISTURE RESIST BUTT CON	05510 12-10 MULTILINK BUTT CONNECTOR	03-8NB 12-10 SPADE TERM 8 STUD NYLON	03-10NB 12-10 SPADE TERM 10 STUD NYLON
13-10NB 12-10 RING TERM 10 STUD NYLON	13-148NB 12-10 RING TERM 1/4 STUD NYLON	13-568NB 12-10 RING TERM 5/16 STUD NYLON	13-38NB 12-10 RING TERM 3/8 STUD NYLON	13-50NB 12-10 RING TERM 1/2 STUD NYLON
13-88NB 12-10 RING TERM 8 STUD NYLON	73M-250-32-NBL 12-10 MALE QK SLIDE FULL NYLON	73F-250-32-NBL 12-10 FEMALE QIK SLIDE FULL NY	73M-250-32-NB 12-10 MALE QIK SLIDE NYLON	73F-250-32-NB 12-10 FEMALE QIK SLIDE NYLON
83P-55-NB 12-10 PIN TERMINAL NYLON				

ELECTRICAL



IBS, INCORPORATED

Nylon Insulated Q3C/Vinyl Q3B

Heavy Duty Terminals

- 25% more metal than 12-14 GA.
- Covers three (3) wire sizes including the two most popular — 12 & 14.
- Heavier metal gives vibration-free contact where other terminals may fail.
- Resists cracking and splitting after bending or crimping.
- Provides high insulation heat range — 250° continuous, 350° intermittent.
- Ideal for starters, alternators, generators, etc.



NYLON-INSULATED INSULATION GRIP (NB)

IBS No.	Wire	Stud	Color	Qty
123-10-NB	16-12	#10	Yellow	25
123-14-NB	16-12	1/4	Yellow	25
123-56-NB	16-12	5/16	Yellow	25
123-38-NB	16-12	3/8	Yellow	25
123-500-NB	16-12	1/2	Yellow	25

Heavy Duty Large Gauge Brazed Seam

Silver Brazed to Eliminate Cracking & Splitting

Ring Terminals



IBS No.	Wire	Stud	Color	Qty
14-10S-WN	8 GA	#10	Red	10
14-14S-WN	8 GA	1/4	Red	10
14-56-WN	8 GA	5/16	Red	10
14-38-WN	8 GA	3/8	Red	10
14-500S-WN	8 GA	1/2	Red	10
15-10S-WN	6 GA	#10	Blue	10
15-14S-WN	6 GA	1/4	Blue	10
15-56-WN	6 GA	5/16	Blue	10
15-38-WN	6 GA	3/8	Blue	10
15-500S-WN	6 GA	1/2	Blue	10
16-10-WN	4 GA	#10	Yellow	10
16-14-WN	4 GA	1/4	Yellow	10
16-56-WN	4 GA	5/16	Yellow	10
16-38-WN	4 GA	3/8	Yellow	10
16-500S-WN	4 GA	1/2	Yellow	10

Butt Connectors (Q3B)

Vinyl



BUTT CONNECTORS VINYL (WP)

IBS No.	Wire	Color	Qty
64-WP	8 GA	Red	10
65-WP	6 GA	Blue	10
66-WP	4 GA	Yellow	10

Heavy Duty Wire Ends for #8, #6 & #4 GA Wire Assortment (Z02)

IBS No. 159R • 18 Items • 180 Pcs
Packaged in a locking steel drawer for easy storage and organization

INDUSTRIAL PRODUCTS 148 SAND SPRING RD. HUNTSVILLE, AL 35894-1000

Heavy Duty Wire Ends for #8, #6 & #4 GA Wire

Assortment No. 159R

64-WP #8 BUTT CONNECTOR VINYL	65-WP #6 BUTT CONNECTOR VINYL	66-WP #4 BUTT CONNECTOR VINYL		
16-10-WN #8 RING TERM. 10 STUD NYLON	16-14-WN #6 RING TERM. 1/4 STUD NYLON	16-56-WN #4 RING TERM. 5/16 STUD NYLON	16-38-WN #4 RING TERM. 3/8 STUD NYLON	16-500S-WN #4 RING TERM. 1/2 STUD NYLON
15-10S-WN #6 RING TERM. 10 STUD NYLON	15-14S-WN #6 RING TERM. 1/4 STUD NYLON	15-56-WN #6 RING TERM. 5/16 STUD NYLON	15-38-WN #6 RING TERM. 3/8 STUD NYLON	15-500S-WN #6 RING TERM. 1/2 STUD NYLON
14-10S-WN #8 RING TERM. 10 STUD NYLON	14-14S-WN #8 RING TERM. 1/4 STUD NYLON	14-56-WN #8 RING TERM. 5/16 STUD NYLON	14-38-WN #8 RING TERM. 3/8 STUD NYLON	14-500S-WN #8 RING TERM. 1/2 STUD NYLON

ELECTRICAL

Multilink Connectors Sealed Electrical System

Crimped for Maximum Reliability
Soldered for Strength & Conductivity
Sealed for Superior Durability



MULTILINKS Are the Ultimate Connection WHEN FAILURE IS NOT AN OPTION



THE CRIMP CONNECTOR

- Zippered brazed seam for superior crimp performance.
- Window for visual inspection.
- Wire stop prevents over-insertion.
- Serrated inner barrel for extra crimp strength.



THE SOLDER

- Flux coating to clean metal surfaces.
- Pre-measured solder to deliver the right amount.
- Low-temp solder alloy for ease of installation.



THE HEAT SHRINK TUBING

- Adhesive-lined polyolefin to seal the connection.
- Color-coded with wire gauge imprint for easy size identification.
- Translucent tubing to allow for visual inspection

The Ultimate Connection

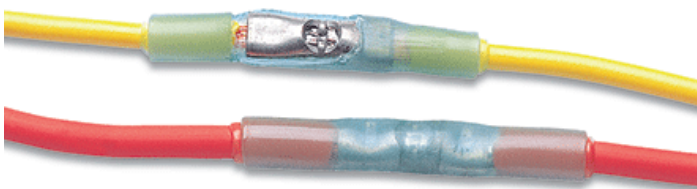

- **High quality, brazed seam crimp connector** provides a secure mechanical connection.
- **Pre-fluxed, low temperature solder** delivers superior current flow and tensile strength.
- **Translucent, adhesive-lined heat shrink tubing** allows for visual inspection and provides a seal against corrosion.
- **Crimped, soldered and sealed connection** meets or exceeds the most stringent OEM standards.

Easy-to-Install



1. Strip the wire to 3/8".
2. Select a connector (match wire gauge) & insert wire into the barrel.
3. Seat wire and crimp using an insulated crimping tool nest that matches the color or gauge of the connector. If placing a butt connector, repeat steps 1-3 for the other side.
4. Apply heat evenly around the length of tubing (including crimp area) from the center out to the ends until the tubing fully recovers and the adhesive flow & solder flows into the center opening.
5. Remove from heat and let cool for **THE ULTIMATE CONNECTION**.



IBS, INCORPORATED

Shrink Terminals Q2B

Multilink Connectors

Butt Connectors with Thermal Indicator

Take the Guesswork Out of Soldering!

- **Red thermal indicator** disappears from solder sleeve when solder has flowed
- **Lead-free solder alloy** has greater surface tension, stronger termination
- **"No-clean" flux** on solder sleeve cleans metals & provides quality solder termination

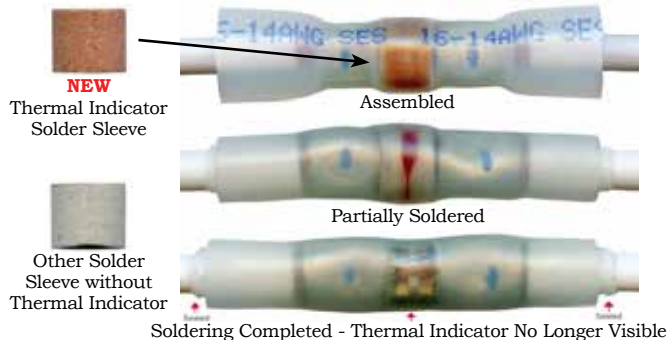

IBS No.	Wire	Color	Qty
BT5520	24-22	Clear	25
BT5518	20-18	Red	50
BT5514	16-14	Blue	50
BT5510	12-10	Yellow	25

Butt Connectors



IBS No.	Wire	Color	Qty
B5520	24-22	Clear	25
B5518	20-18	Red	50
B5514	16-14	Blue	50
B5510	12-10	Yellow	25

Spade Terminals



IBS No.	Wire	Stud	Color	Qty
140978	20-18	#6	Red	25
132147	20-18	#8	Red	25
125713	20-18	#10	Red	25
140979	16-14	#6	Blue	25
140980	16-14	#8	Blue	25
125714	16-14	#10	Blue	25
140981	12-10	#6	Yellow	25
140982	12-10	#8	Yellow	25
125715	12-10	#10	Yellow	25

Step-Butt Connectors



IBS No.	Wire	Color	Qty
B5560	24-22 to 22-18	Pink w / Red Ring	25
B5530	20-18 to 16-14	Blue w / Red Ring	25
B5540	16-14 to 12-10	Yellow w / Blue Ring	25
B5550	8 GA to 12-10	Pink w / Yellow Ring	25

Female Quickslides



IBS No.	Wire	Blade	Color	Qty
125717	20-18	.250	Red	25
125719	16-14	.250	Blue	25
125721	12-10	.250	Yellow	25

Male Quickslides



IBS No.	Wire	Blade	Color	Qty
125716	20-18	.250	Red	25
125718	16-14	.250	Blue	25
125720	12-10	.250	Yellow	25

Ring Terminals



IBS No.	Wire	Stud	Color	Qty
135159	20-18	#6	Red	25
125702	20-18	#8	Red	25
125703	20-18	#10	Red	25
125704	20-18	1/4	Red	25
138835	16-14	#6	Blue	25
125705	16-14	#8	Blue	25
125706	16-14	#10	Blue	25
125707	16-14	1/4	Blue	25
134189	16-14	5/16	Blue	25
125708	16-14	3/8	Blue	25
125709	12-10	#10	Yellow	25
125710	12-10	1/4	Yellow	25
134188	12-10	5/16	Yellow	25
125711	12-10	3/8	Yellow	25
125712	12-10	1/2	Yellow	25

ELECTRICAL



**Multilink Wire Ends
Assortment with Thermal
Indicator Butt Connectors**
IBS No. 859R • 24 Items • 175 Pcs
Packaged in a locking steel drawer for easy
storage and organization



IBS, Inc.		Multilink Wire Ends w/ Thermal Indicator Butt Connectors			
SPECIALTY PRODUCTS FOR PROFESSIONALS & SERVICE INDUSTRIALMULT.COM • 800-878-1936		Assortment No. 859R			
IBS518 20-18 MULTILINK BUTT CONNECTOR WITH THERMAL INDICATOR	IBS530 20-18 TO 16-14 MULTILINK STEP	IBS514 16-14 MULTILINK BUTT CONNECTOR WITH THERMAL INDICATOR	IBS540 16-14 TO 12-10 MULTILINK STEP	IBS510 12-10 MULTILINK BUTT CONNECTOR WITH THERMAL INDICATOR	IBS550 12-10 TO 8GA MULTILINK STEP
128702 20-18 MULTILINK #8 RING TERM	128713 20-18 MULTILINK #10 SPADE TERM	128705 16-14 MULTILINK #8 RING TERM	128714 16-14 MULTILINK #10 SPADE TERM	128709 12-10 MULTILINK #10 RING TERM	128715 12-10 MULTILINK #10 SPADE TERM
128703 20-18 MULTILINK #10 RING TERM	128716 20-18 MULTILINK .250 MALE	128706 16-14 MULTILINK #10 RING TERM	128718 16-14 MULTILINK .250 MALE	128710 12-10 MULTILINK 1/4 RING TERM	128720 12-10 MULTILINK .250 MALE
128704 20-18 MULTILINK 1/4 RING TERM	128717 20-18 MULTILINK .250 FEMALE	128707 16-14 MULTILINK 1/4 RING TERM	128719 16-14 MULTILINK .250 FEMALE	128711 12-10 MULTILINK 3/8 RING TERM	128721 12-10 MULTILINK .250 FEMALE

**Multilink Wire Ends
Assortment**
IBS No. 385R • 24 Items • 175 Pcs
Packaged in a locking steel drawer for easy
storage and organization



IBS, Inc.		Multilink Wire Ends			
SPECIALTY PRODUCTS FOR PROFESSIONALS & SERVICE INDUSTRIALMULT.COM • 800-878-1936		Assortment No. 385R			
IBS518 20-18 MULTILINK BUTT CONNECTOR	IBS530 20-18 TO 16-14 MULTILINK STEP	IBS514 16-14 MULTILINK BUTT CONNECTOR	IBS540 16-14 TO 12-10 MULTILINK STEP	IBS510 12-10 MULTILINK BUTT CONNECTOR	IBS550 12-10 TO 8GA MULTILINK STEP
128702 20-18 MULTILINK #8 RING TERM	128713 20-18 MULTILINK #10 SPADE TERM	128705 16-14 MULTILINK #8 RING TERM	128714 16-14 MULTILINK #10 SPADE TERM	128709 12-10 MULTILINK #10 RING TERM	128715 12-10 MULTILINK #10 SPADE TERM
128703 20-18 MULTILINK #10 RING TERM	128716 20-18 MULTILINK .250 MALE	128706 16-14 MULTILINK #10 RING TERM	128718 16-14 MULTILINK .250 MALE	128710 12-10 MULTILINK 1/4 RING TERM	128720 12-10 MULTILINK .250 MALE
128704 20-18 MULTILINK 1/4 RING TERM	128717 20-18 MULTILINK .250 FEMALE	128707 16-14 MULTILINK 1/4 RING TERM	128719 16-14 MULTILINK .250 FEMALE	128711 12-10 MULTILINK 3/8 RING TERM	128721 12-10 MULTILINK .250 FEMALE

**Multilink Wire Ends
Assortment**
Includes Torch & Butane Refill
IBS No. 324R • 21 Items • 147 Pcs
Packaged in a locking steel drawer for easy
storage and organization



IBS, Inc.		Multilink Wire Ends With Microtorch Butane Torch & Refill Included			
SPECIALTY PRODUCTS FOR PROFESSIONALS & SERVICE INDUSTRIALMULT.COM • 800-878-1936		Assortment No. 324R			
IBS518 20-18 MULTILINK BUTT CONNECTOR	IBS530 20-18 TO 16-14 MULTILINK STEP	128702 20-18 MULTILINK #8 RING TERM	128703 20-18 MULTILINK #10 RING TERM	128713 20-18 MULTILINK #10 SPADE TERM	128738 MICROTORCH BUTANE TORCH
IBS514 16-14 MULTILINK BUTT CONNECTOR	128714 16-14 MULTILINK #10 SPADE TERM	128718 16-14 MULTILINK .250 MALE	128719 16-14 MULTILINK .250 FEMALE	128715 12-10 MULTILINK #10 SPADE TERM	95007 42 GRAM BUTANE REFILL
128705 16-14 MULTILINK #8 RING TERM	128706 16-14 MULTILINK #10 RING TERM	128707 16-14 MULTILINK 1/4 RING TERM	128708 16-14 MULTILINK 3/8 RING TERM	128720 12-10 MULTILINK .250 MALE	
IBS510 12-10 MULTILINK BUTT CONNECTOR	128709 12-10 MULTILINK #10 RING TERM	128710 12-10 MULTILINK 1/4 RING TERM	128711 12-10 MULTILINK 3/8 RING TERM	128721 12-10 MULTILINK .250 FEMALE	

**Multilink Wire Ends
Assortment**
(without Torch & Butane Refill)
IBS No. 314R • 19 Items • 145 Pcs
Packaged in a locking steel drawer for easy
storage and organization



IBS, Inc.		Multilink Wire Ends			
SPECIALTY PRODUCTS FOR PROFESSIONALS & SERVICE INDUSTRIALMULT.COM • 800-878-1936		Assortment No. 314R			
IBS518 20-18 MULTILINK BUTT CONNECTOR	128702 20-18 MULTILINK #8 RING TERM	128703 20-18 MULTILINK #10 RING TERM	128713 20-18 MULTILINK #10 SPADE TERM		
IBS514 16-14 MULTILINK BUTT CONNECTOR	128714 16-14 MULTILINK #10 SPADE TERM	128718 16-14 MULTILINK .250 MALE	128719 16-14 MULTILINK .250 FEMALE	128715 12-10 MULTILINK #10 SPADE TERM	
128705 16-14 MULTILINK #8 RING TERM	128706 16-14 MULTILINK #10 RING TERM	128707 16-14 MULTILINK 1/4 RING TERM	128708 16-14 MULTILINK 3/8 RING TERM	128720 12-10 MULTILINK .250 MALE	
IBS510 12-10 MULTILINK BUTT CONNECTOR	128709 12-10 MULTILINK #10 RING TERM	128710 12-10 MULTILINK 1/4 RING TERM	128711 12-10 MULTILINK 3/8 RING TERM	128721 12-10 MULTILINK .250 FEMALE	

ELECTRICAL



IBS, INCORPORATED

Shrink Terminals Q2B

Solder & Seal Terminals

While Supplies Last

Solder & Seal terminals are radically different from other connectors on the market. In a simple, one-step process, Solder & Seal terminals produce an electrically and environmentally sound connection. The soldering process insures that the resistance, voltage drop, and tensile strength of Solder & Seal terminals will exceed all current standards for wire connector performance. The tough, heat shrinkable tubing has an adhesive lining which provides a complete environmental seal to prevent corrosion and reduce vibration.



Design Features

- **Fluxed solder ring** melts and flows when heated to strengthen the connection, maximize current flow and minimize resistance.
- **Tough, multiple wall tubing** shrinks when heated and delivers above average vibration and tensile strength (700 psi vis 40 psi for a standard nylon splice) which reduces failure due to pull-out under stress.
- **Translucent, adhesive-lined** sleeve melts when heated to create an environmentally sealed connection which reduces failure due to moisture, corrosion, and vibration.
- **Industry standard color-coded sleeve** for quick identification saves time and eliminates costly errors.
- **No expensive crimp tools required** - means perfect connections anywhere.

Butt Connectors



IBS No.	Wire	Color	Qty
B5410	16-14	Blue	25

Ring Terminals



IBS No.	Wire	Stud	Color	Qty
B116-08	20-18	#8	Red	25
B116-10	20-18	#10	Red	25
B116-14	20-18	1/4	Red	25
B114-10	16-14	#10	Blue	25
B114-14	16-14	1/4	Blue	25
B114-38	16-14	3/8	Blue	25
B110-10	12-10	#10	Yellow	25
B110-14	12-10	1/4	Yellow	25
B110-38	12-10	3/8	Yellow	25
B110-12	12-10	1/2	Yellow	25

Quick Slides



MALE QUICK SLIDES - INSULATED SOLDER & SEAL

IBS No.	Wire	Color	Qty
B66-10M	12-10	Yellow	25



FEMALE QUICK SLIDES - INSULATED SOLDER & SEAL

IBS No.	Wire	Color	Qty
B66-18F	22-18	Red	25
B66-10F	12-10	Yellow	25

Spade Terminals



IBS No.	Wire	Stud	Color	Qty
B216-10	20-18	#10	Red	25
B214-10	16-14	#10	Blue	25
B210-10	12-10	#10	Yellow	25

PRODUCT CHARACTERISTICS

Temperature Rating: -65° to 275°F
 Dielectric Strength: 15kV
 Voltage Drop: Less than equal length of wire

Insulation Resistance: 1014 Megohms
Military Specifications
 Tubing: MIL-I-25053/4 Class1, AMS-3634
 Solder: QQ5571E, MIL-S-14256

ELECTRICAL



Crimp & Seal Terminals

Crimp & Seal terminals are all-weather, crimped and heat-sealed connectors suitable for every standard electrical connection. These connectors greatly upgrade the electrical systems of automobiles, boats and machinery by incorporating an adhesive-lined, heat-shrinkable tubing plus the finest metal connectors available. The result is a tough, durable and corrosion-resistant connection.



Clear Tubing
Allows Visual Inspection

Heavy Duty Tubing Provides
Additional Strain Relief

Long Copper Barrel
for Maximum Crimping & Conductivity

Inner Wall Melts to
Create an Environmental Seal When Heated

Standard Color Coding
Indicates Wire Sizes for Easy Identification



Design Features

- **Heavy duty, polyolefin tubing** provides maximum strain relief eliminating failure due to flex.
- **Meltable integral inner-wall lines the tube.** This special adhesive fills any existing voids and creates an environmental seal which repels moisture, and reduces vibration.
- **Electro-tin plated copper terminals** provide maximum conductivity insuring full power along with high corrosion resistance for long life.
- **Heat-shrinkable tubing is pre-shrunk to the terminal** eliminating a time consuming step and insuring that the wire will be sealed off from moisture.
- **Industry standard color coded sleeve** for quick identification saves time and eliminates errors.

Installation



Crimp & Seal terminals are easily crimped with a conventional tool for insulated connections. A hot air gun, or other heat source should be applied to the splice until the tubing recovers and the adhesive flows.

PRODUCT CHARACTERISTICS

Electrical Properties

Temperature Rating: 67° to 255°F
Dielectric Strength: 7.5KV
Voltage Drop: Less than equal length of wire
Insulation Resistance: 10⁶ Megohms

Insulation Properties

Initial Properties Tensile Strength: 7000 psi
Ultimate Elongation: 200%
After Heat Aging Tensile Strength: 700 psi
(168 hr: 315°F/158°C) Ultimate Elongation: 200%
Brittleness Impact No cracking (4 hr. -94°F/-70°C)
Cut-through Resistance 70 lbs.
Abrasion Resistance 700 cycles



IBS, INCORPORATED

Shrink Terminals Q2B

Crimp & Seal Terminals

Butt Connectors



IBS No.	Wire	Color	Qty
B5100	24-22	Clear	50
B5110	20-18	Red	50
B5210	16-14	Blue	50
B5310	12-10	Yellow	25
B5108	8 GA	Pink	25

Step Butt Connectors



IBS No.	Wire	Color	Qty
B5610	20-18 to 16-14	Blue w / Red Stripe	25
B5620	16-14 to 12-10	Yellow w / Blue Stripe	25
B5630	12-10 to 8 GA	Red w / Yellow Stripe	25

Spade Terminals



IBS No.	Wire	Stud	Color	Qty
B5118	20-18	#10	Red	25
B5228	16-14	#10	Blue	25
B5331	12-10	#10	Yellow	25

Snap Plugs



MALE SNAP PLUGS

IBS No.	Wire	Blade	Color	Qty
B5165	20-18	.156	Red	25
B5265	16-14	.156	Blue	25



FEMALE SNAP PLUGS

IBS No.	Wire	Plug	Color	Qty
B5175	20-18	.156	Red	25
B5275	16-14	.156	Blue	25

Ring Terminals



IBS No.	Wire	Stud	Color	Qty
B5112	20-18	#6	Red	25
B5113	20-18	#8	Red	25
B5114	20-18	#10	Red	25
B5115	20-18	1/4	Red	25
B5116	20-18	5/16	Red	25
B5117	20-18	3/8	Red	25
B5222	16-14	#6	Blue	25
B5223	16-14	#8	Blue	25
B5224	16-14	#10	Blue	25
B5225	16-14	1/4	Blue	25
B5226	16-14	5/16	Blue	25
B5227	16-14	3/8	Blue	25
B5323	12-10	#8	Yellow	25
B5324	12-10	#10	Yellow	25
B5325	12-10	1/4	Yellow	25
B5326	12-10	5/16	Yellow	25
B5327	12-10	3/8	Yellow	25
B5328	12-10	1/2	Yellow	25

Quick Slides



MALE QUICK SLIDES - INSULATED

IBS No.	Wire	Blade	Color	Qty
B5155	20-18	.250	Red	25
B5235	16-14	.187	Blue	25
B5255	16-14	.250	Blue	25
B5355	12-10	.250	Yellow	25



FEMALE QUICK SLIDES - FULLY INSULATED

IBS No.	Wire	Blade	Color	Qty
B5145	20-18	.250	Red	25
B5230	16-14	.187	Blue	25
B5245	16-14	.250	Blue	25
B5345	12-10	.250	Yellow	25

ELECTRICAL

IBS, INCORPORATED

Shrink Terminals Q2B



Crimp & Seal Long Neck Terminals

The Ideal Terminal for Heat Shrink Connectors

Standard sealed terminals often end up with a less than optimum seal because there just isn't enough room between the neck and ring to accommodate the shrink tubing and provide a perfect seal to keep out corrosion. Or, the shrink tubing impedes on the stud hole and makes mounting the ring terminal difficult.



Long Neck = Superior Contact Regular Neck = Inferior Contact



Long Neck Crimp & Seal Terminals are re-designed to solve both those issues and features the added benefit of being the ideal terminal for stacking applications.

- Longer neck provides more space for shrink tubing which means a better seal, giving a longer lasting terminal that won't corrode and fail over time.
- Longer neck also means more space for the stud hole to make mounting and attaching the ring terminal easier and giving a much better connection.
- Long neck design also makes for better terminal in stacking applications also providing a better connection and less chance of failure.

IBS No.	Wire	Stud	Color	Qty
136025	22-18	#6	Red	25
136026	22-18	#8	Red	25
136027	22-18	#10	Red	25
136028	14-16	#6	Blue	25
136029	14-16	#8	Blue	25
136030	14-16	#10	Blue	25
136031	14-16	1/4	Blue	25
136032	14-16	5/16	Blue	25
136033	14-16	3/8	Blue	25
136034	12-10	#8	Yellow	25
136035	12-10	#10	Yellow	25
136036	12-10	1/4	Yellow	25
136037	12-10	5/16	Yellow	25
136038	12-10	3/8	Yellow	25

Long Neck Crimp & Seal Terminals Assortment

IBS No. 790R • 14 Items • 140 Pcs
Packaged in a locking steel drawer for easy storage and organization



IBS, Inc.				Crimp & Seal Long Neck Terminals			
Assortment No. 790R							
136025 22-18 CRIMP & SEAL #6 LONG NECK RING	136029 16-14 CRIMP & SEAL #8 LONG NECK RING	136033 16-14 CRIMP & SEAL 3/8 LONG NECK RING	136037 12-10 CRIMP & SEAL 5/16 LONG NECK RING	136026 22-18 CRIMP & SEAL #8 LONG NECK RING	136030 16-14 CRIMP & SEAL #10 LONG NECK RING	136034 12-10 CRIMP & SEAL #8 LONG NECK RING	136038 12-10 CRIMP & SEAL 3/8 LONG NECK RING
136027 22-18 CRIMP & SEAL #10 LONG NECK RING	136031 16-14 CRIMP & SEAL 1/4 LONG NECK RING	136035 12-10 CRIMP & SEAL #10 LONG NECK RING		136028 16-14 CRIMP & SEAL #6 LONG NECK RING	136032 16-14 CRIMP & SEAL 5/16 LONG NECK RING	136036 12-10 CRIMP & SEAL 1/4 LONG NECK RING	

Crimp & Seal Terminals with Long Neck Ring Terminals

IBS No. 791R • 24 Items • 240 Pcs
Packaged in a locking steel drawer for easy storage and organization



IBS, Inc.				Crimp & Seal Wire Ends w/ Long Neck Ring Terminals			
Assortment No. 791R							
B5110 20-18 CRIMP & SEAL BUTT CONNECTOR	B5118 20-18 #10 CRIMP & SEAL SPADE TERM	136028 16-14 #6 CRIMP & SEAL LONG NECK RING	136033 16-14 3/8 CRIMP & SEAL LONG NECK RING	B5310 12-10 CRIMP & SEAL BUTT CONNECTOR	136038 12-10 3/8 CRIMP & SEAL LONG NECK RING		
136025 22-18 #6 CRIMP & SEAL LONG NECK RING	B5155 20-18 CRIMP & SEAL 250 MALE CONN	136029 16-14 #8 CRIMP & SEAL LONG NECK RING	B5228 16-14 CRIMP & SEAL #10 SPADE TERM	136034 12-10 #8 CRIMP & SEAL LONG NECK RING	B5331 12-10 CRIMP & SEAL #10 SPADE TERM		
136026 22-18 #8 CRIMP & SEAL LONG NECK RING	B5145 20-18 CRIMP & SEAL 250 FEMALE CONN	136030 16-14 #10 CRIMP & SEAL LONG NECK RING	B5255 16-14 CRIMP & SEAL 250 MALE CONN	136035 12-10 #10 CRIMP & SEAL LONG NECK RING	B5355 12-10 CRIMP & SEAL 250 MALE CONN		
136027 22-18 #10 CRIMP & SEAL LONG NECK RING	B5210 16-14 CRIMP & SEAL BUTT CONNECTOR	136031 16-14 1/4 CRIMP & SEAL LONG NECK RING	B5245 16-14 CRIMP & SEAL 250 FEMALE CONN	136036 12-10 1/4 CRIMP & SEAL LONG NECK RING	B5345 12-10 CRIMP & SEAL 250 FEMALE CONN		



IBS, INCORPORATED

Assortments Z02

Crimp & Seal Terminals Assortment

Includes Torch & Butane Refill
IBS No. 109R • 21 Items • 315 Pcs
 Packaged in a locking steel drawer for easy storage and organization



IBS, Inc.					Crimp & Seal Terminals w/ Torch & Butane Refill	
INDUSTRIAL PRODUCTS OF THE EAST MANUFACTURING & SERVICE INDUSTRIALBULB.COM P.O. BOX 878-1806					Assortment No. 109R	
			B5233 16-14 CRIMP & SEAL #8 RING TERM	B5234 16-14 CRIMP & SEAL #10 RING TERM	128738 - 95007 MICROTORCH BUTANE TORCH - REFILL	
B5225 16-14 CRIMP & SEAL 1/4 RING TERM	B5228 16-14 CRIMP & SEAL #10 SPADE TERM	B5245 16-14 CRIMP & SEAL .250 FEMALE CONN	B5255 16-14 CRIMP & SEAL .250 MALE CONN	B5265 16-14 CRIMP & SEAL .156 MALE BULLET		
B5275 16-14 CRIMP & SEAL .156 FEMALE BULLET	B5324 12-10 CRIMP & SEAL #10 RING TERM	B5325 12-10 CRIMP & SEAL 1/4 RING TERM	B5327 12-10 CRIMP & SEAL 3/8 RING TERM	B5345 12-10 CRIMP & SEAL .250 FEMALE CONN	B280 22-18 SOLDER&SEAL SHRINK TUBE	
B5355 12-10 CRIMP & SEAL .250 MALE CONN	B5110 20-18 CRIMP & SEAL BUTT CONNECTOR	B5210 16-14 CRIMP & SEAL BUTT CONNECTOR	B5310 12-10 CRIMP & SEAL BUTT CONNECTOR	B5100 22-24 CRIMP & SEAL BUTT CONNECTOR	B281 16-14 SOLDER&SEAL SHRINK TUBE	
					B282 12-10 SOLDER&SEAL SHRINK TUBE	

Crimp & Seal Terminals Assortment

IBS No. 316R • 19 Items • 348 Pcs
 Packaged in a locking steel drawer for easy storage and organization



IBS, Inc.					Crimp-N-Seal Terminals	
INDUSTRIAL PRODUCTS OF THE EAST MANUFACTURING & SERVICE INDUSTRIALBULB.COM P.O. BOX 878-1806					Assortment No. 316R	
			B5233 16-14 CRIMP & SEAL #8 RING TERM	B5234 16-14 CRIMP & SEAL #10 RING TERM	B280 22-18 SOLDER&SEAL SHRINK TUBE	
B5225 16-14 CRIMP & SEAL 1/4 RING TERM	B5228 16-14 CRIMP & SEAL #10 SPADE TERM	B5245 16-14 CRIMP & SEAL .250 FEMALE CONN	B5255 16-14 CRIMP & SEAL .250 MALE CONN	B5265 16-14 CRIMP & SEAL .156 MALE BULLET	B281 16-14 SOLDER&SEAL SHRINK TUBE	
B5275 16-14 CRIMP & SEAL .156 FEMALE BULLET	B5324 12-10 CRIMP & SEAL #10 RING TERM	B5325 12-10 CRIMP & SEAL 1/4 RING TERM	B5327 12-10 CRIMP & SEAL 3/8 RING TERM	B5345 12-10 CRIMP & SEAL .250 FEMALE CONN	B282 12-10 SOLDER&SEAL SHRINK TUBE	
B5355 12-10 CRIMP & SEAL .250 MALE CONN	B5110 20-18 CRIMP & SEAL BUTT CONNECTOR	B5210 16-14 CRIMP & SEAL BUTT CONNECTOR	B5310 12-10 CRIMP & SEAL BUTT CONNECTOR	B5100 24-22 CRIMP & SEAL BUTT CONNECTOR		

Crimp & Seal Terminals Assortment

IBS No. 386R • 24 Items • 240 Pcs
 Packaged in a locking steel drawer for easy storage and organization



IBS, Inc.					Crimp & Seal Wire Ends	
INDUSTRIAL PRODUCTS OF THE EAST MANUFACTURING & SERVICE INDUSTRIALBULB.COM P.O. BOX 878-1806					Assortment No. 386R	
B5110 20-18 CRIMP & SEAL BUTT CONNECTOR	B5115 20-18 CRIMP & SEAL 1/4 RING TERM	B5210 16-14 CRIMP & SEAL BUTT CONNECTOR	B5227 16-14 CRIMP & SEAL 3/8 RING TERM	B5310 12-10 CRIMP & SEAL BUTT CONNECTOR	B5327 12-10 CRIMP & SEAL 3/8 RING TERM	
B5112 20-18 CRIMP & SEAL #6 RING TERM	B5118 20-18 #10 CRIMP & SEAL SPADE TERM	B5223 16-14 CRIMP & SEAL #8 RING TERM	B5228 16-14 CRIMP & SEAL #10 SPADE TERM	B5323 12-10 CRIMP & SEAL #8 RING TERM	B5331 12-10 CRIMP & SEAL #10 SPADE TERM	
B5113 20-18 CRIMP & SEAL #8 RING TERM	B5155 20-18 CRIMP & SEAL .250 MALE CONN	B5224 16-14 CRIMP & SEAL #10 RING TERM	B5255 16-14 CRIMP & SEAL .250 MALE CONN	B5324 12-10 CRIMP & SEAL #10 RING TERM	B5355 12-10 CRIMP & SEAL .250 MALE CONN	
B5114 20-18 CRIMP & SEAL #10 RING TERM	B5145 20-18 CRIMP & SEAL .250 FEMALE CONN	B5225 16-14 CRIMP & SEAL 1/4 RING TERM	B5245 16-14 CRIMP & SEAL .250 FEMALE CONN	B5325 12-10 CRIMP & SEAL 1/4 RING TERM	B5345 12-10 CRIMP & SEAL .250 FEMALE CONN	

ELECTRICAL

HydraLink Connectors

Sealed Connectors for Multiple Wires

HydraLink Inline Butt Connectors

- Connects 1 wire to 2 wires.
- Provides a superior alternative to unsealed quick taps.
- Crimped for positive connectivity.
- Sealed for durability & corrosion resistance.

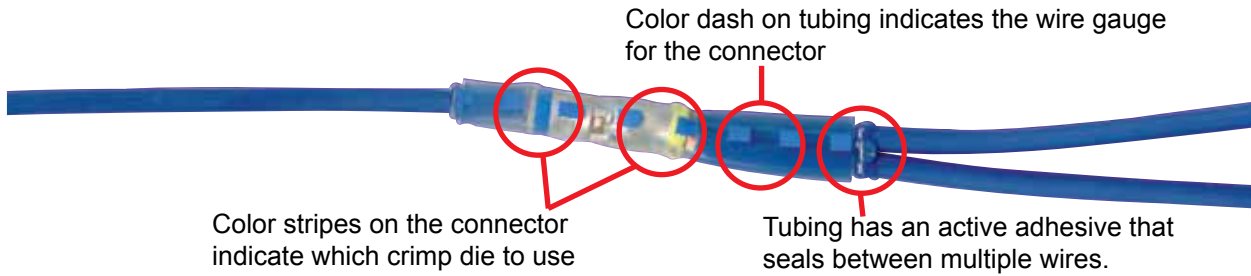

HYDRALINK INLINE BUTT CONNECTORS

	IBS No.	Wire GA	Tubing Color	Color Stripe on Connector	Wire	Crimp Die (Insulated)	Qty
	B5716	20-18 AWG	Clear / Red Dashes	Side 1: Red Side 2: Blue	One: 20-18 Two: 20-18	Red (20-18) Blue (16-14)	15
	B5714	16-14 AWG	Clear / Blue Dashes	Side 1: Blue Side 2: Yellow	One: 16-14 Two: 16-14	Blue (16-14) Yellow (12-10)	15
	B5710	12-10 AWG	Clear / Yellow Dashes	Side 1: Yellow Side 2: Red	One: 12-10 Two: 12-10	Yellow (12-10) Red (8 GA)	15

HydraLink Closed End Connectors

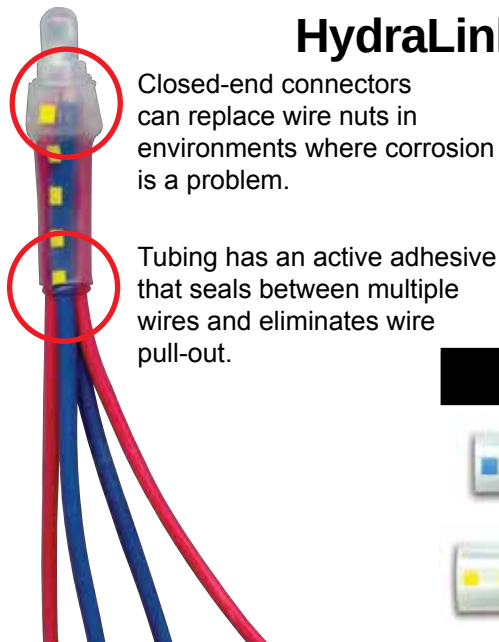

- Connects up to 4 wires.
- Provides a superior alternative to wire nuts.
- Crimped for positive connectivity.
- Adhesive tubing eliminates pull-out.
- Sealed for durability & corrosion resistance.

HYDRALINK CLOSED END CONNECTORS

	IBS No.	Wire	Tubing Color	Qty
	B5814	22-14 AWG	Clear / Blue Dashes	15
	B5810	18-10 AWG	Clear / Yellow Dashes	15



IBS, INCORPORATED





































Assortments Z02

Sealed Wire Connectors II Assortment

IBS No. 761R • 17 Items • 145 Pcs

Packaged in a locking steel drawer for easy storage and organization



 IBS, Inc. <small>SPECIALTY PRODUCTS FOR MAINTENANCE & REPAIR INDUSTRIALBOLT.COM © © © 800-678-1506</small>		Sealed Wire Connectors II			Assortment No. 761R
B5560 26-24 TO 22-18 MULTILINK STEP BUTT CONNECTOR  	B5610 20-18 X 16-14 CRIMP & SEAL STEP BUTT CON  	B5716 20-18 HYDRALINK IN LINE BUTT CONNECTOR  	B5916 22-18 OPTISEAL BUTT CONNECTOR  	61-CS 22-18 COOL-SEAL BUTT CONNECTOR NYLON  	
B5530 20-18 TO 16-14 MULTILINK STEP BUTT CONN  	B5620 16-14 12-10 CRIMP & SEAL STEP BUTT CON  	B5714 16-14 HYDRALINK IN LINE BUTT CONNECTOR  	B5914 16-14 OPTISEAL BUTT CONNECTOR  	62-CS 16-14 COOL-SEAL BUTT CONNECTOR NYLON  	
B5540 16-14 TO 12-10 MULTILINK STEP BUTT CONN  	B5630 12-10 X 8GA CRIMP & SEAL STEP BUTT CONN  	B5710 12-10 HYDRALINK IN LINE BUTT CONNECTOR  	B5910 12-10 OPTISEAL BUTT CONNECTOR  	63-CS 12-10 COOL-SEAL BUTT CONNECTOR NYLON  	
B5550 12-10 TO 8GA MULTILINK STEP BUTT CONN  	B5814 22-14 HYDRALINK CLOSED END CONNECTOR  	B5810 18-10 HYDRALINK CLOSED END CONNECTOR  			

E
L
E
C
T
R
I
C
A
L

Optiseal Terminals

For a Clear and OPTimal View of the Connection

OptiSeal connectors are designed to provide optimal visual assurance of a sealed crimp connection and eliminate mis-crimps. Standard connectors do not allow the installer to see the wire, which can result in the following problems:



- 1) Wire stripped too short — which can result in crimping the end of the wire (poor termination).
- 2) Wire is not fully seated to the connector, which can result in a poor termination.

COLOR CODED TERMINALS

- Ring Terminals have a 45° barrel that assures the wire is seated properly and wire is being crimped to the terminal for optimal connection, saving on timely repairs and failure.
- Longer neck provides more space for shrink tubing which means a better seal, for a longer lasting terminal that won't corrode and fail over time.
- Longer neck also means more space for the stud hole to make mounting and attaching ring terminals easier which provides a much better connection — meaning an optimum electrical connection with no power loss and less chance for corrosion.
- The long neck design also makes for a better terminal in stacking applications also providing a better connection and less chance of failure.
- Color-coded stripes also indicate/guide where to position crimp nest to install properly for the correct connection reducing failure and downtime.
- Brazed seam barrel ensures superior crimp performance for optimum connection saving on timely repairs and failure.
- Serrations in the crimp barrel provide strong mechanical termination for stronger hold reducing the chance of failure or pullout.

Optiseal Ring Terminals



IBS No.	Description	Qty
136040	12-10 OptiSeal Ring #6	25
136001	12-10 Optiseal Ring #8	25
136002	12-10 Optiseal Ring #10	25
136003	12-10 Optiseal Ring 1/4	25
136004	12-10 Optiseal Ring 5/16	25
136005	12-10 Optiseal Ring 3/8	25
136041	12-10 Optiseal Ring 1/2	25
136006	16-14 Optiseal Ring #6	25
136007	16-14 Optiseal Ring #8	25
136008	16-14 Optiseal Ring #10	25
136009	16-14 Optiseal Ring 1/4	25
136010	16-14 Optiseal Ring 5/16	25
136011	16-14 Optiseal Ring 3/8	25
136012	22-18 Optiseal Ring #6	25
136013	22-18 Optiseal Ring #8	25
136014	22-18 Optiseal Ring #10	25
136042	22-18 Optiseal Ring 1/4	25
136043	22-18 Optiseal Ring 5/16	25
136044	22-18 Optiseal Ring 3/8	25

ELECTRICAL

Optiseal Step Butt Connectors



IBS No.	Wire	Code Color	Qty
136015	12-10 to 8GA	Yellow to Red	25
136016	16-14 to 12-10	Blue to Yellow	25
136017	22-18 to 16-14	Red to Blue	25
136018	22-24 to 22-18	White to Red	25

Optiseal Butt Connectors



IBS No.	Wire	Code Color	Qty
B5916	22-18	Red	25
B5914	16-14	Blue	25
B5910	12-10	Yellow	25



IBS, INCORPORATED

Shrink Terminals Q2B

ELECTRICAL

Optiseal Male & Female Connectors

STANDARD LENGTH



IBS No.	Description	Qty
136019	12-10 OptiSeal .250 Female Conn	25
136020	12-10 OptiSeal .250 Male Conn	25
136021	16-14 OptiSeal .250 Female Conn	25
136039	16-14 OptiSeal .250 Male Conn	25
136023	22-18 OptiSeal .250 Female Conn	25
136024	22-18 OptiSeal .250 Male Conn	25

Optiseal Male & Female Connectors

PARTIALLY INSULATED



IBS No.	Description	Qty
136051	12-10 .250 Female Connector Partially Insulated	25
136053	12-10 .250 Male Connector Partially Insulated	25
136054	16-14 .250 Female Connector Partially Insulated	25
136056	16-14 .250 Male Connector Partially Insulated	25
136057	22-18 .250 Female Connector Partially Insulated	25
136059	22-18 .250 Male Connector Partially Insulated	25

Optiseal Female Connector

FULLY INSULATED



IBS No.	Description	Qty
136052	12-10 .250 Female Long Neck Connector — Fully Insulated	25
136055	16-14 .250 Female Long Neck Connector — Fully Insulated	25
136058	22-18 .250 Female Long Neck Connector — Fully Insulated	25

Optiseal Spade Terminals



IBS No.	Description	Qty
136045	12-10 #8-#10 Stud Spade	25
136046	12-10 1/4 Stud Spade	25
136047	16-14 #6 Stud Spade	25
136048	16-14 #8-#10 Stud Spade	25
136049	22-18 #6 Stud Spade	25
136050	22-18 #8-#10 Stud Spade	25

Optiseal Male Bullet Plug Connectors



IBS No.	Description	Qty
136063	12-10 OptiSeal Male Bullet .180 Plug	25
136061	12-10 OptiSeal Male Bullet .157 Plug	25
136067	16-14 OptiSeal Male Bullet .180 Plug	25
136065	16-14 OptiSeal Male Bullet .157 Plug	25
136071	22-18 OptiSeal Male Bullet .180 Plug	25
136069	22-18 OptiSeal Male Bullet .157 Plug	25

Optiseal Female Bullet Receptacle Connectors



IBS No.	Description	Qty
136062	12-10 OptiSeal Female Bullet .180 Recep	25
136060	12-10 OptiSeal Female Bullet .157 Recep	25
136066	16-14 OptiSeal Female Bullet .180 Recep	25
136064	16-14 OptiSeal Female Bullet .157 Recep	25
136070	22-18 OptiSeal Female Bullet .180 Rec	25
136068	22-18 OptiSeal Female Bullet .157 Rec	25

IBS, INCORPORATED

Assortments Z02



OptiSeal Terminals

IBS No. 793R • 24 Items • 220 Pieces

Packaged in a locking steel drawer for easy storage and organization

IBS, Inc. SPECIALTY PRODUCTS FOR MAINTENANCE & REPAIR INDUSTRIALBOLT.COM 800-678-1906						Optiseal Terminals
						Assortment No. 793R
B5916 22-18 OPTISEAL BUTT CONNECTOR 	136017 22-18 TO 16-14 OPTISEAL STEP BUTT 	B5914 16-14 OPTISEAL BUTT CONNECTOR 	136016 16-14 TO 12-10 OPTISEAL STEP BUTT 	B5910 12-10 OPTISEAL BUTT CONNECTOR 	136015 12-10 TO 8GA OPTISEAL STEP BUTT CONNECTOR 	
136018 24-22 TO 22-18 OPTISEAL STEP BUTT 	136014 22-18 #10 OPTISEAL RING TERMINAL 	136007 16-14 #8 OPTISEAL RING TERMINAL 	136011 16-14 3/8 OPTISEAL RING TERMINAL 	136001 12-10 #8 OPTISEAL RING TERMINAL 	136005 12-10 3/8 OPTISEAL RING TERMINAL 	
136012 22-18 #6 OPTISEAL RING TERMINAL 	136023 22-18 .250 FEMALE OPTISEAL CONNECTOR 	136008 16-14 #10 OPTISEAL RING TERMINAL 	136021 16-14 .250 FEMALE OPTISEAL CONNECTOR 	136002 12-10 #10 OPTISEAL RING TERMINAL 	136019 12-10 .250 FEMALE OPTISEAL CONNECTOR 	
136013 22-18 #8 OPTISEAL RING TERMINAL 	136024 22-18 .250 MALE OPTISEAL CONNECTOR 	136009 16-14 1/4 OPTISEAL RING TERMINAL 	136039 16-14 .250 MALE OPTISEAL CONNECTOR 	136003 12-10 1/4 OPTISEAL RING TERMINAL 	136020 12-10 .250 MALE OPTISEAL CONNECTOR 	

Optiseal Terminals & Heat Shrink Kits (Z08)

728R-1 OptiSeal Shrink Tube Kit with Ratcheting Crimper

728R OptiSeal Conn & Shrink Tube Kit Only

Packaged in a locking plastic travel tray for easy storage and organization



OPTISEAL KIT CONTENTS

IBS No.	Description	Qty
B5910	12-10 OPTISEAL Butt Connector	25
B5914	16-14 OPTISEAL Butt Connector	25
B5916	22-18 OPTISEAL Butt Connector	25
B5920	12-10 OPTISEAL Shrink Tube	5
B5924	16-14 OPTISEAL Shrink Tube	10
B5926	22-18 OPTISEAL Shrink Tube	10
Included with 728R-1		
B0050	Ratcheting Crimp Tool	1

ELECTRICAL



IBS, INCORPORATED

Shrink Terminals Q2B

Cool Seal Terminals (Q3C)

Cool Seal terminals are the most innovative and cost-effective sealed electrical connector to hit the market in 25 years. A heat-less, solder-less terminal, it utilizes revolutionary technology that installs in a fraction of the time of comparable heat seal connectors.



E
L
E
C
T
R
I
C
A
L

- Seals out moisture causing corrosion — assuring a better connection and longer life.
- A heat-less / solder-less connection — for ease of use and safety because no flame is required.
- Patented anaerobic technology — adhesive activated when wire is inserted for maximum strength.
- Simply strip and crimp for a fast, economical connection.
- No heat tools required, making it a faster, safer connection.
- Nylon insulation for superior protection and longer life.
- 99.9% ETP copper terminal for maximum connectivity.

BUTT CONNECTORS

IBS No.	Wire	Color	Qty
61-CS	22-18	Red	50
62-CS	16-14	Blue	50
63-CS	12-10	Yellow	25
CS-PACK	1 Pkg of All Three Colors		125

IBS, INCORPORATED

Quick Connectors Q3E



3M Performance Plus Wire Connectors

- **Unique Design:** Accommodates multiple wire combinations.
- **Rounded Wings:** Makes connectors easier to grip.
- **Flexible Skirt:** Covers overstrips for additional safety.
- **3 Connectors in Family:** Covers entire 600V range.

FASTER AND EASIER TO USE

Grips Quicker, Pulls on Faster

The unique spring design grips quickly, turns on fast and expands to accept a wide range of wire sizes. The unique spring design also bites quicker for secure connections every time.

Covers a Wider Range

The larger throat design and extended skirt allow just three connectors to cover the entire 600V range.

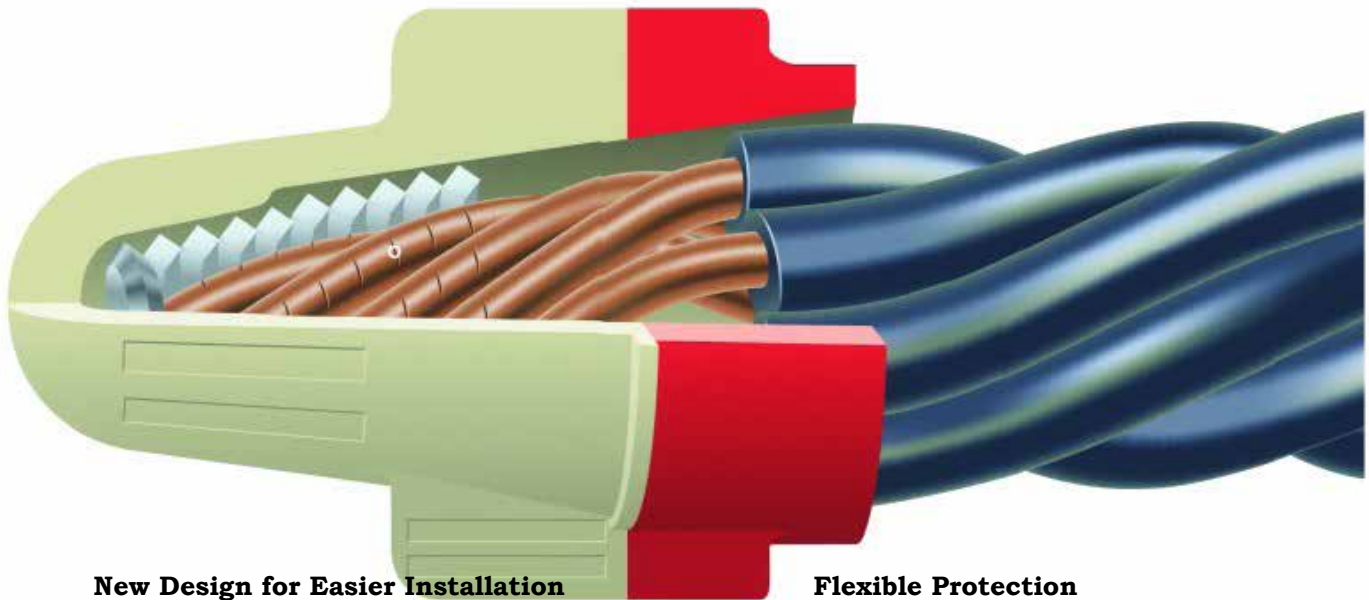

New Design for Easier Installation

A newly modified internal design makes installation smooth, fast and easy on the hands.

Flexible Protection

Long, flexible skirt covers overstrips and protects conductors, but readily bends and conforms to take up less room.

3M PERFORMANCE PLUS WIRE CONNECTORS

	IBS No.	Color	Wire Combination Range		Voltage Rating	Qty
			MIN	MAX		
	973	Orange Blue	2 # 22	2 # 12	600V UL Listed	50
	974	Red Yellow	2 # 18	2 # 8		50
	975	Blue Gray	4 # 14	2 # 6		25

ELECTRICAL



IBS, INCORPORATED

Quick Connectors Q3E

Wall Nuts

Pushwire Connectors for Solid and Stranded Copper Wire

Use with Multiple Wire Gauges



See the Safety:

- Clear housing allows visual confirmation of connection.
- Test port for easy continuity testing.

Fast, Easy Installation:

- No more twisting and taping required.
- Strip the wire, insert the conductor, and you're done!

Safe:

- Each wire is held individually, eliminating loose connections.
- Touch-proof and rated to 105°C.
- UL listed/CSA certified for 600 volts (1000 volts for fixtures and signs) and current rated to the largest conductor used.

Save Time:

- Wall Nuts™ provide up to 50% time savings on installation.
- Secure connections reduce expensive troubleshooting and warranty work.

	IBS No.	Push-In Cond	Strand Copper	Solid Copper	Qty
	773-162	2	12-16 AWG stranded (<19 strands) Strip Length =0.47in	12-18 AWG	100
	773-164	4			100
	773-166	6			100
	773-168	8			50
	773-173	3	10-14 AWG Strip Length =0.47in	10-14 AWG	50

Lever Nut

Pushwire Connector for Solid and Stranded Copper Wire With Locking Lever

Use with Multiple Wire Gauges



Fast, Easy Installation:

- Spring pressure connection technology for a secure and locked connection.
- Built in test port for easy continuity testing.
- No more twisting and taping required.
- Strip the wire, insert the conductor, snap the lever down and you're done!

Safe:

- Each wire is held individually, eliminating loose connections.
- Touch-proof and rated to 105°C.
- UL listed/CSA certified for 600 volts (1000 volts for fixtures and signs).

Save Time:

- Like the Wall Nuts™, Lever Nut provides up to 50% time savings on installation.
- Secure connections reduce expensive troubleshooting and warranty work.

	IBS No.	Push-In Cond	Strand Copper	Solid Copper	Qty
	222-412	2	12-28 AWG Strip Length =0.47in	12-28 AWG Strip Length =0.47in	50
	222-413	3	12-28 AWG Strip Length =0.47in	12-28 AWG Strip Length =0.47in	50
	222-415	5	12-28 AWG Strip Length =0.47in	12-28 AWG Strip Length =0.47in	40

ELECTRICAL

IBS, INCORPORATED

Quick Connectors Q3E



Lever-Nuts

Compact Splicing Connectors for All Wire Types.

Smaller and More User Friendly



See the Safety:

- Clear housing allows visual confirmation of connection.
- Test port for easy continuity testing.

Fast, Easy Installation:





- Connects solid, stranded, and fine-stranded conductors from 24-12 AWG, Inline accepts 20-12 AWG
- Lift the lever up, insert conductor and push lever back down

Safe:

- Each wire is held individually, eliminating loose connections.
- Touch-proof and rated to 105°C.
- UL listed/CSA certified for 600 volts (1000 volts for fixtures and signs) and current rated largest conductor used.

Save Time:

- Tool free connection and disconnection with easy-to-use lever design.

IBS No.	Push-In Cond	Strand Copper	Solid Copper	Qty
 221-2401	2	18-12 AWG Strip Length =0.43in	20-12 AWG Strip Length =0.43in	50
 221-412	2	24-12 AWG Strip Length =0.43in	24-12 AWG Strip Length =0.43in	50
 221-413	3	24-12 AWG Strip Length =0.43in	24-12 AWG Strip Length =0.43in	25
 221-415	5	24-12 AWG Strip Length =0.43in	24-12 AWG Strip Length =0.43in	30

Wall Nuts & Lever Nuts Assortment (Z02)

IBS No. 199R • 13 Items • 106 Pcs

Packaged in a locking steel drawer for easy storage and organization

- Includes crimp tool •

















IBS, Inc.

SPECIALTY PRODUCTS FOR MAINTENANCE & REPAIR
INDUSTRIALBOLT.COM • 800-678-1906

Wall Nuts & Lever Nuts

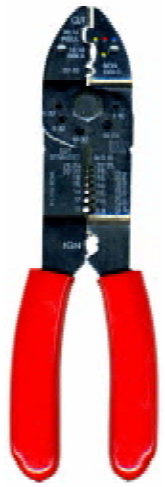
Assortment No. 199R				
<p>773-162 2 WIRE WALL NUT</p> 	<p>773-164 4 WIRE WALL NUT</p> 	<p>773-166 6 WIRE WALL NUT</p> 	<p>773-168 8 WIRE WALL NUT</p> 	<p>773-173 3 WIRE WALL NUT</p> 
<p>222-412 2 WIRE LEVER NUT</p> 	<p>222-413 3 WIRE LEVER NUT</p> 	<p>222-415 5 WIRE LEVER NUT</p> 		
<p>221-2401 INLINE SPlice CLEAR LEVER NUT</p> 	<p>221-412 2 WIRE CLEAR LEVER NUT</p> 	<p>221-413 3 WIRE CLEAR LEVER NUT</p> 	<p>221-415 5 WIRE CLEAR LEVER NUT</p> 	
				<p>TH450 AUTO WIRE CRIMPER/STRIPPER</p> 



IBS, INCORPORATED

Quick Connectors Q3E

Wire Nuts

- Color coded and flame retardant.
- Accepts solid and stranded wire with copper to copper connections.
- Cone shaped spring helps pull the wires into the connector.
- Pre-twisting of wires not required.
- CSA certified and UL listed.

	IBS No.	Color	Wire Combination Range	Voltage Rating	PKG
	6x682	Gray	22 to 14 AWG Min 2 #22 Max 1 #16 w/1 #18	300V	100
	6x683	Blue	22 to 14 AWG Min 2 #22 Max 3 #16	300V	100
	6x684	Orange	22 to 14 AWG Min 2 #18 & 1 #20 Max 2 #14	600V	100
	6x685	Yellow	18 to 12 AWG Min 2 #18 Max 4 #14 & 1 #12	600V	100
	6x686	Red	18 to 6 AWG Min 2 #18 Max 2 #14 & 4 #18	600V	50
	6x687	Yellow Winged	18 to 12 AWG Min 2 #14 Max 4 #14 & 1 #18	600V	50
	6x688	Red Winged	18 to 6 AWG Min 2 #14 Max 4 #12	600V	50
	6x689	Gray	18 to 8 AWG Min 3 #14 w/1 #18 Max 3 #10	600V	25
	6x690	Blue	14 to 6 AWG Min 2 #10 w/1#12 Max 1#8 w/3 #10	600V	25
	6x691	Gold	22 to 8 AWG Min 3 #22 Max 4 #12	600V	50
	6x692	Green	14 to 10 AWG Min 2 #14 Max 5 #10	1000V	50

Instant Auto Connectors

- Electrically connects (tap) wire ends to through (run) wires and insulates the connection.
- No special tools needed — standard pliers easily make the connection.
- No wire stripping, twisting, or soldering necessary.



IBS No.	Color	Wire	Type	Splices	Qty
801	Blue	18-14	Gen. Purp.	tap, inline pigtail	25
902	Brown	18-14	Gen Purp		25
903	Yellow	12-10	Hvy Duty		25
905	Red	22-18	Low Volt		25

Self-Stripping Disconnects

- Easily makes midspan connections without stripping insulation.
- Disconnectable tap leg simplifies hook-up, enhances flexibility.
- Will mate with most .250" male blades.
- Self-stripping connector speeds installation, reduces possible conductor damage and eliminates time consuming mid-span tap.
- Provides a circuit test point.
- Fully insulated feature eliminates second step insulating and improves circuit isolation.
- Installs with pliers — no special tools required.

	IBS No.	Wire	Qty
	952F-250-32-NL	18-14	50
	953F-250-32-NL	12	50

Self-Stripping Pigtail Connector

- Sealant filled to protect against corrosion.
- Installs with pliers - no special tools required.
- One size covers 4 wire ranges 22-14.
- Flame retardant - safe at normal engine temperatures.
- Clear plastic case allows visual inspection.
- Use in a variety of marine and auto applications.

	IBS No.	Wire	Qty
	3M-314	Covers 4 wire ranges: 22-14	25

ELECTRICAL

IBS, INCORPORATED

Quick Connectors Q3E



Wall Nuts, Lever Nuts & Wire Nuts Assortment (Z02)

IBS No. 198R • 15 Items • 256 Pcs

Packaged in a locking steel drawer for easy storage and organization

• Includes crimp tool •





Wire Nuts

Assortment No. 198R

<p>6X682 GRAY WIRE NUTS</p> 	<p>6X683 BLUE WIRE NUT/REPLACES BLK</p> 	<p>6X684 ORANGE WIRE NUTS</p> 	<p>6X685 YELLOW WIRE NUT</p> 	<p>6X686 RED WIRE NUT</p> 	
<p>6X687 YELLOW WIRE NUT WINGED</p> 	<p>6X688 RED WIRE NUT WINGED</p> 	<p>6X689 GRAY WIRE NUT WINGED</p> 	<p>6X690 BLUE WIRE NUT WINGED</p> 	<p>6X691 TAN WIRE NUT WINGED</p> 	
<p>6X692 GREEN GROUNDING WIRE NUT WINGED</p> 					
<p>973 O/B MULTI WIRE NUT</p> 	<p>974 RED/YELLOW MULTI WIRE NUT</p> 	<p>975 BLUE / GRAY MULTI WIRE NUT</p> 			

Wire Nuts Travel Tray (Z02)

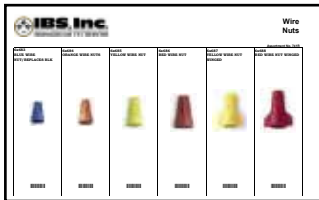

741R Wire Nuts Travel Tray

6 Items • 90 Pcs

Packaged in a clear plastic locking container

IBS No.	Description	Qty
6x683	Blue Wire Nut	20
6x684	Orange Wire Nut	20
6x685	Yellow Wire Nut	15
6x686	Red Wire Nut	15
6x687	Yellow Wire Nut - Winged	10
6x688	Red Wire Nut - Winged	10

Wall & Lever Nut Travel Tray (Z02)

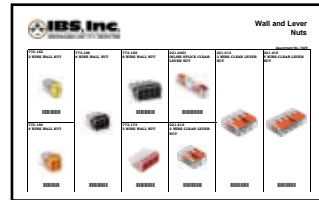

740R Wall & Lever Nut Travel Tray

9 Items • 105 Pcs

Packaged in a clear plastic locking container

IBS No.	Description	Qty
773-162	2 Wire Wall Nut	20
773-164	4 Wire Wall Nut	15
773-166	6 Wire Wall Nut	10
773-168	8 Wire Wall Nut	10
773-173	3 Wire Wall Nut	10
221-2401	Inline Splice Lever Nut	10
221-412	2 Wire Lever Nut	10
221-413	3 Wire Lever Nut	10
221-415	5 Wire Lever Nut	10

ELECTRICAL



IBS, INCORPORATED

Deutsch Connectors & Terminals Q3G

Deutsch Connectors & Terminals

Deutsch connectors and terminals are environmentally sealed electrical connectors for critical applications where moisture, salt spray, dirt or dust could potentially damage electrical connections or systems. Designed for cable to cable applications on engines, transmissions, under the hood or in the cab.

FEATURES & BENEFITS

- A single contact system terminates all connectors by utilizing common tooling and processes, creating an error-free connection.
- Copper crimp-type terminals with a stainless steel sleeve covering the fingers for protection to the fingers and increased performance and long life.
- When properly crimped, terminations provide an air-tight crimp which is highly resistant to increases of electrical resistance caused by oxidation and variations in temperature.
- Pins have no retention tangs and therefore are not subject to damage during assembly and re-work.
- Shells are made of flame-retardant, high-grade thermoplastics for maximum performance.
- No additional sealing required — connectors are sealed when snapped together making assembly time fast and easy.
- Fail-safe connector assembly designed to allow installation only after wedge locks and pins are inserted properly.
- Housings are rated -55°C to +125°C and silicone seals allow the connector to withstand extreme temperature and moisture, making them extremely versatile in a wide range of applications.
- Properly wired and mated connection will withstand immersion under three feet of water without loss of electronic qualities or leakage.
- Positive locking mechanism keeps connectors mated even in extreme vibration.

APPLICATIONS

Agriculture • Construction • Forestry
 Emergency Vehicles • Marine • Military
 Material Handling Lifts • Mining
 Off-Highway • Recreation / Racing
 Truck / Bus

Deutsch Terminals



Socket for Plug Pin for Receptacle Seal Plug

DEUTSCH TERMINALS

IBS No.	Description	Qty
125100	Deutsch 16-18 GA Socket	25
125102	Deutsch 16-18 GA Pin	25
125101	Deutsch 14-16 GA Socket	25
125103	Deutsch 14-16 GA Pin	25
125126	Deutsch Seal Plug	1

Deutsch Connector Tools



125124

125125



125127

IBS No.	Description	Qty
125124	Deutsch Removing Tool	1
125125	Deutsch Crimping Tool	1
125127	Deutsch Economy Crimping Tool	1

ELECTRICAL

IBS, INCORPORATED

Deutsch Connectors & Terminals Q3G



ELECTRICAL

Deutsch 2-Way Connectors

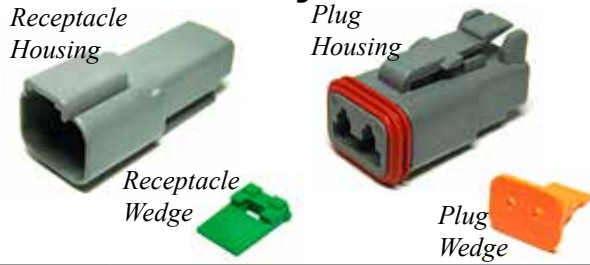

IBS No.	Description	Qty
125104	2-Way Receptacle Housing	5
125114	2-Way Receptacle Wedge	5
125105	2-Way Plug Housing	5
125115	2-Way Plug Wedge	5

Deutsch 6-Way Connectors

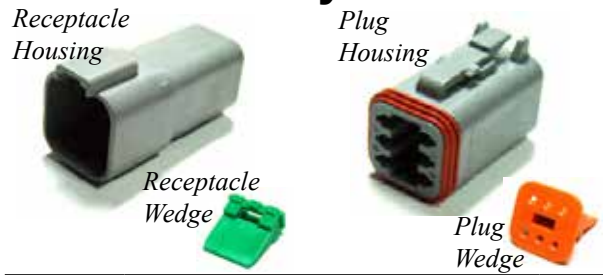

IBS No.	Description	Qty
125110	6-Way Receptacle Housing	5
125120	6-Way Receptacle Wedge	5
125111	6-Way Plug Housing	5
125121	6-Way Plug Wedge	5

Deutsch 3-Way Connectors

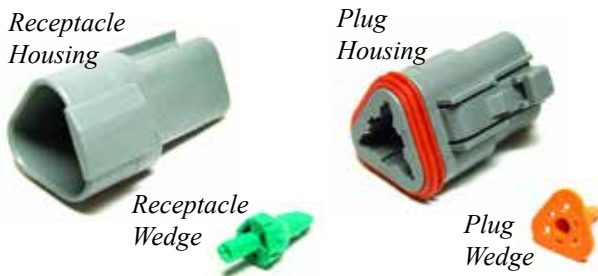

IBS No.	Description	Qty
125106	3-Way Receptacle Housing	5
125116	3-Way Receptacle Wedge	5
125107	3-Way Plug Housing	5
125117	3-Way Plug Wedge	5

Deutsch 8-Way Connectors

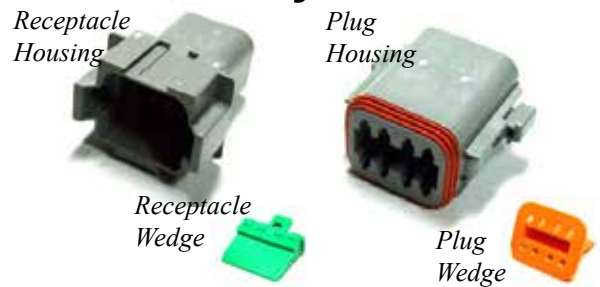

IBS No.	Description	Qty
125112	8-Way Receptacle Housing	5
125122	8-Way Receptacle Wedge	5
125113	8-Way Plug Housing	5
125123	8-Way Plug Wedge	5

Deutsch 4-Way Connectors

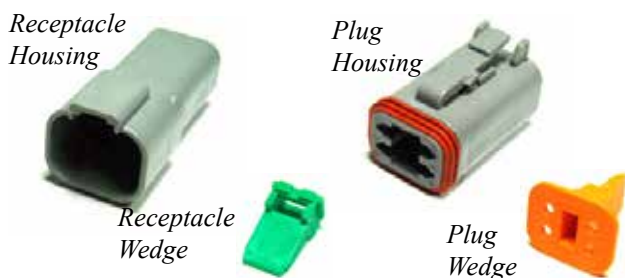

IBS No.	Description	Qty
125108	4-Way Receptacle Housing	5
125118	4-Way Receptacle Wedge	5
125109	4-Way Plug Housing	5
125119	4-Way Plug Wedge	5

Deutsch 12-Way Connectors

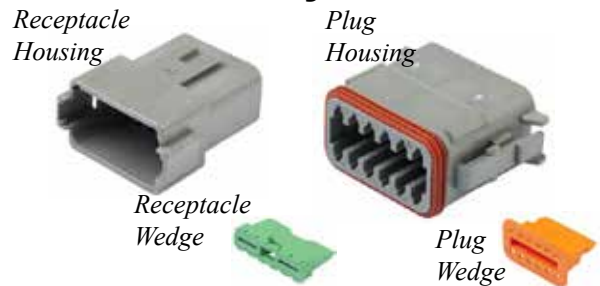

IBS No.	Description	Qty
125130	12-Way Receptacle Housing	5
125140	12-Way Receptacle Wedge	5
125131	12-Way Plug Housing	5
125141	12-Way Plug Wedge	5



IBS, INCORPORATED

DTP Deutsch Connectors

DTP Deutsch Connectors

DEUTSCH environmentally sealed electrical connectors are designed for harsh operating environments and critical applications where dirt, moisture, salt spray, and rough terrain can otherwise contaminate or damage electrical connections.

Deutsch's DTP connectors are the solution for sealed power application requirements. DTP Series connectors offer the proven reliability and quality of Deutsch's DT Series, filling the need for higher amperage. They are environmentally sealed and come in two and four pin arrangements.

The DTP Series offers designers the ability to use multiple size 12 contacts, each with a 25 amp continuous capacity, within a single shell.

FEATURES & BENEFITS

- Accepts contact size 12 (25 amps)
- 10-14 AWG
- 2 and 4 cavity arrangements
- In-line, flange, or PCB mount
- Rectangular, thermoplast housing
- Integrated latch for mating
- Wedgelocks assure contact alignment and retention

DTP 2-Way Connectors



IBS No.	Description	Qty
125152	2-Way Receptacle Housing DTP Series	5
125162	2way Receptacle Wedge DTP Series	5
125153	2way Plug 10-14AWG DTP Series	5
125163	2way Plug Wedge DTP Series	5

DTP 4-Way Connectors



IBS No.	Description	Qty
125154	4way Receptacle Housing DTP Series	5
125164	4-Way Receptacle Wedge DTP Series	5
125155	4-Way Plug Housing DTP Series	5
125165	4-Way Plug Wedge DTP Series	5

DTP TERMINALS

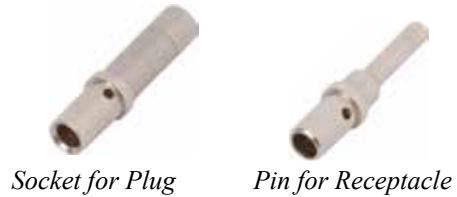

IBS No.	Description	Qty
125151	12-14GA Pin DTP Series	25
125150	12-14GA Socket DTP Series	25

DTP Deutsch Connectors & Tools Assortment
IBS No. 857R • 12 Items • 90 Pcs
Bundled with Crimping & Removal Tools
Packaged in a locking steel drawer for easy storage and organization

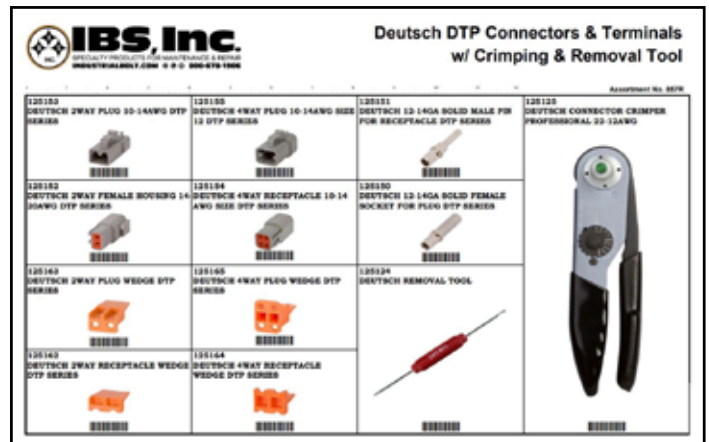

Assortment also available without tools included:

IBS No. 858R • 10 Items • 88 Pcs
Packaged in a locking steel drawer for easy storage and organization
• No tools included •

IBS, INCORPORATED

Assortments Z02



Deutsch DT Connectors & Terminals Assortment

Bundled with Crimping & Removal Tools
IBS No. 768R • 26 Items • 134 Pcs

Packaged in a locking steel drawer for easy storage & organization



IBS Inc. <small>INDUSTRIAL PRODUCTS OF THE WORLD</small> INDUSTRIALPRODUCT.COM © P.O. BOX 878-1808						Deutsch DT Connectors & Terminals with Crimping & Removal Tools
						Assortment No. 768R
125104 DEUTSCH 2WAY RECEPTACLE HOUSING	125106 DEUTSCH 3WAY RECEPTACLE HOUSING	125108 DEUTSCH 4WAY RECEPTACLE HOUSING	125110 DEUTSCH 6WAY RECEPTACLE HOUSING	125112 DEUTSCH 8WAY RECEPTACLE HOUSING	125100 DEUTSCH 16-18GA SOCKET FOR PIN	
125105 DEUTSCH 2WAY PLUG HOUSING	125107 DEUTSCH 3WAY PLUG HOUSING	125109 DEUTSCH 4WAY PLUG HOUSING	125111 DEUTSCH 6WAY PLUG HOUSING	125113 DEUTSCH 8WAY PLUG HOUSING	125102 DEUTSCH 16-18GA PIN FOR RECEPTACLE	
125114 DEUTSCH 2WAY RECEPTACLE WEDGE	125116 DEUTSCH 3WAY RECEPTACLE WEDGE	125118 DEUTSCH 4WAY RECEPTACLE WEDGE	125120 DEUTSCH 6WAY FEMALE WEDGE	125122 DEUTSCH 8WAY FEMALE WEDGE	125101 DEUTSCH 14-16GA SOCKET FOR PLUG	
125115 DEUTSCH 2WAY PLUG WEDGE	125117 DEUTSCH 3WAY PLUG WEDGE	125119 DEUTSCH 4WAY PLUG WEDGE	125121 DEUTSCH 6WAY MALE WEDGE	125123 DEUTSCH 8WAY MALE WEDGE	125103 DEUTSCH 14-16GA PIN FOR RECEPTACLE	

Deutsch DT Connectors & Terminals Assortment

IBS No. 769R • 24 Items • 132 Pcs

Packaged in locking steel drawer for easy storage & organization



IBS Inc. <small>INDUSTRIAL PRODUCTS OF THE WORLD</small> INDUSTRIALPRODUCT.COM © P.O. BOX 878-1808						Deutsch DT Connectors & Terminals
						Assortment No. 769R
125104 DEUTSCH 2WAY RECEPTACLE HOUSING	125106 DEUTSCH 3WAY RECEPTACLE HOUSING	125108 DEUTSCH 4WAY RECEPTACLE HOUSING	125110 DEUTSCH 6WAY RECEPTACLE HOUSING	125112 DEUTSCH 8WAY RECEPTACLE HOUSING	125100 DEUTSCH 16-18GA SOCKET FOR PIN	
125105 DEUTSCH 2WAY PLUG HOUSING	125107 DEUTSCH 3WAY PLUG HOUSING	125109 DEUTSCH 4WAY PLUG HOUSING	125111 DEUTSCH 6WAY PLUG HOUSING	125113 DEUTSCH 8WAY PLUG HOUSING	125102 DEUTSCH 16-18GA PIN FOR RECEPTACLE	
125114 DEUTSCH 2WAY RECEPTACLE WEDGE	125116 DEUTSCH 3WAY RECEPTACLE WEDGE	125118 DEUTSCH 4WAY RECEPTACLE WEDGE	125120 DEUTSCH 6WAY FEMALE WEDGE	125122 DEUTSCH 8WAY FEMALE WEDGE	125101 DEUTSCH 14-16GA SOCKET FOR PLUG	
125115 DEUTSCH 2WAY PLUG WEDGE	125117 DEUTSCH 3WAY PLUG WEDGE	125119 DEUTSCH 4WAY PLUG WEDGE	125121 DEUTSCH 6WAY MALE WEDGE	125123 DEUTSCH 8WAY MALE WEDGE	125103 DEUTSCH 14-16GA PIN FOR RECEPTACLE	

Deutsch DT Connectors & Terminals Assortment II

Bundled with Crimping & Removal Tools
IBS No. 780R • 26 Items • 134 Pcs

Packaged in a locking steel drawer for easy storage & organization



IBS Inc. <small>INDUSTRIAL PRODUCTS OF THE WORLD</small> INDUSTRIALPRODUCT.COM © P.O. BOX 878-1808						Deutsch DT Connectors & Terminals
						Assortment No. 780R
125104 DEUTSCH 2WAY FEMALE HOUSING	125106 DEUTSCH 3WAY FEMALE HOUSING	125108 DEUTSCH 4WAY FEMALE HOUSING	125110 DEUTSCH 6WAY FEMALE HOUSING	125112 DEUTSCH 8WAY FEMALE HOUSING	125100 DEUTSCH 16-18GA FEM TERMINAL	
125105 DEUTSCH 2WAY MALE HOUSING	125107 DEUTSCH 3WAY MALE HOUSING	125109 DEUTSCH 4WAY MALE HOUSING	125111 DEUTSCH 6WAY MALE HOUSING	125113 DEUTSCH 8WAY MALE HOUSING	125102 DEUTSCH 16-18GA MALE TERMINAL	
125114 DEUTSCH 2WAY FEMALE WEDGE	125116 DEUTSCH 3WAY FEMALE WEDGE	125118 DEUTSCH 4WAY FEMALE WEDGE	125120 DEUTSCH 6WAY FEMALE WEDGE	125122 DEUTSCH 8WAY FEMALE WEDGE	125101 DEUTSCH 14-16GA FEM TERMINAL	
125115 DEUTSCH 2WAY MALE WEDGE	125117 DEUTSCH 3WAY MALE WEDGE	125119 DEUTSCH 4WAY MALE WEDGE	125121 DEUTSCH 6WAY MALE WEDGE	125123 DEUTSCH 8WAY MALE WEDGE	125103 DEUTSCH 14-16GA MALE TERMINAL	

ELECTRICAL



IBS, INCORPORATED

Metripack Connectors & Terminals Q3G

Metripack 280 Series Connectors & Terminals

Metripack 280 Series in-line connectors feature high current and current density in a small compact design as well as excellent resistance to temperature, chemicals, and abrasion.

These may be used in under-hood automotive applications as well as most marine, appliance, agricultural and industrial control applications. Designed for 16 volts DC and 30 amps maximum. Metripack 280 Series sealed systems are ideally suited for critical, low-energy applications that require protection from environmental hazards.



Metripack Cable Seals



IBS No.	Description	Qty
125201	Metripack Green 16-20 GA Seal	50
125202	Metripack Gray 14-16 GA Seal	50
125203	Metripack Blue 12-14 GA Seal	50

Metripack 16-18 Terminals



IBS No.	Description	Qty
125212	Metripack 16-18 GA - Male	50
125215	Metripack 16-18 GA - Female	50

Metripack 12-14 Terminals



IBS No.	Description	Qty
125213	Metripack 12-14 GA - Male	50
125216	Metripack 12-14 GA - Female	50

Metripack 1 Connectors



IBS No.	Description	Qty
125204	Metripack 1 Connector - Male	5
125208	Metripack 1 Connector - Female	5
125218	Metripack 1 Contact TPA Black	10

Metripack 2 Connectors



IBS No.	Description	Qty
125205	Metripack 2 Connector - Male	5
125209	Metripack 2 Connector - Female	5
125219	Metripack 2 Contact TPA Blue	10

E
L
E
C
T
R
I
C
A
L

IBS, INCORPORATED

Metripack Connectors & Terminals Q3G



Metripack 3 Connectors



125206



125210



125220



125221

IBS No.	Description	Qty
125206	Metripack 3 Connector - Male	5
125210	Metripack 3 Connector - Female	5
125220	Metripack 3 Contact TPA Male	5
125221	Metripack 3 Contact TPA Female	5

Metripack 5 Connectors



125207



125211



125222



125223

IBS No.	Description	Qty
125207	Metripack 5 Connector - Male	5
125211	Metripack 5 Connector - Female	5
125222	Metripack 5 Contact TPA Male	5
125223	Metripack 5 Contact TPA Female	5

Metripack Cavity Plug



125224

IBS No.	Description	Qty
125224	Metripack Cavity Plug	5

Metripack Crimping Tool



125225

IBS No.	Description	Qty
125225	Metripack Crimping Tool	1

Metripack 22-12GA Crimper



125325

IBS No.	Description	Qty
125325	Weather-Pack 22-12GA Crimper	1

Metripack Terminal Removal Tool



125226

IBS No.	Description	Qty
125226	Metripack Terminal Removal Tool	1

ELECTRICAL



IBS, INCORPORATED

Assortments Z02

Metripack 280 Series Assortment

With Crimping & Removal Tools
 IBS No. 771R • 22 Items • 432 Pieces
 Packaged in a locking steel box for easy storage & organization



IBS, Inc. SPECIALTY PRODUCTS FOR MAINTENANCE & REPAIR INDUSTRIALMARKET.COM © P.O. BOX 878-1908					Metripack 280 Series Electrical Connectors & Tools	
Assortment No. 771R						
125204 METRIPACK 1 PIN MALE CONNECTOR BODY	125208 METRIPACK 1 PIN FEMALE CONNECTOR BODY	125218 METRIPACK 1 PIN T.P.A. MALE & FEMALE	125201 METRIPACK GREEN CABLE SEAL 18-16 & 20-18 GAUGE	125212 METRIPACK 16-18 GAUGE MALE TERMINAL	 	
125205 METRIPACK 2 PIN MALE CONNECTOR BODY	125209 METRIPACK 2 PIN FEMALE CONNECTOR BODY	125219 METRIPACK 2 PIN T.P.A. MALE & FEMALE	125202 METRIPACK GRAY CABLE SEAL 14-16 GAUGE	125215 METRIPACK 16-18 GAUGE FEMALE TERMINAL		
125206 METRIPACK 3 PIN MALE CONNECTOR BODY	125210 METRIPACK 3 PIN FEMALE CONNECTOR BODY	125220 & 125221 METRIPACK 3 PIN T.P.A. MALE AND FEMALE	125203 METRIPACK BLUE CABLE SEAL 12-14 GAUGE	125213 METRIPACK 12-14 GAUGE MALE TERMINAL		
125207 METRIPACK 5 PIN MALE CONNECTOR BODY	125211 METRIPACK 5 PIN FEMALE CONNECTOR BODY	125222 & 125223 METRIPACK 5 PIN T.P.A. MALE AND FEMALE	125224 METRIPACK CAVITY PLUG	125216 METRIPACK 12-14 GAUGE FEMALE TERMINAL		

Metripack 280 Series Assortment

IBS No. 770R • 20 Items • 430 Pieces
 Packaged in a locking steel box for easy storage and organization



IBS, Inc. SPECIALTY PRODUCTS FOR MAINTENANCE & REPAIR INDUSTRIALMARKET.COM © P.O. BOX 878-1908					Metripack 280 Series Electrical Connectors	
Assortment No. 770R						
125204 METRIPACK 1 PIN MALE CONNECTOR BODY	125208 METRIPACK 1 PIN FEMALE CONNECTOR BODY	125218 METRIPACK 1 PIN T.P.A. MALE & FEMALE	125201 METRIPACK GREEN CABLE SEAL 18-16 & 20-18 GAUGE	125212 METRIPACK 16-18 GAUGE MALE TERMINAL	 	
125205 METRIPACK 2 PIN MALE CONNECTOR BODY	125209 METRIPACK 2 PIN FEMALE CONNECTOR BODY	125219 METRIPACK 2 PIN T.P.A. MALE & FEMALE	125202 METRIPACK GRAY CABLE SEAL 14-16 GAUGE	125215 METRIPACK 16-18 GAUGE FEMALE TERMINAL		
125206 METRIPACK 3 PIN MALE CONNECTOR BODY	125210 METRIPACK 3 PIN FEMALE CONNECTOR BODY	125220 & 125221 METRIPACK 3 PIN T.P.A. MALE AND FEMALE	125203 METRIPACK BLUE CABLE SEAL 12-14 GAUGE	125213 METRIPACK 12-14 GAUGE MALE TERMINAL		
125207 METRIPACK 5 PIN MALE CONNECTOR BODY	125211 METRIPACK 5 PIN FEMALE CONNECTOR BODY	125222 & 125223 METRIPACK 5 PIN T.P.A. MALE AND FEMALE	125224 METRIPACK CAVITY PLUG	125216 METRIPACK 12-14 GAUGE FEMALE TERMINAL		

Metripack 280 Series Assortment II

With Crimping & Removal Tools
 IBS No. 781R • 22 Items • 432 Pieces
 Packaged in a locking steel box for easy storage & organization



IBS, Inc. SPECIALTY PRODUCTS FOR MAINTENANCE & REPAIR INDUSTRIALMARKET.COM © P.O. BOX 878-1908					Metripack 280 Series Electrical Connectors & Tools	
Assortment No. 781R						
125204 METRIPACK 1 PIN MALE CONNECTOR BODY	125208 METRIPACK 1 PIN FEMALE CONNECTOR BODY	125218 METRIPACK 1 PIN T.P.A. MALE & FEMALE	125201 METRIPACK GREEN CABLE SEAL 18-16 & 20-18 GAUGE	125212 METRIPACK 16-18 GAUGE MALE TERMINAL	 	
125205 METRIPACK 2 PIN MALE CONNECTOR BODY	125209 METRIPACK 2 PIN FEMALE CONNECTOR BODY	125219 METRIPACK 2 PIN T.P.A. MALE & FEMALE	125202 METRIPACK GRAY CABLE SEAL 14-16 GAUGE	125215 METRIPACK 16-18 GAUGE FEMALE TERMINAL		
125206 METRIPACK 3 PIN MALE CONNECTOR BODY	125210 METRIPACK 3 PIN FEMALE CONNECTOR BODY	125220 & 125221 METRIPACK 3 PIN T.P.A. MALE AND FEMALE	125203 METRIPACK BLUE CABLE SEAL 12-14 GAUGE	125213 METRIPACK 12-14 GAUGE MALE TERMINAL		
125207 METRIPACK 5 PIN MALE CONNECTOR BODY	125211 METRIPACK 5 PIN FEMALE CONNECTOR BODY	125222 & 125223 METRIPACK 5 PIN T.P.A. MALE AND FEMALE	125224 METRIPACK CAVITY PLUG	125216 METRIPACK 12-14 GAUGE FEMALE TERMINAL		

ELECTRICAL

IBS, INCORPORATED

Weatherpack Connectors & Terminals Q3G



Weatherpack Connectors & Terminals



- **An environmentally-sealed electrical connection system**, utilizing a pin-and-socket configuration – designed to withstand exposure to extreme temperatures, moisture, harsh engine compartment vapors and chemicals with outstanding reliability
- **For 12V systems – 20A maximum** - Voltage rating: 0.05 to 16.0 volts
- **Pin and sleeve configuration** to alleviate stress relaxation
- **Secondary lock and Connector Position Assurance (CPA)** for improved system design
- **Dual-locking tangs on terminals** help prevent backing out
- **Terminal plugging** requires no orientation and positive locking indexing prevents mismatching of connectors
- **Weather-Pack seals are made of a self lubricating silicone and are multi-ribbed** to prevent moisture and other contaminants from entering the connector and causing terminal corrosion.

Weatherpack Cable Seals



125201



125202



125203

IBS No.	Description	Qty
125201	Weatherpack Green 16-20 GA Seal	50
125202	Weatherpack Gray 14-16 GA Seal	50
125203	Weatherpack Blue 12-14 GA Seal	50

Weatherpack Cavity Plug



125224

IBS No.	Description	Qty
125224	Weatherpack Cavity Plug	25

Weatherpack 1 Connectors



125306



125307

IBS No.	Description	Qty
125306	Weatherpack 1 Tower Female	5
125307	Weatherpack 1 Shroud Male	5

Weatherpack 2 Connectors



125308



125309

IBS No.	Description	Qty
125308	Weatherpack 2 Tower Female	5
125309	Weatherpack 2 Shroud Male	5

ELECTRICAL



IBS, INCORPORATED

Weatherpack Connectors & Terminals Q3G

ELECTRICAL

Weatherpack 3 Connectors



125310



125311

IBS No.	Description	Qty
125310	Weatherpack 3 Tower Female	5
125311	Weatherpack 3 Shroud Male	5

Weatherpack 4 Connectors



125312



125313

IBS No.	Description	Qty
125312	Weatherpack 4 Tower Female	5
125313	Weatherpack 4 Shroud Male	5

Weatherpack 6 Connectors



125314



125315

IBS No.	Description	Qty
125314	Weatherpack 6 Tower Female	5
125315	Weatherpack 6 Shroud Male	5

Weatherpack 20-18 GA Terminals



125300



125301

IBS No.	Description	Qty
125301	Weatherpack 20-18 GA Female	50
125300	Weatherpack 20-18 GA Male	50

Weatherpack 16-14 GA Terminals



125302



125303

IBS No.	Description	Qty
125303	Weatherpack 16-14 GA Female	50
125302	Weatherpack 16-14 GA Male	50

Weatherpack 12 GA Terminals



125304



125305

IBS No.	Description	Qty
125305	Weatherpack 12 GA Female	25
125304	Weatherpack 12 GA Male	25

Weatherpack 22-12GA Crimper



125325

IBS No.	Description	Qty
125325	Weather-Pack 22-12GA Crimper	1

Weatherpack Terminal Extractor Tool



125326

IBS No.	Description	Qty
125326	Weather-Pack Terminal Extractor	1



IBS, INCORPORATED

Tapes & Sealants Q1D

E
L
E
C
T
R
I
C
A
L

Scotch® Brand 88 Electrical Tape

88 Vinyl Plastic Electrical Tape
for Cold Weather Resistance

- Extra thickness provides added electrical properties, quicker installation buildup and abrasion resistance.
- Flame retardant.
- Hot and cold weather resistant.
- Resists UV rays, abrasion, moisture, alkalis acids and corrosion.
- Meets requirements of ASTMD-3005 Type I, UL510, MIL-I-24391 and CSA C22.2.
- Temperature Range: -18°C/0°F to +105°C/220°F.



IBS No.	MIL Thick	Color	Length	Qty
3M6143	8.5	Black	3/4" x 66'	1

Scotch Brand 33+ Electrical Tape

33+ Vinyl Plastic Professional Grade
Electrical Tape

- Use as a primary insulation for wire cable splices up to 600 volts and for fixture and wire splices up to 1kV.
- Flame retardant.
- Hot and cold weather resistant.
- Resists UV rays, abrasion, moisture, alkalis acids and corrosion.
- Meets requirements of ASTMD-3005 Type I, UL510, HHI-595C and CSA C22.2.
- Temperature Range: -18°C/0°F to +105°C/220°F.



IBS No.	MIL Thick	Color	Length	Qty
3M6133	7.0	Black	3/4" x 76'	1

Super Black Vinyl Electrical Tape

Vinyl Plastic Electrical Tape
for Cold Weather Resistance
3M SUPER 88 EQUIVALENT

- 8.5 mil (0.21mm) all weather, professional grade, pressure sensitive vinyl tape that provides heavier thickness for added mechanical & electrical protection.
- Flame retardant.
- Cold and weather resistant.
- Can be used for splices at not more than 600 Volts.
- Resists UV rays, abrasion, moisture, alkalis acids and corrosion.
- Meets requirements of ASTMD-3005 Type I, UL510, and MIL-I-24391.



IBS No.	MIL Thick	Color	Length	Qty
6143	8.5	Black	3/4" x 66'	1

Premium+ Black Vinyl Electrical Tape

7.0 MM Vinyl Plastic Professional Grade
Electrical Tape

3M 33+ EQUIVALENT

- Use as a primary insulation for wire cable splices up to 600 volts and for fixture and wire splices up to 1kV.
- Flame retardant.
- Hot and cold weather resistant.
- Resists UV rays, abrasion, moisture, alkalis acids and corrosion.
- Meets requirements of ASTMD-3005 Type I, UL510, HHI-595C and CSA C22.2.
- Temperature Range: -18°C/0°F to +105°C/220°F.



IBS No.	MIL Thick	Color	Length	Qty
6132	7	Black	3/4" x 66'	1

IBS, INCORPORATED

Tapes & Sealants Q1D



Colored Electrical Tape

Just like our standard electrical tape, this PVC electrical tape has excellent elongation and creep back characteristics for tighter, more permanent wraps. No adhesion transfer assures consistent sealing. Suitable for use up to 600 Volts and a maximum temperature of 176°F (80°C).

Each roll measures 3/4" x 60 ft.



IBS No.	Color	Length	Qty
N9010	Black	3/4" x 60'	10
145237	Blue	3/4" x 60'	5
145238	Green	3/4" x 60'	5
145239	White	3/4" x 60'	5
145240	Brown	3/4" x 60'	5
145241	Orange	3/4" x 60'	5
145242	Yellow	3/4" x 60'	5
145243	Gray	3/4" x 60'	5
145244	Red	3/4" x 60'	5

Black Liquid Electrical Tape

This product has thousands of uses in a variety of environments. Anytime electrical wires are exposed, this product is the perfect solution. Liquid electrical tape provides a totally sealed joint which is flexible and fire resistant. UV, water and most chemicals will not affect a joint sealed with Liquid Electrical Tape. Dries to the touch in about 10 minutes and fully cures in 24 hours.

- Forms a protective, waterproof, UV-resistant dielectric coating.
- Prevents corrosion on wires and terminals.
- Patented, UL tested, fast-drying formula.



IBS No.	Description	Qty
105124	Black Liquid Electrical Tape 4 oz.	1

Electrical Tape Assortment

IBS No. 711R • 11 Items • 20 Pcs

Packaged in a locking steel drawer for easy storage and organization



Electrical Tape

Assortment No. 711R

<p>145237 3/4 X 60FT BLUE ELECTRICAL TAPE</p>	<p>145238 3/4 X 60FT GREEN ELECTRICAL TAPE</p>	<p>145239 3/4 X 60FT WHITE ELECTRICAL TAPE</p>	<p>B9211 1' X 30' FUSION TAPE</p>
<p>145240 3/4 X 60FT BROWN ELECTRICAL TAPE</p>	<p>145241 3/4 X 60FT ORANGE ELECTRICAL TAPE</p>	<p>145242 3/4 X 60FT YELLOW ELECTRICAL TAPE</p>	<p>B9201 SILICONE TAPE - RED</p>
<p>145243 3/4 X 60FT GRAY ELECTRICAL TAPE</p>	<p>145244 3/4 X 60FT RED ELECTRICAL TAPE</p>	<p>N9010 3/4 X 60YD PVC ELECTRICAL</p>	

ELECTRICAL



IBS, INCORPORATED

Assortments (Z02)

Silicone Sealing Tape

Self-fusing tape cures without heat to form a solid rubber insulator. It has a minimum dielectric strength of 400 volts/mil. (.020" thick). It has a continuous operating temperature range from -60° to +200°C with intermittent up to +260°C. It has a minimum tensile strength of 700 psi and a tear resistance of 85 psi. It also has a 300% minimum ultimate elongation. It replaces shrink tape and can be used where shrink tubing would be impractical. Its ease of application and removability make it a versatile choice for insulating and weather-proofing.



IBS No.	Color	Width	Length	Qty
B9201	Red	1"	36 ft.	1
B9202	Black	1"	36 ft.	1
B9204	Gray	1"	36 ft.	1
B9205	Clear	1"	36 ft.	1
B9206	Red	2"	10 ft.	1
B9207	Black	2"	10 ft.	1
B9208	Gray	2"	10 ft.	1
B9209	Clear	2"	10 ft.	1

Fusion Tape

Fusion Tape is used by everyone from OEM manufacturers to contractors in most any industry; automotive, heavy duty, marine, utilities, and plant maintenance.



Seals pipes, hoses and wires as it insulates and bundles.

Fusion Tape is:

- A positive sealing cold shrink tape — requires no heat, which means no special tools are needed, and can be used to replace shrink tube.
- Temperature range is -40°F to 100°F continuous and 130°F intermittent — for all weather use.
- Has no sticky sides, and adheres only to itself — which makes it much easier to use than some shrink tubing.
- Withstands harsh cleaning chemicals and steam — for longer life.
- Has a 5 year shelf life — so you don't have to be concerned with it going bad prior to use.
- Cures to a tight, yet flexible waterproof bond — the benefit is that even where the seal is being flexed, the bond will hold.
- Begins to fuse in minutes, cures in a few hours and continues to constrict for 24 hours.
- Has a liner, a true fusing tape that won't start working until stretched.

IBS No.	Description	Qty
B9211	Fusion Tape 1" x 30'	1

Silicone Sealing Tape Assortment

IBS No. 743R • 8 Items • 8 Pcs

Packaged in a locking steel drawer for easy storage and organization

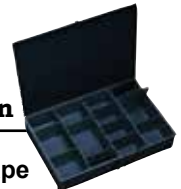

Silicone Sealing Tape

Assortment No. 743R

<p style="font-size: x-small;">B9201 TAPE SILICONE RED 1" X 36'</p>	<p style="font-size: x-small;">B9202 TAPE SILICONE BLACK 1" X 36'</p>	<p style="font-size: x-small;">B9204 TAPE SILICONE GRAY 1" X 36'</p>	<p style="font-size: x-small;">B9205 TAPE SILICONE CLEAR 1" X 36'</p>
<p style="font-size: x-small;">B9206 TAPE SILICONE RED 2" X 10'</p>	<p style="font-size: x-small;">B9207 TAPE SILICONE BLACK 2" X 10'</p>	<p style="font-size: x-small;">B9208 TAPE SILICONE GRAY 2" X 10'</p>	<p style="font-size: x-small;">B9209 TAPE SILICONE CLEAR 2" X 10'</p>

Sealing Compound

Consisting of a tough, all-weather grade elastic vinyl backing and a self-fusing, rubber-based insulating mastic, this sealing compound is designed to withstand bleach, water, steam, saltwater spray, oils, chemicals, hydraulic fluid, liquid detergent, JP-4, horse urine, and many more.

- Applies & seals quickly and easily.
- Rugged PVC backing resists abrasion, wear and tear.
- Can be applied from 0° to 100°F.
- Rated at 176°F continuous operation.
- Resists ultraviolet (sun) light.
- Is compatible with all thermoplastic and rubber wire insulation.
- Provides strain relief by taking pressure off connectors.
- Protects against vibration "shake-loose."
- Seals and insulates most connections: bolted, crimped or screw-type connectors, terminals, and self-stripping connectors.
- Seals and protects in all automotive applications including livestock carriers.



IBS No.	Description	Qty
6147	Roll 2-1/2" x 10 ft.	1
6149	Pre-Cut Patches 2-1/2 sq (25)	1

Teflon Tape

- Teflon thread sealing tape
- Chemically inert, withstands alkalis, acids, oils and solvents.
- Can be used on iron, stainless steel, copper, brass, plastic, glass or rubber pipes.



IBS No.	Description	Qty
UT-11	Teflon Tape 1/2" x 520"	1

Blue Painter's Tape

- Ideal for long term masking projects when tape must be left on for up to a week or more.
- Removes cleanly and easily for up to 14 days without leaving adhesive residue.
- Can also be used on most previously painted surfaces, including painted wallboard and even glass and metal.
- UV Resistant; can be used in direct sunlight.
- Adhesion level: medium.
- Compatible with water-based, and solvent based coatings; not compatible with lacquer coatings or surfaces.
- Can be used on interior or exterior jobs.



IBS No.	Length	Qty
145333	1" x 60 yd	1
145335	2" x 60 yd	1

Masking Tape

- An all-purpose, standard grade masking tape with excellent properties for most applications.
- Protects surfaces from unwanted paint.
- Easily peeled.
- Light bundling.



IBS No.	Description	Qty
UT77-1	Masking Tape 1" x 60 yds.	1
UT77-2	Masking Tape 2" x 60 yds.	1

Duct Tape

- Contractors Grip — 11.0mm thick.
- Multi-purpose, polyethylene coated cloth, waterproof tape.
- Seals against loss of heated and cooled air.
- Conforms to irregular surfaces.



IBS No.	Description	Qty
UT-102	Duct Tape 2" x 60 yds (2160 in.)	1



IBS, INCORPORATED

Cross-Link Wire Q06

Heavy Duty Wire (Cross-Linked) — 100 Ft Spools

This general purpose wire is used where superior resistance to the elements, abrasion, and where extremes in temperature, both high and low, are encountered. Heavy duty cross-linked wire has a flexible, bare annealed copper conductor which is insulated with a special polyethylene base. Chemically cross-linked polyethylene is a compound which is vulcanized to obtain a thermoplastic wire insulation. A thermosetting insulation doesn't melt when exposed to heat after the vulcanization process. Our chemically cross-linked polyethylene features toughness combined with outstanding heat resistance. Meets SAEJ1128.

Voltage: Rated at **60VDC/25VAC** or less. Temperature: Rated at **-40°F (-40°C)** to **257°F (125°C)**.

ELECTRICAL

	Color	22 GA	20 GA	18 GA	16 GA	14 GA	12 GA	10 GA
	BLACK	82301	82201	82183	82163	82141	82121	81103
	WHITE	82307	82207	82187	82167	82142	82122	81107
	RED	82303	82203	82181	82161	82143	82123	81101
	YELLOW	82302	82202	82182	82162	82144	82124	81102
	GREEN	82304	82204	82184	82164	82145	82125	81104
	BLUE	82305	82205	82185	82165	82146	82126	81105
	BROWN	82306	82206	82186	82166	82147	82127	81106
	ORANGE			82188	82168	82148		
	PURPLE					82149		

Wire Sold by Spools in Quantities of One

Heavy Duty (Cross-Linked) Primary Wire Assortments (Z08)

4 Bar Wire Rack Assortment

IBS No. 341R • 16 (100 ft) spools



	Color	14 GA	12 GA	10 GA
	BLACK	82141 Qty: 1	82121 Qty: 1	81103 Qty: 1
	WHITE	82142 Qty: 1	82122 Qty: 1	
	RED	82143 Qty: 1	82123 Qty: 1	81101 Qty: 1
	YELLOW	82144 Qty: 1		
	GREEN	82145 Qty: 1	82125 Qty: 1	
	BLUE	82146 Qty: 1	82126 Qty: 1	
	BROWN	82147 Qty: 1	82127 Qty: 1	
	PURPLE	82149 Qty: 1		

Arranged on a 4 bar wire rack - separates wire by ga

2 Bar Wire Rack Assortment (Z02)

IBS No. 860R • 11 (100 ft) spools



	Color	14 GA	12 GA	10 GA
	BLACK	82141 Qty: 1	82121 Qty: 1	81103 Qty: 1
	WHITE	82142 Qty: 1		
	RED	82143 Qty: 1	82123 Qty: 1	81101 Qty: 1
	YELLOW	82144 Qty: 1		
	GREEN	82145 Qty: 1		
	BLUE	82146 Qty: 1		
	BROWN	82147 Qty: 1		

Arranged on a 2 bar wire rack - separates wire by ga

IBS, INCORPORATED

Primary Wire Q05



General Purpose Thermoplastic — 100 Ft. Spools

Single conductor copper stranded primary wire with the highest quality poly-vinyl chloride insulation providing the best in flexibility, permanent color and resistance to acids, grease oil and diesel fumes. Primary wire is manufactured to meet all SAE type GPT specifications and will work safely between the operating temperatures of -20°F and +165°F.

Voltage: Rated at 60V or less. Temperature: Rated at -40°F (-40°C) to 176°F (80°C).

	Color	20 GA	18 GA	16 GA	14 GA	12 GA	10 GA	8 GA
	BLACK	81203S	81183S	81163S	81143S	81123S	81103S	81083A
	WHITE	81207S	81187S	81167S	81147S	81127S	81107S	
	RED	81201S	81181S	81161S	81141S	81121S	81101S	81081A
	YELLOW	81202S	81182S	81162S	81142S	81122S	81102S	
	GREEN	81204S	81184S	81164S	81144S	81124S	81104S	
	BLUE	81205S	81185S	81165S	81145S	81125S	81105S	
	BROWN	81206S	81186S	81166S	81146S	81126S	81106S	
	ORANGE		81188S	81168S	81148S			
	PURPLE		81189S	81169S	81149S			

Primary Wire Sold by Spools in Quantities of One

General Purpose Primary Wire Assortments (Z08)

4 Bar Wire Rack Assortment

IBS No. 134R • 16 (100 ft) spools



	Color	16 GA	14 GA	12 GA	10 GA
	BLACK	81163S Qty: 1	81143S Qty: 1	81123S Qty: 1	81103S Qty: 1
	WHITE		81147S Qty: 1	81127S Qty: 1	
	RED	81161S Qty: 1	81141S Qty: 1	81121S Qty: 1	81101S Qty: 1
	GREEN		81144S Qty: 1	81124S Qty: 1	
	BLUE		81145S Qty: 1	81125S Qty: 1	
	BROWN		81146S Qty: 1	81126S Qty: 1	

Arranged on a 4 bar wire rack - separates wire by ga

2 Bar Wire Rack Assortment (Z02)

IBS No. 302R • 11 (100 ft) spools



	Color	14 GA	12 GA	10 GA
	BLACK	81143S Qty: 1	81123S Qty: 1	81103S Qty: 1
	WHITE	81147S Qty: 1		
	RED	81141S Qty: 1	81121S Qty: 1	81101S Qty: 1
	YELLOW	81142S Qty: 1		
	GREEN	81144S Qty: 1		
	BLUE	81145S Qty: 1		
	BROWN	81146S Qty: 1		

Arranged on a 2 bar wire rack - separates wire by ga

ELECTRICAL



IBS, INCORPORATED

Conducting Wire & Cable Q07

E
L
E
C
T
R
I
C
A
L

Trailer Cable

This general purpose, thermoplastic wire has the same wire construction as the parallel multiple conductor and has an overall grey colored, tough Typhayzel® jacket for additional protection against moisture and abrasion. The conductor is made up of 2 - 14GA wires. Colors are white and black.



MULTIPLE CONDUCTOR

IBS No.	GA	Description	Qty
8150S	12/6	Black, Red, Brown, Yellow Green & Blue - 100 ft spool	1
	10/1	White	
8157S	14/7	Red, Green, Brown, White, Black, Yellow, Blue 100 ft spool	1
8152S	14/4	Black, White, Red, Brown 100 ft spool	1
8151S	14/6	Red, Green, Brown, White, Black & Yellow - 100 ft spool	1
8155S	16/6	Red, Green, Brown, White, Black & Yellow - 100 ft spool	1

Jacketed Multiple Conductor

This general purpose, thermoplastic wire has the same wire construction as the parallel multiple conductor and has an overall grey colored, tough Typhayzel® jacket for additional protection against moisture and abrasion. The conductor is made up of 2 - 14GA wires. Colors are white and black.



IBS No.	GA	Description	Qty
8131S	12/2	Black & White 100 ft spool	1
8132S	14/2	Black & White 100 ft spool	1
8133S	16/2	Black & White 100 ft spool	1
8134S	18/2	Black & White 100 ft spool	1

Parallel Multiple Conductor

This general purpose, thermoplastic wire meets the same conditions as primary wire. The conductors are bonded together to simplify circuit identification and termination. This allows for faster, more convenient installation where two or more conductors are required. It is made up of 3 - 14GA conductors. Colors are yellow, green and brown.

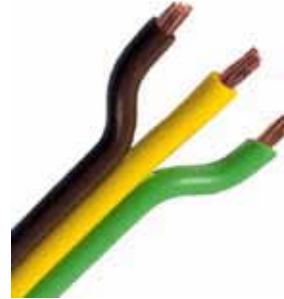

IBS No.	GA	Description	Qty
8140S	14/3	Yellow, Green & Brown - 100 ft spool	1

Clear Speaker Wire

Teledyne AWD speaker wire has a flat, parallel, flexible construction, SPT style, for easy split separation. The two copper conductors, one bar and one tinned, are protected with transparent, extruded, thermoplastic jacket which provides visible wire identification and positive polarity.



IBS No.	GA	Description	Qty
81000	18/2	100 ft spool	1



IBS Battery / Welding Cable

Type TPR (FT1) Rubber Polymer

6 AWG - 4/0 AWG • 600 Volts • -49°C to 105°C

Features

- Remains flexible even at - 49°C
- Extra flexible class K stranding
- - 49°C to 105°C, 600 Volt rating
- Jacketing compound passes UL WV1 Flame Test
- Resistant to oil, water, acid, gas, ozone, cuts, tears, and abrasion
- Made in the U.S.A.

Applications

Designed for heavy duty welding applications where extreme cold weather flexibility and resistance to cuts, tears, abrasion and welding sledge is required.



Construction

Conductor

- Bare, annealed electrolyte copper
- 30 AWG Class K rope lay stranding

Dual Insulated Jacketing Technology



An inner insulator of the same high quality compound in high contrast color is applied between the conductor and outer sheath for added safety. This provides: increased insulation, added flexibility, and allows the user to easily identify damage or wear.

Additionally, this eliminates corrosion inherent to paper separators found in cables of lesser quality, which extends the product's life and improves performance.

Outer Jacket

A proprietary rubber polymer (FT1) provides exceptional oil, water, acid, gas and ozone resistance.



- Is flame retardant.
- MSHA low smoke compliant.
- Durable, and extremely flexible at all operating temperatures.

IBS No.	Cable GA	Color	Stranding	AMP Rating	Terminal Color	Length	Qty
16498	6 GA	Black	266 x 30	80	Gray	25'	1
16499	6 GA	Red	266 x 30	80	Gray	25'	1
16500	4 GA	Black	420 x 30	120	Gray	25'	1
165001	4 GA	Red	420 x 30	120	Gray	25'	1
16501	2 GA	Black	665 x 30	240	Green	25'	1
165011	2 GA	Red	665 x 30	240	Green	25'	1
16502	1 GA	Black	833 x 30	300	Pink	25'	1
165022	1 GA	Red	833 x 30	300	Pink	25'	1
16503	1/0 GA	Black	1045 x 30	360	Black	25'	1
165033	1/0 GA	Red	1045 x 30	360	Black	25'	1
16504	2/0 GA	Black	1330 x 30	450	Orange	25'	1
165044	2/0 GA	Red	1330 x 30	450	Orange	25'	1
16506	3/0 GA	Black	1691 x 30	540	Purple	10'	1
165066	3/0 GA	Red	1691 x 30	540	Purple	10'	1
16508	4/0 GA	Black	2109 x 30	640	Yellow	10'	1
165088	4/0 GA	Red	2109 x 30	640	Yellow	10'	1

ELECTRICAL



IBS, INCORPORATED

Shrink Tubing Q2A

6 to 1 Hi-Ratio Heat Shrink Tubing

- Extremely versatile 6:1 shrink ratio can accommodate a wide variety of connector shapes and configurations.
- Rigid heavy wall and thermoplastic adhesive lining provides a gas, water, and environmental seal for the toughest applications.
- Dielectric strength of 500 volts/mil.
- Tough and durable to provide exceptional insulation and abrasion protection.
- Flame retardant material meets MIL-I-23053/15A Specs.



IBS No.	Pre-Shrunk ID	Post-Shrunk ID	Wire Range	MAX Wall Thickness	Length	Color	Qty
B3315	3/4	.125	14 - 1 GA	.123	12"	Black	1
B3317	1-3/4	.29	2 - 750 MCM	.140	12"	Black	1
B3319	2-3/4	.46	3/0 - 1200 MCM	.190	12"	Black	1
B3320	3-1/2	.673	500 - 1300 MCM	.170	12"	Black	1

Heavy Wall Heat Shrink Tubing

- Heavy wall polyolefin material assures superior abrasion protection and strain relief.
- Mastic-lined inner wall forms a weatherproof seal when heated to prevent failure due to corrosion and vibration.
- 3 to 1 shrink ratio means fewer part numbers to cover a variety of cable sizes resulting in less inventory.

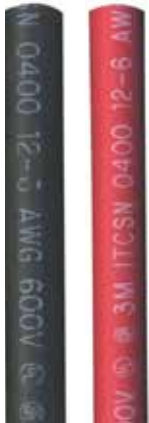

IBS No.	Pre-Shrunk ID	Post-Shrunk ID	Wire Size	Color	Length	MAX Wall	Qty
B3501	.40	.150	12-6	Black	6"	.09	5
B3502	.40	.150	12-6	Red	6"	.09	5
B3503	.80	.20	8-1/0	Black	6"	.11	5
B3404	.80	.20	8-1/0	Red	6"	.11	5
B3505	1.10	.37	2-4/0	Black	6"	.12	5
B3405	1.10	.37	2-4/0	Red	6"	.12	5
B3605	1.5	.50	4/0-400	Black	12"	.17	1
B3601	2.0	.65	500-1000 MCM	Black	12"	.17	1
B3620	.80	.20	8-1	Black	48"	.11	1
B3630	1.10	.37	2-4/0	Black	48"	.12	1

Heavy Wall Heat Shrink Tubing Assortment II (Z08)

IBS No. 295P • 12 Items • 86 Pcs

Packaged in a locking steel drawer for easy storage and organization



IBS, Inc. INDUSTRIAL SOLUTIONS • P.O. BOX 870 • ST. LOUIS, MO 63108		Heavy Wall Shrink Tubing II	
Assortment No. 295P			
B3505 2-4/0GA X 6" BLACK HVY		B3405 2-4/0GA X 6" RED HVY WALL	
B3503 8-1/0GA X 6" BLACK HEAVY SHRINK TUBE		B3404 8-1/0 GA X 6" RED HEAVY SHRINK TUBE	
B3501 12-6GA X 6" BLACK HVY SHRINK		B3502 12-6GA X 6" RED HVY SHRINK	
B3508 8-2GA X 6" CLEAR SHRINK TUBE		B282 12-10 SOLDER&SEAL SHRINK TUBE	
B3507 14-8GA X 6" CLEAR SHRINK TUBE		B281 16-14 SOLDER&SEAL SHRINK TUBE	
B3506 18-12GA X 6" CLEAR SHRINK		B280 22-18 SOLDER&SEAL SHRINK TUBE	

IBS, INCORPORATED

Shrink Tubing Q2A



Automotive Dual Wall Heat Shrink Tubing

This polyolefin tubing can be used for sealing splices and terminals. In addition to weather-proofing your connection, it also provides strain relief and vibration resistance. An excellent alternative to heavy wall tubing in light duty applications. Ideal for automotive computer wiring and applications where vibration, moisture, or friction are present and may cause failure.

- **Double Wall Construction** creates a strong, durable connection that insulates to reduce failure due to vibration.
- **Heavy Duty** polyolefin material resists wear and assures superior abrasion protection and strain relief.
- **Inner wall** is lined with mastic that breaks down when heated to form a weatherproof seal against moisture, eliminating failure due to corrosion.

DUAL WALL SHRINK TUBING — CLEAR

IBS No.	Pre-Shrunk ID	Post-Shrunk ID	Wire Size	MAX Wall	Color	Length	Qty
B3506	1/4	.08	18-10	.040	Clear	6"	10
B3507	3/8	.12	14-8	.055	Clear	6"	10
B3508	1/2	.16	8-4	.070	Clear	6"	10
B3300	1/8	.04	30-18	.040	Clear	12"	10
B3301	3/16	.062	20-14	.040	Clear	12"	10
B3302	1/4	.08	18-10	.040	Clear	12"	10

- **Clear Outer Wall** allows for visual inspection before and after installation for fewer mistakes and less rework.

DUAL WALL SHRINK TUBING — BLACK & RED

IBS No. Red	IBS No. Black	Pre-Shrunk ID	Post-Shrunk ID	Wire Size	MAX Wall	Length	Qty
16480	16485	1/8	.040	30-18	.040	6"	8
16481	16486	3/16	.062	20-14	.040	6"	8
16482	16487	1/4	.080	18-10	.040	6"	8
16483	16488	3/8	.120	14-8	.055	6"	8
16484	16489	1/2	.160	8-4	.070	6"	8
16492	16490	3/4	.250	4-2/0	.085	6"	8
16493	16491	1	.320	2-4/0	.100	6"	8

Automotive Dual Wall Heat Shrink Tubing Assortment

IBS No. 800R • 12 Items • 72 Pcs

Packaged in a locking steel drawer for easy storage and organization



Dual Wall Shrink Tubing

Assortment No. 800R

<p style="font-size: x-small;">16486 3/16 X 6IN BLACK DUAL WALL SHRINK TUBE</p>	<p style="font-size: x-small;">16481 3/16 X 6IN RED DUAL WALL SHRINK TUBE</p>
<p style="font-size: x-small;">16487 1/4 X 6IN BLACK DUAL WALL SHRINK TUBE</p>	<p style="font-size: x-small;">16482 1/4 X 6IN RED DUAL WALL SHRINK TUBE</p>
<p style="font-size: x-small;">16488 3/8 X 6IN BLACK DUAL WALL SHRINK TUBE</p>	<p style="font-size: x-small;">16483 3/8 X 6IN RED DUAL WALL SHRINK TUBE</p>
<p style="font-size: x-small;">16489 1/2 X 6IN BLACK DUAL WALL SHRINK TUBE</p>	<p style="font-size: x-small;">16484 1/2 X 6IN RED DUAL WALL SHRINK TUBE</p>
<p style="font-size: x-small;">16490 3/4 X 6IN BLACK DUAL WALL SHRINK TUBE</p>	<p style="font-size: x-small;">16492 3/4 X 6IN RED DUAL WALL SHRINK TUBE</p>
<p style="font-size: x-small;">16491 1IN X 6IN BLACK DUAL WALL SHRINK TUBE</p>	<p style="font-size: x-small;">16493 1IN X 6IN RED DUAL WALL SHRINK TUBE</p>



IBS, INCORPORATED

Shrink Tubing Q2A

High Adhesive Flow Heat Shrink Tubing

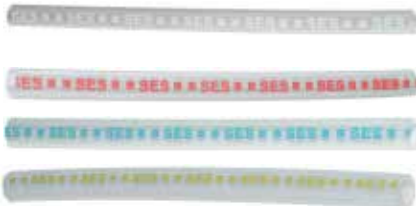

- Excellent for sealing multiple wires.
- Puncture resistant
- Provides superior strain relief.
- Clear with color coded lines

IBS No.	Pre-Shrunk ID	Post-Shrunk ID	Wire Size	MAX Wall	Color	Length	Qty
B3310	.220	.045	24-12	.057	White Dash	12"	5
B3311	.300	.060	22-10	.061	Red Dash	12"	5
B3312	.350	.080	16-8	.071	Blue Dash	12"	5
B3313	.450	.105	14-4	.096	Yellow Dash	12"	5

Heavy Wall Heat Shrink Tubing Assortment (Z02)

IBS No. 338R • 6 Items • 30 Pcs

Packaged in a locking steel drawer for easy storage and organization











IBS, Inc.

SPECIALTY PRODUCTS FOR MAINTENANCE & REPAIR
INDUSTRIALBOLT.COM © © © 800-678-1906

Automotive Shrink Tubing

12" Cut Lengths

Assortment No. 338R

B3313 14-4AWG HI FLOW ADHESIVE	
B3312 16-8AWG HI FLOW ADHESIVE	
B3311 22-10AWG HI FLOW ADHESIVE	
B3310 24-12AWG HI FLOW ADHESIVE	
B3301 3/16 X 12" CLEAR DUAL WALL	
B3300 1/8 X 12" CLEAR DUAL WALL	

ELECTRICAL

IBS, INCORPORATED

Shrink Tubing Q2A



Color Coded Dual Wall Shrink Tubing

- **Tinted for color coding and is also translucent** to view underlying material.
- **Wire gauge imprint for ease of identification** before and after installation.
- **Adhesive lining** provides a barrier against contaminants.



IBS No.	Pre-Shrunk ID	Post-Shrunk ID	Wire Size	MAX Wall	Color	Length	Qty
B279	.115	.028	24-22	.06	Clear	6"	10
B280	.245	.045	22-18	.06	Red	6"	10
B281	.245	.080	16-14	.06	Blue	6"	10
B282	.360	.100	12*10	.06	Yellow	6"	10

Automotive Shrink Tubing Assortment (Z02)

Includes Torch

IBS No. 297R • 9 Items • 55 Pcs



















Packaged in a locking steel drawer for easy storage and organization



IBS, Inc.
SPECIALTY PRODUCTS FOR MAINTENANCE & REPAIR
INDUSTRIALBOLT.COM © © © 800-678-1906



Automotive Shrink Tubing
With MicroTorch Butane Torch Included
Assortment No. 297R

<p>B281 16-14 SOLDER&SEAL SHRINK TUBE</p>  	<p>B282 12-10 SOLDER/SEAL SHRINK TUBE</p>  
<p>B280 22-18 SOLDER&SEAL SHRINK TUBE</p>  	<p>B279 24-22 SOLDER/SEAL SHRINK TUBE</p>  
<p>B3507 14-8GA X 6 CLEAR SHRINK TUBE"</p>  	<p>B3508 8-2GA X 6 CLEAR SHRINK TUBE"</p>  
<p>B3302 1/4 X 12 CLEAR DUAL WALL"</p>  	
<p>B3301 3/16 X 12 CLEAR DUAL WALL"</p>  	
<p>B3300 1/8 X 12 CLEAR DUAL WALL"</p>  	

ELECTRICAL



IBS, INCORPORATED

Shrink Tubing Q2A

Optiseal Adhesive-Lined Heat Shrink Tubing

- Provides optimal clarity for visual inspection.
- Adhesive-lined tubing ensures a waterproof seal.
- Wire gauge imprint simplifies wire size identification.

SPECIFICATIONS

Material: Cross-linked ionic polymer

Shrink Ratio: Exceeds 2.5 to 1

Shrink/Recovery Temperature: 90°C (194°F)

Continuous Operating Temp: -55°C to 125°C

Flammability: Passed (FMVSS 302 test)

Tensile Strength: 4,000 psi

Longitudinal Change: +1/-10% Max

Dielectric Strength: 750 V/Mil (30KV/MM)



IBS No.	Pre-Shrunk ID	Post-Shrunk ID	Wire Size	Color	Length	Qty
B5926	.176	.045	22-18	Clear	6"	10
B5924	.250	.080	16-14	Clear	6"	10
B5920	.365	.100	12-10	Clear	6"	10

Optiseal Butt Connectors & Shrink Tubing (Z02)

Includes Torch

IBS No. 728R • 6 Items • 100 Pcs

Packaged in a locking plastic Travel Tray for easy storage and organization



Optiseal Butt Connector & Shrink Tubing

Assortment No. 728R

<p>B5916 22-18 OPTISEAL BUTT CONNECTOR</p> 	<p>B5914 16-14 OPTISEAL BUTT CONNECTOR</p> 	<p>B5910 12-10 OPTISEAL BUTT CONNECTOR</p> 	<p>B5926 22-18 OPTISEAL HEAT SHRINK TUBING .260 X 6"</p> 	<p>B5924 16-14 OPTISEAL HEAT SHRINK TUBING .260 X 6"</p> 	<p>B5920 12-10 OPTISEAL HEAT SHRINK TUBING .375 X 6"</p> 
---	---	---	---	---	---

ELECTRICAL

Thin Wall Heat Shrink Tubing — 48" Lengths

- Flexible polyolefin single wall tubing — will not crack or split.
- Withstands open flame.
- 2 to 1 shrink ratio — one part number covers 2 or more wire sizes.



IBS No. Red	IBS No. Black	Pre-Shrunk ID	Post-Shrunk ID	Wire Size	MAX Wall	Length	Qty
16513	16524	1/8	1/16	26-22	.020	48"	4
16514	16523	3/16	3/32	22-18	.020	48"	4
16515	16525	1/4	1/8	16-14	.025	48"	4
16516	16526	3/8	3/16	12-10	.025	48"	4
16517	16527	1/2	1/4	6-4	.025	48"	4
16518	16528	3/4	3/8	2-1	.030	48"	4
16519	16529	1	1/2	1/0	.035	48"	4

Thin Wall Heat Shrink Tubing — 25' Rolls

While Supplies Last

- Flexible polyolefin single wall tubing — will not crack or split.
- Withstands open flame.
- 2 to 1 shrink ratio — one part number covers 2 or more wire sizes.

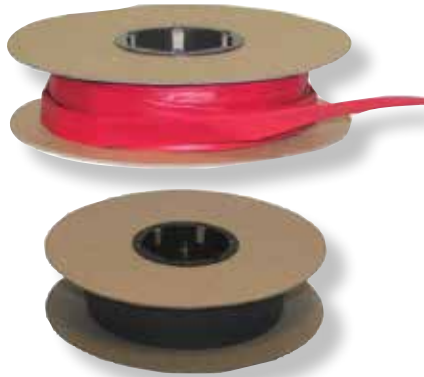

IBS No. Red	IBS No. Black	Pre-Shrunk ID	Post-Shrunk ID	Wire Size	MAX Wall	Length	Qty
16554	-	1/8	1/16	26-22	.020	25'	1
16553	-	3/16	3/32	22-18	.020	25'	1
16555	-	1/4	1/8	16-14	.025	25'	1
16556	-	3/8	3/16	12-10	.025	25'	1
16557	-	1/2	1/4	6-4	.025	25'	1
16558	-	3/4	3/8	2-1	.030	25'	1
16559	16589	1	1/2	1	.035	25'	1

ELECTRICAL



IBS, INCORPORATED

Battery Terminals Q02

ECOMAX™ Post Top Battery Terminals

ECOMAX™ Battery Terminals are the first environmentally friendly, 100% copper battery terminal. The post top design is manufactured with the highest quality C11000 ETP copper and is completely lead free and RoHS compliant — making it exempt from CA Proposition 65 requirement.

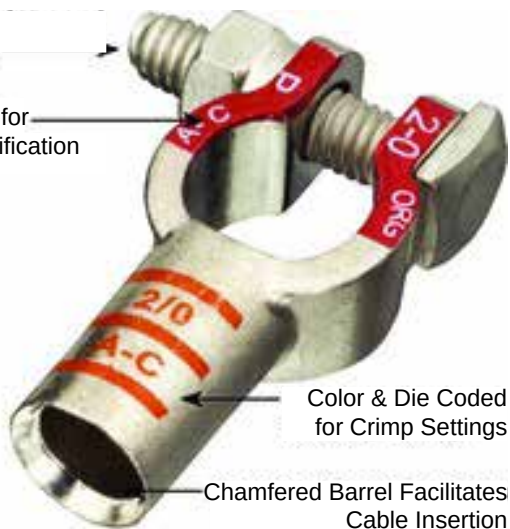

ECOMAX Battery Terminals Feature:

- Environmentally Friendly — RoHS compliant.
- Lead Free — Exempt from CA Proposition 65.
- 100% Copper Construction — C11000 ETP.
- Maximum Conductivity 101% IACS at 68°F.
- Tin plated for corrosion resistance.
- Provided with Nut and Bolt installed.
- Exceeds SAE Standard.

ECOMAX™ STRAIGHT CLAMP TERMINAL

IBS No.	Cable GA	Polarity	Color	Qty
E2102	4 GA	Univ	Gray	5
E2107	1+2 GA	Neg	Pink	5
E2108	1+2 GA	Pos	Pink	5
E2109	1/0	Neg	Black	5
E2110	1/0	Pos	Black	5
E2111	2/0	Neg	Orange	5
E2112	2/0	Pos	Orange	5
E2113	3/0	Neg	Purple	5
E2114	3/0	Pos	Purple	5
E2115	4/0	Neg	Yellow	5
E2116	4/0	Pos	Yellow	5



ECOMAX FLAG TERMINALS

IBS No.	Cable GA	Polarity	Color	Qty
E2209	1/0	Neg	Black	5
E2210	1/0	Pos	Black	5
E2211	2/0	Neg	Orange	5
E2212	2/0	Pos	Orange	5
E2213	3/0	Neg	Purple	5
E2214	3/0	Pos	Purple	5



ECOMAX™ RIGHT ELBOW TERMINALS

IBS No.	Cable GA	Polarity	Color	Qty
E2309	1/0	Neg	Black	5
E2310	1/0	Pos	Black	5
E2311	2/0	Neg	Orange	5
E2312	2/0	Pos	Orange	5



ECOMAX™ LEFT ELBOW TERMINALS

IBS No.	Cable GA	Polarity	Color	Qty
E2411	2/0	Neg	Orange	5
E2412	2/0	Pos	Orange	5

ELECTRICAL

IBS, INCORPORATED

Assortments Z02



EcoMax Terminals, HD Lugs & Splices Assortment

IBS No. 202P • 11 Items • 75 Pcs
Packaged in a locking steel drawer for easy storage and organization



IBS Inc. SPECIALTY PRODUCTS FOR MAINTENANCE & REPAIR INDUSTRIALMARKET.COM P.O. BOX 479-1908				EcoMax Terminals Heavy Duty Lugs & Splices			
Assortment No. 202P							
BAL1038 1/0 X 3/8ST HVY DUTY TUBULAR LUG	BAL1012 BATT TERM 1/0 X 1/2 STUD LUG HEAVY DUTY TUBULAR	E2110 ECOMAX BATT TERM 1/0 GA POS	E2109 ECOMAX BATT TERM 1/0 GA NEG				
BAL2038 2/0 X 3/8ST HVY DUTY TUBULAR LUG	BAL2012 2/0 X 1/2ST HVY DUTY TUBULAR LUG	E2112 ECOMAX BATT TERM 2/0 GA POS	E2111 ECOMAX BATT TERM 2/0 GA NEG				
MS100 1/0GA HVY DUTY BUTT CONN	MS200 2/0GA HVY DUTY BUTT CONN						
B1110 5/16 X 1-1/4 BATT BOLT & NUT TIN PLATED							

EcoMax Battery Ends & Shrink Tubing Assortment

IBS No. 835R • 8 Items • 34 Pcs
Packaged in a locking steel drawer for easy storage and organization



IBS Inc. SPECIALTY PRODUCTS FOR MAINTENANCE & REPAIR INDUSTRIALMARKET.COM P.O. BOX 479-1908				Eco-Max Battery Ends & Shrink Tubing			
Assortment No. 835R							
BAL1038 1/0 X 3/8ST HVY DUTY TUBULAR	BAL2038 2/0 X 3/8ST HVY DUTY TUBULAR	B3405 2-4/0GA X 6' RED HVY WALL	B3505 2-4/0GA X 6' BLACK HVY				
E2110 ECOMAX BATT TERM 1/0 GA POS	E2112 ECOMAX BATT TERM 2/0 GA POS						
E2109 ECOMAX BATT TERM 1/0 GA NEG	E2111 ECOMAX BATT TERM 2/0 GA NEG						

EcoMax Post Top Battery Terminals Assortment

IBS No. 129P • 17 Items • 69 Pcs
Packaged in a locking steel drawer for easy storage and organization



IBS Inc. SPECIALTY PRODUCTS FOR MAINTENANCE & REPAIR INDUSTRIALMARKET.COM P.O. BOX 479-1908				ECOMAX Post Top Battery Terminals			
Assortment No. 129P							
E2107 ECOMAX BATT TERM 1-2 GA NEG	E2111 ECOMAX BATT. TERM 2/0 GA. NEG.	E2309 ECOMAX BATT. TERM. RT. EL. 1/0 NEG.	B1110 5/16 X 1-1/4 TIN PLTD BATT				
E2108 ECOMAX BATTERY TERM 1-2 GA POSITIVE	E2112 ECOMAX BATT. TERM. 2/0 GA. POS.	E2310 ECOMAX BATT. TERM. RT. EL. 1/0 POS.					
E2109 ECOMAX BATT TERM 1/0 GA NEG	E2113 ECOMAX BATT. TERM. 3/0 GA. NEG.	E2311 ECOMAX BATT. TERM. RT. EL. 2/0 NEG.	E2411 ECOMAX BATT. TERM. LT. EL. 2/0 NEG.	E2211 ECOMAX BATT. TERM. FLAG 2/0 NEG.			
E2110 ECOMAX BATT TERM 1/0 GA POS	E2114 ECOMAX BATT. TERM. 3/0 GA. POS.	E2312 ECOMAX BATT. TERM. RT. EL. 2/0 POS.	E2412 ECOMAX BATT. TERM. LT. EL. 2/0 POS.	E2212 ECOMAX BATT. TERM. FLAG 2/0 POS.			

ELECTRICAL



IBS, INCORPORATED

Battery Terminals Q02

Stud Top / Side Mount Terminals

- Stackable — Allows maximum use of threads and more than one terminal to share a common stud.
- Maintenance Free
- Tin Plated
- Universal Polarity



STRAIGHT CLAMP TERMINAL

IBS No.	Cable GA	Die Code		Qty
		Color	Letter	
B2607	1 GA	Pink	H-H	5
B2609	1/0	Pink	E-A	5
B2611	2/0	Orange	A-C	5
B2613	3/0	Purple	A-B	5



DOUBLE BARREL (SPLICE)

IBS No.	Cable GA	Die Code		Qty
		Color	Letter	
B2711	2/0	Orange	A-C	5



B1103



B1104



B1105

STUD TOP BATTERY NUTS

IBS No.	Color	Type	Polarity	Qty
B1103	Black	Synthetic	Negative	10
B1104	Red	Synthetic	Positive	10
B1105	Gray	Stainless	Universal	10



B1101



BATTERY SIDE TERMINAL BOLTS

IBS No.	Description	Qty
B1101	3/8-16 X 1-1/8 Side Term Bolt	10
B1101L	3/8-16 X 1-3/4 Side Term Bolt	10
B1102	3/8-16 X 1-1/2 Side Term Bolt	10

B1102

E
L
E
C
T
R
I
C
A
L



Fusion™ Solder-On Battery Terminals

Fusion™ Connectors come ready-to-use. The correctly engineered flux and solder is precisely pre-measured and loaded in a solderable tin plated connector. Fusion™ strength is twice that of typical crimp or compression connectors.

- Stronger than crimp connectors, twice as thick as industry standards. All clamps, lugs and fasteners are tin plated.
- All clamps include tin plated 5/16" battery bolts and shoulder nuts.
- Faster, less confusing and less costly than multi-component solder slug systems.

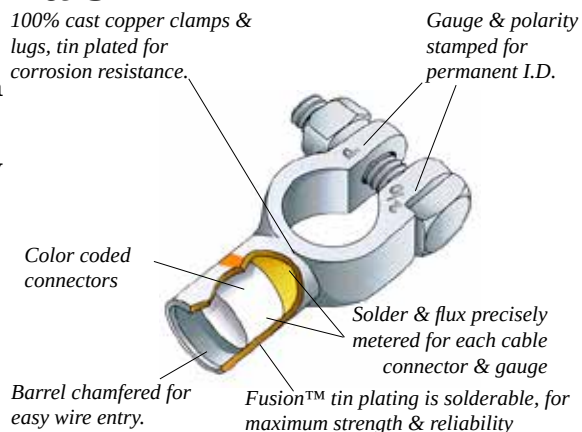

The Latest Innovation in Corrosion Protection

Quality Results with Every Application

- Long term reliability saves time and money.
- Complete, engineered system, includes copper connector, solderable tin plating, flux and solder.
- Easy for inexperienced users, saves time and money.

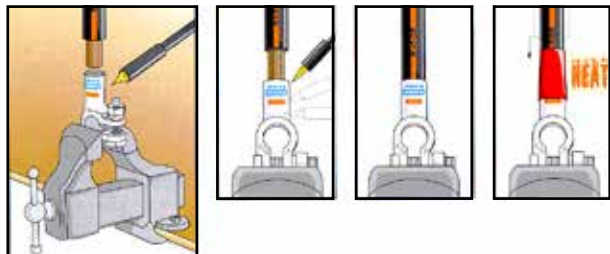

Secure connector in vise, apply heat, insert wire, allow to cool, install heat shrink tubing.

FAST, CONVENIENT, CONSISTENT QUALITY.



FUSION™ STRAIGHT CLAMP TERMINAL

IBS No.	Cable GA	Polarity	Color	Qty
B2117	4-6 GA	Neg	Grey	5
B21171	4-6 GA	Pos	Grey	5
B2118	1-2 GA	Neg	Pink	5
B2119	1-2GA	Pos	Pink	5
B2120	1/0	Neg	Black	5
B2121	1/0	Pos	Black	5
B2122	2/0	Neg	Orange	5
B2123	2/0	Pos	Orange	5
B2124	3/0	Neg	Purple	5
B2125	3/0	Pos	Purple	5
B2126	4/0	Neg	Yellow	5
B2127	4/0	Pos	Yellow	5



FUSION™ RIGHT CLAMP TERMINAL

IBS No.	Cable GA	Polarity	Color	Qty
B2128	1-2 GA	Neg	Pink	5
B2129	1-2GA	Pos	Pink	5
B2130	1/0	Neg	Black	5
B2131	1/0	Pos	Black	5
B2132	2/0	Neg	Orange	5
B2133	2/0	Pos	Orange	5
B2134	3/0	Neg	Purple	5
B2135	3/0	Pos	Purple	5
B2136	4/0	Neg	Yellow	5
B2137	4/0	Pos	Yellow	5



IBS, INCORPORATED

Battery Terminals Q02

ELECTRICAL



FUSION™ Flag

IBS No.	Cable GA	Polarity	Color	Qty
B2148	1-2 GA	Neg	Pink	5
B2149	1-2GA	Pos	Pink	5
B2150	1/0	Neg	Black	5
B2151	1/0	Pos	Black	5
B2152	2/0	Neg	Orange	5
B2153	2/0	Pos	Orange	5
B2154	3/0	Neg	Purple	5
B2155	3/0	Pos	Purple	5
B2156	4/0	Neg	Yellow	5
B2157	4/0	Pos	Yellow	5



FUSION™ HEAVY WALL LUGS (Q09)

IBS No.	Cable GA	Size	Color	Qty
B00381	4-6 GA	3/8	Grey	5
B00501	4-6 GA	1/2	Grey	5
B01381	1-2 GA	3/8	Pink	5
B01501	1-2GA	1/2	Pink	5
B11381	1/0	3/8	Black	5
B11501	1/0	1/2	Black	5
B21381	2/0	3/8	Orange	5
B21501	2/0	1/2	Orange	5
B31381	3/0	3/8	Purple	5
B31501	3/0	1/2	Purple	5
B41381	4/0	3/8	Yellow	5
B41501	4/0	1/2	Yellow	5

Fusion Solder-On Battery Ends & Shrink Tubing Assortment

IBS No. 296P • 8 Items • 34 Pcs

Packaged in a locking steel drawer for easy storage and organization



**FUSION™ Solder-On
Battery Ends & Shrink Tubing**
Assortment No. 296P

<small>B11381</small> 1/0 X 3/8 FUSION HVY WALL LUG 	<small>B21381</small> 2/0 X 3/8 FUSION HVY WALL LUG 	<small>B3405</small> 2-4/0GA X 6" RED HVY WALL 	<small>B3505</small> 2-4/0GA X 6" BLACK HVY
<small>B2121</small> 1/0 POS STRT FUSION BATTERY 	<small>B2123</small> 2/0 POS STRT FUSION BATTERY 		
<small>B2120</small> 1/0 NEG STRT FUSION BATTERY 	<small>B2122</small> 2/0 NEG STRT FUSION BATTERY 		

Fusion Battery Ends Assortment (Z02)

IBS No. 387R • 12 Items • 22 Pcs

Packaged in a locking steel drawer for easy storage and organization



Fusion Battery Ends
Assortment No. 387R

<small>B2117</small> 4-6GA NEG STRT FUSION BATTERY 	<small>B21171</small> 4-6GA POS STRT FUSION BATTERY 	<small>B2118</small> 1-2GA NEG STRT FUSION BATTERY 	<small>B2119</small> 1-2GA POS STRT FUSION BATTERY
<small>B2120</small> 1/0 NEG STRT FUSION BATTERY 	<small>B2121</small> 1/0 POS STRT FUSION BATTERY 	<small>B2122</small> 2/0 NEG STRT FUSION BATTERY 	<small>B2123</small> 2/0 POS STRT FUSION BATTERY
<small>B2124</small> 3/0 NEG STRT FUSION BATTERY 	<small>B2125</small> 3/0 POS STRT FUSION BATTERY 	<small>B2126</small> 4/0 NEG STRT FUSION BATTERY 	<small>B2127</small> 4/0 POS STRT FUSION BATTERY



Battery Terminals



HEAVY DUTY UNIVERSAL TERMINAL

IBS No.	Cable GA	Polarity	Qty
N7000	2/0-4/0	Neg or Pos	5



AUTOMOTIVE SERIES EMERGENCY STYLE BATTERY TERMINALS

IBS No.	Cable GA	Polarity	Color	Qty
133333	4GA - 1/0	Negative	Black	5
133332	4GA - 1/0	Positive	Red	5
133334	Universal	Universal	Zinc	5



MARINE WING NUT STYLE BATTERY TERMINALS

IBS No.	Cable GA	Stud	Polarity	Color	Qty
133336	4GA-1/0	5/16"	Negative	Black	5
133335	4GA-1/0	3/8"	Positive	Red	5

Military Spec Battery Terminals

These battery terminal adapters are used for mounting electrical leads to battery terminals on industrial lift trucks, tractor trucks, off road vehicles and many military applications for the U.S. Army, Navy, Marines and Coast Guard. The basic shape style is for A26 battery posts. Mil spec battery terminals feature a thick lead body and 3/8" bolt to attach to any accessory needed. Both bolts are reversible to allow for easier installation.



IBS No.	Description	Polarity	Qty
133529	Military Battery End	Negative	5
133530	Military Battery End	Positive	5

OEM Style Battery Terminals

- Ideal replacement for all light & medium duty.
- Zinc-plated copper alloy.
- Ribbed barrel for added wire gripping.



IBS No.	Cable GA	Polarity	Qty
133329	8-6 GA	Negative	5
133328	8-6 GA	Positive	5
133331	4, 2 & 1 GA	Negative	5
133330	4, 2 & 1 GA	Positive	5

Battery Converters



Side Terminal to Post Conversion (Male Thread)

- Converts side terminal to side post.
- Polarity specific.



Post Top to Side Terminal

- Converts post top to side terminal.
- Polarity specific.
- With steel insert.
- Fasteners included.

IBS No.	Description	Qty
133338	Side Terminal Post Set Positive & Negative (5 sets = 10 pcs)	5
133339	Side Terminal Adapter Set Positive & Negative (5 sets = 10 pcs)	5

Accessory Bolts

- Connect accessories directly to your battery. Ideal for radios, lights, winches, stereo systems, hydraulic pumps — any accessory that requires direct connection to the battery.
- Adapters made of solid brass.



IBS No.	Description	Qty
B6007	3/8 Side Terminal Accessory Bolt replaces regular S/T bolt and has 5/16-18 x 1/2" stud for accessory wires.	10
B6024	Adapter nut replaces regular 5/16" shoulder nut on top post clamps and has 5/16-18 x 3/4 stud for accessory wires.	10

Battery Nuts & Bolts

- Tin Plated
- Sold by the package (25 Nuts, 25 bolts)



IBS No.	Description	Qty
B1110	5/16-18 x 1-1/4 (25 Nuts, 25 Bolts)	25



IBS, INCORPORATED

Battery Terminals Q02

Cable Slugs



Cable slugs provide a fast, easy and environmentally sealed method to complete battery connections of all types. Cable slugs are available in seven sizes and are color coded for wire range from 4 GA to 4/0. Flux is packed in 2 oz. jars to provide easy application to the cable.

















- No crimp tools required.
- Minimal risk of insulation puncture.
- Environmental seal of insulator to wire prevents dielectric leakage and damage to splice by corrosive environments.
- Bonded insulation provides optimum mechanical strain relief.
- Minimal training and operator skill required to achieve correct results.

IBS No.	Size	Color	Qty
B400	4 GA	Grey	10
B200	2 GA	Green	10
B100	1 GA	Pink	10
B1010	1/0 GA	Black	10
B2010	2/0 GA	Orange	10
B3010	3/0 GA	Purple	10
B4010	4/0 GA	Yellow	10
B500	2 oz	Flux	1

Special Battery Ends Assortment

IBS No. 642P • 19 Items 52 Pcs

Packaged in a locking steel drawer for easy storage and organization

 Special Battery Ends			
Assortment No. 642P			
133328 8-6GA OEM POSITIVE BATTERY END 	N7000 HVY DUTY TOP MOUNT BATT TERM 	133338 POST TO SIDE MNT BATTERY END 	133335 MARINE WING NUT BATTERY END 
133329 8-6GA OEM NEGATIVE BATTERY END 	133332 AUTOMOTIVE EMERGENCY POS. 	133338 POST TO SIDE MNT BATTERY END 	B6007 SIDE MNT BATTERY ACC. BOLT 
133330 4,2&1GA OEM POSITIVE BATTERY 	133333 AUTOMOTIVE EMERGENCY NEG. 	133339 SIDE MNT TO POST TOP BATT. 	B1101 SIDE MOUNT BATT BOLT OEM 
133331 4,2&1GA OEM NEGATIVE BATTERY 	133334 AUTOMOTIVE SIDE MNT EMERG 	133339 SIDE MNT TO POST TOP BATT. 	B1110 5/16 X 1-1/4 BATT BOLT & NUT TIN PLATED 

ELECTRICAL



Battery End Power Cleaning Brushes (T03)

These brushes remove and polish corroded battery posts to ensure optimal conductivity. Brushes fit easily and securely in any electric, cordless or pneumatic drill.

- Cleans & polishes up to 1,000 battery posts.
- Heavy duty injected molded housing.
- Resilient steel bristles.
- Accepts 1/4" hex shank. Fits all drills or cordless screwdrivers.
- Acceptable RPM rating between 400-800

4-in-1 Tube Fitting Brush



Post Top

Marine

IBS No.	Description	Qty
133341	Post Top Power Brush	1
133343	Marine Power Brush	1
44690	4-in-1 Tube Fitting Brush	1
133457	Set of 4 Battery Power Brushes	1

Terminal Protectors (Q02)



- For Post Top Terminals
 - Prevents corrosion build-up.
 - Prolongs battery life.
 - Provides full starting power.
- Sold Each by Can
(1 can contains 100 protectors)

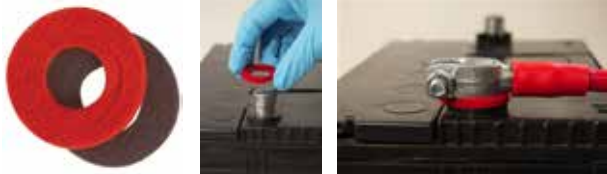

IBS No.	Description	Qty
643TP	Terminal Protectors (100 per can)	1

Heavy Duty Lugs

- Extra heavy duty thick copper for greater conductivity.
- Identification marked for cable size, color and letter code.
- Thicker tongue and raised barrel to resist vibration.
- Superior height to conventional lugs & splices.
- Longer barrel for improved crimping.
- 100% tin plating.
- Resists cracking.



IBS No.	Cable GA	Stud	Qty
BAL0138	1-2 GA	3/8	5
BAL0112	1-2 GA	1/2	5
BAL1038	1/0	3/8	5
BAL1012	1/0	1/2	5
BAL2038	2/0	3/8	5
BAL2012	2/0	1/2	5
BAL3038	3/0	3/8	5
BAL3012	3/0	1/2	5
BAL4038	4/0	3/8	5
BAL4012	4/0	1/2	5

Splices

Standard

Flared opening for easy cable insertion. Made electrolytic copper, tin plated

Heavy Duty

Superior height to conventional splices
Thicker copper for greater conductivity.
Crimping tool coding on barrel.
100% tin plated.



STANDARD SPLICES

HEAVY DUTY SPLICES

IBS No.	Cable GA	Qty
B1930	#2	10
B1940	#1	10
B1950	1/0	10
B1960	2/0	10
B1970	3/0	10

IBS No.	Cable GA	Qty
MS1	1 GA	5
MS100	1/0	5
MS200	2/0	5
MS300	3/0	5
MS400	4/0	5

ELECTRICAL



IBS, INCORPORATED

Tubular Lugs Q09

Copper Tubular Lugs



- Flared and chamfered barrel facilitates cable insertion.
- Made of 100% electrolytic copper.
- Lugs can be crimped or soldered.
- Gauge is stamped on lug for easy identification.

IBS No.	Cable GA	Stud	Qty	IBS No.	Cable GA	Stud	Qty
B8101	8 GA	#10	10				
B8141	8 GA	1/4	10	B1143	1 GA	1/4	10
B8561	8 GA	5/16	10	B1561	1 GA	5/16	10
B8383	8 GA	3/8	10	B1381	1 GA	3/8	10
B8503	8 GA	1/2	10	B1501	1 GA	1/2	10
B6101	6 GA	#10	10				
B6141	6 GA	1/4	10	B10141	1/0 GA	1/4	10
B6561	6 GA	5/16	10	B10516	1/0 GA	5/16	10
B6583	6 GA	3/8	10	B10381	1/0 GA	3/8	10
B6503	6 GA	1/2	10	B10501	1/0 GA	1/2	10
B4101	4 GA	#10	10				
B4141	4 GA	1/4	10	B20141	2/0 GA	1/4	10
B4561	4 GA	5/16	10	B20516	2/0 GA	5/16	10
B4381	4 GA	3/8	10	B20381	2/0 GA	3/8	10
B4503	4 GA	1/2	10	B20501	2/0 GA	1/2	10
B2141	2 GA	1/4	10	B30381	3/0 GA	3/8	10
B2561	2 GA	5/16	10	B30501	3/0 GA	1/2	10
B2381	2 GA	3/8	10	B40381	4/0 GA	3/8	10
B2503	2 GA	1/2	10	B40501	4/0 GA	1/2	10

Copper Tubular Lugs Assortment (Z02)

IBS No. 755R • 24 Items • 120 Pcs

Packaged in a locking steel drawer for easy storage and organization



Copper Tubular Lugs

Assortment 755R

<p>B8101 BATT TERM #8AWG #10 STUD LUG</p>	<p>B6101 BATT TERM #6AWG #10 STUD LUG</p>	<p>B4141 BATT TERM #4AWG 1/4 STUD LUG</p>	<p>B2381 BATT TERM #2AWG 3/8 STUD LUG</p>	<p>B10381 BATT TERM 1/0AWG 3/8 STUD LUG</p>	<p>B30381 BATT TERM 3/0AWG 3/8 STUD LUG</p>
<p>B8141 BATT TERM #8AWG 1/4 STUD LUG</p>	<p>B6141 BATT TERM #6AWG 1/4 STUD LUG</p>	<p>B4561 BATT TERM #4AWG 5/16 STUD LUG</p>	<p>B2503 BATT TERM #2AWG 1/2 STUD LUG</p>	<p>B10501 BATT TERM 1/0AWG 1/2 STUD LUG</p>	<p>B30501 BATT TERM 3/0AWG 1/2 STUD LUG</p>
<p>B8561 BATT TERM #8AWG 5/16 STUD LUG</p>	<p>B6561 BATT TERM #6AWG 5/16 STUD LUG</p>	<p>B4381 BATT TERM #4AWG 3/8 STUD LUG</p>	<p>B1381 BATT TERM #1AWG 3/8 STUD LUG</p>	<p>B20381 BATT TERM 2/0AWG 3/8 STUD LUG</p>	<p>B40381 BATT TERM 4/0AWG 3/8 STUD LUG</p>
<p>B8383 BATT TERM #8AWG 3/8 STUD LUG</p>	<p>B6583 BATT TERM #6AWG 3/8 STUD LUG</p>	<p>B4503 BATT TERM #4AWG 1/2 STUD LUG</p>	<p>B1501 BATT TERM #1AWG 1/2 STUD LUG</p>	<p>B20501 BATT TERM 2/0AWG 1/2 STUD LUG</p>	<p>B40501 BATT TERM 4/0AWG 1/2 STUD LUG</p>

IBS, INCORPORATED

Tubular Lugs Q09



Tin Plated Copper Tubular Lugs



- Flared and chamfered barrel facilitates cable insertion.
- Tin plated copper lugs reduce corrosion caused by harsh environments.
- May be soldered or crimped and are burr-free for a finished, professional look.
- UL Listed/CSA Certified.

IBS No.	Cable GA	Stud	Qty	IBS No.	Cable GA	Stud	Qty
B8101P	8 GA	#10	10				
B8141P	8 GA	1/4	10	B1143P	1 GA	1/4	10
B8561P	8 GA	5/16	10	B1561P	1 GA	5/16	10
B8383P	8 GA	3/8	10	B1381P	1 GA	3/8	10
B8503P	8 GA	1/2	10	B1501P	1 GA	1/2	10
B6101P	6 GA	#10	10				
B6141P	6 GA	1/4	10	B10141P	1/0 GA	1/4	10
B6561P	6 GA	5/16	10	B10516P	1/0 GA	5/16	10
B6583P	6 GA	3/8	10	B10381P	1/0 GA	3/8	10
B6503P	6 GA	1/2	10	B10501P	1/0 GA	1/2	10
B4101P	4 GA	#10	10				
B4141P	4 GA	1/4	10	B20141P	2/0 GA	1/4	10
B4561P	4 GA	5/16	10	B20516P	2/0 GA	5/16	10
B4381P	4 GA	3/8	10	B20381P	2/0 GA	3/8	10
B4503P	4 GA	1/2	10	B20501P	2/0 GA	1/2	10
B2141P	2 GA	1/4	10	B30381P	3/0 GA	3/8	10
B2561P	2 GA	5/16	10	B30501P	3/0 GA	1/2	10
B2381P	2 GA	3/8	10	B40381P	4/0 GA	3/8	10
B2503P	2 GA	1/2	10	B40501P	4/0 GA	1/2	10

Tin Plated Copper Tubular Lugs Assortment (Z02)

IBS No. 760R • 24 Items • 120 Pcs

























Packaged in a locking steel drawer for easy storage and organization



Tin Plated Copper Tubular Lugs

Assortment 760R



B8101P BATT TERM #8AWG #10 STUD LUG 	B6101P BATT TERM #6AWG #10 STUD LUG 	B4141P BATT TERM #4AWG 1/4 STUD LUG 	B2381P BATT TERM #2AWG 3/8 STUD LUG 	B10381P BATT TERM 1/0AWG 3/8 STUD LUG 	B30381P BATT TERM 3/0AWG 3/8 STUD LUG 
B8141P BATT TERM #8AWG 1/4 STUD LUG 	B6141P BATT TERM #6AWG 1/4 STUD LUG 	B4561P BATT TERM #4AWG 5/16 STUD LUG 	B2503P BATT TERM #2AWG 1/2 STUD LUG 	B10501P BATT TERM 1/0AWG 1/2 STUD LUG 	B30501P BATT TERM 3/0AWG 1/2 STUD LUG 
B8561P BATT TERM #8AWG 5/16 STUD LUG 	B6561P BATT TERM #6AWG 5/16 STUD LUG 	B4381P BATT TERM #4AWG 3/8 STUD LUG 	B1381P BATT TERM #1AWG 3/8 STUD LUG 	B20381P BATT TERM 2/0AWG 3/8 STUD LUG 	B40381P BATT TERM 4/0AWG 3/8 STUD LUG 
B8383P BATT TERM #8AWG 3/8 STUD LUG 	B6583P BATT TERM #6AWG 3/8 STUD LUG 	B4503P BATT TERM #4AWG 1/2 STUD LUG 	B1501P BATT TERM #1AWG 1/2 STUD LUG 	B20501P BATT TERM 2/0AWG 1/2 STUD LUG 	B40501P BATT TERM 4/0AWG 1/2 STUD LUG 



IBS, INCORPORATED

Battery Tools T03

High Capacity Hydraulic Crimper



High Capacity Hydraulic Crimper creates strong medical connections with crisp and sharp corners. The powerful hydraulic action delivers 70kN (15,736 Lbf) of force for secure crimps. This crimper includes 8 hardened steel die sets, and is ideal for battery and welding cables.

- Powerful hydraulic action delivers nominal force of 10 tons for secure crimps.
- Ideal for battery and welding cables.
- Creates strong mechanical connections with crisp and sharp corners.
- Features non-slip handle and ON/OFF retractor knob.
- Includes 8 hardened-steel die sets from #6 to 4/0 AWG.

IBS No.	Description	Qty
141981	High Capacity Hydraulic Crimper	1

Universal Crimping Tool IBS No. B0283

- **Double Compound Action** effortlessly exerts maximum force for fast, reliable crimps every time.
- **Rotating Dies** accommodate all sizes of battery terminals, lugs, and connectors, eliminating loss or need to store individual dies.
- **Diamond Shape Crimp** compresses all strands together to form a solid mass of copper. This assures a low resistance connection every time.
- **Easy to use reference chart** located on tool eliminates guess work enabling competition products to be crimped accurately.
- **Wire range:** #8 GA through 250 MCM.



BATTERY TERMINAL CRIMPING TOOL APPLICATION CHART

AWG No.	Battery Terminals Die Setting				Flared Lugs Die Setting		
	L Die	R Die	Color	# of Crimps	L Die	R Die	# of Crimps
6	NA	NA	NA	NA	M	K	1
4	J	H	Green	1	K	K	1
2	H	H	Pink	2	J	H	1
1	H	H	Pink	2	J	H	
1/0	E	A	Black	2	H	H	
2/0	A	C	Orange	2	E	A	2
3/0	A	B	Purple	2	A	C	
4/0	A	A	Yellow	2	A	B	2

E
L
E
C
T
R
I
C
A
L

Cable Cutter

IBS No. B0014

Wire Range: 8 GA to 350 mm

Length: 24 inches



Wire Cutter

IBS No. B0012

Wire Range: up to 2/0

Length: 7-3/4 inches



Battery Cable Stripper

IBS No. B0285

Wire Range: 8 GA to 4/0

Length: 3-3/4 inches



Indent Crimper

IBS No. B0840

Wire Range: 6 GA to 4/0

Length: 3-3/4 inches



12 Volt Tester

IBS No. 0690T

- Durable, high quality tester.
- Ideal for testing lighting and wiring circuits in auto, truck trailer & marine applications.
- Insulated mini-gator clip for positive contact.
- Sharp pierce point for penetrating all low voltage wiring.
- Bulb replaceable with standard automotive bulb.



Cable Clamps

IBS No. N7726

Sold in sets of Two

World's strongest booster cable clamp. Rated at 500 amps. It is the perfect replacement for worn or damaged clamps. Color coded red and black.



Professional Grade Heavy Duty Booster Cables (Q3F)

4GA x 20' 400 AMP

IBS No. 120765

- 400 AMP, Color coded clamps.
- Clamps are 100% Epoxy Coated for Safety.
- Tangle-free, twin-line cables.
- Extra Heavy Duty Insulation.
- Pure Copper Conductors.
- Stays flexible down to -30°F/-34°C
- Comes boxed for clean, safe storage.
- Includes convenient storage bag.





IBS, INCORPORATED

Nylon Tie Wraps Q04

Ty-Rap® Black Nylon Cable Tie Wraps with Metal Tabs

Heat Stabilized / Ultraviolet Resistant

A **durable, cost-effective bundling solution** designed to be used in **special applications** and in **harsh environmental conditions**. These ties combine **heat stabilizing** and **UV resistant materials** to provide a better match for special applications in both outdoor and **high-temperature** areas (-40°F/-40°C to 221°F/105°C). These ties also provide a smooth, **low-profile look** and offer **unlimited tensioning range** for a perfect fit. The convenience of a single tie for both applications keeps installation time and cost to a minimum. These ties are also **an effective alternative to expensive metallic fasteners**, which are priced higher and take longer to install.



- The **stainless steel locking device in the head** allows these ties to have a smooth body, making them infinitely adjustable within the bundle range.
- **Ideal for Industrial OEM and MRO** (includes, but not limited to industrial, lawn/garden/farming equipment, recreation vehicles, heavy equipment).
- The smooth outer body in comparison with the notched body of regular ties **reduces the stress on the tie for greater strength and improved performance**, especially in cold and dry conditions.
- **Ribbed and textured inner body prevents slippage** on the bundle from inside, keeping the tie in place during and after installation.
- **No slip tail** for easier starting and tightening.
- **Temperature range** (-40°F/-40°C to 221°F/105°C).
- **UL Recognized.**

IBS No.	Length	Strength	Width	MIL SPEC	Qty
104488	3-1/2	18 lbs	.091	MS3367-4	100
104489	5-1/2	30 lbs	.140	MS3367-5	100
104490	7	50 lbs	.187	MS3367-1	100
104491	11	50 lbs	.187	MS3367-7	100
104492	14	50 lbs	.187	MS3367-2	50
104493	13	120 lbs	.270	MS3367-3	50

Met-Tab Cable Tie Rack Assortment

IBS No. 815R • 5 Items • 400 Pcs

Packaged in a wall mountable steel cable tie rack for easy storage & organization.

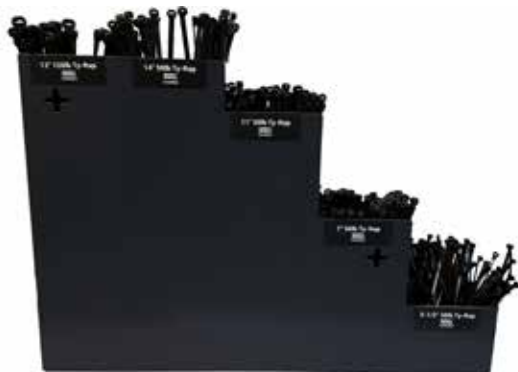

- Cable tie rack features all steel construction.
- Each compartment is supplied with a removable divider to create from 5 to 10 compartments.
- 5 different compartment heights provide storage space for cable ties in multiple lengths.
- Wall mountable.
- Overall diameter: 18-5/32"W X 3D X 12-1/4"H

IBS, INCORPORATED

Assortments Z02

















Black Nylon Ty-Raps with Metal Tabs Assortment

IBS No. 370R • 7 Items • 251 Pcs

Packaged in a locking steel drawer for easy storage & organization.



 IBS, Inc. <small>SPECIALTY PRODUCTS FOR MAINTENANCE & REPAIR INDUSTRIALBOLT.COM © © © 800-678-1906</small>		Black Nylon Ty-Raps with Metal Tabs	
		Assortment No. 370R	
104487 MINI CABLE TIE GUN			
			
104493 13IN 120LB BLACK NYLON TYRAP METAL TAB			
			
104492 14IN 50LB BLACK NYLON TYRAP METAL TAB			
			
104491 11IN 50LB BLACK NYLON TYRAP METAL TAB			
			
104490 7IN 50LB BLACK NYLON TYRAP METAL TAB			
			
104488 3-1/2 18LB BLACK NYLON TYRAP METAL TAB		104489 5-1/2 30LB BLACK NYLON TYRAP METAL TAB	
			

ELECTRICAL



IBS, INCORPORATED

Nylon Tie Wraps Q04

Cable Tie Wraps

Cable ties are all nylon and flame retardant, fungus inert, and resistant to solvents, alkalies, and grease. They function normally in service temperatures ranging from -40°F (-40°C) to 185°F (85°C) and can be stored in temperatures down to -85°F (-65°C).

The flexible design of the cable ties allows them to be slipped easily under and around cables and harnesses. The curved tip makes it easier to grasp, position and insert into the head. The raised ribs on the tail allow for temporary holding while the work is being positioned. The tie then locks in place automatically and the excess tail can be snipped off. The cable tie will then stay locked without slipping. No metal barbs.

NATURAL NYLON CABLE TIES

IBS No.	Length	Strength	Width	Bundle	Qty
L-4-18	4"	18 lbs	.095	.75"	100
L-5-30	5.5"	40 lbs	.140	1.5"	100
L-7-50	7.5"	50 lbs	.180	2"	100
L-11-50	11"	50 lbs	.180	3"	100
L-14-50	14.5"	50 lbs	.180	4"	100
L-14-120	15"	120 lbs	.300	4"	100
L-8-175	8"	175 lbs	.340	2"	100
L-24-175	24.5"	175 lbs	.340	7"	50
L-32-175	36"	175 lbs	.340	10"	50

UV BLACK WEATHER-RESISTANT CABLE TIES

IBS No.	Length	Strength	Width	Bundle	Qty
B-4-18	4"	18 lbs	.095	.75"	100
B-8-18	8"	18 lbs	.095	2"	100
B-5-30	5.5"	40 lbs	.140	1.5"	100
B-7-50	7.5"	50 lbs	.180	2"	100
B-11-50	11"	50 lbs	.180	3"	100
B-14-50	14.5"	50 lbs	.180	4"	100
B-14-120	15"	120 lbs	.300	4"	100
B-8-175	8"	175 lbs	.340	2"	100
B-24-175	24.5"	175 lbs	.340	7"	50
B-32-175	36"	175 lbs	.340	10"	50
B-21-250	22"	250 lbs	.500	6"	100

The shelf life of a nylon Cable Tie Wrap outside of its original packaging is 1 year. The 1 year shelf life begins after the packaging has been opened.

Shelf life of cable ties is a function of the environment in which they are stored.

Perfect storage conditions for a cable tie is 70°F and 50% Relative Humidity packaged in the manufacturer's original sealed bags. Life expectancy under these conditions is well in excess of two years. Shelf life will be reduced by temperature and humidity extremes, as well as by any break in the sealed bag.

Cable ties should be stored in the manufacturer's original packaging until ready for use.

Cable ties should be used within one year of purchase.

Partial Cable tie bags should be closed or sealed if at all possible.

Cable ties should not be over tensioned when installed (Over-tensioning actually weakens the tie).

E
L
E
C
T
R
I
C
A
L

IBS, INCORPORATED

Assortments Z02



Nylon Cable Tie Wraps

Assortment

IBS No. 107R • 10 Items • 750 Pcs

Packaged in a locking steel drawer for easy storage & organization.



IBS Inc. INDUSTRIAL PRODUCTS FOR MAINTENANCE & REPAIR INDUSTRIAL@IBSOL.COM • 800-678-1908		Nylon Tie Wraps
15" 120lb. Black Nylon Tie B-14-120		Assortment No. 107R
14-1/2" 50 lb. Black Nylon Tie B-14-50		
4" 18 lb. Black Nylon Tie B-4-18	11" 50 lb. Black Nylon Tie B-11-50	
7-1/2" 50 lb. Clear Nylon Tie L-7-50	8" 50 lb. Mounting Tie MH-7-50	
5-1/2" 40 lb. Clear Nylon Tie L-5-30	7-1/2" 50 lb. Black Nylon Tie B-7-50	
4" 18 lb. Clear Nylon Tie L-4-18	5-1/2" 40 lb. Black Nylon Tie B-5-30	

Standard Cable Tie Wraps Asst.

IBS No. 724R • 6 Items • 600 Pcs

Packaged in a locking steel drawer for easy storage & organization.



IBS Inc. INDUSTRIAL PRODUCTS FOR MAINTENANCE & REPAIR INDUSTRIAL@IBSOL.COM • 800-678-1908		Standard Cable Tie Wraps
L-4-18 4 18LB NATURAL NYLON TIE*		L-5-30 5-1/2 30LB NATURAL NYLON TIE*
L-7-50 7 50LB NATURAL NYLON TIE*		
L-11-50 11 50LB NATURAL NYLON TIE*		
L-14-50 14 50LB NATURAL NYLON TIE*		
L-14-120 14 120LB NATURAL NYLON TIE*		
L-14-120 14 120LB NATURAL NYLON TIE*		

Weather-Resistant Cable Tie Wraps Assortment

IBS No. 725R • 6 Items • 600 Pcs

Packaged in a locking steel drawer for easy storage & organization.



IBS Inc. INDUSTRIAL PRODUCTS FOR MAINTENANCE & REPAIR INDUSTRIAL@IBSOL.COM • 800-678-1908		Weather Resistant Cable Tie Wraps
B-4-18 4 18LB BLACK NYLON TIE*		B-5-30 5 30LB BLACK NYLON TIE*
B-7-50 7 50LB BLACK NYLON TIE*		
B-11-50 11 50LB BLACK NYLON TIE*		
B-14-50 14 BLACK NYLON TIE*		
B-14-120 14 120LB BLACK NYLON TIE*		
B-14-120 14 120LB BLACK NYLON TIE*		

Cable Tie Rack Assortment

IBS No. 814R • 5 Items • 500 Pcs

Packaged in a wall mountable steel cable tie rack for easy storage & organization.

- Cable tie rack features all steel construction.
- Each compartment is supplied with a removable divider to create from 5 to 10 compartments.
- 5 different compartment heights provide storage space for cable ties in multiple lengths.
- Wall mountable.
- Overall diameter: 18-5/32"W X 3D X 12-1/4"H

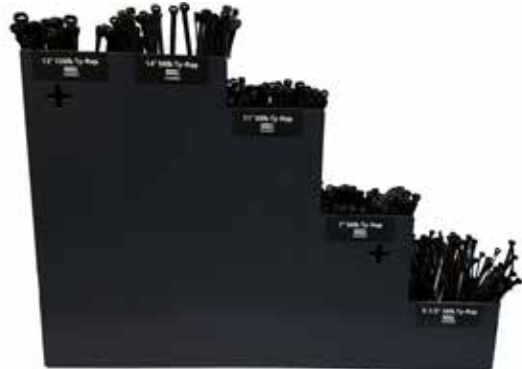

ELECTRICAL



IBS, INCORPORATED

Nylon Tie Wraps Q04

Black Low Profile Cable Tie Wraps

In some areas and applications a standard tie can be a real nuisance, snagging or catching on materials around it, or even taking up more space than needed or wanted. Standard ties can also create a safety hazard with sharp edges where the tang was cut off.

Low Profile Tie Wraps provide a solution to these problems. Made in the USA., this tie is the lowest profile nylon tie on the market and offers superior tensile strength and robust quality that stand up well in a wide range of environments. Safer than a traditional tie because of its smooth, snag proof contour with no barbs or spikes to injure and installer, technician, or end user.

FEATURES & BENEFITS

- Lowest profile nylon tie available offering exceptional functionality, strength and safety.
- Flexible head design easily flexes around tubing or bundled wiring enhancing the visual appeal of your finished product by fitting closely and snugly to the material being wrapped.
- Tamper-proof pawl located under the tie's head offers additional safety and security.
- Leftover strap conveniently slips back into the head, leaving no sharp cutoffs or exposed edges to injure the installer, technician, or end user.
- Made in the USA.
- RoHS and UL compliant.



BLACK LOW PROFILE CABLE TIE WRAPS

IBS No.	Length	Strength	Width	Bundle	Qty
BLP-7-50	7.5"	50 lbs	.17	1-3/4"	100
BLP-11-50	11"	50 lbs	.17	3"	100
BLP-14-50	14"	50 lbs	.17	4"	100
BLP-14-120	14"	120 lbs	.30	4"	100

Black Low Profile Cable Tie Wraps Assortment

IBS No. 796R • 8 Items • 700 Pcs

Packaged in a locking steel drawer for easy storage & organization.













IBS, Inc.
SPECIALTY PRODUCTS FOR MAINTENANCE & REPAIR
INDUSTRIALBOLT.COM • 800-678-1506

**Low Profile and Releasable
Cable Tie Wraps**

Assortment No. 796R

<p>BLP-14-120 14IN 120LB BLACK NYLON LOW PROFILE TIE WRAP</p> 	
<p>BLP-14-50 14IN 50LB BLACK NYLON LOW PROFILE TIE WRAP</p> 	
<p>RB-5-50 5 50LB BLACK RELEASABLE NYLON™ TIE WRAP</p> 	<p>BLP-11-50 11IN 50LB BLACK NYLON LOW PROFILE TIE WRAP</p> 
<p>RB-8-50 8 50LB BLACK RELEASABLE NYLON™ TIE WRAP</p> 	<p>BLP-7-50 7IN 50LB BLACK NYLON LOW PROFILE TIE WRAP</p> 
<p>RB-12-50 12 50LB BLACK RELEASABLE™ NYLON TIE WRAP</p> 	
<p>RB-14-50 14 50LB BLACK RELEASABLE™ NYLON TIE WRAP</p> 	



UV Black Weather-Resistant Releasable Cable Tie Wraps

Ideal for use in applications where there is a need to repeatedly open and close the tie.



IBS No.	Length	Strength	Width	Bundle	Qty
RB-5-50	5"	50 lbs	.290	1.5"	100
RB-8-50	8"	50 lbs	.290	2"	100
RB-12-50	12"	50 lbs	.290	3"	100
RB-14-50	14"	50 lbs	.180	4"	100



Nylon Speedy Ties (Q04) Reusable Tie Wrap

A fully re-usable, easily releasable lashing tie. The Speedy-Tie's unique design allows it to be released with one hand.



Features:

- Just one click to tie and untie
- Fully re-usable
- Once applied, the tail can be neatly tucked away for added safety
- Highly visible yellow color
- Versatile design allows for multiple applications

Used for and by:

- Electrical contractors
- Heating and ventilation contractors
- Residential construction
- General and heavy industry
- Packaging
- Tubing and pipe bundling
- Overhead installations
- In-plant transfer of products

IBS No.	Length in.	Length (mm)	MIN Tensile Strength lbs	MIN Tensile Strength (N)	Width in.	Width (mm)	MAX Bundle in.	MAX Bundle (mm)	Operating Temperature	Qty
141146	29.52	(750)	200 lbs	(888)	.51	(13)	8.27	(210)	-40°F to 185° F CONTINUOUS	10

Releasable Cable Tie Wraps Assortment (Z02)

IBS No. 726R • 5 Items • 310 Pcs

Packaged in a locking steel drawer for easy storage & organization.



Releasable Cable Tie Wraps

Assortment No. 726R

RB-5-50 5" 50LB BLACK RELEASABLE NYLON TIE	
RB-8-50 8" 50LB BLACK RELEASABLE NYLON TIE	
RB-12-50 12" 50LB BLACK RELEASABLE NYLON TIE	
RB-14-50 14" 50LB BLACK RELEASABLE NYLON TIE	
141146 29.5 200# YELLOW NYLON*	



IBS, INCORPORATED

Nylon Tie Wraps Q04

Colored & Fluorescent Cable Tie Wraps

Fluorescent nylon cable tie wraps feature the same design characteristics as the standard cable ties, but are available in highly visible fluorescent colors. Ideal for color coding wire bundles by usage or application.

ELECTRICAL

	IBS No.	Length	Strength	Color	Qty
	BL-4-18	4"	18 lbs.	Blue	100
	R-4-18	4"	18 lbs.	Red	100
	Y-4-18	4"	18 lbs.	Fluorescent Yellow	100
	BL-7-50	7"	50 lbs.	Blue	100
	BR-7-50	7"	50 lbs.	Brown	100
	GY-7-50	7"	50 lbs.	Gray	100
	GR-7-50	7"	50 lbs.	Green	100
	P-7-50	7"	50 lbs.	Purple	10
	R-7-50	7"	50 lbs.	Red	100
	Y-7-50	7"	50 lbs.	Yellow	100
	FB-7-50	7"	50 lbs.	Fluorescent Blue	100
	FG-7-50	7"	50 lbs.	Fluorescent Green	100
	FO-7-50	7"	50 lbs.	Fluorescent Orange	100
	FP-7-50	7"	50 lbs.	Fluorescent Pink	100
	FY-7-50	7"	50 lbs.	Fluorescent Yellow	100
	TW4	4"	18 lbs.	25 Pcs. Each of the following: White, Black, Yellow, Red & Blue	1
	TW7	7"	50 lbs.	25 Pcs. Each of the following: Blue, Brown, Gray, Green, Purple, Red, Yellow	1
	TW7FL	7"	50 lbs.	25 Pcs. Each of the following: White, Black, FL Yellow, FL Green, FL Blue, FL Orange, FL Pink	1

IBS, INCORPORATED

Assortments Z02



Colored Cable Tie Wraps Assortment

IBS No. 710R • 12 Items • 1200 Pcs

Packaged in a locking steel drawer for easy storage & organization



IBS, Inc. <small>SPECIALTY PRODUCTS FOR MAINTENANCE & REPAIR INDUSTRIALBOLT.COM © © © 800-678-1906</small>		Colored Cable Tie Wraps Assortment No. 710R
BL-4-18 4" 18LB BLUE NYLON TIE 	R-4-18 4" 18LB RED NYLON TIE 	
Y-4-18 4" 18LB FLOURESCENT YELLOW NYLON TIE 	L-4-18 4" 18LB NATURAL NYLON TIE 	
B-7-50 7" 50LB BLACK NYLON TIE 	B-4-18 4" 18LB BLACK NYLON TIE 	
FB-7-50 7" 50LB FLOURESCENT BLUE NYLON TIE 	L-7-50 7" 50LB NATURAL NYLON TIE 	
FO-7-50 7" 50LB FLOURESCENT ORANGE NYLON TIE 	FG-7-50 7" 50LB FLOURESCENT GREEN NYLON TIE 	
FY-7-50 7" 50LB FLOURESCENT YELLOW NYLON TIE 	FP-7-50 7" 50LB FLOURESCENT PINK NYLON TIE 	

8" Colored Cable Tie Wraps Assortment

IBS No. 786R • 12 Items • 1200 Pcs

Packaged in a locking steel drawer for easy storage & organization



IBS, Inc. <small>SPECIALTY PRODUCTS FOR MAINTENANCE & REPAIR INDUSTRIALBOLT.COM © © © 800-678-1906</small>		7" Colored Cable Tie Wraps Assortment No. 786R
BL-7-50 7" 50LB BLUE NYLON TIE 	GY-7-50 7" 50LB GRAY NYLON TIE 	
Y-7-50 7" 50LB YELLOW NYLON TIE 	GR-7-50 7" 50LB GREEN NYLON TIE 	
R-7-50 7" 50LB RED NYLON TIE 	P-7-50 7" 50LB PURPLE NYLON TIE 	
BR-7-50 7" 50LB BROWN NYLON TIE 	FO-7-50 7" 50LB FLOURESCENT ORANGE NYLON TIE 	
FB-7-50 7" 50LB FLOURESCENT BLUE NYLON TIE 	FP-7-50 7" 50LB FLOURESCENT PINK NYLON TIE 	
FY-7-50 7" 50LB FLOURESCENT YELLOW NYLON TIE 	FG-7-50 7" 50LB FLOURESCENT GREEN NYLON TIE 	

ELECTRICAL



IBS, INCORPORATED

Nylon Tie Wraps Q04

Push Mount Cable Ties

These cable ties snap quickly into a 1/4" hole to provide one-piece bundling and mounting. The push-mount head is ideal for mounting on panels or chassis. Centering ears and locking barbs hold securely and spring arm thickness compensators tighten in panel chassis up to 1/8" thick. Bundling can be done either before or after mounting. Injection molded for maximum strength.



UV BLACK WEATHER-RESISTANT PUSH MOUNTING CABLE TIES

IBS No.	Length	Strength	Width	Bundle	Qty
PMB-8-50	8"	50 lbs	.190	2"	100

Buttonhead Cable Ties

Buttonhead ties are of two piece construction designed to mount the tie on a panel or structural framework. The strap can be inserted into the head in either direction to speed installation. Black nylon construction.

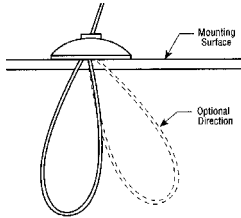

UV BLACK WEATHER-RESISTANT BUTTONHEAD CABLE TIES

IBS No.	Length	Strength	Width	Bundle	Qty
BH-10-100	9-5/8"	100 lbs	.22	2.62"	50

Screw Mount Cable Ties

Screw mount cable ties have a built-in mounting hole. Once fastened around a bundle they can simply be secured with a screw or bolt.



NATURAL SCREW MOUNT CABLE TIES

IBS No.	Length	Strength	Width	Bundle	Mounts with	Qty
MH-7-50	8"	50 lbs	.18	2"	#10 screw	100
MH-14-50	15"	50 lbs	.18	4"	#10 screw	100
MH-14-120	15"	120 lbs	.30	4"	1/4" screw	100



UV BLACK WEATHER-RESISTANT SCREW MOUNT CABLE TIES

IBS No.	Length	Strength	Width	Bundle	Mounts with	Qty
MBH-7-50	8"	50 lbs	.18	2"	#10 screw	100

Stud Mount Cable Tie Wrap

This tie is made to easily mount to the top of a stud. With the additional height gained by this design, it allows the wire bundle added clearance from the panel or wherever it is being used.

- The standoff design can be mounted onto screws or studs to mount and secure bundles in one component providing quick installation time — saving time and money.
- Serrated stand-off has "soft-push" technology, meaning the standoff slides onto the stud easily and the serrations bite onto the stud for a secure bundle that saves time and money.
- Mounts onto #10 & 5mm studs.



IBS No.	Length	Strength	Width	Bundle	Qty
SM-6-50	6"	50 lbs	.18	1.4"	25

E
L
E
C
T
R
I
C
A
L

IBS, INCORPORATED

Nylon Tie Wraps Q04



Dual Clamp Cable Ties

- Designed to provide **parallel separation** between hoses, wires, cables and tubing to protect from abrasion.
- **Optional mounting hole** for securing bundles along
- **150 lb. tensile strength** ensures enough strength for heavy duty applications.
- Straps are **releasable** for increased serviceability.
- **Heat and UV stabilized** for longer life in applications outdoors and in higher temperatures



IBS No.	Length		MIN Tensile Strength		Width		MAX Bundle		Stud Diam.		Operating Temperature	Qty
	in.	(mm)	lbs	(N)	in.	(mm)	in.	(mm)	in.	(mm)		
141140	13.0	(330.20)	150 lbs	(667)	.50	(12.7)	1.3	(33.0)	1/4	M6	-40°F to +221° F -40°C to +105° C	50
141141	19.2	(487.68)	150 lbs	(667)	.50	(12.7)	2.28	(58.0)	1/4	M6	-40°F to +221° F -40°C to +105° C	50

Cable & Tubing Mounting Tie Wraps Assortment

IBS No. 727R • 7 Items • 255 Pcs

Packaged in a locking steel drawer for easy storage & organization



















IBS, Inc.

SPECIALTY PRODUCTS FOR MAINTENANCE & REPAIR
INDUSTRIALBOLT.COM © © © 800-678-1906

Mounting Tie Wraps

Assortment No. 727R

SM-6-50	6' 50LB STUD MOUNT CABLE TIE WRAP BLACK	
		
PMB-8-50	8" 50LB BLACK PUSH MOUNT CABLE TIE WRAP	
		
BH-10-100	9-5/8" 100LB BUTTON HD TIE WRAP BLACK	
		
MH-7-50	7" 50LB NATURAL MOUNTING NYLON TIE WRAP	
		
MBH-7-50	7" 50LB BLACK NYLON MOUNTING TIE	
		
MH-14-120	14" 120LB NATURAL MOUNTING NYLON TIE WRAP	
		
141140	13IN DUAL CLAMP CABLE TIE BLACK	
		

ELECTRICAL



IBS, INCORPORATED

Nylon Tie Wraps Q04

Cable Tie Gun (Q04)

3/32" - 3/16" Capacity



- **Capacity:** 3/32-Inch (2.4mm) to 3/16-Inch (4.8mm) wide and up to 1/16-Inch (1.58mm) thick — **works on 18 lb. to 50 lb. cable ties.**
- **Generates 18-50-Pounds** of tensile strength for a firm and snug bundle.
- **Flush cuts end of cable tie** for a clean and smooth end, eliminating the hazardous, sharp edges left behind with regular tie ends.
- **Adjustable bundling pressure**, allowing it to be used on various types of materials without damaging the material.
- Body is **constructed of high impact nylon and fiberglass** for strength and durability.
- Not compatible with stainless steel ties.

IBS No.	Description	Qty
141416	Cable Tie Gun	1

Mini Cable Tie Gun (T03)



- Convenient, pocket sized cable gun.
- Secures & cuts cable ties 18-50 lbs tensile strength.
- Provides a tighter installation of nylon cable ties vs. manual installation.
- Works with ties from 2.4 mm to 4.8 mm wide (0.094" to .0188") with tensile strength from 18 to 50 lbs.
- Twist cable gun to cut and trim off excess cable tie length.
- Contoured trigger and palm rest is easy on the hands.
- Heavy, long-wearing mechanism and handle.

IBS No.	Description	Qty
104487	Mini Cable Tie Gun	1

ALWAYS WEAR SAFETY GLASSES
DO NOT OVER-TIGHTEN

Cable Tie Bases

Bases are backed with foam adhesive. For use with 18, 30, and 50 lb. ties.



IBS No.	Size	Color	Qty
3M-6292	1 x 1	Ivory	25
3M-6294	3/4 x 3/4	Ivory	25
3M-6297	1 x 1	Black	25

Adjustable Cable & Hose Mounts

These clamps are highly resistant to chemicals, heat and impact. The ladder style fastening system allows them to be easily released and refastened. They are ideal for securing wires, cables, hose or bundles of various shapes and sizes. They can be mounted using either a screw or the adhesive backing and can be used over and over again. The three sizes accommodate sizes from #14 wire to 1" hose or cable.

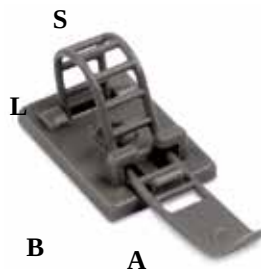

IBS No.	A	B	S	L	Use Range	Qty
L-013	.709	.984	.314	2.34	.118 - .500	25
L-018	.827	1.18	.472	3.12	.197 - .827	25
L-023	.984	1.38	.551	3.37	.275 - .984	25



Vinyl Dipped Hose Clamps

Clamps are furnished open. They are made of zinc plated steel with a 1/32" thick black vinyl plastic coating. Great for wire cable and all types of hose and tubing. Resistant to abrasion and chemicals. Temperature range -30°F to +350°F.



IBS No.	ID	Hole Size	Width	Qty
16540	1/4	1/4	1/2	25
16530	3/8	1/4	1/2	25
16531	1/2	1/4	1/2	25
16534	5/8	1/4	1/2	25
16532	3/4	1/4	1/2	25
16546	1	1/4	1/2	25
16541	5/16	3/8	3/4	25
16542	3/8	3/8	3/4	25
16543	1/2	3/8	3/4	25
16544	5/8	3/8	3/4	25
16545	3/4	3/8	3/4	25
16547	1	3/8	3/4	25
16533	1-1/4	3/8	3/4	25
16548	1-1/2	3/8	3/4	25
16550	2	3/8	3/4	25

Nylon Clamps

Durable nylon clamp. Ideal for channeling cable and wire. Operating temperature ranges from - 60°F to 275°F. Natural color



IBS No.	ID	Width	Screw Size	Qty
7118A	1/8	3/8	#10	25
7119A	3/16	3/8	#10	25
7120A	1/4	3/8	#10	25
7121A	5/16	3/8	#10	25
7122A	3/8	3/8	#10	25
7123A	7/16	3/8	#10	25
7124A	1/2	3/8	#10	25
7125A	9/16	1/2	#10	25
7126A	5/8	1/2	#10	25
7128A	3/4	1/2	#10	25
7129A	7/8	1/2	#10	25
7130A	1	1/2	#10	10

Rubber Insulated Clamps

Excellent for securing all types of wiring to the body or frame of all types of mobile equipment. Flexible neoprene cushion holds the lines firmly while protecting them from shock, abrasion and vibration.



ALUMINUM
1/4" Mounting Hole 1/2" Wide

IBS No.	ID	Stamp	Qty
7314A	1/4	4	25
7315A	3/8	6	25
7316A	1/2	8	25
7317A	5/8	10	25
7318A	3/4	12	25
7319A	7/8	14	10
7320A	1	16	10
7321A	1-1/8	18	10
7322A	1-1/4	20	10
7323A	1-3/8	22	10
7324A	1-1/2	24	10
7325A	1-5/8	26	10



CADMIUM PLATED STEEL
3/8" Mounting Hole 5/8" Wide

IBS No.	ID	Stamp	Qty
7514A	1/4	4	25
7515A	3/8	6	25
7516A	1/2	8	25
7517A	5/8	10	25
7518A	3/4	12	25
7519A	7/8	14	10
7520A	1	16	10
7522A	1-1/4	20	10
7524A	1-1/2	24	10
7525A	2	32	5
7527A	2-1/2	40	5

Chassis Clips

Spring steel, push on wire clips, finished in black enamel. Spring tension holds the clip in place while it secures the wires to panel surfaces.



IBS No.	Frame	Qty
7060A	3/16	50
7061A	1/4	50
7062A	3/8	50

ELECTRICAL



IBS, INCORPORATED

Assortments Z02

Vinyl Coated Clamps

IBS No. 802R • 10 Items • 197 Pcs
Packaged in a locking steel drawer for easy storage and organization



IBS, Inc.		Vinyl Coated Clamps	
SPECIALTY PRODUCTS FOR MAINTENANCE & SERVICE INDUSTRIALBOLT.COM © P.C. 800-870-1906			
Assortment No. 802R			
16540 1/4ID 1/4 STUD VINYL COATED LOOM CLAMP	16531 1/2ID 1/4 STUD VINYL COATED LOOM CLAMP	16547 1ID 3/8 STUD VINYL COATED LOOM CLAMP	16548 1-1/2ID 3/8 STUD VINYL COATED LOOM CLAMP
16541 5/16ID 3/8STUD VINYL COATED LOOM CLAMP	16534 5/8ID 1/4 STUD VINYL COATED LOOM CLAMP	16533 1-1/4ID 13/32 STUD VINYL COATED LOOM CLAMP	16530 2ID 3/8 STUD VINYL COATED LOOM CLAMP
16530 3/8ID 1/4 STUD VINYL COATED LOOM CLAMP	16545 3/4ID 3/8 STUD VINYL COATED LOOM CLAMP		

Nylon Clamps

IBS No. 145R • 12 Items • 525 Pcs
Packaged in a locking steel drawer for easy storage and organization



IBS, Inc.		Nylon Clamps	
SPECIALTY PRODUCTS FOR MAINTENANCE & SERVICE INDUSTRIALBOLT.COM © P.C. 800-870-1906			
Assortment No. 145R			
7118A 1/8 NYLON CLAMP	7119A 3/16 NYLON CLAMP	7120A 1/4 NYLON CLAMP	
7121A 5/16 NYLON CLAMP	7122A 3/8 NYLON CLAMP	7123A 7/16 NYLON CLAMP	
7124A 1/2 NYLON CLAMP	7125A 9/16 NYLON CLAMP	7126A 5/8 NYLON CLAMP	
7128A 3/4 NYLON CLAMP	7129A 7/8 NYLON CLAMP	7130A 1 NYLON CLAMP	

Nylon & Rubber Clamps

IBS No. 141R • 16 Items • 230 Pcs
Packaged in a locking steel drawer for easy storage and organization



IBS, Inc.		Rubber Insulated & Nylon Clamps	
SPECIALTY PRODUCTS FOR MAINTENANCE & SERVICE INDUSTRIALBOLT.COM © P.C. 800-870-1906			
Assortment No. 141R			
7120A 1/4 NYLON CLAMP	7122A 3/8 NYLON CLAMP	7124A 1/2 NYLON CLAMP	7126A 5/8 NYLON CLAMP
7314A 1/4 INSULATED CLAMP 1/4 STUD STAMP #4	7315A 3/8 INSULATED CLAMP 1/4 STUD STAMP #6	7316A 1/2 INSULATED CLAMP 1/4 STUD STAMP #8	7318A 5/8 INSULATED CLAMP 1/4 STUD STAMP #12
7320A 1 INSULATED CLAMP 1/4 STUD STAMP #16	7322A 1-1/4 INSULATED CLAMP 1/4 STUD STAMP #20	7324A 1-1/2 INSULATED CLAMP 1/4 STUD STAMP #24	7314A 1/4 INSULATED CLAMP 3/8 STUD STAMP #4
7516A 1/2 INSULATED CLAMP 3/8 STUD STAMP #8	7518A 5/8 INSULATED CLAMP 3/8 STUD STAMP #12	7520A 1 INSULATED CLAMP 3/8 STUD STAMP #16	7522A 1-1/4 INSULATED CLAMP 3/8 STUD STAMP #18

Rubber Insulated Clamps 1/4" Mounting Hole

IBS No. 146R • 12 Items • 90 Pcs
Packaged in a locking steel drawer for easy storage and organization



IBS, Inc.		Rubber Insulated Clamps 1/4" Mounting Hole	
SPECIALTY PRODUCTS FOR MAINTENANCE & SERVICE INDUSTRIALBOLT.COM © P.C. 800-870-1906			
Assortment No. 146R			
7314A 1/4 INSULATED CLAMP 1/4 STUD STAMP #4	7315A 3/8 INSULATED CLAMP 1/4 STUD STAMP #6	7316A 1/2 INSULATED CLAMP 1/4 STUD STAMP #8	
7317A 5/8 INSULATED CLAMP 1/4 STUD STAMP #10	7318A 3/4 INSULATED CLAMP 1/4 STUD STAMP #12	7319A 7/8 INSULATED CLAMP 1/4 STUD STAMP #14	
7320A 1 INSULATED CLAMP 1/4 STUD STAMP #16	7321A 1-1/8 INSULATED CLAMP 1/4 STUD STAMP #18	7322A 1-1/4 INSULATED CLAMP 1/4 STUD STAMP #20	
7323A 1-3/8 INSULATED CLAMP 1/4 STUD STAMP #22	7324A 1-1/2 INSULATED CLAMP 1/4 STUD STAMP #24	7325A 1-5/8 INSULATED CLAMP 1/4 STUD STAMP #26	

ELECTRICAL

IBS, INCORPORATED

Assortments Z02



Rubber Insulated Clamps 3/8" Mounting Hole

IBS No. 147R • 8 Items • 75 Pcs
Packaged in a locking steel drawer for easy storage and organization



IBS, Inc. QUALITY PRODUCTS FOR MAINTENANCE & REPAIR INDUSTRIALBOLT.COM © P.C. 888-678-1808		Rubber Insulated Clamps 3/8" Mounting Hole	
Assortment No. 147R			
7514A 1/4 INSULATED CLAMP 3/8 STUD STAMP #4	7515A 3/8 INSULATED CLAMP 3/8 STUD STAMP #6	7516A 1/2 INSULATED CLAMP 3/8 STUD STAMP #8	
7517A 5/8 INSULATED CLAMP 3/8 STUD STAMP #10	7518A 3/4 INSULATED CLAMP 3/8 STUD STAMP #12	7519A 7/8 INSULATED CLAMP 3/8 STUD STAMP #14	
7520A 1 INSULATED CLAMP 3/8 STUD STAMP #16	7522A 1-1/4 INSULATED CLAMP 3/8 STUD STAMP #18		

Grommets (Q1C)

Grommets are made of flexible oil-resistant extra tough Styrene Butadien Copolymer Rubber. They have an operating temperature from -60°F to 180°F. Insert them into pre-drilled holes to protect wires against cutting and fraying.

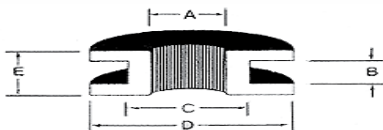

- A = O.D. of wire or wires
- B = Wall thickness
- C = I.D. of pre-drilled hole
- D = Grommet overall outside diameter
- E = Grommet thickness

IBS No.	Bore ID (A)	Groove Width (B)	Groove Diameter (C)	Outside Diameter (D)	Overall Thickness (E)	Qty
A-4410	5/32	1/16	1/4	3/8	3/16	25
A-4413	3/16	1/16	5/16	1/2	1/4	25
A-4414	3/16	3/32	9/32	3/8	5/16	25
A-16454	1/4	1/16	3/8	1/2	3/16	25
A-4419	5/16	1/16	7/16	9/16	3/16	25
A-4423	3/8	1/16	1/2	5/8	9/32	25
A-4428	1/2	3/32	3/4	31/32	9/32	25
A-16458	1/2	1/8	3/4	1	1/2	25
A-4430	1/2	1/4	13/16	1-1/16	1/2	25
A-4432	5/8	1/16	7/8	1-1/8	5/16	25
A-4433	3/4	1/16	15/16	1-1/8	1/4	25

Grommet Kit (Z02)

IBS No. 230R • 11 Items • 220 Pieces
Packaged in a locking steel drawer for easy storage and organization



IBS, Inc. QUALITY PRODUCTS FOR MAINTENANCE & REPAIR INDUSTRIALBOLT.COM © P.C. 888-678-1808		Grommet Kit	
Assortment No. 230R			
A-4410 5/32ID X 1/16 GROOVE RUBBER	A-4413 3/16ID X 1/16 GROOVE RUBBER	A-4414 3/16ID X 3/32 GROOVE RUBBER	
A-16454 1/4ID X 1/16 GROOVE RUBBER	A-4419 5/16ID X 1/16 GROOVE RUBBER	A-4433 3/8ID X 1/16 GROOVE RUBBER	
A-4428 1/2ID X 3/32 GROOVE RUBBER	A-16458 1/2ID X 1/8 GROOVE RUBBER	A-4432 5/8ID X 1/16 GROOVE RUBBER	
A-4433 3/4ID X 1/16 GROOVE RUBBER	A-4430 1/2ID X 1/4 GROOVE RUBBER		

ELECTRICAL



IBS, INCORPORATED

Automotive Bulbs Q03

E
L
E
C
T
R
I
C
A
L

	IBS No.	Volts	Function	Candle Power	Life (hrs)	Base	Pkg Qty
	B37	14	Instrument	.5 c.p.	2500	Wedge	10
	B53	14.4	Instrument	1 c.p.	1000	Min Bay	10
	B57	14	Instrument Side Marker	2 c.p.	500	Min Bay	10
	B67	13.5	Parking	4 c.p.	5000	S.C. Bayonet	10
	B73	14	Miniature Wedge	0.3 c.p.	15,000	Wedge	10
	B89	13	Courtesy Dome	6 c.p.	750	S.C. Bayonet	10
	B90	12	Parking Dome Instrument	6 c.p.	750	Mini Base	10
	B93	12	Instrument	15 c.p.	200	S.C. Bayonet	10
	B97	13.5	License Parking	4 c.p.	5000	S.C. Bayonet	10
	B168	14	Side Marker	3 c.p.	1500	Wedge	10
	B193	14	Instrument	2 c.p.	2500	Wedge	10
	B194	14	Side Marker	2 c.p.	2500	Wedge	10
	B199	13	Instrument	32 c.p.	1200	Mini Base	10
	B194NA	14	Side Marker Amber	1.5 c.p.	1500	Wedge	10
	B211-2	12	Courtesy Dome	12 c.p.	1000	Miniature Cap	10
	B561	13	Instrument	12 c.p.	1000	Rigid Loop Base	10
	B623	28	Courtesy Dome	6 c.p.	1000	S.C. Bayonet	10
	B624	28	HD Truck Instrument	6 c.p.	1000	D.C. Bayonet	10
	B904	14	Instrument	6 c.p.	1000	Wedge	10
	B906	13	Instrument	6 c.p.	1000	Wedge	10
	B912	12.8	Side Marker / Dome	12 c.p.	1000	Wedge	10
	B916	13.5	Side Marker / Dome	2 c.p.	10,000	Wedge	10
	B916NA	13	Side Marker / Amber	1.5 c.p.	10,000	Wedge	10























S.C. = SINGLE CONTACT D.C. = DOUBLE CONTACT MIN. = MINIATURE

IBS, INCORPORATED

Automotive Bulbs Q03



ELECTRICAL

	IBS No.	Volts	Function	Candle Power	Life (hrs)	Base	Pkg Qty
	B921	12.8	Side Marker / Dome	21 c.p.	500	Wedge	10
	B922	13.0	Instrument	15 c.p.	200	Wedge	10
	B1003	12.8	Side Marker / Dome	15 c.p.	200	S.C. Bayonet	10
	B1004	12.8	Dome / Courtesy	15 c.p.	200	D.C. Bayonet	10
	B1034	12.8	Stop & Turn	3.2 c.p.	200	D.C. Index	10
	B1073	12.8	Front Turn	32 c.p.	200	S.C. Bayonet	10
	B1076	12.8	Front Turn	32 c.p.	200	D.C. Bayonet	10
	B1141	12.8	Rear Turn	21 c.p.	1000	S.C. Bayonet	10
	B1142	12.8	General Purpose	21 c.p.	1000	D.C. Bayonet	10
	B1156	12.8	Front & Rear Turn	32 c.p.	1200	S.C. Bayonet HD	10
	B1157	12.8	Stop / Tail / Turn	32 c.p.	1200	D.C. Index HD	10
	B1157NA	12.8	Stop / Tail / Turn Amber	24 c.p.	1200	D.C. Index HD	10
	B1662	28	Construction Equipment	32 c.p.	400 to 1000	D.C. Bayonet	10
	B1683	28	Stop / Turn H.D. Truck	32 c.p.	500	S.C. Bayonet	10
	B1816	13.0	Instrument	3 c.p.	1000	Min. Bayonet	10
	B1891	14.0	Instrument	2 c.p.	7500	Bayonet	10
	B1893	14.0	Instrument	2 c.p.	7500	Min. Bayonet	10
	B1895	14.0	Instrument	2 c.p.	2000	Min. Bayonet	10
	B2057	12.8	Stop / Turn / Tail	32 c.p. 2 c.p.	1200 5000	D.C. Index	10
	B2057NA	12.8	Stop / Turn / Tail Amber	32 c.p. 2 c.p.	1200 5000	D.C. Index	10
	B3057	12.8	Stop / Turn / Tail	32 c.p. 2 c.p.	1200 5000	Wedge	10
	B3057NA	12.8	Stop / Turn / Tail	24c.p. 2 c.p.	1200 5000	Wedge	10
	B3156	12.0	Stop / Turn	32 c.p.	1200	Wedge	10

S.C. = SINGLE CONTACT D.C. = DOUBLE CONTACT MIN. = MINIATURE



IBS, INCORPORATED

Automotive Bulbs Q03

ELECTRICAL

	IBS No.	Volts	Function	Candle Power	Life (hrs)	Base	Pkg Qty
	B3157	12.0	Stop / Turn / Tail	32 c.p. 3 c.p.	1200 5000	Wedge	10
	B3157NA	12.0	Stop / Turn / Tail	24 c.p. 2.2 c.p.	1200 5000	Wedge	10
	B3457	14.0	Stop / Turn / Tail	40 c.p. 3 c.p.	400 5000	Plastic Wedge	10
	B3357NA	12.8	Stop / Turn / Tail	30 c.p.	400	Wedge	10
	B3457NA	14.0		2.2 c.p.	5000		
	B4157NA	12.0	Stop / Turn / Tail	32 c.p. 3 c.p.	1200 5000	Plastic Wedge	10
	B7443	12.0	Stop / Turn Tail	3.5 c.p.	500	Wedge	10
	B9004	12.8	Halogen Headlight Bulb	45 to 65 Watts	320 to 150	Halogen Capsule	2
	B9006	12.0	Halogen Headlight Bulb	55 Watts	450	Halogen Capsule	2
	B9007	12.8	Halogen Headlight Bulb	55 to 65 Watts	1100 to 150	Halogen Capsule	6
	PR-2	2.38	Flashlight	.8 c.p.	15	S.C. Min Flanged	10
	5457A	Instrument Panel Bulb Socket Holder Use with B194 & B194NA				1/2 Hole	5
	5458A	Instrument Panel Bulb Socket Holder Use with B194 & B194NA				5/8 Hole	5

S.C. = SINGLE CONTACT D.C. = DOUBLE CONTACT MIN. = MINIATURE

IBS, INCORPORATED

Assortments Z02



















Automotive Bulbs

IBS No. 327R • 16 Items • 160 Pcs

Packaged in a locking steel drawer for easy storage and organization



























IBS, Inc. SPECIALTY PRODUCTS FOR MAINTENANCE & REPAIR INDUSTRIALBOLT.COM © © © 800-678-1906		Automotive Bulbs			
Assortment No. 327R					
B194 #194 12V INSTRUMENT / SIDE 	B194NA 12V AMBER PARKING / SIDE 	B1893 12V HD AUTO INSTRUMENT LIGHT 	B1895 12V PARKING / SIDE MARKER 	B53 12V AUTO INSTRUMENT LIGHT 	
B57 12V AUTO INSTRUMENT LIGHT 	B1157 12V STOP - TURN - SIGNAL LIGHT 	B1157NA 12V STOP - TAIL - SIGNAL LIGHT 	B3157 12V STOP - TAIL - TURN LIGHT 	B3157NA 12V STOP - TAIL - TURN LIGHT 	
B2057 12V STOP - TAIL - TURN LIGHT 	B3057 12V STOP - TAIL - TURN LIGHT 	B1156 12V FRONT & REAR TURN LIGHT 	B3156 12V FRONT & REAR TURN LIGHT 		
B916 12V PARKING / SIDE MARKER 	B97 12V PARKING / LICENSE PLATE 				

12V Mini Auto Bulbs

IBS No. 722R • 24 Items • 186 Pcs

Packaged in a locking steel drawer for easy storage and organization



IBS, Inc. SPECIALTY PRODUCTS FOR MAINTENANCE & REPAIR INDUSTRIALBOLT.COM © © © 800-678-1906		12V Miniature Auto Bulb Assortment			
Assortment No. 722R					
B37 14V AUTO AIR COURTESY DOME IND AUTOMOTIVE BULB GLASS WEDGE 	B53 12V AUTO INSTRUMENT INDICATOR AUTOMOTIVE BULB MINI BASE 	B57 12V AUTO INSTRUMENT INDICATOR AUTOMOTIVE BULB MINI BASE 	B67 12V PARKING DOME INDICATOR AUTOMOTIVE BULB MINI BASE 	B89 12V PARKING DOME INSTRUMENT AUTOMOTIVE BULB MINI BASE 	B97 12V PARKING LICENSE PLATE AUTOMOTIVE BULB MINI BASE 
B194 12V INSTRUMENT SIDE MARKER AUTOMOTIVE BULB GLASS WEDGE 	B194NA 12V SIDE MARKER PARK AMBER AUTOMOTIVE BULB 	B906 12V SIDE MARKER DOME AUTOMOTIVE BULB 	B912 12V SIDE MARKER DOME AUTOMOTIVE BULB 	B916 12V PARKING SIDE MARKER AUTOMOTIVE BULB 	B921 12V SIDE MARKER DOME AUTOMOTIVE BULB 
B1156 12V FRONT REAR TURN LIGHT AUTOMOTIVE BULB 	B1157 12V STOP TURN SIGNAL LIGHT AUTOMOTIVE BULB 	B1157NA 12V STOP TAIL SIGNAL AMBER AUTOMOTIVE BULB 	B1893 14V HD INSTRUMENT MINI BASE AUTOMOTIVE BULB 	B1895 12V PARKING SIDE MARKER AUTOMOTIVE BULB 	B2057 12V STOP TAIL TURN LIGHT AUTOMOTIVE BULB 
B3057 12V STOP TAIL TURN LIGHT AUTOMOTIVE BULB PLASTIC WEDGE 	B3156 12V FRONT REAR TURN LIGHT AUTOMOTIVE BULB PLASTIC WEDGE 	B3157 12V STOP TAIL TURN LIGHT AUTOMOTIVE BULB PLASTIC WEDGE 	B3157NA 12V STOP TAIL TURN LIGHT AMBER AUTOMOTIVE BULB PLASTIC WEDGE 	5457A INSTRUMENT PANEL BULB SOCKET HOLDER 1/2 HOLE 	5458A INSTRUMENT PANEL BULB SOCKET HOLDER 5/8 HOLE 
				For Bulb B194 & B194NA	For Bulb B194 & B194NA



IBS, INCORPORATED

Automotive Electrical Q03

Glass Tube Fuses

Glass Fuses are widely used in electronic and electrical applications where proper fuse selection is critical to performance. Quality fuses provide safety and reliability by preventing short circuits and overloads that can cause fires and damage.

- For electronic/electrical applications, fuse must be rated at 125V or better.
- Voltage must match or exceed the fuse being replaced (125V household current; 12V for auto; 24V for heavy duty).
- Amperage must match that of the old fuse.



AGA
1/4 x 5/8

IBS No.	AMP	Volt	Qty
AGA1	1	125	5
AGA2	2	125	5
AGA3	3	125	5
AGA5	5	125	5
AGA10	10	32	5
AGA15	15	32	5
AGA20	20	32	5
AGA25	25	32	5
AGA30	30	32	5



AGX
1/4 x 1

IBS No.	AMP	Volt	Qty
AGX3	3	125	5
AGX15	15	32	5
AGX20	20	32	5
AGX25	25	32	5
AGX30	30	32	5



AGC
1/4 x 1-1/4

IBS No.	AMP	Volt	Qty
AGC1	1	250	5
AGC2	2	250	5
AGC2-1/2	2.5	250	5
AGC3	3	250	5
AGC4	4	250	5
AGC5	5	250	5
AGC6	6	250	5
AGC7-1/2	7.5	250	5
AGC8	8	250	5
AGC10	10	250	5
AGC15	15	32	5
AGC20	20	32	5
AGC25	25	32	5
AGC30	30	32	5
AGC35	35	32	5
AGC40	40	32	5



SFE

IBS No.	AMP	Size	Qty
SFE4	4	1/4 x 5/8	5
SFE6	6	1/4 x 3/4	5
SFE7-1/2	7.5	1/4 x 7/8	5
SFE9	9	1/4 x 1	5
SFE14	14	1/4 x 1-1/6	5
SFE20	20	1/4 x 1-1/4	5
SFE30	30	1/4 x 1-7/8	5



AGW

1/4 x 7/8 32 Volt

IBS No.	AMP	Qty
AGW1	1	5
AGW2-1/2	2.5	5
AGW4	4	5
AGW5	5	5
AGW6	6	5
AGW7-1/2	7.5	5
AGW15	15	5
AGW20	20	5
AGW30	30	5
AGW35	35	5



GBC

1/4 x 31/32 32 Volt

IBS No.	AMP	Qty
GBC2-1/2	2.5	5
GBC5	5	5
GBC8	8	5
GBC16	16	5
GBC25	25	5

FUSE PULLER



IBS No.	Description	Qty
FP-C	Dual purpose — pulls and installs both blade type and glass tube fuses. Single piece design made of durable plastic.	1

ELECTRICAL

IBS, INCORPORATED

Automotive Electrical Q03



ATR Micro Blade-Type Fuses

For single-circuit protection. A sub-miniature design that meets the need for more circuits to be protected while utilizing less space and its ability to cope with high temperatures in adverse environments makes it the recommended choice for newer vehicles.

Photo	IBS No.	AMP	Volts	Color	Qty	Photo	IBS No.	AMP	Volts	Color	Qty
	ATR5	5	32	Tan	5		ATR20	20	32	Yellow	5
	ATR7-1/2	7-1/2	32	Brown	5		ATR25	25	32	Clear	5
	ATR10	10	32	Red	5		ATR30	30	32	Green	5
	ATR15	15	32	Blue	5						

ATL Micro 3 Blade-Type Fuses

For dual-circuit protection in one fuse. It has 3 terminals and 2 fuse elements with a common center terminal. Its sub-miniature design meets the need for more circuits to be protected while utilizing less space and its ability to cope with high temperatures in adverse environments makes it a recommended choice for newer vehicles.

Photo	IBS No.	AMP	Volts	Color	Qty	Photo	IBS No.	AMP	Volts	Color	Qty
	ATL5	5	32	Tan	5		ATL10	10	32	Red	5
	ATL7-1/2	7-1/2	32	Brown	5		ATL15	15	32	Blue	5

ATR, ATL & ATM Low Profile Fuses Assortment (Z02)

IBS No. 822R • 18 Items • 160 Pcs

Packaged in a locking steel drawer for easy storage and organization

IBS, Inc. SPECIALTY PRODUCTS FOR MAINTENANCE & REPAIR INDUSTRIALBOLT.COM © 2013 800-678-1306		ATR, ATL & ATM Low-Profile Fuses			Assortment No. 822R
ATR5 5AMP MICRO2 FUSE 32V TAN FUSE 	ATR7-1/2 7-1/2AMP MICRO2 FUSE 32V BROWN FUSE 	ATR10 10AMP MICRO2 FUSE 32V RED FUSE 	ATR15 15AMP MICRO2 FUSE 32V BLUE FUSE 	ATR20 20AMP MICRO2 FUSE 32V YELLOW FUSE 	
ATR25 25AMP MICRO2 FUSE 32V CLEAR FUSE 	ATR30 30AMP MICRO2 FUSE 32V GREEN FUSE 	ATL5 5AMP MICRO3 FUSE 32V TAN FUSE 	ATL7-1/2 7-1/2AMP MICRO3 FUSE 32V BROWN FUSE 	ATL10 10AMP MICRO3 FUSE 32V RED FUSE 	
ATL15 15AMP MICRO3 FUSE 32V BLUE FUSE 	ATM5LP AUTO FUSE ATM LOW PROFILE 5AMP 	ATM7-1/2LP AUTO FUSE ATM LOW PROFILE 7-1/2AMP 	ATM10LP AUTO FUSE ATM LOW PROFILE 10AMP 	ATM15LP AUTO FUSE ATM LOW PROFILE 15AMP 	
ATM20LP AUTO FUSE ATM LOW PROFILE 20AMP 	ATM25LP AUTO FUSE ATM LOW PROFILE 25AMP 	ATM30LP AUTO FUSE ATM LOW PROFILE 30AMP 			



IBS, INCORPORATED

Automotive Electrical Q03

































Micro Fuses Assortment (Z02)

IBS No. 766R • 16 Items • 135 Pcs

Packaged in a locking steel drawer for easy storage and organization































ELECTRICAL

IBS, Inc. SPECIALTY PRODUCTS FOR MAINTENANCE & REPAIR INDUSTRIALBOLT.COM 800-678-1906		Micro Fuses		
Assortment No. 766R				
ATR5 5AMP MICRO2 FUSE 32V TAN FUSE  	ATR7-1/2 7-1/2AMP MICRO2 FUSE 32V BROWN FUSE  	ATR10 10AMP MICRO2 FUSE 32V RED FUSE  	ATR15 15AMP MICRO2 FUSE 32V BLUE FUSE  	ATR20 20AMP MICRO2 FUSE 32V YELLOW FUSE  
ATR25 25AMP MICRO2 FUSE 32V CLEAR FUSE  	ATR30 30AMP MICRO2 FUSE 32V GREEN FUSE  	ATL5 5AMP MICRO3 FUSE 32V TAN FUSE  	ATL7-1/2 7-1/2AMP MICRO3 FUSE 32V BROWN FUSE  	ATL10 10AMP MICRO3 FUSE 32V RED FUSE  
ATL15 15AMP MICRO3 FUSE 32V BLUE FUSE  	FMM15 15AMP MCASE FUSE 32V GREY  	FMM20 20AMP MCASE FUSE 32V BLUE  	FMM25 25AMP MCASE FUSE 32V WHITE  	FMM30 30AMP MCASE FUSE 32V PINK  
FMM40 40AMP MCASE FUSE 32V GREEN  				

Micro Fuses Travel Tray Assortment (Z02)

IBS No. 803R • 11 Items • 55 Pcs

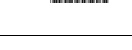
Packaged in a locking plastic travel tray for easy storage and organization

IBS, Inc. SPECIALTY PRODUCTS FOR MAINTENANCE & REPAIR INDUSTRIALBOLT.COM 800-678-1906		ATR Micro2 and ATL Micro3 Blade Fuses		
Assortment 803R				
ATR5 5AMP MICRO2 FUSE 32V TAN FUSE  	ATR10 10AMP MICRO2 FUSE 32V RED FUSE  	ATR20 20AMP MICRO2 FUSE 32V YELLOW FUSE  	ATR30 30AMP MICRO2 FUSE 32V GREEN FUSE  	ATL7-1/2 7-1/2AMP MICRO3 FUSE 32V BROWN FUSE  
ATR7-1/2 7-1/2AMP MICRO2 FUSE 32V BROWN FUSE  	ATR15 15AMP MICRO2 FUSE 32V BLUE FUSE  	ATR25 25AMP MICRO2 FUSE 32V CLEAR FUSE  	ATL5 5AMP MICRO3 FUSE 32V TAN FUSE  	ATL10 10AMP MICRO3 FUSE 32V RED FUSE  
				       



IBS, INCORPORATED

Automotive Electrical Q03



ATM Low Profile Blade-Type Fuses

Popular for late model vehicles, these compact, low-profile ATM fuses save space and feature an enclosed element for protection against shock and sparks. This is a low profile version of the ATM fuse using the same ratings and universal color-coding as ATM and ATC style fuses.

Photo	IBS No.	AMP	Volts	Color	Qty	Photo	IBS No.	AMP	Volts	Color	Qty
	ATM5LP	5	12	Tan	5		ATM20LP	20	12	Yellow	5
	ATM7-1/2LP	7-1/2	12	Brown	5		ATM25LP	25	12	Clear	5
	ATM10LP	10	12	Red	5		ATM30LP	30	12	Green	5
	ATM15LP	15	12	Light Blue	5						

ATM Low Profile Fuses Travel Tray(Z02)

IBS No. 721R • 7 Items • 35 Pcs

Packaged in a locking plastic tray for easy storage and organization



ATM Low Profile Fuses

Assortment No. 721R

 ATM5LP AUTO FUSE ATM LOW PROFILE 5AMP 	 ATM10LP AUTO FUSE ATM LOW PROFILE 10 AMP 	 ATM15LP AUTO FUSE ATM LOW PROFILE 15 AMP 	 ATM20LP AUTO FUSE ATM LOW PROFILE 20 AMP 	 ATM25LP AUTO FUSE ATM LOW PROFILE 25 AMP 	 ATM30LP AUTO FUSE ATM LOW PROFILE 30 AMP 
---	--	--	--	--	--



ELECTRICAL



IBS, INCORPORATED

Automotive Electrical Q03

ATM Blade-Type Fuses

Introduced in the early 90's, ATM fuses are quickly growing in popularity for late model OEM applications. ATM Fuses use the same universal color coding as ATC style. These fuses feature an enclosed element offering protection against shocks and sparks plus corrosion resistance for longer service life.

Photo	IBS No.	AMP	Volts	Color	Qty	Photo	IBS No.	AMP	Volts	Color	Qty
	ATM2	2	12	Gray	5		ATM10	10	12	Red	5
	ATM3	3	12	Violet	5		ATM15	15	12	Light Blue	5
	ATM4	4	12	Pink	5		ATM20	20	12	Yellow	5
	ATM5	5	12	Tan	5		ATM25	25	12	Clear	5
	ATM7-1/2	7.5	12	Brown	5		ATM30	30	12	Green	5

ATM Blade-Type Fuses Travel Tray

IBS No. 127R • 6 Items • 60 Pcs

Packaged in a locking plastic tray for easy storage and organization



ELECTRICAL



ATC Blade-Type Fuses

ATC Blade fuses were introduced in the late 1970s and are still widely used by automotive OEM's. Our ATC products use the industry's universal color coding to indicate the amperage, and feature an enclosed element — offering protection against shocks and sparks, plus corrosion resistance for a longer service life.

Photo	IBS No.	AMP	Volts	Color	Qty	Photo	IBS No.	AMP	Volts	Color	Qty
	ATC1	1	12	Black	5		ATC10	10	12	Red	5
	ATC2	2	12	Gray	5		ATC15	15	12	Light Blue	5
	ATC3	3	12	Violet	5		ATC20	20	12	Yellow	5
	ATC4	4	12	Pink	5		ATC25	25	12	Clear	5
	ATC5	5	12	Tan	5		ATC30	30	12	Green	5
	ATC7-1/2	7.5	12	Brown	5		ATC40	40	12	Orange	5

ATC Blade-Type Fuses Travel Tray (Z02)

IBS No. 792R • 8 Items • 40 Pcs

Packaged in a locking plastic tray for easy storage and organization

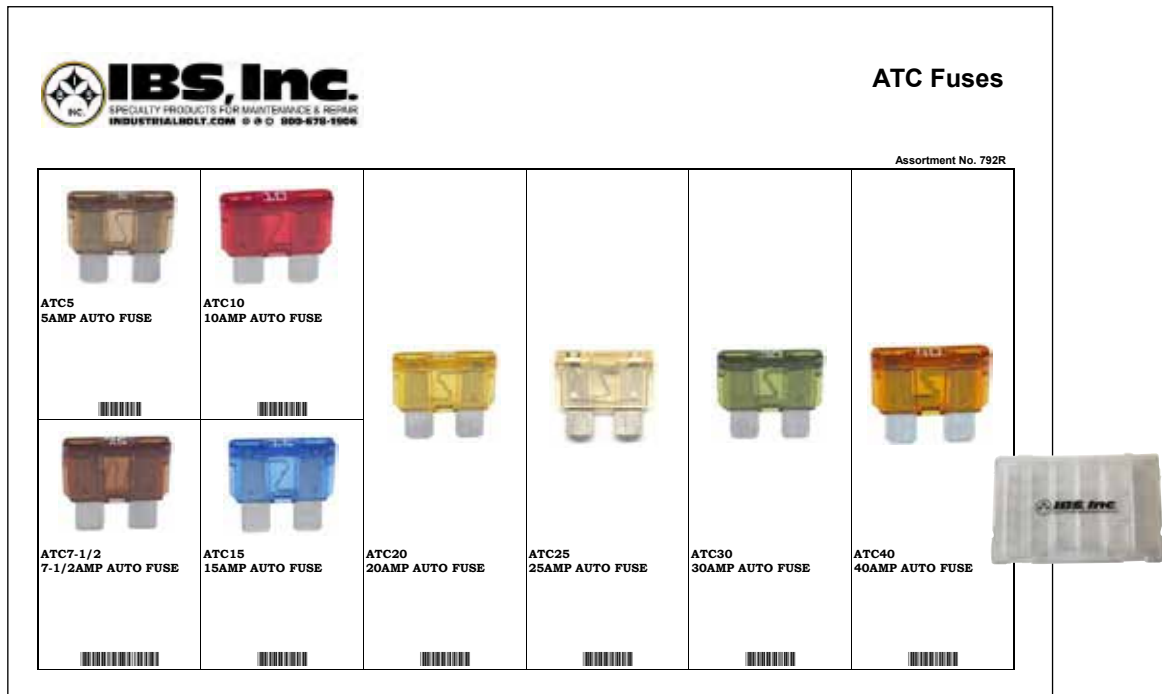

ELECTRICAL



IBS, INCORPORATED

Assortments Z02

MAXI Blade-Type Fuses

Maxi Fuses are used to protect circuits in the wiring harness — usually found under the hood, in a fuse panel, or supplementary panel near the battery. Primarily used in domestic cars, MAX fuses also have some applications in imported models. OEM applications currently range up to 60 amps; however, some aftermarket accessories (such as high-end stereos) require protection to 80 amps.

Photo	IBS No.	AMP	Volts	Color	Qty	Photo	IBS No.	AMP	Volts	Color	Qty
	MAX20	20	32	Yellow	1		MAX50	50	32	Red	1
	MAX25	25	32	Gray	1		MAX60	60	32	Blue	1
	MAX30	30	32	Green	1		MAX70	70	32	Tan	1
	MAX40	40	32	Orange	1		MAX80	80	32	Clear	1

ELECTRICAL

MAXI Blade-Type Fuses Travel Tray (Z02)

IBS No. 128R • 7 Items • 31 Pcs

Packaged in a locking plastic tray for easy storage and organization

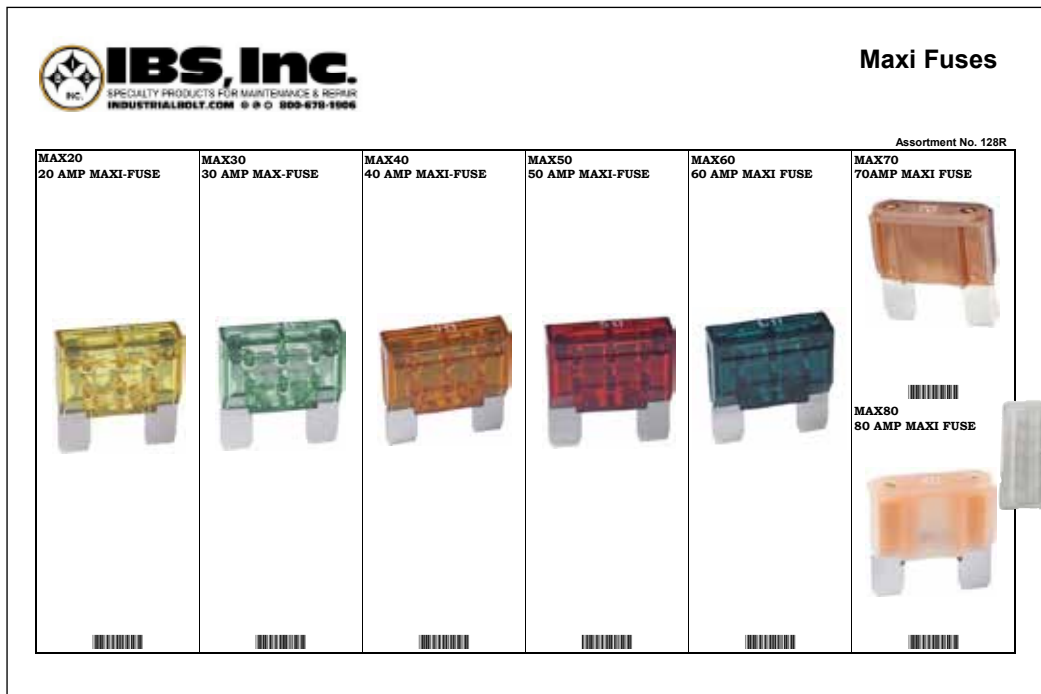

IBS, INCORPORATED

Assortments Z08



Blade Fuses (Z02)

IBS No.720R • 29 Items • 127 Pcs

Packaged in a locking steel drawer for easy storage and organization





IBS, Inc.
SPECIALTY PRODUCTS FOR MAINTENANCE & REPAIR
INDUSTRIALBOLT.COM • 800-678-1906

Blade Fuses
ATM, ATC and MAX

720R							
ATM2 	ATM3 	ATM4 	ATM5 	ATM7-1/2 	ATM10 	ATM15 	ATM20 
ATM25 	ATM30 	ATC2 	ATC3 	ATC4 	ATC5 	ATC7-1/2 	ATC10 
ATC15 	ATC20 	ATC25 	ATC30 	ATC40 			
MAX20 	MAX30 	MAX40 	MAX50 	MAX60 	MAX70 	MAX80 	FP-C FUSE PULLER 

Auto Electrical Fuses

IBS No. 290P • 37 Items • 235 Pcs





































Packaged in a locking steel drawer for easy storage and organization





IBS, Inc.
SPECIALTY PRODUCTS FOR MAINTENANCE & REPAIR
INDUSTRIALBOLT.COM • 800-678-1906

Automotive Electrical Fuses

Assortment No. 290P							
AGA15 AUTO FUSE 	AGA20 AUTO FUSE 	AGA30 AUTO FUSE 		SFE7-1/2 AUTO FUSE GLASS TUBE 	SFE14 AUTO FUSE GLASS TUBE 	SFE20 AUTO FUSE GLASS TUBE 	SFE30 AUTO FUSE GLASS TUBE 
AGC1 AUTO FUSE 	AGC4 AUTO FUSE 	AGC7-1/2 AUTO FUSE 	AGC10 AUTO FUSE 	AGC15 AUTO FUSE 	AGC20 AUTO FUSE 	AGC25 AUTO FUSE 	AGC30 AUTO FUSE 
ATC5 AUTO FUSE 	ATC10 AUTO FUSE 	ATC15 AUTO FUSE 	ATC20 AUTO FUSE 	ATC25 AUTO FUSE 	ATC30 AUTO FUSE 	EL-13 HVY DUTY 3 PRONG TRUCK FLASHER FLASHER 	
ATM5 AUTO FUSE 	ATM10 AUTO FUSE 	ATM15 AUTO FUSE 	ATM20 AUTO FUSE 	ATM25 AUTO FUSE 	ATM30 AUTO FUSE 	EL-13 HVY DUTY 3 PRONG TRUCK FLASHER FLASHER 	
19518 GLASS TUBE WATER-PROOF IN-LINE 		19513 BLADE TYPE WATER-PROOF IN-LINE FUSE HLDR 				FP-C FUSE PULLER 	
0690T 12 VOLT TESTER 				1588A 3/8 TEST CLIP JAW 	MAX20 20 AMP MAXI FUSE YELLOW 	MAX30 30 AMP MAX FUSE GREEN 	MAX40 40 AMP MAXI FUSE ORANGE 

ELECTRICAL



IBS, INCORPORATED

Automotive Electrical Q03

LED Smart Fuses

Blade Type Fuses with LED Indicator

The integrated LED on the top of the fuse glows brightly if the fuse is blown. This eliminates the guesswork and speeds the replacement of the blown fuse. The color-coded fuses instantly let you know the right amperage of the fuse to be replaced. These fuses snap into place without the use of special tools and provide easy identification of blown fuses in hard-to-reach locations.

ATM BLADE-TYPE

Photo	IBS No.	AMP	Volts	Color	Qty	Photo	IBS No.	AMP	Volts	Color	Qty
	139212	5	32	Amber	5		139216	20	32	Yellow	5
	139214	10	32	Red	5		139217	25	32	Clear	5
	139215	15	32	Blue	5		139218	30	32	Green	5

ATO/ATC BLADE-TYPE

Photo	IBS No.	AMP	Volts	Color	Qty	Photo	IBS No.	AMP	Volts	Color	Qty
	139222	5	32	Amber	5		139226	20	32	Yellow	5
	139224	10	32	Red	5		139227	25	32	Clear	5
	139225	15	32	Blue	5		139228	30	32	Green	5

MAXI BLADE-TYPE

Photo	IBS No.	AMP	Volts	Color	Qty	Photo	IBS No.	AMP	Volts	Color	Qty
	139411	20	12	Yellow	1		139414	50	12	Red	1
	139412	30	12	Green	1		139415	60	12	Blue	1
	139413	40	12	Orange	1		139416	80	12	Clear	1

ELECTRICAL

IBS, INCORPORATED

Assortments Z02



LED Smart Fuses

IBS No. 364R • 22 Items • 76 Pcs
 Packaged in a locking steel drawer for easy storage and organization



IBS Inc. INDUSTRIALBLADE.COM © D © 800-878-1808						LED Smart Fuses
Assortment No. 364R						
139212 ATM 5 Amp Mini / Amber	139214 ATM 10 Amp Mini / Red	139215 ATM 15 Amp Mini / Blue	139216 ATM 20 Amp Mini / Yellow	139217 ATM 25 Amp Mini / Clear	139447 ATM Mini In-Line Clear Cover Fuseholder	
139218 ATM 30 Amp Mini / Green		139222 ATC 5 Amp Amber	139224 ATC 10 Amp Red	139225 ATC 15 Amp Blue	139450 ATC In-Line Clear Cover Fuseholder	
139226 ATC 20 Amp Yellow	139227 ATC 25 Amp Clear	139228 ATC 30 Amp Green		139411 MAXI 20 Amp Yellow	139425 MAXI In-Line Fuseholder with Cover	
139412 MAXI 30 Amp Green	139413 MAXI 40 Amp Amber	139414 MAXI 50 Amp Red	139415 MAXI 60 Amp Blue	139416 MAXI 80 Amp Clear		

ATM LED Smart Fuses

IBS No. 360R • 6 Items • 36 Pcs
 Packaged in a clear plastic box for easy storage and organization



IBS Inc. INDUSTRIALBLADE.COM © D © 800-878-1808						ATM Mini Blade LED Smart Fuses
Assortment No. 360R						
139212 5AMP ATM STYLE LED SMART FUSE	139214 10AMP ATM STYLE LED SMART FUSE	139215 15AMP ATM STYLE LED SMART FUSE	139216 20AMP ATM STYLE LED SMART FUSE	139217 25AMP ATM STYLE LED SMART FUSE	139218 30AMP ATM STYLE SMART FUSE	

ATC LED Smart Fuses

IBS No. 361R • 6 Items • 42 Pcs
 Packaged in a clear plastic box for easy storage and organization



IBS Inc. INDUSTRIALBLADE.COM © D © 800-878-1808						ATC Standard Blade LED Smart Fuses
Assortment No. 361R						
139222 5AMP ATC STYLE LED SMART FUSE	139224 10AMP ATC STYLE LED SMART FUSE	139225 15AMP ATC STYLE LED SMART FUSE	139226 20AMP ATC STYLE LED SMART FUSE	139227 25AMP ATC STYLE LED SMART FUSE	139228 30AMP ATC STYLE LED SMART FUSE	

MAXI Blade LED Smart Fuses

IBS No. 362R • 6 Items • 18 Pcs
 Packaged in a clear plastic box for easy storage and organization



IBS Inc. INDUSTRIALBLADE.COM © D © 800-878-1808						Maxi Blade LED Smart Fuses
Assortment No. 362R						
139411 20AMP MAXI STYLE LED SMART FUSE	139412 30AMP MAXI STYLE LED SMART FUSE	139413 40AMP MAXI STYLE LED SMART FUSE	139414 50AMP MAXI STYLE LED SMART FUSE	139415 60AMP MAXI STYLE LED SMART FUSE	139416 80AMP MAXI STYLE LED SMART FUSE	

ELECTRICAL



IBS, INCORPORATED

Automotive Electrical Q03

Cartridge Fuses

Developed to meet the growing OEM demand for smaller components, these fuses offer high amp protection in compact packages. Most are available in amp ratings from 15 to 60A.

FMX FUSES

Photo	IBS No.	AMP	Color	Qty	Photo	IBS No.	AMP	Color	Qty
	FMX-20	20	Blue	2		FMX-40	40	Green	2
	FMX-25	25	White	2		FMX-50	50	Red	2
	FMX-30	30	Pink	2		FMX-60	60	Yellow	2

FMX LOW-PROFILE FUSES

Photo	IBS No.	AMP	Color	Qty	Photo	IBS No.	AMP	Color	Qty
	FMX-20LP	20	Blue	2		FMX-40LP	40	Green	2
	FMX-25LP	25	White	2		FMX-50LP	50	Red	2
	FMX-30LP	30	Pink	2		FMX-60LP	60	Yellow	2

FMM FUSES

Photo	IBS No.	AMP	Color	Qty	Photo	IBS No.	AMP	Color	Qty
	FMM15	15	Grey	1		FMM30	30	Pink	1
	FMM20	20	Blue	1		FMM40	40	Green	1
	FMM25	25	White	1					

FMS FUSES

Photo	IBS No.	AMP	Color	Qty	Photo	IBS No.	AMP	Color	Qty
	FMS-15	15	Gray	1		FMS-40	40	Green	1
	FMS-20	20	Blue	1		FMS-50	50	Red	1
	FMS-25	25	White	1		FMS-60	60	Yellow	1
	FMS-30	30	Pink	1					

ELECTRICAL

IBS, INCORPORATED

Assortments Z02



Micro Cartridge Fuses

IBS No. 823R • 24 Items • 48 Pcs

Packaged in a locking steel drawer for easy storage and organization

 Micro Cartridge Fuses					
Assortment No. 823R					
FMX-20 20AMP BLUE MAXI FUSE JCASE 	FMX-25 25AMP WHITE MAXI FUSE JCASE 	FMX-30 30AMP PINK MAXI FUSE JCASE 	FMX-40 40AMP GREEN MAXI FUSE JCASE 	FMX-50 50AMP RED MAXI FUSE JCASE 	FMX-60 60AMP YELLOW MAXI FUSE JCASE 
FMX-20LP 20AMP BLUE LP MAXI FUSE JCASE LP - LOW PROFILE 	FMX-25LP 25AMP WHITE LP MAXI FUSE JCASE LP - LOW PROFILE 	FMX-30LP 30AMP PINK LP MAXI FUSE JCASE LP - LOW PROFILE 	FMX-40LP 40AMP GREEN LP MAXI FUSE JCASE LP - LOW PROFILE 	FMX-50LP 50AMP RED LP MAXI FUSE JCASE LP - LOW PROFILE 	FMX-60LP 60AMP YELLOW LP MAXI FUSE JCASE LP - LOW PROFILE 
FMM15 15AMP MCASE FUSE 32V GRAY 	FMM20 20AMP MCASE FUSE 32V BLUE 	FMM25 25AMP MCASE FUSE 32V WHITE 	FMM30 30AMP MCASE FUSE 32V PINK 	FMM40 40AMP MCASE FUSE 32V GREEN 	FMS15 15AMP MCASE FUSE 32V GRAY SLOTTED 
FMS20 20AMP MCASE FUSE 32V BLUE SLOTTED 	FMS25 25AMP MCASE FUSE 32V WHITE SLOTTED 	FMS30 30AMP MCASE FUSE 32V PINK SLOTTED 	FMS40 40AMP MCASE FUSE 32V GREEN SLOTTED 	FMS50 50AMP MCASE FUSE 32V RED SLOTTED 	FMS60 60AMP MCASE FUSE 32V YELLOW SLOTTED 



FMX Fuse Assortment (Z02)

IBS No. 851R • 6 Items • 12 Pcs

Packaged in a locking steel drawer for easy storage and organization

 FMX Fuses					
Assortment 851R					
FMX-20 20AMP BLUE MAXI FUSE JCASE 	FMX-25 25AMP WHITE MAXI FUSE JCASE 	FMX-30 30AMP PINK MAXI FUSE JCASE 	FMX-40 40AMP GREEN MAXI FUSE JCASE 	FMX-50 50AMP RED MAXI FUSE JCASE 	FMX-60 60AMP YELLOW MAXI FUSE JCASE 



FMX Low Profile Fuse

Assortment (Z02)

IBS No. 852R • 6 Items • 12 Pcs

Packaged in a locking steel drawer for easy storage and organization

 FMX Low Profile Fuses					
Assortment 852R					
FMX-20LP 20AMP BLUE LP MAXI FUSE JCASE LP - LOW 	FMX-25LP 25AMP WHITE LP MAXI FUSE JCASE LP - LOW 	FMX-30LP 30AMP PINK LP MAXI FUSE JCASE LP - LOW 	FMX-40LP 40AMP GREEN LP MAXI FUSE JCASE LP - LOW 	FMX-50LP 50AMP RED LP MAXI FUSE JCASE LP - LOW 	FMX-60LP 60AMP YELLOW LP MAXI FUSE JCASE LP - LOW 



ELECTRICAL



IBS, INCORPORATED

Automotive Electrical Q03

FMM Fuse Assortment (Z02)

IBS No. 853R • 5 Items • 30 Pcs

Packaged in a locking steel drawer for easy storage and organization

FMS Fuse Assortment (Z02)

IBS No. 854R • 7 Items • 35 Pcs

Packaged in a locking steel drawer for easy storage and organization

ELECTRICAL

IBS, Inc.
DESIGNER OF PRODUCTS TO THE MARINE, TRUCKING & AVIATION INDUSTRIES

FMM Fuses

Assortment 853R

FMM15 15AMP MCASE FUSE 32V GRAY	FMM20 20AMP MCASE FUSE 32V BLUE	FMM25 25AMP MCASE FUSE 32V WHITE	FMM30 30AMP MCASE FUSE 32V PINK	FMM40 40AMP MCASE FUSE 32V GREEN



IBS, Inc.
DESIGNER OF PRODUCTS TO THE MARINE, TRUCKING & AVIATION INDUSTRIES

FMS Fuses

Assortment 854R

FMS15 15 AMP MCASE FUSE 32V GRAY SLOTTED	FMS20 20 AMP MCASE FUSE 32V BLUE SLOTTED	FMS25 25 AMP MCASE FUSE 32V WHITE SLOTTED	FMS30 30 AMP MCASE FUSE 32V PINK SLOTTED	FMS40 40 AMP MCASE FUSE 32V GREEN SLOTTED	FMS50 50 AMP MCASE FUSE 32V RED SLOTTED

FMS60
60 AMP MCASE FUSE
32V YELLOW SLOTTED



IBS, INCORPORATED

Automotive Electrical Q03



FUSE HOLDERS

Photo	IBS No.	Description	GA	Fuse Size	Mount	Electrical Connection	Qty
	139433	ATR Micro 2 Add-A-Line Fuse Holder	16	20 amp	—	—	1
	139434	ATR Micro 2 Add-A-Line Fuse Holder	16	15 amp	—	—	1
	139430	ATM Low Profile Add-A-Line Fuse Holder Adds an additional circuit to an existing circuit	16	Prim Max 25A Sec Max 15A	—	—	1
	139421	ATM Fuse Holder & Cover for ATM Mini Blade	12	30 amp	In-line	4" Lead Wires	1
	139431	ATM Fuse Holder & Cover for ATM Mini Blade	16	20 amp	In-line	4" Lead Wires	1
	139420	ATM Add-A-Line Fuse Holder Adds an additional circuit to an existing circuit	16	Prim Max 25A Sec Max 15A	—	—	1
	139428	ATM Fuse Blade Tap 3/16 Push-On Blade	—	—	—	—	25
	139447	ATM Fuse Holder Clear Covered For use with LED Smart Fuses	14	30 amp	In-line	Lead Wires	1
	139422	ATC Fuse Holder & Cover Black Inline	12	30 amp	In-line	Lead Wires	1
	139423	ATC Fuse Holder for ATC Blade	12	30 amp	In-line	4" Lead Wires	1
	139432	ATC Fuse Holder for ATC Blade	16	20 amp	In-line	4" Lead Wires	1
	139424	ATC Fuse Holder Clear Cover Cover Only for ATC Fuse Holder	—	—	Cover for 139423	—	1
	139427	ATC / ATO Add-A-Line Fuse Holder Adds an additional circuit to an existing circuit	16	Prim Max 25A Sec Max 15A	—	—	1
	139429	ATC / ATO Fuse Blade Tap 1/4 Push-On Blade	—	—	—	—	25
	19513	ATC Waterproof Fuse Holder Complete assembly with body & cap	12	30 amps	In-Line	Lead Wires	1
	972	ATC Self-Strip Fuse Holder	NA	0-20 amps	In-Line	Quick Connect 18-14 GA	25
	139450	Clear Covered ATC Fuse Holder For use with LED Smart Fuses	12	30 amp	In-Line	4" Lead Wires	1
	139425	MAXI Fuse Holder & Cover For MAXI Blade	6	60 amp	In-Line	Lead Wires	1
	0905A	Glass Tube Fuse Holder	16	0-15 amps	In-Line	Lead Wires	15
	0906A	Glass Tube Fuse Holder	12	0-30 amps	In-Line	Lead Wires	15
	HFA	Waterproof Fuse Holder	14		In-Line	Lead Wires	1
	19518	Waterproof Glass Tube Fuse Holder	12	1/4 x 1-1/4	In-Line	Lead Wires	1
	HKP	Panel Mount Glass Tube Fuse Holder 250/20A Rating	NA	1/4 x 1-1/4	Panel	Solder Term	1
	139435	J Case Fuse Holder	8	0-60AMPS	In-Line	Red GXL Wire 4" Leads	1

ELECTRICAL



IBS, INCORPORATED

Automotive Fuse Holders & Accessories















IBS No. 723R • 15 Items • 75 Pcs

Packaged in a locking steel drawer for easy storage & organization



Automotive Fuse Holders & Accessories

Assortment No. 723R

<p>139433 ATR MICRO2 ADD A LINE FUSE HOLDER 20AMP 16GA</p> 	<p>139431 ATM 16GA IN LINE FUSE HOLDER 32V 20AMP</p> 	<p>139422 12GA ATC FUSE HOLDER & COVER BLACK IN LINE</p> 	<p>19513 BLADE TYPE WATER-PROOF IN-LINE FUSE HLDR</p> 
<p>139434 ATR MICRO2 INLINE FUSE HOLDER 15AMP 16GA 5IN LEADS</p> 	<p>139420 ATM ADD A LINE FUSE HOLDER 32V 2 FUSE 30A</p> 	<p>139427 ATC ADD A LINE FUSE HOLDER TAP 2 ATO/ATC MAX 30A</p> 	<p>139425 MAXI IN-LINE FUSE HOLDER WITH COVER 32V 60A</p> 
<p>139430 ATM LOW PROFILE ADD-A-LINE FUSE HOLDER</p> 	<p>139447 14GA ATM FUSE HOLDER & COVER CLEAR MINI</p> 	<p>139450 12GA ATC FUSE HOLDER & COVER CLEAR</p> 	<p>139435 FMX INLINE FUSE HOLDER 60AMP 8GA 4IN LEADS 58V</p> 
<p>139421 12GA ATM IN-LINE FUSE HOLDER W/ COVER 32V 30A</p> 	<p>139428 ATM FUSE BLADE TAP .187 TAB</p> 	<p>139429 ATC FUSE BLADE TAP .250 TAB</p> 	



ELECTRICAL

IBS, INCORPORATED

Automotive Electrical Q03



Blade-Type Circuit Breakers

Blade style circuit breakers offer interchangeability with commonly used blade-style fuses, such as ATC, ATM and MAXI. Available in several reset modes that correspond to SAE categories: SAE Type 1 (automatic reset), SAE Type II (modified reset) and SAE Type III (manual reset). Blade-style circuit breakers utilize carefully designed and manufactured snap-acting thermal elements with precious metal electrical units.

MINI BREAKERS

MINI BREAKERS match the blade footprint of ATM fuses. Ultra-thin, to fit in tight spaces, they're the smallest automotive circuit breakers on the market.

Photo	IBS No.	Description	AMP	Volts	Color	Qty
	CB212-10 CB212-15 CB212-20 CB212-25 CB212-30	<ul style="list-style-type: none"> Smallest circuit breaker available Type II, non-cycling, modified reset - remains open as long as power is available or until load is removed. Designed to match ATM fuse footprint. For 12V electrical systems 	10 15 20 25 30	12	Silver	1
	CB233-05 CB233-7-1/2 CB233-10 CB233-15 CB233-20 CB233-25 CB233-30	<ul style="list-style-type: none"> Type III manual reset Remains in the OFF position until button or lever is manually reset. For 12V electrical systems Matches ATM fuse footprint 	5 10 15 20 25 30	12	Tan Brown Red Blue Yellow White Green	1

MAXI-STYLE BREAKERS

MAXI BREAKERS are identical in size to MAXI-style fuses. The only breakers on the market to match the MAXI's footprint and body dimensions. CB1911 can be used to replace MAXI fuses in any application.

Photo	IBS No.	Description	AMP	Volts	Color	Qty
	CB1911-10 CB1911-20 CB1911-30	Brass colored Type 1 breaker with MAXI fuse footprint. 12 Volt.	10 20 30	12	Brass	1
	<p>Type 1 — Automatic Reset Circuit breaker automatically resets after opening. If the fault still exists, the breaker will continue to cycle between ON and OFF positions until the overload is corrected. These devices are sometimes called "cycling breakers."</p> <p>Type II — Modified Reset The circuit breaker will remain "tripped" (in the OFF position) as long as there's power to the circuit, or by turning off the ignition switch. These devices are sometimes called "non-cycling breakers."</p>					

ELECTRICAL



IBS, INCORPORATED

Automotive Electrical Q03

ELECTRICAL

Blade-Type Circuit Breakers

ATC-STYLE BREAKERS

ATC STYLE BREAKERS are designed to fit ATC style fuse panels. These ATC breakers are the thinnest available in the aftermarket and comply with SAE standard J553.

Photo	IBS No.	Description	AMP	Volts	Color	Qty
	CB221-10	• Type I automatic reset	10	12	Brass	1
	CB221-15	• Auto reset until load is corrected	15			
	CB221-20	• 12V electrical systems	20			
	CB221-30	• Matches ATO / ATC fuses	30			
	CCB-25	Replaces OE Part 4527053. Available in 25 AMP Type I	25	12	Silver	1
	CB222-10	• Type II non-cycling modified reset, remains open as long as power is available, or until load is removed. • For 12V electrical systems • Matches ATO / ATC fuses	10	12	Silver	1
	CB222-15		15			
	CB222-20		20			
	CB222-30		30			
	CB223-10	• Type III ATC Circuit Breakers • 24V electrical systems • Complies with SAE J553. • Matches ATO / ATC fuses	10	24	Silver	1
	CB223-15		15			
	CB223-20		20			
	CB223-25		25			
	CB223-30		30			
	CB227-10	• Type III ATC Low Profile Circuit Breakers • Complies with SAE J553 and SAE J1171 for ignition protection.	10	12	Red Blue Yellow White Green	1
	CB227-15		15			
	CB227-20		20			
	CB227-25		25			
	CB227-30		30			
	CBB-30	Type II circuit breakers can be used to replace ATC fuses 12 volt. Available in 30 AMP.	30	12	Silver	1
	FCB-20	Replaces OE part D9AB-14526-BA. Available in 20 AMP Type II.	20	12	Silver	1

UCB BREAKERS

UCB BREAKERS feature "snap off" universal blades which can easily be sized to fit applications where fuseblock spacing is tight, or the fuse terminal is recessed.

Photo	IBS No.	Description	AMP	Volts	Color	Qty
	UCB-10	Universal Type 1 Circuit Breaker 12 Volt	10	12	Red	1
	UCB-15	Universal Type 1 Circuit Breaker 12 Volt	15	12	Blue	1
	UCB-20	Universal Type 1 Circuit Breaker 12 Volt	20	12	Gold	1
	UCB-25	Universal Type 1 Circuit Breaker 12 Volt	25	12	Silver	1
	UCB-30	Universal Type 1 Circuit Breaker 12 Volt	30	12	Green	1

Stud Mount Circuit Breakers

Photo	IBS No.	Description	AMP	Volts	Color	Qty
	CBC-15B	Heavy Duty Type 1 - 12 Volt breaker. Two 10-32 threaded studs and brass plated battery terminal.	15	12	Brass	1
	CBC-20B		20			
	CBC-30B		30			
	CBC-40B		40			
	CBC-50B		50			
Type 1 — Automatic Reset Circuit breaker automatically resets after opening. If the fault still exists, the breaker will continue to cycle between ON and OFF positions until the overload is corrected. These devices are sometimes called "cycling breakers."						
	CBF-20	Type II - 12 volt breaker. CBF circuit breakers can be used to replace glass fuses in 1/4 x 1-1/4 fuse blocks.	20	12	Black	1
	CBF-30		30			
	CBS-10	Standard duty Type II - 12 Volt breaker. Two 10-32 threaded studs.	10	12	Silver	1
	CBS-15		15			
	CBS-20		20			
	CBS-25		25			
	CBS-30		30			
Type II — Modified Reset The circuit breaker will remain "tripped" (in the OFF position) as long as there's power to the circuit, or by turning off the ignition switch. These devices are sometimes called "non-cycling breakers."						

Stud-Mount Fuses

AMG fuses are for high current applications on select late model vehicles and available in ratings from 80 to 500 A. Use with the HMEG fuse block.



IBS No.	AMP	Qty	IBS No.	AMP	Qty
AMG60	60	1	AMG200	200	1
AMG80	80	1	AMG250	250	1
AMG100	100	1	AMG300	300	1
AMG125	125	1	AMG400	400	1
AMG150	150	1	HMEG	FUSE BLOCK	



Fusible Links

Used primarily in Japanese designed car models to provide wiring harness protection. Available in the following styles:



FEMALE FUSIBLE LINKS

IBS No.	AMP	Qty
FLF-20	20	1
FLF-30	30	1
FLF-40	40	1
FLF-50	50	1
FLF-60	60	1



MALE FUSIBLE LINKS

IBS No.	AMP	Qty
FLM-30	30	1
FLM-60	60	1
FLM-80	80	1



IBS, INCORPORATED

Assortments Z02

Automotive Circuit Breakers ATM & ATC Assortment

IBS No. 824R • 31 Items — 46 Pieces

Packaged in a locking steel drawer for easy storage & organization

IBS, Inc. SPECIALTY PRODUCTS FOR MAINTENANCE & REPAIR INDUSTRIALBOLT.COM 800-678-1906		Automotive Circuit Breakers ATM & ATC						Assortment No. 824R
CB212-10 10AMP ATM MINI CIRC BREAKER II	CB212-15 15AMP ATM MINI CIRCUIT BREAKER II	CB212-20 20AMP ATM MINI CIRC BREAKER II	CB212-25 25AMP ATM MINI CIRC BREAKER II	CB212-30 30AMP ATM MINI CIRC BREAKER II	CB233-05 5AMP ATM MINI RESET CB TYPE III	CB233-10 10AMP ATM MINI RESET CB TYPE III	CB233-15 15AMP ATM MINI RESET CB TYPE III	
CB233-20 20AMP ATM MINI RESET CB TYPE III	CB233-25 25AMP ATM MINI RESET CB TYPE III	CB233-30 30AMP ATM MINI RESET CB TYPE III	CB221-10 10AMP ATC CIRCUIT BREAKER TYPE 1	CB221-15 15AMP ATC CIRCUIT BREAKER TYPE 1	CB221-20 20AMP ATC CIRC BREAKER TYPE 1	CB221-25 25AMP ATC CIRCUIT BREAKER TYPE 1	CB221-30 30AMP ATC CIRCUIT BREAKER TYPE 1	
CB223-10 10AMP ATC 24V RESET CB TYPE III	CB223-15 15AMP ATC 24V RESET CB TYPE III	CB223-20 20AMP ATC 24V RESET CB TYPE III	CB223-25 25AMP ATC 24V RESET CB TYPE III	CB223-30 30AMP ATC 24V RESET CB TYPE III	CB227-10 10AMP ATC RESET CB TYPE III RED	CB227-15 15AMP ATC RESET CB TYPE III BLUE	CB227-20 20AMP ATC RESET CB TYPE III YELLOW	
CB227-25 25AMP ATC RESET CB TYPE III WHITE	CB227-30 30AMP ATC RESET CB TYPE III GREEN	UCB-10 10AMP ATM CB SNAP OFF BLADES	UCB-15 15AMP ATM CB SNAP OFF BLADES	UCB-20 20AMP ATM CB SNAP OFF BLADES	UCB-25 25AMP ATM CB SNAP OFF BLADES	UCB-30 30AMP ATM CB SNAP OFF BLADES		

Heavy Duty Truck Circuit Breakers Assortment

IBS No. 340R • 26 Items — 26 Pieces

Packaged in a locking steel drawer for easy storage & organization



IBS, Inc. SPECIALTY PRODUCTS FOR MAINTENANCE & REPAIR INDUSTRIALBOLT.COM 800-678-1906		Heavy Duty Truck Circuit Breakers						Assortment No. 340R
CB1911-10 10AMP MAXI BREAKER	CB1911-20 20AMP MAXI BREAKER	CB1911-30 30AMP MAXI BREAKER	CB212-10 10AMP ATM MINI CIRCUIT BREAKER	CB212-15 15AMP ATM MINI CIRCUIT BREAKER	CB212-20 20AMP ATM MINI CIRCUIT BREAKER	CB212-25 25AMP ATM MINI CIRCUIT BREAKER		
CBC-15B 15AMP STUD MOUNTED	CBC-20B 20AMP STUD MOUNTED	CBC-30B 30AMP STUD MOUNTED	CBC-40B 40AMP STUD MOUNTED	CBC-50B 50AMP STUD MOUNTED	CCB-25 25AMP CIRCUIT BREAKER OE#	FCB-20 20AMP CIRCUIT BREAKER OE#		
UCB-10 10AMP UNIVERSAL CIRCUIT	UCB-15 15AMP UNIVERSAL CIRCUIT	UCB-20 20AMP UNIVERSAL CIRCUIT	UCB-25 25AMP UNIVERSAL CIRCUIT	UCB-30 30AMP UNIVERSAL CIRCUIT	CBF-20 20AMP CIRCUIT BREAKER-GLASS	CBF-30 30AMP CIRCUIT BREAKER-GLASS		
CB221-10 10AMP ATC BLADE BREAKER TYPE 1	CB221-15 15AMP ATC BLADE BREAKER TYPE 1	CB221-20 20AMP ATC BLADE BREAKER TYPE 1	CB221-30 30AMP ATC BLADE BREAKER TYPE 1	CBB-30 30AMP ATC STYLE CIRCUIT				

ELECTRICAL

IBS, INCORPORATED

Automotive Electrical Q03



Electronic Signal Flashers — Extended Life

Tridon's Extended Life Super Duty Electronic Signal Flashers last up to 9 times longer than conventional thermal flashers. Designed for use with trucks, buses, RVs, taxis and passenger cars, they are built tough with heavy duty components throughout.



- Thick Palladium Contact provides longer life under heavy loads.
- Faster Start Time — Only .75 seconds to first flash as compared to 1.5 seconds with ordinary flashers.
- Dependability — Has few moving parts and a thermoplastic cover to help protect the flashers from temperature extremes (-25°F to 145°F).
- Highly audible — Clear distinctive audible signal can be heard in any traffic situation.
- Highly durable — Average life is 800 hours at 10 lamps. Exceeds DOT and SAE specifications J590 and J945 by a factor of 2:1.
- Highly Efficient — Incorporates a positive electromechanical relay in contrast to thermal flashers to achieve the most constant regulated timing of any flasher.

IBS No.	Description	Load	Max. Watts	FPM	Durability (Cycling)	Qty
EL-12	12V - 2 Pin	1 - 10	250	70-100	200 hrs	1
EL-13	12V - 3 Pin	1 - 10	250	70-100	200 hrs	1
EL-13A	12V - 3 Pin Alt*	1 - 6	150	85	150 hrs	1

*EL-13A is an alternating flasher that alternates from side to side.

Heavy Duty Flashers



FLASHERS

DOT Approved • Variable Load

IBS No.	Volts	No. of Terminals	No. of Bulbs	MAX Amps	Qty
EL550	20	3	1 - 6	12.8	1
EL552	30	2	2 - 6	12.8	1

5 Prong Relay



- The best solution for full voltage applicable to head lamps, fog horns, motors for fans, window lifters, air conditioners, heated rear windows, etc.
- Engineered to deliver superior performance over a long life.
- Permissible ambient temperature - 40°C to 85°C.
- Mechanical life — no load = 1,000,000 cycles at +85°C.
- 12 volt; 30/50 amp.

IBS No.	Description	Qty
73984	12V 30/50 AMP 5 Prong Relay	1

ELECTRICAL



IBS, INCORPORATED

Automotive Electrical Q03

ELECTRICAL

Test Clips

- Cadmium plated steel.
- Full meshing teeth.

IBS No.	Jaw Opening	AMP Rating	Qty
1587A	3/16	—	25
1588A	3/8	—	25
0836A	3/4	25	5
0837A	1-1/16	50	5



Spiral Wrap



Expandable spiral cut polyethylene wrap. Wires can enter and break out at any point. Retains strength under repeated flexing. Operating temperature -105°F to 215°F.

IBS No.	Color	I.D.	Length	Qty
5119A	Natural	3/16	100 ft.	1
5120A	Natural	1/4	100 ft.	1
5121A	Natural	3/8	100 ft.	1
5122A	Natural	1/2	100 ft.	1
5123A	Natural	3/4	100 ft.	1
5124A	Natural	1	100 ft.	1
6219A	Black	3/16	100 ft.	1
6220A	Black	1/4	100 ft.	1
6221A	Black	3/8	100 ft.	1
6222A	Black	1/2	100 ft.	1

Fabric Loom



IBS No.	Size	Length	Qty
8212S	3/16	50 ft.	1
8213S	1/4	50 ft.	1
8214S	3/8	50 ft.	1
8215S	1/2	50 ft.	1
8216S	5/8	50 ft.	1
8218S	1	50 ft.	1

Tough, flexible loom. Smooth inside for easy wire insertion. Saturated with an asphalt compound for moisture proofing. Non-metallic material protects against short circuits and undesirable noise.

Convuluted Tubing (Split Loom)



IBS No.	Size	Length	Qty
5140A	1/4	50 ft.	1
5141A	3/8	50 ft.	1
5142A	1/2	50 ft.	1
5143A	3/4	50 ft.	1

Flexible black polyethylene tubing for holding wires in position and protecting them from abrasion. Tubing is split for easy wire insertion. Operating temperature -30°F to +200°F.

Split Braided Sleeving



IBS No.	Size	Length	Qty
19040	1/4	75 ft.	1
19041	3/8	75 ft.	1
19042	1/2	50 ft.	1
19043	3/4	50 ft.	1
19044	1	25 ft.	1

Made from semi-rigid 10 mil Polyethylene braid; its lightweight, quiet & flexible. A lateral split accommodates a wide variety of bundling needs. 25% edge overlap allows for coverage around inline plugs, connectors & splices. Add and remove wires without disassembly. Retains shape & rigidity from -94°F to 257°F.

Split Tubing & Sleeve Installation Tool

- Insert your wire bundle into the shank.
- Slide the tool along the split in the sleeving.
- Watch as the tool desposits the wires and closes the split.



IBS No.	Size	Qty
19045	1/4 - 3/8	1
19046	1/2	1
19047	3/4	1
19048	1	1

IBS, INCORPORATED

Miscellaneous Items Q3F



ELECTRICAL

Procell Alkaline Batteries

- Provides 1.5 volts, 6 volts and 9 volts.
- Good low temperature characteristics.
- Recommended for heavy drain items which get frequent use i.e. flashlights, calculators, lanterns, etc.
- Good long-lasting power source.



IBS No.	Cell	Pkg Qty	Case Qty
EN95	D	12	72
EN93	C	12	72
EN96	AAAA	2	12
EN92	AAA	12	144
EN91	AA	12	144
EN22	9V	6	72
EN29	6V lantern	1	12
LR41	1.5V	1	—
LR44	LED Safety Glasses	1	6
CR2032	3V	1	6
CR123A	3V	1	12

Procell Alkaline Batteries Assortment (Z02)

IBS No. 395R • 5 Items • 46 Pcs

Packaged in a locking steel drawer for easy storage & organization

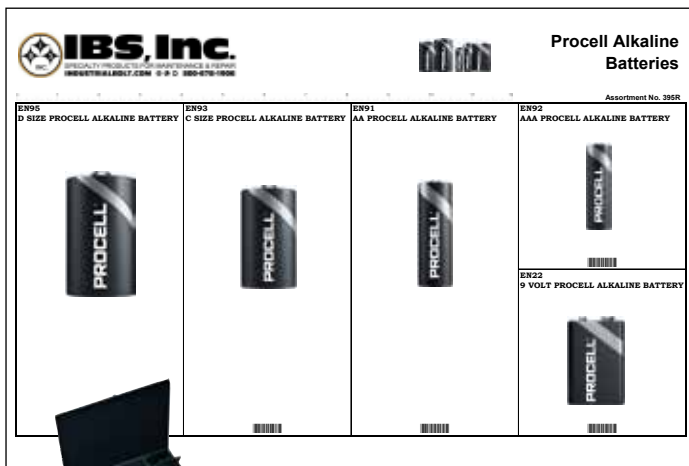

Rough Service Light Bulbs

Supreme Special Filament



- Designed exclusively for the automotive industry.
- Bulbs have 9 filament supports plus a thicker, shorter stem for the supports. This provides twice the resistance to the type of shock that destroys filaments in common bulbs.
- Guaranteed long-life bulbs.
- Brass based eliminates "freezing" or corroding in the socket — allowing easier removal.
- Made in the USA.

ROUGH SERVICE BULBS

TOUGH COAT BULBS

IBS No.	Watts	Pkg Qty	IBS No.	Watts	Pkg Qty
75A/RS	75	4	75A/STC	75	4
100A/RS	100	4	100A/STC	100	4

Procell Alkaline Batteries Assortment (Z02)

IBS No. 746R • 5 Items • 30 Pcs

Packaged in a locking plastic tray for easy storage & organization

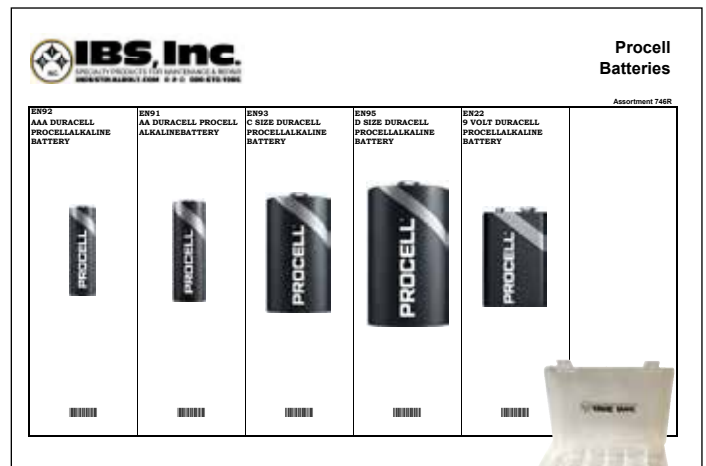



IBS, INCORPORATED

Miscellaneous Items Q3F

ELECTRICAL

Professional 50' Quad Tap Retractable Reel 15 AMP



IBS No.	Case Qty	Case Wt.	Cord Length	Cord GA	Cord Jacket
136111	1	17 lbs	50 ft	12/3	SJTW

- 40% larger cord reel with smooth glide rewind.
- Polarized plug with four 15 AMP grounded receptacles.
- Resettable 15 AMP circuit breaker.
- LED power status light.
- Mounting brackets included.
- Heavy Duty 12/3 Cord.

Pro 1200 Lumen LED Worklight On 50' Retractable Metal Reel



IBS No.	Case Qty	Case Wt.	Cord Length	Cord GA	Cord Jacket
136641	1	8 lbs	50 ft	18/2	SVTW
136642	Replacement Head (136641 & 137681)				



- All LED construction and 18/2 SVTW cord make this a lightweight and virtually indestructible work light ideal for most work environments.
- Worklight has two brightness settings of 1,200 and 600 Lumens make this light perfect for lighting up a large area.
- Two built-in magnets with a detachable magnetic hook, one at the balance point in the middle of the handle, and the other at the tip of the light offer hands free options for convenience and added value.
- Octagonal shaped handle keeps the floodlight aimed in the correct direction when set on its side for extra convenience and safety.
- Includes a mounting bracket allowing the reel to be attached to the wall or ceiling for safety and convenience.
- 1 year limited warranty.

Pro 1200 Lumen LED Worklight With 25' Cord



IBS No.	Case Qty	Case Wt.	Cord Length	Cord GA	Cord Jacket
137681	1	1 lbs	25 ft	18/2	SJTW

- All LED construction and 18/2 SVTW cord make this a lightweight and virtually indestructible work light ideal for most work environments.
- Worklight has two brightness settings of 1,200 and 600 Lumens make this light perfect for lighting up a large area.
- Two built-in magnets with a detachable magnetic hook, one at the balance point in the middle of the handle, and the other at the tip of the light offer hands free options for convenience and added value.
- Octagonal shaped handle keeps the floodlight aimed in the correct direction when set on its side for extra convenience and safety.
- 25' cord is the perfect length for easy storage and yet reaches places where needed.
- 1 year limited warranty.

Under-Hood Worklight



IBS No.	Pkg Qty	Description
138516	1	Under-Hood Worklight

- Adjustable carrier system extends to 77 inches to fit across most automotive hoods.
- Can be used with or without the carrier.
- Magnetic ends for easy, multi-positioning housing.
- Hanger hooks add mounting versatility.
- Housing is chemical, moisture and impact-resistant to stand up to the toughest situations and applications.
- Dual power mode runs up to 4-1/2 hours on full power, or 8-1/2 hours on half power.
- 120 premium LEDs deliver up to 35,000 hour life.
- Includes internal battery pack with AC and car chargers.
- 51" L x 4" W x 7" H.
- Lumens: 1200 at full-power, 650 at half-power



Omni 3K Worklight

3000 Lumens



The OMNI 3K is the ultimate omni-directional work light and once you've used it, you will wonder how you ever lived without it! It is powerful, yet compact measuring just 7" x 5-3/8".

- **3000 lumens** of light with a dual COB output.
- **Fully Rotatable** — the dual panels rotate 360°, directing light to any angle.
- **Handle** — **single handle that swivels**, making it easier to adjust and direct.
- **Mounting** — **Strong magnetic handle** attaches to any metal surface or **universal 1/4-20 female thread** allows for mounting to standard tri-pods.
- **Water Resistant** — IPX4 Water Resistant means it can resist a sustained, low-pressure water jet spray.
- **Rechargeable** — Fast USB-C charging.
- **Red Light Mode** — Helps eyes to quickly adjust and adapt for night vision.
- **Back-Up Battery** — use to charge USB devices with a 4,000mAh power bank.

IBS No.	Description
136647	Omni 3K Worklight

LED Work Light

- Single light fixture producing 2,200 lumens of light from a single 20W LED.
- Multi-angle tilt and swivel fixture design.
- Multi-fin heat-sink keeps light cool to the touch .
- LED is rated at 50,000 hours of life.
- Comfort grip padded handle.
- Single sealed push button switch.
- Tempered glass lens.
- 6 ft SVT, 18/3 cord with grounded plug.
- Powder coated for long wear.
- Impact, chemical and water resistant design.



IBS No.	Description
201711	LED Work Light

Omni 2K Worklight

2000 Lumens

The OMNI 2K is an omni-directional work light that boasts a powerful 2,000 lumen, Dual C•O•B output with a red hazard feature. The OMNI features magnetic handles to provide convenient carry, magnetic attachment or a sturdy base for hands-free light. Each C•O•B panel and magnetic handle rotate to give light everywhere that you need it, and the dimmer controls give you the right amount of light. Completely rechargeable, the OMNI 2K also features a power bank to charge your USB powered devices.

- **USB-C rechargeable.**
- **4,000mAh** power bank
- **Rotating magnetic handles**
- **Rotating C•O•B panels**
- **Water and impact resistant**
- **Non-slip rubber coating**
- **Battery charging indicator**
- **Rear-positioned ON/OFF button** and 2 buttons for adjustable brightness
- **USB-C charging cable** included
- **Powered by internal rechargeable battery** (Recharge time: 2 - 8 hours).
- **Folded size:** (H) 4.8" x (W) 6.25" x (D) 1.875", 0.5 lbs.



IBS No.	Description
202013	Omni 2K Worklight

Rechargeable LED Area Worklight WITH MAGNETIC BASE

- High/Low brightness modes.
- 1000 lumens on high.
- 500 lumens on low.
- Constructed from lightweight 6061-T6 aluminum.
- Multi-angle tilt and swivel fixture design.
- Powerful magnetic base for hands-free operation.
- Multi-fin heat sink keeps light cool to the touch.
- LED is rated at 50,000 hours of life.
- Adjustable comfort-grip handle.
- Single sealed push button switch.
- Tempered glass lens.
- Powder coated for long wear.
- IP-X7 rated waterproof
- Impact and chemical resistant design
- Meets requirements of NFPA-1971-8.6 (2013)
- Rechargeable Li-ion
- Includes AC & DC power supplies
- 1 Year limited warranty.



IBS No.	Description
136645	Rechargeable LED Area Worklight with Magnetic Base

ELECTRICAL



IBS, INCORPORATED

Miscellaneous Items Q3F

ELECTRICAL

Dual Function Flood / Flashlight with Magnet & Stand

- 150 lumens flashlight
- 120 lumens floodlight
- 270 lumens dual-light
- 4 AA batteries included
- Multifunction — Flashlight / Floodlight / Dual-Light.
- Oval shape and non-slip textured body for easier and safer handling.



IBS No.	Pkg Qty	Description
138515	1	Dual Function Flood/Flashlight with Magnet & Stand

BAT Flashlight

- 1,000 Lumen High-Power LED
- 4 AA batteries included
- Aircraft grade anodized aluminum; water and impact resistant
- Rubberized protective sleeve
- Ergonomic textured handle



IBS No.	Pkg Qty	Description
138523	1	The BAT Flashlight

Joey Flashlight XL

- 300 lumens worklight
- 520 lumens flashlight
- AA batteries included
- Multifunction Flashlight , Worklight & Signal Light.
- Magnetic Base
- 3 Lighting Modes
 - High Intensity Flashlight
 - Magnetic Worklight
 - Red Signal Light Magnetic Base
- Magnetic Base



IBS No.	Pkg Qty	Description
138528	1	IBS Joey Flashlight XL

LED Dual-Light Headlamp

- 55 lumens spotlight
- 40 lumens floodlight
- 80 lumens dual-light
- 3 AAA batteries included
- Adjustable elastic headband with rubberized strips keep the headlamp in place
- Headlamp tilts for optimum light positioning
- IP-X7 rated waterproof



IBS No.	Pkg Qty	Description
138524	1	LED Dual-Light Headlamp

Cordless Rechargeable Multi-Purpose LED Work / Flood Light

With AC & DC Chargers & Magnet Hooks



IBS No.	Pkg Qty	Description
138511	1	Cordless Rechargeable Multipurpose LED Work Flood Light
138511LENS	1	Replacement Lens

- Dual-brightness Floodlight – 600/225 Lumens for optimum battery control and life.
- Three heavy-duty integrated magnets, one at the tip of the light, one at the mid-point of the body and one built into the base for multiple hands-free uses.
- Magnetic hook can be attached to either the body or tip magnets and can be rotated 360 degrees for even more hands-free versatility.
- Octagonal body design keeps the light in place when laid on its side for extra convenience and safety.
- Flat bottom design allows the light to stand up and directed to where the light is needed for added value.
- User-replaceable lens saves money on replacing the entire light when the lens is damaged.
- Water resistant makes this light perfect for indoor and outdoor use.
- Impact & chemical resistant means the light is durable enough to use in most work environments.
- Powered by integrated Lithium-ion battery for optimum life with no “battery memory” for easy charging.
- Includes both AC & DC power supply/charger means this light can be used in the shop or on the road.
- 1 Year Limited Warranty

Intrinsically Safe LED Flood/Flashlight

- 55 lumens spotlight
- 40 lumens floodlight
- 80 lumens dual-light
- 3 AAA batteries included
- Adjustable elastic headband with rubberized strips keep the headlamp in place
- Headlamp tilts for optimum light positioning
- IP-X7 rated waterproof



IBS No.	Pkg Qty	Description
138520	1	Intrinsically Safe LED Dual Function Flood/Flashlight



Fluorescent Work Light Replacement Bulbs



26W FLUORESCENT WORKLIGHT REPLACEMENT BULB

IBS No.	Case Qty	Case Wt.	Watts	Used With
121017	12	1.6 lbs	26W	IBS No. 136022 IBS No. 136155



13W FLUORESCENT WORKLIGHT REPLACEMENT BULB

IBS No.	Case Qty	Case Wt.	Watts	Used With
121016	12	1.5 lbs	13W	IBS No. 121012 IBS No. 137689



12V 13W FLUORESCENT WORKLIGHT REPLACEMENT BULB

IBS No.	Case Qty	Case Wt.	Watts	Used With
123151	12	1.5 lbs	13W	IBS No. 123149 IBS No. 137686

Halogen Work Light Replacement Bulb



500W HALOGEN WORKLIGHT BULB REPLACEMENTS

IBS No.	Case Qty.	Case Wt. (lbs)	Used With	Package
136104	12	1.5	IBS No. 136106	Clamshell

Accessories



MALE REPLACEMENT PLUG - 3 WIRE

IBS No.	Case Qty.	Case Wt. (lbs)	Description
137687	6	3	Male Plug



FEMALE REPLACEMENT PLUG - 3 WIRE

IBS No.	Case Qty.	Case Wt. (lbs)	Description
137688	6	3	Female Plug

Replacement Parts



REPLACEMENT PARTS 26W FLUORESCENT LIGHT

IBS No.	Description	Pkg	Use with
137916	Replacement Head	Box	136155
138000	Replacement Lens	Box	136155



REPLACEMENT TUBE ASSEMBLY FOR 13W WORKLIGHTS

IBS No.	Size	Pkg	Use with
137998	13W	Bag	121012, 123149, 137686



REPLACEMENT DOUBLE HOOKS FOR TUBE LIGHTS

IBS No.	Description	Pkg	Use with
138001	Double Hooks	Box	13W Lights

ELECTRICAL



IBS, INCORPORATED

Miscellaneous Items Q3F

IBS DualGlow Extension Cords



LIGHTED ENDS
INDICATE
WHEN POWER
IS PRESENT



IBS DUALGLOW EXTENSION CORDS 25', 50' & 100 FT SINGLE TAP

IBS No.	Cord Length	Cord GA	Cord Jacket
141478	25 ft	12/3	SJTW 15A Rated
139641	50 ft	12/3	SJTW 15A Rated
139642	100 ft	12/3	SJTW 15A Rated

- Contractor Grade / Professional Quality
- Features CGM (Continuous Current and Ground Monitoring, which means each female plug has a green neon light that indicates there is ground continuity — an OSHA Safety Requirement.
- Molded stress collar prevents the cord from pulling out providing additional strength and longevity.
- Male plugs feature an amber neon light indicating the presence of power in the cords and outlet.
- Patented 2-way, non-slip finger grips makes connecting and disconnecting easier and faster saving time and preventing faulty connections.
- Superior cold weather jacket provides flexibility in freezing temperatures as low as -40°F, making unraveling and storing cords easier and faster.
- High visibility improves safety and productivity, helps prevent on the job injuries — saving time and money.
- 12/3 ga wire provides maximum connectivity that can handle large, industrial tools without overheating or tripping breakers.

IBS Pro-Lock Extension Cords



PRO-LOCK DUALGLOW MOLDED EXTENSION CORDS 50' & 100 FT SINGLE TAP

IBS No.	Cord Length	Cord GA	Cord Jacket / Color
139646	50 ft	10/3	SJTW / Blue 15A Rated
139647	100 ft	10/3	SJTW / Blue 15A Rated
139643	50 ft	12/3	SJTW / Orange 15A Rated
139644	100 ft	12/3	SJTW / Green 15A Rated
139645		10/3 to 12/3	Extension Cord End Only

- Contractor Grade / Professional Quality
- Features the exclusive Pro-Lock Connector - Click to Lock up to 80lbs tensile strength means ends won't pull apart.
- Safely locks your cords together, keeps equipment connected without dangerous cord tying, which provides for a safer and more productive work environment, saving time and money.
- With the quick release collar, cords with Standard 3 prong 15A-125V ends won't pull apart and are easy to connect and disconnect when needed for a safe and continuous connection.
- Both male and female plugs feature power check lighted ends indicating the presence of power in the cords and outlet for safer operation.
- Superior cold weather jacket provides flexibility in freezing temperatures as low as -40°F, making unraveling and storing cords easier and faster.
- High visibility improves safety and productivity, helps prevent on the job injuries — saving time and money.
- 10/3 and 12/3 ga wire provides maximum connectivity that can handle large, industrial tools without overheating or tripping breakers.
- **UL, cUL listed.**

E
L
E
C
T
R
I
C
A
L

IBS, INCORPORATED

Miscellaneous Items Q3F



GFCI INLINE TRIPLE TAP CORD

IBS No.	Type	Cord Length	Cord GA	Cord Jacket
141438	GFCI	12/3	SJTW 15A Rated	SJTW 15A Rated

- Contractor Grade / Professional Quality
- Fast acting circuit breaker designed to shut-off electrical power in the event of a ground fault in as little as 1/4 of one second.
- Oil-resistant jacket remains flexible even at sub-zero temperatures.
- Ideal for use during maintenance, remodeling, or repair of buildings, structures or equipment.
- High visibility yellow for added safety.
- Lighted receptacle for added safety.
- Grounded receptacle.
- Meets OSHA Regulation 1910.304.

Lighted Adapters



LIGHTED PLUG ADAPTER SINGLE TAP

IBS No.	Pkg Qty	Pkg	Description
141436	5	Bag	3 to 2 Lighted Adapter

- Converts a single 15 AMP 125 Volt grounded outlet.
- Lighted end indicates power is on.
- 1875 Watt.
- UL approved.



LIGHTED PLUG ADAPTER TRIPLE TAP

IBS No.	Pkg Qty	Pkg	Description
141437	2	Bag	Lighted Adapter Triple Outlet

- Converts a single 15 AMP 125 Volt grounded outlet to three 15A, 125V U-ground outlets.
- Lighted end indicates power is on.
- 1875 Watt.
- UL approved.

Silver Bearing Solder (S05)

Low Temperature

The highest strength, lowest melting point silver solder alloy for stainless steel, dissimilar metals and chrome plating.

- 500% stronger than common solders.
- Superior corrosion resistance with bright, shiny deposits.



IBS No.	Description	Qty
46001	1 oz. syringe	1
46000	9 ft. x 1/16 coil, acid core 96.5% tin - 3.5% silver	1

Silvabrite 100® Solder (S05)

Lead Free

Silvabrite 100® was developed to meet market demands for a safe and easy-to-use solder for drinking water systems and other applications. Silvabrite 100® is a lead-free and antimony free, non-toxic solder which contains the same metals used in dental fillings.

Features/Benefits:

- Lead-free composition — safe for use in drinking water systems.
- Low melting point — excellent penetration, flow and wetting out action means fast application and less waste.
- Wide melting range — 440°F to 500°F for maximum control.
- Excellent "capping off" ability.
- Tin, copper and silver composition — provides higher shear, creep and tensile strength than 50/50 for strong corrosion resistant leak-tight joints.



IBS No.	Description	Qty
460013	1/8 X 1# spool	1

ELECTRICAL



60/40 Rosin Core Solder Most Popular Solder for Electrical Applications

- Rosin flux is completely non-corrosive and non-conductive.
- Quick acting rosin flux dissolves surface oxides for good wetting and strong connections.
- Meets Fed. Spec. QQ-S-571
- 60% Tin / 40% Lead.
- Made in the USA



IBS No.	Description	Qty
46044	.031 x 1# Spool	1
46045	.062 x 1# Spool	1
46046	.093 x 1# Spool	1

NOKORODE® Regular Paste Flux

Will not freeze or decompose. No odor. Lead free. Recommended for use on all solder alloys including 95/5 and all lead-free solders. Meets specification O-F-506, Type 1A and A-A-51145, MIL-F04995-2.



IBS No.	Description	Qty
460014	1.7 oz. jar	1

60/40 Rosin Core Solder & Excalibur Torch Assts (Z08)

Each size of 60/40 Rosin Core Solder combined with an Excalibur Torch.

Excalibur Torch

A self-igniting and cordless soldering iron, hot air blower, and butane torch complete in 1 great tool! The Piezo electric ignition system provides a quick start-up in any mode.

Includes 5 interchangeable tips: 1 Reflector, 1 Hot Air Blower, 1 Hot Knife, 1 3.5mm Chisel Tip, and 1 3mm Diagonal Tip. One tube of solder is also included.

Includes a handy, impact-resistant travelling case for complete mobility, moves easily from the workshop to the field.



IBS No.	Description
690P	.031 x 1# Spool with Excalibur Torch
691P	.062 x 1# Spool with Excalibur Torch
692P	.093 x 1# Spool with Excalibur Torch
141060	Excalibur Torch Set

Butane Refill



- Universal tip fuels most leading butane lighters.
- Low in non-volatile contaminants which can cause burner valve to clog, affecting flame height and function.

WARNING: USE THIS PRODUCT ONLY AS DIRECTED ON THE PACKAGE. INTENTIONAL MISUSE BY DELIBERATELY CONCENTRATING & INHALING THE CONTENTS MAY BE HARMFUL OR FATAL. KEEP OUT OF REACH OF CHILDREN.

IBS No.	Description	Qty
95007	Butane Refill	1



Solder Combo Assortments (Z08)

One of our bestselling assortments just got better! Solder combos available in any combination — 2 of our Low Temperature Silver Bearing Solder in coil, paste, or one of each and includes the new **MICROTORCH BUTANE TORCH!**

MICROTORCH BUTANE TORCH

IBS No. 125738 (T03)

Retail Value \$39.95

At only 5-1/4" high with a 2500°F flame, the **MICROTORCH** is ideal for all types of professional use. Refillable with premium grade Butane Refill. (IBS No. 95007 - T03).

Low temperature silver bearing soft solder — the highest strength, lowest melting point silver solder alloy for stainless steel, dissimilar metals and chrome plating, available in coil, or syringe paste.

- 500% stronger than common solders.
- Superior corrosion resistance with bright, shiny deposits



IBS No.	Description	Qty
418P	1 Solder Paste Syringe 1 Torch	1 Coil 1 Butane Refill
425P	2 Solder Paste Syringes 1 Torch	1 Butane Refill
426P	2 Solder Coils 1 Torch	1 Butane Refill

Microtorch Butane Torch



At only 5-1/4" high with a 2500° flame, the **Microtorch** is ideal for all types of professional use. Refillable with premium grade butane (IBS No. 95007). A versatile and handy addition to any professional workshop.

IBS No.	Description	Qty
125738	Microtorch Butane Torch	1

Industrial Butane Torch

Powerful, portable, refillable and anti-flare with a flame temperature of over 2500°F, the Industrial Butane Torch is ideal for automotive, plumbing, and professional repair shop use.



Functions & Uses:

- Lead Gutters
- Toughen Metal
- Stripping Paint
- Automotive Repair
- Sweat Ftgs & Joints
- Lay or Remove Tiles
- Loose Bolts
- Plumbing
- Dry Cements

IBS No.	Description	Qty
125739	Industrial Butane Torch	1

Dual Temp Electric Heat Gun

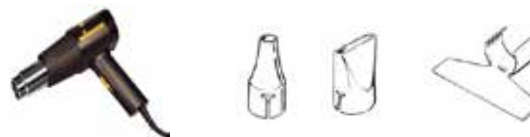

A general purpose heat gun that is ideal for most heating applications, including applying heat shrink tubing, stripping paint, thawing pipes and loosening floor tile.

- 2 temperature settings (750°F & 1000°F) for versatility & various applications.
- 4100 BTU output for removing multiple layers of paint.
- 1200 Watts make this a powerful heat gun.
- Measures 16.5 x 9.8 x 17 inches

IBS No.	Description
141096	Dual Temp Electric Heat Gun
141305	Concentrator Nozzle
141306	Flare Nozzle
141307	Glass Protector Nozzle

Wire / Cable Cutter



- Stainless steel blades cut electrical cable safely.
- Ergonomic handle for comfort.
- Spring keeps handles open when in use.
- Locking device keeps blades closed when not in use.

WARNING:

DO NOT USE ON ELECTRICAL CIRCUITS!

IBS No.	Description	Qty
99169	James Morton Wire Cable Cutter	1

ELECTRICAL



IBS, INCORPORATED

Tools T03

Wire Crimp Tool (T03)



A versatile, heavy-duty tool, made of .140" high-strength, heat-treated carbon steel. It is lightweight without sacrificing strength. It handles a variety of terminal and connector styles, including FLAGS, closed-end connectors, crimp sleeves and standard parts, insulated and non-insulated, over a broad range of 26-6 AWG.

- Anvil Type wire cutter.
- Crimp dies for #26-10 AWG insulated terminals, connectors, and closed-end connectors.
- Cuts & re-threads 4-40, 6-32, 8-32, 10-24, and 10-32 machine screws.
- Crimp die for #12-6 AWG non-insulated terminals, connectors, FLAGS, quick-slides, crimp sleeves and high temperature terminals.
- Crimp die for insulated terminals and butt connectors, wire sizes #8-6 AWG.
- Crimp die for #26-14 AWG non-insulated terminals, connectors, FLAGS, quick-slides and crimp sleeves.
- Wire-stripping stations.
- Strip length guide.
- Textured, cushioned grips.

IBS No.	Description	Qty
TH450	Wire Crimp Tool	1

Ratcheting Wire Terminal Crimper



- Ratcheting mechanism with adjustable clamping force allows for precise, repeatable crimps.
- Compound action design puts more crimping power into each squeeze.
- Double crimping die creates a secure crimp that resists pull-out.
- Ratcheting function allows you to secure a wire connector in the die before inserting the stripped wire into the barrel.
- Quick release lever frees the crimper jaws in any position and when double crimp is complete, acts as a built-in safety measure that can open the handles whenever tool is jammed or stuck.
- Steel jaw contains color-coded wire size markings for red (22-18 AWG), blue (16-14 AWG), and yellow (12-10 AWG) terminals.
- Ergonomic biomaterial handles offer a comfortable, secure grip.

IBS No.	Description	Qty
11477	Ratcheting Wire Terminal Crimper	1

Ratcheting Crimp Tool Sets (T03)

Available with 4 Additional Dies for Crimping A Variety of Terminals with One Tool!



- 4 Crimp Nests: 8 AWG Red; 12-10 AWG Yellow; 16-14 AWG Blue; 22-18 AWG Red
- Mating mechanism prevents jaws from slipping or misalignment.
- Long handles make it easier to crimp - Less force required.
- Easy-to-use and understand release mechanism.
- Ergonomic design to initiate the crimp process.



Dies Available:

- For open barrel terminals: 20GA thru 10GA
- For Insulated Closed End Connectors
- For Double Crimp Insulated Terminals: 24GA thru 10GA
- For Insulated Flag Terminals

IBS No.	Description	Qty
B0050	Ratcheting Crimp Tool	1
B0051	Ratcheting Crimp Tool & Dies Kit	1
B0052	Ratcheting Crimp Tool Case & Dies — No Tools	1
B0053	Ratcheting Crimp Tool Die for 22-10GA Insulated Closed End Term	1
B0054	Ratcheting Crimp Tool Die with Locator for 20-10 GA Open Barrel Connectors	1
B0055	Ratcheting Crimp Tool Die for 22--14 GA Insulated Flag Terminals	1
B0056	Ratcheting Crimp Tool Die for 26-10 GA Double Grip Insulated Terminals	1

ELECTRICAL



Battery Terminal Cleaner IBS No. 74103

Battery Terminal Cleaner removes corrosion from all battery parts and quickly identifies leaks. Color indicator turns red in the presence of acid. When neutralizing, color indicator shows yellow. Regular use increases battery performance and life expectancy.

- **Improves conductivity** — Seals out air to prevent corrosion that robs battery power and life.
- **Attacks and destroys corrosion** — Quick acting cleaner removes stubborn corrosion.
- **Extends battery life** — Seals air and dirt out to protect battery against corrosion build-up and battery voltage leakage.
- **No mess application**
- **Fast-acting formula** makes clean up quick.



Battery Terminal Protector IBS No. 74109

A unique film designed to protect battery terminals from corrosion. Industrial battery terminal sealer and protector.

Extends battery life, allows for maximum flow.

- **Extends battery life** by preventing corrosion.
- **Improves electrical output** keeping connections clean and in direct contact with terminals.
- **Remains flexible** so it won't crack when installing, removing or tightening connections.
- Dielectric strength: 30,000 volts.
- **USE ON:** Battery posts, terminals, in automobiles, trucks, power equipment, boats, handling equipment.



Safety Solvent IV Degreaser IBS No. 74156

- **Penetrates and removes** dirt, grease, oil, grime and varnish deposits.
- Safe on all metals, electrical, equipment wiring, and painted surfaces.
- Non Corrosive and non-staining.
- Removes tar, adhesive marks, crayon, lipstick, chewing gum, ink, fresh paint & spots from upholstery, rugs and clothing.



4 Way Plus IBS No. 74107

- **Dries wet electrical systems and ignitions** to end system delays due to moisture.
- Penetrates and loosens frozen nuts & bolts for faster and easier removal.
- Excellent all-purpose lubricant.
- Valve sprays either stream or mist for all your varied needs.
- Provides moisture barrier — Excellent for use on electrical equipment.
- Stops squeaks and provides permanent protection against metal-to-metal wear.



IBS, INCORPORATED

Chemicals S04

E
L
E
C
T
R
I
C
A
L



Contact and Circuit Board Cleaner

IBS No. 74128

- **Cleans oil**, grease, dirt, moisture and condensation from circuit boards, precision instruments, oxygen equipment, controls, switches, motors and film.
- **Removes carbon** and other harmful deposits on all electrical contacts.
- **Restores** full current flow.



Undercoat

IBS No. 74127

- **Protects and seals** body undersides on trucks, buses, and automobiles.
- **Protects drums, tanks** and other outside storage vessels.
- **Seals out moisture.**
- **Absorbs shock and noise**, eliminating rattles and squeaks.



Dielectric Grease (S08)

IBS No. 37535 - 3 oz. tube

Provides a moisture-proof barrier that lubricates and protects electrical equipment from salt, dirt and corrosion. High dielectric strength. Good thermal, oxidation, and chemical stability.