



Drill Bits, Inserts & Reamers

A

Assortments

Threaded Rod

Grade 8 Threaded Rod Assortment PD-44

Assortments, Cutting Tool

Countersinks, Fluteless

Hex & Round Shank PD-26

Draps, IBS Hi-Alloy

- 5 Pc NC Hex Shank Drap Set PD-33
- 6 Pc Metric Hex Shank Drap Set PD-33
- 10 Pc NC / NF Hex Shank Drap Set PD-33

Drill Bits, Nitro-Carb

- 7 Pc. Nitro-Carb Mech Length Drill Bit Set - Pouch PD-13
- 12 Pc. Nitro-Carb Mech Length Drill Bit Set - Hard Case PD-13
- 16 Pc. Nitro-Carb Mech Length Drill Bit Set - Pouch PD-13

IBS Type 187 Spotweld PD-24

Left Hand Drill Bit PD-17

Letter PD-12

Number PD-12

Quick Release Drill Bit & Insert PD-13

Reduced Shank PD-14, PD-15

Stubby PD-19

Drill Bits, Nitro-X

- 13 Pc Nitro-X Step Tip Mechanics Length Handi-Bit Set 1/16 X 1/2 by 32nds PD-3
- 29 Pc Nitro-X Step Tip Mechanics Length Set 1/16 X 1/2 by 64ths PD-3
- 51 Pc. Nitro-X StepTip Mechanic's Length Organizer Set 1/16 to 1/2 by 64ths PD-3

Handi-Bit Dispenser

Jobber's Length, 29pc PD-10

Mechanic's Length, 29pc PD-10

Reamers

3 Pc Step Reamer Set PD-29

Reamers, Nitro-Carb

Hole Hog Reamers with Drills PD-32

Unibit

3 Pc Set PD-28

Assortments, Cutting Tools

Carbide Burs PD-44

Assortments, Tools

Extractors

25 Piece Hex Head Spline Drive Screw Extractor Set PD-45

Screw Extractors, Sets

25 Piece Hex Head Spline Drive Screw Extractor Set PD-45

C

Countersinks

6-Flute Chatterless Countersinks PD-25

Fluteless

3 Pc Set Hex Shank PD-26

5 Pc Set, Round Shank PD-26

Round & Hex Shank PD-26

D

DRAPS, Hi-Alloy

NC, NF, & Metric PD-33

DRAPS, IBS Hi-Alloy PD-33

Drill Bits

Assortments

Economy Drill Bits PD-21

IBS NITRO-X STEP TIP DRILL BIT ORGANIZER PD-3, PD-4

IBS NITRO-X STEP TIP DRILL HANDI-BIT SET PD-3

IBS Type 187 Spotweld PD-24

Jobbers Length Drill Bit Sets PD-11

Left Hand, Nitro-Carb PD-17

Letter & Number, Nitro-Carb PD-12

Mechanics Length Drill Bit Sets PD-11

Metric Nitro-Carb Drill Bit Sets PD-21

Nitro-Carb Quick-Change Hex Shank Drill Bit PD-13

Platinum Spiral Flute Step Drill Travel Trays PD-27

Reduced Shank, Nitro-Carb PD-14, PD-15

Stubby, Nitro-Carb PD-19

Nitro-Carb Left Hand

Stubby Drill Set PD-18

Ultra Point Acrylic Drill Bits PD-25

Unibit 3 Piece Set PD-28

Carbide Tipped Straight Flute Drills for Hard Steel PD-16

Extended Length PD-21

Glass & Tile PD-24

IBS Cryo-Tech HSS Nitrided

Jobber's Length PD-3, PD-4, PD-5

IBS NITRO-X S&D Step Tip Drill Bits PD-4

IBS NITRO-X Step Tip Drill Bits PD-3

IBS Type 187

Spotweld PD-24

Masonry

SDS Plus Masonry Drill Bits PD-23

SDS Plus Masonry Drill Bits

5 Pc Set PD-23

Straight Shank Masonry PD-22

Straight Shank Masonry

Drill Bits — 5 Pc Set PD-22

Nitro-Carb

Double End PD-19

Letter PD-12

Metric PD-20

Number PD-12



Quick-Change Hex Shank Drill Bits PD-13
 Stubby Length PD-19
Nitro-Carb Platinum
 Handi-Bit 29 Pc Mechanic's Length Drill Bit Assortm PD-10

Nitro-Carb, PLATINUM SERIES
 General Info PD-8
 Jobbers & Mechanic's Lengths PD-9
 Mechanic's Length Reduced Shank Drills PD-14

Platinum Series Spiral Reamers PD-31
Platinum Spiral Flute Step Drills PD-27
Ultra Point Acrylic PD-25

Driver Bits
Grabit Drill-Out Broken Bolt Extractor Set PD-44
GRABIT PRO Damaged Screw Remover PD-44

E

Extractors
Bolt Extractors PD-45
Screw Extractors
 Power-Outs™ Double Edged Screw Extractors PD-45
Screw Extractors, Sets
 25 Piece Hex Head Spline Drive Screw Extractor Set PD-45
 Grabit Drill-Out Broken Bolt Extractor Set PD-44
 Power-Outs Sets PD-45

H

Handi-Bit 29 Pc Drill Bit Sets
Black PD-10
Hi-Vis PD-10
Hi-Alloy PD-24

I

IBS NITRO-X S&D Step Tip Drill Bits PD-4

N

Nitro-Carb
Stubby Length
 Left Hand
 Left Hand Stubby Drill Bits PD-18
Nitro-X StepTip Mechanic's Length 51 Pc Organizer Set
 1/16 to 1/2 by 64ths PD-3

R

Reamers
Nitro-Carb
 Hole Hog PD-32
Step Reamers PD-29
 3 Pc Set PD-29

S

Screw Extractors, Sets
Grabit Drill-Out Broken Bolt Extractor Set PD-44

T

Technical Information

Drill Bits
 Decimal Equivalent Chart For Drill Sizes PD-40
 Fractional Drill Cutting Speeds in RPM PD-36
 Letter Drill Cutting Speeds in RPM PD-37
 Metric Drill Cutting Speeds in RPM PD-39
 Number Drill Cutting Speeds in RPM PD-38
 Re-sharpening Procedures PD-7
 Speeds & Feeds Tables PD-34
 Surface Cutting Speeds For Various Materials PD-35

Drills, Nitro-Carb
 Features & Benefits PD-6
 Metric Drill Cutting Speeds PD-39
 Nitro Carb vs Cobalt PD-7

Drills, Nitro-Carb Platinum Series
 Features & Benefits PD-8
iNES Internal Rethreading Tap PD-42
iNES Replacement Blades & Nylon Pads PD-43

NES Rethreading Tools PD-41
Nitro-Carb Spiral Reamers
 Features & Benefits PD-30
Step Drills PD-27, PD-28

Threaded Rod

Tools
 Deburring Tool (T03) PD-44
 Grabit® Drill-Out Broken Bolt Extractor Set PD-44

Tools

Hand
 iNES Internal Rethreading Tap PD-42
 iNES Replacement Blades & Nylon Pads PD-43
 NES Rethreading Tools PD-41
 Power-Outs Sets PD-45
 ThreadMate Set & External Tool PD-43

Threaded Rod

Deburring Tool 3Pc Set (T03) PD-44
 Grabit® Drill-Out Broken Bolt Extractor Set PD-44



IBS NITRO-X Step Tip Drill Bits

Mechanic's Length • 3 Flats On Shank • MADE IN THE U.S.A



EXPAND HOLES • EXTREME APPLICATIONS • EXCEPTIONAL LIFE & VALUE

Nitro-X Step Tip Drill Bits have a unique **step point** for faster and cooler drilling. This innovative design combines the fast penetrating action of a reamer with all the superior features of our standard Nitro-Carb drill bits with **up to 50% faster drilling and 4X longer life.**

- **EXPAND Holes** — The **unique step tip design** easily enlarges existing holes without damaging the point that is typical with standard tip drill bits.
- **EXTREME Applications** — Ideal for hard steel, sheet metal, brass and even acrylics.
- **EXCEPTIONAL Life & Value** — The **step tip geometry reduces heat** that is generated on a larger tip, producing smaller chips and shavings for a cooler cut, reducing cutting tool wear for increase tool life.
- **Mechanics length** for a shorter, sturdier construction, **providing better control and reduced breakage.**
- **The unique step tip design** rapidly reams the hole larger as it penetrates for a faster, cooler cutting action — up to 50% faster than standard tip drill bits — saving time and money!
- **Eliminates the need to drill starter pilot holes** before making larger hole sizes.
- The **micro 135° split point provides accurate starting and self centering**, eliminating the need for a center punch or pilot hole.
- **Three flats on the shank reduce slippage for superior hold** even in hand-held operations - (3/16" and larger).
- **Gold surface treated** for added lubricity.
- **1/16" to 1/2" in 1/64" increments.**
- **MADE IN THE USA!**

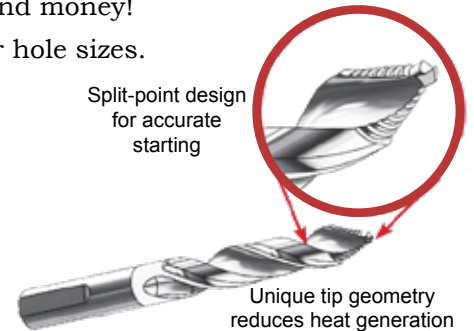

Drill Size	IBS No.	Overall Length	Flute Length	Qty	Drill Size	IBS No.	Overall Length	Flute Length	Qty	Drill Size	IBS No.	Overall Length	Flute Length	Qty
1/16	18200*	1-7/8	7/8	6	7/32	18210	3-1/4	2	6	3/8	18220	4-1/4	2-11/16	3
5/64	18201*	2	1	6	15/64	18211	3-3/8	2-1/16	6	25/64	18221	4-5/16	2-3/4	3
3/32	18202*	2-1/4	1-1/4	6	1/4	18212	3-1/2	2	6	13/32	18222	4-3/8	2-13/16	2
7/64	18203*	2-3/8	1-5/16	6	17/64	18213	3-5/8	2-1/8	3	27/64	18223	4-7/16	2-7/8	2
1/8	18204	2-1/2	1-7/16	6	9/32	18214	3-3/4	2-1/4	3	7/16	18224	4-1/2	2-15/16	2
9/64	18205	2-5/8	1-9/16	6	19/64	18215	3-7/8	2-3/8	3	29/64	18225	4-5/8	3	2
5/32	18206	2-3/4	1-11/16	6	5/16	18216	4	2-1/2	3	15/32	18226	4-3/4	3-1/8	2
11/64	18207	2-7/8	1-13/16	6	21/64	18217	4-1/16	2-9/16	3	31/64	18227	4-7/8	3-1/4	2
3/16	18208	3	1-7/8	6	11/32	18218	4-1/8	2-5/8	3	1/2	18228	5	3-3/8	2
13/64	18209	3-1/8	1-15/16	6	23/64	18219	4-3/16	2-11/16	3					

* These bits are too small to have the Nitro-X Step Tip and have a standard 135° split point

IBS NITRO-X STEP TIP DRILL HANDI-BIT SET



IBS NITRO-X STEP TIP DRILL BIT ORGANIZER

IBS No.	Description
16765	51 Pc. Nitro-X StepTip Mechanic's Length Organizer Set 1/16 to 1/2 by 64ths



IBS No.	Description
17466	13 Pc Nitro-X Step Tip Mechanic's Length Handi-Bit Set 1/8 X 1/2 by 32nds
17464	29 Pc Nitro-X Step Tip Mechanic's Length Set 1/16 X 1/2 by 64ths



IBS, INCORPORATED

Nitro-X Drill Bits P06

IBS NITRO-X Reduced Shank Step Tip Drill Bits



EXPAND HOLES • EXTREME APPLICATIONS • EXCEPTIONAL LIFE & VALUE

Nitro-X Reduced Shank Step Tip Drill Bits have a unique **step point** for faster and cooler drilling. This innovative design combines the fast penetrating action of a reamer with all the superior features of our standard Nitro-Carb drill bits with **up to 50% faster drilling and 4X longer life**.

- **EXPAND Holes** — The **unique step tip design** easily enlarges existing holes without damaging the point that is typical with standard tip drill bits.
- **EXTREME Applications** — Ideal for hard steel, sheet metal, brass and even acrylics.
- **EXCEPTIONAL Life & Value** — The **step tip geometry reduces heat** that is generated on a larger tip, producing smaller chips and shavings for a cooler cut, reducing cutting tool wear for increase tool life.
- **The unique step tip design** rapidly reams the hole larger as it penetrates for a faster, cooler cutting action — up to 50% faster than standard tip drill bits — saving time and money!
- The **micro 135° split point provides accurate starting and self centering**, eliminating the need for a center punch or pilot hole.
- **Three flats on the shank reduce slippage for superior hold** even in hand-held operations.
- **Gold surface treated** for added lubricity.
- **9/16" to 1" in 1/16" increments.**
- **MADE IN THE USA!**

IBS NITRO-X STEP TIP 1/2 SHANK DRILL BITS

IBS No.	Description
18881	9/16 NITRO-X Step Tip 1/2 Shank Drill Bit
18883	5/8 NITRO-X Step Tip 1/2 Shank Drill Bit
18885	11/16 NITRO-X Step Tip 1/2 Shank Drill Bit
18887	3/4 NITRO-X Step Tip 1/2 Shank Drill Bit
18889	13/16 NITRO-X Step Tip 1/2 Shank Drill Bit
18891	7/8 NITRO-X Step Tip 1/2 Shank Drill Bit
18893	15/16 NITRO-X Step Tip 1/2 Shank Drill Bit
18895	1" NITRO-X Step Tip 1/2 Shank Drill Bit



IBS NITRO-X STEP TIP S&D 4 Pc & 8 Pc Sets

IBS No.	Description
18897	4 Pc. Nitro-X Step Tip 1/2 Shank Drill Bit Set Sizes: 9/16", 5/8", 3/4" & 1"
18899	8 Pc. Nitro-X Step Tip 1/2 Shank Drill Bit Set Sizes: 9/16-1 X 1/16

D
R
I
L
L
B
I
T
S
E
T
C

IBS, INCORPORATED

Cryo-Tech Nitrided HSS P05



IBS Cryo-Tech™ Nitrided HSS Drill Bits

Jobber's Length • 135° Split Point • 3 Flats Shank
MADE IN THE U.S.A.



- **Cryogenic hardening** creates a denser, more uniform grain steel for a harder, longer lasting drill bit increasing drill durability and lifespan, saving time and money.
- **A harder more durable bit that has reduced friction and wear properties as well as surface roughness** creating a cooler cutting and faster cutting drill bit that is more effective, reducing the "cost-per-hole" — outperforms cobalt in work hardening stainless steel!
- Cryogenic hardening also creates **a more uniform grain structure that also relieves stress fracturing**, making for a more durable bit that lasts 50% longer than other HSS drill bits for less breakage, less wear and increased productivity.
- **Bits are nitrided — this process diffuses nitrogen into the surface to create a case hardening** for superior tool life and exceptional corrosion resistance for a longer lasting bit that saves time and money.

IBS CRYO-TECH NITRIDED HSS JOBBER'S LENGTH DRILL BITS

Drill Size	IBS No.	Overall Length	Flute Length	Qty	Drill Size	IBS No.	Overall Length	Flute Length	Qty	Drill Size	IBS No.	Overall Length	Flute Length	Qty
1/16	16600	1-7/8	7/8	6	7/32	16610	3-3/4	2-1/2	6	3/8	16620	5	3-5/8	3
5/64	16601	2	1	6	15/64	16611	3-7/8	2-5/8	6	25/64	16621	5-1/8	3-3/4	3
3/32	16602	2-1/4	1-1/4	6	1/4	16612	4	2-3/4	6	13/32	16622	5-1/4	3-7/8	2
7/64	16603	2-5/8	1-1/2	6	17/64	16613	4-1/8	2-7/8	3	27/64	16623	5-3/8	3-15/16	2
1/8	16604	2-3/4	1-5/8	6	9/32	16614	4-1/4	2-15/16	3	7/16	16624	5-1/2	4-1/16	2
9/64	16605	2-7/8	1-3/4	6	19/64	16615	4-3/8	3-1/16	3	29/64	16625	5-5/8	4-3/16	2
5/32	16606	3-1/8	2	6	5/16	16616	4-1/2	3-3/16	3	15/32	16626	5-3/4	4-5/16	2
11/64	16607	3-1/4	2-1/8	6	21/64	16617	4-5/8	3-5/16	3	31/64	16627	5-7/8	4-3/8	2
3/16	16608	3-1/2	2-5/16	6	11/32	16618	4-3/4	3-7/16	3	1/2	16628	6	4-1/2	2
13/64	16609	3-5/8	2-7/16	6	23/64	16619	4-7/8	3-1/2	3					

IBS Cryo-Tech™ Organizer

MADE IN THE U.S.A. (P15)



IBS No.	Description
16764	51 Pc. IBS Cryo-Tech 1/16 thru 1/2 x 64ths Cryo Jobber Length Handi-Bit Index

IBS Cryo-Tech™ Handi-Bit Set

MADE IN THE U.S.A.



IBS No.	Description
17437	29 Pc. IBS Cryo-Tech 1/16 thru 1/2 x 64ths Cryo Jobber Length Handi-Bit Index
17049	Cryo Red Handi Bit Index only (Empty)

D R I L L B I T S E T C



IBS, INCORPORATED

Nitro-Carb Drills P02

IBS Nitro-Carb Drill Bits

Super Premium High Performance Drills

More Holes Per Drill! Lower Cost Per Hole!

WHAT SETS THEM APART FROM THE REST

IBS Nitro-Carb Drill Bits are manufactured with a special **high Molybdenum tool steel** for a **more consistent drill bit** with a higher than average hardness and **more resistance to wear**. The **flutes** are ground to **1/2 of industry standard tolerances**, which means **more accuracy and more consistency** in grinding operations. The flutes also feature a nitro-carburized surface to provide extra wear resistance along the cutting edge of the point.



Tighter Tolerances

DISCOVER THE NITRO-CARB DIFFERENCE

IBS Nitro Carb Drill Bits feature a **split point** which provides the drill bit with **self-centering/non-walking characteristics**, and **reduces the thrust required** to penetrate a work piece. A low temperature surface treatment relieves stress; produces a gold color and improves lubricity.

Our **Mechanic's Length Drill Bits** as well as our **1/2" Reduced Shank Drill Bits** have **3 flats on the shank**. These flats allow for a **strong positive chuck grip** of the shank and virtually **eliminate** the potential for the drill to **slip into the chuck**.

These heavy duty drill bits are recommended for use in work hardening grades of stainless steel and other tough metal drilling applications. Heavy duty construction and the nitro-carburized, hi-molybdenum tool steel means:

- **EASILY CUTS:**
Stainless Steels • Tool Steels • Exotic Steels • Standard Steels
- **Substantially longer cutting life**
The nitro-carburized flute has an increased Rockwell hardness.
- **Cuts harder materials**
The flatter point takes a smaller chip. More torque is directed to a smaller area. This allows drilling into materials with hardness of over 30 on the Rockwell "C" scale.
- **Stops drill walking**
The split point design gives accurate starting without the use of a center punch.
- **Holds tighter hole size**
The split point design is self centering. This limits the normal oversize drilling characteristics.
- **Outstanding quality appearance**
The rich amber gold color sets it apart from commodity cutting tools.
- **Runs cooler, uses less torque**
135° point takes a smaller chip resulting in less heat. Amber gold surface treatment reduces friction. The Nitro-Carb bits will substantially out-perform cobalt drill bits in work hardening stainless steel applications. This performance advantage is the result of the construction difference between the two types of bits.



Nitro-Carburized Flute



135° Split Point



NITRO-CARB VS. COBALT

Cobalt bits, manufactured to **Type J NAS 907 specs**, have a very thick web. A thick web provides the strength needed to limit breakage of the cobalt steel.

Nitro-Carb bits are made of special hi-moly tool steel, which is much tougher than cobalt steel. The resulting strength of the Nitro-Carb bit allows the bit to be manufactured with a considerably thinner web. (See photo A).

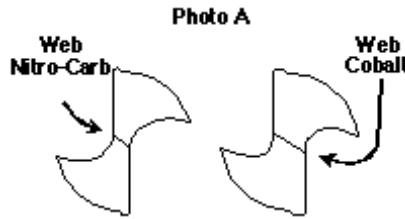

A Nitro-Carb bit with its thin web will penetrate the work hardening stainless fast enough to continually cut beneath the chip which is hardening from deformation. This means the drill bit is cutting softer steel. The cobalt bit, with its thick web, cannot be fed at a fast enough rate to cut beneath the area which is hardening. As a result the cobalt bit is continually drilling into hardened steel.

Re-sharpening Procedure

1. SET-UP FOR POINTING

- Clamp guide block on tool rest at 67.5°.
- Set tool rest below center line.
- Dress wheel for parallel edges and true face.
- Use an 80 to 100 grit semi-friable grinding wheel.

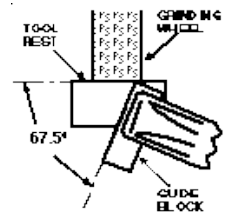
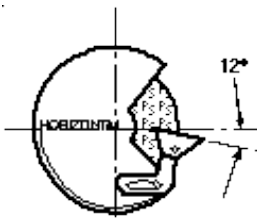

2. GRIND POINT ANGLE

Forming Primary Cutting Edge

- Pre-grind to remove all damaged edges.
- Place frill on tool rest parallel to guide block.
- Align cutting lip parallel to machine axis.
- Push into wheel.
- Repeat for second cutting edge.

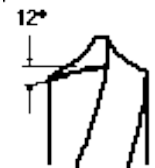
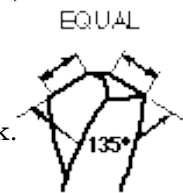
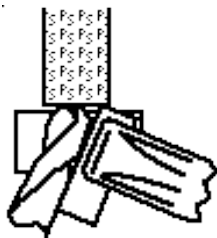

3. POINT SPLIT

Forming Secondary Cutting Edges

- Grind secondary cutting edges.
- Feed into wheel until center is reached.
- Repeat for other side.

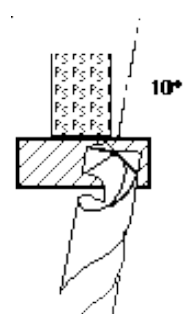
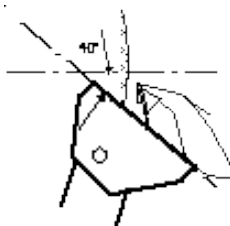
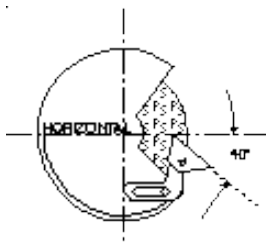

NOTE: ALL DAMAGED SECTIONS ON THE POINT AND MARGINS MUST BE GROUND AWAY PRIOR TO ANY ABOVE RESHARPENING PROCEDURE.



IBS, INCORPORATED

Nitro-Carb Drills P02

IBS Nitro-Carb Platinum Series Mechanics & Jobber's Lengths Nitro-Carb Drill Bits



"Platinum Series — The Proof is in the Performance"

D
R
I
L
L
B
I
T
S
E
T
C

- **BUILT FOR SUBSTANTIALLY LONGER CUTTING LIFE** - The Nitro-Carburized Flute has an increased Rockwell hardness providing strength without becoming brittle.
- **DESIGNED TO CUT HARDER MATERIALS** — The flatter point takes a smaller chip. More torque is directed to a smaller area. This allows drilling into materials with hardness of over 30 on the Rockwell "C" scale.
- **BLACK TREATED MARGINS** - designed to produce a free flow of chips and protect the cutting edge from heat abrasion for reduced friction and wear resulting in maximum life when drilling tough materials like stainless steel.
- **STAYS SHARP** - Flute Surface Treatment improves chip removal and reduces friction so bits maintain sharpness for longer life.
- **RUNS COOL** - **135° split point** takes a smaller chip, uses less torque and minimizes heat build up for longer life.
- **ELIMINATES DRILL WALKING** - The split point design gives accurate and quick-starting without the use of a center punch - (even on round surfaces) - fewer steps saves time.
- **PRODUCES TRUE HOLES** - The split point design self-centers and holds a tighter, truer hole size. This limits oversize drilling characteristics and produces accurate holes even in handheld applications.
- **NO CHUCK SLIPPAGE** - Flats on the Mechanic's Length drill shanks (3/16" and larger) allow easy positive chuck grip for safety, and speed — great for keyless chucks!
- **UNIQUE APPEARANCE** - the bright platinum flute and black web distinguish this bit from commodity cutting tools.
- **QUALITY ASSURANCE** - Bears the IBS stamp assuring that you are using a truly unique, high quality cutting tool.
- **MADE IN THE USA!**

IBS, INCORPORATED

Nitro-Carb Drills P02



IBS Nitro-Carb Platinum Series Drill Bits

"Platinum Series — The Proof is in the Performance"



PLATINUM SERIES NITRO CARB MECHANIC'S LENGTH DRILL BITS

Drill Size	IBS No.	Overall Length	Flute Length	Qty	Drill Size	IBS No.	Overall Length	Flute Length	Qty	Drill Size	IBS No.	Overall Length	Flute Length	Qty
1/16	17400	1-7/8	7/8	6	7/32	17410	3-1/4	2	6	3/8	17420	4-1/4	2-11/16	3
5/64	17401	2	1	6	15/64	17411	3-3/8	2-1/16	6	25/64	17421	4-5/16	2-3/4	3
3/32	17402	2-1/4	1-1/4	6	1/4	17412	3-1/2	2	6	13/32	17422	4-3/8	2-13/16	2
7/64	17403	2-3/8	1-5/16	6	17/64	17413	3-5/8	2-1/8	3	27/64	17423	4-7/16	2-7/8	2
1/8	17404	2-1/2	1-7/16	6	9/32	17414	3-3/4	2-1/4	3	7/16	17424	4-1/2	2-15/16	2
9/64	17405	2-5/8	1-9/16	6	19/64	17415	3-7/8	2-3/8	3	29/64	17425	4-5/8	3	2
5/32	17406	2-3/4	1-11/16	6	5/16	17416	4	2-1/2	3	15/32	17426	4-3/4	3-1/8	2
11/64	17407	2-7/8	1-13/16	6	21/64	17417	4-1/16	2-9/16	3	31/64	17427	4-7/8	3-1/4	2
3/16	17408	3	1-7/8	6	11/32	17418	4-1/8	2-5/8	3	1/2	17428	5	3-3/8	2
13/64	17409	3-1/8	1-15/16	6	23/64	17419	4-3/16	2-11/16	3					



PLATINUM SERIES NITRO CARB JOBBER'S LENGTH DRILL BITS

Drill Size	IBS No.	Overall Length	Flute Length	Qty	Drill Size	IBS No.	Overall Length	Flute Length	Qty	Drill Size	IBS No.	Overall Length	Flute Length	Qty
1/16	16800	1-7/8	7/8	6	7/32	16810	3-3/4	2-1/2	6	3/8	16820	5	3-5/8	3
5/64	16801	2	1	6	15/64	16811	3-7/8	2-5/8	6	25/64	16821	5-1/8	3-3/4	3
3/32	16802	2-1/4	1-1/4	6	1/4	16812	4	2-3/4	6	13/32	16822	5-1/4	3-7/8	2
7/64	16803	2-5/8	1-1/2	6	17/64	16813	4-1/8	2-7/8	3	27/64	16823	5-3/8	3-15/16	2
1/8	16804	2-3/4	1-5/8	6	9/32	16814	4-1/4	2-15/16	3	7/16	16824	5-1/2	4-1/16	2
9/64	16805	2-7/8	1-3/4	6	19/64	16815	4-3/8	3-1/16	3	29/64	16825	5-5/8	4-3/16	2
5/32	16806	3-1/8	2	6	5/16	16816	4-1/2	3-3/16	3	15/32	16826	5-3/4	4-5/16	2
11/64	16807	3-1/4	2-1/8	6	21/64	16817	4-5/8	3-5/16	3	31/64	16827	5-7/8	4-3/8	2
3/16	16808	3-1/2	2-5/16	6	11/32	16818	4-3/4	3-7/16	3	1/2	16828	6	4-1/2	2
13/64	16809	3-5/8	2-7/16	6	23/64	16819	4-7/8	3-1/2	3					

D R I L L B I T S E T C



IBS, INCORPORATED

Nitro-Carb Drill Bit Sets P15

Handi-Bit 29 PcDrill Bit Sets

Available in Black and Hi-Visibility Indexes



Our 29 pc clip-on drill index is ideal for use both in the shop or at the job site. Made from high impact plastic, the Handi-Bit canister has a molded side hook that clips on to a tool caddy, utility belt, tool bucket, or ladder. Eliminate wasted time searching for the correct drill bit - 29 different sizes are in hands reach. With a screw-on plastic hex shaped cover, drill bits will remain secure and protected. Available in **Mechanics, Jobbers and Left Handed** styles.

- Contains drill bits from 1/16" to 1/2" by 64ths.
- Screw-on hex-shaped cover protects & contains drill bits.
- Water-resistant, great for outdoor job sites.
- Constructed of high-impact, break resistant plastic.
- Available in Black and Hi-Visibility Yellow Handi-Bit Indexes

BLACK DRILL INDEX

HI-VISIBILITY DRILL INDEX

IBS No.	Description	Qty	IBS No.	Description	Qty
17435	Mechanic's Length	1	17460	Mechanic's Length	1
17438	Jobber's Length	1	17461	Jobber's Length	1
17439	Left Hand Jobbers Length	1	17462	Left Hand Jobber's Length	1

D
R
I
L
L

B
I
T
S

E
T
C

IBS, INCORPORATED

Nitro-Carb Drill Assortments P15



Nitro-Carb Drill Bit Sets Jobber's Length



JOBBER'S LENGTH DRILL BIT SETS - INDEX

IBS No.	Description
16756	13 Pc. Jobbers Length Fractional Drill Set Sizes 1/16" to 1/4" by 64ths. Complete with index.
16755	15 Pc. Jobber's Length Drill Set Sizes 1/16" to 1/2" by 32nds. Packaged in a 29 Pc. index for expansion to 64ths sizes
16759	15 Pc. Jobbers Length Drill Set Sizes 1/16" to 1/2" by 32nds. Complete with 32nds index
16757	21 Pc. Jobber's Length Drill Set Sizes 1/16" to 3/8" by 64ths Complete with index
16760	29 Pc. Jobber's Length Drill Set Sizes 1/16" to 1/2" by 64ths. Complete with index.
16763	115 Pc. Fractional, Letter & Number Drill Set Contains Platinum Series and Nitro-Carb Drill Bits Letter Drills A to Z (NC) Number Drills #1 through #60 (NC) Fractional drills 1/16" to 1/2" by 64ths (Platinum)



JOBBER'S LENGTH DRILL BIT SET - ORGANIZER

IBS No.	Description
16762	51 Pc Jobbers Length Drill Set 29 of the most popular drill bit sizes. Contains 51 Platinum drill bits Sizes 1/16" to 1/2" by 64ths. Complete with 3 drawer organizer See Chart for sizes and quantities.

Nitro-Carb Drill Bit Sets Mechanic's Length



MECHANIC'S LENGTH DRILL BIT SETS - INDEX

IBS No.	Description
17433	13 Pc. Mechanic's Length Drill Set Sizes 1/16" to 1/4" by 64ths. Complete with index
17432	15 Pc. Mechanic's Length Drill Set Sizes 1/16" to 1/2" by 32nds. Packaged in a 29 Pc. index for expansion to 64ths sizes
17434	21 Pc. Mechanic's Length Drill Set Sizes 1/16" to 3/8" by 64ths. Complete with index
17431	29 Pc. Mechanic's Length Drill Set Sizes 1/16" to 1/2" by 64ths Complete with index.



MECHANIC'S LENGTH DRILL BIT SET - ORGANIZER

IBS No.	Description
17430	51 Pc Mechanic's Length Drill Set 29 of the most popular drill bit sizes. Contains 51 Platinum drill bits Sizes 1/16" to 1/2" by 64ths. Complete with 3 drawer organizer See Chart for sizes and quantities.

16762 & 17430 BIT SIZES & QUANTITIES

Size	Qty.	Size	Qty.	Size	Qty.	Size	Qty.
1/16	3	3/16	4	5/16	1	7/16	1
5/64	3	13/64	1	21/64	1	29/64	1
3/32	3	7/32	1	11/32	1	15/32	1
7/64	3	15/64	1	23/64	1	31/64	1
1/8	5	1/4	3	3/8	1	1/2	1
9/64	3	17/64	1	25/64	1		
5/32	3	9/32	1	13/32	1		
11/64	2	19/64	1	27/64	1		

D R I L L B I T S E T C



IBS, INCORPORATED

Nitro-Carb Drills P02

Nitro-Carb Number Drills

Sizes #1 — #52 are 135° split point.
 Sizes #53 — #80 are non-split point.
 Sizes #61 — #80 are high speed steel.



NITRO CARB NUMBER DRILL BITS

Drill Size	IBS No.	Drill Size	IBS No.	Drill Size	IBS No.
#1	16080	#28	16107	#55	15927
#2	16081	#29	16108	#56	15928
#3	16082	#30	16109	#57	15929
#4	16083	#31	16110	#58	15930
#5	16084	#32	16111	#59	15931
#6	16085	#33	16112	#60	15932
#7	16086	#34	16113	#61	16715
#8	16087	#35	16114	#62	16716
#9	16088	#36	16115	#63	16717
#10	16089	#37	16116	#64	16718
#11	16090	#38	16117	#65	16719
#12	16091	#39	16118	#66	16720
#13	16092	#40	16119	#67	16721
#14	16093	#41	16120	#68	16722
#15	16094	#42	16121	#69	16723
#16	16095	#43	16122	#70	16724
#17	16096	#44	16123	#71	16725
#18	16097	#45	16124	#72	16726
#19	16098	#46	16125	#73	16727
#20	16099	#47	16126	#74	16728
#21	16100	#48	16127	#75	16729
#22	16101	#49	16128	#76	16730
#23	16102	#50	16129	#77	16731
#24	16103	#51	16130	#78	16732
#25	16104	#52	16131	#79	16733
#26	16105	#53	16132	#80	16734
#27	16106	#54	15926		

Sold in quantities of (1)

Nitro-Carb Letter Drills



NITRO CARB LETTER DRILL BITS A - Z

Drill Size	IBS No.	Drill Size	IBS No.
A	16135	N	16148
B	16136	O	16149
C	16137	P	16150
D	16138	Q	16151
E	16139	R	16152
F	16140	S	16153
G	16141	T	16154
H	16142	U	16155
I	16143	V	16156
J	16144	W	16157
K	16145	X	16158
L	16146	Y	16159
M	16147	Z	16160

Sold in quantities of (1)

Letter & Number Drill Bit Sets (P15)



LETTER & NUMBER DRILL BIT SETS - INDEX

IBS No.	Description
16703	60 Pc. Jobber's Length Number Drill Set Sizes #1 through #60. Complete with Index.
16704	26 Pc. Jobber's Length Letter Drill Set Sizes A through Z. Complete with index.
16713	60 Pc. Jobber's Length Number Drill Set Sizes #1 through #60. Complete with 5 drawer organizer.
16714	26 Pc. Jobber's Length Letter Drill Set Sizes A through Z. Complete with 3 drawer organizer.

D
R
I
L
L
B
I
T
S
E
T
C



Nitro-Carb Quick-Change Hex Shank Drill Bits (P21)



A new version of our superior Nitro-Carb Mechanics Length Drill Bits featuring the convenience of a quick change hex shank.

- One piece machined shank (bits larger than 1/4") encounter more torque to withstand. Competitor bits have cast shanks that do not stand up to the force and constant use.
- All metal, welded shank design (bits 1/4" and smaller) — competitor bits have cast shanks that do not stand up to the force and constant use.
- Special Hi-Molybdenum tool steel.
- 135° split point for fast penetration and accurate starting without center punch.
- Body and clearance are treated for maximum lubricity.
- Especially designed for hand held drills.
- Recommended for use in hardening grades of stainless steel and other hard metal drill applications.
- Quick release eases changing of cutting tools

Drill Size	IBS No.	Drill Size	IBS No.
1/16	15400	5/16	15416
3/32	15402	11/32	15418
1/8	15404	3/8	15420
5/32	15406	13/32	15422
3/16	15408	7/16	15424
7/32	15410	15/32	15426
1/4	15412	1/2	15428
9/32	15414		

Sold in quantities of (1)

Nitro-Carb Quick-Change Hex Shank Drill Bit Sets (P15)



15429, 15430



15431



15432

IBS No.	Description
15429	7 Pc. Nitro-Carb Mech Length Drill Bit Set - Pouch. Sizes 1/16 to 1/4 by 32nds
15430	7 Pc. Nitro-Carb Mech Length Drill Bit Set - Pouch. Sizes 1/8 to 1/2 by 16ths
15431	16 Pc. Nitro-Carb Mech Length Drill Bit Set - Pouch. Sizes 1/16 to 1/2 by 32nds
15432	12 Pc. Nitro-Carb Mech Length Drill Bit Set - Hard Case. Sizes 1/16 to 1/2 by 32nds

Quick Release Drill Bit & Insert Assortment
IBS No. 744R • 22 Items • 28 Pcs
Packaged in a locking steel drawer for easy storage and organization

IBS, Inc. <small>SPECIALTY PRODUCTS FOR MAINTENANCE & REPAIR</small> <small>INDUSTRIALDRILL.COM • 9 9 C 800-678-1906</small>				Quick Release Drill Bit and Power Bit Assortment <small>Assortment No. 744R</small>	
<small>ITEMS FOR EXPANSION</small>					
15404 1/8 HEX SHANK DRILL <small>*15400 1/16 HEX SHANK DRILL *15402 3/32 HEX SHANK DRILL</small>	15406 5/32 MECH LGTH NITRO CARB QUICK RELEASE HEX SHANK DRILL	15408 3/16 MECH LGTH NITRO CARB QUICK RELEASE HEX SHANK DRILL	15410 7/32 MECH LGTH NITRO CARB QUICK RELEASE HEX SHANK DRILL		
15412 1/4 MECH LGTH NITRO CARB QUICK RELEASE HEX SHANK DRILL	15414 9/32 MECH LGTH NITRO CARB QUICK RELEASE HEX SHANK DRILL	15416 5/16 MECH LGTH NITRO CARB QUICK RELEASE HEX SHANK DRILL			
15418 11/32 MECH LGTH NITRO CARB QUICK RELEASE HEX SHANK DRILL	15420 3/8 MECH LGTH NITRO CARB QUICK RELEASE HEX SHANK DRILL	<small>*15422 13/32 HEX SHANK DRILL *15424 7/16 HEX SHANK DRILL *15426 15/32 HEX SHANK DRILL *15428 1/2 HEX SHANK DRILL</small>			
250-PB11 #1 PHIL X 1-15/16 POWER BIT	250-PB12 #2 PHIL X 1-15/16 POWER BIT	250-PB13 #3 PHIL X 1-15/16 POWER BIT	MSH1/4 1/4 NUT DRIVER	140341 COMBO QUICK CHANGE BIT HOLDER	
250-PB31 #1 PHIL X 3-1/2 POWER BIT	250-PB32 #2 PHIL X 3-1/2 POWER BIT	250-PB33 #3 PHIL X 3-1/2 POWER BIT	MSH5/16 5/16 NUT DRIVER		
250-R11 #1 SQ. DRIVE X 1-15/16 POWER BIT	250-R12 #2 SQ. DRIVE X 1-15/16 POWER BIT	250-R13 #3 SQ. DRIVE X 1-15/16 POWER BIT	MSH3/8 3/8 NUT DRIVER		



IBS, INCORPORATED

Nitro-Carb Drills P02

D
R
I
L
L
B
I
T
S
E
T
C

1/2" & 3/8" Reduced Shank Drill Bits (P03)

- Hi-Molybdenum tool steel.
- Heavy duty construction.
- 135° split point - Sizes larger than 1" have 118° split point.
- 3 flats on shank (on 1/2" Reduced Shank Only) individually tubed and insure positive chucking without slippage
- Gold surface treated body and clearance for maximum lubricity.
- 6" Overall Length.



3/8" REDUCED SHANK DRILL BITS

Drill Size	IBS No.	Qty.	Drill Size	IBS No.	Qty.
25/64	16870	1	29/64	16874	1
13/32	16871	1	15/32	16875	1
27/64	16872	1	31/64	16876	1
7/16	16873	1	1/2	16877	1



1/2" REDUCED SHANK DRILL BITS

Drill Size	IBS No.	Qty.	Drill Size	IBS No.	Qty.
33/64	16833	1	13/16	16852	1
17/32	16834	1	53/64	16853	1
35/64	16835	1	27/32	16854	1
9/16	16836	1	55/64	16855	1
37/64	16837	1	7/8	16856	1
19/32	16838	1	57/64	16857	1
39/64	16839	1	29/32	16858	1
5/8	16840	1	59/64	16859	1
41/64	16841	1	15/16	16860	1
21/32	16842	1	61/64	16861	1
43/64	16843	1	31/32	16862	1
11/16	16844	1	63/64	16863	1
45/64	16845	1	1	16864	1
23/32	16846	1	1-1/16	16865	1
47/64	16847	1	1-1/8	16866	1
3/4	16848	1	1-1/4	16867	1
49/64	16849	1	1-3/8	16868	1
25/32	16850	1	1-1/2	16869	1
51/64	16851	1			

1/2" Mechanic's Length Platinum Series Reduced Shank Drills (P03)

- Hi-Molybdenum tool steel.
- Heavy duty construction.
- 135° split point - Sizes larger than 1" have 118° split point.
- Black treated margins provides a free flow of chips and protects the cutting edge from heat abrasion so drills last longer when drilling tough materials like stainless steel.
- 3 flats on shank individually tubed and insure positive chucking without slippage.
- Designed for use in work hardening grades of stainless steel and other hard metal drilling applications.
- 5" Overall Length.



1/2" REDUCED SHANK DRILL BITS

Drill Size	IBS No.	Qty.	Drill Size	IBS No.	Qty.
9/16	16881	1	13/16	16889	1
5/8	16883	1	7/8	16891	1
11/16	16885	1	15/16	16893	1
3/4	16887	1	1	16895	1

Reduced Shank Nitro-Carb Drill Bit Sets(P15)



REDUCED SHANK DRILL BIT SETS - CASE

IBS No.	Description
16897	4 Pc. Reduced Shank Mechanics Length PLATINUM SERIES 9/16, 5/8, 3/4, 1" Complete with sturdy storage case
16898	4 Pc. Jobber's Length Nitro-Carb Reduced Shank Drill Set 9/16, 5/8, 3/4, 1" Complete with sturdy storage case



Reduced Shank Nitro-Carb Drill Sets (P15)



3/8 REDUCED SHANK DRILL BIT SETS - INDEX

IBS No.	Description
16706	29 Pc. Jobber's Length Nitro-Carb Reduced Shank Drill Set 1/16" to 1/2" by 64ths 3/8" shank on drill sizes larger than 3/8" Complete with metal index
16707	15 Pc. Jobber's Length Reduced Shank Starter Set 1/16" to 1/2" by 32nds. 3/8" shank on drill sizes larger than 3/8" Complete with 29 pc index for expansion NOTE: Contains same drills as 16705 - different index
16705	15 Pc. Jobber's Length Reduced Shank Starter Set 1/16" to 1/2" by 32nds. 3/8" shank on drill sizes larger than 3/8" Complete with 29 pc index for expansion NOTE: Contains same drills as 16707 - different index



1/2 REDUCED SHANK DRILL BIT SETS - INDEX

IBS No.	Description
16761	8 Pc. Jobber's Length Reduced Shank Drill Set 9/16, 5/8, 11/16, 3/4, 13/16, 7/8, 15/16, 1" Complete with metal index
16899	8 Pc. Mechanic's Length Reduced Shank Drill Set 9/16, 5/8, 11/16, 3/4, 13/16, 7/8, 15/16, 1" Complete with metal index



REDUCED SHANK DRILL BIT SETS - STAND

IBS No.	Description
16709	4 Pc. Jobber's Length Reduced Shank Drill Set 9/16, 5/8, 11/16, 3/4" Complete with metal stand
16710	33 Pc. Jobber's Length Reduced Shank Drill Set 1/2, 33/64, 17/32, 35/64, 9/16, 37/64, 19/32, 39/64, 5/8, 41/64, 21/32, 43/64, 11/16, 45/64, 23/32, 47/64, 3/4", 49/64, 25/32, 51/64, 13/16, 53/64, 27/32, 55/64, 7/8, 57/64, 29/32, 59/64, 15/16, 61/64, 31/32, 63/64, 1" Complete with metal stand

D
R
I
L
L
B
I
T
S
E
T
C



IBS, INCORPORATED

Nitro-Carb Drills (P02)

Carbide Tipped Straight Flute Drills for Hard Steel (P20)



When other drill bits can't cut it, turn to the bit designed for hardened steels and drilling out broken items such as studs and taps.

- Straight-flute drill bits are stronger than spiral-flute drill bits and resist breaking when drilling into hard and abrasive materials, such as hardened steels with a Rockwell hardness of 35 to 60 HRC.
- The bits provide free cutting action, generate minimal heat during drilling and leave a smooth finish on the hole without requiring a reaming pass
- Straight flutes help with chip evacuation in horizontal drilling applications.
- Carbide-tipped drill bits have carbide cutting edges that provide excellent hardness, wear resistance, and heat resistance.
- The bit's body is made from a material that absorbs more vibration and shock than carbide, so they are less rigid and less likely to break than solid carbide drill bits.

IBS No.	Diameter (in.)	Shank Diameter (in)	Overall Length (in)	Qty
16173	3/16	3/16	3	1
16175	1/4	1/4	4	1
16178	5/16	1/4	4	1
16180	3/8	3/8	6	1
16183	1/2	1/2	6	1
17463	5 Pc Carbide Tipped Straight Flute Drill Set for Hard Steel (P15)			1
834R	5 Pc Carbide Tipped Straight Flute Drill Set for Hard Steel (P15)			



5 Pc Carbide Tipped Straight Flute Drill Set

IBS No. 17463 • 5 Items • 5 Pcs

Includes sizes

3/16, 1/4, 5/16, 3/8 & 1/2

Packaged in a Folding Pouch for Easy Storage and Organization

- Pouch holds up to 7 drills (IBS No. 17035).
- Sturdy belt clip for convenience.
- **Pouch Dimensions:** Closed 3-1/2" X 6-1/2"
Open: 3-1/2" X 13"

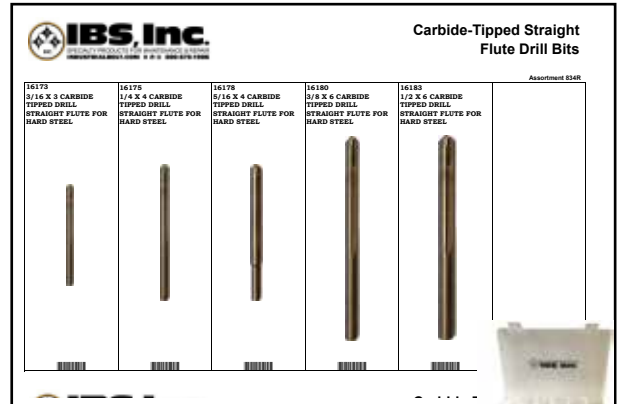

5 Pc Carbide Tipped Straight Flute Drill Set

IBS No. 834R • 5 Items • 5 Pcs

Includes sizes

3/16, 1/4, 5/16, 3/8 & 1/2"

Packaged in Plastic Travel Tray for Easy Storage & Organization

D
R
I
L
L
B
I
T
S
E
T
C



Nitro-Carb Drill Bits P02

Left Hand Drill Bits (P16)

- Nitro-Carburized Hi-Molybdenum tool steel.
- Gold surface treated for maximum lubricity.
- Self centering 135° split point for fast penetration & accurate starting without a center punch.
- Precision ground point, flutes and body, clearance, and drill diameter provide the ultimate in accuracy and performance.
- Ideal for drilling broken studs.
- Need for screw and bolt extractor may be eliminated.



Drill Size	IBS No.	Qty.	Drill Size	IBS No.	Qty.	Drill Size	IBS No.	Qty.	Drill Size	IBS No.	Qty.
1/16	15940	3	3/16	15948	2	5/16	15957	1	7/16	15965	1
5/64	15941	3	13/64	15949	2	21/64	15958	1	29/64	15966	1
3/32	15942	3	7/32	15950	2	11/32	15959	1	15/32	15967	1
7/64	15943	3	15/64	15951	2	23/64	15960	1	31/64	15968	1
1/8	15944	3	1/4	15953	2	3/8	15961	1	1/2	15969	1
9/64	15945	3	17/64	15954	1	25/64	15962	1			
5/32	15946	3	9/32	15955	1	13/32	15963	1			
11/64	15947	2	19/64	15956	1	27/64	15964	1			

Left Hand Drill Bit Sets (P15)



LEFT HAND DRILL BIT SETS - INDEX

IBS No.	Description
15970	8 Pc. Left Hand Nitro Carb Drill Bit Starter Set 1/16 thru 1/2 x 1/16ths. Packaged in a 15 pc index for expansion
15971	29 Pc. Left Hand Nitro Carb Drill Bit Set 1/16 thru 1/2 x 64ths. Packaged in a 29 Pc Index
17429	8 Pc. Left Hand Nitro Carb Drill Bit Set 1/16 thru 1/2 x 16ths. Packaged in a 29 Pc Handi-Bit Index for expansion
17439	29 Pc. Left Hand Nitro Carb Drill Bit Set 1/16 thru 1/2 x 64ths. Packaged in a 29 Pc Handi-Bit Index

D R I L L B I T S E T C



IBS, INCORPORATED

Nitro-Carb Drill Bits P02

Left Hand Stubby Drill Bits

- **PERFECT FOR REMOVING BROKEN BOLTS AND STUDS** – The shorter length makes for a stronger, more stable drill and the left hand flute design assists with drilling out broken bolts and studs without tightening further - actually loosening and backing out the broken bolt or stud – saving time and money on costly repairs.
- **Nitro-Carburized** Hi-Molybdenum tool steel.
- **Gold surface treated** for maximum lubricity.
- **Self centering 135° split point** for fast penetration & accurate starting without a center punch.
- **Precision ground point, flutes and body**, clearance, and drill diameter provide the ultimate in accuracy and performance.
- **NO CHUCK SLIPPAGE** — Flats on the Stubby Length drill shanks allow easy positive chuck grip for safety and speed — great for keyless chucks!
- Ideal for removing broken studs.
- Need for screw and bolt extractor may be eliminated.
- **MADE IN THE USA!**



Nitro-Carb Left Hand Stubby Drill Set (P15)

Drill Size	IBS No.	Qty.	Drill Size	IBS No.	Qty.
1/16	18400	3	9/32	18414	1
5/64	18401	3	5/16	18416	1
3/32	18402	3	11/32	18418	1
1/8	18404	3	3/8	18420	1
5/32	18406	3	13/32	18422	1
3/16	18408	2	7/16	18424	1
7/32	18410	2	15/32	18426	1
1/4	18412	2	1/2	18428	1



IBS No.	Description
16702	15 Pc. Nitro-Carb Left Hand Stubby Drill Index Set 1/16 thru 1/2 x 64ths. Complete with metal index

Power Out Extractor & Stubby Left Hand Drill Bit Travel Tray

IBS No. 818R • 10 Items • 10 Pcs • (P15)

Packaged in an adjustable compartment small plastic travel tray for easy storage and organization

Power-Out Extractor & Stubby Left Hand Nitro Carb Drill Bit

Assortment 818R

<p>139501 #1 POWER-OUT DBL EDGED SCREW EXTRACTOR</p>	<p>139502 #2 POWER-OUT DBL EDGED SCREW EXTRACTOR</p>	<p>139503 #3 POWER-OUT DBL EDGED SCREW EXTRACTOR</p>	<p>139504 #4 POWER-OUT DBL EDGED SCREW EXTRACTOR</p>	<p>139505 #5 POWER-OUT DBL EDGED SCREW EXTRACTOR</p>	
<p>18406 5/32 STUBBY LEFT HAND NITRO CARB DRILL</p>	<p>18412 1/4 STUBBY LEFT HAND NITRO CARB DRILL</p>	<p>18416 5/16 STUBBY LEFT HAND NITRO CARB DRILL</p>	<p>18424 7/16 STUBBY LEFT HAND NITRO CARB DRILL</p>	<p>18428 1/2 STUBBY LEFT HAND NITRO CARB DRILL</p>	

IBS, INCORPORATED

Nitro-Carb Drill Bits P02



Nitro-Carb Double End Drills (P20)



- Self centering 135° split point.
- Nitro-Carburized Hi-Molybdenum tool steel.
- 2 drills in one means twice the holes per drill and lower costs per hole.
- Ideal for pop rivet applications, truck and auto bodies and any thin sheet metal applications.

Drill Size	IBS No.	Qty.	Drill Size	IBS No.	Qty.
1/8	15909	6	1/4	15915	6
5/32	15910	6	#11	15917	6
3/16	15911	6	#20	15918	6
7/32	15912	6	#30	15919	6

Nitro-Carb Double End Drill Travel Tray (P15)

IBS No. 17442 • 6 Items • 12 Pcs

Packaged in an adjustable compartment small plastic travel tray for easy storage and organization



Stubby Drill Bits



- Hi-Molybdenum tool steel.
- Heavy duty construction.
- 135° split point, no center punch needed — will not walk.
- Recommended for work hardening grades of stainless steel and other hard metal drilling applications.
- Gold surface treated body and clearance for maximum lubricity.
- Short length of drill makes this an especially rigid drill for greater drilling accuracy.
- Less stress due to shorter length and less breakage.
- Drill is designed for ease of penetration and to facilitate chip removal in tough, hard materials.

Drill Size	IBS No.	Qty.	Drill Size	IBS No.	Qty.	Drill Size	IBS No.	Qty.	Drill Size	IBS No.	Qty.
1/16	17800	6	3/16	17808	6	5/16	17816	3	7/16	17824	2
5/64	17801	6	13/64	17809	6	21/64	17817	3	29/64	17825	2
3/32	17802	6	7/32	17810	6	11/32	17818	3	15/32	17826	2
7/64	17803	6	15/64	17811	6	23/64	17819	3	31/64	17827	2
1/8	17804	6	1/4	17812	3	3/8	17820	3	1/2	17828	2
9/64	17805	6	17/64	17813	3	25/64	17821	2			
5/32	17806	6	9/32	17814	3	13/32	17822	2			
11/64	17807	6	19/64	17815	3	27/64	17823	2			



Stubby Nitro-Carb Drill Set (P15)

IBS No.	Description
16708	29 Pc. Nitro-Carb Stubby Drill Bit Set 1/16 thru 1/2 x 64ths. Complete with metal index
16711	15 Pc. Nitro-Carb Stubby Drill Bit Set 1/16 thru 1/2 x 32nds. Complete with metal index

D R I L L B I T S E T C



IBS, INCORPORATED

Nitro-Carb Drill Bits P02

Metric Nitro-Carb Drill Bits (P02)

- Nitro-Carburized Hi-Molybdenum tool steel.
- Gold surface treated for maximum lubricity.
- Self centering 135° split point for fast penetration & accurate starting without a center punch.
- Precision ground point, flutes and body, clearance, and drill diameter provide the ultimate in accuracy and performance.

DRILL BITS ETC

Drill Size	IBS No.	Qty.	Drill Size	IBS No.	Qty.	Drill Size	IBS No.	Qty.	Drill Size	IBS No.	Qty.
.7	17830	1	3.0	17864	1	6.4	17898	1	9.8	17932	1
.8	17831	1	3.1	17865	1	6.5	17899	1	9.9	17933	1
.85	17832	1	3.2	17866	1	6.6	17900	1	10.0	17934	1
.9	17833	1	3.3	17867	1	6.7	17901	1	10.1	17935	1
.95	17834	1	3.4	17868	1	6.8	17902	1	10.2	17936	1
1.0	17835	1	3.5	17869	1	6.9	17903	1	10.3	17937	1
1.05	17836	1	3.6	17870	1	7.0	17904	1	10.4	17938	1
1.1	17837	1	3.7	17871	1	7.1	17905	1	10.5	17939	1
1.15	17838	1	3.8	17872	1	7.2	17906	1	10.6	17940	1
1.2	17839	1	3.9	17873	1	7.3	17907	1	10.7	17941	1
1.25	17840	1	4.0	17874	1	7.4	17908	1	10.8	17942	1
1.3	17841	1	4.1	17875	1	7.5	17909	1	10.9	17943	1
1.35	17842	1	4.2	17876	1	7.6	17910	1	11.0	17944	1
1.4	17843	1	4.3	17877	1	7.7	17911	1	11.1	17945	1
1.45	17844	1	4.4	17878	1	7.8	17912	1	11.2	17946	1
1.5	17845	1	4.5	17879	1	7.9	17913	1	11.3	17947	1
1.55	17846	1	4.6	17880	1	8.0	17914	1	11.4	17948	1
1.6	17847	1	4.7	17881	1	8.1	17915	1	11.5	17949	1
1.65	17848	1	4.8	17882	1	8.2	17916	1	11.6	17950	1
1.7	17849	1	4.9	17883	1	8.3	17917	1	11.7	17951	1
1.75	17850	1	5.0	17884	1	8.4	17918	1	11.8	17952	1
1.8	17851	1	5.1	17885	1	8.5	17919	1	11.9	17953	1
1.9	17852	1	5.2	17886	1	8.6	17920	1	12.0	17954	1
2.0	17853	1	5.3	17887	1	8.7	17921	1	12.1	17955	1
2.05	17854	1	5.4	17888	1	8.8	17922	1	12.2	17956	1
2.1	17855	1	5.5	17889	1	8.9	17923	1	12.3	17957	1
2.2	17856	1	5.6	17890	1	9.0	17924	1	12.4	17958	1
2.3	17857	1	5.7	17891	1	9.1	17925	1	12.5	17959	1
2.4	17858	1	5.8	17892	1	9.2	17926	1	12.6	17960	1
2.5	17859	1	5.9	17893	1	9.3	17927	1	12.7	17961	1
2.6	17860	1	6.0	17894	1	9.4	17928	1	12.8	17962	1
2.7	17861	1	6.1	17895	1	9.5	17929	1	12.9	17963	1
2.8	17862	1	6.2	17896	1	9.6	17930	1	13.0	17964	1
2.9	17863	1	6.3	17897	1	9.7	17931	1			

GRAY shaded lines indicate NON-STOCK items. Allow 2-3 weeks extra order processing time.

IBS, INCORPORATED

Nitro-Carb Drill Bits P02



Metric Nitro-Carb Drill Bit Sets (P15)

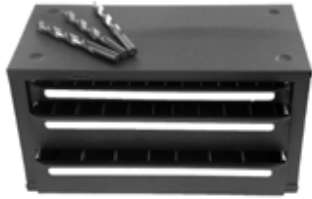

IBS No.	Description
17450	25 Pc Metric Nitro-Carb Drill Bit Set 25 of the most popular drill bit sizes. 1mm thru 13mm by .5mm Complete with 3 drawer organizer



METRIC NITRO-CARB DRILL BIT SET - INDEX

IBS No.	Description
17451	19 Pc. Metric Nitro-Carb Drill Bit Set 1mm thru 10mm x .5mm Complete with metal index
17452	25 Pc. Metric Nitro-Carb Drill Bit Set 1mm thru 13mm x .5mm Complete with metal index

Extended Length Drill Bits Aircraft Drill Bits (P18)

- Ideal for drilling where extra reach is needed.
- 135° split point.
- Bright finish.
- High speed steel.



IBS No.	Drill Size	Flute Length	Qty
59616	1/4 x 12	2-3/4	1
59620	5/16 x 12	3-3/16	1
59624	3/8 x 12	3-5/8	1
59628	7/16 x 12	4-1/16	1
59632	1/2 x 12	4-1/2	1

Economy Drill Bits (P2A)

- 118° point.
- General purpose drills for portable and machine drilling.
- Designed to perform well in low and medium carbon steel cast iron & wood.
- Bright finish.



Drill Size	IBS No.	Qty.	Drill Size	IBS No.	Qty.
1/16	17104	1	19/64	17119	1
5/64	17105	1	5/16	17120	1
3.32	17106	1	21/64	17121	1
7/64	17107	1	11/32	17122	1
1/8	17108	1	23/64	17123	1
9/64	17109	1	3/8	17124	1
5/32	17110	1	25/64	17125	1
11/64	17111	1	13/32	17126	1
3/16	17112	1	27/64	17127	1
13/64	17113	1	7/16	17128	1
7/32	17114	1	29/62	17129	1
15/64	17115	1	15/32	17130	1
1/4	17116	1	31/64	17131	1
17/64	17117	1	1/2	17132	1
9/32	17118	1			



ECONOMY DRILL BIT SET - INDEX

IBS No.	Description
16701	29 Pc. Economy Drill Bit Set 1/16 thru 1/2 x 64ths Complete with metal index

D R I L L B I T S E T C



IBS, INCORPORATED

Masonry Drill Bits

Straight Shank Masonry Drill Bits (P20)



- Carbide tipped, surface treated, regular helix.
- Heat-resistant up to 1800°F.
- Diamond ground tungsten carbide tip is copper brazed for long life and heat resistance.
- Manufactured with a 15° negative grind to reduced carbide chipping.
- Wide flute provides fast dust removal in softer materials.
- Straight shank bits for professional use in 3-jaw chuck drill for drilling brick, concrete, cinder block, stone, etc.
- Produced according to ANSI standards to meet application tolerances.

IBS No.	Size	Length (Overall x Flute)	Qty	IBS No.	Size	Length (Overall x Flute)	Qty
15896	1/8	3 x 1-3/8	1	15904	9/16	6 x 3-1/2	1
15897	5/32	3 x 1-1/2	1	15905	5/8	6 x 3	1
15897A	5/32	6 x 4	1	15906	3/4	6-3/4 x 3-1/2	1
15898	3/16	3-1/2 x 1-9/16	1	15907	7/8	6-1/4 x 3-1/2	1
15898A	3/16	6 x 3-1/2	1	15908	7/8	13 x 9	1
15899	7/32	6 x 4	1	159081	1	6-1/4 x 4	1
15900	1/4	4 x 2-1/8	1	159082	1	13 x 9	1
159001	1/4	6 x 4	1	15902	3/8	6 x 3-1/2	1
159002	9/32	4 x 2-1/2	1	159021	7/16	6 x 3-1/2	1
15901	5/16	4-3/4 x 2-3/4	1	15903	1/2	6 x 3-1/2	1
159011	3/8	4-1/2 x 2-3/4	1				

Straight Shank Masonry Drill Bits — 5 Pc Set (P15)

IBS No. 15998

- Sizes range from 5/32" to 1/2".
- Packaged in a clear plastic index.

Includes sizes:

IBS No.	Size	Length	IBS No.	Size	Length
15897A	5/32	6	15902	3/8	6
15898A	3/16	6	15903	1/2	6
159001	1/4	6			





SDS Plus Masonry Drill Bits

Faster drilling from a new carbide tip which features:

- Brazing and hardening are completed in a unique oven process guaranteeing a higher uniform quality.
- Self centering for precise starts.
- 160° angle means optimum elasticity and wear resistance for superior function and longevity.

Longer life from:

- Bronze alloy brazing of the carbide tip withstands heat better than silver used on many competitive products.
- High quality shot-peened steel strengthened to relieve tension and bit breakage.
- New wide fluting design flows the dust out of the hole faster, thus reducing friction and adding life to the carbide cutting.

IBS No.	Size	Total Length	Usable Length	Qty	IBS No.	Size	Total Length	Usable Length	Qty
15800	5/32	4	2	1	15825	7/16	6	4	1
15801	5/32	6	4	1	15826	7/16	12	10	1
15802	3/16	4	2	1	15827	1/2	6	4	1
15803	3/16	6	4	1	15828	1/2	8	6	1
15804	3/16	8	6	1	15829	1/2	12	10	1
15805	3/16	12	10	1	15830	1/2	18	16	1
15806	7/32	6	4	1	15831	1/2	24	22	1
15807	7/32	8	6	1	15832	9/16	6	4	1
15808	7/32	16	14	1	15833	9/16	12	10	1
15809	1/4	4	2	1	15834	9/16	18	16	1
15810	1/4	6	4	1	15835	5/8	6	4	1
15811	1/4	8	6	1	15836	5/8	8	6	1
15812	1/4	12	10	1	15837	5/8	12	10	1
15813	1/4	18	16	1	15838	5/8	18	16	1
15814	9/32	4	2	1	15839	5/8	24	22	1
15815	9/32	6	4	1	15840	11/16	8	6	1
15816	5/16	4	2	1	15841	3/4	6	4	1
15817	5/16	6-1/2	4	1	15842	3/4	8	6	1
15818	5/16	8	6	1	15843	3/4	12	10	1
15819	5/16	12	10	1	15844	3/4	18	16	1
15820	3/8	6	4	1	15845	27/32	6	4	1
15821	3/8	8	6	1	15846	7/8	12	10	1
15822	3/8	12	10	1	15847	7/8	18	16	1
15823	3/8	18	16	1	15848	1	12	10	1
15824	3/8	24	22	1	15849	1	18	16	1

GRAY shaded lines indicate NON-STOCK items. Allow 2-3 weeks extra order processing time.

SDS Plus Masonry Drill Bits 5 Pc Set (P15)

IBS No. 15851

Set Includes:

- Sizes range from 5/32" to 1/2".
- Packaged in a clear plastic index.



IBS No.	Size	Length	IBS No.	Size	Length
15801	5/32	6	15820	3/8	6
15803	3/16	6	15827	1/2	6
15810	1/4	6			

D R I L L B I T S E T C



IBS, INCORPORATED

Miscellaneous Drill Bits (P20)

IBS Type 187 Spotweld Drill Bits

- A rugged, high performance drill bit designed to effectively cut auto body panel spot welds.
- Cobalt steel permits speeds up to 30% greater than H.S.S. drills.
- Cobalt Steel is substantially more abrasion resistant, resulting in very long wearing cutting edges.



IBS No.	Diameter MM	Approx Spotweld Size, Inches	Overall Length Inches	Qty
19341	8.00	5/16	2.25	1
19342	10.00	3/8	2.25	1
19343	8.0 TE*	5/16	3.62	1
19344	10.0 TE*	3/8	3.62	1

* TE Twin End Drill Bits

These twin end drill bits will cut twice as many spot welds with the added advantage of longer reach to drill the less accessible spotwelds.



SPOTWELD DRILL BIT SET (P15)

IBS No.	Description
19340	4 Pc. Spotweld Drill Bit Set (P15) 8.0, 10.00, 8.0TE, 10.0TE Complete with metal index

Glass & Tile Drill Bits



- Industrial grade carbide to prevent cracking and ensure a long life.
- Pointed tip for accuracy of hole placement and easy centering.

Applications:

- For drilling glass, tiles, ceramics and mirrors.
- Reduced rotational speed (RPM) and use of water improves the drilling results.

Key Safety or Application Warning:

Glass and Tile Bits are only for rotary application. If you are using a Hammer Drill, you must TURN OFF THE HAMMER MODE.

IBS No.	Diameter MM	Overall Length Inches	Qty
15981	1/8	3-1/2	1
15982	5/32	3-1/2	1
15983	3/16	3-1/2	1
15984	1/4	3-1/2	1
15985	5/16	3-3/4	1
15986	3/8	4	1
15987	1/2	4	1



Ultra Point Acrylic Drill Bits



Acrylic drills are designed with ultra points for superior performance when drilling through plastics, acrylics, or laminate surfaces.

- **Special Hi-Molybdenum tool steel, gold surface treated** body, flute and point for maximum lubricity.
- **The ultra point is precision ground at a 60° angle** for gradual penetration to avoid cracking and chipping of the acrylic material.
- **Special 0° rake angle on cutting edge** eliminates grabbing when drill breaks through plastic, acrylic or laminate surfaces.
- All sizes over 1/4" have 1/4" shanks.

IBS No.	Diameter	IBS No.	Diameter	IBS No.	Diameter	IBS No.	Diameter
17280	3/32	17284	7/32	17288	11/32	17292	15/32
17281	1/8	17285	1/4	17289	3/8	17293	1/2
17282	5/32	17286	9/32	17290	13/32		
17283	3/16	17287	5/16	17291	7/16		



Sold in quantities of (1)

ULTRA POINT ACRYLIC DRILL BIT SET (P15)

IBS No.	Description
17295	7 Pc Ultra Point Drill Bit Set (P15) 1/8 thru 1/2 by 16ths

6-Flute Chatterless Countersinks



6-Flute Chatterless Countersinks are easy to use and provide the best finish. They quickly form an 82° countersink in a variety of materials allowing flat head fasteners to mount flush for a professional finish.

- **Special Hi-Molybdenum tool steel construction, gold surface treated** for maximum lubricity.
- **Unique 6-flute chatterless design has staggered cutting angles** to eliminate the harmonics that cause chatter in conventional tools – provides a more comfortable operation for users and a smoother finish in a wide variety of materials – saving user fatigue and time in finishing.
- **6-Flute design distributes the cutting load over six cutting edges** allowing edges to stay sharper longer to provide longer service life saving time and money.
- **Ideal for use on** hand tools, drill presses, milling machines and lathes.
- **Made in the USA**



IBS No.	Size	For Screw Size	Shank	IBS No.	Size	For Screw Size	Shank
19380	1/4	#4	1/4" Shank	19385	3/4	3/8	1/2" Shank
19381	5/16	#6		19386	7/8	7/16	
19382	3/8	#8, #10		19387	1	1/2	
19383	1/2	1/4"	3/8" Shank	19388	1-1/4	5/8	3/4" Shank
19384	5/8	5/16		19389	1-1/2	3/4	
19390	1/4 - 1/2 4PC Set 6-Flute Countersinks						



IBS, INCORPORATED

Miscellaneous Drill Bits (P20)

Fluteless Countersinks Deburring Tools

Our IBS high speed steel fluteless countersinks (deburring tools) offer superior quality, unique design and outstanding performance, yielding excellent workpiece finish. Designed for use in a wide variety of materials, including metal, plastic and wood. These tools can be easily sharpened by use of a small mounted grinding wheel inserted in the hole.



- Chatterless finish
- Single cutting edge for fast stock removal
- Free-cutting
- Easily sharpened
- Ideal for portable use

Fluteless Countersinks - 82° Pilotless, Round Shank

IBS No.	Screw Size	Shank Diameter	Overall Length	Body Diameter	Qty
19300	#4 & #5	1/4	1-1/2	1-7/16	1
19301	#6	1/4	1-1/2	19/64	1
19302	#8	1/4	1-5/8	11/32	1
19303	#10	1/4	1-5/8	25/64	1
19304	#12 & #14	1/4	1-7/8	9/16	1



Fluteless Countersinks - 82° Pilotless, Hex Shank for Portable Drills

IBS No.	Screw Size	Shank Diameter	Overall Length	Body Diameter	Qty
19305	#2, #3, #4	Hex	1-27/32	1/4	1
19306	#5, #6, #8	Hex	2	11/32	1
19307	#10, #12, #14	Hex	2-5/16	9/16	1



Fluteless Countersink Sets



Round Shank Fluteless 5 Pc Countersink Set 82° Pilotless, Round Shank

IBS No.	Set Contains
19310	19300, 19301, 19302, 19303, 19304



Hex Shank Fluteless 3 Pc Countersink Set 82° Pilotless, Hex Shank for Portable Drills

IBS No.	Set Contains
19315	19305, 19308, 19307



D
R
I
L
L
B
I
T
S
E
T
C

IBS, INCORPORATED

Miscellaneous Drill Bits (P20)



Platinum Spiral Flute Step Drills

Drill Twice as Fast as a Straight Flute Step Drill

IBS Platinum Spiral Flute Step Drills cut twice as fast as straight flute step drills, quickly in various sheet materials up to 1/8" thick. Each step drill bit drills a range of sizes. The further the bit advances, the larger the diameter of the hole. Because step drill bits enter the material one step at a time, the operator can drill the desired hole by counting the individual steps, or by using a washer as a simple stop.

The **self-starting tip** eliminates the need for pilot holes.

Applications include: junction boxes, switch boxes, metal studs, electrical applications, lighting fixtures, autobody work, and many other uses.

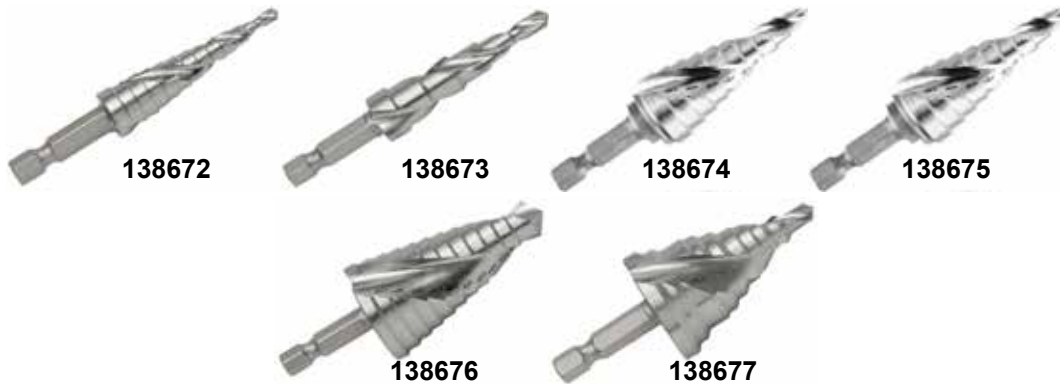

NITRO-CARB STEP DRILLS

IBS No	Description	
138672	1/8-1/2 X 1/32 Platinum Spiral Flute Step Drill	1/4 HEX SHANK 13 HOLES
138673	3/16-1/2 X 1/16 Platinum Spiral Flute Step Drill	1/4 HEX SHANK 6 HOLES
138674	3/16-3/4 X 1/16 Platinum Spiral Flute Step Drill	1/4 HEX SHANK 10 HOLES
138675	3/16-7/8 X 1/16 Platinum Spiral Flute Step Drill	1/4 HEX SHANK 12 HOLES
138676	7/16 -1-1/8 X 1/16 Platinum Spiral Flute Step Drill	1/4 HEX SHANK 12 HOLES
138677	7/8-1-1/8 X 1/4 Platinum Spiral Flute Step Drill	1/2 HEX SHANK 2 HOLES

Platinum Spiral Flute Step Drill Travel Trays

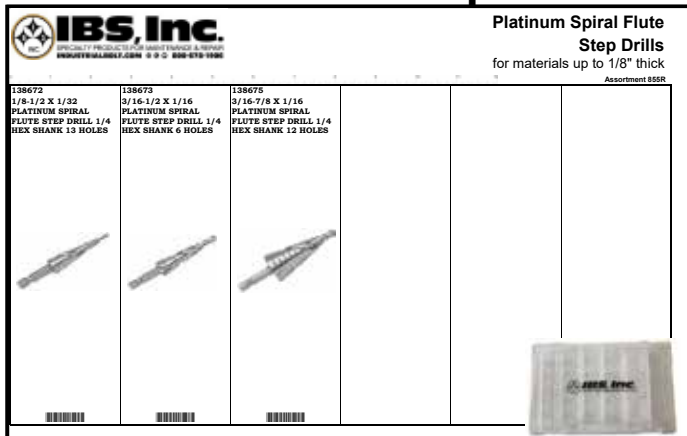

3Pc Spiral Flute Step Drills Starter Set Travel Tray

IBS No. 855R • 3 Items • 3 Pcs

Packaged in a Locking Plastic Travel Tray for Easy Storage & Organization

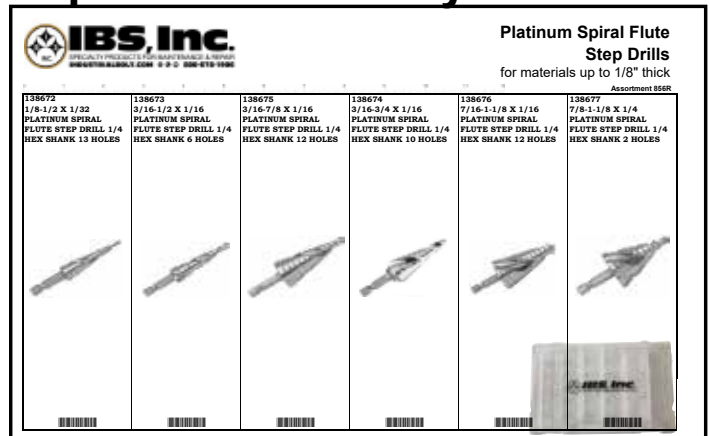

6Pc Spiral Flute Step Drills Travel Tray

IBS No. 856R • 6 Items • 6 Pcs

Packaged in a Locking Plastic Travel Tray for Easy Storage & Organization

D R I L L B I T S E T C



IBS, INCORPORATED

Miscellaneous Drill Bits (P20)

Nitro-Carb Step Drills

Nitro-Carb Step Drills are in a class unto themselves. Nitro-Carb Step Drills include as many as 13 different hole sizes in a single bit, eliminating the need for an entire tool box full of specific sized drill bits. And its built-in differences result in a tool that cuts faster and cleaner and gives a true, round hole every time.

- **Double Flute Design** — Means faster cutting action producing a hole quickly and efficiently saving time and money.
- **Multiple Stepped for Your Multiple Drilling Needs** —includes as many as 13 different hole sizes in a single bit, eliminating the need for specific sized drill bits.
- **Proper hole size** is achieved by counting the steps as they penetrate the work and stopping the pressure when the desired hole size is reached.
- **Deburring is Automatic** once the proper hole diameter is attained, the hole is automatically deburred by the cutting edge of the next larger step.
- **Hardened steel for long life** - each Nitro-Carb Step Drill is constructed of industrial grade high speed molybdenum steel, heat-treated to a Rockwell of between 61 and 63 on the "C" scale and tempered to assure maximum strength for long life.
- **Self-Centering Split Point Tip** - the split point virtually eliminates skidding and the need for center punching; the tip gives sure starts even on curved surfaces such as pipe and conduit.



NITRO-CARB STEP DRILLS

Unibit Size #	IBS Size #	IBS No.	No. of Holes	Hole	Increments	Shank	
#1	#1	128672	13	1/8 - 1/2	1/32	1/4 Hex	
#4	#2	128673	6	3/16 - 1/2	1/4	1/4 Hex	
#3	#3	128674	9	1/4 - 3/4	1/16	1/4 Hex	
#8	#4	128675	12	3/16 - 7/8	1/16	1/4 Hex	
#12	#5	128676	10	1/4 - 1-3/8	1/8	3/8 w/Flats	
#2	#29	128677	13	1/4 - 1	1/16	3/8 w/Flats	
—	—	128686	3 Pc Set: #1, #2, #4				
—	—	749R	6 Pc Set: #1, #2, #3, #4, #5, #29				



IBS No. 128686

3 Piece Set Contains:

- (128672) 1/8-1/2
- (128673) 3/16-1/2
- (128675) 3/16-7/8



Nitro-Carb Step Drill Travel Tray

IBS No. 749R • 6 Items • 6 Pcs

Contains all 6 sizes packaged in an adjustable compartment small plastic travel tray for easy storage and organization.

RECOMMENDED DRILL SPEEDS

Hole Size	RPM
Up to 1/4	1500 — 1750
1/4 — 1/2	1000 — 1250
1/2 — 3/4	500 — 1000
3/4 — 1	300 — 500

IBS, INCORPORATED

Step Reamers (P17)



Step Reamers

**THE FASTEST AND EASIEST WAY TO ENLARGE HOLES IN MATERIALS UP TO 1/2" THICK!
INCREDIBLY FAST AND ACCURATE!**



- **GOLD OXIDE COATING** enhances lubricity, reduces friction, and increases toughness.
- **SIZES ARE ETCHED INSIDE THE FLUTES** which will last longer and allow users to read the sizes even after use.
- **MADE OF M2 HSS TOOL STEEL** for optimum performance in tough metals — means it stays sharper longer, saving time and money.
- **1/2" SHANK WITH 3 FLATS ON THE SHANK** allows easy positive chuck grip, eliminating spinning or slipping in the chuck for safety, and speed — great for keyless chucks!
- **EACH REAMER HAS 5 STEPS IN 1/16" INCREMENTS** — 3 Step Reamers can replace 15 reamers, which saves money in inventory.
- **CHAMFER ON EACH STEP** — deburs the cut for a perfectly finished hole every time, eliminating sharp edges for a safer finish, saving time and money.
- **Full 1/2" cutting depth** for use in thicker material than standard step drills for more versatility in more applications.



STEP REAMERS

IBS No.	Description	Qty.
18531	5/16 to 9/16 Step Reamer	1
18532	9/16 to 13/16 Step Reamer	1
18533	13/16 to 1-1/16 Step Reamer	1
18534	3 Pc Step Reamer Set	1



3 Pc STEP REAMER SET
(5/16 to 1-1/16)
IBS No. 18534

D
R
I
L
L
B
I
T
S
E
T
C



IBS, INCORPORATED

Nitro-Carb Spiral Reamers (P17)

Platinum Series Spiral Reamers

STRAIGHT SHANK, LEFT HAND HELIX, RIGHT HAND CUT, COLLAR STOP HSS

"PLATINUM SERIES — THE PROOF IS IN THE PERFORMANCE"



D
R
I
L
L
B
I
T
S
E
T
C

- **M7 TOOL STEEL & NOMO COATING** equip this reamer to cut stainless steel and tough alloys. An exclusive combination of high speed steel, superior geometry, and our unique NOMO treatment (Nitride on Margin Only) make short work of enlarging holes in framework and structural steel.
- **FITS INTO SMALL HOLES** smaller diameter allows the user to enlarge much smaller holes to desired diameter, reducing the need for progressively larger tools. Ideal for harder to cut metals such as stainless steel.
- **TAPER ANGLE DESIGN** distributes cutting forces along the edges. Multiple tapered cutting edges evenly distribute the cutting load for effortless reaming, resulting in less damage and replacement costs.
- **SAFE TO USE** — Flutes of the reamer turn in a forward (down and away) direction, so chips are safely ejected away from the operator.
- **HSS SAFETY COLLAR** prevents over penetration for safety and accuracy.

Applications:

Industrial applications include steel erection, automotive, truck and trailer manufacturing.

Ideal for:

- Enlarging misaligned holes
- Fuel tank mounting
- Truck frame drilling
- Tool box & accessory mounting
- Spring hangers
- Trailer hitch, 5th wheel & tow hook mounting

IBS, INCORPORATED

Nitro Carb Spiral Reamers (P17)



Platinum Series Spiral Reamers

STRAIGHT SHANK, LEFT HAND HELIX, RIGHT HAND CUT, COLLAR STOP HSS

"PLATINUM SERIES — THE PROOF IS IN THE PERFORMANCE"

Engineered exclusively to enlarge and align existing holes; especially in tight spots. The ideal maintenance reamer.

- Three flats on the shank — allows for strong positive chuck grip and eliminates slippage in the chuck.
- Gold surface treated for additional lubricity for cooler operation and longer life.
- Effortlessly fits into small holes
- Quickly aligns structural steel
- Deburs welded & punched holes
- Cuts stainless steel and tough alloys
- Fits most power tools
- Ideal for maintenance and repair

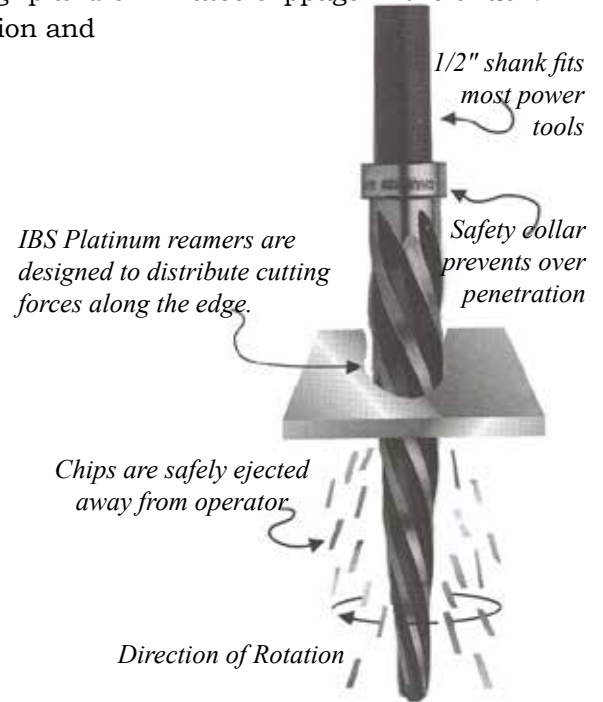

IBS No.	Dia.	Shank Dia	Decimal Equivalent	No. of Flutes	Point Dia.	Flute Length	Overall Length	Pilot Drill	Drill No.
18501	1/4	1/4	.2500	4	.195	2-5/16	4	3/16	16808
18502	5/16	5/16	.3125	4	.215	3	4-5/8	17/64	16813
18503	3/8	3/8	.3750	4	.250	3	4-5/8	5/16	16816
18504	7/16	7/16	.4375	4	.250	3-1/4	5-7/8	3/8	16820
18505	1/2	1/2	.5000	5	.281	3-15/16	5-7/8	3/8	16820
18506	9/16	1/2	.5625	5	.343	3-15/16	5-7/8	7/16	16824
18507	5/8	1/2	.6250	5	.343	4-1/2	6-3/8	7/16	16824
18510	3/4	1/2	.7500	5	.406	4-15/16	6-3/8	1/2	16828
18513	7/8	1/2	.8750	5	.500	5-3/16	6-3/8	19/32	16838
18515	1	1/2	1.0000	5	.719	5-3/16	6-3/8	7/8	16856

SETS

18517 4 Pc Platinum Spiral Reamer Set (5/16, 3/8, 7/16, & 1/2) P15

18518 4 Pc Platinum Spiral Reamer Set (3/8, 1/2, 5/8, & 3/4) P15



4 Pc Platinum Spiral Reamer Set
(5/16, 3/8, 7/16, & 1/2)
IBS No. 18517



4 Pc Platinum Spiral Reamer Set
(3/8, 1/2, 5/8 & 3/4)
IBS No. 18518

D R I L L B I T S E T C



IBS, INCORPORATED

Nitro Carb Spiral Reamers (P17)

Nitro-Carb Hole Hog Reamers Hole Enlargers Hole Hog™ Super Premium Core Drills



Made of special Hi-Molybdenum tool steel, these reamers feature a gold surface treated body and clearance for maximum lubricity, close tolerance construction, three flats on the shank and four flutes. They are designed exclusively to enlarge existing holes.

This high performance tool is designed to enlarge existing holes by as much as 160% of the existing hole's diameter. The four flute design and modified "Hole Hog" point prevent the catching and hogging-in commonly experienced when standard S&D drills break through thinner material such as truck frames. The flattened 1/2" shank makes this tool extremely useful in portable drilling.

HOLE HOG REAMERS 4-5/16" Overall Length, 1-7/8 Flute Length

IBS No.	Diameter (in.)	Pilot Drill	Qty
18524	3/8	1/4	1
18526	1/2	5/16	1
18528	5/8	25/64	1
18530	3/4	15/32	1

Hole Hog Reamer / Pilot Drill Sets (P15)

These sets contain the reamers described above and mechanics length Nitro-Carb drill bit in a metal index. The reamers have flats along the shank for ease of use with portable drilling.



HOLE HOG REAMER SETS w/Drill Bits Made from Special High Molybdenum Tool Steel

IBS No.	# of Pcs	Reamer Sizes included	Drill Sizes included
18521	8 Pc	3/8, 1/2, 5/8, 3/4	1/4, 5/16, 25/64, 15/32
18522	6 Pc	3/8, 1/2, 5/8	1/4, 5/16, 25/64
18523	6 Pc	1/2, 5/8, 3/4	5/16, 25/64, 15/32

D
R
I
L
L
B
I
T
S
E
T
C

IBS, INCORPORATED

High Speed Taps (P08)



IBS Nitro Carb "DRAPS"



- Made of **Hi-Molybdenum tool steel** for longer tool life.
- **3 Flats on the Shank** reduces slippage and provides for faster tool changes and alignment in keyless chuck.
- **Ground threads** and a **plug lead tap** design allows for smooth entry, easy tapping and excellent thread finish.
- **Black & Gold surface treatment** reduces friction, holds lubricant and provides improved chip removal resulting in cooler cutting and extended life.
- **135° Split Point** allows easier starts and higher speed drilling, eliminating the need for a center punch or pilot hole.
- **Longer drill point** allows for use in thicker materials.

DRAPS - NC

IBS No.	Thread Size	Max Material Thickness	Thread Length
17150	4-40	0.368	0.564
17151	6-32	0.468	0.376
17152	8-32	0.539	0.376
17153	10-24	0.606	0.496
17154	12-24	0.677	0.496
17155	1/4-20	0.746	0.626
17156	5/16-18	0.889	0.683
17157	3/8-16	1.031	0.746
17158	7/16-14	1.172	0.882
17159	1/2-13	1.378	0.940

DRAPS - NF

IBS No.	Thread Size	Max Material Thickness	Thread Length
17173	8-36	0.540	0.376
17160	10-32	0.608	0.496
17161	1/4-28	0.750	0.626
17162	5/16-24	0.893	0.683
17163	3/8-24	1.036	0.746
17164	7/16-20	1.178	0.880
17165	1/2-20	1.384	0.940

DRAPS - METRIC

IBS No.	Thread Size	Max Material Thickness	Thread Length
17166	M3-.5	0.403	0.624
17167	M4-.7	0.538	0.376
17168	M5-.8	0.610	0.496
17169	M6-1.0	0.746	0.626
17170	M8-1.25	0.892	0.686
17171	M10-1.5	1.037	0.746
17172	M12-1.75	1.373	0.942

6 Pc Coarse Machine Screw Nitro Carb Tap Set IBS No. 17175

Contains sizes: 6-32, 8-32, 10-24, 10-32, 12-24, 1/4-20 packaged in a locking plastic case for easy storage and organization



7 Pc Fine Thread Nitro Carb Tap Set IBS No. 17176

Contains sizes: 8-36, 10-32, 1/4-28, 5/16-24, 3/8-24, 7/16-20, 1/2-20 packaged in a folding cloth pouch for easy storage and organization.



7 Pc Coarse Thread Nitro Carb Tap Set IBS No. 17177

Contains sizes: 8-32, 10-24, 1/4-20, 5/16-18, 3/8-16, 7/16-14, 1/2-13 packaged in a folding cloth pouch for easy storage and organization.



6 Pc Machine Screw Nitro Carb Tap Travel Tray IBS No. 17178

Contains sizes: 8-32, 10-24, 12-24, 1/4-20, 5/16-18, 3/8-16 packaged in a locking plastic travel tray for easy storage and organization.



6 Pc Metric Nitro Carb Tap Travel Tray IBS No. 17179

Contains sizes: M4, M5, M6, M8, M10, M12 packaged in a locking plastic travel tray for easy storage and organization.



D R I L L B I T S E T C

Sold in quantities of (1)



IBS, INCORPORATED

Technical Information

Speeds and Feeds for Drill Bits

The speed of a drill bit is usually measured in terms of the rate at which the outside or periphery of the tool moves in relation to the work being drilled. The common term for this is Surface Feet per Minute (SFM). The relation of SFM and Revolutions per Minute (RPM) is indicated by the following formula:

$$\text{RPM} = 3.8 \quad \times \quad \left[\frac{\text{SFM}}{\text{Drill Diameter in inches}} \right]$$

The most economical speed for operating a drill bit will depend on variables, some of which are:

1. Composition and hardness of material being drilled.
2. Depth of the hole being drilled.
3. Use of cutting fluids.
4. Type and condition of drilling equipment.
5. Quality of holes desired.

Speeds shown in the accompanying table of cutting speeds include a range in feet per minute. In most drilling situations it is usually better to start with a slower speed and build up to the maximum after a trial hole may indicate the drill bit can be run faster.

The following information provides widely recommended drill bit speeds in feet per minute for a wide range of materials. These speeds give the user a good starting point but may be adjusted to slower or faster depending on the variables listed previously and the resulting performance. The optimum speed must be established through trial.

Standard drill bit feed information is provided below to help establish the proper feed rate of different diameters. This is particularly useful when a drill press, etc. is being used.

Drill Bit Feeds

DIAMETER OF DRILL BIT (INCHES)	NORMAL FEED	HEAVY FEED
from 1/16 to 1/8	.001 -.002	.002 -.004
over 1/8 to 1/4	.002 -.004	.004 -.008
over 1/4 to 1/2	.004 -.008	.008 -.016
over 1/2 to 1	.008 -.016	.016 -.024
over 1	.016 -.024	.024 -.032

The following charts convert surface feet per minute to revolutions per minute for fractional, letter and number drills. To use these charts, locate the drill bit diameter to be used on the left side of the chart and the desired surface feet per minute at the top (reference the following chart for the material to be drilled). The point where the two columns meet will give you a good guide regarding the revolutions per minute to be used as a starting point.

D
R
I
L
L
B
I
T
S
E
T
C



Surface Cutting Speeds For Various Materials

Reference the chart below to determine the proper surface speed for use in the following charts.

Material	Speed: Ft/Min	Material	Speed: Ft/Min
Aluminum & its alloys	40 to 50	Bakelite	90 to 100
Common brass and bronze	200 to 300	Allegheny metal	40 to 50
High Tensile Bronze	70 to 150	Manganese copper	20 to 30
Magnesium and its alloys	250 to 400	Chromalloy	40 to 50
Plastics	100 to 150	Magnet steel (soft)	40 to 50
Plastics containing glass fibers	70 to 90	Tool steel (RB80)	40 to 60
Formica	70 to 100	Tool steel (RB 32-34)	40 to 50
Hardwoods	300 to 400	Nitralloy 135	50 to 60
Die Castings (zinc base)	300 to 400	Waspalloy	12 to 15
Copper	70 to 100	Crucible HY-Tuf (AMS 6418)	15 to 25
Automotive steel forgings	40 to 50	Crucible UHS 260	7 to 15
Nickel steel (3/2%)	20 to 50	Timken HS 220	15 to 25
Spring Steel	30 to 40	Inco Tricent	10 to 20
Mild steel (2. - .3 carbon)	80 to 110	Vascojet X4 and 1000	7 to 15
Medium Steel (.4 - .5 carbon)	70 to 80	Thermold J	7 to 15
Alloy Steel-Manganese (7-13%)	30 to 40	Trinidur	12 to 15
Molybdenum steel	60 to 70	Discalloy AMS 5733	12 to 15
Monel	50 to 60	Vitallium	10 to 12
Titanium (RC 32 - RC 34)	20 to 50	Udimet 500	12 to 15
Tool steel (anneled 1.2 carbon)	20 to 50	Iconel 700	7 to 15
Permalloy (77% nickel)	50 to 60	Rene 41	7 to 15
Soft cast iron	100 to 150	Armco (17-4 PH and 17-7 PH)	15 to 20
Medium hard cast iron	70 to 100	Iconet AMS 5685	10 to 12
Hard Cast Iron	30 to 70	SAE 4340, 4360 & AMS 6415	7 to 15
Malleable iron	80 to 90	USS STRUX - MOD 98BV40	7 to 15
Stainless steel 200 series	50 to 70	SAE 4330 - Mod. AMS 6407	15 to 25
18-8 stainless steel & 300 series	20 to 60	H-11 AMS 6485	7 to 15
Stainless steel 400 series	20 to 60	A 286 AMS 5736	15 to 20
Zamak	200 to 300	S-816AMS 5765	12 to 15
Hard rubber	90 to 100		

D R I L L B I T S E T C



IBS, INCORPORATED

Technical Information

Fractional Drill Cutting Speeds in RPM

D
R
I
L
L
B
I
T
S
E
T
C

Drill	Feet Per Minute														
	10	12	15	20	25	30	35	40	45	50	60	70	80	90	100
1/64	2445	2934	3667	4889	6112	7334	8556	9778	11001	12223	14668	17112	19557	22001	24446
1/32	1222	1467	3667	2445	3056	3667	4278	4889	5500	6112	7334	8556	9778	11001	12223
3/64	815	978	1833	1630	2037	2445	2852	3259	3667	4074	4889	5704	6519	7334	8149
1/16	611	733	1222	1222	1528	1833	2139	2445	2750	3056	3667	4278	4889	5500	6112
5/64	489	587	917	978	1222	1467	1711	1956	2200	2445	2934	3422	3911	4400	4889
3/32	407	489	733	815	1019	1222	1426	1630	1833	2037	2445	2852	3259	3667	4074
7/64	349	419	611	698	873	1048	1222	1397	1572	1746	2095	2445	2794	3143	3492
1/8	306	367	524	611	764	917	1070	1222	1375	1528	1833	2139	2445	2750	3056
9/64	272	326	458	543	679	815	951	1086	1222	1358	1630	1901	2173	2445	2716
5/32	244	293	407	489	611	733	856	978	1100	1222	1467	1711	1956	2200	2445
11/64	222	267	367	444	556	667	778	889	1000	1111	1333	1556	1778	2000	2222
3/16	204	244	333	407	509	611	713	815	917	1019	1222	1426	1630	1833	2037
13/64	188	226	306	376	470	564	658	752	846	940	1128	1316	1504	1692	1880
7/32	175	210	282	349	437	524	611	698	786	873	1048	1222	1397	1572	1746
15/64	163	196	262	326	407	489	570	652	733	815	978	1141	1304	1467	1630
1/4	153	183	244	306	382	458	535	611	688	764	217	1070	1222	1275	1528
9/32	136	163	229	272	340	407	475	543	611	679	815	951	1086	1222	1358
5/16	122	147	204	244	306	367	428	489	550	611	733	856	978	1100	1222
11/32	111	133	183	222	278	333	389	444	500	556	667	778	889	1000	1111
7/16	87	105	167	175	218	262	306	349	393	437	524	611	698	786	873
15/32	81	98	131	163	204	244	285	326	367	407	489	570	652	733	815
1/2	76	92	122	153	191	229	267	306	344	382	458	535	611	688	764
9/16	68	81	115	136	170	204	238	272	306	340	407	475	543	611	679
5/8	61	73	102	122	153	183	214	244	275	306	367	428	489	550	611
11/16	56	67	92	111	139	167	194	222	250	278	333	389	444	500	556
3/4	51	61	83	102	127	153	178	204	229	255	306	357	407	458	509
13/16	47	56	76	94	118	141	165	188	212	235	282	329	376	423	470
7/8	44	52	71	87	109	131	153	175	1965	218	262	306	349	393	437
15/16	41	49	65	81	102	122	143	163	183	204	244	285	326	367	407
1	38	46	57	76	95	115	134	153	172	191	229	267	306	344	382



Letter Drill Cutting Speeds in RPM

Drill	Feet Per Minute														
	10	12	15	20	25	30	35	40	45	50	60	70	80	90	100
A	163	196	245	326	408	490	571	653	735	818	982	1145	1309	1472	1636
B	160	193	241	321	401	481	562	642	722	803	963	1124	1284	1445	1605
C	158	189	237	316	395	473	552	631	710	789	947	1105	1292	1420	1578
D	155	186	233	311	388	466	543	621	699	778	937	1089	1245	1400	1556
E	153	183	229	306	386	458	535	611	687	764	917	1070	1222	1375	1528
F	149	178	223	297	372	446	520	595	669	778	934	1089	1245	1400	1556
G	146	176	220	293	366	439	512	585	659	732	878	1024	1170	1317	1463
H	144	172	215	287	359	431	503	574	646	718	862	1005	1149	1292	1436
I	140	169	211	281	351	421	492	562	632	702	842	983	1123	1264	1404
J	138	165	207	276	345	414	483	552	621	690	827	965	1103	1241	1379
K	136	163	204	272	340	408	476	544	612	680	815	951	1087	1223	1359
L	132	158	198	263	329	395	461	527	593	659	790	922	1054	1185	1317
M	129	155	194	259	324	388	453	518	583	648	777	907	1036	1166	1295
N	126	152	190	253	316	379	442	506	569	633	759	886	1012	1139	1265
O	121	145	181	242	302	363	423	484	544	605	725	846	967	1088	1209
P	118	142	177	237	296	355	414	473	532	592	710	828	946	1065	1183
Q	115	138	173	230	288	345	403	460	518	575	690	805	920	1035	1150
R	113	135	169	225	282	338	394	451	507	564	676	789	902	1014	1127
S	110	132	135	220	274	329	384	439	494	549	659	769	878	988	1098
T	107	128	160	213	267	320	373	427	480	533	640	746	853	959	1066
U	104	125	156	208	259	311	363	415	467	519	623	727	830	934	1038
V	101	122	152	203	253	304	355	405	456	507	608	709	810	912	1013
W	99	119	148	198	247	297	346	396	445	495	594	693	792	891	989
X	96	115	144	192	240	289	337	385	433	481	576	672	769	865	962
Y	95	113	142	189	236	284	331	378	425	473	567	662	756	851	945
Z	92	111	139	185	231	277	324	370	416	462	555	647	740	832	925

D R I L L B I T S E T C

NOTE: For speeds higher than tabulated, multiply all values by ten and for speeds lower divide by ten.



IBS, INCORPORATED

Technical Information

Number Drill Cutting Speeds in RPM

D
R
I
L
L
B
I
T
S
E
T
C

Drill	Feet Per Minute														
	10	12	15	20	25	30	35	40	45	50	60	70	80	90	100
1	168	201	251	335	419	503	586	670	754	838	1005	1173	1340	1508	1675
2	173	207	259	346	432	519	605	691	778	864	1037	1210	1382	1555	1728
3	179	215	269	359	448	538	628	717	807	897	1076	1255	1434	1614	1793
4	183	219	274	366	457	548	640	731	822	914	1097	1280	1462	1645	1828
5	186	223	279	372	465	558	651	743	836	930	1115	1301	1487	1673	1859
6	187	225	281	374	468	562	655	749	843	936	1123	1310	1498	1685	1872
7	190	228	285	380	475	570	665	760	855	950	1140	1330	1520	1710	1900
8	192	230	288	384	480	576	672	768	864	960	1151	1343	1535	1727	1919
9	195	234	292	390	487	585	682	780	877	975	1169	1364	1559	1754	1949
10	197	237	296	385	494	592	691	790	888	987	1184	1382	1579	1777	1974
11	200	240	300	400	500	600	700	800	900	1000	1200	1400	1600	1800	2000
12	202	243	303	404	505	606	707	808	909	1010	1213	1415	1617	1819	2021
13	206	248	310	413	516	619	723	826	929	1032	1239	1450	1652	1859	2065
14	210	252	315	420	525	630	735	839	944	1050	1259	1469	1679	1889	2099
15	212	255	318	424	531	637	743	849	955	1064	1276	1489	1802	1914	2127
16	216	259	324	432	540	647	755	863	971	1079	1295	1511	1726	1942	2158
17	221	265	331	442	552	662	773	883	994	1104	1325	1546	1766	1987	2208
18	225	270	338	451	563	676	789	901	1014	1130	1356	1582	1808	2034	2260
19	230	276	345	460	575	690	805	920	1035	1151	1381	1611	1841	2071	2301
20	237	285	356	474	593	712	830	949	1068	1186	1423	1660	1898	2135	2372
21	240	288	360	480	601	721	841	961	1081	1201	1441	1681	1922	2162	2402
22	243	292	365	487	608	730	852	973	1095	1217	1460	1703	1946	2190	2433
23	248	298	372	496	620	744	868	992	1116	1240	1488	1736	1984	2232	2480
24	251	302	377	503	628	754	880	1005	1131	1257	1508	1759	2010	2262	2513
25	255	307	383	511	639	766	894	1022	1150	1276	1533	1789	2044	2300	2555
26	260	312	390	520	650	780	909	1039	1169	1299	1559	1819	2078	2338	2598
27	265	318	398	531	663	796	928	1061	1194	1327	1592	1857	2122	2388	2653
28	272	326	408	544	680	816	952	1087	1223	1360	1631	1903	2175	2447	2719
29	281	337	421	562	702	843	983	1123	1264	1405	1685	1966	2247	2528	2809
30	297	357	446	585	743	892	1040	1189	1338	1487	1784	2081	2378	2676	2973
31	318	382	477	637	796	955	1114	1273	1432	1592	1910	2228	2546	2865	3183
32	329	395	494	659	823	988	1153	1317	1482	1647	1976	2305	2634	2964	3293
33	338	406	507	676	845	1014	1183	1352	1521	1690	2028	2366	2704	3042	3380
34	344	413	516	688	860	1032	1204	1376	1549	1721	2065	2409	2753	3097	3442
35	347	417	521	694	886	1042	1215	1389	1563	1736	2088	2430	2778	3125	3472
36	359	430	538	717	898	1076	1255	1435	1614	1794	2152	2511	2870	3228	3587
37	367	441	551	735	918	1102	1285	1469	1653	1837	2204	2571	2938	3006	3673
38	376	452	564	753	941	1129	1317	1505	1693	1882	2258	2634	3010	3387	3763
39	384	461	576	768	960	1152	1344	1536	1728	1920	2303	2687	3071	3455	3839
40	390	468	585	780	974	1169	1364	1559	1754	1949	2339	2729	3118	3508	3898



Metric Drill Cutting Speeds in RPM

Drill	Feet Per Minute					
	20	30	50	70	80	100
0.5	3878	5817	9695	13573	15512	19389
1.0	1939	2908	4847	6786	7756	9695
1.5	1293	1939	3232	4524	5171	6463
2.0	971	1456	2427	3397	3883	4854
2.5	776	1165	1941	2717	3105	3882
3.0	647	970	1617	2264	2587	3234
3.5	554	832	1386	1940	2218	2772
4.0	485	728	1213	1698	1940	2425
4.5	431	647	1078	1509	1724	2156
5.0	388	582	970	1359	1552	1940
6.0	323	485	809	1132	1294	1617
7.0	277	415	693	970	1109	1386
8.0	243	364	605	849	970	1213
9.0	216	323	539	755	832	1075
10.0	194	291	485	679	776	970
11.0	176	265	441	617	706	882
12.0	162	243	404	566	647	809
13.0	149	224	373	522	597	749
14.0	139	208	346	485	554	693
15.0	129	194	323	453	517	647
16.0	121	182	303	424	485	606
17.0	114	171	285	399	457	571
18.0	108	162	269	377	431	539
19.0	102	153	255	357	409	511
20.0	97	146	243	340	388	485
22.0	88	132	221	309	353	441
24.0	81	121	202	283	323	404
26.0	75	112	187	261	299	373
28.0	69	104	173	243	277	346
30.0	65	97	162	226	259	323

NOTE: For speeds higher than tabulated, multiply all values by ten and for speeds lower divide by ten.

SUGGESTIONS FOR MAXIMUM DRILL PERFORMANCE

1. **A reduced speed is recommended to start the drill.**
2. **The harder the material the slower the speed.**
3. **The larger the diameter the slower the speed.**
4. **Do not force feed. Let the drill cut at its own pace.**
5. **Once the bore is started, either keep the drill cutting or remove it. Idling of the cutting edge will harden the steel and dull the bit.**
6. **At the point of break-through, lighten the feed pressure.**
7. **Avoid side pressure on the drill bit whenever possible.**

D
R
I
L
L

B
I
T
S

E
T
C



IBS, INCORPORATED

Technical Information

Decimal Equivalent Chart For Drill Sizes

D
R
I
L
L
B
I
T
S
E
T
C

Drill Size	mm	Dec. In.	Drill Size	mm	Dec. In.	Drill Size	mm	Dec. In.	Drill Size	mm	Dec. In.
—	0.10	.0039	45	2.08	.0820	5	5.22	.2055	7/16	11.11	.4375
—	0.20	.0079	44	2.18	.0860	4	5.31	.2090	29/64	11.51	.4531
—	0.25	.0098	43	2.26	.0890	3	5.41	.2130	15/32	11.91	.4688
—	0.30	.0118	42	2.37	.0935	7/32	5.58	.2188	—	12.00	.4724
80	0.34	.0135	3/32	2.38	.0938	2	5.61	.2210	31/64	12.30	.4844
79	0.37	.0145	41	2.44	.0960	1	5.79	.2280	1/2	12.70	.5000
1/64	0.40	.0156	40	2.50	.0980	A	5.94	.2340	—	13.00	.5118
78	0.41	.0160	39	2.53	.0995	15/64	5.95	.2344	33/64	13.10	.5156
77	0.46	.0180	38	2.58	.1015	—	6.00	.2362	17/32	13.49	.5312
—	0.50	.0197	37	2.64	.1040	B	6.05	.2380	35/64	13.89	.5469
76	0.51	.0200	36	2.71	.1065	C	6.15	.2420	—	14.00	.5512
75	0.53	.0210	7/64	2.78	.1094	D	6.25	.2460	9/16	14.29	.5625
74	0.57	.0225	35	2.70	.1100	1/4	6.35	.2500	37/64	14.68	.5781
—	0.60	.0236	34	2.82	.1110	E	6.35	.2500	—	15.00	.5906
73	0.61	.0240	33	2.87	.1130	F	6.53	.2570	19/32	15.08	.5938
72	0.64	.0250	32	2.95	.1160	G	6.63	.2610	39/64	15.48	.6094
71	0.66	.0250	—	3.00	.1181	17/64	6.75	.2656	5/8	15.88	.6250
—	0.70	.0276	31	3.05	.1200	H	6.76	.2660	—	16.00	.6299
70	0.71	.0280	1/8	3.18	.1250	I	6.91	.2720	41/64	16.27	.6406
69	0.74	.0292	30	3.26	.1285	—	7.00	.2756	21/32	16.67	.6562
—	0.75	.0295	29	3.45	.1360	J	7.04	.2770	—	17.00	.6693
68	0.79	.0310	28	3.57	.1405	K	7.14	.2810	43/64	17.07	.6719
1/32	0.79	.0313	9/64	3.57	.1406	9/32	7.14	.2812	11/16	17.46	.6875
—	0.80	.0315	27	3.65	.1440	L	7.37	.2900	45/84	17.86	.7031
67	0.81	.0320	26	3.73	.1470	M	7.40	.2950	—	18.00	.7087
66	0.84	.0330	25	3.80	.1495	19/64	7.54	.2969	23/32	18.26	.7188
65	0.89	.0350	24	3.86	.1520	N	7.67	.3020	47/64	18.65	.7344
—	0.90	.0354	23	3.91	.1540	5/16	7.94	.3125	—	19.00	.7480
64	0.91	.0360	5/32	3.97	.1562	—	8.00	.3150	3/4	19.05	.7500
63	0.94	.0370	22	3.99	.1570	O	8.03	.3160	49/64	19.45	.7656
62	0.97	.0380	—	4.00	.1575	P	8.20	.3230	25/32	19.84	.7812
61	0.99	.0390	21	4.04	.1500	21/64	8.33	.3281	—	20.00	.7874
—	1.00	.0394	20	4.09	.1610	Q	8.43	.3320	51/64	20.24	.7969
60	1.02	.0400	19	4.22	.1660	R	8.61	.3390	13/16	20.64	.8125
59	1.04	.0410	18	4.31	.1695	11/32	8.73	.3438	—	21.00	.8268
58	1.07	.0420	11/64	4.37	.1719	S	8.84	.3480	53/64	21.02	.8281
57	1.09	.0430	17	4.39	.1730	—	9.00	.3543	27/32	21.43	.8438
56	1.18	.0465	16	4.50	.1770	T	9.09	.3580	55/64	21.84	.8594
3/64	1.19	.0469	15	4.57	.1800	23/64	9.13	.3594	—	22.00	.8861
55	1.32	.0520	14	4.62	.1820	U	9.35	.3680	7/8	22.23	.8750
54	1.40	.0550	13	4.70	.1850	3/8	9.53	.3750	57/64	22.62	.8906
53	1.51	.0595	3/16	4.76	.1875	V	9.55	.3770	—	23.00	.9055
1/16	1.59	.0625	12	4.80	.1890	W	9.80	.3860	29/32	23.02	.9062
52	1.61	.0635	11	4.85	.1910	25/64	9.92	.3906	59/64	23.42	.9219
51	1.70	.0670	10	4.91	.1935	—	10.00	.3937	15/16	23.81	.9375
50	1.78	.0700	9	4.98	.1960	X	10.08	.3970	—	24.00	.9449
49	1.85	.0730	—	5.00	.1968	Y	10.26	.4040	61/64	24.21	.9531
48	1.93	.0760	8	5.05	.1990	13/32	10.32	.4062	31/32	24.61	.9688
5/64	1.98	.0781	7	5.11	.2010	Z	10.40	.4130	—	25.00	.9842
47	1.99	.0785	13/64	5.16	.2031	27/64	10.72	.4219	63/64	25.00	.9844
—	2.00	.0787	6	5.18	.2040	—	11.00	.4331	1	25.40	1.000
46	2.06	.0810	—	—	—	—	—	—	—	25.50	1.039



NES External Rethreading Tools



An essential tool for anyone who deals with nuts and bolts in: maintenance, construction, garages, plumbing, agriculture and engineering.

- Adjusts automatically to thread diameter & pitch.
- No measuring of thread required.
- Can be used on left and right hand threads.
- Can be used on both inch and metric threads.
- Two hardened steel blades (58RC) guided by the existing thread, regroove the damaged area.

Turn handle (A) to raise floating blades (B).



Place the tool over the thread to be repaired.

Turn handle (A) to lower floating blades into grooves of thread and tighten by hand only.



Turn the NES External fastener repair tool in the direction of the arrow.



NES 1A EXTERNAL TOOL IBS No. 99152

NES 1A	OD	Pipe	L	W	H	R
in.	5/32 to 11/16	up to 7/16	2-3/8	29/32	2-7/16	2-11/16
mm.	4-18		61	23	62	68



NES 2 EXTERNAL TOOL IBS No. 99162

NES 2	OD	Pipe	L	W	H	R
in.	11/16 to 1-1/2	3/8 to 1-1/8	4-1/8	1-1/2	4-5/16	4-5/8
mm.	17-38		105	32	110	117

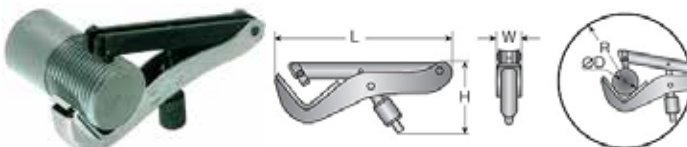

NES 3 EXTERNAL TOOL IBS No. 99163

NES 3	OD	Pipe	L	W	H	R
in.	1-1/4 to 5	1 to 4-1/2	12	1-3/4	5-1/8	9-7/8
mm.	32-128		305	44	130	250

NES Universal Thread Restorer 4 Pc Tool Kit



IBS No.	Description
122254	NES Universal Thread Restorer 4 Pc Tool Kit Contains all three NES Rethreading Tools. Replacement blades and internal thread cleaner tool included.

NES Internal Thread Cleaner / Restoring Tool



IBS No.	Description
122252	NES Internal Thread Cleaner Restoring Tool
122253	NES Internal Thread Cleaner Replacement Blades

NES Replacement Blades



IBS No.	Description
122249	NES1 Replacement Blades
122250	NES2 Replacement Blades
122251	NES3 Replacement Blades

D R I L L B I T S E T C



IBS, INCORPORATED

Tools (T03)

iNES Internal Rethreading Tap



An essential tool for anyone who deals with nuts and bolts in: maintenance, construction, garages, plumbing, agriculture and engineering.

- Adjusts automatically to thread diameter & pitch.
- No measuring of thread required.
- Can be used on left and right hand threads.
- Can be used on both inch & metric threads.
- Hardened steel blade (62RC) guided by the existing threads, regrooves the damaged area.

Turn knurled knob (K) to fully retract the blade (B) into the housing. Insert iNES tool into the threaded hole or bore to be repaired.



Turn knurled knob (K) to extend blade (B) into the thread groove on an undamaged section and tighten by hand only.



Rotate the iNES internal fastener repair tool by the cross rod, as shown, in the desired direction.

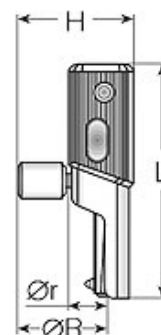
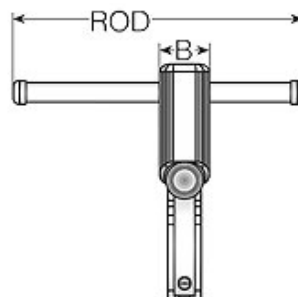

iNES #21 IBS No. 126289

iNES 22	OD	L	B	H	Rod	Or	OR
in.	5/16 to 7/16	4-5/16	11/16	1-3/4	4-9/16	11/16	1-9/16
mm.	12 to 16	109	18	45	116	17	39
pipes	1/16 - 3/16						

iNES #24 IBS No. 126296

iNES 24	OD	L	B	H	Rod	Or	OR
in.	7/8 to 1-1/4	5-3/8	1-1/16	2-1/2	6-3/8	1-1/16	2-1/8
mm.	22 to 32	136	27	64	161	27	54
pipes	1/2 to 7/8						

iNES #22 IBS No. 126294

iNES 22	OD	L	B	H	Rod	Or	OR
in.	1/2 to 5/8	4-5/16	11/16	1-3/4	4-9/16	11/16	1-9/16
mm.	12 to 16	109	18	45	116	17	39
pipes	1/4 - 3/8						

iNES #25 IBS No. 126297

iNES 25	OD	L	B	H	Rod	Or	OR
in.	1-1/4 to 2-1/8	6-7/16	1-1/2	3-3/16	7-9/16	1-3/8	2-7/16
mm.	22 to 32	163	38	81	192	35	62
pipes	7/8 to 1-3/4						

iNES #23 IBS No. 126295

iNES 23	OD	L	B	H	Rod	Or	OR
in.	11/16 to 13/16	4-3/8	13/16	2-1/16	5-1/8	13/16	1-3/4
mm.	16 to 20	111	21	53	130	20	45
pipes	3/8 - 1/2						



3 Pc iNES Internal Set

IBS No.	Description
126302	Contains #21 Small, #22 Medium & #23 Large iNES tools. Replacement blades included.



3 & 6 Pc NES Internal & External Tool Sets

IBS No.	Description
126303	Contains NES 1A Small External Tool, #21 Small & #22 Medium iNES Internal tools. Replacement blades included.
126304	Contains NES 1A Small & #2 Large External Tools, #21 Small, #22 Small, #23 Medium & #24 Large iNES Internal tools. Replacement blades included for internal tools.



iNES Replacement Blades & Nylon Pads



Replacement Blade

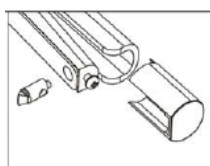

Nylon pads or for use with Internal tools to be used for repair for threads in aluminum or other soft metals.

IBS No.	Description
126305	iNES #21 Replacement Blades
126298	iNES #22 Replacement Blades
126299	iNES #23 Replacement Blades
126300	iNES #24 Replacement Blades
126301	iNES #25 Replacement Blades
126306	iNES #21 Nylon Pad
126306	iNES #22 Nylon Pad
126306	iNES #23 Nylon Pad
126306	iNES #24 Nylon Pad

ThreadMate™ Set & External Tool



- Fixes any thread in diameter between M5-M12 (#12 - 1/2") internal and M4-M13 (5/32" - 1/2") external.
- A great solution for outdoor technicians, industrial maintenance, workshops, auto garages, marine use, farmers, auto mechanics, professional and hobby users, etc.
- Small size fits any toolbox.
- External thread repair tool repairs and restores external threads.
- Easy to use set with built-in knob — just set and turn.
- Kit contains replaceable nylon pads for soft metal repair jobs.
- Clean thread in both ways - inside out, or outside in.
- Easy to operate, no special thread knowledge required — works on USS, SAE, Metric, Fine, Coarse, etc.

THREADMATE™ KIT & EXTERNAL TOOL

IBS No.	Description	Qty
126290	MINI ThreadMate™ Kit	1
126292	MINI ThreadMate™ External Tool	1
126291	Replacement Blades Ext. Tool 1 pr.	1

D R I L L B I T S E T C



IBS, INCORPORATED

Tools (T03)

D
R
I
L
L
B
I
T
S
E
T
C

External Deburring Tools 3Pc Set (T03)

IBS No. 476P

- Quickly repairs damaged threads from 7/64" to 2-1/3".
- Hardened HRC 60 Steel blades remove burrs and uneven ridges from threaded rods, pipes and more.
- Works on hardened and mild steels, Grade 8 fasteners, stainless steel, brass copper, aluminum, plastics, wood, etc.
- 1/4" hex shank attaches to your drill quickly.
- Most effective at low speeds — recommended speed should not exceed 500 RPM in a clockwise direction only.



IBS No.	Description	Shank	Qty
51951	Small Deburring Tool 7/64" to 7/16"	1/4"	1
51950	Medium Deburring Tool 5/16" to 7/8"	1/4"	1
51952	Large Deburring Tool 23/32" to 2-1/3"	3/8"	1



REMOVE BURS



REPAIR DAMAGED THREADS



WORKS ON A VARIETY OF MATERIALS

GrabIt® Drill-Out Broken Bolt Extractor Set

Removing stripped screws and bolts can be a frustrating experience, and now there's a solution! This 4 pc extractor kit removes broken bolts from as small as 1/4" to 1/2" (6mm-12mm) and can drill up to Grade 8 or 10.9 class fasteners. Each Drill-Out is a drill bit and extractor in one and is uniquely designed to drill into the rough surfaces when bolts break.

SINGLE STEP EXTRACTION FAST & EASY TO USE

A drill bit and extractor in one tool, the DRILL-OUT creates a unique interaction between drill bit and extractor, resulting in maximum impact and break out ability. Broken bolts and studs are removed quickly and easily without damaging the fastener threads.

- **Unique drill tip** allows the tool to stay on center.
- **Self-centering drill tip eliminates** walking or wandering.
- **No grinding, center punching or pilot hole** required.
- **Works** on jagged, uneven and rough breaks.
- **Tempered twice for extra hardness;** resulting in multiple extractions per tool.
- **Made from the highest quality M2 HSS Steel.**
- **MADE IN THE USA.**



DRILLING:

1. Choose the correct size DRILL-OUT.
2. Secure round end in the drill chuck and tighten.
3. Thread collet/extractor back against drill chuck.
4. Set drill in reverse and begin drilling at the suggested RPM's. (see Figure 1)

REMEMBER: Hole must be straight & on center.

DO NOT allow collet/extractor to move down toward tip while drilling.

5. Stop drilling just before the collet/extractor reaches the broken bolt. (See Figure 2)
6. Apply penetrating oil to help loosen bolt.

IBS No.	Description	Qty
133309	Grab-It Drill Out Extractor 4 Pc Set 1/4" to 1/2" (6mm to 12mm)	1

WARNING: Always wear safety glasses when operating or near power tools. Cutting tools may shatter when broken.



Power-Outs™ Double Edged Screw Extractors

These patented double-edged screw extractors are made from hardened chrome vanadium steel with a burnished finish. The cutting edges are polished, and the part number and dimensions are laser marked on the shank for easy identification.



POWER OUTS DOUBLE EDGED SCREW EXTRACTORS

IBS No.	Size	SW Diam (in)	Drill Diam (in)		Screw Size (in)	
			Min	Max	Min	Max
139501	1	1/4	1/8	3/16	3/16	1/4
139502	2	3/8	3/16	9/32	5/16	3/8
139503	3	1/2	1/4	3/8	7/16	1/2
139504	4	5/8	11/32	1/2	1/2	9/16
139505	5	3/4	7/16	5/8	5/8	3/4
139506	6	7/8	9/16	3/4	7/8	1
139507	7	1	3/4	15/16	1	1-1/8
139395	5 Pc Set (Sizes 1-5 in a plastic pouch)					

Power-Outs™ Sets



POWER OUTS & LH DRILL EXTRACTOR SET

IBS No.	Description
670P	5 pc Power Outs & 8 Pc LH Drill Extractor Set (1/16, 1/8, 3/16, 1/4, 5/16, 3/8, 7/16, 1/2)
745R	5 pc Power Outs Travel Tray w/Corresponding LH Drill Bits (5/32, 1/4 5/16, 7/16 & 1/2)
818R	5 pc Power Outs Travel Tray w/Corresponding LH Stubby Drill Bits (5/32, 1/4 5/16, 7/16 & 1/2)

Bolt Extractors

- Reverse spiral flutes are designed to bite down to provide maximum gripping power.
- High carbon steel ensures longer life and greater durability.
- Universal lobular design fits all types of fasteners.
- 3/8 square drive for use with hand ratchets, impact wrenches, and air ratchets.
- Hexagonal flats for use with flat wrench, pliers, adjustable wrench, sockets or locking pliers.



IBS No.	Description
54115	5 PC 3/8 DRIVE BOLT / STUD EXTRACTOR SET 5/16 - 3/4 Removes bolt sizes: 8mm, 10mm, 13mm, 19mm, 5/16, 11/16, & 3/4" in drive size 3/8"

Hex Head Spline Drive Screw Extractors

- Designed to remove broken studs, bolts, socket screws and fittings from #12 - 1-3/4".
- For use with sockets and flat wrenches.
- Made in the U.S.A.



25 Piece Hex Head Spline Drive Screw Extractor Set

IBS No.	Description
53227	25 Pc. Hex Head Spline Drive Screw Extractor Set. Sizes 1/8 - 7/8. Packaged in a sturdy blue plastic box for easy storage and organization

IBS No.	Size	Hex Hd Size	Bolt Dia.	Drill Bit
53201	1/8	1/2	#12	1/8
53202	5/32	1/2	1/4	5/32
53205	1/4	1/2	7/16	1/4
53206	9/32	1/2	1/2	9/32
53207	5/16	1/2	9/16	5/16
53208	11/32	1/2	5/8	11/32
53209	3/8	1/2	11/16	3/8
53210	13/32	1/2	3/4	13/32
53211	7/16	5/8	13/16	7/16
53213	1/2	5/8	15/32	1/2
53216	19/32	3/4	1-1/8	19/32
53217	5/8	3/4	1-3/16	5/8
53220	23/32	7/8	1-3/8	23/32
53225	7/8	1	1-11/16	7/8

D R I L L B I T S E T C



D
R
I
L
L
B
I
T
S
E
T
C



Taps, Burs & Blades

A

Annular Cutters

Carbide Tipped

CT150 & CT200 PT-13, PT-15

IBS High Speed Steel PT-15

Assortments

Threaded Rod

Grade 8 Threaded Rod Assortment PT-60

Assortments, Cutting Tools

Advanced Edge Power Reciprocating Saw Blades

with Tool Ease Lubricant Stick PT-44

Annular Cutters - Carbide Tipped

PT-14

Annular Cutters - High Speed Steel PT-16

Black Hole Carbide Tipped Cutters

1" Depth - 4 Pc.Set PT-22

1" Depth - 5 Pcs PT-22

3/16" Depth - 5 Pc. PT-22

762R - 5 Pc. - 3/16" Depth PT-21

763R - 4 Pc. 1" Depth PT-21

764R - 5 Pc. - 1" Depth PT-22

Carbide Burs PT-58, PT-60

Hole Saws

Bi-Metal

Advanced Bi-Metal Hole Saws 2-1/8" - 4" PT-26

Advanced Bi-Metal Hole Saws 3/4" - 4" PT-27

Advanced Bi-Metal Hole Saws 5/8" - 2" PT-28

M42 Thin Wall Hole Saws Travel Tray Assortment PT-17

Hole Saws - Bi-Metal

Advanced Edge Bi-Metal Hole Saws 2-1/8" - 4" PT-26, PT-28

Advanced Edge Bi-Metal Hole Saws 3/4" - 4" PT-27, PT-29

Advanced Edge Bi-Metal Hole Saws 5/8" - 2" PT-21, PT-22, PT-26, PT-28

Advanced Edge Bi-Metal Hole Saws 11 Pc Kit PT-29

Advanced Edge Bi-Metal Hole Saws 14 Pc Kit PT-29

Nitro-Carb Power Tap & Hex Die Sets PT-8, PT-10

Saw Blades

Advanced Edge Power Reciprocating Saw Blades

with Tool Ease Lubricant Stick PT-44

Bi-Metal Air Saw Blades PT-50

Bi-Metal Reciprocating

Saw Blades PT-48

Bore Blades and Demolition Blades PT-48

IBS Hi-Alloy & Triple-Cut Hacksaw Blades PT-43

Reciprocating Saw Handle & Blade Kit PT-47

Special Purpose Reciprocating Saw Blades PT-49, PT-63

Taps, Metric

Index

18 Metric Taps & Drill Bits w/Index PT-7

Organizer

29 pc Metric Taps, Drill Bits, Hex Dies & Tools PT-7

Taps, Standard

Drawer

4-40 thru 1/2-10 Tap, Die & Drill Set PT-9

9/16-12 thru 3/4-16 Tap, Die & Drill Set PT-9

Index

10 Pc NC/NF Power Taps w/Index PT-5, PT-8

10 Pc NC/NF Taper Taps w/Index PT-8

18 Pc NC Bottom Taps & Drill Bits w/Index PT-8

18 Pc NC Taper Taps & Drill Bits w/Index PT-8

Nitro-Carb Hand Tap PT-8

B

Blades

100 PK Shark Serrated Blades PT-53

Bandsaw, Bi-Metal

General Information PT-35

Portable Blades PT-40

Troubleshooting PT-36, PT-37, PT-38, PT-39

Bi-Metal

Air Saw Blades PT-50

Reciprocating Saw PT-45

Boar Blades PT-46

Thick Demolition PT-46

Sabre/Jig PT-51

Chop Saw-Carbide Tipped

14" Blade for Aluminum PT-33

14" Blade for Stainless Steel PT-33

14" Blade for Steel PT-33

Circular Saw

Combination Blade PT-31

Heavy Duty Deck / Nail Cutting Blade PT-31

Miter Saw Blade PT-32

Miter Saw Rip Blade PT-32

Novelty Combo Blade PT-31

Steel & Iron Cutting Blade PT-31

Circular Saw-Carbide Tipped

7-1/4" Blades for Aluminum PT-33

7-1/4" Blades for Steel PT-33

SteelMax 7-1/4" Blades for Stainless Steel PT-33

Hacksaw

IBS Hi-Alloy PT-42

Triple-Cut PT-42

Reciprocating Saw

Advanced Edge Power Reciprocating Saw Blades PT-44

Bi-Metal PT-45

Double Edge Bi-Metal Bore Blades PT-46, PT-47

Power Curve PT-46

Tungsten Carbide PT-46

Retractable Knife

HD 8 PT Snap Blade PT-52

Heavy Duty Hook Utility Blades PT-52

Single Edge Razor Blades PT-53

Burs - Carbide, Rotary

14° Taper Radius PT-57

Ball Shape PT-56



T
A
P
S

B
U
R
S

B
L
A
D
E
S

- Cone Shape PT-57
- Cylinder PT-56
- Cylinder Radius End PT-56
- General Information
 - Surface Feet Conversion Chart PT-59
- Oval PT-57
- Tree Pointed End PT-57
- Tree Radius End PT-57

F

Files

Accessories

- File Card PT-62
- Skroo-Zon File Handles PT-63

Black Maxi-Sharp

- All Purpose PT-61
- Half-Round PT-61
- Mill PT-61
- Multi-Kut Flat PT-62
- Round PT-62
- Tapered Saw PT-62

Chainsaw Files PT-62

Tungsten Points File with Pocket Clip PT-62

Fiskars Utility Knives & Tools

Tools

- Fiskars PowerArc Easy Action Shears (10") PT-55
- Fiskars PowerArc Utility Snips (8") PT-55

Utility Knives

- Fiskars Pro Fixed Blade Utility Knife PT-54
- Fiskars Pro Folding Utility Knife PT-54
- Fiskars Pro Retractable Blade Utility Knife PT-54

H

Hacksaw Frame, 4-in-1 PT-41

Hex Dies

Nitro-Carb PT-12

Hole Saws

Bi-Metal

- Advanced Bi-Metal Hole Saws PT-25
- Arbors PT-25
- Hole Saw Arbor Replacement Drill PT-25

Carbide Tipped Annular Cutters

- CT150 PT-13, PT-15, PT-16
- CT150 Accessories PT-13, PT-15
- CT200 PT-13, PT-15, PT-16

Carbide Tipped, Black Hole

- 1" Depth PT-20
- 3/16" Depth
 - Accessories PT-19

M42 Thin Wall Hole Saws PT-17

Sheet Metal Slugger Cutters PT-18

- Slugger Cutter Accessories
 - 3mm Hex Key PT-18
 - Pilot Pin PT-18
- Slugger Cutter Arbor Assembly PT-18

Technical Information

Cutting Speeds PT-30

K

Knives

Cartridge Loading Snap Knife with Rubber Grip PT-52

Fiskars Utility Knives

- Fiskars Pro Fixed Utility Knife PT-54
- Fiskars Pro Retractable Blade Utility Knife PT-54

HD Retractable Blade 8 Pt. Breakaway Knife PT-52

SHARK Combination Utility Knife PT-53

L

Lubricants

Ultra Lube Super Premium

Cutting Fluid PT-24

T

Taps

Nitro-Carb

- Bottom PT-6
- General Information PT-6
- Hand Tap Assortments - Index PT-8
- HSS Taper Pipe Taps PT-6, PT-8, PT-10
- Metric Taps PT-7
- Metric Tap Sets PT-7
- NPT Pipe PT-7
- Plug PT-6
- Power PT-6
- Power Tap & Hex Die Sets PT-8, PT-10
- Taper PT-6

Threaded Rod

Tools

- Deburring Tool (T03) PT-60

Tools

Hand

- 4-in-1 Hacksaw Frame PT-41
- Cartridge Loading Snap Knife with Rubber Grip PT-52, PT-53
- HD Retractable Blade
 - 8 Pt. Breakaway Knife PT-52
- Heavy Duty Metal Scraper PT-53
- Professional Hex Die Wrench PT-11
- Professional Straight Handle Tap Wrench PT-11
- Reciprocating Saw Handle PT-47
- Revo Folding Knife PT-53
- Tapping Tool & Guide PT-11
- T-Handle Tap Wrench PT-11

Power

- 7-1/4 Circular Saw PT-33
- 14" Circular Saw PT-34
- Compact Magnetic Drill Press PT-23
- Magnetic Drill Press PT-23
- Variable Speed / Reversible
 - Magnetic Drill Press PT-23

Replacement Parts



HD 8 PT Snap Blade PT-52
Heavy Duty Hook Utility Blades PT-52
Plastic Razor Blades PT-53
Single Edge Razor Blades PT-53
Threaded Rod
Deburring Tool 3Pc Set (T03) PT-60

T
A
P
S

B
U
R
S

B
L
A
D
E
S



IBS, INCORPORATED

Nitro Carb Taps P10

"Power" Taps Changing The Way Holes Are Tapped



Before the "Power" Tap, it was said that all taps broke before they wore out. But now that has all changed. Called a "Power" Tap because of the way it "shoots" the chips out ahead of the tap. The design is radically different from that of the ordinary tap and therefore can be used well in power tools. This change is most noticeable when tapping stringy materials, where before the flutes would become loaded and cause the tap to break. The "Power" Tap design makes it possible to use shallower flutes which translates to a stronger tap. This all adds up to a tap which requires less power to drive and, for some classes of work (through holes and blind holes with sufficient clearance at the bottom, most notably), are much more economical to use than ordinary hand taps.

T
A
P
S

B
U
R
S

B
L
A
D
E
S

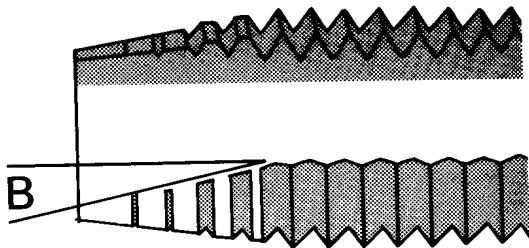
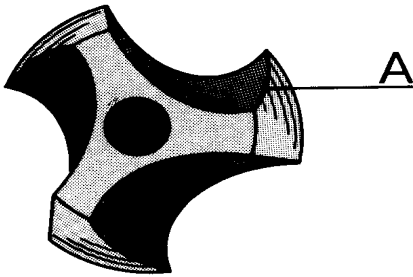

"Power" Tap Design

The cutting edges (**A**) at the point of the tap are ground at an angle (**B**) to the axis for a distance of four or five threads. This angle, in conjunction with the hook on the cutting edge of the land and the special flute form, produces the long curling chips. These chips, instead of passing out or backing in the flutes, are "shot" out ahead of the tap.

"Power" Tap



Hand Tap



Stronger

A "Power" Tap does not need the deep flutes that an ordinary tap requires for the elimination of chips. Thus fewer and shallower flutes can be used giving the tap a larger cross sectional arc and extra strength.

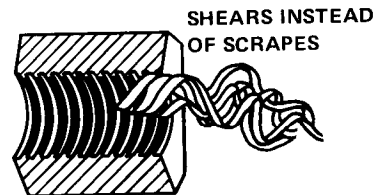

Less Power Needed

The metal is sheared by the angular cutting edge with a hook on the land instead of being torn or pulled off with a scraping action. Much less power is needed for this shearing across than is required for hand taps.

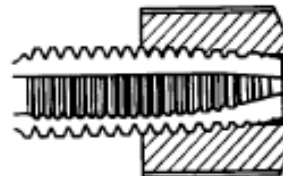

Accuracy

The first few teeth of the "Power" Tap do all the cutting. The remainder of the threaded section serves as a lead screw, steadying the tap and insuring a more accurately tapped hole.

IBS, INCORPORATED

Nitro-Carb Taps P10



Pro Power Taps

IBS Pro Power Taps are designed for difficult materials including: stainless steel, alloy steels, and high carbon steel. Special tool geometry creates less torque, better removal of chips and runs cooler. Reduced neck design enhances the flow of cutting fluid to cutting teeth and reduces surface contact between the tool and workpiece for more efficient threading.

- **Constructed of Chromium, Vanadium, Molybdenum and Cobalt Alloys**
- **Cuts Harder Materials than standard HSS Tap - Cuts Up to 45 Rockwell "C"**
- **Superior Design Actually Shoots Chips Out Ahead of the Tap Providing a Faster, Cleaner and Smoother Thread and a Longer Lasting Tap.**

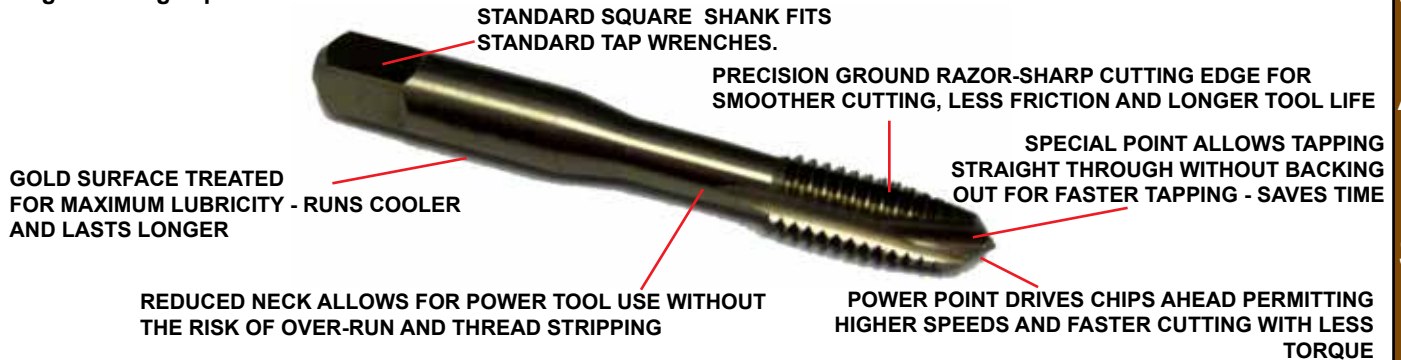

Inch

Thread Size	# of Flutes	IBS No.	Thread Size	# of Flutes	IBS No.	Thread Size	# of Flutes	IBS No.	Thread Size	# of Flutes	IBS No.
4-40	2	18000	10-32	3	18004	5/16-18	2	18008	7/16-14	3	18012
6-32	2	18001	12-24	3	18005	5/16-24	2	18009	7/16-20	3	18013
8-32	3	18002	1/4-20	3	18006	3/8-16	3	18010	1/2-13	3	18014
10-24	3	18003	1/4-28	3	18007	3/8-24	3	18011	1/2-20	3	18015

Metric

Thread Size	# of Flutes	IBS No.	Thread Size	# of Flutes	IBS No.	Thread Size	# of Flutes	IBS No.	Thread Size	# of Flutes	IBS No.
M3-.5	2	18020	M6-1.0	3	18023	M10-1.5	3	18025	M14-2.0	3	18027
M4-.7	3	18021	M8-1.25	3	18024	M12-1.75	3	18026	M16-2.0	3	18028
M5-.8	3	18022									

Pro Power Tap Assortments (P15)



IBS No.	Description
563P	10 Pc NC/NF Pro Power Taps with Index Tap Sizes: 1/4-20, 1/4-28, 5/16-18, 5/16-24, 3/8-16, 3/8-24, 7/16-14, 7/16-20, 1/2-13, 1/2-20 Packaged in a sturdy 10 pc. metal index
17456	18 Pc NC Pro Power Taps & Drill Bits with Index Tap Sizes: 6-32, 8-32, 10-24, 10-32, 1/4-20, 5/16-18, 3/8-16, 7/16-14, 1/2-13 Drill Bits: #36, #29, #25, #21, #7, "F", 5/16, "U", 27/64 Packaged in a sturdy 18 pc. metal index
17458	8 Pc Metric Pro Power Taps with Index Tap Sizes: M3-0.50, M4-0.70, M5-0.80, M6-1.00, M8-1.25, M10-1.50, M12-1.75, M16-2.00 Packaged in a sturdy 10 pc. metal index
17457	28 Pc NC/NF Pro Power Taps & Drill Bits with Organizer Tap Sizes: 6-32, 8-32, 10-24, 10-32, 1/4-20, 1/4-28, 5/16-18, 5/16-24, 3/8-16, 3/8-24, 7/16-14, 7/16-20, 1/2-13, 1/2-20 Drill Bits: #36, #29, #25, #21, #7, #3 "F", I, Q, 5/16, 3/8, 25/64, 27/64, 29/64 Packaged in a sturdy 28 pc. metal index



IBS, INCORPORATED

Nitro-Carb Taps P10

Nitro-Carb Taps

IBS Nitro-Carb Taps are professional quality cutting tools for maintenance and repair applications. They are made of the same quality alloys as our drill bits (Chromium, Vanadium, and Molybdenum), which allows for faster cutting and longer tap life.

FEATURES:

- **Nitro-Carburized finish** at 950°F to be measurably harder than high speed steel.
- **Space age Nitro-Carb steel** withstands substantially higher operating temperatures while maintaining sharpness.
- **Requires 30% less torque** to provide faster cutting.
- **30% heavier web** than regular taps — for less tap breakage.
- **Special Hi-Tungsten & High Molybdenum tool steels**, gold surface treated for maximum lubricity.
- **Precision ground threads** for the ultimate in accuracy and performance.
- **3 styles** - Taper, Power & Bottoming styles provide versatility in tough materials both blind & through holes.
- **For general use in production tapping** or hand operations.
- **Cuts materials up to 55 Rockwell** on the "C" scale.
- **Thread tolerances are to .0005.** Gives perfect threads every time.
- **Outlasts ordinary taps 3 to 1.**
- **Recommended for stainless** and other hard metals.
- **Nitro-Carb Taps will reduce your "Tapped Hole" costs** tremendously saving time, labor, & money
- **Triple Heat Treated Ground Threads** and Special Alloys all combine to give you a 200% higher breaking torque over ordinary taps.



POWER

Three to five threads chamfered. For general use when tapping into the bottom of a hole is not critical.



TAPER

Eight to ten threads chamfered for easy use thread starting in tough materials



BOTTOM

One and one half threads chamfered. Use after threads have been started for tapping to the bottom of a hole.

Thread Size	Drill Size	Power	# of Flutes	Plug	# of Flutes	Taper	# of Flutes	Bottom	# of Flutes	Thread Size	Drill Size	Power	# of Flutes	Plug	# of Flutes	Taper	# of Flutes	Bottom	# of Flutes
4-40	43	17629	2			17600	3	17655	3	7/16-20	25/64	17642	3			17613	4	17668	4
6-32	34	17630	2			17601	3	17656	3	1/2-13	27/64	17643	3			17614	4	17669	4
8-32	29	17631	2			17602	4	17657	4	3/16-20	29/64	17644	3			17617	4	17670	4
10-24	23	17632	2			17603	4	17658	4	9/16-12	31/64			17645	4	17619	4	17671	4
10-32	20	17633	2			17604	4	17659	4	9/16-18	1/2			17646	4	17620	4	17672	4
12-24	16	17634	2			17605	4	17660	4	5/8-11	17/32	17647	3			17621	4	17673	4
1/4-20	7	17635	2			17606	4	17661	4	5/8-18	9/16	17648	3			17622	4	17674	4
1/4-28	3	17636	2			17607	4	17662	4	3/4-10	21/32	17649	3			17623	4	17675	4
5/16-18	"G"	17637	2			17608	4	17663	4	3/4-16	11/16	17650	3			17624	4	17676	4
5/16-24	"I"	17638	2			17609	4	17664	4	7/8-9	49/64			17651	4	17625	4	17677	4
3/8-16	"O"	17639	3			17610	4	17665	4	7/8-14	13/16			17652	4	17626	4	17678	4
3/8-24	"R"	17640	3			17611	4	17666	4	1-8	7/8			17653	4	17627	4	17679	4
7/16-14	3/8	17641	3			17612	4	17667	4	1-14	59/64			17654	4	17628	4	17680	4

Nitro-Carb Taper Pipe Taps



Thread	Drill Size	Taper	Flutes	Thread	Drill Size	Taper	Flutes	Thread	Drill Size	Taper	Flutes
1/8-27	11/32	17682	4	1/4-18	7/16	17683	4	3/8-18	37/64	17684	4
1/2-14	23/32	17685	4	3/4-14	59/64	17686	5				

TAPS BURRS BLADES

IBS, INCORPORATED

Nitro-Carb Taps P10



Nitro-Carb Metric Taps



Thread Size	Drill Size	Power	# of Flutes	Plug	# of Flutes	Taper	# of Flutes	Bottom	# of Flutes
M2.5-.45	2.05	17704	2			17687	3	17750	3
M3-.5	2.5	17705	2			17688	3	17751	3
M3.5-.60	2.9	17706	2			17691	3	17752	3
M4-.70	3.3	17707	2			17689	4	17753	4
M4.5-.75	3.75	17719	2			17695	4	17771	4
M5-.80	4.2	17708	2			17690	4	17754	4
M6-1.0	5.0	17709	2			17692	4	17755	4
M8-1.0*	7.0			17768	4	17693	4	17756	4
M8-1.25	6.7	17710	3			17694	4	17757	4
M10-1.25*	8.7			17769	4	17696	4	17758	4
M10-1.5	8.5	17711	3			17697	4	17759	4
M12-1.25*	10.8			17770	4	17698	4	17760	4
M12-1.75	10.2	17712	3			17699	4	17761	4
M14-1.5*	12.5			17720	4	17700	4	17762	4
M14-2.0	12.0	17713	3			17701	4	17763	4
M16-1.5*	14.5			17721	4	17702	4	17764	4
M16-2.0	14.0	17714	3			17703	4	17765	4
M18-2.5	15.5	17772	3			17773	4	17774	4
M20-2.5	17.5			17715	4	17717	4	17766	4
M24-3.0	21.0			17716	4	17718	4	17767	4

* indicates Fine Thread

Nitro-Carb Metric Tap Sets

IBS No.	Description
17445 (P15)	18 Metric Taps & Drill Bits w/Index Tap Sizes: M2.5-.45, M3-.5, M3.5-.60, M4-.70, M5-.80, M6-1.0, M8-1.25, M10-1.5, M12-1.75 Drill Bits: 2.05mm, 2.5mm, 2.9mm, 3.3mm, 4.2mm, 5mm, 6.7mm, 8.5mm, 10.2mm Packaged in a sturdy 18 pc. metal index
567P (Z08)	29 pc Metric Taps, Drill Bits, Hex Dies & Tools Tap Sizes: M2.5-.45, M3-.5, M3.5-.60, M4-.70, M5-.80, M6-1.0, M8-1.25, M10-1.5, M12-1.75 Includes the following tools: (1) Straight Handle Top Wrench, (1) 1" Hex Die Wrench, (1) 1-7/16" Hex Die Wrench Packaged in a sturdy 3 drawer organizer
17453	10pc Metric Power Taps Tap Sizes: M3-.5, M3.5-.6, M4-.70, M4.5-.75, M5-.80, M6-1.0, M8-1.25, M10-1.5, M12-1.75, M16-20. Packaged in a sturdy metal index
17454	10pc Metric Taper Taps Tap Sizes: M3-.5, M3.5-.6, M4-.70, M4.5-.75, M5-.80, M6-1.0, M8-1.25, M10-1.5, M12-1.75, M16-2.0. Packaged in a sturdy metal index
17455	10pc Metric Bottom Taps Tap Sizes: M3-.5, M3.5-.6, M4-.7, M4.5-.75, M5-.8, M6-1.0, M8-1.25, M10-1.5, M12-1.75, M16-2.0. Packaged in a sturdy metal index



T
A
P
S

B
U
R
S

B
L
A
D
E
S



IBS, INCORPORATED

Assortments Z08

TAPS
BURS
BLADES

Nitro-Carb Hand Tap Assortments (P15)



IBS No.	Description
551P	10 Pc NC/NF Power Taps with Index Tap Sizes: 1/4-20, 1/4-28, 5/16-18, 5/16-24, 3/8-16, 3/8-24, 7/16-14, 7/16-20, 1/2-13, 1/2-20 Packaged in a sturdy 10 pc. metal index
550P	10 Pc NC/NF Taper Taps w/Index Tap Sizes: 1/4-20, 1/4-28, 5/16-18, 5/16-24, 3/8-16, 3/8-24, 7/16-14, 7/16-20, 1/2-13, 1/2-20 Packaged in a sturdy 10 pc. metal index
552P	10 Pc NC/NF Bottom Taps w/Index Tap Sizes: 1/4-20, 1/4-28, 5/16-18, 5/16-24, 3/8-16, 3/8-24, 7/16-14, 7/16-20, 1/2-13, 1/2-20 Packaged in a sturdy 10 pc. metal index
554P	10 Pc NC Power Taps with Index Tap Sizes: 4-40, 6-32, 8-32, 10-24, 10-32, 1/4-20, 5/16-18, 3/8-16, 1/2-13, 5/8-11 Packaged in a sturdy 10 pc. metal index
553P	10 Pc NC Taper Taps with Index Tap Sizes: 4-40, 6-32, 8-32, 10-24, 10-32, 1/4-20, 5/16-18, 3/8-16, 1/2-13, 5/8-11 Packaged in a sturdy 10 pc. metal index
555P	10 Pc NC Bottom Taps with Index Tap Sizes: 4-40, 6-32, 8-32, 10-24, 10-32, 1/4-20, 5/16-18, 3/8-16, 1/2-13, 5/8-11 Packaged in a sturdy 10 pc. metal index
17448	18 Pc NC Power Taps & Drill Bits with Index Tap Sizes: 6-32, 8-32, 10-24, 10-32, 1/4-20, 5/16-18, 3/8-16, 7/16-14, 1/2-13 Drill Bits: #36, #29, #25, #21, #7, "F", 5/16" "U", 27/64" Packaged in a sturdy 18 pc. metal index
17447	18 Pc NC Taper Taps & Drill Bits with Index Tap Sizes: 6-32, 8-32, 10-24, 10-32, 1/4-20, 5/16-18, 3/8-16, 7/16-14, 1/2-13 Drill Bits: #36, #29, #25, #21, #7, "F", 5/16" "U", 27/64" Packaged in a sturdy 18 pc. metal index
17449	18 Pc NC Bottom Taps & Drill Bits with Index Tap Sizes: 6-32, 8-32, 10-24, 10-32, 1/4-20, 5/16-18, 3/8-16, 7/16-14, 1/2-13 Drill Bits: #36, #29, #25, #21, #7, "F", 5/16" "U", 27/64" Packaged in a sturdy 18 pc. metal index

Nitro-Carb Power Tap & Hex Die Sets

- **Special Hi-Tungsten and Hi-Molybde-num tool steel construction, gold surfacetreated** for maximum lubricity.
- **Recommended for use in production tapping and drilling** in work hardening grades of stainless steel and other hard metal applications.
- **Precision ground tap threads** for the ultimate in accuracy and performance.



40 Pc NITRO-CARB POWER TAP & HEX DIE SET

IBS No.	Description
17472	SET CONTAINS: <ul style="list-style-type: none"> • Nitro Power Taps & Hex Die Sizes: 4-40, 6-32, 8-32, 10-24, 10-32, 12-24, 1/4-20, 1/4-28, 5/16-18, 5/16-24, 3/8-16, 3/8-24, 7/16-14, 7/16-20, 1/2-13 & 1/2-20 • Nitro-Carb Taper Pipe Tap & Hex Die: 1/8-27 NPT • T-Handle tap wrenches: 0" - 1/4" & 3/16" - 1/2" • Straight handle tap wrench: #4 - 1/2" • Die stock, screw pitch gauge & screwdriver. • Packaged in a sturdy molded plastic case.



25 Pc NITRO-CARB POWER TAP & HEX DIE SET

IBS No.	Description
17471	SET CONTAINS: <ul style="list-style-type: none"> • Nitro Power Taps & Hex Die Sizes: 1/4-20, 1/4-28, 5/16-18, 5/16-24, 3/8-16, 3/8-24, 7/16-14, 7/16-20, 1/2-13 & 1/2-20. • Nitro-Carb Pipe Tap & Hex Die Size: 1/8-27 NPT • T-Handle tap wrench: 3/16" - 1/2" • Die stock, screw pitch gauge & screwdriver. • Packaged in a sturdy molded plastic case.

















IBS, INCORPORATED

Assortments Z08









#4 thru 1/2 Tap, Die & Drill Set
NITRO-CARB TAPS WITH TAP & DIE WRENCHES
 Packaged in a Locking Steel Drawer for Easy Storage & Organization
IBS No. 591P • 50 Items • 50 Pcs



 IBS, Inc. <small>SPECIALTY PRODUCTS FOR MAINTENANCE & REPAIR INDUSTRIALBOLT.COM • 800-678-1906</small>		Nitro-Carb Power Taps, Hex Dies and Drill Bits with Tools	
120922 Professional Tap Wrench		120925 Professional 1" Hex Die Wrench	
129913 17643 16823  1/2-13 HSS Hex Die Nitro-Carb Power Tap 27/64 Drill Bit	129922 17644 16825  1/2-20 HSS Hex Die Nitro-Carb Power Tap 29/64 Drill bit	129912 17641 16820  7/16-14 HSS Hex Die Nitro-Carb Power Tap 3/8 Drill Bit	129921 17642 16821  7/16-20 HSS Hex Die Nitro-Carb Power Tap 25/64 Drill Bit
129910 17637 16141  5/16-18 HSS Hex Die Nitro-Carb Power Tap "G" Drill Bit	129919 17638 16143  5/16-24 HSS Hex Die Nitro-Carb Power Tap "T" Drill Bit	129911 17639 16149  3/8-16 HSS Hex Die Nitro-Carb Power Tap "O" Drill Bit	129920 17640 16152  3/8-24 HSS Hex Die Nitro-Carb Power Tap "R" Drill Bit
129917 17633 16099  10-32 HSS Hex Die Nitro-Carb Power Tap #20 Drill Bit	129908 17634 16095  12-24 HSS Hex Die Nitro-Carb Power Tap #16 Drill Bit	129909 17635 16086  1/4-20 HSS Hex Die Nitro-Carb Power Tap #7 Drill Bit	129918 17636 16082  1/4-28 HSS Hex Die Nitro-Carb Power Tap #3 Drill Bit
129904 17629 16122  4-40 HSS Hex Die Nitro-Carb Taper Tap #43 Drill Bit	129905 17630 16113  6-32 HSS Hex Die Nitro-Carb Power Tap #34 Drill Bit	129906 17631 16108  8-32 HSS Hex Die Nitro-Carb Power Tap #29 Drill Bit	129907 17632 16102  10-24 HSS Hex Die Nitro-Carb Power Tap #23 Drill Bit

9/16 thru 3/4 Tap, Die & Drill Set
NITRO-CARB TAPS WITH TAP & DIE WRENCHES
 Packaged in a Locking Steel Drawer for Easy Storage & Organization
IBS No. 592P • 50 Items • 50 Pcs



 IBS, Inc. <small>SPECIALTY PRODUCTS FOR MAINTENANCE & REPAIR INDUSTRIALBOLT.COM • 800-678-1906</small>		Nitro-Carb Plug/Power Taps, Hex Dies and Drill Bits with Tools	
120923 Professional Tap Wrench		120926 Professional 1-7/16" Hex Die Wrench	
129916 17649 16842  3/4-10 HSS Hex Die Nitro-Carb Power Tap 21/32 Drill Bit	129925 17650 16844  3/4-16 HSS Hex Die Nitro-Carb Power Tap 11/16 Drill bit	129915 17647 16834  5/8-11 HSS Hex Die Nitro-Carb Power Tap 17/32 Drill Bit	129924 17648 16836  5/8-18 HSS Hex Die Nitro-Carb Power Tap 9/16 Drill bit
129914 17645 16827  9/16-12 HSS Hex Die Nitro-Carb Plug Tap 31/64 Drill Bit	129923 17646 16828  9/16-18 HSS Hex Die Nitro-Carb Plug Tap 1/2 Drill bit		

TAPS
BURS
BLADES



IBS, INCORPORATED

Assortments Z08

Metric Nitro-Carb Power Taps, Drill Bits & Tap & Die Tools

NITRO-CARB TAPS

Packaged in a Locking Steel Drawer for Easy Storage & Organization
IBS No. 593P • 29 Items • 29 Pcs



T
A
P
S

B
U
R
S

B
L
A
D
E
S



Metric Nitro-Carb Power Taps, Hex Dies and Drill Bits w/ Tools

Assortment No. 593P

<p>120925 Professional 1" Hex Die Wrench</p>		<p>120926 Professional 1" Hex Die Wrench</p>	
<p>120922 Professional Tap Wrench</p>			
<p>129934 M10-1.5 Nitro-Carb Hex Die 17711 Nitro-Carb Power Tap 17919 8.5mm Nitro-Carb Drill Bit</p>			<p>129935 M12-1.75 Nitro-Carb Hex Die 17712 Nitro-Carb Power Tap 17936 10.2mm Nitro-Carb Drill Bit</p>
<p>129931 M6-1.0 Nitro-Carb Hex Die 17709 Nitro-Carb Power Tap 17884 5mm Nitro-Carb Drill Bit</p>			<p>129933 M8-1.25 Nitro-Carb Hex Die 17710 Nitro-Carb Power Tap 17901 6.7mm Nitro-Carb Drill Bit</p>
<p>129929 M4-0.7 Nitro-Carb Hex Die 17707 Nitro-Carb Power Tap 17867 3.3mm Nitro-Carb Drill Bit</p>			<p>129930 M5-0.8 Nitro-Carb Hex Die 17708 Nitro-Carb Power Tap 17876 4.2mm Nitro-Carb Drill Bit</p>
<p>M2.5-0.45 17704 Nitro-Carb Power Tap 17854 2.05mm Nitro-Carb Drill Bit</p>	<p>M3-0.5 129928 Nitro-Carb Hex Die 17705 Nitro-Carb Power Tap 17859 2.5mm Nitro-Carb Drill Bit</p>	<p>M3.5-0.6 135590 Nitro-Carb Hex Die 17706 Nitro-Carb Power Tap 17863 2.9mm Nitro-Carb Drill Bit</p>	

Nitro-Carb Power Tap & Hex Die Sets

- **Special Hi-Tungsten and Hi-Molybdenum tool steel construction, gold surface treated** for maximum lubricity.
- **Recommended for use in production tapping and drilling** in work hardening grades of stainless steel and other hard metal applications.
- **Precision ground tap threads** for the ultimate in accuracy and performance.



24Pc METRIC NITRO-CARB POWER TAP & HEX DIE SET

IBS No.	Description
17474	SET CONTAINS:
	<ul style="list-style-type: none"> • Nitro Power Taps & Hex Die Sizes: 3.0-.50, 3.5-.60, 4.0-.70, 5.0-.80, 6.0-1.00, 8.0-1.25, 10.0-1.50 & 12.0-1.75. • HSS pipe tap & hex die size: 1/8-27 NPT • T-Handle tap wrenches: 0" - 1/4" & 3/16" - 1/2" • Straight handle tap wrench: #4 - 1/2" • Die stock & screw metric pitch gauge. • Packaged in a sturdy molded plastic case.



Professional Straight Handle Tap Wrench (T03)

- Solid construction for long life and ease of use.
- Straight handle design provides greater leverage, especially when using larger diameter taps.
- Ideal for hand tapping.



IBS No.	Description
120922	For Taps #0 to 1/2" (3mm to 12mm)
120923	For Taps #1/4" to 3/4" (6mm to 18mm)
120924	For Taps #1/2 to 1-1/8" (12mm to 28mm)

Professional Hex Die Wrench (T03)

- Maintains alignment for accurate, straight threading.
- Dies easily lock in position with set screw



IBS No.	Description
120925	For 1" Hexagon Dies
120926	For 1-7/16 Hexagon Dies

T-Handle Tap Wrench

- Designed for use with taps and on many other tools to be turned by hand.
- Adjusted and tightened to size by twisting knurled nut.
- Sliding T-Wrench Handle.
- Additional holding jaws are recessed and inside hole for trapping onto small sized taps.
- T-Handle may be extended full length in either direction for more leverage.
- Sliding T-handle has spring tension stop.



IBS No.	Description
120920	For Taps #0 to 1/4" (3mm to 6mm)
120921	For Taps #3/16 to 1/2" (4mm to 12mm)

T-Handle Ratcheting Tap Wrenches

- Adjustable T-Handle may be slipped from side to side for positioning convenience and added leverage in tight spaces.
- It can be easily set for left or right handed operation, or locked for non-ratcheting use.
- Available in sizes to fit 1/16" up to 1/2" taps, and in extended lengths up to 12" for hard-to-reach areas.
- Designed for use with taps, reamers, screw extractors and other tools with a square shank.



IBS No.	Description
120930	1/16 -1/4 Ratcheting Tap Wrench
120931	1/4 -1/2 Ratcheting Tap Wrench
120932	1/16 -1/4 x 10 Ratcheting Tap Wrench
120933	1/4 -1/2 x 12 Ratcheting Tap Wrench

Tapping Tool & Guide

Perfect alignment provided for close tolerances and perpendicularity between the hardened sleeve of the tapper and the inside of the tapping guide.

Stops tap breakage.

- Carbonitrided jaws for long life.
- Center drill on stem for floating center.
- Sliding T-Wrench Handle.
- 120° Vees on Aligner Body Base to accept round parts.
- Slotted body serves as wrench for tightening when changing jaws.



IBS No.	Description
17050	Tapping Tool & Guide

T
A
P
S

B
U
R
S

B
L
A
D
E
S



IBS, INCORPORATED

Nitro-Carb Hex Dies P10

Nitro-Carb Hex Dies

T
A
P
S
B
U
R
S
B
L
A
D
E
S

- Hi-Molybdenum tool steel construction for maximum life.
- Nitro-Carburized finish at 950°F to be measurably harder than high speed steel.
- Nitro-Carb dies are designed to last 5 times longer than their carbon steel equivalent.
- Polished gold flats with black surface treated threads for long life and rich appearance.
- Hex configuration allows both wrench and die stock use in threading — more universal than round dies.
- 4-40 through 1/2" have a 1" O.D.; 9/16" through 3/4" have a 1-7/16" O.D.



COARSE THREAD

IBS No.	Thread	Width Across Flats	Die Wrench
129904	4-40	1" Hex	120925
129905	6-32	1" Hex	120925
129906	8-32	1" Hex	120925
129907	10-24	1" Hex	120925
129908	12-24	1" Hex	120925
129909	1/4-20	1" Hex	120925
129910	5/16-18	1" Hex	120925
129911	3/8-16	1" Hex	120925
129912	7/16-14	1" Hex	120925
129913	1/2-13	1" Hex	120925
129914	9/16-12	1-7/16" Hex	120926
129915	5/8-11	1-7/16" Hex	120926
129916	3/4-10	1-7/16" Hex	120926

PIPE THREAD

IBS No.	Thread	Width Across Flats	Die Wrench
129926	1/8 NPT	1" Hex	120925
129927	1/4-18 NPT	1-7/16" Hex	120926



FINE THREAD

IBS No.	Thread	Width Across Flats	Die Wrench
129917	10-32	1" Hex	120925
129918	1/4-28	1" Hex	120925
129919	5/16-24	1" Hex	120925
129920	3/8-24	1" Hex	120925
129921	7/16-20	1" Hex	120925
129922	1/2-20	1" Hex	120925
129923	9/16-18	1-7/16" Hex	120926
129924	5/8-18	1-7/16" Hex	120926
129925	3/4-16	1-7/16" Hex	120926



METRIC THREAD

IBS No.	Thread	Width Across Flats	Die Wrench
129928	M3-.05	1" Hex	120925
135590	M3.5-.60	1" Hex	120925
129929	M4-.07	1" Hex	120925
129930	M5-.08	1" Hex	120925
129931	M6-1.0	1" Hex	120925
129933	M8-1.25	1" Hex	120925
129934	M10-1.5	1" Hex	120925
129935	M12-1.75	1-7/16" Hex	120926

Nitro Carb Hex Dies are sold in packages of 1

IBS, INCORPORATED

Hole Saws & Cutters P28



IBS Carbide Tipped Annular Cutters 1-3/8" & 2" Cutting Depth

IBS carbide tipped annular cutters maximize the cutting performance of any portable magnetic drill press. Their superior "Triple Edge" cutting action outperforms ordinary high speed steel annular cutters and twist drills 6 to 1.

Annular cutters offer an alternative to reaming and can be used in applications where hole saws are limited by depth.

Ideal for making large holes in thick steel.

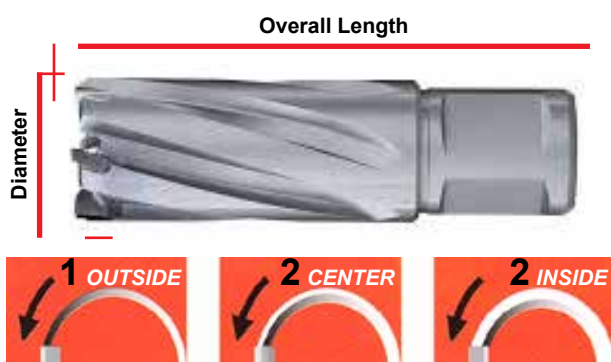

Triple Edge Cutters — Superior ultra-hard tungsten carbide tips, balanced in three different positions permit higher feed rates and increased hole making in structural steel and steel plate.

Features & Benefits:

- Ultra-hard tungsten carbide teeth permit faster cutting even in tough materials and shapes.
- Cut clean, bur-free holes; precision pilot ejects the center as a plug of steel.
- Features "Weldon-style" flats for fast loading and better rigidity.

Applications:

- For use with magnetic drill presses to cut holes in cast iron steel, and ultra-hard or exotic alloys.
- 1-3/8" Cutting Depth — for drilling holes up to 1-3/8" deep and 9/16" to 2-1/16" diameter.
- 2" Cutting Depth — for drilling holes up to 2" deep and 9/16" to 2 1/16" diameter with high precision and speed.
- Produce overlapping and interrupted holes easily.
- Ideal for crescent cuts on pipe ends.



1-3/8" Carbide Tipped 2" Carbide Tipped

IBS No.	Size	Usable Length	IBS No.	Size	Usable Length
19102	9/16	1"	19132	9/16	2"
19103	5/8	1"	19133	5/8	2"
19104	11/16	1"	19134	11/16	2"
19105	3/4	1"	19135	3/4	2"
19106	13/16	1"	19136	13/16	2"
19107	7/8	1"	19137	7/8	2"
19108	15/16	1"	19138	15/16	2"
19109	1	1"	19139	1	2"
19110	1-1/16	1"	19140	1-1/16	2"
19111	1-1/8	1"	19141	1-1/8	2"
19112	1-3/16	1"	19142	1-3/16	2"
19113	1-1/4	1"	19143	1-1/4	2"
19114	1-5/16	1"	19144	1-5/16	2"
19115	1-3/8	1"	19145	1-3/8	2"
19116	1-7/16	1"	19146	1-7/16	2"
19117	1-1/2	1"	19147	1-1/2	2"
19118	1-9/16	1"	19148	1-9/16	2"
19119	1-5/8	1"	19149	1-5/8	2"
19120	1-11/16	1"	19150	1-11/16	2"
19121	1-3/4	1"	19151	1-3/4	2"
19122	1-13/16	1"	19152	1-13/16	2"
19123	1-7/8	1"	19153	1-7/8	2"
19124	1-15/16	1"	19154	1-15/16	2"
19125	2	1"	19155	2	2"
19126	2-1/16	1"	19156	2-1/16	2"

1-3/8" Accessories

2" Accessories

19339	Pilot Pin for 7/16" & 1/2"	19453	Pilot Pin for 7/16" & 1/2"
19345	Pilot Pin for 9/16" or larger	19470	Pilot Pin for 9/16" or larger

All IBS part numbers in **bold print** are stock items
All IBS part numbers not in **bold print** require 1 week lead time

T
A
P
S
B
U
R
S
B
L
A
D
E
S



IBS, INCORPORATED

Hole Saws & Cutters P28

Carbide Tipped Annular Cutter Sets

1" & 2" Cutting Depth
6 Pc Sets

Packaged a Molded Plastic Case for Easy Storage
& Organization



1" CARBIDE TIPPED ANNULAR CUTTER SET
IBS No. 19465

IBS No.	Size	Usable Length
19104	11/16	1"
19106	13/16	1"
19108	15/16	1"
19109	1	1"
19110	1-1/16	1"
19435	Pilot Pin for 1"	



2" CARBIDE TIPPED ANNULAR CUTTER SET
IBS No. 19466

IBS No.	Size	Usable Length
19134	11/16	2"
19136	13/16	2"
19138	15/16	2"
19139	1	2"
19140	1-1/16	2"
19470	Pilot Pin for 2"	

T
A
P
S

B
U
R
S

B
L
A
D
E
S

IBS, INCORPORATED

Hole Saws & Cutters P28



IBS High Speed Steel Annular Cutters

1" & 2" Cutting Depth

IBS High Speed Steel Annular Cutters are made in the USA and are the highest quality cutters available on the market. The exclusive CNC machining and heat treating process used to manufacture IBS cutters provide extreme drilling performance, ensuring longer cutter life and efficient hole drilling, while maintaining precise bore tolerances.



- IBS HSS Annular Cutters come **WITH a pilot pin**, eliminating the need for finding and assembling for improved productivity and faster change-outs, saving time and money.
- **MADE IN THE USA of high quality M2 Steel** for optimum performance for longer life and more cuts in standard steel drilling applications, saving time and money.
- **HSS is non-sensitive to shock or impact** as compared to carbide — making them more durable in applications not requiring carbide.
- Stocked in 1" and 2" depth of cut, (also available NONSTOCK in 3" depth).

PILOT PINS

- Pilot pin included with cutter
- Allow coolant to flow to center of cutter during drilling cycle.
- Eject slug from center of cutter after the drilling cycle.
- Align cutters to desired drilling position.

1" Cutter			2" Cutter		
IBS No.	Size	Usable Length	IBS No.	Size	Usable Length
19396	7/16	1"	19426	7/16	2"
19397	1/2	1"	19427	1/2	2"
19346	9/16	1"	19471	9/16	2"
19347	5/8	1"	19472	5/8	2"
19348	11/16	1"	19473	11/16	2"
19349	3/4	1"	19474	3/4	2"
19350	13/16	1"	19475	13/16	2"
19351	7/8	1"	19476	7/8	2"
19352	15/16	1"	19477	15/16	2"
19353	1	1"	19478	1	2"
19354	1-1/16	1"	19479	1-1/16	2"
19355	1-1/8	1"	19480	1-1/8	2"
19356	1-3/16	1"	19481	1-3/16	2"
19357	1-1/4	1"	19482	1-1/4	2"
19358	1-5/16	1"	19483	1-5/16	2"
19359	1-3/8	1"	19484	1-3/8	2"
19360	1-7/16	1"	19485	1-7/16	2"
19361	1-1/2	1"	19486	1-1/2	2"
19362	1-9/16	1"	19487	1-9/16	2"
19363	1-5/8	1"	19488	1-5/8	2"
19364	1-11/16	1"	19489	1-11/16	2"
19365	1-3/4	1"	19490	1-3/4	2"
19366	1-13/16	1"	19491	1-13/16	2"
19367	1-7/8	1"	19492	1-7/8	2"
19368	1-15/16	1"	19493	1-15/16	2"
19369	2	1"	19494	2	2"
19370	2-1/16	1"	19495	2-1/16	2"

1" Accessories		2" Accessories	
19339	Pilot Pin for 7/16" & 1/2"	19453	Pilot Pin for 7/16" & 1/2"
19345	Pilot Pin for 9/16" or large	19470	Pilot Pin for 9/16" or larger

T
A
P
S
B
U
R
S
B
L
A
D
E
S



IBS, INCORPORATED

Hole Saws & Cutters P15

IBS High Speed Steel Annular Cutter 6 & 12 Pc Sets

1" & 2" Cutting Depth

Packaged in a Molded Plastic Case for Easy Storage & Organization



6 PC 1" IBS HSS ANNULAR CUTTER SET
IBS No. 19420

IBS No.	Size	Usable Length
19346	9/16	1"
19348	11/16	1"
19350	13/16	1"
19352	15/16	1"
19354	1-1/16	1"
19345	Pilot Pin for 9/16 or larger	



6 PC 2" IBS HSS ANNULAR CUTTER SET
IBS No. 19422

IBS No.	Size	Usable Length
19471	9/16	2"
19473	11/16	2"
19475	13/16	2"
19477	15/16	2"
19479	1-1/16	2"
19470	Pilot Pin for 9/16 or larger	



12 PC 1" IBS HSS ANNULAR CUTTER SET
IBS No. 19421

IBS No.	Size	Usable Length
19396	7/16	1"
19397	1/2	1"
19346	9/16	1"
19347	5/8	1"
19348	11/16	1"
19349	3/4	1"
19350	13/16	1"
19351	7/8	1"
19352	15/16	1"
19353	1	1"
19354	1-1/16	1"
19339	Pilot Pin for 7/16" & 1/2"	
19345	Pilot Pin for 9/16 or larger	



12 PC 2" IBS HSS ANNULAR CUTTER SET
IBS No. 19423

IBS No.	Size	Usable Length
19426	7/16	2"
19427	1/2	2"
19471	9/16	2"
19472	5/8	2"
19473	11/16	2"
19474	3/4	2"
19475	13/16	2"
19476	7/8	2"
19477	15/16	2"
19478	1"	2"
19479	1-1/16	2"
19453	Pilot Pin for 7/16" & 1/2"	
19470	Pilot Pin for 9/16 or larger	

T
A
P
S

B
U
R
S

B
L
A
D
E
S



M42 THIN WALL HOLE SAWS

IBS No.	Description
29290	3/4" M42 Thin Wall Hole Saw
29291	7/8" M42 Thin Wall Hole Saw
29292	1" M42 Thin Wall Hole Saw
29293	1-1/8" M42 Thin Wall Hole Saw
29294	1-1/4" M42 Thin Wall Hole Saw
29295	1-3/8" M42 Thin Wall Hole Saw
29296	1-1/2" M42 Thin Wall Hole Saw
4CREDIT	Used Trade-A-Blade Credit

- Innovative Design** — Impact rated hole cutter makes these far more aggressive at cutting sheet metal and other thin metals. Rated for impact tools and coupled with thin all, these cut many times faster than a standard hole saw or special sheet metal hole cutter like the slugger.
- 1/4" Hex Shank Quick Change Versatility** — Can be used with a wide range of air, corded or cordless tools, including impact tools. Can be used with hex shank adaptors, quick releases and extensions.
- Thin Wall** — The thin wall 3TPI design makes these hole saws cut extremely fast compared to other hole saws that have to remove more material due to the thicker wall design. They leave a burr-free cut that is faster and cleaner than standard bi-metal hole saws.
- M42 Bi-Metal with 8% Cobalt** — M42 Bi-Metal with Cobalt has increased wear resistance and added tooth strength. This combination has proven to be excellent for steel and metal cutting applications across several platforms (bandsaw, recip, etc.). M42 Bi-Metal is highly resistant to wear or breakage so it stays sharp longer and provides a fast cutting over a long life.
- Built-in pilot drill with spring** for immediate slug ejection — unlike most hole saws that require effort after the cut to remove the slug, the ejection spring makes slug removal fast and effortless, boosting productivity.
- Stop shoulder design** has built-in collar to prevent the saw from over-drilling or popping through the work — preventing damage to things like electrical wires and components when drilling through existing panels in service equipment.
- Optimized for applications in thin gauge metal** up to 1/8" thick.

NOTE: Our Trade-a-Blade™ system is simple! The Trade-a-Blade™ system rewards our users by giving them a 'Trade Credit' toward the purchase of another Trade-a-Blade™ product. This is an easy and a cost effective way for customers to save money.

Receive a \$4 credit toward the purchase of a new M42 Thin Wall Hole Saw when turning in a used one.

Limit - One \$4 credit for each new M42 Thin Wall Hole Saw purchased.

The used M42 Thin Wall Hole Saws can be turned into your salesperson for credit when placing an order for a new one. The \$4 credit will be reflected on the invoice with the new M42 Thin Wall Hole Saws.



M42 Thin Wall Hole Saws Travel Tray Assortment

PACKAGED IN A PLASTIC TRAVEL TRAY

IBS No. 820R • 7 Items • 7 Pcs

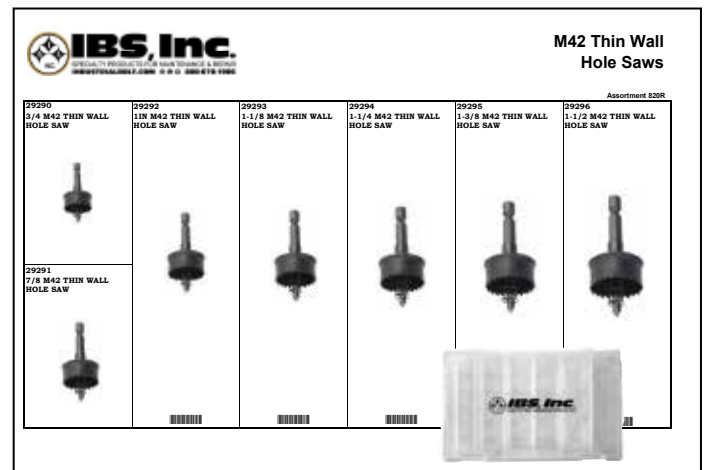

T
A
P
S
B
U
R
S
B
L
A
D
E
S



IBS, INCORPORATED

Hole Saws & Cutters P28

Sheet Metal Slugger Cutters

Thin Metal Cutters

While Supplies Last

Slugger Thin Metal Cutters accurately produce holes in sheet metal, light tubing, rubber, fiber materials and select plastics. Designed for use with hand held drilling equipment.

Slugger Thin Metal Cutters drill up to three times faster than hole saws and have superior tool life. Center-free design eliminates deflection and leaves a smooth bore in work pieces. The arbor system quickly installs to most hand drills, accepting a full range of cutters. Cutters lock securely into the arbor, replacing inaccurate older style thread-on tools.

Applications include: HVAC, PHCC, electrical and maintenance work.



T
A
P
S

B
U
R
S

B
L
A
D
E
S

COMPARE THIN METAL SLUGGER CUTTERS TO HOLE SAWS:

- Drills holes three times faster than hole saws, saving time and money.
- Cuts the outer "slug" of a hole, giving superior tool life compared to standard drills.
- Does not bore out a hole for a cleaner and more accurate hole finish.
- Precision ground teeth for sharper, cleaner cuts.
- Reduced grabbing and tearing means minimum material deformation and a hole requiring less finishing work.

SHEET METAL SLUGGER CUTTERS

IBS No.	Diameter	Decimal Equiv.	Depth Cut	Qty
29191	3/8	.3750	1/4	1
29195	5/8	.6250	1/4	1



SLUGGER CUTTER ACCESSORIES

IBS No.	Description
29075	Pilot Pin
14993	3mm Hex Key (L01)



Carbide Tipped Cutters

For Thin Steel Applications — Up to 3/16" Thick

The fastest and smoothest way to cut holes in thin steel, these carbide tipped hole saws are the perfect workmate for the professional electrician, plumber, mechanic and general contractor.



Features & Benefits:

- **Built-in ejector spring and pilot drill** — for quick smooth discharge of metal slug and optimal productivity.
- **Special Tungsten Carbide Teeth** provide increased wear resistance resulting in a saw that will **outlast and outperform** traditional bi-metal saws, step drills, and other tools by as much as **10 to 1**.
- **Carbide Teeth Cut Clean** — which means less resistance and up to three times less energy drained when using a cordless drill, for more cuts in a charge — saving time and money.
- **Safety Collar Stop** — prevents over penetration of the work piece and provides better rigidity for clean, bur-free cutting with quicker and easier removal.
- **One Piece Construction** —for stable, accurate cutting, resulting in crisp cuts without burs.

Applications:

- **Quickly cuts holes in materials up to 3/16" thick**
Thin Steel Plate Iron
Aluminum Copper
Cast Iron Stainless Steel
- **Cleanly cuts holes (9/16 up to 5" diameter) in:**
Junction Boxes Switch Boxes
Metal Studs Electrical Appliances
Lighting Fixtures Pipe
Ideal for auto, truck & body repair
- **Producing overlapping and uninterrupted holes easily.**

CARBIDE TIPPED CUTTERS CUTS 3/16" DEPTH

Includes Hole Saw, Arbor and Pilot Drill

IBS No.	Shank	Cut	IBS No.	Shank	Cut
19200	3/8"	9/16	19226	3/8"	2-3/16
19201	3/8"	5/8	19227	3/8"	2-1/4
19202	3/8"	11/16	19228	3/8"	2-5/16
19203	3/8"	3/4	19229	3/8"	2-3/8
19204	3/8"	13/16	19230	3/8"	2-7/16
19205	3/8"	7/8	19231	3/8"	2-1/2
19206	3/8"	15/16	19232	3/8"	2-9/16
19207	3/8"	1	19233	3/8"	2-5/8
19208	3/8"	1-1/16	19234	1/2"	2-11/16
19209	3/8"	1-1/8	19235	1/2"	2-3/4
19210	3/8"	1-3/16	19236	1/2"	2-13/16
19211	3/8"	1-1/4	19237	1/2"	2-7/8
19212	3/8"	1-5/16	19238	1/2"	2-5/16
19213	3/8"	1-3/8	19239	1/2"	3
19214	3/8"	1-7/16	1923902	1/2"	3-1/4
19215	3/8"	1-1/2	1923903	1/2"	3-3/8
19216	3/8"	1-9/16	1923904	1/2"	3-1/2
19217	3/8"	1-5/8	1923906	1/2"	3-3/4
19218	3/8"	1-11/16	1923908	1/2"	4
19219	3/8"	1-3/4	1923909	1/2"	4-1/8
19220	3/8"	1-13/16	1923910	1/2"	4-1/4
19221	3/8"	1-7/8	1923912	1/2"	4-1/2
19222	3/8"	1-15/16	1923913	1/2"	4-3/4
19223	3/8"	2	1923914	1/2"	5
19224	3/8"	2-1/16			
19225	3/8"	2-1/8			

CT CUTTERS™ 3/16" Depth ACCESSORIES

19240	Pilot Drill
19241	Ejector Spring - 3/16" Depth
19242	Pilot Drill - Carbide Tipped for Ductile Pipe



IBS, INCORPORATED

Hole Saws & Cutters P28

Carbide Tipped Hole Cutters For Thick Steel Applications Up to 1" Thick

The ultimate way to cut holes in thick steel, this long tip carbide hole saw is the new "Contractor's Helper." Cutting quick, accurate holes in pipe or drilling through thick steel are no longer a problem with the triple edge cutting power of our Carbide Tipped Hole Cutters.



Features & Benefits:

- **Built-in ejector spring and pilot drill** — for quick smooth discharge of metal slug and optimal productivity.
- **Special Tungsten Carbide Teeth** provide increased wear resistance resulting in a saw that will **outlast and outperform** traditional bi-metal saws, step drills, and other tools by as much as **10 to 1**.
- **Carbide Teeth Cut Clean** — which means less resistance and up to three times less energy drained when using a cordless drill, for more cuts in a charge — saving time and money.
- **Safety Collar Stop** — prevents over penetration of the work piece and provides better rigidity for clean, bur-free cutting with quicker and easier removal.
- **One Piece Construction** —for stable, accurate cutting, resulting in crisp cuts without burs.

Applications:

- **Quickly cuts holes in materials up to 1" thick**
 - Thin Steel Plate Iron
 - Aluminum Copper
 - Cast Iron Stainless Steel
- **Cleanly cuts holes (9/16 up to 3" diameter) in:**
 - Junction Boxes Switch Boxes
 - Metal Studs Electrical Appliances
 - Lighting Fixtures Pipe
 - Ideal for auto, truck & body repair
- **Producing overlapping and uninterrupted holes easily.**

CARBIDE TIPPED HOLE CUTTERS CUTS 1" DEPTH

Includes Hole Saw, Arbor and Pilot Drill

IBS No.	Shank	Cut	IBS No.	Shank	Cut
19249	3/8"	9/16	19265	3/8"	1-9/16
19250	3/8"	5/8	19266	3/8"	1-5/8
19251	3/8"	11/16	19267	3/8"	1-11/16
19252	3/8"	3/4	19268	3/8"	1-3/4
19253	3/8"	13/16	19269	3/8"	1-13/16
19254	3/8"	7/8	19270	3/8"	1-7/8
19255	3/8"	15/16	19271	3/8"	1-15/16
19256	3/8"	1	19272	3/8"	2
19257	3/8"	1-1/16	1927201	3/8"	2-1/8
19258	3/8"	1-1/8	1927202	3/8"	2-1/4
19259	3/8"	1-3/16	1927203	3/8"	2-3/8
19260	3/8"	1-1/4	1927204	3/8"	2-1/2
19261	3/8"	1-5/16	1927205	3/8"	2-5/8
19262	3/8"	1-3/8	1927206	3/8"	2-3/4
19263	3/8"	1-7/16	1927207	3/8"	2-7/8
19264	3/8"	1-1/2	1927208	1/2"	3

HOLE CUTTER™ 1" Depth ACCESSORIES

19273	Pilot Drill
19274	Ejector Spring - 1" Depth
19275	Pilot Drill - Carbide Tipped for Ductile Pipe

Cutter Extensions

- Extends the Carbide Tipped Hole Cutters by 4", giving access to hard-to-reach places.
- Made of precision machined tool steel for durability, stability and longer life.
- Only 2 extensions required to cover all sizes — less inventory means lower costs.



IBS No.	Description
192421	4" x 10mm Hole Cutter Extension
192422	4" x 13mm Hole Cutter Extension

T
A
P
S

B
U
R
S

B
L
A
D
E
S













5 Pc. Carbide Tipped Cutters

3/16" DEPTH

IBS No. 762R • 5 Items • 5 Pcs

Packaged in a Locking steel drawer for easy storage & organization









		Carbide Tipped Cutters 3/16" Depth Assortment No. 762R	
19205 7/8 CARBIDE TIPPED CUTTER - 3/16" DEPTH  	19209 1-1/8 CARBIDE TIPPED CUTTER - 3/16" DEPTH  	19213 1-3/8 CARBIDE TIPPED CUTTER - 3/16" DEPTH  	19219 1-3/4 CARBIDE TIPPED CUTTER - 3/16" DEPTH  
19223 2" CARBIDE TIPPED CUTTER - 3/16" DEPTH  			

4 Pc. Carbide Tipped Cutters

1" DEPTH

IBS No. 763R • 4 Items • 4 Pcs

Packaged in a Locking steel drawer for easy storage & organization

		Carbide Tipped Cutters 1" Depth Assortment No. 763R	
19250 5/8 CARBIDE TIPPED CUTTER - 1" DEPTH  	19252 3/4 CARBIDE TIPPED CUTTER - 1" DEPTH  	19254 7/8 CARBIDE TIPPED CUTTER - 1" DEPTH  	19256 1" CARBIDE TIPPED CUTTER - 1" DEPTH  

T
A
P
S

B
U
R
S

B
L
A
D
E
S



IBS, INCORPORATED

Assortments Z02

5 Pc. Carbide Tipped Cutters 1" DEPTH











IBS No. 764R • 5 Items • 5 Pcs

Packaged in a locking steel drawer for easy storage & organization

T
A
P
S

B
U
R
S

B
L
A
D
E
S

 IBS, Inc. <small>SPECIALTY PRODUCTS FOR MAINTENANCE & REPAIR INDUSTRIALBOLT.COM © © © 800-678-1506</small>		Carbide Tipped Cutters 1" Depth	
<small>Assortment No. 764R</small>			
19254 7/8 CARBIDE TIPPED CUTTER - 1" DEPTH  	19258 1-1/8 CARBIDE TIPPED CUTTER - 1" DEPTH  	19262 1-3/8 CARBIDE TIPPED CUTTER - 1" DEPTH  	19268 1-3/4 CARBIDE TIPPED CUTTER - 1" DEPTH  
19272 2" CARBIDE TIPPED CUTTER - 1" DEPTH  			

Carbide Tipped Cutter Sets (P28)



CARBIDE TIPPED CUTTER SET
3/16" Depth 5 Pcs

IBS No.	Description
19280	7/8, 1-1/8, 1-3/8, 1-3/4, & 2"



CARBIDE TIPPED CUTTER SET
1" Depth 4 Pcs

IBS No.	Description
19281	5/8, 3/4, 7/8, & 1"



CARBIDE TIPPED CUTTER SET
1" Depth 5 Pcs

IBS No.	Description
19283	7/8, 1-1/8, 1-3/8, 1-3/4, & 2"



Magnetic Drill Press

- The optimal drilling speed designed for use with carbide and HSS cutters on the toughest jobs and applications.
- Effective solution for drilling harder materials
- Powerful magnet for easier placement and better holding power on thinner material.
- Cost effective drill for running with Carbide cutters for longer life, higher cutting rate and capable of cutting harder materials.
- 1-3/8" maximum diameter annular cutter.
- 2" maximum drilling depth.
- 15.75" Height, 1100W, 11.5 Amp, 450-590 RPM.



IBS No.	Description
19467	Magnetic Drill Press up to 1-3/8 - 2"
19456	Arbor Adapter
19457	Drill Chuck

Compact Magnetic Drill Press

Compact with Fixed Drill Motor for Work in Confined Spaces

- **Extremely compact** with ideal power to weight ratio for work at heights and in confined spaces.
- **Hand feed wheel mounts** on either side for use in special situations.
- **Die cast aluminum housing** for strength in the field.
- **Internal motor cable routing** prevents unintended threading or hanging up on the work-piece.
- Internal Cooling.
- **Easy** guide adjustment.
- **Stationary** drill motor.
- **Quill feed spindle** eliminates field maintenance and adjustments provides positive slug ejection.
- 1-5/8 maximum diameter annular cutter.
- 2" maximum drilling depth.



IBS No.	Description
19468	Compact Magnetic Drill Press for 1-3/8 - 2"

Variable Speed / Reversible Magnetic Drill Press

Universal with 2 Speed Gearbox

For Use with 1-9/16 to 2" Annular Cutters

Compact with high functionality for universal use on the construction site and in the workshop.

- Simple and error-proof control concept in the operator's field of view.
- **Double drill motor guides** enable use of the largest core bits.
- **Reversible.**
- **Electronic speed control.**
- **High power motor** with stable speed.
- **High magnetic holding force.**
- Convenient magnetic holding force gauge.
- **Integrated cooling tank.**
- **Hand feed wheel** can be mounted on either side.



IBS No.	Description
19469	Variable Speed / Reversible Magnetic Drill Press

Slugger Cutting Fluid for Mag Drills



- Water soluble concentrate makes up to 10 quarts of cutting fluid.
- Improves surface finish and reduces heat build up when drilling — extending the life of the cutter.
- Specially designed packaging with a sight window ensures proper mixing ratios.

IBS No.	Description
19463	Slugger Cutting Fluid for Mag Drills 1 Quart
19464	Slugger Cutting Fluid for Mag Drills 1 Gallon

T
A
P
S

B
U
R
S

B
L
A
D
E
S



IBS, INCORPORATED

Hole Saws & Cutters P28

T
A
P
S

B
U
R
S

B
L
A
D
E
S

Ultra Lube Super Premium Cutting Fluid (S04)



Ultra Lube is a multi-purpose cutting fluid specially formulated to extend tool life and reduce chip welding. **Ultra Lube** also provides precision finish with closer tolerances on finished work.

- **Super concentrated formula** will not run and even clings to vertical surfaces keeping the lubricant on the tool or at the or at the drilling/cutting point for continual lubrication resulting in cooler cutting which means longer tool life, saving time and money.
- **Contains no harsh chemicals or ozone depleting chemicals** which provides a virtual smoke free operation on even the most heat prone applications for a safer, cleaner cut making for faster clean up.
- **Available in a small, easier to handle 4 oz. bottle for hand drilling applications** that is easier to apply and get the lubricant exactly where it's needed, saving user time and money.
- **16 oz. bottle perfect for larger jobs** and coolant reservoir filling.

IBS No.	Description
96050	Ultra Lube Cutting Fluid 4 oz. bottle
96070	Ultra Lube Cutting Fluid 16 oz. bottle

Rapid Core™ Ejecting Hole Saw Arbors



Our Rapid Core Ejecting Hole Saw Arbors make cutting holes a snap. This new design eliminates the need for a screwdriver or knife to dig out the core after drilling your hole. These arbors take efficiency to a whole new level.

- **Drop out the core** with the touch of the button.
- Saves time, money and eliminates the hassle of plug removal
- Delivers immediate and effortless plug removal
- Enlarge holes that are too small
- Extend pilot drill length to cut at an angle
- Durable high-speed pilot bits

Pilot Drill Bits

Rapid Core™ Ejecting Hole Saw Arbors



- Use with Rapid Core ejecting Holes Saw Arbors
- Smooth cuts even at slow speed
- Delivers immediate and effortless plug removal.

IBS No.	Description	Qty
29050	Rapid Core Ejecting Arbor for 1-1/4" to 6" dia. Hole Saws 10mm (7/16") Hex Shank	1
29051	Rapid Core Ejecting Arbor for 9/16 to 1-3/16" dia. Hole Saws 8mm (5/16") Hex Shank	1
29052	Pilot Drill Bit for 29050 Hole Saw Arbor	1
29053	Pilot Drill Bit for 29051 Hole Saw Arbor	1

IBS, INCORPORATED

Hole Saws & Cutters P28



Advanced Bi-Metal Hole Saws



Our Bi-Metal Advanced Hole Saws feature new developments in tooth design and a new manufacturing process that outperforms the competition. All IBS mandrels are interchangeable with other name brands.

- **Patent pending tooth set is designed to remove material faster** providing smoother and faster cuts saving time and money.
- **Increased cutting depth of 1-15/16** means professional users can still cut through 2x4's in one pass and other thicker applications other hole saws require multiple cuts, saving time and money.
- **Wider cap design and thicker side wall** reduces runout, vibration and prevents collapsing.
- **Innovative angled side slots provide increased leverage** for faster and easier slug removal – saving time and money.
- **Premium M42 high speed steel cutting edge with 8% cobalt** results in twice the life of other hole saws for superior life and value.
- **Made in the USA**

Applications include: steel plate, pipe (round or square), angle iron, wood, composite materials and plastics.



ADVANCED BI-METAL HOLE SAWS

IBS No.	Dia.	Arbor	IBS No.	Dia.	Arbor
29200	9/16	29036	29226	2-5/16	29034
29201	5/8	29036	29227	2-3/8	29034
29203	3/4	29036	29228	2-1/2	29034
29204	13/16	29036	29229	2-9/16	29034
29205	7/8	29036	29230	2-5/8	29034
29206	15/16	29036	29231	2-3/4	29034
29207	1"	29036	29232	2-7/8	29034
29208	1-1/16	29036	29233	3"	29034
29209	1-1/8	29036	29234	3-1/8	29034
29210	1-3/16	29036	29235	3-1/4	29034
29211	1-1/4	29034	29236	3-3/8	29034
29212	1-5/16	29034	29237	3-1/2	29034
29213	1-3/8	29034	29238	3-5/8	29034
29214	1-7/16	29034	29239	3-3/4	29034
29215	1-1/2	29034	29240	3-7/8	29034
29216	1-9/16	29034	29241	4"	29034
29217	1-5/8	29034	29242	4-1/8	29034
29218	1-11/16	29034	29243	4-1/4	29034
29219	1-3/4	29034	29245	4-1/2	29034
29220	1-13/16	29034	29246	4-3/4	29034
29221	1-7/8	29034	29247	5"	29034
29222	2"	29034	29248	5-1/2	29034
29223	2-1/16	29034	29249	6	29034
29224	2-1/8	29034			
29225	2-1/4	29034			



29070



29036



29034



29039

HOLE SAW ARBOR ADAPTER

IBS No.	Description
29070	Allows arbors with 1/2-20 thread to use saws with 5/8-18 thread. Use with 1-9/16" through 6" hole saws.

HOLE SAW ARBORS

IBS No.	Shank	Shape	Thread
29034	7/16	Hex	5/8-18
29036	1/4	Round	1/2-20

HOLE SAW ARBOR PILOT DRILL

IBS No.	Description
29039	Hole Saw Arbor Replacement Drill

T
A
P
S

B
U
R
S

B
L
A
D
E
S



IBS, INCORPORATED

Assortments Z02

T
A
P
S

B
U
R
S

B
L
A
D
E
S













Advanced Bi-Metal Hole Saws 5/8" - 2"

With Rapid Core Ejecting Arbor

IBS No. 782R • 14 Items • 14 Pcs

Packaged in a locking steel drawer for easy storage & organization

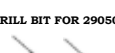

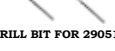
29201 5/8 HOLE SAW ADVANCED EDGE 	29209 1-1/8 HOLE SAW ADVANCED EDGE 	29217 1-5/8 HOLE SAW ADVANCED EDGE 	29050 RAPID CORE EJECTING ARBOR FOR 1-1/4 TO 6 HOLE SAWS 
29203 3/4 HOLE SAW ADVANCED EDGE 	29211 1-1/4 HOLE SAW ADVANCED EDGE 	29219 1-3/4 HOLE SAW ADVANCED EDGE 	29051 RAPID CORE EJECTING ARBOR FOR 9/16 - 1-3/16 DIAM HOLE SAWS 
29205 7/8 HOLE SAW ADVANCED EDGE 	29213 1-3/8 HOLE SAW ADVANCED EDGE 	29222 2" HOLE SAW ADVANCED EDGE 	29052 PILOT DRILL BIT FOR 29050 
29207 1" HOLE SAW ADVANCED EDGE 	29215 1-1/2 HOLE SAW ADVANCED EDGE 		29053 PILOT DRILL BIT FOR 29051 

Advanced Bi-Metal Hole Saws 5/8" to 2"

with Rapid Core Ejecting Arbors

Assortment No. 782R









Advanced Bi-Metal Hole Saws 2-1/8" - 4"

With Rapid Core Ejecting Arbor

IBS No. 783R • 8 Items • 8 Pcs

Packaged in a locking steel drawer for easy storage & organization



29224 2-1/8 HOLE SAW ADVANCED EDGE 	29228 2-1/2 HOLE SAW ADVANCED EDGE 	29237 3-1/2 HOLE SAW ADVANCED EDGE 	29050 RAPID CORE EJECTING ARBOR FOR 1-1/4 TO 6 DIAM. HOLE SAWS 
29225 2-1/4 HOLE SAW ADVANCED EDGE 	29233 3" HOLE SAW ADVANCED EDGE 	29241 4" HOLE SAW ADVANCED EDGE 	29052 PILOT DRILL FOR 29050 

Advanced Bi-Metal Hole Saws 2-1/8" to 4"

with Rapid Core Ejecting Arbors

Assortment No. 783R

















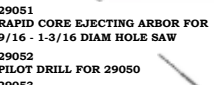

Advanced Bi-Metal Hole Saws 3/4" - 4"

With Rapid Core Ejecting Arbor

IBS No. 784R • 18 Items • 18 Pcs

Packaged in a locking steel drawer for easy storage & organization



29203 3/4 HOLE SAW ADVANCED EDGE 	29217 1-5/8 HOLE SAW ADVANCED EDGE 	29225 2-1/4 HOLE SAW ADVANCED EDGE 	29241 4" HOLE SAW ADVANCED EDGE 
29207 1" HOLE SAW ADVANCED EDGE 	29219 1-3/4 HOLE SAW ADVANCED EDGE 	29228 2-1/2 HOLE SAW ADVANCED EDGE 	29050 RAPID CORE EJECTING ARBOR 1-1/4 - 6 DIAM HOLE SAW 
29209 1-1/8 HOLE SAW ADVANCED EDGE 	29222 2" HOLE SAW ADVANCED EDGE 	29233 3" HOLE SAW ADVANCED EDGE 	29051 RAPID CORE EJECTING ARBOR FOR 9/16 - 1-3/16 DIAM HOLE SAW 
29211 1-1/4 HOLE SAW ADVANCED EDGE 	29224 2-1/8 HOLE SAW ADVANCED EDGE 	29237 3-1/2 HOLE SAW ADVANCED EDGE 	29052 PILOT DRILL FOR 29050 
29213 1-3/8 HOLE SAW ADVANCED EDGE 			29053 PILOT DRILL FOR 29051 
29215 1-1/2 HOLE SAW ADVANCED EDGE 			

Advanced Bi-Metal Hole Saws 3/4" to 4"

with Rapid Core Ejecting Arbors

Assortment No. 784R

IBS, INCORPORATED

Assortments Z02



Advanced Bi-Metal Hole Saws 5/8" - 2"

IBS No. 729R • 14 Items • 14 Pcs

Packaged in a locking steel drawer for easy storage & organization

IBS, Inc. SPECIALTY PRODUCTS FOR MAINTENANCE & REPAIR INDUSTRIALBOLT.COM • 800-678-1906			Advanced Bi-Metal Hole Saws 5/8" to 2"	
Assortment No. 729R				
29201 5/8 HOLE SAW ADVANCED EDGE	29209 1-1/8 HOLE SAW ADVANCED EDGE	29217 1-5/8 HOLE SAW ADVANCED EDGE	29036 LSS 4 H.S. ARBOR	
29203 3/4 HOLE SAW ADVANCED EDGE	29211 1-1/4 HOLE SAW ADVANCED EDGE	29219 1-3/4 HOLE SAW ADVANCED EDGE	29034 LSS 2 H.S. ARBOR	
29205 7/8 HOLE SAW ADVANCED EDGE	29213 1-3/8 HOLE SAW ADVANCED EDGE	29222 2" HOLE SAW ADVANCED EDGE	29039 1/4 PILOT DRILL	
29207 1" HOLE SAW ADVANCED EDGE	29215 1-1/2 HOLE SAW ADVANCED EDGE			

Advanced Bi-Metal Hole Saws 2-1/8" - 4"

IBS No. 730R • 8 Items • 8 Pcs

Packaged in a locking steel drawer for easy storage & organization

IBS, Inc. SPECIALTY PRODUCTS FOR MAINTENANCE & REPAIR INDUSTRIALBOLT.COM • 800-678-1906			Advanced Bi-Metal Hole Saws 2-1/8" to 4"	
Assortment No. 730R				
29224 2-1/8 HOLE SAW ADVANCED EDGE	29228 2-1/2 HOLE SAW ADVANCED EDGE	29237 3-1/2 HOLE SAW ADVANCED EDGE	29034 LSS 2 H.S. ARBOR	
29225 2-1/4 HOLE SAW ADVANCED EDGE	29233 3" HOLE SAW ADVANCED EDGE	29241 4" HOLE SAW ADVANCED EDGE	29039 1/4 PILOT DRILL	

Advanced Bi-Metal Hole Saws 3/4" - 4"

IBS No. 731R • 18 Items • 18 Pcs

Packaged in a locking steel drawer for easy storage & organization

IBS, Inc. SPECIALTY PRODUCTS FOR MAINTENANCE & REPAIR INDUSTRIALBOLT.COM • 800-678-1906			Advanced Bi-Metal Hole Saws 3/4" to 4"	
Assortment No. 731R				
29203 3/4 HOLE SAW ADVANCED EDGE	29217 1-5/8 HOLE SAW ADVANCED EDGE	29225 2-1/4 HOLE SAW ADVANCED EDGE	29237 3-1/2 HOLE SAW ADVANCED EDGE	
29207 1" HOLE SAW ADVANCED EDGE	29219 1-3/4 HOLE SAW ADVANCED EDGE	29228 2-1/2 HOLE SAW ADVANCED EDGE	29241 4" HOLE SAW ADVANCED EDGE	
29209 1-1/8 HOLE SAW ADVANCED EDGE	29222 2" HOLE SAW ADVANCED EDGE	29233 3" HOLE SAW ADVANCED EDGE	29036 LSS 4 H.S. ARBOR	
29211 1-1/4 HOLE SAW ADVANCED EDGE	29224 2-1/8 HOLE SAW ADVANCED EDGE		29034 LSS 2 H.S. ARBOR	
29213 1-3/8 HOLE SAW ADVANCED EDGE			29039 1/4 PILOT DRILL	
29215 1-1/2 HOLE SAW ADVANCED EDGE				

TAPS
BURS
BLADES



IBS, INCORPORATED

Assortments Z02

T
A
P
S

B
U
R
S

B
L
A
D
E
S

Advanced Bi-Metal Hole Saws Industrial Kit

IBS No. 29282 • 15 Items • 15 Pcs (P28)
Packaged in a molded plastic case



IBS No.	Description
29282	Advanced Hole Saw Industrial Kit - 15 pcs Sizes: 3/4, 7/8, 1", 1-1/4, 1-3/8, 1-1/2, 1-3/4, 2, 2-1/4, 2-1/2", 3" plus 2 arbors & pilot drills and 1 ejector spring

Advanced Bi-Metal Hole Saws Master Electricians Kit

IBS No. 29283 • 13 Items • 13 Pcs (P28)
Packaged in a metal case



IBS No.	Description
29283	Advanced Hole Saw Kit - Master Electrician 13 pcs Sizes: 7/8, 1-1/8, 1-3/8, 1-3/4, 2, 2-1/2, 3, 3-5/8, 4-1/8, 4-1/2" plus 3 arbors with pilot drills

IBS, INCORPORATED

Hole Saws & Cutters P28



Hole Saw Recommended RPM Cutting Speeds

Size (Inches)	Aluminum	Brass	Mild Steel	Cast Iron	Tool & Stainless Steel
9/16	900	790	580	400	300
5/8	825	730	550	365	275
11/16	750	665	500	330	250
3/4	690	600	460	300	230
13/16	635	560	425	280	210
7/8	585	520	390	260	195
15/16	555	495	370	245	185
1	525	470	350	235	175
1-1/16	480	435	325	215	160
1-1/8	450	400	300	200	150
1-3/16	425	380	285	190	145
1-1/4	410	360	275	180	140
1-5/16	390	345	260	175	135
1-3/8	375	330	250	165	125
1-7/16	360	315	240	160	120
1-1/2	345	300	230	150	115
1-9/16	330	290	220	145	110
1-5/8	315	280	210	140	105
1-11/16	305	270	205	135	100
1-3/4	295	260	195	130	95
1-13/16	285	250	190	125	95
1-7/8	270	240	180	120	90
2	255	230	170	115	85
2-1/16	245	220	165	110	80
2-1/8	240	210	160	105	80
2-1/4	225	200	150	100	75
2-5/16	225	195	145	100	75
2-3/8	220	190	140	95	70
2-1/2	205	180	135	90	65
2-9/16	200	175	130	85	65
2-5/8	195	170	130	85	65
2-3/4	185	160	125	80	60
2-7/8	180	160	120	80	60
3	170	150	115	75	55
3-1/8	165	140	110	70	55
3-1/4	155	140	105	70	50
3-3/8	150	130	100	65	50
3-1/2	145	130	95	65	45
3-5/8	140	120	95	60	45
3-3/4	135	120	90	60	45
3-7/8	135	120	90	60	45
4	130	110	85	55	40
4-1/8	120	110	80	55	40
4-1/4	120	110	80	55	40
4-3/8	120	100	80	50	40
4-1/2	105	100	75	50	35

Note: When sawing ferrous metals, always use a cutting fluid to insure smooth operations and prolong saw life. (Do not use cutting fluids with cast iron.)

T
A
P
S

B
U
R
S

B
L
A
D
E
S



IBS, INCORPORATED

Circular Saw Blades P11

T
A
P
S
B
U
R
S
B
L
A
D
E
S

Heavy Duty 7-1/4 Blade Deck & Nail Circular Saw Blade

Designed with specially formulated carbide tips to ensure a long cutting life in pressure treated lumber, recycled lumber, decking and flooring with hidden or embedded nails. This blade also features a reinforced shoulder design, heat vents, expansion slots, and fits various 7-1/4" portable saws, including worm drives. This blade is very popular with contractors due to its rugged design and fast cutting ability.

Ideal for Pressure Treated Lumber, Hardy Board® and concrete coated lumber — this blade will even cut nails!

FEATURES:

- Thin Kerf for Fast Cuts
- Professional Grade Carbide Construction
- Reinforced Shoulder
- Aggressive Hook Angle
- Heat Vents for Cooler Operation
- Precision Ground Carbide Tips



IBS No.	Description	Arbor	Grind
72518	7-1/4 X 18T Deck & Nail	5/8 ◊	ATB

Steel & Ferrous Metal Circular Saw Blade

Designed with a durable C-6 carbide grade and triple chip tooth grind to ensure a long cutting life in ferrous metals, such as: steel studs, angle iron, pipe, rebar, channel, flat stock, conduit and much more. Can also be used for cutting non-ferrous metals, such as aluminum, copper, and brass. Specially formulated micro grain carbide tips with titanium and tantalum last longer and leave a burr free cut with little to no sparks or dust commonly associated with abrasives. This blade cuts 5 to 10 times faster and lasts up to 30 times longer than abrasives, allowing fewer blade changes and increased production.

FEATURES:

- Professional Grade C-6 Carbide Construction
- Precision Ground Carbide Tips
- Tensioned & Hardened Steel Plate
- Surface Ground Steel Plate
- Laser Cut Expansion Slots



IBS No.	Description	Arbor	Carbide	Grind
72536	7-1/4 X 36T Steel & Ferrous Metals	5/8 ◊	C-6	TCG

Wood Cutting Circular Saw Blade

This wood cutting blade has been designed for quick, clean cutting with various portable saws, including worm drives. Ideal for cutting all types of hardwood, softwood, particle board and plywood. The aggressive hook angle and super thin kerf make for fast and easy cutting. Additional features include an anti-kickback tooth design for added safety, and heat vents for cooler operation, resulting in extended blade life. Long-lasting micro grain carbide tips are precision ground to ensure the best possible cut.

FEATURES:

- Super Thin Kerf for Fast Cuts
- Professional Grade C-2 Carbide
- Expansion Slots Prevent Warping
- Anti-Kickback Tooth Design
- Aggressive Hook Angle
- Heat Vents for Cooler Operation.
- Precision Ground Carbide Tips



IBS No.	Description	Arbor	Carbide	Grind
72524	7-1/4 X 24T Wood Cutting	5/8 ◊	C-3	ATB

Novelty Combo Blade

Designed for ripping and cross-cutting all types of hardwood, softwood, particle board and plywood with miter, chop, table and radial arm saws. The 4 & 1 tooth grind features for alternate top bevel teeth and 1 flat top raker with an anti-kickback tooth design. A large gullet space separates each tooth set and helps insure proper chip ejection. The special tooth configuration makes these blades great for both ripping and crosscutting applications.

FEATURES:

- Professional Grade C-4 Carbide Construction
- Precision Ground Carbide Tips
- Positive Hook Angle
- Tensioned and Hardened Steel Plate
- Anti-Kickback Raker Tooth
- Surface Ground Steel Plate



IBS No.	Description	Arbor	Carbide	Grind
10028	10" X 50T Carbide Combo Blade	5/8	C-4	2 & 1



Miter Saw Rip Blade

Designed for ripping all types of hardwood, softwood, and plywood with table and radial arm saw. Features precision ground micro grain carbide tips and copper plugged expansion slots for less noise and vibration. Also features an anti-kickback tooth design, aggressive hook angle, and large gullets, making it great for fast ripping applications.

FEATURES:

- Professional Grade C-4 Carbide Construction
- Copper Plugged Expansion Slots
- Aggressive Hook Angle
- Anti-Kickback Tooth Design
- Precision Ground Carbide Tips
- Tensioned & Hardened Steel Plate Construction
- Surface Ground Steel Plate



IBS No.	Description	Arbor	Carbide	Grind
100210	10" X 24T Carbide Ripping Blade	5/8	C-4	ATB

Miter Saw Blade

This fine-finishing blade has been designed for the cleanest crosscutting of all types of hardwood and soft wood with miter, chop, table and radial arm saws. Features precision ground micro grain carbide tips, for less noise and vibration. Great for cross-cutting applications where a very smooth cut is needed.

FEATURES:

- Professional Grade C-4 Carbide Construction
- Copper Plugged Expansion Slots
- Positive Hook Angle
- Precision Ground Carbide Tips
- Tensioned & Hardened Steel Plate Construction
- Surface Ground Steel Plate



IBS No.	Description	Arbor	Carbide	Grind
100230	10" X 80T Carbide Smooth Cut Blade	5/8	C-4	ATB

T
A
P
S

B
U
R
S

B
L
A
D
E
S



IBS, INCORPORATED

Circular Saw Blades P11

Sluggo Carbide-Tipped Circular & Chop Saw Blades

For Use with Metal Cutting Circular and Chop Saws Only

Sluggo™ industrial quality metal cutting saw blades are the finest blades available for the professional fabricator and metal worker.

- Tungsten Carbide Construction — provides exceptional wear resistance and maximum cutting life.
- Clean cutting — leaves a bur-free cut ready for use or welding. No additional grinding necessary.
- Cool Cutting — unique metallurgy of the carbide tips result in minimum heat transferred to the inner plate. Most of the heat remains with the chips collected in the unique chip collector.
- High Performance — Blades cut much faster than traditional methods saving time, labor and money.

Blades are available for clean and cool cutting of mild steel, stainless steel, and aluminum.



7-1/4" INDUSTRIAL METAL CUTTING CIRCULAR SAW BLADES - CARBIDE TIPPED

IBS No.	Blade Dia.	Teeth	Arbor	RPM	Applications
137756	7.25"	36T	20mm	3500	Circular Saw Blades for Steel
137757	7.25"	54T	20mm	3500	Circular Saw Blades for Aluminum
137758	7.25"	48T	20mm	3500	Circular Saw Blade for Stainless Steel

14" INDUSTRIAL METAL CUTTING CHOP SAW BLADES - CARBIDE TIPPED

IBS No.	Blade Dia.	Teeth	Arbor	RPM	Applications
137761	14.0"	66T	1.0"	1450	Chop Saw Blades for Steel
137762	14.0"	80T	1.0"	1450	Chop Saw Blades for Aluminum
137763	14.0"	90T	1.0"	1450	Chop Saw Blade for Stainless Steel

T
A
P
S

B
U
R
S

B
L
A
D
E
S

IBS, INCORPORATED

Circular Saw Blades P11



Circular Saws (T03)

- Increase Productivity — No milling or deburring with near surgical dry-cut technology.
- Cuts a variety of Metals, Plastic and Wood.
- Cool to the Touch — No waiting for your workpiece to cool down.
- Precise Cutting — with integrated laser sighting system (7-1/4" saw only).



Circular & Chop Saw Blades Sold Separately

7-1/4" CIRCULAR SAW

SPECIFICATIONS	7-1/4"
Part Number	137759
Cutting Capacity	2-1/4"
Weight	15 lbs.
Blade Diameter	7.25"
Arbor	3/4" (20mm)
RPM	3800
Beveling/Mitering	Beveling / 45°
Motor	120V / 1400W
Depth Adjustment	Yes
Chip Cover	1 Cover for Metal
Applications	Pipe, plate, channel, grating, roof decking, silos, emergency rescue.

- Powerful double-insulated motor for continuous loads
- Internally powered laser (no batteries required)
- Spring loaded lower guard
- Integrated chip collection
- Soft Start
- Electric Brake
- Smooth bevel and angle cutting adjustments
- Well balanced handle design for better control

INCLUDES: 1 tool case, 1 blade, 1 wrench, 1 guide plate, 1 safety eyewear, 1 ear protection, 1 instruction manual

DO NOT USE on materials thicker than 3/8" solid for aluminum, 5/16" for mild steel, or 1/4" for solid stainless steel.

14" CIRCULAR SAW

SPECIFICATIONS	14"
Part Number	137760
Cutting Capacity	4-3/4"
Weight	54 lbs.
Blade Diameter	14"
Arbor	1" (25.4mm)
RPM	1300
Beveling/Mitering	Mitering / 45°
Motor	120V / 1800 W
Depth Adjustment	Two Position Vise
Chip Cover	Chip Tray
Applications	Pipe, plate, channel, conduit angle iron, metal studs, rebar, tubing, etc..

- Low speed high torque motor
- High Precision durable steel construction
- Cast aluminum base
- Quick release table/base clamp cuts 0o to 45o
- Smooth bevel and angle cutting adjustments
- Eye protection plate
- Table/base clamp with quick release
- Depth stop
- Well balanced handle design for better control
- Integrated chip collection

INCLUDES: 1 tool case, 1 blade, 1 wrench, 1 guide plate, 1 safety eyewear, 1 ear protection, 1 instruction manual

DO NOT USE on materials thicker than 3/8" solid for aluminum, 5/16" for mild steel, or 1/4" for solid stainless steel.

T
A
P
S

B
U
R
S

B
L
A
D
E
S



IBS, INCORPORATED

Bandsaw Blades P11

General Information

- Bandsaw Blades are custom ordered to your specifications
- Allow up to 3 weeks for delivery
- All bandsaw blades are non-stock, & NON-RETURNABLE
- To order, specify the following:

1. Composition / Material: Bi-Metal or Carbon

Bi-Metal:

Bi-Metal blades are designed to cut just about anything that can be cut.

Bi-Metal blades have hardened High Speed Steel teeth that are electron beam welded to a high strength spring steel alloy backing material. The result is a durable, fatigue resistant blade that should last many times longer than carbon blades because it is able to withstand the heat when cutting steel and other alloys.



Bi-Metal blades have a variable tooth pitch which means that the blade simultaneously cut and clean to reduce friction and vibration for faster, smoother and straighter cutting.

Cutting Applications: Used on most metal working applications, carbon steel, stainless steel and ferrous metal, non-ferrous metal, alloy and tool steel, nickel brass alloy, wood, plastic, foam, titanium and just about anything that needs to be cut.

Carbon: (2 designs)

Carbon blades are mainly for non-ferrous metal, wood, plastic, and other materials.

1. Blades with 10 tpi and 1/2" width or larger are Carbon Hard Back.

Carbon Hard Back blades are constructed from one piece of carbon steel, with spring tempered back and tooth hardness of RC 04-07. The backing material resists snagging and scoring of the band and accepts heavier feed pressure and back tension than flex back, for faster, straighter cutting.

Cutting Applications: Used on wood, plastics, abrasive materials, carbon tool steels, solid structural steel, brass bronze, cast iron lead, zinc, cold rolled steel. Small to mid-sized machines.



2. Blades with 8 tpi and under 1/2" are Carbon Flex Back.

Carbon Flex Back blades are constructed from one piece of carbon steel with spring tempered back and tooth hardness of RC04—07, and back hardness of RC28—30. Excellent fatigue resistance, even at high band speeds.

Cutting Applications: Used on wood, plastics, fiberglass, mild steels, cast iron copper, lead, & aluminum. Use light duty saws with band speeds below 4,000 min.



2. Teeth Per Inch (TPI) refer to price pages

BI-METAL — VARIPITCH TOOTH		CARBON — STRAIGHT TOOTH	
Dia./ Wall / Thickness	TPI	Dia./ Wall / Thickness	TPI
Up to 3/16"	14/16	1/16" to 1/8"	24
3/16" to 3/8"	10/14	Up to 1/8"	18
1/4" to 1/2"	8/12	1/8" to 1/4"	14
1/2" to 1"	6/10	1/4" to 1/2"	10
1" to 1-1/2"	5/8	1/2" to 1"	8
1-1/2" to 3"	4/5	1" to 3"	5
3" to 5"	3/4	3" to 5"	4
5" to 8"	2/3	5" to 8"	3
8" or larger	1/2	8" or larger	Z — 1.25

3. Length — Refer to chart located in price pages

4. Width — Refer to chart located in price pages

T
A
P
S
B
U
R
S
B
L
A
D
E
S

Anatomy of a Bandsaw Blade

Although it looks like a flat piece of metal with teeth, a quality industrial band saw blade is actually a sophisticated cutting tool. Its ability to efficiently cut through tough metals, composite materials, plastics, and woods depends on a variety of interrelated factors such as the design, spacing and set of the teeth; the design and capacity of the gullets to make sure chips are efficiently removed; the composition of the backer strip; and the gage of the metal. These considerations must be taken into account when selecting the right blade for your application.

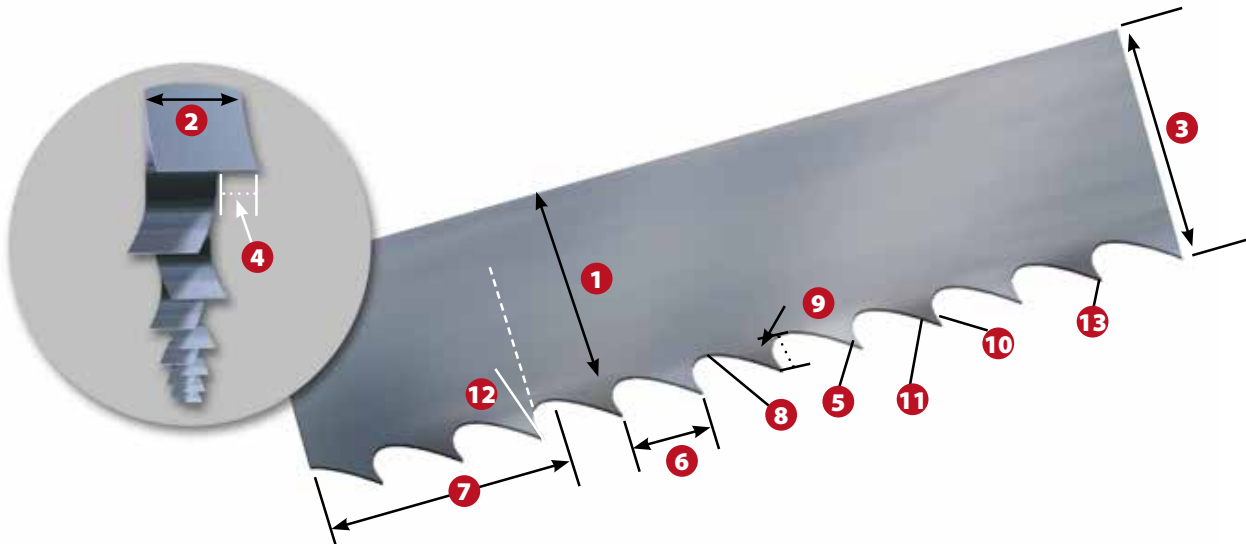

- 1 **Blade Back** The body of the blade not including tooth portion
- 2 **Gage** The thickness of the blade
- 3 **Width** The tip of tooth to back of blade
- 4 **Set** The bending of teeth right or left
- 5 **Tooth** The cutting portion of the saw blade
- 6 **Tooth Pitch** The distance from one tooth tip to the next
- 7 **T.P.I.** The number of teeth per inch measured gullet to gullet
- 8 **Gullet** The curved area between the tooth points
- 9 **Gullet Depth** The distance from the tooth tip to the bottom of the gullet
- 10 **Tooth Face** The surface of the tooth on which the chip is formed
- 11 **Tooth Flank** The angled back surface of the tooth opposite the tooth face
- 12 **Tooth Rake Angle** The angle of the tooth face measured with respect to a line perpendicular to the cutting direction of the saw
- 13 **Tooth Tip** The cutting edge of the saw tooth



IBS, INCORPORATED

Bandsaw Blades P11



Tooth Selection Guide (teeth per inch)

T
A
P
S

B
U
R
S

B
L
A
D
E
S





Material Size (Inches)	Teeth Per Inch	Material Size (Metric)	Wall Thickness (Inches)	Teeth Per Inch	Wall Thickness (Metric)
0		0	1/16	10/14	- 1.8
.1	14/18	2.5	1/8	8/12	- 3.2
.2	10/14	5.1	3/16	6/10	- 4.8
.3	8/12	7.6	1/4	5/8	- 6.3
.4	8/12	10.2	5/16	5/8	- 7.9
.5	6/10	12.7	3/8	5/8	- 9.5
.6	6/10	15.0	7/16	5/8	- 11.0
.7	5/8	17.8	1/2	5/8	- 12.7
.8	5/8	20.0	9/16	4/6	- 14.3
.9	5/8	22.9	5/8	4/6	- 15.8
1	5/8	25.4	11/16	4/6	- 17.5
1-1/4	4/6	31.8	3/4	3/4	- 19.0
1-1/2	4/6	38.1	13/16	3/4	- 20.6
1-3/4	4/6	44.5	7/8	3/4	- 22.0
2	4/6	50.8	15/16	3/4	- 23.8
2-1/4	3/4	57.2	1	3/4	- 25.4
2-1/2	3/4	63.5	1-1/8	3/4	- 28.6
2-3/4	3/4	69.9	1-1/4	3/4	- 32.0
3	3/4	76.2	1-3/8	2/3	- 35.0
3-1/4	3/4	82.6	1-1/2	2/3	- 38.0
3-1/2	3/4	88.9			
3-3/4	3/4	95.3			
4	3/4	101.6			
5	2/3	127.0			
6	2/3	152.4			
7	2/3	177.8			
8	2/3	203.0			
9	1.4/2.5	228.6			
10	1.4/2.5	254.0			
15	1/1.5	381.0			
30	1/1.5	762			

 **Rectangular Solids:**
(Use Width)
  **Round Solids:**
(Use Diameter)

Pipe Tubing Structurals
 (Use Wall Thickness)

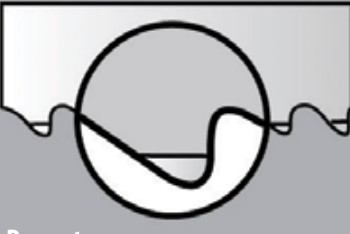
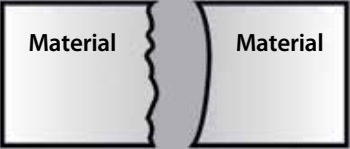
Cutting speed - structurals rule of thumb:
 When cutting structurals use a cutting speed of
 250-325 S.F.M. Wet • 200-250 S.F.M. Dry

Bandsaw Blade Problem Solving

Problem	Problem Cause	Solution
 <p>Premature Blade Breakage Straight Break indicates fatigue</p>	<ul style="list-style-type: none"> • Incorrect blade - teeth too coarse • Blade tension too high • Side guides too tight • Damaged or misadjusted blade guides • Excessive feed • Incorrect cutting fluid • Wheel diameter too small for blade • Blade rubbing on wheel flanges • Teeth in contact with work before starting saw • Incorrect blade speed 	<ul style="list-style-type: none"> • Use finer tooth pitch • Reduce blade tension (see machine manual) • Check side guide clearance (see machine manual) • Check all guides for alignment/damage • Reduce feed pressure • Check coolant • Use thinner blade • Adjust wheel alignment • Allow 1/2" clearance before starting cut • Increase or decrease blade speed
 <p>Premature Dulling of Teeth</p>	<ul style="list-style-type: none"> • Teeth pointing in wrong direction / blade mounted backwards • Improper or no blade break-in • Hard spots in material • Material work hardened • Improper coolant • Improper coolant concentration • Speed too high • Feed too light • Teeth too small 	<ul style="list-style-type: none"> • Install blade correctly. If teeth are facing the wrong direction, flip blade inside out • Break in blade properly (Page 17) • Check for hardness or hard spots like scale or flame cut areas • Increase feed pressure • Check coolant type • Check coolant mixture • Check recommended blade speed (Page 24-25) • Increase feed pressure • Increase tooth size
 <p>Inaccurate Cut</p>	<ul style="list-style-type: none"> • Tooth set damage • Excessive feed pressure • Improper tooth size • Cutting fluid not applied evenly • Guides worn or loose • Insufficient blade tension 	<ul style="list-style-type: none"> • Check for worn set on one side of blade • Reduce feed pressure • Check tooth size chart (Page 23) • Check coolant nozzles • Tighten or replace guides, check for proper alignment • Adjust to recommended tension
 <p>Band Leading in Cut</p>	<ul style="list-style-type: none"> • Over-feed • Insufficient blade tension • Tooth set damage • Guide arms loose or set too far apart • Chips not being cleaned from gullets • Teeth too small 	<ul style="list-style-type: none"> • Reduce feed force • Adjust recommended tension • Check material for hard inclusions • Position arms as close to work as possible. Tighten arms. • Check chip brush • Increase tooth size
 <p>Chip Welding</p>	<ul style="list-style-type: none"> • Insufficient coolant flow • Wrong coolant concentration • Excessive speed and/or pressure • Tooth size too small • Chip brush not working 	<ul style="list-style-type: none"> • Check coolant level and flow • Check coolant ratio • Reduce speed and/or pressure • Use coarser tooth pitch • Repair or replace chip brush
 <p>Teeth Fracture Back of tooth indicates work spinning in clamps</p>	<ul style="list-style-type: none"> • Incorrect speed and/or feed • Incorrect blade pitch • Saw guides not adjusted properly • Chip brush not working • Work spinning or moving in vise 	<ul style="list-style-type: none"> • Check cutting chart (Page 24-25) • Check tooth size chart (Page 23) • Adjust or replace saw guides • Repair or replace chip brush • Check bundle configuration/adjust vise pressure
 <p>Irregular Break Indicates material movement</p>	<ul style="list-style-type: none"> • Indexing out of sequence • Material loose in vise 	<ul style="list-style-type: none"> • Check proper machine movement • Check vise or clamp

T
A
P
S
B
U
R
S
B
L
A
D
E
S







IBS, INCORPORATED

Bandsaw Blades P11

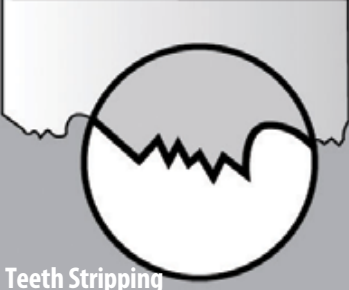
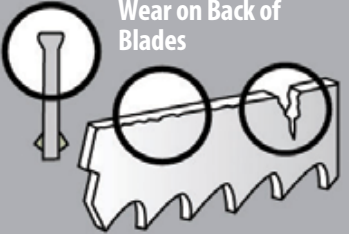
T
A
P
S
B
U
R
S
B
L
A
D
E
S

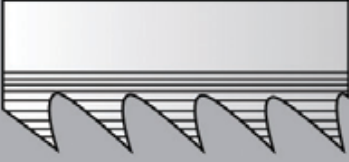
Bandsaw Blade Problem Solving

Problem	Problem Cause	Solution
 <p>Teeth Stripping</p>	<ul style="list-style-type: none"> • Feed pressure too high • Tooth stuck in cut • Improper or insufficient coolant • Incorrect tooth size • Hard spots in material • Work spinning in vise - loose nest or bundle • Blade speed too slow • Blade teeth running backwards • Chip brush not working 	<ul style="list-style-type: none"> • Reduce feed pressure • Do not enter old cut with a new blade • Check coolant flow and concentration • Check tooth size chart (Page 23) • Check material for hard inclusions • Check clamping pressure - be sure work is held firmly • Increase blade speed - see cutting chart (Page 24-25) • Reverse blade (turn inside out) • Repair or replace chip brush
 <p>Wear on Back of Blades</p>	<ul style="list-style-type: none"> • Excessive feed pressure • Insufficient blade tension • Back-up guide roll frozen, damaged, or worn • Blade rubbing on wheel flange 	<ul style="list-style-type: none"> • Decrease feed pressure • Increase blade tension and readjust guides • Repair or replace back-up roll or guide • Adjust wheel cant
 <p>Rough Cut Washboard surface Vibration and or chatter</p>	<ul style="list-style-type: none"> • Dull or damaged blade • Incorrect speed or feed • Insufficient blade support • Incorrect tooth pitch • Insufficient coolant 	<ul style="list-style-type: none"> • Replace with new blade • Increase speed or decrease feed • Move guide arms as close as possible to the work • Use finer pitch blade • Check coolant flow
 <p>Wear Lines, Loss of Set</p>	<ul style="list-style-type: none"> • Saw guide inserts or wheel flange are riding on teeth • Insufficient blade tension • Hard spots in material • Back-up guide worn 	<ul style="list-style-type: none"> • Check machine manual for correct blade width • Tension blade properly • Check material for inclusions • Replace guide
 <p>Twisted Blade Profile Profile sawing</p>	<ul style="list-style-type: none"> • Blade binding in cut • Side guides too tight • Radius too small for blade width • Work not firmly held • Erratic coolant flow • Excessive blade tension 	<ul style="list-style-type: none"> • Decrease feed pressure • Adjust side guide gap • Use narrower blade • Check clamping pressure • Check coolant nozzles • Decrease blade tension
 <p>Blade Wear Teeth blued</p>	<ul style="list-style-type: none"> • Incorrect blade • Incorrect feed or speed • Improper or insufficient coolant 	<ul style="list-style-type: none"> • Use coarser tooth pitch • Increase feed or decrease speed • Check coolant flow

IBS, INCORPORATED

Bandsaw Blades P11



Bi-Metal Portable Bandsaw Blades — Standard Pitch



BI-METAL PORTABLE BANDSAW BLADES — STANDARD PITCH

With sharp cutting edges and straight pitch teeth, these blades cut fast and last a long time with reduced breakage

IBS No.	Length		TPI	Set
	inches	mm		
447810	44-7/8 X 1/2 X .020	1140 X 12.7 X .50	10	Raker
447814	44-7/8 X 1/2 X .020	1140 X 12.7 X .50	14	Wavy
447818	44-7/8 X 1/2 X .020	1140 X 12.7 X .50	18	Wavy
447824	44-7/8 X 1/2 X .020	1140 X 12.7 X .50	24	Wavy
—	53-3/4 X 1/2 X .020	1365 X 12.7 X .50	10	Raker
—	53-3/4 X 1/2 X .020	1365 X 12.7 X .50	14	Wavy
—	53-3/4 X 1/2 X .020	1365 X 12.7 X .50	18	Wavy
—	53-3/4 X 1/2 X .020	1365 X 12.7 X .50	24	Wavy
—	53-3/4 X 1/2 X .020	1365 X 12.7 X .50	10/14	Raker

**ORDER AS NON-STOCK — NON RETURNABLE ITEM
SOLD INDIVIDUALLY**

Use on machine metals, including stainless steel, pipe, tubing and solids. Premium straight pitch blades offer high resistance to heat, wear and shock, contributing to longer blade life.

T
A
P
S

B
U
R
S

B
L
A
D
E
S



IBS, INCORPORATED

Hacksaw / Reciprocating Saw Blades P11

4-in-1 Hacksaw Frame

IBS No. 16411

The Nicholson® Pro Series 4-in-1 Hacksaw takes versatility and quality to an entirely new level. Its frame is designed to hold blades at a tension of up to 30,000 psi, for smooth and straight cuts, whether in standard, 45° angle, or low profile configurations. And while some other hacksaws have jab saw capability, the unique design of the Nicholson Pro Series accommodates a heavy duty reciprocal saw blade for maximum performance in jab saw applications.

T
A
P
S

B
U
R
S

B
L
A
D
E
S

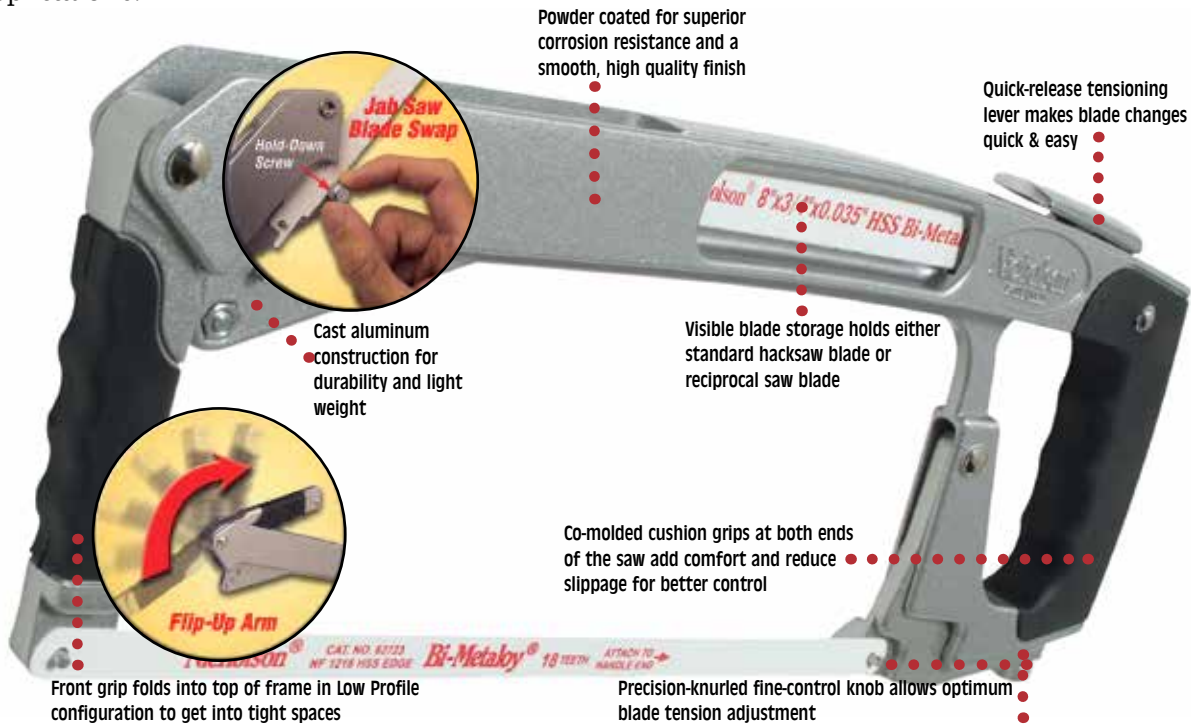

GENERAL USE

Standard 90° blade position is best for most jobs around the shop



45° ANGLE

The 45° blade position allows flush cuts and use in obstructed applications



LOW PROFILE

Low profile configuration allows quality high tension cuts in tight spaces.



JAB SAW

Heavy duty Jab Saw configuration is perfect for many close-in applications.

Four Ways to Get the Job Done!



90° Blade Position



45° Blade Position



Low Profile



Jab Saw

IBS, INCORPORATED

Hacksaw / Reciprocating Saw Blades P11



IBS Hi-Alloy Hacksaw Blades

The IBS Hi-Alloy hand hacksaw blade is the ideal combination of high, red heat hardness on the cutting edge, joined to a tough, alloy steel back with great strength and stretch resistance.

This combination, made possible by **electron beam welding**, gives performance never before attainable in any hand hacksaw blade.

The **bi-metal design** creates a shatter resistant blade with the ability to cut faster and longer because it stays sharper.

The best blade possible for cutting materials including stainless steel hardened alloys or ANYTHING that can be cut.

Manufactured in varied pitch, which means that the blade simultaneously cuts and cleans for low friction and fast cutting.



"VARI-PITCH REPEATER TEETH"

FINE COARSE FINE COARSE

IBS No.	Size	TPI	Qty
16395	12" x 1/2	18/14 tpi	10
16396	12" x 1/2	24/20 tpi	10
16398	12" x 1/2	32/26 tpi	10

Triple-Cut Hacksaw Blades

This is a hacksaw blade with **3 different pitches of teeth**.

This blade has 32 tpi at the front 1/3 of the blade, 24 tpi in the center, and 18 tpi at the back 1/3 of the blade.

This special tooth configuration allows super fast and easy starts in thin sheet metal with the 32 tpi at the front, slightly faster cutting in the middle, and really fast cutting towards the back of the blade.

- Bi-metal construction for maximum strength and resistance to bending, twisting binding, vibration and breaking.
- Super sharp Hi-Strength Alloy Teeth for easier starting, faster cutting and longer life.

Recommended Use: For use as a standard hacksaw blade, but on a wider variety of material thicknesses. Use to cut wood, plastic, or any machinable metal, including conduit, stainless steel tubing, angle iron, copper tubing, structural materials and more.



IBS No.	Size	TPI	Qty
16399	12"	18/24/32 tpi	10

T
A
P
S

B
U
R
S

B
L
A
D
E
S



IBS, INCORPORATED

Assortments (Z02)

IBS Hi-Alloy & Triple-Cut Hacksaw Blades

IBS No. 785R • 4 Items • 20 Pcs

Packaged in a locking steel drawer for easy storage & organization

T
A
P
S

B
U
R
S

B
L
A
D
E
S

 IBS, Inc. <small>SPECIALTY PRODUCTS FOR MAINTENANCE & REPAIR INDUSTRIALBOLT.COM • 800-678-1906</small>		Hi-Alloy Bi-Metal Hacksaw Blades	
		Assortment No. 785R	
16395 12 18/14 HI-ALLOY HACKSAW BLADE			
16396 12 24/20 HI-ALLOY HACKSAW BLADE			
16398 12 32/26 HI-ALLOY HACKSAW BLADE			
16399 12 18/24/32 TRIPLE CUT BIMETAL HACKSAW BLADE			

IBS, INCORPORATED

Reciprocating Saw Blades (P11)



Advanced Edge Power Reciprocating Saw Blades



The Advanced Edge Power reciprocating saw blade powers through the toughest applications. This heavy duty blade is perfect for cutting any machineable metal as well as wood, wood composite, plastic or rubber.

- **1" width** for more rigidity and beam strength.
- **.042" thickness** accepts heavier feed pressure.
- **Straight tooth pitch** gives a smooth cutting action.
- **Bi-Metal construction** for long cutting life and heat and wear resistance.
- **MADE IN THE USA!**











IBS No.	Description	PKG
470610	6IN 10TPI	2
470910	9IN 10TPI	2
471210	12IN 10TPI	2
470614	6IN 14TPI	2
470914	9IN 14TPI	2
471214	12IN 14TPI	2
470618	6IN 18TPI	2
470918	9IN 18TPI	2
471218	12IN 18TPI	2



Advanced Edge Power Reciprocating Saw Blades with Tool Ease Lubricant Stick

IBS No. 840R 10 Items • 21 Pcs

Packaged in a locking steel drawer for easy storage & organization

 IBS, Inc. <small>SPECIALTY PRODUCTS FOR MAINTENANCE & REPAIR INDUSTRIALBOLT.COM © © © 800-678-1906</small>		Advanced Edge Power Reciprocating Saw Blades	
			Assortment No. 840R
470610 6IN X .042 10TPI ADVANDED EDGE POWER RECIP BLADE 1IN WIDTH 	470910 9IN X .042 10TPI ADVANDED EDGE POWER RECIP BLADE 1IN WIDTH 		
471210 12IN X .042 10TPI ADVANDED EDGE POWER RECIP BLADE 1IN WIDTH 			
470614 6IN X .042 14TPI ADVANDED EDGE POWER RECIP BLADE 1IN WIDTH 	470914 9IN X .042 14TPI ADVANDED EDGE POWER RECIP BLADE 1IN WIDTH 		
471214 12IN X .042 14TPI ADVANDED EDGE POWER RECIP BLADE 1IN WIDTH 			
470618 6IN X .042 18TPI ADVANDED EDGE POWER RECIP BLADE 1IN WIDTH 	470918 9IN X .042 18TPI ADVANDED EDGE POWER RECIP BLADE 1IN WIDTH 		
471218 12IN X .042 18TPI ADVANDED EDGE POWER RECIP BLADE 1IN WIDTH 		74172 TOOL EASE 	

TAPS BURSB L A D E S



IBS, INCORPORATED

Hacksaw / Reciprocating Saw Blades P11

Bi-Metal Reciprocating Saw Blade

IBS Reciprocating Saw Blades are designed to fit all popular machines that take 1/2" shank. Bi-Metal blades consist of a high-speed cutting edge welded to a flexible alloy steel back. Faster cutting with sharper, harder teeth and extra-strength shank. Bi-metal blades reduce breakage and last longer than conventional carbon and all high-speed blades. Recommended for cutting steel, stainless steel, nail-embedded wood, hardwood flooring, reinforcing bar, cast iron and pipe.

T
A
P
S

B
U
R
S

B
L
A
D
E
S



Plaster with metal lathe plaster board, sheet rock, plaster walls. Tooth design cuts both forward and on backward stroke.

IBS No.	Size	TPI	Qty
44656	6" x 3/4 x .035	6 tpi	5



Wood, nail-embedded wood, compositions plastic, cast aluminum, light gauge metals.

IBS No.	Size	TPI	Qty
44610	6" x 3/4 x .035	10 tpi	5



All woods, plastic, cast aluminum, nail-embedded wood, soil pipe.

IBS No.	Size	TPI	Qty
4461014	6" x 3/4 x .050	10/14 tpi	5
4481014	8" x 3/4 x .050	10/14 tpi	5



Metal, 18 gauge and under. Trim & tubing. Galvanized pipe under 18 gauge.

IBS No.	Size	TPI	Qty
44424	4" x 3/4 x .035	24 tpi	5
44624	6" x 3/4 x .035	24 tpi	5



Wood, nail-embedded wood, compositions plastic, cast aluminum, light gauge metals.

IBS No.	Size	TPI	Qty
44606	6" x 3/4 x .050	6 tpi	5
44906	9" x 3/4 x .050	6 tpi	5
441206	12" x 3/4 x .050	6 tpi	5
44120812	12" x 3/4 x .050	8/12 tpi	5



Heavy gauge metals of 18 gauge to 1/8" thick conduit, pipe, channels and tubing.

IBS No.	Size	TPI	Qty
44418	4" x 3/4 x .035	18 tpi	5
44618	6" x 3/4 x .035	18 tpi	5
44818	8" x 3/4 x .035	18 tpi	5
44918	9" x 3/4 x .035	18 tpi	5
441018	10" x 3/4 x .035	18 tpi	5
441218	12" x 3/4 x .035	18 tpi	5
44914	9" x 3/4 x .035	14 tpi	5



Heavy gauge metals 1/8" thick and above. Barstock and angles.

IBS No.	Size	TPI	Qty
44414	4" x 3/4 x .035	14 tpi	5
44614	6" x 3/4 x .035	14 tpi	5

IBS, INCORPORATED

Hacksaw / Reciprocating Saw Blades P11



Power Curve Reciprocating Saw Blades



- Blade curvature positions teeth to cut more efficiently, resulting in a longer lasting blade
- Lasts up to twice as long as a straight blade
- Provides better performance on difficult materials, such as: nail-embedded wood, black pipe, unit-strut, and other construction materials.

IBS No.	Size	TPI	Qty
45918	9" x 3/4 x .035	18 tpi	5
45914	9" x 3/4 x .035	14 tpi	5
45904	9" x 3/4 x .035	4 tpi	5

Thick Demolition Reciprocating Saw Blades

Specially designed for the toughest demolition jobs. Cuts all woods, nail-embedded wood and metals.



THICK DEMOLITION RECIPROCATING SAW BLADES

IBS No.	Size	TPI	Qty
460906	9" x 7/8 x .062	6 tpi	2
460910	9" x 7/8 x .062	10 tpi	2
461206	12" x 7/8 x .062	6 tpi	2
461210	12" x 7/8 x .062	10 tpi	2

Bore Blades™ Double Edge Bi-Metal Reciprocating Saw Blades

- **Double-sided** — so it cuts 3 ways making it versatile to cut in multiple directions and plunge cut saving users time and money.
- **Made with 8% cobalt** for exceptional strength and durability to provide long-lasting metal and wood cutting saving money on additional blades.
- **Round plunging tip** with ease to eliminate the need to drill first — saving the user time and money.
- **Double-edged blade cuts both ways** — just change direction as needed, saving the user time & money
- **Each blade has different TPI on each side** making them two blades for the cost of one — saving time and money on blade changeouts.



IBS No.	Size	TPI	Qty
446710	6"	6 x 10 tpi	5
446711	6"	14 x 18 tpi	5
448710	8"	6 x 10 tpi	5
448711	8"	10 x 14 tpi	5
4410710	10"	8/12 x 10 tpi	5

Tungsten Carbide Grit Reciprocating Saw Blades

Cutting edges have carbide grains bonded to an alloy backer and will not snag. Their super resistance to heat and shock make them ideal for materials too hard or abrasive for standard metal blades.

Recommended Use: Cutting fiberglass, lathe, plaster, ceramics, laminates, marble and hardened steel.



IBS No.	Size	Qty
45499	4" x 3/4	2
45699	6" x 3/4	2
45899	8" x 3/4	2

T
A
P
S

B
U
R
S

B
L
A
D
E
S



IBS, INCORPORATED

Hacksaw / Reciprocating Saw Blades (P11)

T
A
P
S
B
U
R
S
B
L
A
D
E
S

Reciprocating Saw Handle

- Instantly turn any standard reciprocating saw blade into a hand saw!
- Ergonomic handle with angled setting for additional leverage.
- Quick-twist lock securely holds any standard reciprocating saw blade or any 1/4" hex shank bit.
- Converts to a multi-bit screwdriver — handle stores 6 of the most popular bits: #5 & #6 Slotted, #1 & #2 Phillips and T15 and T20 Torx.
- Use to cut metal, wood, drywall and much more.



IBS No.	RECIPROCATING SAW HANDLE	
44600	Reciprocating Saw Handle	1

Reciprocating Saw Handle & Blade Kit

IBS No. 706R • 7 Items • 11 Pcs (Z03)







Packaged in a plastic drawer for easy storage and organization



IBS, Inc.
SPECIALTY PRODUCTS FOR MAINTENANCE & REPAIR
INDUSTRIALBOLT.COM © © © 800-670-1906

**Reciprocating Saw
Handle & Blade Kit**

Assortment No. 706R

<p>44600 RECIPROCATING SAW HANDLE</p> 	<p>44606 6 6TPI BIMETAL RECIP BLADE*</p> 	<p>44610 6 10TPI BIMETAL RECIP BLADE*</p> 	<p>44618 6 18TPI BIMETAL RECIP BLADE*</p> 	<p>44624 6 24TPI BIMETAL RECIP BLADE*</p> 	<p>446710 6 7X10TPI BORE BLADE*</p>  <p>MBHL25225 1/4 X 2-1/4 MAG DRIVER BITHOLDER</p> 
---	--	---	---	--	---



IBS, INCORPORATED

Assortments (Z02)



Bore Blades and Demolition Blades

IBS No. 801R 9 Items • 18 Pcs (Z02)
 Packaged in a locking steel drawer
 for easy storage & organization

IBS, Inc. SPECIALTY PRODUCTS FOR MAINTENANCE & REPAIR INDUSTRIALBLADE.COM © © © 800-678-1300		Bore Blades and Demolition Blades	
		Assortment No. 801R	
446710 6" 6X10TPI BORE BLADE. For metal and wood cutting.		448711 8" 10X14TPI BORE BLADE. For metal and wood cutting.	
446711 6" 14X18TPI BORE BLADE. For metal and wood cutting.		4410710 10" 8/12X10TPI BORE BLADE. For metal and wood cutting.	
448710 8" 6X10TPI BORE BLADE. For metal and wood cutting.		460906 9 X .062 6TPI DEMOLITION BIMETAL RECIP BLADE Specially designed for the toughest demolition jobs. Cuts all woods, nail-embedded wood and metals.	
460910 9 X .062 10TPI DEMOLITION BIMETAL RECIP BLADE Specially designed for the toughest demolition jobs. Cuts all woods, nail-embedded wood and metals.			
461206 12 X .062 6TPI DEMOLITION BIMETAL RECIP BLADE Specially designed for the toughest demolition jobs. Cuts all woods, nail-embedded wood and metals.			
461210 12 X .062 10TPI DEMOLITION BIMETAL RECIP BLADE Specially designed for the toughest demolition jobs. Cuts all woods, nail-embedded wood and metals.			

Bi-Metal Reciprocating Saw Blades

IBS No. 512P 12 Items • 60 Pcs (Z08)
 Packaged in a locking steel drawer
 for easy storage & organization

IBS, Inc. SPECIALTY PRODUCTS FOR MAINTENANCE & REPAIR INDUSTRIALBLADE.COM © © © 800-678-1300		Hi-Alloy Reciprocating Saw Blades	
		Assortment No. 512P	
441206 12" 6TPI HI ALLOY RECIP BLADE Wood, nail-embedded wood, compositions plastic, cast aluminum, light gauge metals.			
4481014 8" 10-14TPI HI ALLOY RECIP BLADE All woods, plastic, cast aluminum, nail-embedded wood, soil pipe.		44624 6" 24TPI HI ALLOY RECIP BLADE Metal, 18 gauge and under. Trim & tubing. Galvanized pipe under 18 gauge.	
44614 6" 14TPI HI ALLOY RECIP BLADE Heavy gauge metals 1/8" thick and above. Barstock and angles.		44618 6" 18TPI HI ALLOY RECIP BLADE Heavy gauge metals of 18 gauge to 1/8" thick conduit, pipe, channels and tubing.	
44610 6" 10TPI HI ALLOY RECIP BLADE Wood, nail-embedded wood, compositions plastic, cast aluminum, light gauge metals.		4461014 6" 10-14TPI HI ALLOY RECIP All woods, plastic, cast aluminum, nail-embedded wood, soil pipe.	
44606 6" 6TPI HI ALLOY RECIP BLADE Wood, nail-embedded wood, compositions plastic, cast aluminum, light gauge metals.		44656 6" 6TPI HI ALLOY RECIP BLADE Plaster with metal lathe plaster board, sheet rock, plaster walls. tooth design cuts both forward and on backward stroke.	
44414 6" 14TPI HI ALLOY RECIP BLADE Heavy gauge metals 1/8" thick and above. Barstock and angles.		44418 4" 18TPI HI ALLOY RECIP BLADE Heavy gauge metals of 18 gauge to 1/8" thick conduit, pipe, channels and tubing.	
44424 4" 24TPI HI ALLOY RECIP BLADE Metal, 18 gauge and under. Trim & tubing. Galvanized pipe under 18 gauge.			

Special Purpose Reciprocating Saw Blades

IBS No. 393R • 8 Items • 16 Pcs (Z08)
 Packaged in a Locking Steel Drawer
 for Easy Storage & Organization

IBS, Inc. SPECIALTY PRODUCTS FOR MAINTENANCE & REPAIR INDUSTRIALBLADE.COM © © © 800-678-1300		Special Purpose Reciprocating Saw Blades	
		Assortment No. 393R	
44906 9 X 3/4 6TPI RECIP BIMETAL Wood, nail-embedded wood, compositions, plastic, cast aluminum, light gauge metals.		45499 4 TUNGSTEN CARBIDE GRIT RECIP BLADE Cutting fiberglass, lathe, plaster, ceramics, laminates, marble and hardened steel.	
45699 6 TUNGSTEN CARBIDE GRIT RECIP BLADE Cutting fiberglass, lathe, plaster, ceramics, laminates, marble and hardened steel.		45899 8 TUNGSTEN CARBIDE GRIT RECIP BLADE Cutting fiberglass, lathe, plaster, ceramics, laminates, marble and hardened steel.	
460906 9 X .062 6TPI DEMOLITION BIMETAL RECIP BLADE Specially designed for the toughest demolition jobs. Cuts all woods, nail-embedded wood and metals.			
461206 12 X .062 6TPI DEMOLITION BIMETAL RECIP BLADE Specially designed for the toughest demolition jobs. Cuts all woods, nail-embedded wood and metals.			
460910 9 X .062 10TPI DEMOLITION BIMETAL RECIP BLADE Specially designed for the toughest demolition jobs. Cuts all woods, nail-embedded wood and metals.			
461210 12 X .062 10TPI DEMOLITION BIMETAL RECIP BLADE Specially designed for the toughest demolition jobs. Cuts all woods, nail-embedded wood and metals.			

T
A
P
S
B
U
R
S
B
L
A
D
E
S



IBS, INCORPORATED

Hacksaw / Reciprocating Saw Blades (P11)

T
A
P
S

B
U
R
S

B
L
A
D
E
S

Bi-Metal Air Saw Blades

These blades are specifically designed for use in pneumatic saws. Blades have fine teeth for cutting metal. Very popular within autobody / muffler shops or other metal fabricating shops.



Bi-METAL AIR SAW BLADES

IBS No.	Size	TPI	Qty
441318	3" x 1/2" x .025	18 tpi	5
441324	3" x 1/2" x .025	24 tpi	5
441332	3" x 1/2" x .025	32 tpi	5
441418	4" x 1/2" x .025	18 tpi	5
441424	4" x 1/2" x .025	24 tpi	5
441432	4" x 1/2" x .025	32 tpi	5

Bi-Metal Air Saw Blades

IBS No. 513P • 6 Items • 30 Pcs (Z08)
Packaged in a locking plastic tray for easy storage & organization

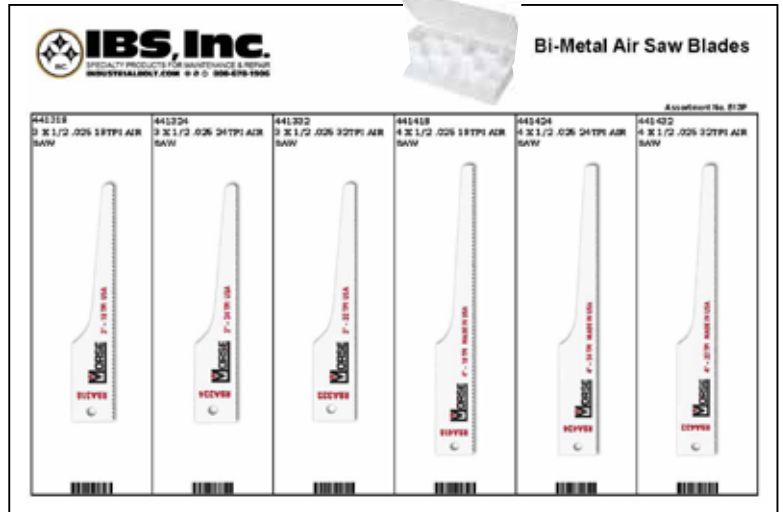

Bi-Metal Sabre/Jig Saw Blades

IBS Bi-Metal Sabre/Jig Saw Blades cut faster, cut straight, and last many times longer than high speed blades. Bi-metal construction consists of extra-sharp teeth milled in high speed steel welded to alloy back for longer life, and fewer changes. Tough sharp shatterproof bi-metal blades recommended for cutting steel, nail-embedded wood, masonite, conduit composition material, laminated countertops.

1/4" Universal Shank



Metal 18 gauge and under.

IBS No.	Size	TPI	Qty
442718	3" x 3/8" x .035	18 tpi	5

Bosch Shank



Steel and non-ferrous metal, 1/8" thick and up.

IBS No.	Size	TPI	Qty
440318	3" x 3/8" x .035	18 tpi	5

IBS, INCORPORATED

Razor Blades P11



"Rapid Razor" Utility Knife



- Autoloading design
- One-button blade change - 5 blades included
- Ergonomic rubber grip
- Heavy duty die cast body
- Holds any standard utility or hook blade
- 5 blades included

IBS No.	Description	Qty
16402	IBS "Rapid Razor" Utility Knife	1

"Rapid Razor" Dispenser 75 Blades/Pkg

- Dispenses 2-notch blades quickly and easily.
- Dispenser is wall mountable for convenient and easy access.
- Convenient see-thru body for easy visual check of supply.
- Built-in blade disposal slot for added safety.
- **MADE IN THE USA**



IBS No.	Description	Qty
16407	IBS "Rapid Razor" Dispenser	1

Heavy Duty Blades

- .025 Gauge.
- Fits most standard knives.
- Long lasting.
- All purpose blades.
- Made in the USA.



IBS No.	Description	Qty
16406	3 Notch Heavy Duty Utility Blade	5

Cartridge Loading Snap Knife with Rubber Grip



- Autoloading design
- Blade cartridge w/6 premium 8 pt blades
- Ratchet wheel for blade stability
- Ergonomic rubber grip
- Auto-locking
- For replacement blades use IBS No. 16409

IBS No.	Description	Qty
16408	Cartridge Loading Snap Knife	1

HD Retractable Blade 8 Pt. Breakaway Knife



- Sturdy metal body
- Auto-locking
- High-visibility yellow.
- Comes with premium steel blades.
- Accepts all standard 8 point blades.
- Spare blade compartment.
- Ideal for cutting cardboard, wood, leather and more.
- For replacement blades use IBS No. 16409

IBS No.	Description	Qty
16403	HD Retractable Breakaway Knife	1

Utility Knife Holster

- Sturdy metal clip.
- Universal use.
- Belt slots.
- High quality leather construction.
- Holds most utility knives & safety cutters.
- Made in the USA.



IBS No.	Description	Qty
16410	Utility Knife Holster	1

Heavy Duty Hook Blades

- Use with IBS Rapid Razor 16402.
- Ideal for cutting roofing, linoleum and carpet.
- .025 Gauge.
- Fits most standard knives.
- Long lasting.
- Made in the USA.



IBS No.	Description	Qty
16412	Heavy Duty Hook Utility Blade	5

HD 8 PT Snap Blade

- Use with IBS No. 16403 & 16408.
- Heavy Duty.
- Fits all standard snap knives.



IBS No.	Description	Qty
16409	HD 8 PT Snap Blade - 10 Pack	1

T
A
P
S
B
U
R
S
B
L
A
D
E
S



IBS, INCORPORATED

Razor Blades P11

T
A
P
S
B
U
R
S
B
L
A
D
E
S

Plastic Razor Blades

- Double Edged for longer life.
- Use with IBS No. 16400.
- Made for safer scraping and cleaning.
- Prevents damage to delicate surfaces.
- Fits most standard knives.
- Will not rust or corrode like metal blades.



IBS No.	Description	Qty
16401	Plastic Razor Blades	50

Single Edge Razor Blades

- Use with IBS No. 16400.
- Fits all standard single edge tools.
- Double honed for extra sharp edge.
- Strong steel back will not bend.
- Individually wrapped for edge protection and safety.
- Innovative packaging easily dispenses each blade thru top slot.
- Storage slot in the bottom for disposal of used blades.
- **MADE IN USA**



IBS No.	Description	Qty
16405	Single Edge Razor Blades	100

Revo Folding Knife

- Comfort-grip finger loop for added safety and control.
- Two position cutting.
- 50% more blade-edge exposed for deeper cutting.
- Quick-change blade replacement.
- Metal belt clip.
- Use with IBS No. 16407 IBS Rapid Razor 100 BLADES/PK (purchase separately).



IBS No.	Description	Qty
16416	Revo Folding Knife	1

Heavy Duty Metal Scraper

- Protective cap keeps the blade covered until it is in use. The cover then snaps on the back of the scraper to keep from losing or misplacing the cap.
- Ergonomic grip for better control.
- No push-button slide to expose the blade which often causes the blade to slide back when in use.
- Includes one standard straight razor blade for added value and allows the scraper to be used immediately.
- Perfect for scraping labels, decals, paint and adhesive from glass and other surfaces.



IBS No.	Description	Qty
16400	Heavy Duty Metal Scraper	1

SHARK Heavy Duty Combination Utility Knife

The SHARK Heavy-Duty Combination Utility Knife is two tools in one, a utility knife and a wire cutter, stripper and crimper. With a wide variety of features, this multi-function tool will get the job done faster, safer and easier.

- Rugged, professional grade construction with a comfortable, ergonomic grip.
- Has its own patented RAPID EDGE serrated blades that are built to last. The blades withstand longer use because the cutting friction is handled by five individual cutting surfaces, other blades only have one straight edge.
- Slide 'n' Lock technology allows you to adjust the amount of the blade that is exposed for precise cutting.
- Extra blades can be stored within the holder and a quick change design allows you to efficiently remove an old blade and replace it with a new one.
- When you're ready to work with wire, a spring loaded wire cutter opens easily and cuts comfortably, which locks securely into the body of the knife when you are done. The precision ground stripping holes easily remove insulation from thick 10 to 18 gauge wires.



IBS No.	Description	Qty
16414	SHARK Combination Utility Knife	1
16415	100 PK Shark Serrated Blades	1



Fiskars® Pro Fixed Blade Utility Knife

- The advantage of a "Fixed" Utility Knife is the blade is held securely and firmly in the knife for no wobble or slippage while in use for safer and more consistent cutting action.
- Folding blade guard deploys with the push of a button for convenient, easy protection.
- A reinforced metal end provides sturdy, reliable resistance against pounding and drops.
- The knife hinges open for easy blade change with no loose parts to keep track of.
- Includes one utility blade & handy 5 blade storage capacity meaning a new sharp blade is easily available to keep working, saving time and money.
- Manufacturer's Full Lifetime Warranty.



IBS No.	Description	Qty
16417	Fiskars Pro Fixed Blade Utility Knife	1

Fiskars® Pro Retractable Blade Utility Knife

- Side blade actuation on the knife helps prevent accidental blade retraction while in use.
- Knife easily hinges open with no loose parts to keep track of during blade change.
- Reinforced metal end provides sturdy, reliable resistance against pounding and drops.
- Includes one utility blade & handy 5 blade storage capacity meaning a new sharp blade is easily available to keep working, saving time and money.
- Manufacturer's Full Lifetime Warranty.



IBS No.	Description	Qty
16418	Fiskars Pro Retractable Utility Knife	1

Fiskars® Pro Folding Utility Knife



The Fiskars® Pro-Folding Utility Knife is a reliable, do-it-all addition to your tool kit and folds for compact storage and portability.

- Fiskars® Pro Folding Utility knife features a dual -locking system that prevents accidental blade release without sacrificing blade-change speed.
- Easy, one-handed, flip-open design means the knife opens with the flick of a wrist — safely reach the knife and continue working without interruption.
- Unique blade-release button makes for fast and easy blade changes — just press and sweep to release the blade and slide in a new one.
- Ergonomic design, including deep grooves and contouring allows for multiple grips.
- The reinforced metal end provides sturdy, reliable resistance against pounding and drops.
- Includes one utility blade.
- Manufacturer's Full Lifetime Warranty.

IBS No.	Description	Qty
16419	Fiskars Pro Folding Utility Knife	1

T
A
P
S
B
U
R
S
B
L
A
D
E
S



IBS, INCORPORATED

Snips, Shears & Pipe Cutters P11

T
A
P
S

B
U
R
S

B
L
A
D
E
S

Fiskars® PowerArc Utility Snips (8")



- PowerArc™ Utility Snips boast **intelligently curved blades** that alter the angle between the blades to give you over 2X more power, especially during the toughest part of the cut.
- **Offset design** with heavy-duty stainless steel blades can be used to cut materials from above or below, keeping waste material away from your hand.
- An **ergonomic, spring-assisted handle** helps reduce hand fatigue and features Softgrip® for enhanced dexterity and comfort.
- A **serrated edge, extended tang and bolted joint** improve control and durability.

IBS No.	Description	Qty
16420	Fiskars PowerArc™ Utility Snips	1

Fiskars® PowerArc Easy Action Shears (10")



- PowerArc™ Easy Action Shears™ boast **intelligently curved blades** that alter the angle between the blades to give you over 2X more power, especially during the toughest part of the cut.
- A radically **ergonomic, spring-assisted handle** features an open top loop, allowing you to rotate your hand over the handle to apply more power, especially during the toughest part of the cut.
- In addition, **Softgrip®** enhances dexterity and comfort, a bigger bottom loop fits large gloved hands and an easy-open lock protects the blades during transport.
- **Heavy-duty coined stainless steel blades** help prevent separation.
- A **serrated edge, extended tang and bolted joint** improve control and durability.

IBS No.	Description	Qty
16421	Fiskars PowerArc™ Easy Action Shears	1

Fiskars® PowerGear Plastic Pipe Cutter



- **PowerGear® technology** gives you over 35% more power to make cutting plastic pipes easier, while eliminating the need for ratcheting.
- This ingenious technology features a gear that provides more power during the toughest parts of the cut.
- **Replaceable stainless steel blades** cut from start to finish in a single, smooth stroke, while a tough stainless exoskeleton maximizes durability.
- An **ergonomic, spring-assisted handle** helps reduce hand fatigue and features Softgrip for enhanced dexterity and comfort.
- An **easy-open lock** simplifies usage while cutting a range of plastic pipes, including up to 1-1/4" O.D. PVC.

IBS No.	Description	Qty
16422	Fiskars PowerGear™ Plastic Pipe Cutter	1
16423	Replacement Blade for Fiskars PowerGear Plastic Pipe Cutter	1

IBS, INCORPORATED

Rotary Burs P29



Solid Carbide Burs

Double, Saber Cut and Fast Mill Flutes • 1/4" Shank

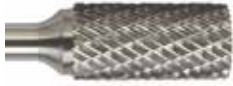

Double Cut

- For use on **hardened** and **tough materials**, stainless steel, cast steel and plastics.
- Produces a finer finish on material.
- Creates smaller chips and slivers.
- Provides greater tool control.



Saber Cut

- For use in **mild steel** and other semi-hard materials.
- Maximum stock removal.
- Engineered for heavy duty applications.
- Wider teeth make longer chips that break up easier and less prone to clogging.



Fast Mill Cut

- For use on **aluminum**, non-ferrous metals, soft steel, reinforced plastics, rubber, wood and other soft materials.
- Provides easy chip flow and faster stock removal without clogging.

FEATURES/BENEFITS:

- **Manufactured from C2 grade carbide** for high performance metal removal.
- **Perfect for edge and surface working**
- **Offered in various shapes available to match with the job** being done for fast, efficient and clean work.
- **1/4" shank fits all standard grinders.**



CYLINDER CARBIDE BUR

IBS No.			SCTI No.	Head Dia	Head Length	Overall Length
Double Cut	Saber Cut	Fast Mill Cut				
16901	16906	16981	SA-1	1/4	5/8	2
16903	16907	16983	SA-3	3/8	3/4	2-1/2
16905	16909	16985	SA-5	1/2	1	2-3/4



CYLINDER END CUT CARBIDE BUR

IBS No.			SCTI No.	Head Dia	Head Length	Overall Length
Double Cut	Saber Cut	Fast Mill Cut				
18901	—	—	SB-1	1/4	5/8	2
18903	—	—	SB-3	3/8	3/4	2-1/2
18905	—	—	SB-5	1/2	1	2-3/4



CYLINDER-RADIUS END CARBIDE BUR

IBS No.			SCTI No.	Head Dia	Head Length	Overall Length
Double Cut	Saber Cut	Fast Mill Cut				
16931	—	—	SC-1	1/4	5/8	2
16933	16936	16987	SC-3	3/8	3/4	2-1/2
16935	16938	16989	SC-5	1/2	1	2-3/4

T
A
P
S

B
U
R
S

B
L
A
D
E
S



IBS, INCORPORATED

Rotary Burs P29

Solid Carbide Burs

Double, Saber and Fast Mill Cut Flutes • 1/4" Shank

T
A
P
S

B
U
R
S

B
L
A
D
E
S



BALL SHAPE CARBIDE BUR

IBS No.			SCTI No.	Head Dia	Head Length	Overall Length
Double Cut	Saber Cut	Fast Mill Cut				
16971	—	—	SD-1	1/4	7/32	2
16972	—	—	SD-2	5/16	5/16	2-1/16
16973	16976	—	SD-3	3/8	5/16	2-1/16
16975	16977	—	SD-5	1/2	7/16	2-3/16



OVAL CARBIDE BUR

IBS No.			SCTI No.	Head Dia	Head Length	Overall Length
Double Cut	Saber Cut	Fast Mill Cut				
16941	—	—	SE-1	1/4	3/8	2
16943	16946	—	SE-3	3/8	5/8	2-11/32
16945	16948	—	SE-5	1/2	7/8	2-5/8



TREE RADIUS END CARBIDE BUR

IBS No.			SCTI No.	Head Dia	Head Length	Overall Length
Double Cut	Saber Cut	Fast Mill Cut				
16911	—	—	SF-1	1/4	5/8	2
16913	16916	16991	SF-3	3/8	3/4	2-1/2
16915	16918	16993	SF-5	1/2	1	2-3/4
—	—	16995	SF-6	5/8	1	2-3/4



TREE POINTED END CARBIDE BUR

IBS No.			SCTI No.	Head Dia	Head Length	Overall Length
Double Cut	Saber Cut	Fast Mill Cut				
16951	—	—	SG-1	1/4	5/8	2
16953	16956	—	SG-3	3/8	3/4	2-1/2
16955	16958	—	SG-5	1/2	1	2-3/4



14° TAPER - RADIUS CARBIDE BUR

IBS No.			SCTI No.	Head Dia	Head Length	Overall Length
Double Cut	Saber Cut	Fast Mill Cut				
16921	—	—	SL-1	1/4	5/8	2
16923	16926	—	SL-3	3/8	1-1/16	2-13/16
16924	16927	—	SL-4	1/2	1-1/8	2-7/8



CONE SHAPE CARBIDE BUR

IBS No.			SCTI No.	Angle	Head Dia	Head Length	Overall Length
Double Cut	Saber Cut	Fast Mill Cut					
16963	—	—	SM-3.	12°	1/4	1	2
16964	16966	—	SM-4	28°	3/8	3/4	2-1/2
16965	16967	—	SM-5	28°	1/2	1	2-3/4

IBS, INCORPORATED

Rotary Burs P29



Carbide Bur Assortments (P15)



DOUBLE CUT ROTARY BURS ASSORTMENT

Asst No.	IBS No. (Bur)	Type	SCTI No.	Head Dia	Head Length	Overall Length		
IBS No. 16980 w / Index & Grinder	IBS No. 16979 with Index	16901	Cylinder	SA-1	1/4	5/8	2	
		16903	Cylinder	SA-3	3/8	3/4	2-1/2	
		16905	Cylinder	SA-5	1/2	1	2-3/4	
		16921	14° Taper	SL-1	1/4	5/8	2-13/16	
		16933	Cylinder Rad	SC-3	3/8	3/4	2-1/2	
		16935	Cylinder Rad	SC-5	1/2	1	2-3/4	
		16911	Tree Radius	SF-1	1/4	5/8	2-1/2	
		16913	Tree Radius	SF-3	3/8	3/4	2-3/4	
		17016	Steel Index					
		69282	1/4 Air Die Grinder					



SABER CUT ROTARY BURS ASSORTMENT

Asst No.	IBS No. (Bur)	Type	SCTI No.	Head Dia	Head Length	Overall Length		
IBS No. 16996 w/Index & Grinder	IBS No. 16997 with Index	16907	Cylinder	SA-3	3/8	3/4	2-1/2	
		16909	Cylinder	SA-5	1/2	1	2-3/4	
		16926	14° Taper	SL-3	3/8	1-1/16	2-13/16	
		16936	Cylinder Rad	SC-3	3/8	3/4	2-1/2	
		16938	Cylinder Rad	SC-5	1/2	1	2-3/4	
		16916	Tree Radius	SF-3	1/2	1	2-1/2	
		16918	Tree Radius	SF-5	3/8	3/4	2-3/4	
		17016	Steel Index					
		69282	1/4 Air Die Grinder					



FAST MILL CUT BURS FOR ALUMINUM ASSORTMENT

Asst No.	IBS No. (Bur)	Type	SCTI No.	Head Dia	Head Length	Overall Length		
IBS No. 16998 w/Index & Grinder	IBS No. 16999 w/Index	16981	Cylinder	SA-1	1/4	5/8	2	
		16983	Cylinder	SA-3	3/8	3/4	2-1/2	
		16985	Cylinder	SA-5	1/2	1	2-3/4	
		16987	Cylinder Rad	SC-3	3/8	3/4	2-1/2	
		16989	Cylinder Rad	SC-5	1/2	1	2-3/4	
		16993	Tree Radius	SF-5	1/2	1	2-1/2	
		17016	Steel Index					
		69282	1/4 Air Die Grinder					

T
A
P
S

B
U
R
S

B
L
A
D
E
S



IBS, INCORPORATED

Hi-Alloy Rotary Burs Gen'l Info

TAPS BURS BLADES

SURFACE FEET CONVERSION CHART								
Surface Feet Per Minute (SFM) to Revolutions Per Minute (RPM)								
SFM	RPM							
	Cutter Diameter							
	1/8"	1/4"	3/8"	1/2"	5/8"	3/4"	7/8"	1"
10	305	153	102	76	61	51	44	38
15	458	229	153	115	92	76	65	57
20	611	305	204	153	122	102	87	76
25	763	382	254	191	153	127	109	95
30	916	458	305	229	183	153	131	115
25	1069	534	356	267	214	178	153	134
40	1221	611	407	206	244	204	174	153
25	1374	687	458	344	275	229	196	172
50	1527	763	509	382	305	254	218	191
60	1832	916	611	458	366	305	262	229
70	2137	1069	712	534	427	356	305	267
80	2443	1221	814	611	489	407	349	305
90	2478	1374	916	687	550	458	393	344
100	3053	1527	1018	763	611	509	436	382
150	4580	2290	1527	1145	916	763	654	573
200	6107	3053	2036	1527	1221	1018	872	763
250	7634	3817	2545	1908	1527	1272	1091	954
300	9160	4580	3053	2290	1832	1527	1309	1145
350	10687	5344	3562	2672	2137	1781	1527	1336
400	12214	6107	4071	3053	2443	2036	1745	1527
450	13740	6870	4580	3453	2748	2290	1963	1718
500	15267	7634	5089	3817	3053	2545	2181	1908
600	18321	9160	6107	4580	3664	3053	2617	2290
700	21374	10687	7125	5344	4275	3562	3053	2672
800	24427	12214	8142	6107	4885	4071	3490	3053
900	27481	13740	9160	6870	5496	4580	3926	3453
1000	30534	15267	10178	7634	6107	5089	4362	3817
1100	33588	16794	11196	8397	6718	5598	4798	4198
1200	36641	18321	12214	9160	7328	6107	5234	4580
1300	39695	19847	13232	9924	7939	6616	5671	4962
1400	42748	21374	14429	10687	8550	7125	3107	5344
1500	45802	22901	15267	11450	9160	7634	6543	5725
1600	48855	24427	16285	12214	9771	8142	6979	6107
1700	51908	25954	17303	12977	10382	8651	7415	6489
1800	54962	27481	18321	13740	10992	9160	7852	6870
1900	58015	29008	19338	14504	11603	9669	8288	7252
2000	61069	30534	20356	15267	12214	10178	8724	7634

FORMULAS: SFM = RPM X Diameter X .262 RPM = (SFM X 3.82) + Diameter

External Deburring Tools 3Pc Set (T03)

IBS No. 476P



- Quickly repairs damaged threads from 7/64" to 2-1/3".
- Hardened HRC 60 Steel blades remove burrs and uneven ridges from threaded rods, pipes and more.
- Works on hardened and mild steels, Grade 8 fasteners, stainless steel, brass copper, aluminum, plastics, wood, etc.
- 1/4" hex shank attaches to your drill quickly.
- Most effective at low speeds — recommended speed should not exceed 500 RPM in a clockwise direction only.

IBS No.	Description	Shank	Qty
51951	Small Deburring Tool 7/64" to 7/16"	1/4"	1
51950	Medium Deburring Tool 5/16" to 7/8"	1/4"	1
51952	Large Deburring Tool 23/32" to 2-1/3"	3/8"	1
476P	3 Piece Set - Deburring Tools		1



REMOVE BURRS

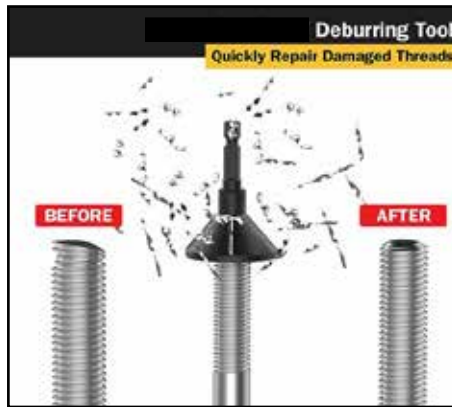

REPAIR DAMAGED THREADS



WORKS ON A VARIETY OF MATERIALS

T
A
P
S
B
U
R
S
B
L
A
D
E
S



IBS, INCORPORATED

Abrasives, Bench Rolls, Files P26

T
A
P
S

B
U
R
S

B
L
A
D
E
S

Black Maxi-Sharp Files

Our Premium line of hand files, specially treated with a black oxide coating, Black Maxi-Sharp Files last longer due to increased resistance to loading and rust.

All Purpose



The built-in handle provides maximum versatility for a wide range of applications. All Purpose Files feature a double cut on one side, a single cut on the other side, have one edge cut and one edge safe (uncut) for shoulder filing, and are parallel in width and thickness.

ALL PURPOSE

IBS No.	Description	Qty
65018-8	8" / 200 mm	1
65018-10	10" / 250 mm	1

Mill Files



Excellent for a wide range of applications such as sharpening, draw filing, lathe work and general shop use; Mill Files are single cut on the sides and edges and taper toward the point width.

MILL FILES - BASTARD CUT

IBS No.	Description	Qty
65000-6	6" / 150 mm	1
65000-8	8" / 200 mm	1
65000-10	10" / 250 mm	1
65000-12	12" / 300 mm	1
65000-14	14" / 350 mm	1

MILL FILES - SMOOTH CUT

IBS No.	Description	Qty
65017-6	6" / 150 mm	1
65017-8	8" / 200 mm	1
65017-10	10" / 250 mm	1
65017-12	12" / 300 mm	1

MILL FILES - SECOND CUT

IBS No.	Description	Qty
65010-6	6" / 150 mm	1
65010-8	8" / 200 mm	1
65010-10	10" / 250 mm	1

Flat Files



Excellent for "hogging" or rapid stock removal; Flat Files are double cut on both sides, single cut on the edges and taper toward the point in width.

FLAT FILES - BASTARD CUT

IBS No.	Description	Qty
65001-6	6" / 150 mm	1
65001-8	8" / 200 mm	1
65001-10	10" / 250 mm	1
65001-12	12" / 300 mm	1
65001-14	14" / 350 mm	1

FLAT FILES - SMOOTH CUT

IBS No.	Description	Qty
65011-6	6" / 150 mm	1
65011-8	8" / 200 mm	1
65011-10	10" / 250 mm	1
65011-12	12" / 300 mm	1

Half-Round Files



Great for rounding out holes, corners and crevices; Half Round Files are double cut on both sides and taper toward the point in width and thickness. Files feature a "twist & roll" action on the half round side produced by a spiral cut design and have the "Wavy Tooth" design on the flat side

HALF ROUND FILES - BASTARD CUT

IBS No.	Description	Qty
65003-6	6" / 150 mm	1
65003-8	8" / 200 mm	1
65003-10	10" / 250 mm	1
65003-12	12" / 300 mm	1
65003-14	14" / 350 mm	1

HALF ROUND FILES - SMOOTH CUT

IBS No.	Description	Qty
65014-6	6" / 150 mm	1
65014-8	8" / 200 mm	1
65014-10	10" / 250 mm	1



Black Maxi-Sharp Files

Our Premium line of hand files, specially treated with a black oxide coating, Black Maxi-Sharp Files last longer due to increased resistance to loading and rust.

Multi-Kut Flat Files



Obtain almost any required finish simply by changing the feed pressure; "Multi-Kut" Flat Files are single cut coarse tooth files that taper toward the point width. Design features allow for fast stock removal while leaving a smooth finish. Combines the performances of Flat and Mill Files.

MULTI-KUT FLAT FILES - SMOOTH CUT

IBS No.	Description	Qty
65019-8	8" / 200 mm	1
65019-10	10" / 250 mm	1

Round Files



Intended for enlarging and rounding out circular openings or concave surfaces; Round Files are double cut and taper toward the point in width and thickness.

ROUND FILES - BASTARD CUT

IBS No.	Description	Qty
65002-6	6" / 150 mm	1
65002-8	8" / 200 mm	1
65002-10	10" / 250 mm	1
65002-12	12" / 300 mm	1

ROUND FILES - SMOOTH CUT

IBS No.	Description	Qty
65012-6	6" / 150 mm	1
65012-8	8" / 200 mm	1

Tapered Saw Files



Designed for filing all types of saws with 60° angle teeth; Taper Saw Files are triangular in shape, have cut edges and taper toward the point in width and thickness.

IBS No.	Description	Type	Qty
65016-6	6" / 150 mm	Regular ▲	1
65004-6	6" / 150 mm	Slim ▲	1
65005-7	6" / 150 mm	Extra Slim ▲	1

3 Square Files



Excellent for cleaning out corners or for use on cutters, taps, and flat surfaces; Three Square files are double cut and taper toward the point in width and thickness

IBS No.	Description	Type	Qty
65015-6	6" / 150 mm	Bastard Cut	1
65015-8	8" / 200 mm	Bastard Cut	1

Tungsten Points File with Pocket Clip



For cleaning contact points in magnetos, switches, electric bells and distributor points and spark plugs in engines; Tungsten Point Files are single cut and have a handy pocket clip.

IBS No.	Description	Qty
65006-6	5" Tungsten Points File w / Pkt Clip	1

Chainsaw Files



Used for sharpening and maintaining proper tooth shape on chain saws; Round Chain Saw files have a fast, smooth cutting action that leaves an excellent "keen" edge cutting finish.

IBS No.	Description	Qty
65007-14	1/4" x 8"	1
65007-316	3/16" x 8"	1
65007-532	5/32" x 6"	1
65007-732	7/32" x 8"	1

File Card



Used to clean files — files last longer when properly cleaned. Excess build-up can cause clogging, resulting in slipping, scratching, or other filing inefficiencies.

IBS No.	Description	Qty
65009	File Card with Brush	1

T
A
P
S

B
U
R
S

B
L
A
D
E
S



IBS, INCORPORATED

Abrasives, Bench Rolls, Files P26

T
A
P
S
B
U
R
S
B
L
A
D
E
S

Files & Accessories

Skroo-Zon File Handles



The best name in file handles, Skroo-Zon wooden file handles have a threaded insert for "easy on, easy off." Reusable and long lasting. Be safe and reduce the risk of injury; use a Skroo-Zon File Handle.

IBS No.	Description	Qty
65008-4	T2 Handle / 4" Files	1
65008-6	T4 Handle / 6" Files	1
65008-8	T5 Handle / 8" Files	1
65008-10	T6 Handle / 10" Files	1
65008-12	T7 Handle / 12" Files	1
65008-14	T8 Handle / 14" Files	1

Black Maxi-Sharp Files Assortment (Z02)









IBS No. 699R • 10 Items • 12 Pcs

Packaged in a locking steel drawer for easy storage & organization



Maxi-Sharp Files

Assortment No. 699R

<p>65018-10 10 MAXI-SHARP ALL PURPOSE</p> 	<p>65019-10 10 MAXI-SHARP FLAT MULTI-KUT</p> 
<p>65001-10 10 MAXI-SHARP FLAT FILE</p> 	<p>65003-10 10 MAXI-SHARP 1/2 RD FILE</p> 
<p>65000-10 10 MAXI-SHARP MILL FILE</p> 	
<p>65002-10 10 MAXI-SHARP ROUND FILE</p> 	
<p>65004-6 6 MAXI-SHARP TAPER FILE SLIM</p> 	<p>65008-6 6 SCRUIZ-ON FILE HANDLE</p> 
<p>65009 FILE CARD WITH BRUSH</p> 	<p>65008-10 10 SCRUIZ-ON FILE HANDLE</p> 